

5. CRANE FORKS, LIFTING BEAMS AND CRANE SCALES



LIFTING BEAMS

CRANE FORKS

SHOP CRANES

CRANE SCALES

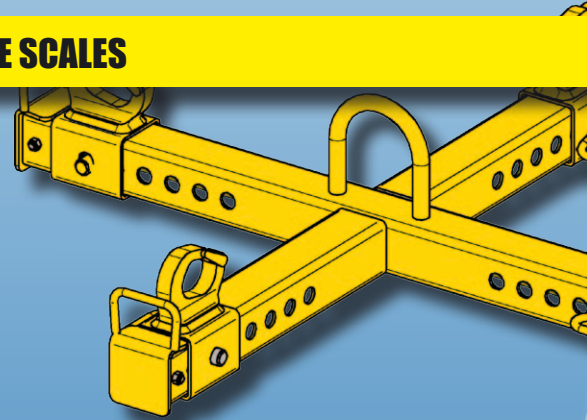

ABT yellowline®

TYPE A

- self-locking safety hooks as standard
- alternatively: only shackles, eye sling hooks, welded eye sling hooks or rotating, latch or safety hooks with swivel
- CE marked
- powder coated surface, standard colour yellow
- **not to be heat treated**

*Items marked with a star are stock items

We also deliver type A beams for workloads of between 8t and 60t. Make an enquiry.

WLL kg	Usable length mm	Weight appr. kg	Product code
1000	1000	15	NOSP101000
1000	2000	42	*NOSP102000
1000	3000	62	NOSP103000
1000	4000	115	*NOSP104000
1000	5000	140	NOSP105000
2000	1000	28	NOSP201000
2000	2000	49	*NOSP202000
2000	3000	87	NOSP203000
2000	4000	139	*NOSP204000
2000	5000	210	NOSP205000
2000	6000	240	NOSP206000
3000	1000	33	NOSP301000
3000	2000	68	NOSP302000
3000	3000	95	NOSP303000
3000	4000	170	NOSP304000
3000	5000	226	NOSP305000
3000	6000	344	NOSP306000
5000	1000	50	NOSP501000
5000	2000	110	NOSP502000
5000	3000	141	NOSP503000
5000	4000	255	NOSP504000
5000	5000	310	NOSP505000
5000	6000	430	NOSP506000
6000	2000	112	NOSP602000
6000	3000	210	NOSP603000
6000	4000	270	NOSP604000
6000	5000	370	NOSP605000
6000	6000	450	NOSP606000

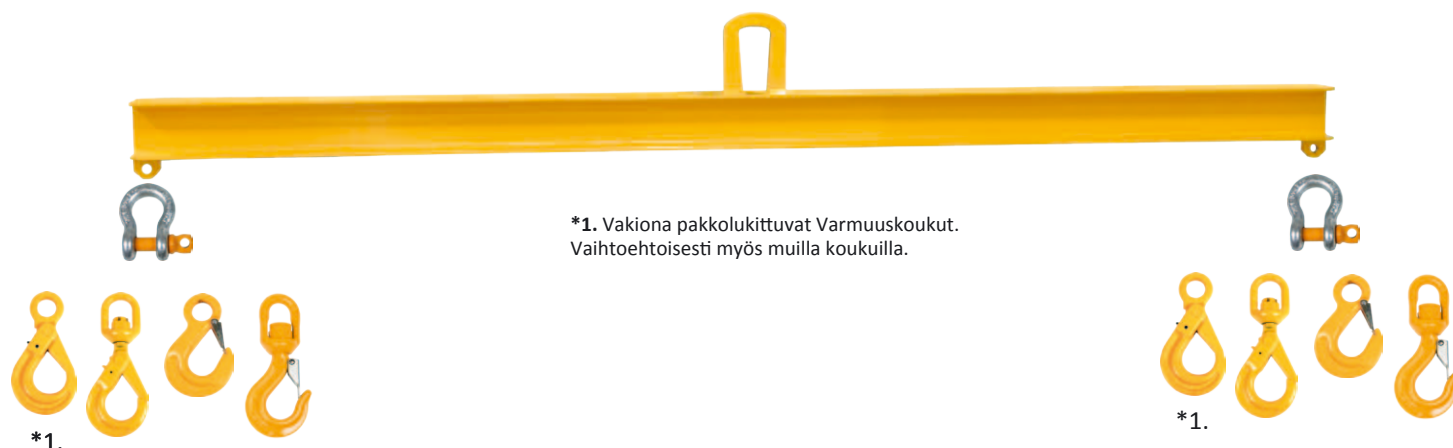

TYPE A, MULTIPLE LIFTING POINTS

- self-locking safety hooks as standard
- alternatively: only shackles, eye sling hooks, welded eye sling hooks or rotating, eye sling or safety hooks with swivel
- adjustment range in steps of 0.5m
- CE marked
- powder coated surface, standard colour yellow
- **not to be heat treated**

*Items marked with a star are stock types

We also deliver type A beams with adjustable lifting points for workloads of between 8t and 60t. Make an enquiry.

WLL kg	Usable length mm	Weight appr. kg	Product code
1000	2000	44	NOSPS102000
1000	3000	65	*NOSPS103000
1000	4000	119	*NOSPS104000
1000	5000	147	NOSPS105000
2000	2000	56	NOSPS202000
2000	3000	96	*NOSPS203000
2000	4000	150	*NOSPS204000
2000	5000	224	NOSPS205000
2000	6000	258	NOSPS206000
3000	2000	74	NOSPS302000
3000	3000	102	NOSPS303000
3000	4000	180	NOSPS304000
3000	5000	240	NOSPS305000
3000	6000	356	NOSPS306000
5000	2000	123	NOSPS502000
5000	3000	159	NOSPS503000
5000	4000	270	NOSPS504000
5000	5000	330	NOSPS505000
5000	6000	450	NOSPS506000
6000	2000	128	NOSPS602000
6000	3000	224	NOSPS603000
6000	4000	289	NOSPS604000
6000	5000	395	NOSPS605000
6000	6000	536	NOSPS606000



*1. Vakiona pakkolukittuvat Varmuuskoukut.
Vaihtoehtoisesti myös muilla koukuilla.

TYPE B

- self-locking safety hooks as standard
- alternatively: only shackles, eye sling hooks, welded eye sling hooks or rotating, eye sling or safety hooks with swivel
- CE marked
- powder coated surface, standard colour yellow
- **not to be heat treated**

*Items marked with a star are stock items.

We also deliver type B beams for workloads of between 8t and 60t. Make an enquiry.

WLL kg	Usable length mm	Size A appr. mm	Weight appr. kg	Product code
1000	1000	400	14	NOSPB101000
1000	2000	680	43	*NOSPB102000
1000	3000	980	64	NOSPB103000
1000	4000	1250	118	*NOSPB104000
1000	5000	1550	147	NOSPB105000
2000	1000	400	31	NOSPB201000
2000	2000	680	52	*NOSPB202000
2000	3000	980	92	NOSPB203000
2000	4000	1250	144	*NOSPB204000
2000	5000	1550	220	NOSPB205000
2000	6000	1850	255	NOSPB206000
3000	1000	430	38	NOSPB301000
3000	2000	710	74	NOSPB302000
3000	3000	1010	102	NOSPB303000
3000	4000	1280	179	NOSPB304000
3000	5000	1580	232	NOSPB305000
3000	6000	1880	353	NOSPB306000
5000	1000	460	55	NOSPB501000
5000	2000	740	126	NOSPB502000
5000	3000	1040	152	NOSPB503000
5000	4000	1310	266	NOSPB504000
5000	5000	1610	324	NOSPB505000
5000	6000	1910	449	NOSPB506000
6000	2000	760	122	NOSPB602000
6000	3000	1060	228	NOSPB603000
6000	4000	1330	291	NOSPB604000
6000	5000	1630	380	NOSPB605000
6000	6000	1930	470	NOSPB606000

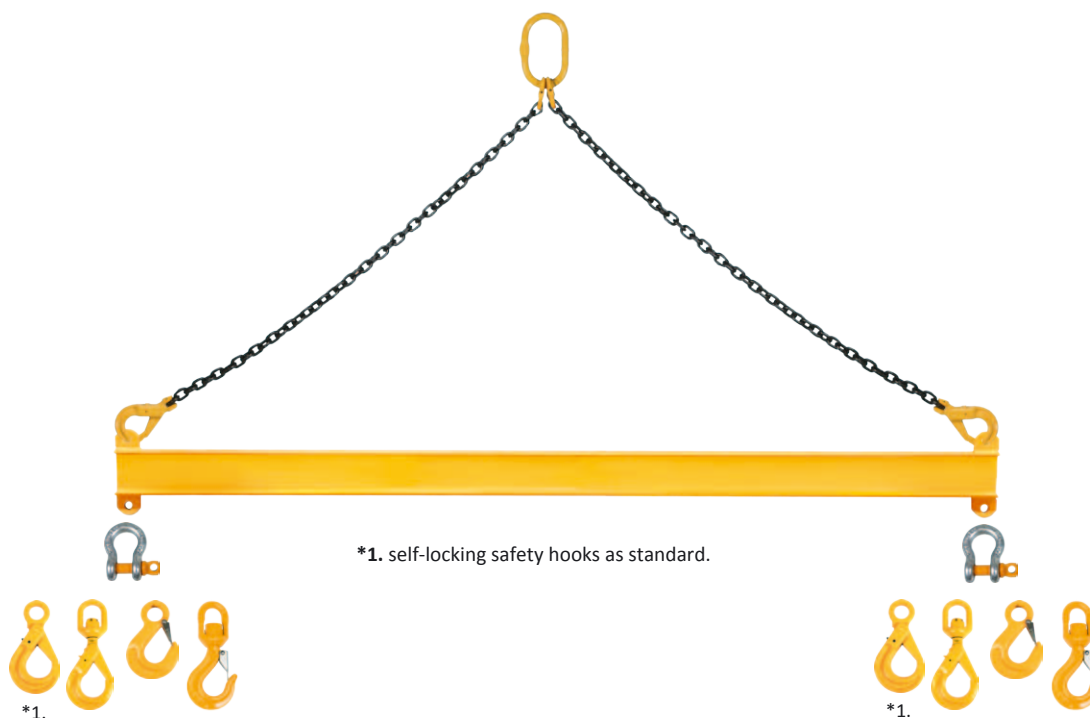

*1. self-locking safety hooks as standard.

*1.

*1.

TYPE B, MULTIPLE LIFTING POINTS

- self-locking safety hooks as standard
- alternatively: only shackles, eye sling hooks, welded eye sling hooks or rotating, eye sling or safety hooks with swivel
- adjustment range in steps of 0.5m
- CE marked
- powder coated surface, standard colour yellow
- **not to be heat treated**

*Items marked with a star are stock types

We also deliver type B beams with adjustable lifting points for workloads of between 8t and 60t. Make an enquiry.

WLL kg	Usable length mm	Size A appr. mm	Weight appr. kg	Product code
1000	2000	680	43	NOSPBS102000
1000	3000	980	62	*NOSPBS103000
1000	4000	1250	116	*NOSPBS104000
1000	5000	1550	142	NOSPBS105000
2000	2000	680	53	NOSPBS202000
2000	3000	980	92	*NOSPBS203000
2000	4000	1250	146	*NOSPBS204000
2000	5000	1550	220	NOSPBS205000
2000	6000	1850	256	NOSPBS206000
3000	2000	710	73	NOSPBS302000
3000	3000	1010	100	NOSPBS303000
3000	4000	1280	176	NOSPBS304000
3000	5000	1580	230	NOSPBS305000
3000	6000	1880	340	NOSPBS306000
5000	2000	740	120	NOSPBS502000
5000	3000	1040	154	NOSPBS503000
5000	4000	1310	260	NOSPBS504000
5000	5000	1610	321	NOSPBS505000
5000	6000	1910	440	NOSPBS506000
6000	2000	760	124	NOSPBS602000
6000	3000	1060	217	NOSPBS603000
6000	4000	1330	279	NOSPBS604000
6000	5000	1630	388	NOSPBS605000
6000	6000	1930	525	NOSPBS606000

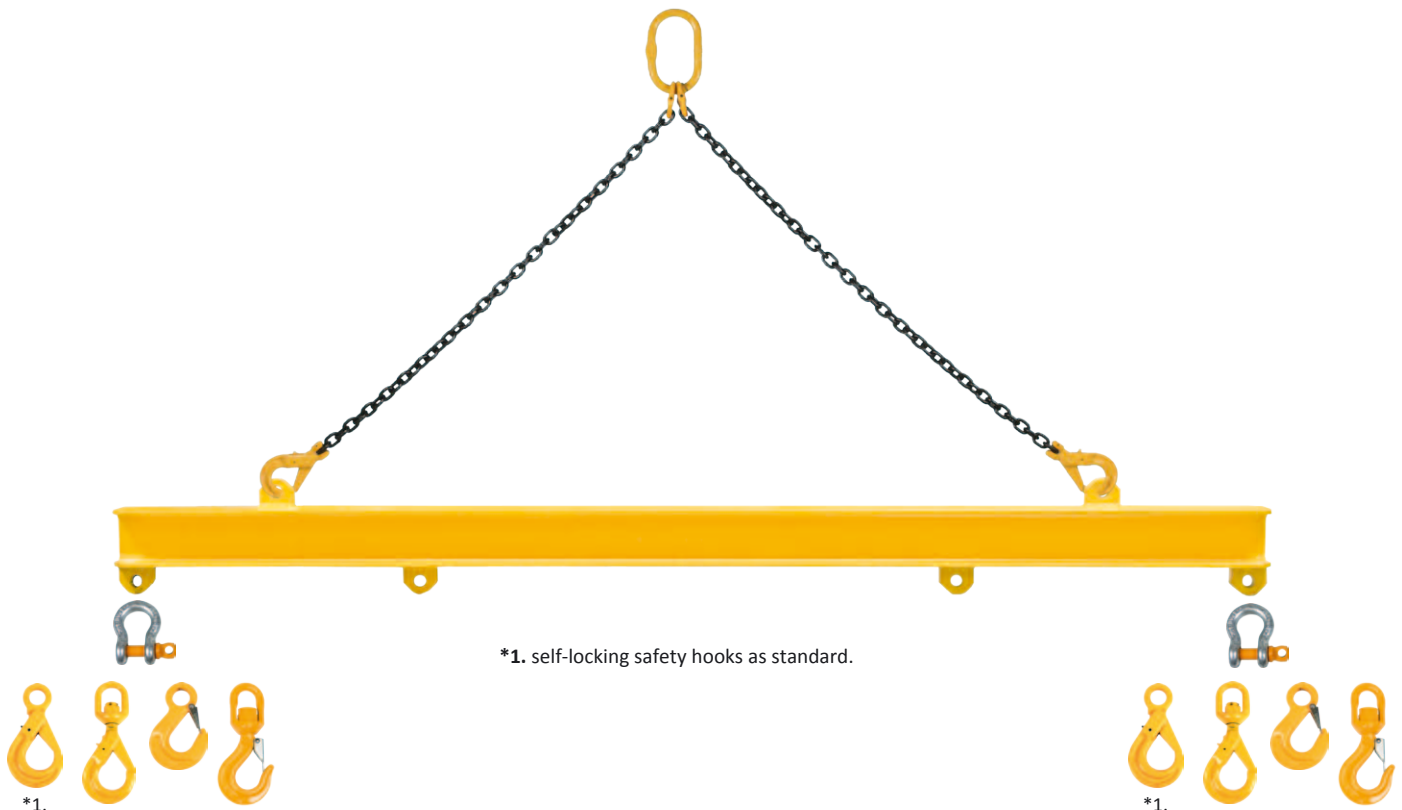
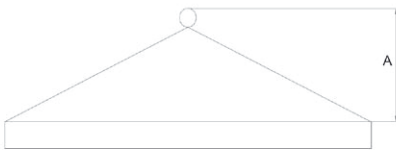

*1. self-locking safety hooks as standard.

LIFTING FRAMES, ALUMINIUM

- Collapsible aluminium lifting frame
- can be stored in small spaces when collapsed
- three sizes: 7,000kg; 10,000kg and 16,000kg
- easy and quick to assemble
- perfect for, for example, lifting boats
- the beam is also available without hooks and roundslings



dimensions m	WLL kg	lifting angle	height m	sling length m	weight kg	product code
3,0 x 3,0	7000	110	1,5	2,5	42	NOKE733AL
3,0 x 2,4	7000	98	1,7	2,5	38	NOKE7324AL
2,4 x 2,4	7000	82	2,0	2,5	35	NOKE72424AL

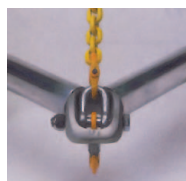

dimensions m	WLL kg	lifting angle	height m	sling length m	weight kg	product code
4,0 x 4,0	10 000	100	2,50	4,0	128	NOKE1044AL
3,0 x 3,0	10 000	120	1,25	2,5	103	NOKE1033AL
3,0 x 2,4	10 000	104	1,50	2,5	96	NOKE10324AL
2,4 x 2,4	10 000	102	1,50	2,5	88	NOKE102424AL



dimensions m	WLL kg	lifting angle	height m	sling length m	weight kg	product code
4,0 x 4,0	16 000	100	2,50	4,0	128	NOKE1644AL
3,0 x 3,0	16 000	90	2,15	3,0	103	NOKE1633AL
3,0 x 2,4	16 000	100	1,60	2,5	96	NOKE16324AL
2,4 x 2,4	16 000	86	1,80	2,5	88	NOKE2424AL



CRANE FORKS FOR EUR-PALLETS

- four standard types
- **also available, among others, as adjustable in down-up direction, bending sideways and with bigger workloads for individual order**
- surface painted yellow
- safety factor 4: 1
- CE marked
- **not to be heat treated**

NOTE! - Always lift from the long side of the pallet!
 - Dimensional tolerance appr. +- 20mm

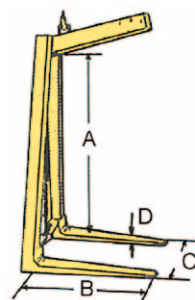

WLL kg	Fork type	A mm	B mm	C mm	D mm	Weight appr. kg	Product code
1500	fixed standard	1500	1000	700	50	95	NOH15001
1500	adjustable forged	1300-2000	1000	350-900	40	165	NOH1500S
2000	adjustable forged	1300-2000	1000	400-900	40	220	NOH2000S
3000	adjustable forged	1300-2000	1000	450-900	50	280	NOH3000S



ABT FOLDABLE SHOP CRANES

- two sizes, capacities 1,000kg and 2,000kg
- lifting bar can be adjusted longitudinally
- both are foldable, so that they can be transported, for example, in a van
- CE marked

Max. load kg	Lifting hook min. height mm	Lifting hook max. height mm	length x width mm	height (beam horizontal) mm	weight kg	product code
1000	750	1800	1610 x 825	154	78	PUNOS1000KT
2000	500	2382	1840 x 1085	158	110	PUNOS2000KT



Tel. (02) 511 5511 sales@haklift.com www.haklift.com

ABT SMALL CRANE SCALES

- stock types 100kg, 300kg, 500kg and 1,000kg
- in-built rechargeable batteries with an operation time of appr. 100 hours at one charge
- equipped with wireless remote control with reset, hold, tare, unit change and switch off
- clear LCD screen
- CE marked

Maximum load kg	Accuracy kg	A mm	B mm	C mm	L mm	Weight appr. kg	Product code
100	0,05	20	65	20	335	4,0	KV01ABT
300	0,10	20	65	20	335	4,0	KV03ABT
500	0,20	25	75	20	335	4,2	KV05ABT
1000	0,50	25	75	20	335	4,2	KV1ABT

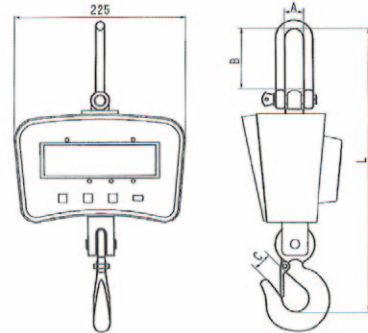
ABT CRANE SCALES

- stock types 3,000kg; 5,000kg; 10,000kg; 15,000kg and 20,000kg
- also available for bigger loads
- battery charger is included
- operating time at one charge is appr. 100 hours
- equipped with wireless remote control with reset, hold, tare, unit change and switch off
- CE marked

Maximum load kg	Accuracy kg	A mm	B mm	C mm	D mm	E mm	F mm	G mm	Weight appr. kg	Product code
3000	1	550	230	340	150	60	80	40	17	KV3ABT
5000	2	690	230	340	150	100	120	50	25	KV5ABT
10000	5	820	230	340	150	100	120	55	34	KV10ABT
15000	5	1020	230	360	155	130	140	75	63	KV15ABT
20000	10	1120	230	360	155	140	220	90	67	KV20ABT

