

FX Y Series

DIN W72×H36mm Of Counter/Timer With Indication Only

■ Features

- Counting speed: 1cps/30cps/2kcps/5kcps
- Selectable voltage input (PNP) method or no-voltage input (NPN) method
- Input mode: Up, Down, Up/Down
- Dot for Decimal Point / Hour. Min. Second by RESET key
- Wide range of input power supply
: 100-240VAC 50/60Hz,
24VAC 50/60Hz, 24-48VDC universal
- Selectable Counter or Timer function by internal DIP switch
- Changed case color (ivory → black)
- [Counter]
20 input modes
- [Timer]
Various time setting range-6-digit model: 0.01 sec to 99999.9 hour /
4-digit model: 0.01 sec to 9999 hour
- Output: Indicator



! Please read "Safety Considerations" in operation manual before using.



■ Model

Model	Display digit	Size	Output	Power supply
FX4Y-I2	9999 (4-digit)	DIN W72×H36mm	Indicator	24VAC 50/60Hz, 24-48VDC
FX4Y-I4				100-240VAC 50/60Hz
FX6Y-I2	999999 (6-digit)			24VAC 50/60Hz, 24-48VDC
FX6Y-I4				100-240VAC 50/60Hz

■ Specifications

Model	Indicator	FX4Y-I2	FX4Y-I4	FX6Y-I2	FX6Y-I4
Display digit		4-digit		6-digit	
Character size (W×H)		8×14mm		4×8mm	
Power supply		24VAC~ 50/60Hz, 24-48VDC==	100-240VAC~ 50/60Hz	24VAC~ 50/60Hz, 24-48VDC==	100-240VAC~ 50/60Hz
Permissible voltage range		90 to 110% of rated voltage			
Power consumption		Max. 2.8VA (24VAC~ 50/60Hz), Max. 1.8W (24-48VDC==)	Max. 3.8VA (240VAC~ 50/60Hz)	Max. 2.8VA (24VAC~ 50/60Hz), Max. 1.8W (24-48VDC==)	Max. 3.8VA (240VAC~ 50/60Hz)
Max. counting speed of CP1/CP2		Selectable 1cps/30cps/2kcps/5kcps (DIP switch)			
Return time		Max. 500ms			
Min. signal width		INHIBIT, RESET: approx. 20ms			
Input method		Selectable voltage input (PNP) method or no-voltage input (NPN) method [Voltage input (PNP) method]-input impedance: max. 10.8kΩ, [H]: 5-30VDC==, [L]:0-2VDC [No-voltage input (NPN) method]-short-circuit impedance: max. 470kΩ, short-circuit residual voltage: max. 1VDC, open-circuit impedance: min. 100kΩ			
Repeat/Set/Voltage/Temp. error		Max. ±0.01% ±0.05 sec			
Insulation resistance		Over 100MΩ (at 500VDC megger)			
External power supply		Max. 12VDC== ±10% 50mA			
Memory retention		Approx. 10 years (non-volatile memory)			
Dielectric strength		2,000VAC 50/60Hz for 1 min (between all terminals and case)			
Noise immunity	AC voltage	±2kV the square wave noise (pulse width 1μs) by noise simulator			
	AC/DC voltage	±500V the square wave noise (pulse width 1μs) by noise simulator			
Vibration	Mechanical	0.75mm amplitude at frequency 10 to 55Hz (for 1 min) in each X, Y, Z direction for 1 hour			
	Malfunction	0.5mm amplitude at frequency 10 to 55Hz (for 1 min) in each X, Y, Z direction for 10 minutes			
Shock	Mechanical	300m/s ² (approx. 30G) in each X, Y, Z direction for 3 times			
	Malfunction	100m/s ² (approx. 10G) in each X, Y, Z direction for 3 times			
Environment	Ambient temp.	-10 to 55°C, storage: -25 to 65°C			
	Ambient humi.	35 to 85%RH, storage: 35 to 85%RH			
Protection structure		IP40 (front part, IEC standard)			
Approval		CE c UL US			
Weight ^{※1}		Approx. 175g (approx. 120g)			

※1: The weight includes packaging. The weight in parenthesis is for unit only.

※Environment resistance is rated at no freezing or condensation.

Up/Down Counter/Timer

Connections

• FX□Y-I4

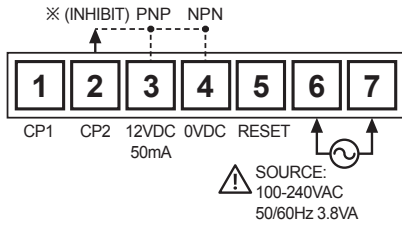

• FX□Y-I2

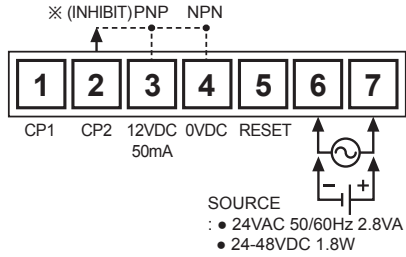

※INHIBIT: In case of timer mode, this terminal is for time hold.
(voltage input (PNP): connect with 12VDC, no-voltage input (NPN): connect with 0VDC)

Dimensions

(unit: mm)

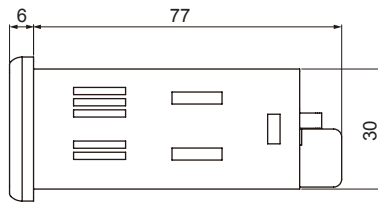
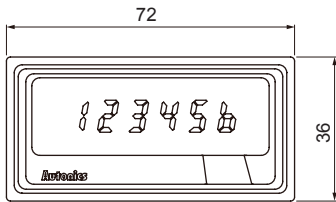

○ Bracket

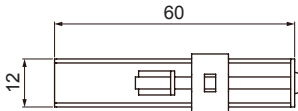
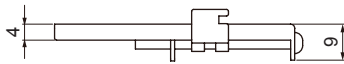

○ Panel cut-out

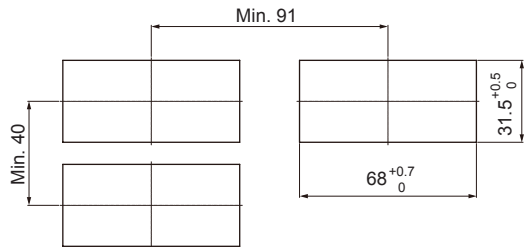

Counting Method

Be careful to select sensor because the counting method of NPN output type sensor is different from PNP output type sensor.

○ NPN output type Proximity sensor

: When the sensor is changed from OFF to ON, it counts.

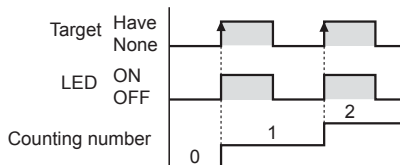
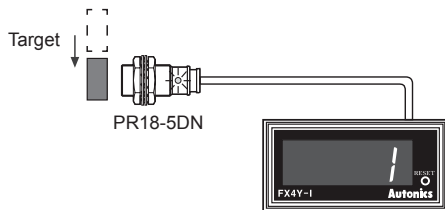

○ PNP output type Proximity sensor

: When the sensor is changed from ON to OFF, it counts.

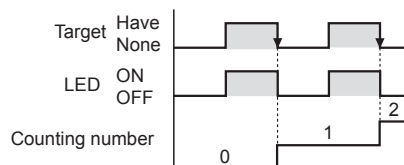
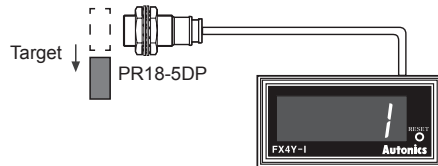

(A) Photoelectric Sensors

(B) Fiber Optic Sensors

(C) Door/Area Sensors

(D) Proximity Sensors

(E) Pressure Sensors

(F) Rotary Encoders

(G) Connectors/ Connector Cables/ Sensor Distribution Boxes/Sockets

(H) Temperature Controllers

(I) SSRs / Power Controllers

(J) Counters

(K) Timers

(L) Panel Meters

(M) Tacho / Speed / Pulse Meters

(N) Display Units

(O) Sensor Controllers

(P) Switching Mode Power Supplies

(Q) Stepper Motors & Drivers & Controllers

(R) Graphic/ Logic Panels

(S) Field Network Devices

(T) Software

FX Series

Input Connections

Voltage input (PNP)

Solid-state input (standard sensor: PNP output type sensor)

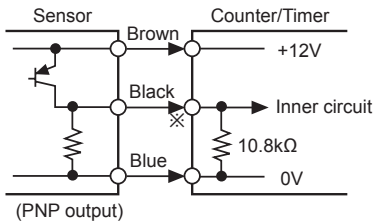

※CP1, CP2 (INHIBIT), RESET input part

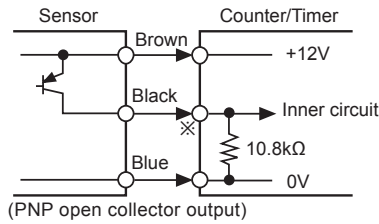

Contact input

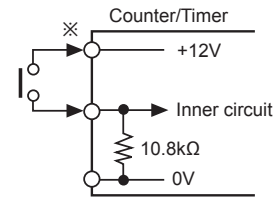

※Counting speed
: Set as 1 or 30cps

No-voltage input (NPN)

Solid-state input (standard sensor: NPN output type sensor)

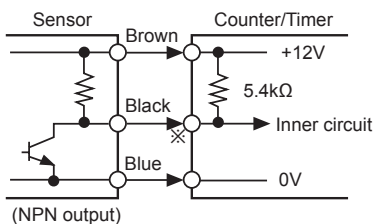

※CP1, CP2 (INHIBIT), RESET input part

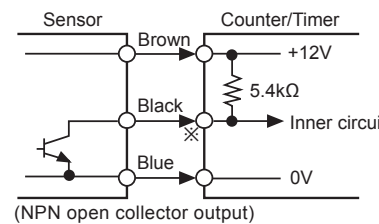

Contact input

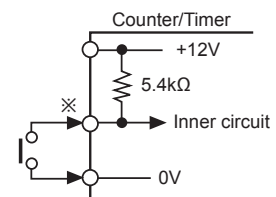

※Counting speed
: Set as 1 or 30cps

Counting & Time Operation

Counting operation

Input mode: Up

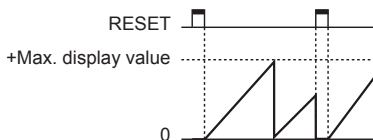

Input mode: Down

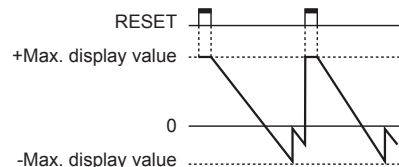

Input mode: Up/Down-A, B, C

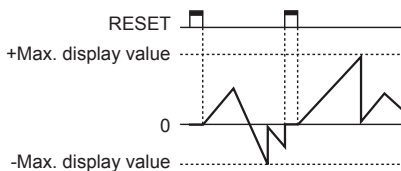

Input mode: Up/Down-D, E, F

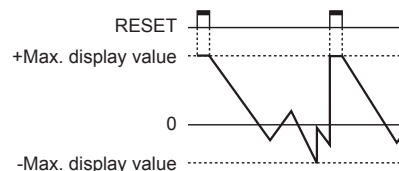

Time operation

Up mode

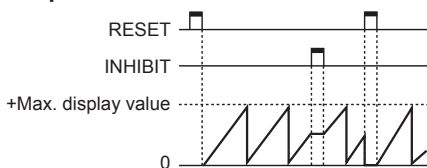

Down mode

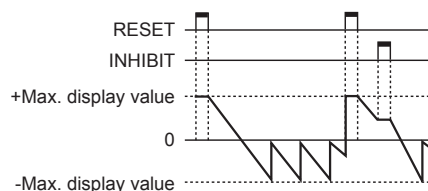

Up/Down Counter/Timer

■ DIP Switch Setting

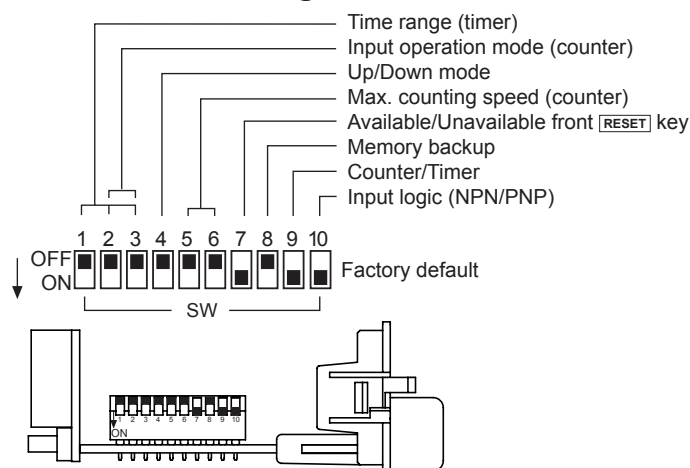

● Up/Down mode

SW	Function
4 OFF <input type="checkbox"/>	Up mode
4 ON <input checked="" type="checkbox"/>	Down mode

● Available/Unavailable front [RESET] key

SW	Function
7 OFF <input type="checkbox"/>	Unavailable front RESET key
7 ON <input checked="" type="checkbox"/>	Available front RESET key

● Max. counting speed (counter)

SW	Function
5 6 OFF <input type="checkbox"/>	1cps
5 6 ON <input checked="" type="checkbox"/>	30cps
5 6 OFF <input type="checkbox"/>	2kcps
5 6 ON <input checked="" type="checkbox"/>	5kcps

● Memory backup

SW	Function
8 OFF <input type="checkbox"/>	Memory backup
8 ON <input checked="" type="checkbox"/>	No memory backup

● Counter/Timer

SW	Function
9 OFF <input type="checkbox"/>	Timer mode
9 ON <input checked="" type="checkbox"/>	Counter mode

● Input logic (CP1, CP2, INHIBIT, RESET input)

SW	Function
10 OFF <input type="checkbox"/>	PNP (voltage input)
10 ON <input checked="" type="checkbox"/>	NPN (no-voltage input)

■ Time Range (Timer)

SW	4-digit	6-digit	SW	4-digit	6-digit
1 2 3 OFF <input type="checkbox"/>	99.99sec	99999.9sec	1 2 3 OFF <input type="checkbox"/>	999.9min	99999.9min
1 2 3 ON <input checked="" type="checkbox"/>	999.9sec	999999sec	1 2 3 ON <input checked="" type="checkbox"/>	99hour 59min	99hour 59min 59sec
1 2 3 OFF <input type="checkbox"/>	9999sec	99min 59.99sec	1 2 3 ON <input checked="" type="checkbox"/>	999.9hour	9999hour 59min
1 2 3 ON <input checked="" type="checkbox"/>	99min 59sec	999min 59.9sec	1 2 3 OFF <input type="checkbox"/>	9999hour	99999.9hour

(A) Photoelectric Sensors

(B) Fiber Optic Sensors

(C) Door/Area Sensors

(D) Proximity Sensors

(E) Pressure Sensors

(F) Rotary Encoders

(G) Connectors/ Connector Cables/ Sensor Distribution Boxes/Sockets

(H) Temperature Controllers

(I) SSRs / Power Controllers

(J) Counters

(K) Timers

(L) Panel Meters

(M) Tacho / Speed / Pulse Meters

(N) Display Units

(O) Sensor Controllers

(P) Switching Mode Power Supplies

(Q) Stepper Motors & Drivers & Controllers

(R) Graphic/ Logic Panels

(S) Field Network Devices

(T) Software

Input Operation Mode (Counter)

※CP: Clock Pulse

Input mode		SW	Voltage input (PNP) method	No-voltage input (PNP) method
Up mode OFF <input type="checkbox"/> 4 ON <input type="checkbox"/>	Up/Down-A (command input)	OFF <input type="checkbox"/> 2 3 ON <input type="checkbox"/>		
	Up/Down-B (individual input)	OFF <input type="checkbox"/> 2 3 ON <input type="checkbox"/>		
	Up/Down-C (phase difference input)	OFF <input type="checkbox"/> 2 3 ON <input type="checkbox"/>		
	Up (adding input)	OFF <input type="checkbox"/> 2 3 ON <input type="checkbox"/>		
Down mode OFF <input type="checkbox"/> 4 ON <input type="checkbox"/>	Up/Down-D (command input)	OFF <input type="checkbox"/> 2 3 ON <input type="checkbox"/>		
	Up/Down-E (individual input)	OFF <input type="checkbox"/> 2 3 ON <input type="checkbox"/>		
	Up/Down-F (phase difference input)	OFF <input type="checkbox"/> 2 3 ON <input type="checkbox"/>		
	Down (subtracting input)	OFF <input type="checkbox"/> 2 3 ON <input type="checkbox"/>		

※A: over min. signal width, B: over than 1/2 of min. signal width. If the signal is smaller than these width, it may cause counting error (± 1).

※n: +Max. display value (FX4Y-I: 9999, FX6Y-I: 999999)

■ Dot for Decimal Point / Hour. Min. Second

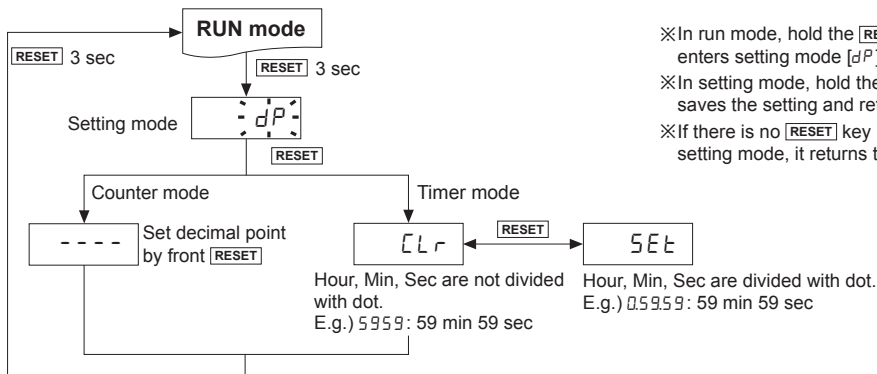

- ※In run mode, hold the **RESET** key for over 3 sec, and it enters setting mode [dP].
- ※In setting mode, hold the **RESET** key for over 3 sec, and it saves the setting and returns to RUN mode.
- ※If there is no **RESET** key input for 60 sec when entering setting mode, it returns to RUN mode.

■ Proper Usage

- Follow instructions in 'Proper Usage'. Otherwise, It may cause unexpected accidents.
- 24-48VDC, 24VAC power supply should be insulated and limited voltage/current or Class 2, SELV power supply device.
- Use the product, 0.1 sec after supplying power.
- When supplying or turning off the power, use a switch or etc. to avoid chattering.
- Install a power switch or circuit breaker in the easily accessible place for supplying or disconnecting the power.
- In case of contact input, set count speed to low speed mode (1cps or 30cps) to operate.
If set to high speed mode (2kcps or 5kcps), counting error occurs due to chattering.
- Keep away from high voltage lines or power lines to prevent inductive noise.
In case installing power line and input signal line closely, use line filter or varistor at power line and shielded wire at input signal line.
Do not use near the equipment which generates strong magnetic force or high frequency noise.
- This product may be used in the following environments.
 - ① Indoors (in the environment condition rated in 'Specifications')
 - ② Altitude max. 2,000m
 - ③ Pollution degree 2
 - ④ Installation category II

(A)	Photoelectric Sensors
(B)	Fiber Optic Sensors
(C)	Door/Area Sensors
(D)	Proximity Sensors
(E)	Pressure Sensors
(F)	Rotary Encoders
(G)	Connectors/ Connector Cables/ Sensor Distribution Boxes/Sockets
(H)	Temperature Controllers
(I)	SSRs / Power Controllers
(J)	Counters
(K)	Timers
(L)	Panel Meters
(M)	Tacho / Speed / Pulse Meters
(N)	Display Units
(O)	Sensor Controllers
(P)	Switching Mode Power Supplies
(Q)	Stepper Motors & Drivers & Controllers
(R)	Graphic/ Logic Panels
(S)	Field Network Devices
(T)	Software