

Варианты задания №2 «Построение ступенчатого разреза»

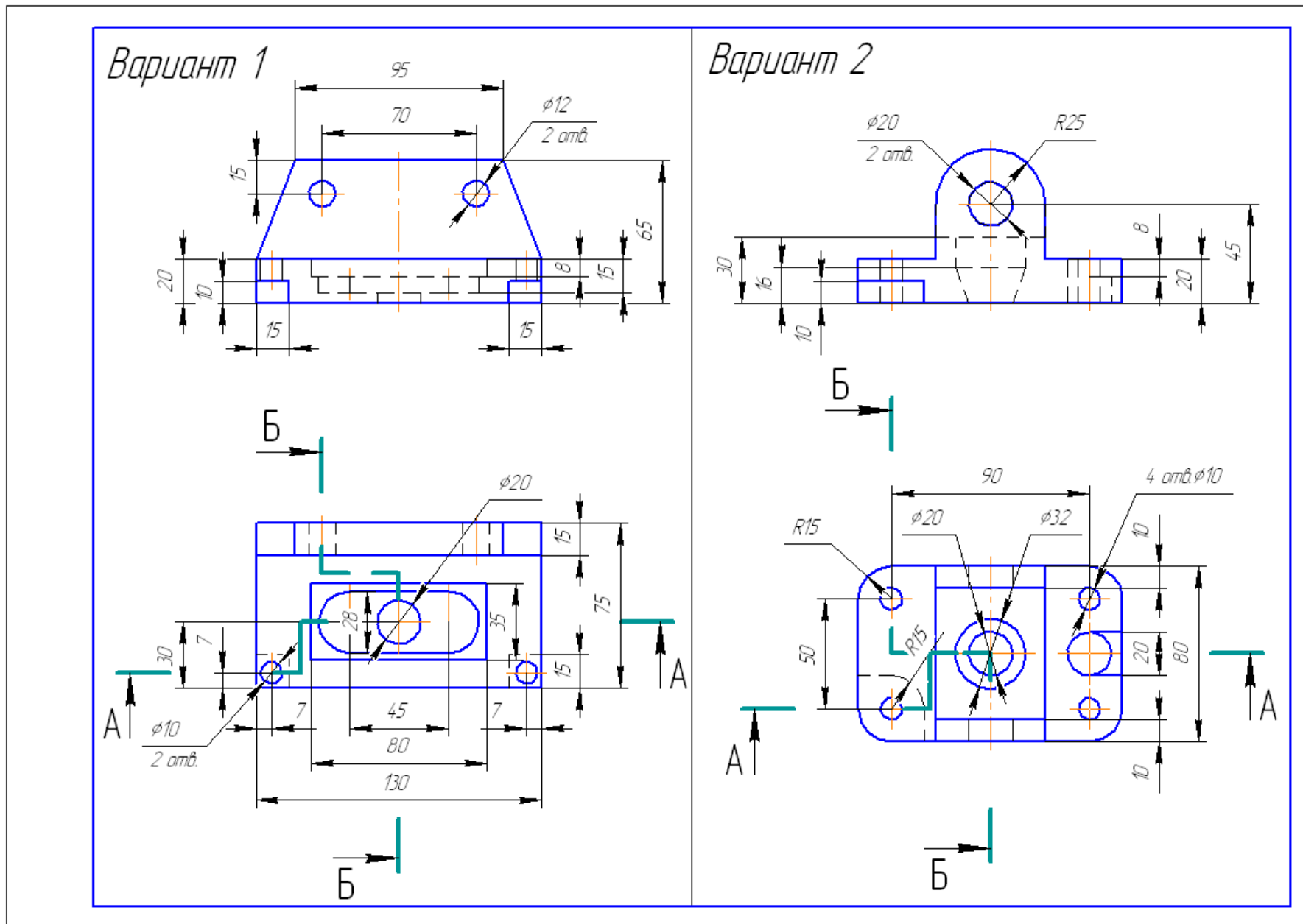

Вариант 3

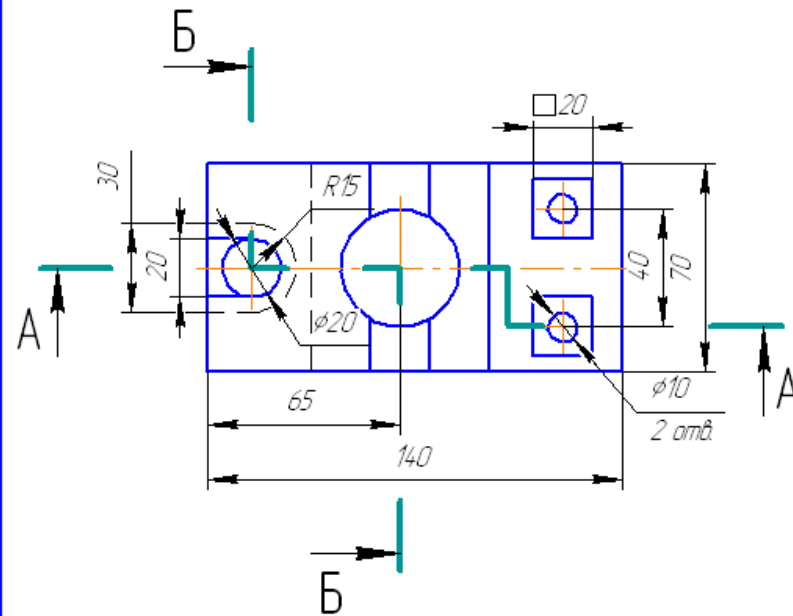
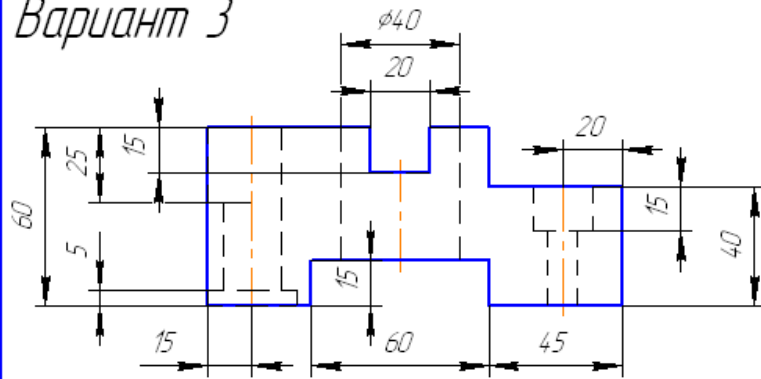

Вариант 4

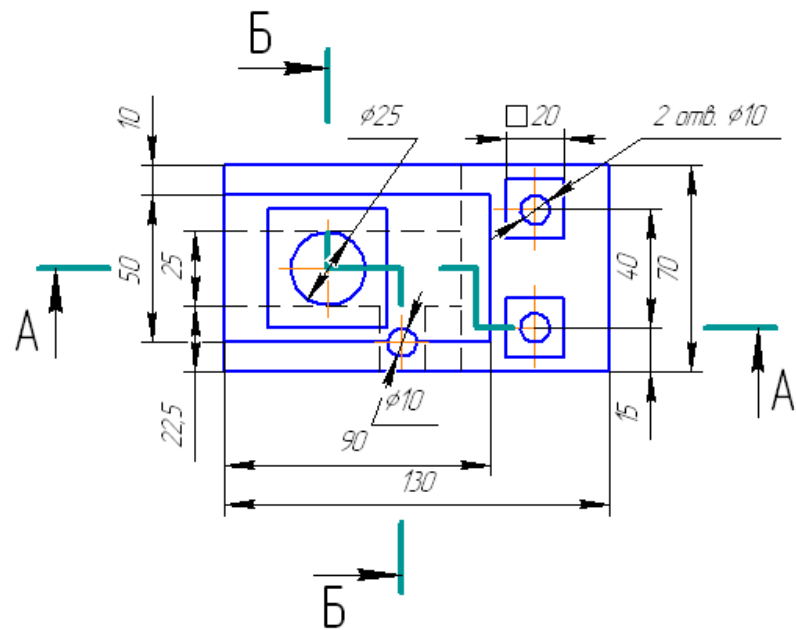
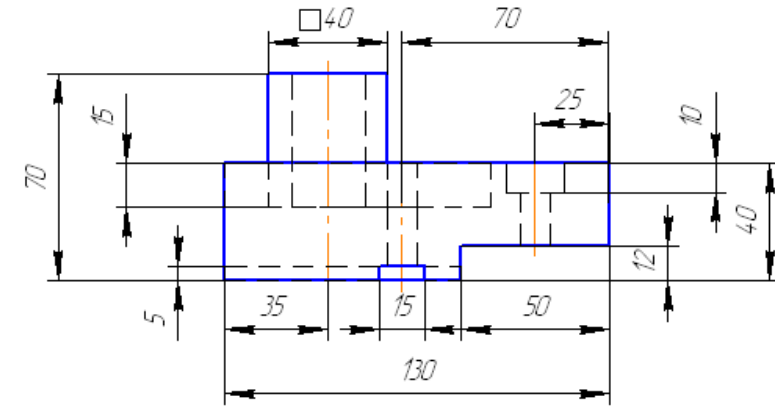

Вариант 5

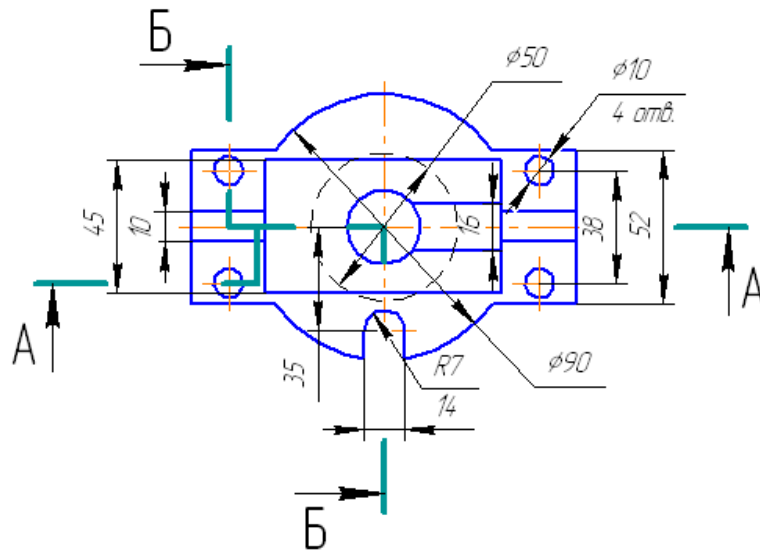
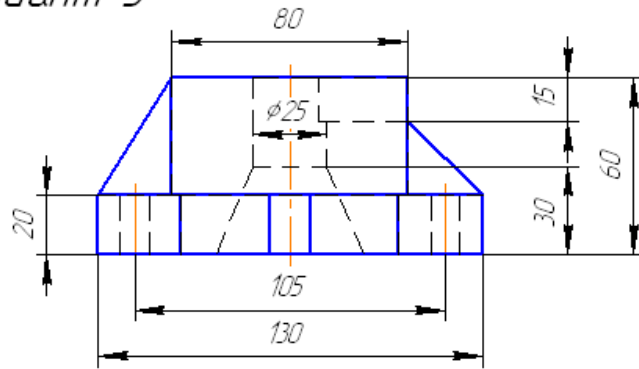

Вариант 6

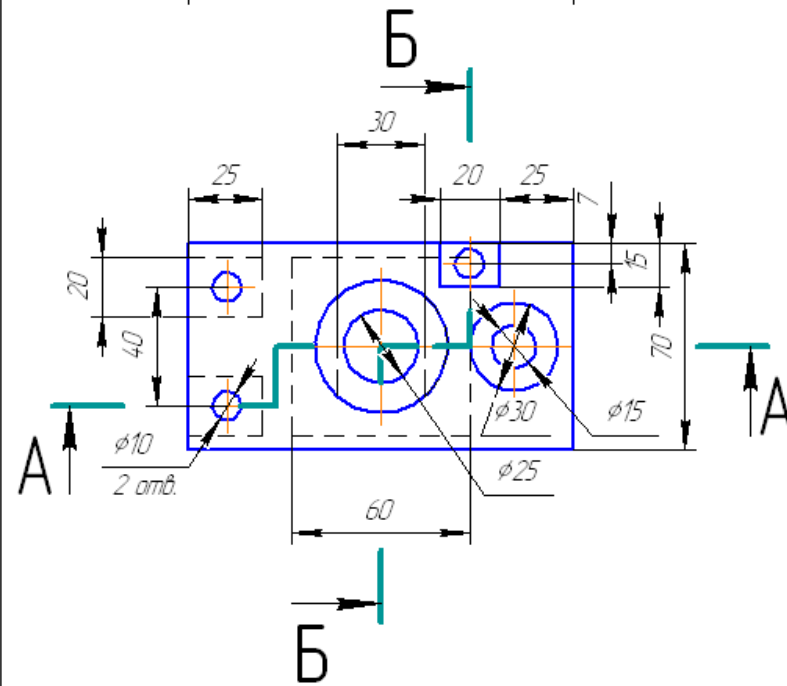
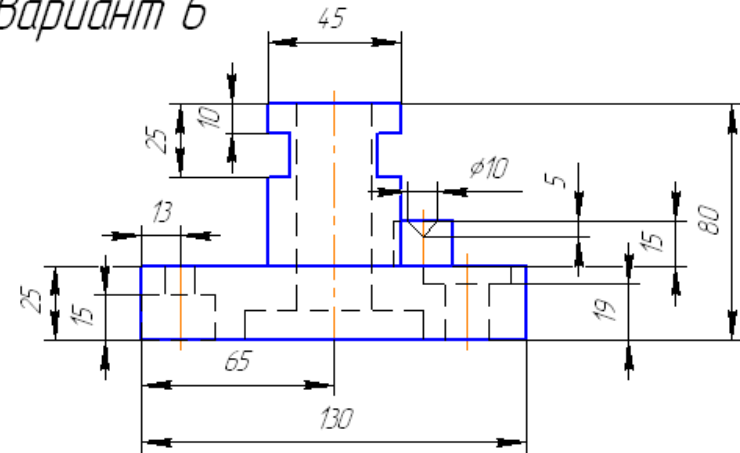

Вариант 7

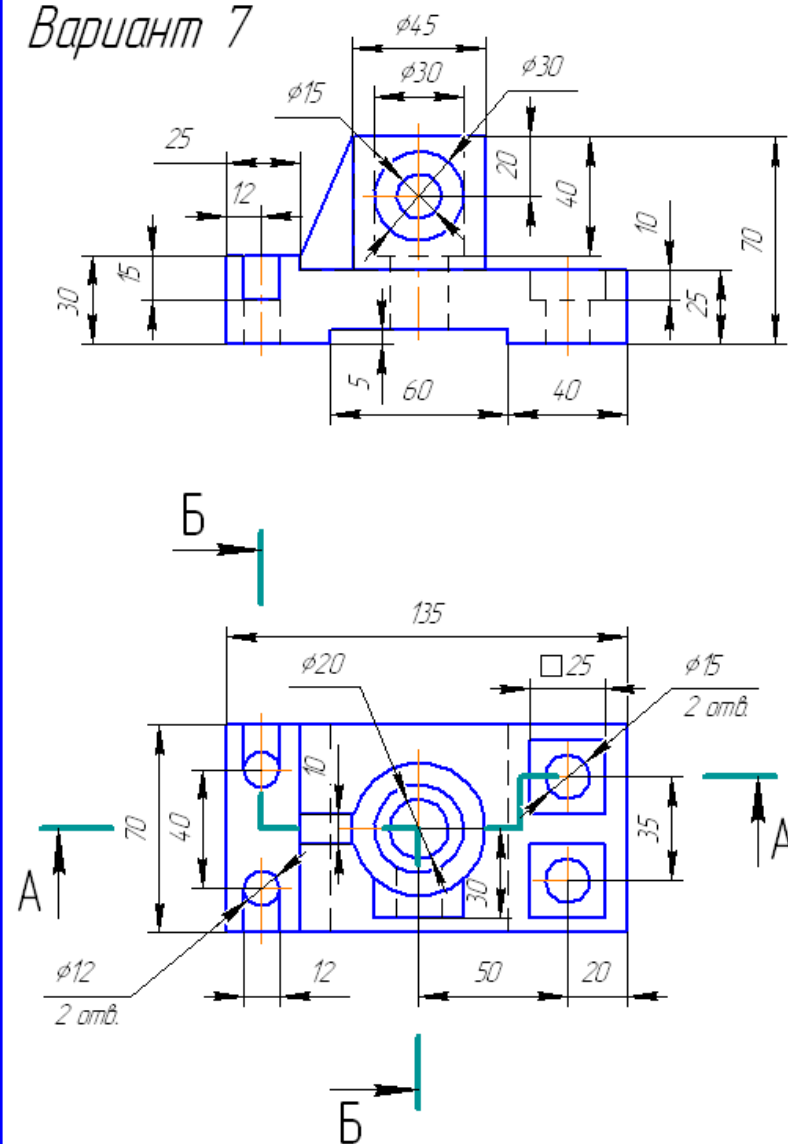

Вариант 8

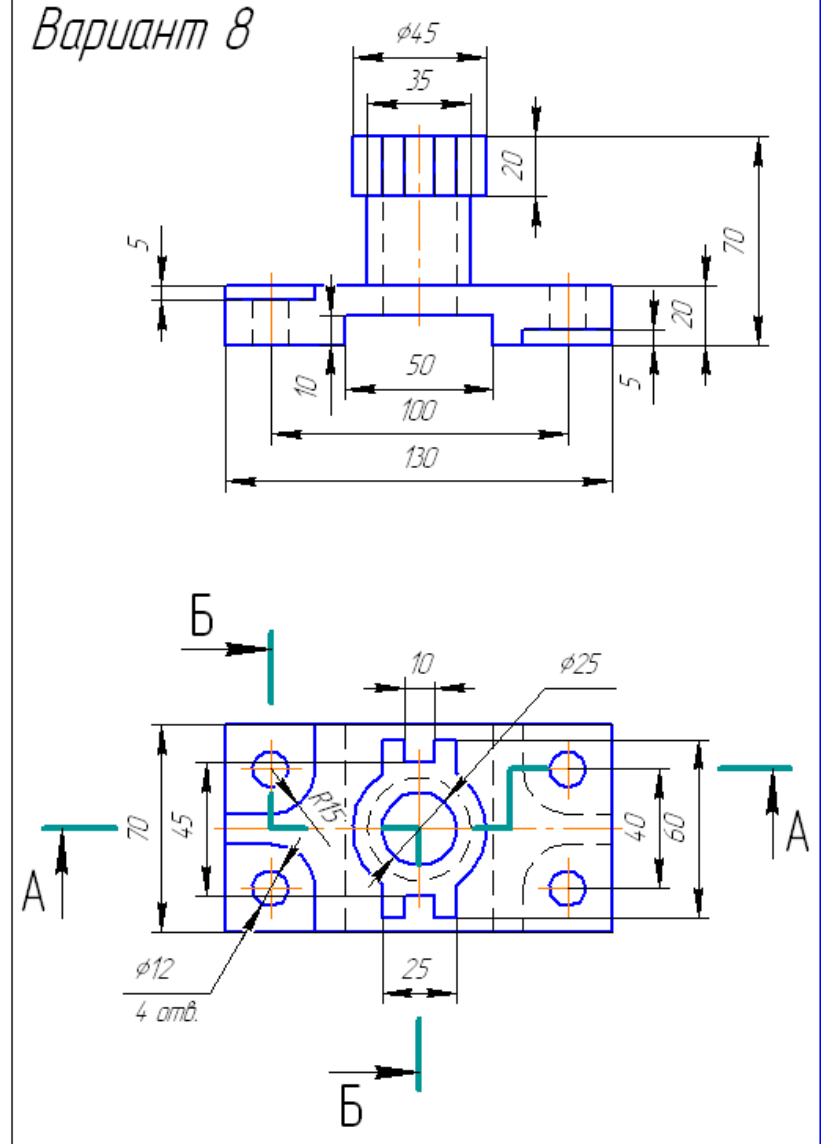

Вариант 9

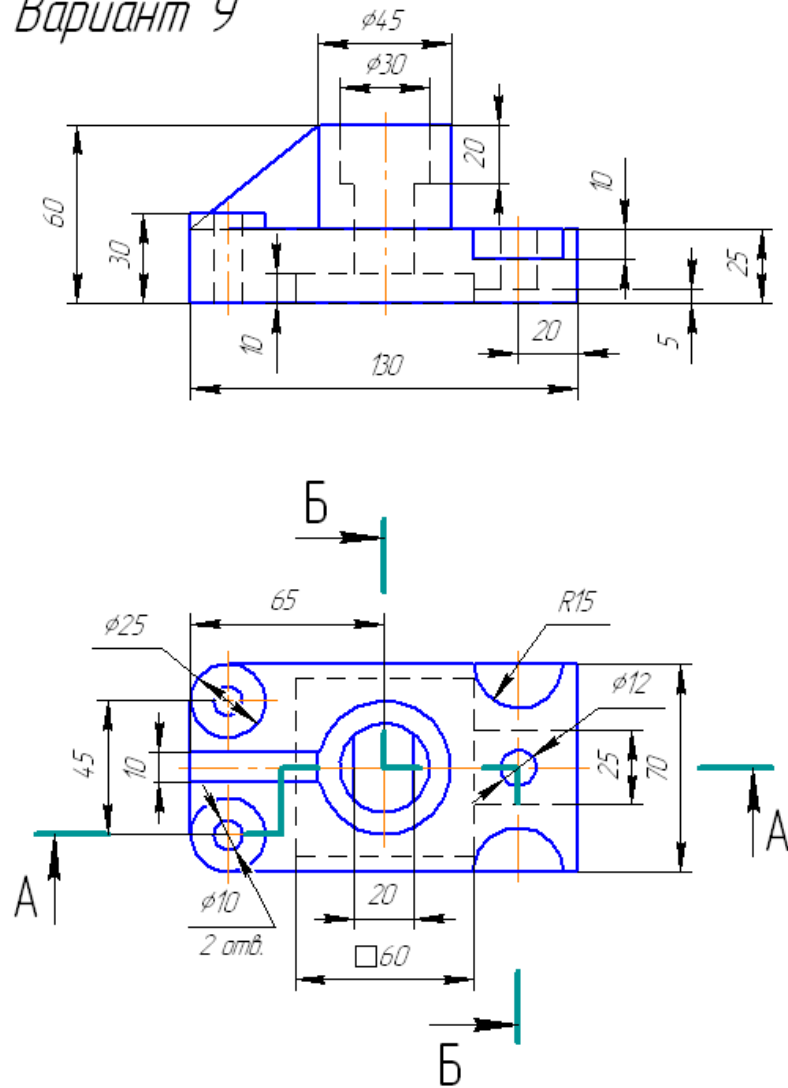

Вариант 10

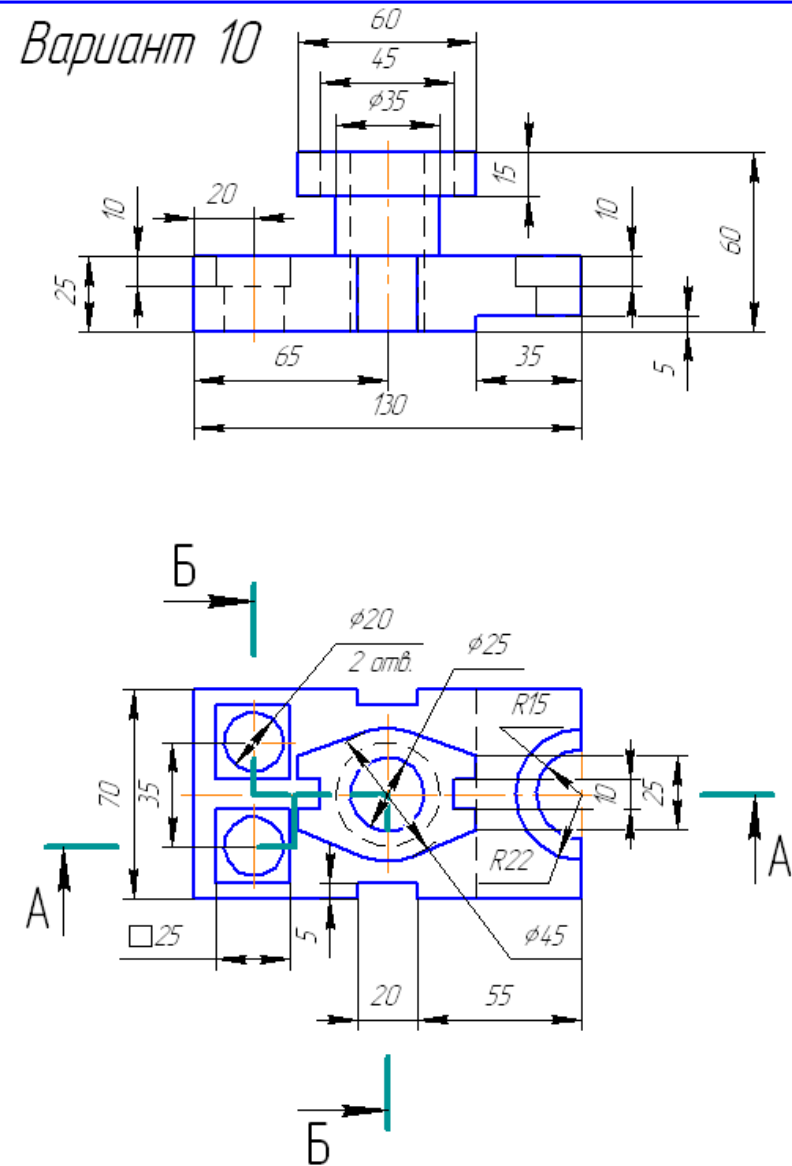

Вариант 11

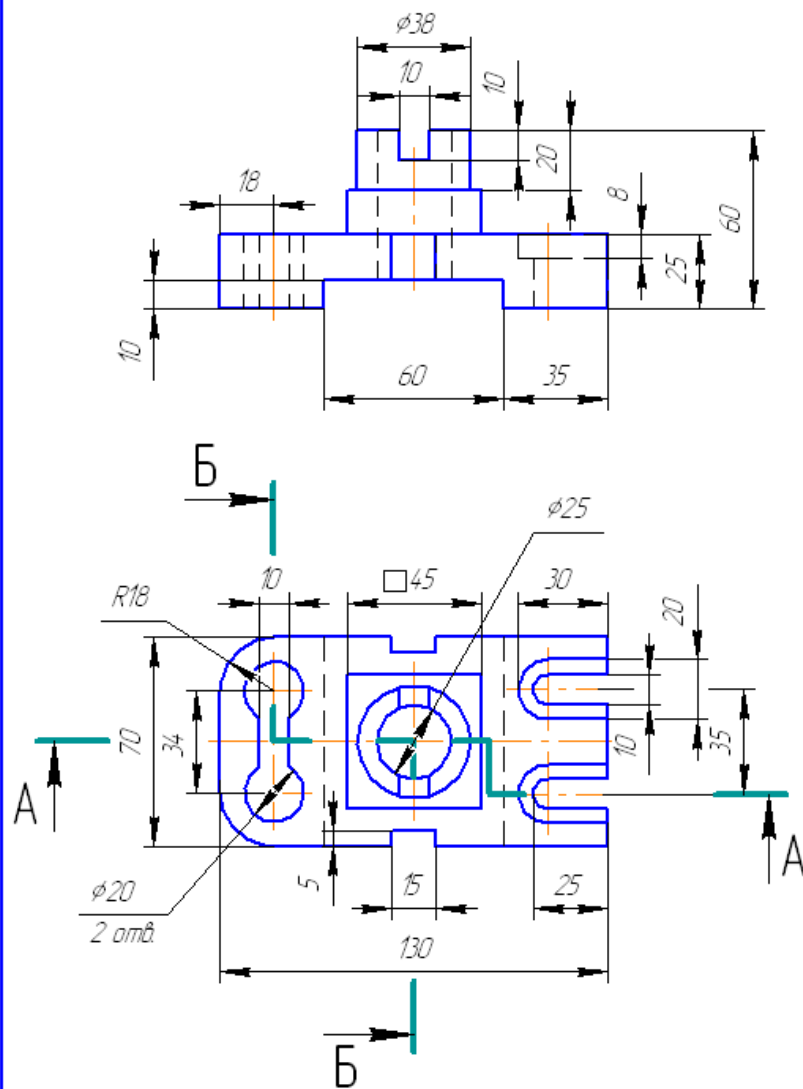

Вариант 12

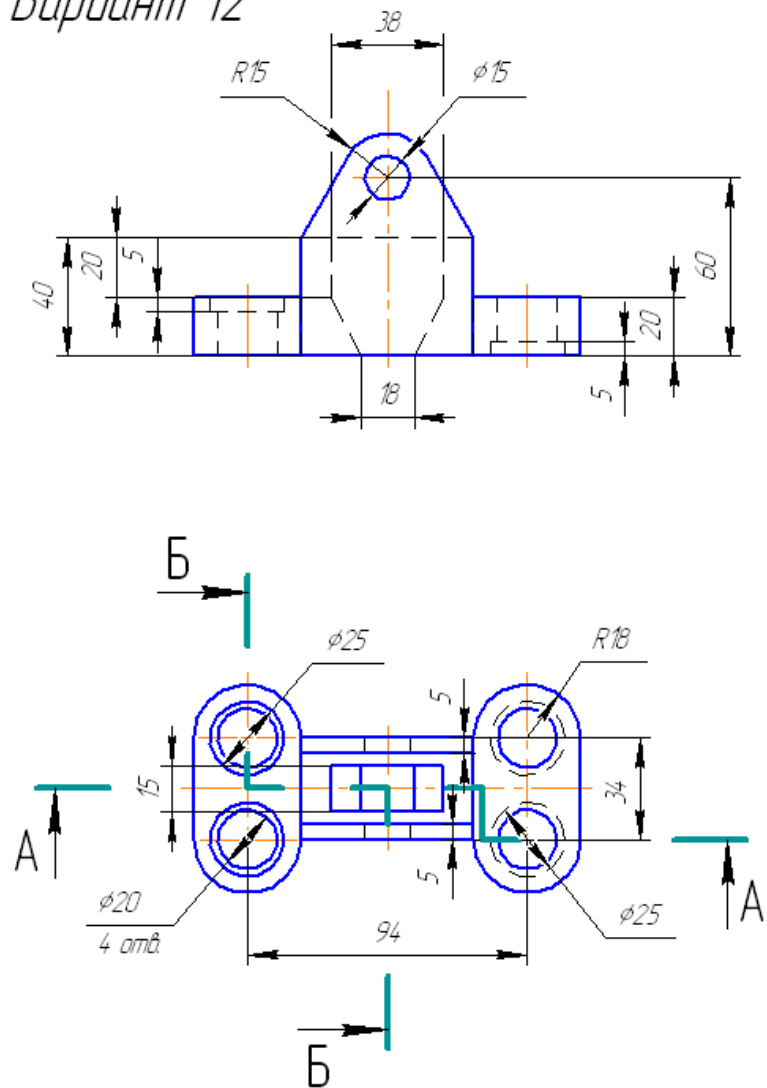

Вариант 13

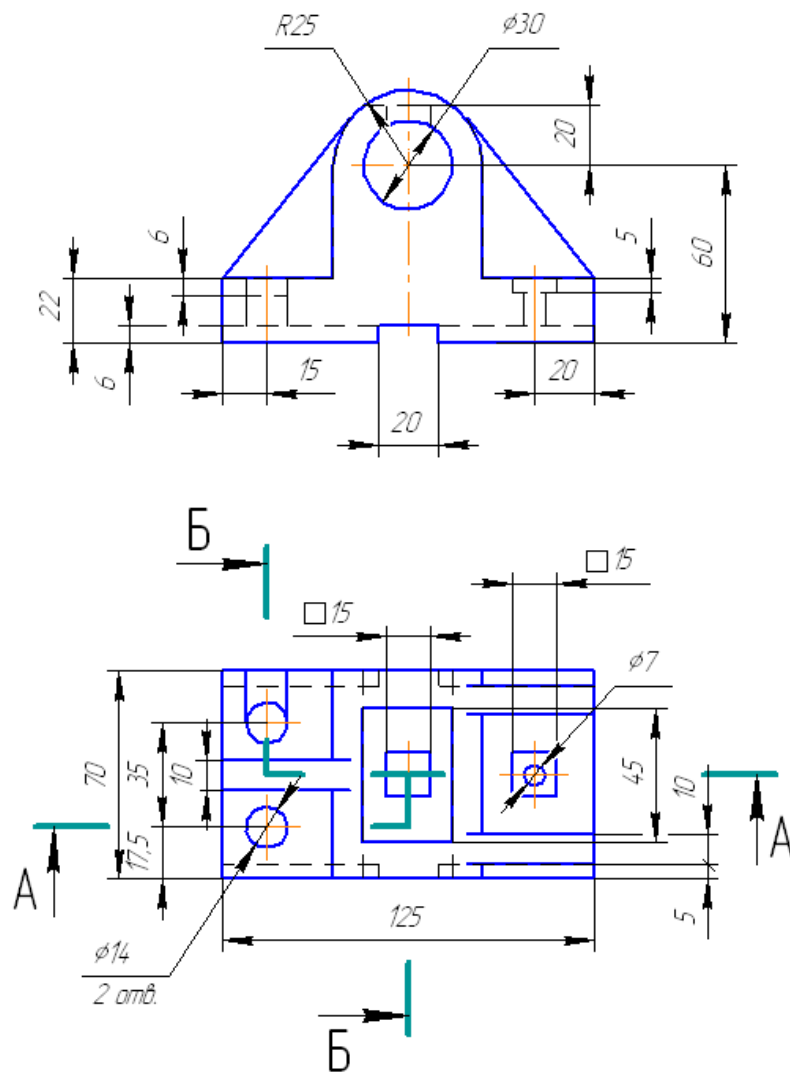

Вариант 14

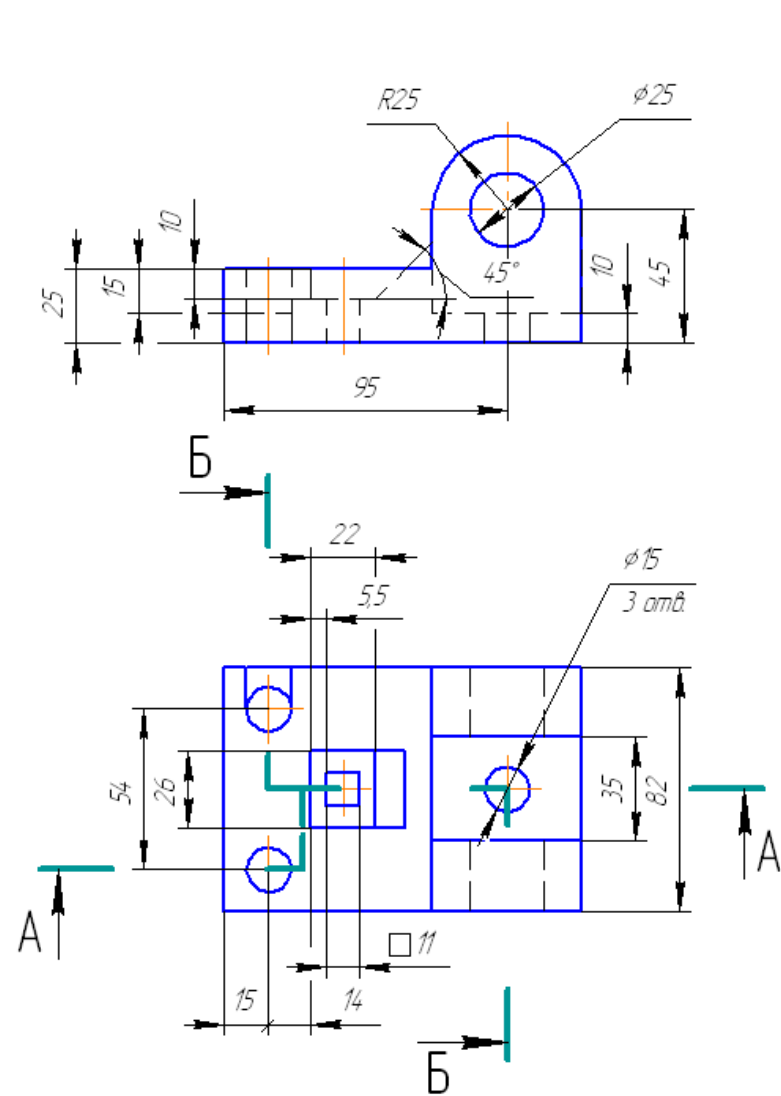

Вариант 15

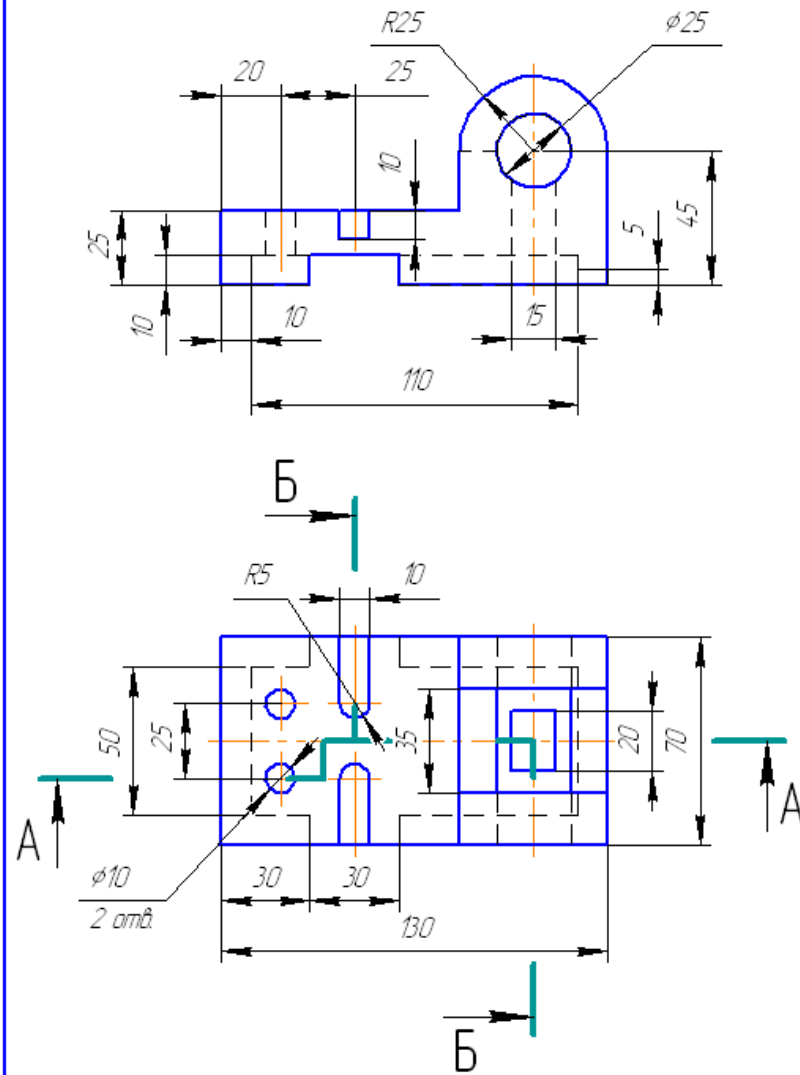

Вариант 16

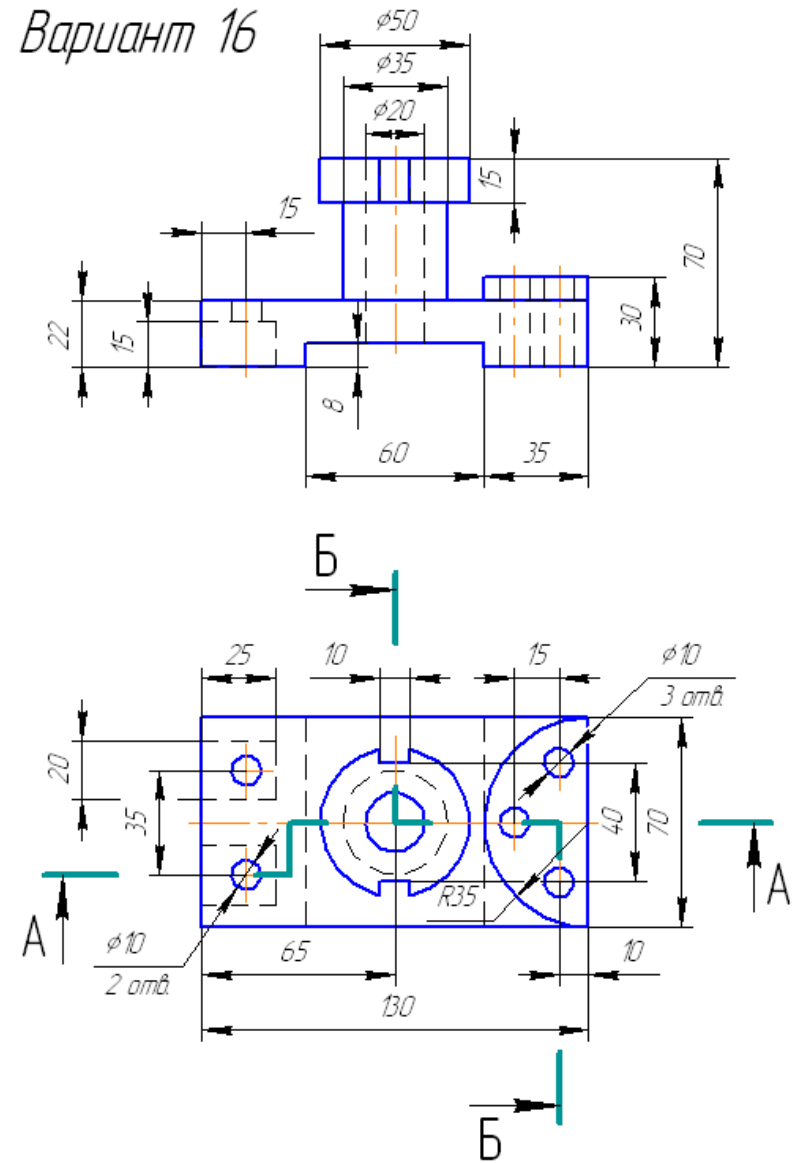

Вариант 19

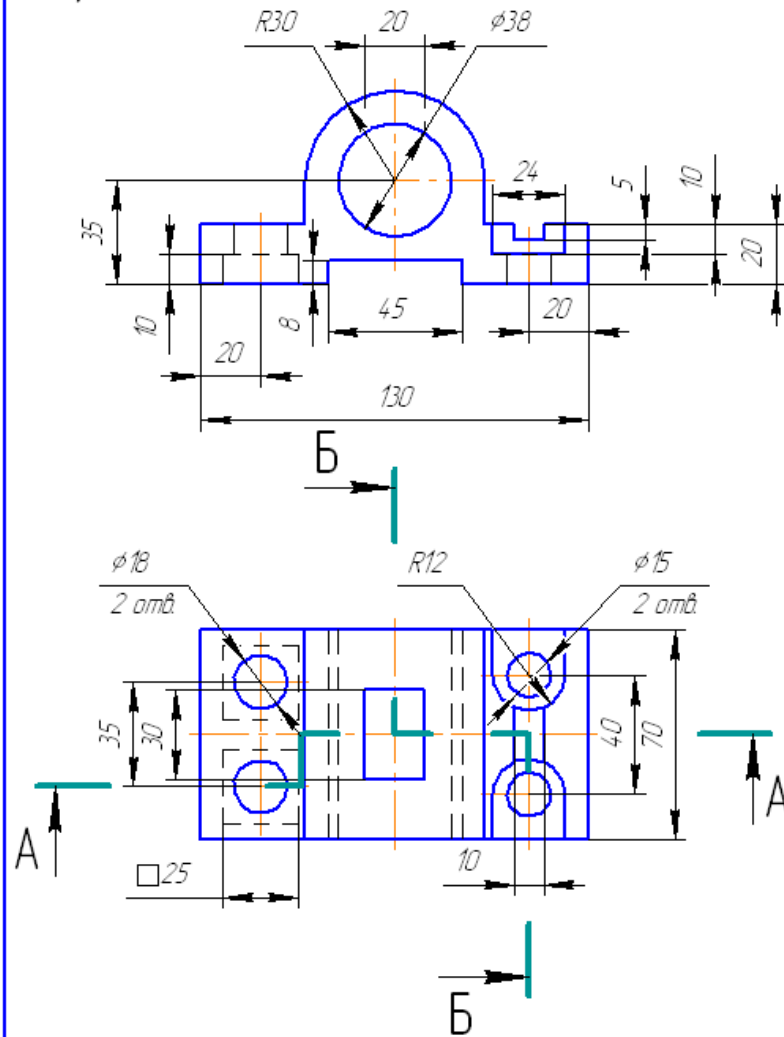

Вариант 20

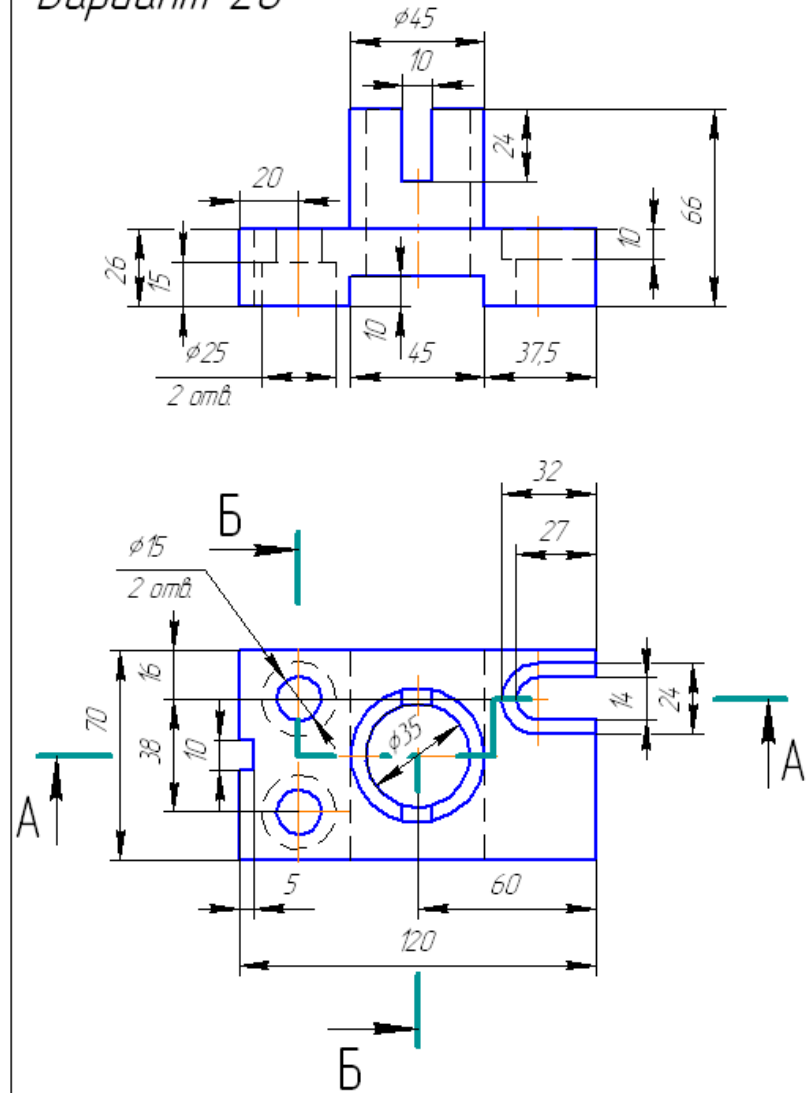

Вариант 21

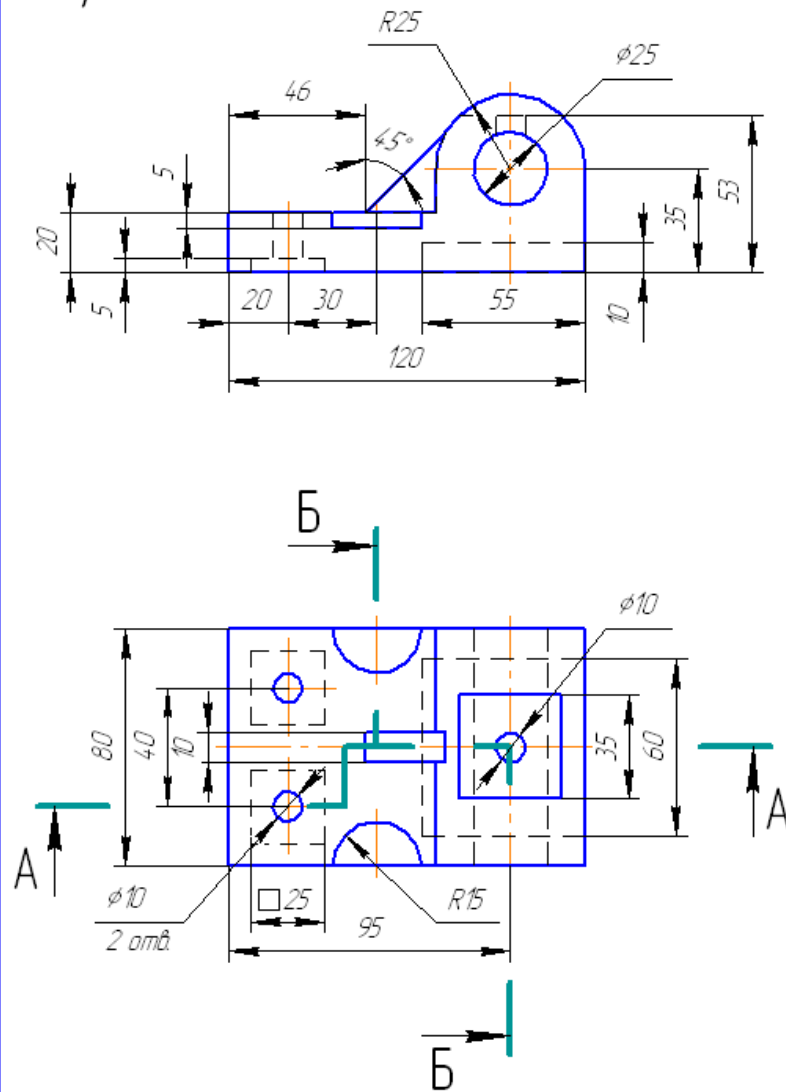

Вариант 22

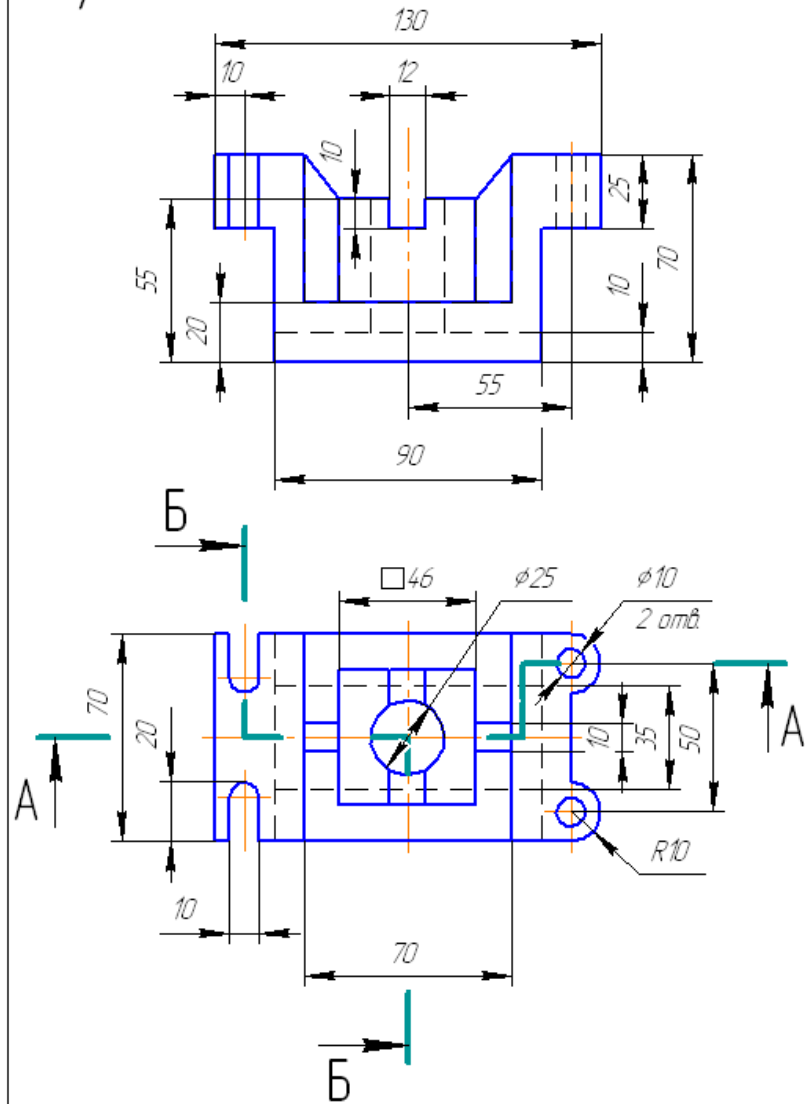

Вариант 23

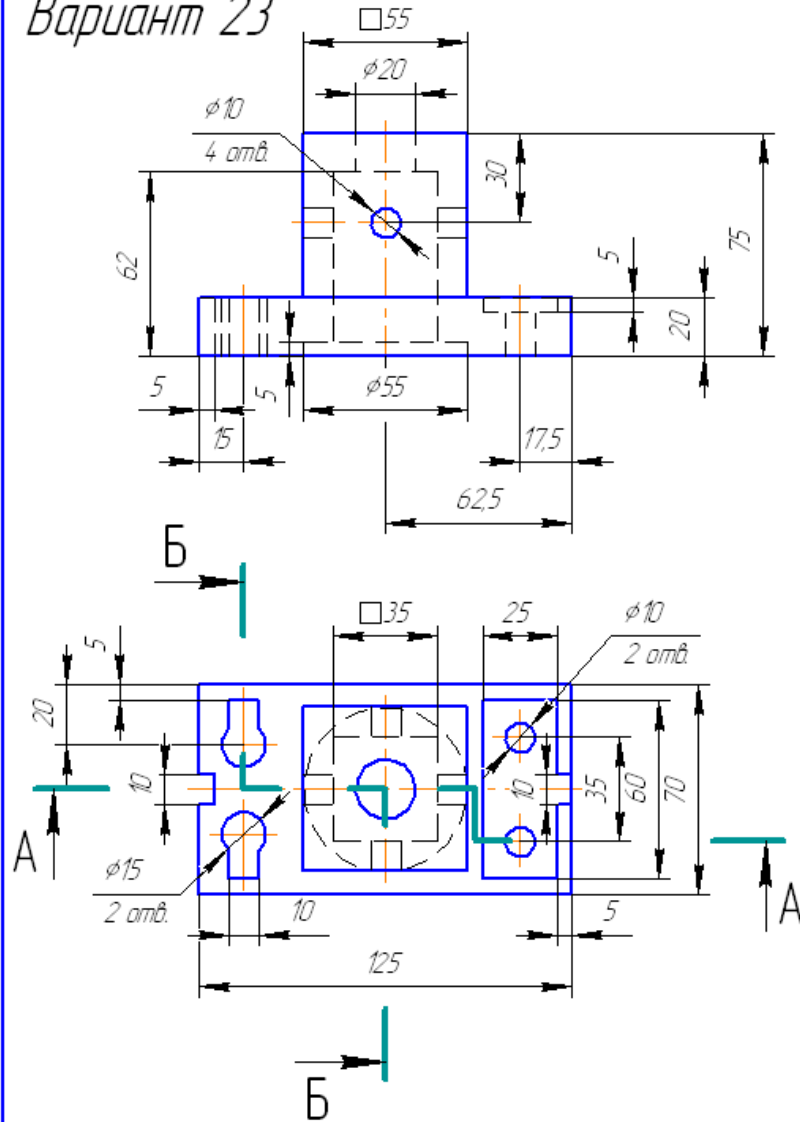

Вариант 24

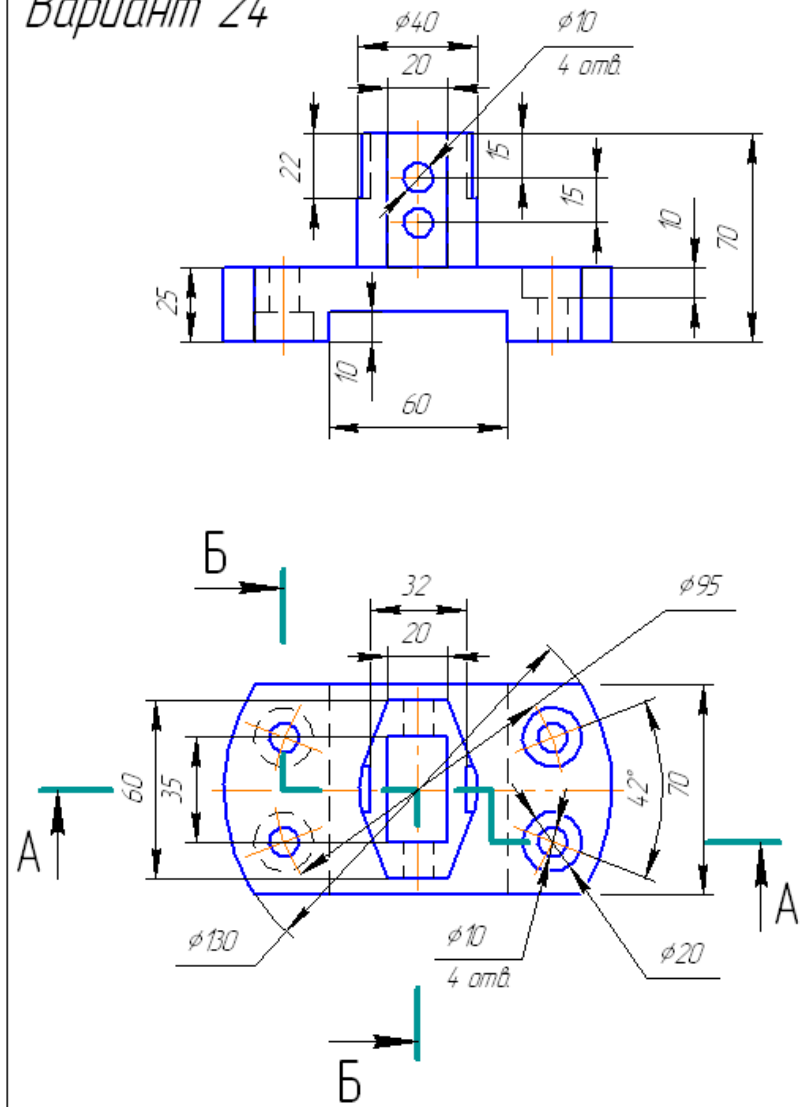

Вариант 25

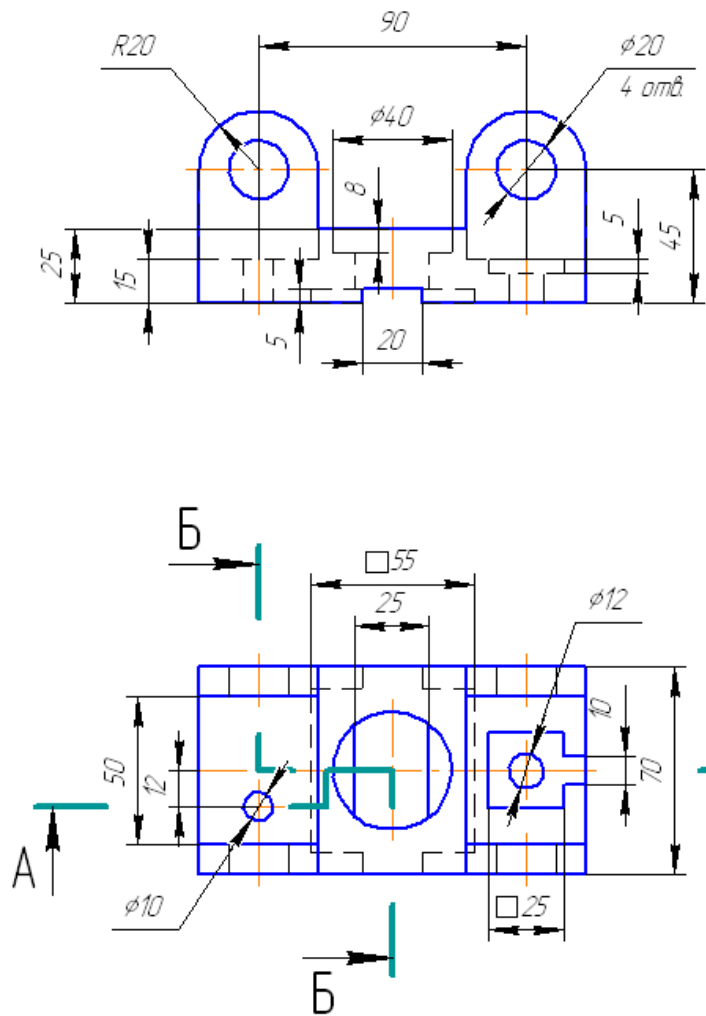

Вариант 26

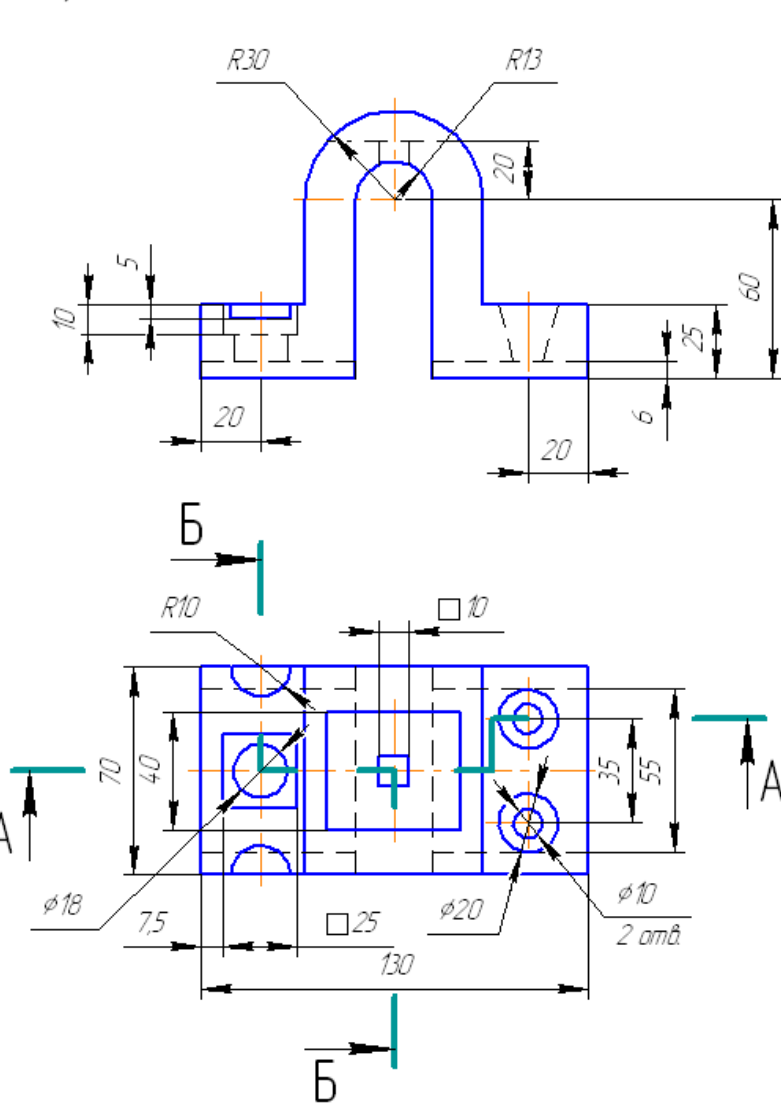

Вариант 27

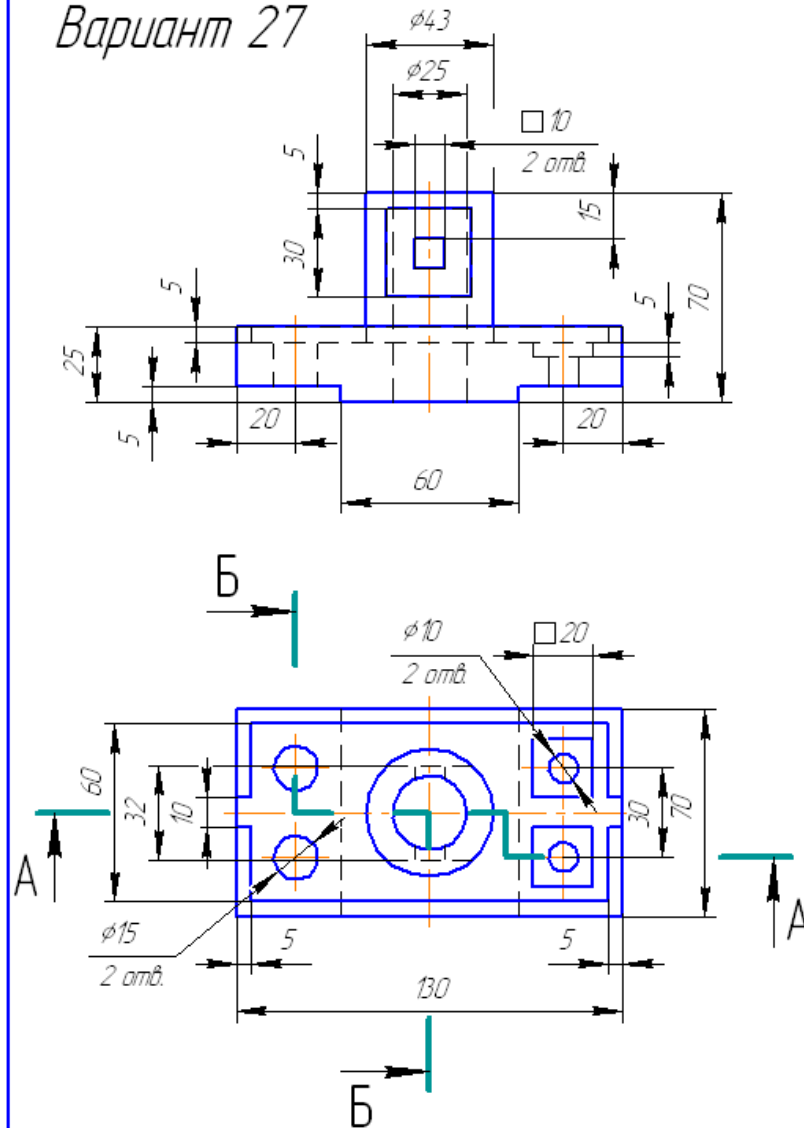

Вариант 28

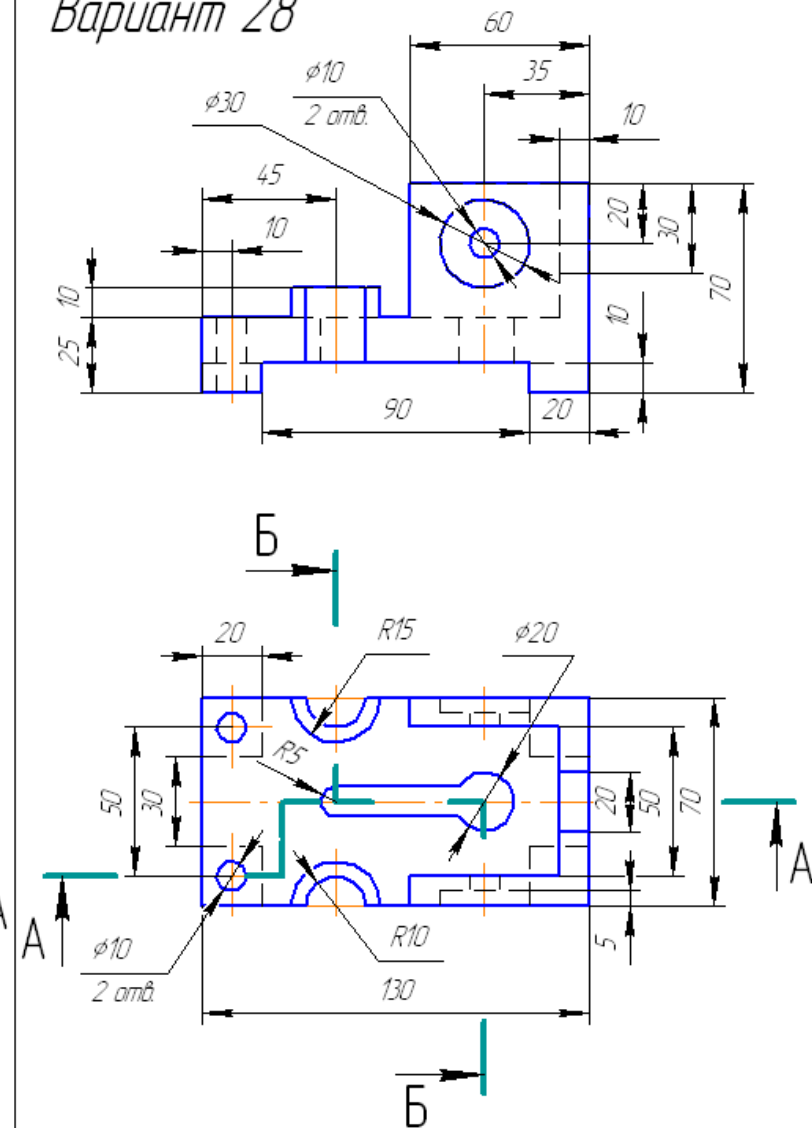

Вариант 29

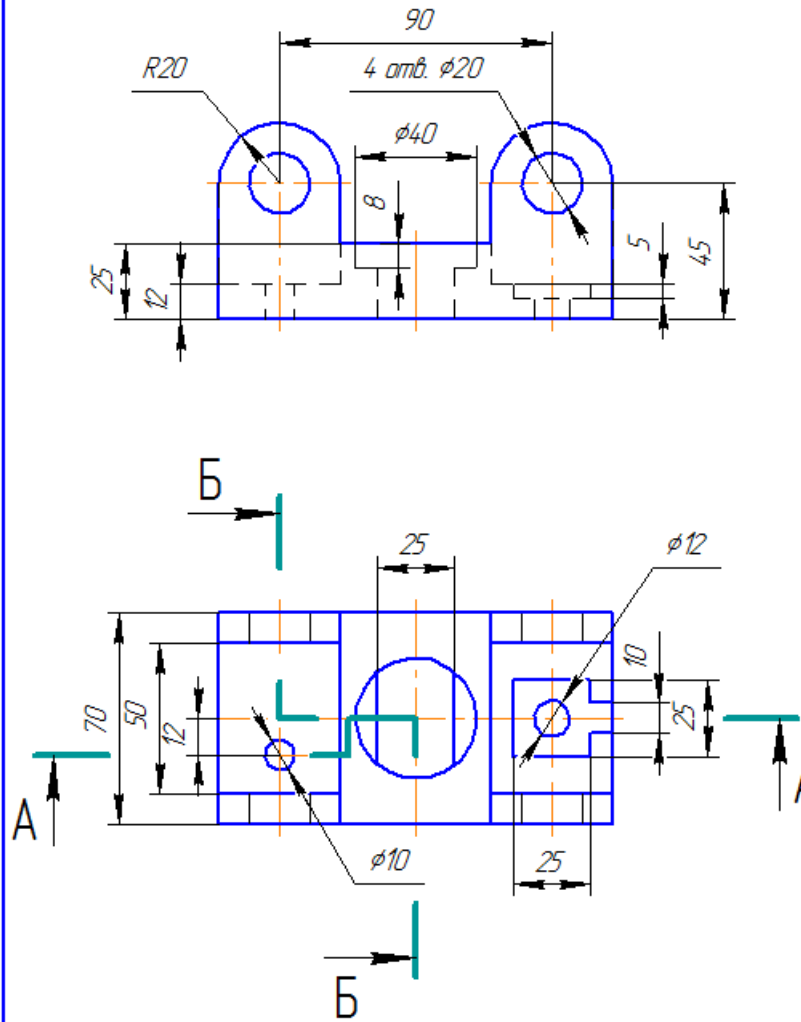

Вариант 30

