

Title	Designing the digital transformation: DESRIST 2017 research in progress proceedings
Editor(s)	Maedche, Alexander vom Brocke, Jan Hevner, Alan
Publication date	2017
Original citation	Maedche, A., vom Brocke, J., Hevner, A. (2017) Designing the Digital Transformation: DESRIST 2017 Research in Progress Proceedings. Karlsruhe, Germany. 30 May - 1 Jun. Karlsruhe: Karlsruher Institut für Technologie (KIT)
Type of publication	Conference item
Link to publisher's version	https://publikationen.bibliothek.kit.edu/1000069452 http://desrist2017.kit.edu/ http://dx.doi.org/10.5445/IR/1000069452 Access to the full text of the published version may require a subscription.
Rights	©2017, The Author(s). This document is licensed under the Creative Commons Attribution – Share Alike 4.0 International License (CC BY-SA 4.0): https://creativecommons.org/licenses/by-sa/4.0/deed.en https://creativecommons.org/licenses/by-sa/4.0/deed.en
Item downloaded from	http://hdl.handle.net/10468/4457

Downloaded on 2018-08-23T18:28:47Z



UCC

University College Cork, Ireland
 Coláiste na hOllscoile Corcaigh

Designing the Digital Transformation

DESRIST 2017 Research in Progress Proceedings

Alexander Maedche¹, Jan vom Brocke², Alan Hevner³ (Eds.)

KIT SCIENTIFIC WORKING PAPERS 64

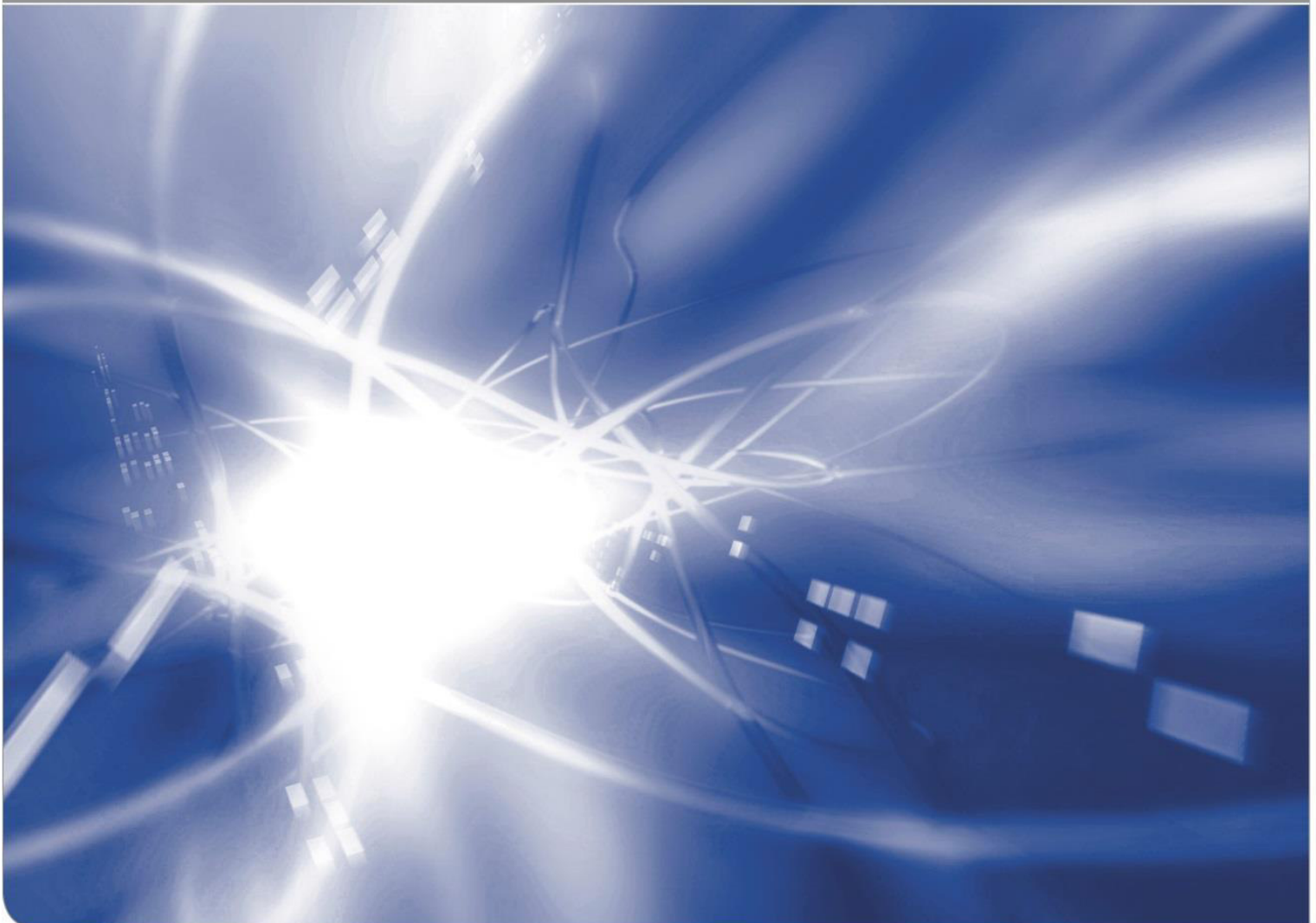

¹ Karlsruhe Institute of Technology (KIT), Karlsruhe, Germany

² University of Liechtenstein, Liechtenstein

³ University of South Florida, USA

Research in Progress Proceedings of the 12th International Conference on
Design Science Research in Information Systems and Technology

DESRIST website: <http://desrist2017.kit.edu>

Institute of Information Systems and Marketing (IISM)
Fritz-Erler-Straße 23
76133 Karlsruhe, Germany
<http://iism.kit.edu>

Impressum

Karlsruher Institut für Technologie (KIT)
www.kit.edu



This document is licensed under the Creative Commons Attribution – Share Alike 4.0 International License (CC BY-SA 4.0): <https://creativecommons.org/licenses/by-sa/4.0/deed.en>

2017

DOI: 10.5445/IR/1000069452

ISSN: 2194-1629

Preface

This volume contains selected research in progress papers at DESRIST 2017 – the 12th International Conference on Design Science Research in Information Systems and Technology held during May 30 – June 1, 2017, at Karlsruhe, Germany.

This year's DESRIST conference continues the tradition of advancing and broadening design research within the information systems discipline. DESRIST brings together researchers and practitioners engaged in all aspects of Design Science Research (DSR), with a special emphasis on nurturing the symbiotic relationship between Design Science researchers and practitioners. As in previous years, scholars and design practitioners from various areas, such as information systems, business & operations research, computer science, and industrial design come together to discuss both challenges and opportunities of Design Science and to solve design problems through the innovative use of information technology and applications. The outputs of DESRIST, new and innovative constructs, models, methods, processes, and systems, provide the basis for novel solutions to design problems in many fields. The conference further builds on the foundation of eleven prior highly successful international conferences held in Claremont, Pasadena, Atlanta, Philadelphia, St. Gallen, Milwaukee, Las Vegas, Helsinki, Miami, Dublin, and St. Johns.

The 12th DESRIST conference has the theme "Designing the Digital Transformation" and emphasizes the contemporary challenge of transforming businesses and society using information technologies. The rapid digital transformation of businesses and society creates new challenges and opportunities for Information Systems (IS) research with a strong focus on design, which relates to manifold application areas of IS research. This year's DESRIST, therefore, introduces selected themes in order to account for and further stimulate DSR in such areas. Specifically, DESRIST features seven themes: DSR in business process management, DSR in human computer interaction, DSR in data science & business analytics, DSR in service science, methodological contributions, domain-specific DSR applications, and emerging themes and new ideas. In total, we received 135 submissions (66 full research papers, 19 prototypes and products, and 50 research-in-progress papers) to the conference for review. Each research paper was reviewed by a minimum of two referees. In this proceedings appear 21 research in progress papers, with an acceptance rate of 42%. The full research paper and descriptions of prototypes and products are published in the separate Springer LNCS proceedings.

We would like to thank all authors who submitted their papers to DESRIST 2017. We trust that the readers will find them as interesting and informative as we did. We would like to thank all members of the Program Committee as well as the many additional reviewers who took the time to provide detailed and constructive critiques for the authors. We are grateful for the support of many colleagues who took responsibility in Chair positions, such as the Doctoral Consortium Chairs, the Industry Track Chairs, the Product and Prototype Chairs, and the Local Arrangement Chairs, as well as for the great dedication of the many volunteers, whose efforts were instrumental to bring about another successful DESRIST conference. Our special thanks go to Dr. Stefan Morana who managed the operational review and publication process in his role as Proceedings Chair. Furthermore, we thank the Karlsruhe Institute of Technology (KIT) and the sponsoring organizations, in particular SAP, Bosch, IBM, Senacor, as well as the Cyberforum / Digital Innovation Center for their support. We believe the papers in these proceedings provide many interesting and valuable insights into the theory and practice of DSR. They open up new and exciting possibilities for future research in the discipline.

May 2017

Alexander Maedche, Jan vom Brocke, Alan Hevner

Organization Committees

General Chairs

Jeffrey Parsons, Memorial University of Newfoundland
John Venable, Curtin University, Australia
Tuure Tuunanen, University of Jyväskylä, Finland

Program Chairs

Alexander Maedche, Karlsruhe Institute of Technology (KIT), Germany
Jan vom Brocke, University of Liechtenstein, Liechtenstein
Alan Hevner, University of South Florida, USA

Theme Chairs

DSR in Business Process Management

Wil van der Aalst, TU Eindhoven, Netherlands
Jan Mendling, WU Vienna, Austria
Michael Rosemann, QUT Brisbane, Australia

DSR in Human Computer Interaction

Marc Adam, The University of Newcastle, Australia
Rene Riedl, Johannes Kepler University Linz, Austria
Dov Te'eni, Tel-Aviv University, Israel

DSR in Data Science & Business Analytics

Wolfgang Ketter, Erasmus University Rotterdam, Belgium
Sudha Ram, The University of Arizona, USA
Ahmed Abbasi, University of Virginia, USA

DSR in Service Science

Daniel Beverungen, University of Paderborn, Germany
Jan Marco Leimeister, University of St.Gallen, Switzerland
Jim Spohrer, IBM, USA

Methodological Contributions

Jan Pries-Heje, Roskilde Universitet, Denmark
Sandeep Purao, Bentley University, USA
Matti Rossi, Aalto University, Finland

Domain-specific DSR Applications

Jörg Becker, University of Münster, Germany
Samir Chatterjee, Claremont Graduate University, USA
Brian Donnellan, Maynooth University, Ireland

Emerging Themes and New Ideas

Robert Winter, University of St.Gallen, Switzerland
John Venable, Curtin University, Australia
Monica Chiarini Tremblay, Florida International University, USA

Products & Prototypes

Peter Loos, Saarland University, Germany
Oliver Müller, IT University Copenhagen, Denmark
Jason Thatcher, Clemson University, USA

Doctoral Consortium Chairs

Shirley Gregor, Australian National University, Australia
Gerd Schwabe University of Zürich, Switzerland
Stefan Seidel, University of Liechtenstein, Liechtenstein

Industry Chairs

Helmut Krcmar, Technical University of Munich, Germany
Norbert Koppenhagen, SAP SE, Germany
Gerhard Satzger, IBM and Karlsruhe Institute of Technology (KIT), Germany

Local Arrangements Chairs

Silvia Schacht, Karlsruhe Institute of Technology (KIT), Germany
Peter Hottum, Karlsruhe Institute of Technology (KIT), Germany

Proceedings Chair

Stefan Morana, Karlsruhe Institute of Technology (KIT), Germany

Program Committee and Reviewer

Adi Wolfson	Dominik Augenstein	Kazem Haki	Raphael Rissler
Agnis Stibe	Dominik Dellermann	Ken Peffers	Raphael Schilling
Aileen Cater-Steel	Dominik Jung	Keng Siau	Reima Suomi
Akhilesh Bajaj	Doo-Hwan Bae	Keumseok Kang	Rene Abraham
Akshay Bhagwatwar	Doug Vogel	Kevin Sullivan	Richard Boland
Alex Winkelmann	Edward Curry	Kevin Williams	Richard N. Taylor
Alexander Simons	Eileen Doherty	Kittisak Sirisaengtaksin	Riita Hekkala
Alivelu Mukkamala	Eric T.K. Lim	Konstantina Valogianni	Rob Gleasure
Amir Haj-Bolouri	Erik Proper	Kunihiko Higa	Robert Wehlitz
Amit Basu	Ewa Lux	Lakshmi Iyer	Rocco Raso
Andreas Oberweis	Fabian Hunke	Leona Chandra	Roel Wieringa
Andreas Solti	Florian Hawlitschek	Maedeh Yassaee	Roman Lukyanenko
Andrija Javor	Florian Müller	Mahei Li	Samuli Pekkola
Anindya Datta	Frederik Ahlemann	Manjul Gupta	Sara Hofmann
Annika Lenz	Fu-Ren Lin	Marc Busch	Srikar Velichety
Anthony Ross	Gabriel Costello	Marco De Marco	Stacie Petter
Antonia Albani	Gabriela Beirão	Marcus Rothenberger	Stefan Feuerriegel
Arin Brahma	George M. Wyner	Mario Nadj	Steffen Höhenberger
Arturo Castellanos	George Widmeyer	Mark Roxburgh	Stephan Aier
Arun Sen	Gerold Wagner	Markus Helfert	Steven Alter
Atish P. Sinha	Gilbert Fridgen	Markus Monhof	Steven R. Haynes
Axel Winkelmann	Giovanni Maccani	Markus Weinmann	Subodha Kumar
Balaji Padmanabhan	Gondy Leroy	Martin Matzner	Susan Finger
Barbara Dinter	Guoqing Chen	Mathias Petsch	Susanne Leist
Benedikt Morschheuser	Guy-Alain Amoussou	Maung Sein	Sven A. Carlsson
Benedikt Notheisen	Hadar Ronen	Maximilian Brosius	Sven Carlsson
Bengisu Tulu	Hajo A. Reijers	Meira Levy	Sven Jannaber
Benjamin Gaunitz	Hangjung Zo	Michael Blaschke	Tamara Babaian
Benjamin Spottke	Harry Jiannan Wang	Michael Schermann	Tamir Bechor
Björn Niehaves	Hedda Luettgenberg	Mikael Lind	Tero Päiväranta
Brian Cameron	Hemant Jain	Mike Goul	Thant Syn
Carson Woo	Henk Sol	Mohammed Alsaqer	Thomas Fischer
Carsten Felden	Henrik Leopold	Monika Malinova	Thorsten Staake
Cecilia Rossignoli	Herbert Jelinek	Munir Mandviwalla	Tilo Böhmman
Celina Friemel	Hissu Hyvärinen	Murali Raman	Timm Teubner
Charles Møller	Hoang Nguyen	Narasimha Bolloju	Ting-Peng Liang
Chen-Huei Chou	Inbal Yahav	Neelam Raigangar	Tomer Geva
Chih-Ping Wei	Irit Hadar	Niall Connolly	Tyler Noorbergen
Chris Zimmerman	Ishwar Murthy	Nick van Beest	Uday Kulkarni
Christian Bartelheimer	Jae Choi	Nils Bergmann	Udo Bub
Christian Hrach	Jairo Gutierrez	Novica Zarvic	Ulrich Bretschneider
Christian Janiesch	James Rodger	Ohad Barzilay	Ulrich Frank
Christine Legner	Jan Hendrik Betzing	Olayan Alharbi	Ulrich Gnewuch
Christoph Müller-Bloch	Jan Pawlowski	Oliver Thomas	Ute Paukstadt
Christoph Rosenkranz	Jan Verelst	Onur Demirörs	Vedran Podobnik
Christoph Schneider	Jannis Beese	Paidi O'Raghallaigh	Veeresh Babu Thummadi
Christopher Jud	Jennifer Chandler	Patrick Delfmann	Verena Wolf
Christopher Yang	Jeremias Perez	Paul Ralph	Victoria Yoon
Chun Ouyang	Jerrel Leung	Peter Fettke	Vijay K Vaishanvi
Clare Thornley	Jiexun Jason	Peter Sommerauer	Vivian Sultan
Claudio Di Ciccio	Jim Kenneally	Peyman Toreini	Volker Nissen
Codrina Lauth	Jing Leon Zhao	Philip Hake	William L. Jr. Kuechler
Cristina Cabanillas	Jinsoo Park	Philipp Brune	William Robinson
Danny Poo	Joakim Lillieskold	Philipp Melzer	Yan Li
Dave Darcy	Johannes Schneider	Philipp Rouast	Yun Wang
David Cornforth	Johannes Starlinger	Phillip Haake	Zhongjie Wang
David P. Darcy	Jonas Sjöström	Pontus Johnson	
Debashis Saha	Joseph Walls	Qing Li	
Debra Vandermeer	Juhani Iivari	Radu Vlas	
Denis Dennehy	Juho Lindman	Raj Sharman	
Derek Nazareth	Julie Kendall	Rajiv Kishore	
Devi Bhattacharya	Karl Werder	Ralf Knackstedt	
Dietmar Nedbal	Karthikeyan Umapathy	Ralf Reussner	
Dimitris Karagiannis	Kaushik Dutta	Ramesh Venkataraman	

Table of Contents

DSR in Business Process Management

Domain Design Principles for Managing Complexity in Conceptual Modeling.....	1
<i>Carson Woo, Veda Storey and Mala Kaul</i>	
A Sequence Analytics Approach for Detecting Handoff Patterns in Workflows: An Exploratory Case Study on the Volvo IT Incident Management Process?	11
<i>Akhil Kumar and Veeresh Thummadi</i>	

DSR in Human Computer Interaction

CatCare: Designing a serious game to foster hand hygiene compliance in health care facilities.....	20
<i>Kai Klinker, Veronika Fries, Manuel Wiesche and Helmut Krcmar</i>	
Feedback, Affect, and Mediated Communication: Towards an Explanatory Design Theory	29
<i>Katharina Jahn, Bastian Kordyaka, Oliver Heger, Henrik Kampling and Bjoern Niehaves</i>	
stressOUT: Design, Implementation and Evaluation of a Mouse-based Stress Management Service	37
<i>Tobias Kowatsch, Fabian Wahle and Andreas Filler</i>	

DSR in Data Science & Business Analytics

An Assistance System for Business Information Visualization.....	46
<i>Michael Schelkle</i>	
An End-to-End Process Model for Supervised Machine Learning: From Problem to Deployment in Information Systems.....	55
<i>Robin Hirt, Niklas Kühl and Gerhard Satzger</i>	
Designing Attention-aware Business Intelligence and Analytics Dashboards.....	64
<i>Peyman Toreini and Stefan Morana</i>	
Towards a Reference Model for Data Management in the Digital Economy	73
<i>Tobias Pentek, Christine Legner and Boris Otto</i>	

DSR in Service Science

Design Science Research for Holistic Climate Services.....	83
<i>Jaakko Helminen and Erkki Sutinen</i>	
Users' time preference based stochastic resource allocation in cloud spot market: Cloud provider's perspective.....	92
<i>Anik Mukherjee, Sundarraj Rangaraja and Kaushik Dutta</i>	
Towards Comparable Business Model Concepts: A Resource Description Framework (RDF) Schema for Semantic Business Model Representations	101
<i>Nicola Terrenghi, Johannes Schwarz and Christine Legner</i>	

Methodological Contributions

Action Design Research as a Method-in-Use: Problems and Opportunities.....	110
<i>Amir Haj-Bolouri, Sandeep Puro, Lennarth Bernhardsson and Matti Rossi</i>	
Positioning Living Labs within Action Design Research: Preliminary Findings from a Systematic Literature Review.....	119
<i>Giovanni Maccani, Shane McLoughlin, David Prendergast and Brian Donnellan</i>	

Domain-specific DSR Applications

Evaluating a Mobile Crisis Response System for the Management of Disaster Volunteers	129
<i>Florian Sobiegalla, Oliver Posegga and Kai Fischbach</i>	
If You Want Your Research Done Right, Do You Have to Do It All Yourself? Developing Design Principles for Systematic Literature Search Systems.....	138
<i>Benjamin Sturm and Ali Sunyaev</i>	
Representing Business Models in Primarily Physical Industries: An Ecosystem Perspective	147
<i>Nicola Terrenghi, Johannes Schwarz and Christine Legner</i>	

Emerging Themes and New Ideas

Enhancing Collaboration through Idea-level Granularity: from Information Sharing Across Security Levels to Collaborative Learning.....	155
<i>John Nosek</i>	
The Paradigm of Design Science Research: A Tool-Supported Literature Review.....	164
<i>Alexander Hervix and Christoph Rosenkranz</i>	
Where is the Crowd?	173
<i>Stephen Warren, Rob Gleasure, Philip O'Reilly, Joseph Feller, Shanping Li and Jerry Cristoforo</i>	
Tension in Design Principle Formulation and Reuse	181
<i>Leona Chandra Kruse and Stefan Seidel</i>	

Domain Design Principles for Managing Complexity in Conceptual Modeling

Research in Progress

Mala Kaul¹, Veda C. Storey², and Carson Woo³

¹Department of Information Systems, College of Business, University of Nevada,
University of Nevada, Reno, 1664 N. Virginia Street, Reno, NV 89557, USA.
mkaul@unr.edu

²Department of Computer Information Systems, J. Mack Robinson College of Business
Georgia State University, Box 4015 Atlanta, GA 30302, USA.
vstorey@gsu.edu

³Sauder School of Business, University of British Columbia,
2053 Main Mall Vancouver, BC V6T 1Z2, Canada.
carson.woo@sauder.ubc.ca

Abstract. Complexity is a problem that can be found in many aspects of research that deals with design. In particular, complexity is found in various business processes that must be modeled and represented in a meaningful way. One of the ways to address complexity is by using decomposition, for which a number of decomposition principles have been proposed. However, there are two domain specific areas in which these principles are lacking: the scope and the context of the problem. This research addresses this problem by deriving two new principles for managing complexity, and evaluates the proposed principles through an example case to illustrate their potential use.

Keywords: Complexity · Design · Scope · Context, Conceptual modeling · Business process management · Decomposition principles · Domain design principles

1 Introduction

In today's business environment, designers and developers must cope with the complexity that is inherent in the processes they model, which requires the application of effective design rules at the conceptual modeling phase of systems analysis. Although there have been ideas and principles proposed to deal with complexity, there are still some aspects that remain challenging. The objectives of this research are to: define complexity with respect to conceptual modeling for business process management; examine existing design principles to identify where these design principles are lacking; and propose new design principles and demonstrate their potential effectiveness.

Motivated by real world problems in business process management, this research builds upon existing design principles from decomposition rules. Thus, this research

contributes to decomposition by identifying two new principles, scope and context. These principles are derived based on notions of decomposition from Simon's [29] inner/outer environment and Alter's [1] work system framework. Application of the proposed scope and context principles is intended to address the issue of complexity in conceptual modeling.

The rest of the paper proceeds as follows. It first defines complexity in terms of prior work on conceptual modeling and design science research. Then, existing principles are analyzed, and two new ones, scope and context, are derived. These principles are then applied to an existing problem to show their potential usefulness and value for teaching conceptual modeling, as well as for professional designers. We conclude with a summary and suggestions for future work.

2 Related Research

2.1 Complexity

The concept of complexity is inherently problematic since it arises from the interaction of a number of closely linked (sub)systems, which may have emergent properties which are distinctly different from the sum of the properties of the individual subsystems [29]. Within the context of information systems, complexity is a problem that is found in many different types of problems that deal with design [6, 11, 36]. Although a number of different methods have been proposed to explain complexity, such as, complexity theory [13], chaos theory [7], complex adaptive systems theory [11], dissipative structure [25] and living system theory [15], or to compute complexity, e.g. system dynamics [30], agent based modeling [8], none of these approaches directly provides a method to resolve information systems design complexity.

According to [22], "Complexity is the way the world is; systems thinking and rigorous design methodologies are the key to success". Design science research has a tradition of being especially suited for solving complex or "wicked" problems [28] while being engaged in knowledge production [2, 31]. Although the notion of complexity is well recognized in the design science research literature, it is mostly submerged in the intractable nature of the problem and the complexity of the information systems environment, with greater focus on resolving these intractable problems through the generation of novel artifacts [12, 16, 19].

2.2 Conceptual Modeling

One way to address complexity in designing novel solutions is simplification. [23], suggest that to capture the complexity of the problem so that the artifact appropriately addresses the problem requirements, it may be helpful to atomize or decompose the problem conceptually. [17] suggests that decomposability is a way to uncover simple answers to complex problems and lead to elegant, simple designs. Therefore, having a good understanding of the problem is key to a successful design. Conceptual models help provide a good representation of the real world problem scenarios. A good con-

ceptual model provides a means of communication and common understanding between system analysts, designers as well as the system's users [18]. Thus, conceptual models are the elements of a design science process which aims at solving real world problem situations. Not only do they help in representing the real world, they also help provide this representation at an appropriate level for a given situation; i.e. the level of detail provides adequate information, but is abstract enough to make sense of, without redundancy or complexity. This requires: 1) the right level of abstraction and 2) a syntactical diagram [21].

2.3 Existing Decomposition Principles

The Bunge-Wand-Weber (BWW) models [32-35] that originally drew on Bunge's ontology [3, 4], provides a formal approach to modeling information systems for practical application. [34] good decomposition model provides a way to address the complexity of a real world system by providing a method to represent it in such a way that users can achieve a better understanding of a system. According to Wand & Weber, there is one high-level object that should be decomposed into a set of sub-systems based upon some rules that guide as to what should/should not be included and also to what degree the system should be decomposed (and when to terminate this decomposition). Based upon the evaluation of the BWW model, five principles have been defined for good decomposition, thereby leading to effective management of complexity in systems design. These good decomposition principles [34] can be summarized as follows:

Minimality – the characteristic of a system with state variables where each sub-system, at every level of the decomposition, has no redundant state variables.

Determinism – the characteristic of a system where, for each of the subsystems with a certain level of the decomposition, an event is either an external event or a well-defined internal event.

Losslessness – the characteristic of a system where the decomposition into subsystems, results in the preservation of each hereditary or emergent state variable.

Minimal coupling – this characteristic of a system results when any environmental change has the least amount of impact on any of the subsystems in the decomposition.

Strong cohesion – the characteristic of the output variables being cohesive if they depend on a common input variable and if any additions to the output variables do not necessitate additional input variables.

3 Domain Design Principles: Scope and Cotext

3.1 Limitations of Existing Decomposition Principles

The BWW model has been richly examined, evaluated and applied [5, 10, 26, 27]. Although the BWW ontology is well established, work is still required to understand how processes and process-oriented systems can be decomposed [27] with a lack of generally accepted criteria for assessing the goodness of decomposed process models [14]. Practically, decomposition and conceptual modeling are well established methods

employed in systems analysis, for mapping business problems and processes. Conceptual modeling (e.g., drawing a data flow diagram) can be considered as decomposing a system.

In this context, we can use the minimality, determinism, losslessness, and minimum coupling principles. Nevertheless, strong cohesion might not be necessary at the top level diagram as this principle can potentially result in too many details at that level, but should be enforced in lower level diagrams. For example, based on [20], people have been using 7 ± 2 processes in level 0 data flow diagrams (DFDs). Enforcing strong cohesion at level 0 might result in significantly more processes at level 0 DFD, which is not recommended.

The five decomposition principles assume the existence of a system to be decomposed. In reality, during conceptual modeling, the scope of the system is not necessarily known. This is observed, for example, in problems that occur with student modeling exercises. For example, in analyzing a warehouse, assume that many customers complain about the long delay in getting their items. If the root of the problem is delivery, then drivers should be included in the analysis scope; if the root cause is locating the items, then drivers will not be included in the analysis scope, but the scope should include how items are being stored. Similarly, after identifying the root problem, the solution to the problem could be different. For example, if the problem is delivery, but drivers are already doing their best, the solution might be to provide customers a better estimation of arrival date/time. Thus, the initial customer interactions must be included in the scope of the analysis. Scope identification is an important practical issue in systems analysis [1, pp. 33-34], but is not addressed in existing decomposition principles.

Similarly, the five decomposition principles do not consider a major objective of conceptual modeling, which is for the purpose of understanding and communication [21]. The understanding and communication can be among management, users, analysts, and developers. Using the warehouse example as above, when describing the steps of the warehouse operations, two students capture different steps:

1. Check customer authority, check warehouse items, check items, arrange transportation, delivery, arrange pick-up, and process document.
2. Check authority, pass request, process request, arrange transportation, and receive order for transport.

Common challenges are: i. How many steps, and ii. What steps, are needed? The above examples are 6-7 steps, yet they convey a different picture of the warehouse operation. Knowing what to represent for the purpose of understanding and communication, is a practical issue, but not addressed in the existing decomposition principles.

3.2 The Two Domain Principles

There are two domain specific limitations in the deployment of these five principles for achieving good decomposition. This leads to the proposal of two new principles to supplement the existing five principles, which we call the scope and context principles.

None of the five decomposition principles can guide scope determination as shown in the above examples. Since scoping is very much an issue in systems analysis, we utilize one of them to derive the scope principle. Based on Alter's [1] work system framework, a work system should be the smallest unit in which the problems or opportunities occur, we propose:

Scope principle: A conceptual model should be the smallest system, in which the problems or opportunities occur.

Similarly, the five decomposition principles do not guide the identification of subsystems (e.g., a process in a data flow diagram) for the purpose of understanding and communication. To resolve this issue, we turn to Simon's [29] decomposability in the context of the inner and outer environment, where his strategy is to hide the details of the inner environment so one can study the outer environment without having to know much about the inner environment. Considering the outer environment as a purpose of understanding and communication, Simon's strategy will be applicable here with the inner environment containing the subsystems. This implies that subsystems should be designed so that we do not need to know much about them, but they are sufficient for us to study the outer environment.

Using Simon's inner/outer environments terminology, the determinism principle captures the inner environment of a decomposed subsystem, but does not provide guidance to the outer environment, which is the interaction of the subsystems. Interactions of subsystems are guided by the minimum coupling principle. A data flow diagram (DFD), for example, with straight-forward linear steps of transforming data (i.e., each process has only one data flowing in and one data flowing out) can fulfill minimum coupling, but provides no guidance as to what constitutes a good set of processes to be used at the top level diagram. Thus, we propose the following principle.

Context principle: A conceptual model should contain the smallest number of subsystems (with a minimal knowledge of each subsystem) and their interactions so that it is sufficient to be used for the purpose of understanding and communication.

4 Application of the Domain Principles

An important part of design science research is to demonstrate the applicability and utility of the model [9, 12, 24]. To assess the validity and utility of the two proposed principles, we apply the principles to an example case that was given as a student assignment in a large North West university as a proof-of-concept. Our findings indicate that these principles can delineate diagrams that communicate more with less. See Appendix 1 for the assignment and Appendix 2 for 2 sample DFDs. For the purpose of this discussion, the DFD processes are listed below, because they are considered subsystems in the DFDs.

<p><u>Example 1 DFD processes:</u> Check stock availability Process payment</p>	<p><u>Example 2 DFD processes:</u> Assist customer Place shoes on hold</p>
--	---

Update inventory	Process sales transaction
Process return	<i>Sign up member</i>
Produce restock request	Create receipt
Submit request	Return shoes
<i>Generate sales report</i>	Restock inventory

Both example solutions conform to the 5 decomposition principles. Nothing in the processes is redundant, thus conforming to the minimality principle. The solutions conform to the determinism principle because they have a deterministic reaction to each data flowing in each process. The suggestion of a strong verb to name each DFD process usually addresses this principle. Losslessness is already taken care in the DFD rule: each child diagram should have the same input and output data flow as the parent process. Similarly, weak coupling or minimum coupling is already taken care in the DFD rule that all data flows should be named. This minimizes the unnecessary interactions among processes. Since each process in both diagrams only has one input data flow or one output data flow except when the process accesses a data store, this conforms to the strong cohesion principles because all output depends on all input data flows. Nevertheless, the above two examples violate at least one of the two new principles.

In both examples, the DFDs fulfill the rule of 7 ± 2 processes at the top level DFD. Clearly, they convey two different stories although they are the same assignment. Example 1 did not include “signing up member”, while Example 2 did not include “generating sales report”. One can argue that “signing up member” occurs when processing payment and thus is part of “process payment” in Example 1. It can also be argued that “generating sales report” is beyond the scope of this DFD, thus not included in Example 2. Hence, new principles are needed. According to the scope principle, if the problem to be addressed in this DFD is to increase sales, then “generate sales report” should be within the scope of this DFD. However, if the problem is to improve customer shopping experience, then “generate sales report” can be outside the scope of this DFD. Thus, pinpointing the problem or opportunity is important in determining the scope of DFDs.

According to the context principle, we should not need to know the details of a process, to understand and communicate DFD at that level. If signing up a member is important for improving sales or providing a better customer experience, then this should not be hidden inside the process payment process in the Example 1 DFD. On the other hand, submit request receives its data flow from produce restock request. It does not seem necessary to know whether a restock request is being submitted at this top level DFD as we assume that someone analyzing restocking requirements, will do something about it. Therefore, according to the context principle, Example 1 DFD should combine restock request and submit request into one process. Similarly, create receipt should be part of process sales transaction in Example 2. More importantly, according to the context principle, Example 2 conveyed a better understanding of how the shoe store works as it provided signing up member and placing a hold on shoes services (not seen in Example 1 DFD). Interestingly, Example 2 received a lower grade from the grader than Example 1. This shows that traditional rules for drawing DFDs did not consider the main purpose of conceptual modeling, which is for understanding and communication.

5 Conclusion

Conceptual modeling has always been difficult because of the challenges in modeling the real world in a manner that can be understood. Although a number of techniques and approaches have been proposed for conceptual modeling, challenges remain for how to develop “good” and accurate models that facilitate understanding and communication. A well-recognized challenge in doing so is dealing with complexity. This research has analyzed existing decomposition approaches for complexity and proposed two new principles: scope and context, both of which are derived from the literature on design science. The utility of the principles was demonstrated through an application to a DFD exercise. Further research will require empirical studies (e.g. as those carried out by [5]) that use the principles and assess their value.

Appendix 1: The Shoe Store Case for the DFD Assignment.

Kits Footwear is a Canadian shoe retailer based in Vancouver. The company has seven stores and two warehouses across Canada. Each store is run by a store manager; the retail manager supervises all the seven store managers. Depending on the size of each store, between 4-6 sales associates and 2-3 cashiers are employed by the store manager. When a customer enters a Kits Footwear store, the sales associates welcome the customers, explain the existing promotions and discounts, and answer their questions. When a customer decides to try a pair of shoes, the sales associate asks the customer his/her shoe size and check the store stock availability. If the shoes are in stock, the sales associate brings them to the customer to try on. If not, the sales associate suggests the customer pick other styles, or if the customer prefers, the sales associate contacts other Kits Footwear branches to check for availability. If another branch has the right size in stock, the sales associate places a hold request and asks the customer to visit the other branch within 24 hours. After the customer decides to purchase a pair of shoes, the sales associate escorts him/her to the cashier. The cashier asks if the customer has any coupons or Kits Footwear membership card. Seniors and students with proper identification are also eligible for extra discounts. If the customer would like to apply for a membership card or renew it, the cashier proceeds with the request. Finally, the cashier collects the payment in cash or by credit/debit card, files the sales receipt, and gives a copy of it to the customer.

Kits Footwear has the return policy for unused items within 30 days of purchase. When a customer visits the cashier to return an item, the cashier should call the store manager, who has the authority to process the return requests. The store manager asks for the return reasons, and if the product is eligible for return, confirms the refund. The cashier completes the refund transaction, requests the customer to sign the return form, and gives a copy of the new receipt to the customer. The store manager is responsible for managing the business performance of the store. The retail manager meets weekly with all the seven store managers to analyze sales in the last week and set new sales goals. If the marketing department has created new promotions or discounts, the retail manager passes on this information to the store managers. Each store manager then uses

the sales goals to schedule the store personnel and define daily goals for the sales associates. Finally, the store manager should maintain an appropriate stock level of products in the store and reorder products if necessary. Weekly, she provides a list of required items and submits the list to the retail manager. After the retail manager confirms the reorder, the store manager sends a request to the closer warehouse. When the ordered items arrive, the sales associates refill the store stock.

Appendix 2: Two sample DFDs .

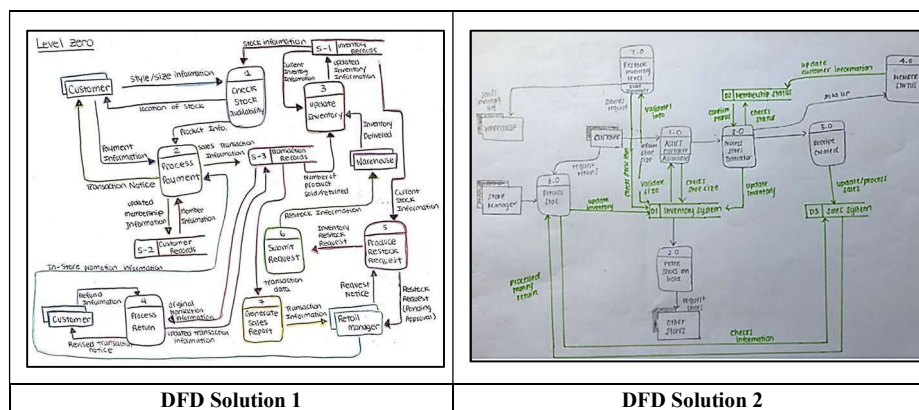

References

1. Alter, S. 2006. The Work System Method: Connecting People, Processes, and IT for Business Results. Larkspur, CA: Work System Press.
2. Baskerville, R.L., Kaul, M., and Storey, V.C. 2015. "Genres of Inquiry in Design-Science Research: Justification and Evaluation of Knowledge Production," *Mis Quarterly* (39:3), pp. 541-564.
3. Bunge, M.A. 1977. "Treatise on Basic Philosophy: Ontology I: The Furniture of the World. Dordrecht, Holland: D." Reidel Publishing Company.
4. Bunge, M.A. 1979. "Treatise on Basic Philosophy: Ontology II: A World of Systems. Dordrecht, Holland: D." Reidel Publishing Company.
5. Burton-Jones, A., and Meso, P.N. 2006. "Conceptualizing Systems for Understanding: An Empirical Test of Decomposition Principles in Object-Oriented Analysis," *Information Systems Research* (17:1), pp. 38-60.
6. Dakin, G. 1993. "Shaping the Future: Business Design through Information Technology," *Journal of the Operational Research Society* (43:9), pp. 1249-1250.
7. Dervin, B. 1999. "Chaos, Order and Sense-Making: A Proposed Theory for Information Design," *Information Design*, pp. 35-57.
8. Druckenmiller, D.A., and Acar, W. 2009. "An Agent-Based Collaborative Approach to Graphing Causal Maps for Situation Formulation," *Journal of the Association for Information Systems* (10:3), p. 221.
9. Gill, T.G., and Hevner, A.R. 2013. "A Fitness-Utility Model for Design Science Research," *ACM Transactions on Management Information Systems (TMIS)* (4:2), p. 5.

10. Green, P., and Rosemann, M. 2000. "Integrated Process Modeling: An Ontological Evaluation," *Information systems* (25:2), pp. 73-87.
11. Hanseth, O., and Lyytinen, K. 2010. "Design Theory for Dynamic Complexity in Information Infrastructures: The Case of Building Internet," *Journal of Information Technology* (25:1), pp. 1-19.
12. Hevner, A.R., March, S.T., Park, J., and Ram, S. 2004. "Design Science in Information Systems Research," *MIS Quarterly* (28:1), Mar 2004, pp. 75-105.
13. Jacucci, E., Hanseth, O., Lyytinen, K., Benbya, H., and McKelvey, B. 2006. "Toward a Complexity Theory of Information Systems Development," *Information Technology & People* (19:1), pp. 12-34.
14. Johannsen, F., and Leist, S. 2012. "Wand and Weber's Decomposition Model in the Context of Business Process Modeling," *Business & Information Systems Engineering* (4:5), p. 271.
15. Knoll, K., and Jarvenpaa, S.L. 1994. "Information Technology Alignment or "Fit" in Highly Turbulent Environments: The Concept of Flexibility," *Proceedings of the 1994 computer personnel research conference on Reinventing IS: managing information technology in changing organizations: managing information technology in changing organizations: ACM*, pp. 1-14.
16. Kuechler, B., and Vaishnavi, V. 2008. "On Theory Development in Design Science Research: Anatomy of a Research Project," *European Journal of Information Systems* (17:5), pp. 489-504.
17. Lewis, K. 2012. "Making Sense of Elegant Complexity in Design," *Journal of Mechanical Design* (134:12), p. 120801.
18. Maes, A., and Poels, G. 2007. "Evaluating Quality of Conceptual Modelling Scripts Based on User Perceptions," *Data & Knowledge Engineering* (63:3), pp. 701-724.
19. March, S.T., and Smith, G.F. 1995. "Design and Natural Science Research on Information Technology," *Decision support systems* (15:4), pp. 251-266.
20. Miller, G.A. 1956. "The Magical Number Seven, Plus or Minus Two: Some Limits on Our Capacity for Processing Information," *Psychological review* (63:2), p. 81.
21. Mylopoulos, J. 1992. "Conceptual Modeling and Telos. Conceptual Modeling, Databases, and Case. An Integrated View of Information Systems. P. Loucopoulos and R. Zicari." *John Wiley & Sons*.
22. Norman, D.A. 2010. *Living with Complexity*. MIT press.
23. Peffers, K., Tuunanen, T., Rothenberger, M.A., and Chatterjee, S. 2007. "A Design Science Research Methodology for Information Systems Research," *Journal of Management Information Systems* (24:3), pp. 45-77.
24. Pries-Heje, J., Baskerville, R., and Venable, J. 2008. "Strategies for Design Science Research Evaluation," *ECIS 2008 proceedings*, pp. 1-12.
25. Prigogine, I. 1967. "Introduction to Thermodynamics of Irreversible Processes," *New York: Interscience*, 1967, 3rd ed.).
26. Recker, J.C., Indulska, M., Rosemann, M., and Green, P. 2005. "Do Process Modelling Techniques Get Better? A Comparative Ontological Analysis of Bpmn,").
27. Recker, J.C., Rosemann, M., Indulska, M., and Green, P. 2009. "Business Process Modeling-a Comparative Analysis," *Journal of the Association for Information Systems* (10:4), p. 1.
28. Rittel, H.W., and Webber, M.M. 1973. "Dilemmas in a General Theory of Planning," *Policy sciences* (4:2), pp. 155-169.
29. Simon, H.A. 1969. *The Sciences of the Artificial*. Cambridge, MA: MIT Press.
30. Serman, J. 2000. *Business Dynamics: Systems Thinking and Modeling for a Complex World*. Boston: Irwin/McGraw-Hill.

31. Van Aken, J.E. 2005. "Management Research as a Design Science: Articulating the Research Products of Mode 2 Knowledge Production in Management," *British journal of management* (16:1), pp. 19-36.
32. Wand, Y., and Weber, R. 1989. "An Ontological Evaluation of Systems Analysis and Design Methods,").
33. Wand, Y., and Weber, R. 1990. "An Ontological Model of an Information System," *IEEE transactions on software engineering* (16:11), pp. 1282-1292.
34. Wand, Y., and Weber, R. 1993. "On the Ontological Expressiveness of Information Systems Analysis and Design Grammars," *Information Systems Journal* (3:4), pp. 217-237.
35. Wand, Y., and Weber, R. 1995. "On the Deep Structure of Information Systems," *Information Systems Journal* (5:3), pp. 203-223.
36. Zachman, J.A. 1987. "A Framework for Information Systems Architecture," *IBM systems journal* (26:3), pp. 276-292.

A Sequence Analytics Approach for Detecting Handoff Patterns in Workflows: An Exploratory Case Study on the Volvo IT Incident Management Process

Akhil Kumar, B Veeresh Thummadi

Pennsylvania State University, University Park, PA, 16802. USA
{akhilkumar, veereshthummadi}@psu.edu

Abstract. In this study, we analyze the activity logs of fully resolved incident management tickets in the Volvo IT department to understand the handoff patterns i.e., how actors pass work from one to another using a sequence analytic approach (a method for studying activity patterns from event log sequences). A generic actor pattern here describes the sequence in which actors participate in the resolution of an incident. We classify actor handoff patterns as straight, loop and ping-pong. Then we analyze the patterns by frequency and duration to draw insights about how actor patterns affect the incident resolution time. The results are quite surprising. In particular, we find that certain loop and ping-pong patterns outperform straight patterns even though more steps are involved in them. Our results have implications for resource allocation in organizations. They suggest that handoff patterns should be another factor to be considered while allocating work to actors along with position, role, experience, skill, preferences, etc.

Keywords: Workflows · Routines · Handoffs · Sequence analytics · Actor patterns · Pattern variety

1 Introduction

Any business or healthcare process can be viewed as a series of handoffs between task actors (or workers) who perform successive tasks until the process instance is completed. After an actor completes her task she hands off the process instance or case to the next actor. Such behavior is observed in various kinds of application areas ranging from medicine and software development to insurance claim processing. Some handoffs also occur in a *ping-pong pattern* such that an actor A hands off a task to actor B only to have it returned later, either after some work is done or just untouched. This leads to an actor handoff pattern represented by the sequence A-B-A, A-B-C-D-A, etc. Such ping-pong behavior arises from an alternating pattern in which the same actor appears more than once.

Most of the research in the Business Process Management (BPM) and workflow literature has been devoted to the discovery of process models, conformance checking and process enhancement. This research assumes that historical process execution logs of completed process instances are available for analysis. Thus, say, we have a log like:

T1 – T4 – T5
T1 – T3 – T5 – T4
T1 – T2 - T4 – T5
T1 – T2
T1 – T5

By applying a process mining algorithm [18] we may discover a process model that always starts with task T1; next tasks T2 and T3 appear in a choice (or alternative) structure and are followed by a parallel structure of T4 and T5 that can appear in any order. Moreover, it is also possible to skip the T2-T3 or T4 -T5 substructure, but only one skip is allowed not both. The discovery of process models in this manner is useful for it helps us to understand the control flow of a process. The drawback with nearly all process mining approaches though is that when considerable variety is inherently present in a process, capturing it in excruciating detail leads to a model that becomes unreadable. The model becomes overrun with so many connectors and edges to accommodate all the flow paths that it looks like spaghetti. In turn, it becomes very hard to decipher and this diminishes its real value.

Researchers in the area of *organizational routines* define routines as “repetitive, recognizable patterns of interdependent actions, carried out by multiple actors.”[4] They accept that variety exists in real world processes and have developed approaches to quantify routine variation, by posing questions like: Does the process in Unit A have more variety than the one in Unit B?[11] Moreover, researchers in organizational routines ascribe greater agency and tacit knowledge to actors of various tasks in terms of their interpretations of how the task should be done rather than treating actors as fully interchangeable. Their focus is on interdependencies among actions, people and technology in contrast to the control flow, data flow and resource perspectives of BPM.

Our approach is in part inspired by previous work in the context of routines [11,12], but our work fits into the broader area of work distribution and resource allocation in BPM (e.g. [6, 14]). To this end, we conduct a preliminary exploratory study, and pose new questions for understanding handoffs patterns in workflow data. Thus we ask: what are the patterns of interaction among generic actors (as opposed to actions) in a large real log and how can they inform us? A pattern like 1-2-1-3-1 shows the order of involvement of actors 1, 2 and 3 in the completion of a process instance through four handoffs among themselves. In this pattern, one might place multiple interpretations. We can interpret this pattern as actor 1 dividing some work between actors 2 and 3 and finally integrating the two pieces of work for resolving the ticket. Alternatively, this pattern could arise when 2 was unable to complete the work sent by 1 and returned it, thus 1 had to instead turn to 3 to perform it. The first interpretation suggests a productive way of completing a work instance while the second is counter-productive. By examining the patterns in more detail in conjunction with the duration of various instances that conform to that pattern we expect to be able to design better work allocation methods.

Our study was made possible by access to a large log from the incident resolution process at the Volvo automotive company. This data set is public and hence the results can be verified. By correlating the most frequent types of actor sequence patterns in this dataset with the duration for resolving the incident we were able to gain many useful insights about the significance of actor patterns. By analyzing this data, we hope

to address questions like: What are the common actor patterns found in resolving tickets? Are some patterns better than others and why? How does actor pattern variety affect resolution time of the tickets? In this way, we can shed more light on the resource perspective in a business process. This perspective has implications for assignment of resources to a process in an efficient way.

This paper is organized as follows. Section 2 gives some preliminaries about handoffs and sequence analytics. Then, Section 3 describes our log data and the main results of our analysis. Next, Section 4 offers a discussion and mentions some related work. The paper concludes with Section 5.

2 Sequence Analytics

A handoff is a transfer of work from one actor to another. Research in healthcare has shown that communication breakdowns among medical professionals can lead to adverse effects on surgical patients [10]. These breakdowns result from poor handoffs involving verbal communications and ambiguities about responsibilities. There is ample evidence to suggest that the nature of social interactions and interdependencies among participants (or resources) who collaborate on a routine or a process does have an impact on the outcome and performance of the process in terms of quality, failure rate, etc. [7].

Sequence analytics refers to the concept of analyzing the sequences of actions or elements to detect similarities and differences across the sequences [11]. For example, in biology this concept is used to detect evolutionary patterns, rate of mutation and any genetic modifications that occurred in time. This concept was later adopted by sociologists and more recently in information systems to detect socio-material entanglement in work processes [5]. An *action* or *task sequence pattern* is a series of possible orderings of related tasks to complete a process or a workflow. Some examples are:

T1-T2-T3-T4
T1-T3-T4-T1

Similarly, it is possible to also consider actor sequences. An actor sequence would define sequences of specific actors such as: A1-A2-A3-A4, or A3-A2-A4-A1, etc. Each sequence denotes the order in which various actors perform tasks to complete a workflow or routine. In contrast to these two notions, in this paper we are interested in studying actor patterns. By a pattern, we mean an ordering in which *generic actors* perform tasks to complete a workflow or a routine. Thus an actor pattern like 1-2-3-4 means that some actor 1, handed over the work to actor 2 who in turn passed it along to 3 and so on. We call this a *straight pattern*. Another pattern is 1-2-3-1 is a *loop pattern* where the work is returned *at the end* to the same actor who started it. Yet another pattern may be 1-2-1-2-1-3. This is a *ping-pong* pattern since the actors alternate with one another. It is important to note here that 1, 2, 3 are generic placeholders for actors, and not specific names of actors. See Fig. 1 for examples of these patterns.

Our goal is to analyze such generic patterns to determine the kinds of patterns appear most frequently and also to understand if some patterns are better than others in terms of incident resolution times.

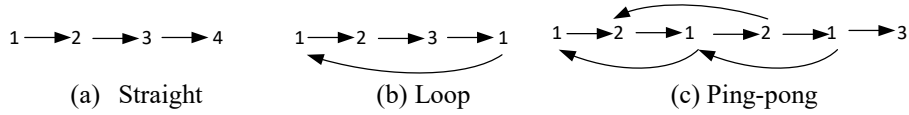

Fig. 1. Different kinds of generic actor patterns

3 A Case study of Volvo IT Incident Management

3.1 Data Set Description and Analysis

This process log data is publicly available and was initially released as a part of the Business Process Intelligence (BPI) Challenge in 2013 [1]. The dataset contains a log of incidents or cases to be resolved. Each incident has a unique serial number. Typically, there are many log records for each incident to reflect any status or owner change. A log record captures the status of the incident and includes information like serial number, date-timestamp, status, sub-status, impact, product, country, owner, support team, and organizational line (see the partial log shown in Table 1). There are 7554 cases or incidents and 65553 events or records in the log for an average of 8.7 log records per incident. The period of this data set extends from the end of March 2010 until middle of May 2012.

Table 1. A snapshot of the incident log

SR Number	Date	Status	Impact	Product	Country	Owner Name
1-364285768	2010-03-31	Accepted	Medium	PROD582	France	Frederic
1-364285768	2010-03-31	Accepted	Medium	PROD582	France	Frederic
1-364285768	2010-03-31	Queued	Medium	PROD582	France	Frederic
1-364285768	2010-04-06	Accepted	Medium	PROD582	France	Anne Claire

The owner attribute in the log record denotes the actual actor who performs a task. When two successive (in time sequence) log records have different owners it indicates a handoff of work from the previous owner to the new one. If two successive records have the same owner, it means that there is a status change and not a handoff. We were only interested in the incidents where at least one handoff occurred.

The dataset was loaded in a MySQL database for the analysis. We first removed the log records for the owner 'Seibel' because this is the information system, and not a human owner. Our focus was on studying the effect of handoffs among human actors only. After all, a resource allocation algorithm can only select a specific human from a set of alternatives. Then we removed all records for incidents where only one human owner was involved and also for incidents that were not resolved. This left us with 4375 incidents - 1755 tickets of low impact, 2413 of medium impact, 204 of high impact and 3 of major impact. Next, we wrote MySQL queries to determine the duration, number of handoffs, number of owners, and handoff pattern for each incident.

Table 2. Incidents by impact level between April 1 and May 15, 2012

Impact level	Number of Incidents
Low	1670
Medium	2204
High	187
Major	3

By plotting resolution time for incidents against time it was observed that resolution times declined with time. This was attributed to a learning curve effect in the initial period that stabilized later on. Moreover, the largest number of incidents were also concentrated in the last part of the dataset, within a short period from April 1 until May 15 of the year 2012. There were 4064 incidents during this period out which the largest number by impact were 2204 medium impact incidents (see Table 2). By concentrating on this period, we were able to eliminate any learning curve effect by removing just a small fraction of the total number of incidents. For our analysis we decided to focus only on the medium and low impact incidents.

Next, we created generic or abstract patterns from the sequences of handoffs for each incident in the log in the following manner. For example, the ticket #1-523391859 has 8 events recorded in the log and contained series of operations in resolving the case. The incident went through multiple hands, 'Elaine-Elaine-Elaine-Elaine-Elaine-Rafael-Rafael-Siebel', before finally getting resolved in Siebel. As we were interested in the abstract handoff patterns among actors, we removed consecutive repetitions with the same owner name (and also owner Siebel) resulting in, 'Elaine-Rafael'. By coding first actor as '1' and second actor as '2' and so on, we were able to generate patterns to convert the sequence of owners' names to numbers 1, 2, 3, These numbers give the order in which an actor appears in the incident resolution process. For each incident we generated the actor pattern along with other information like frequency, average duration, etc. These results are shown in Tables 3 and 4 for medium and low impact incidents, respectively.

3.2 Analysis of Results

Tables 3(a) and (b) show the top 10 most frequent actor patterns that appear in the data set for low and medium impact incidents, respectively. The top 5 actor patterns account for about 70% and the top 10 account for about 80% of the incidents in both tables. The last column of Tables 3(a) and (b) shows the rank by duration time of the various patterns. We have excluded from both tables patterns that had a frequency of less than roughly 1% of the total number of incidents in their category. From these patterns one can easily determine the number of unique owners that took part in resolving the corresponding incident and also the number of handoffs.

Note that 9 out of 10 patterns are common to both tables. Further, the top 3 patterns are identical, and 4 out of the top 5 are common as well. This suggests that similar patterns are used to resolve incidents of both low and medium impact.

Table 3. Top 10 most frequent actor patterns for **Low** and **Medium** Impact Incidents

(a) Low impact tickets				(b) Medium impact tickets			
Actor Pattern	Freq- uency	Average Duration	Rank	Actor Pattern	Freq- uency	Average Duration	Rank
1-2	577	10.2	1	1-2	747	9.3	5
1-2-3	317	10.8	3	1-2-3	492	10.4	6
1-2-3-4	177	14.3	7	1-2-3-4	195	13.8	8
1-2-3-4-5	83	15.0	8	1-2-1	92	9.0	3
1-2-3-4-5-6	48	15.5	9	1-2-3-4-5	90	12.9	7
1-2-3-1	33	10.5	2	1-2-3-1	78	7.6	1
1-2-1	31	10.9	4	1-2-3-4-5-6	35	14.3	9
1-2-3-4-5-6-7	27	17.8	10	1-2-3-4-1	30	8.0	2
1-2-3-2	25	13.0	5	1-2-3-2	19	16.2	10
1-2-3-4-1	19	13.8	6	1-2-3-4-5-1	18	9.2	4

One interesting effect found in Table 3(b) is that a pattern like 1-2 is more frequent than a similar pattern 1-2-1, but the latter takes smaller duration. Similarly, we find that pattern 1-2-3 is more frequent than 1-2-3-1 that has a shorter duration by 27%. We find that many such loop patterns have a shorter duration than their straight pattern counterparts. This raises the question, why does an instance with one additional handoff take a shorter duration than without it? Further investigation showed that in many incidents there was a large lag time between the last two log entries of “Completed-Resolved” and “Completed-Closed”. The last step was performed by the system. In many cases with the straight pattern it increased to 8 days but was lower in the loop pattern. We also examined all 106 incidents for ‘Prod424’ and show the results for the top-10 patterns in Table 4. Notice from the last column for pattern type that only two of the 10 patterns are straight patterns though they account for 80% incidents, while the other patterns for 20% incidents.

Table 4. Top 10 smallest duration actor patterns for **Medium** Impact Incidents for **Prod424**

	Pattern	Frequency	Average Duration	Pattern type
1.	1-2-3-4-2	1	6.0	Ping-pong
2.	1-2	24	6.8	Straight
3.	1-2-1-2-3	1	8.0	Ping-pong
4.	1-2-3-1-2-4-5-6	1	8.0	Ping-pong
5.	1-2-1	5	8.8	Loop
6.	1-2-3-4-5-2-5	1	9.0	Ping-pong
7.	1-2-3-2	1	9.0	Ping-pong
8.	1-2-3-1	2	9.0	Loop
9.	1-2-3-4-2-5-6-1	1	9.0	Ping-pong
10.	1-2-3	26	9.6	Straight

3.3 Understanding Factors that Affect Duration

To gain a better understanding of the factors that affect the duration of an incident, we made an ordinary least regression (OLS) model in R to predict *Duration* using number of owners (*Owners*) and number of handoffs (*Handoffs*) as independent variables. Since

there is a correlation of 0.90 between *Handoffs* and *Owners* we introduced a new variable, $Ping = Handoffs - Owners + 1$. The correlation between *Owners* and *Ping* is 0.55. The results in Fig. 2 show that there is a significant relationship between *Owners* and *Duration* at the 1% level. After trying several models, this model produced better results than models with a single or two variables. More importantly, by trying single variable models with *Owners* and *Handoffs* we found that *Owners* is a better predictor of *Duration* than *Handoffs* with a higher R-squared and coefficient values.

```

Call:
lm(formula = Duration ~ Owners + ping + Owners:ping, data = cdata)
Residuals:
    Min     1Q   Median     3Q      Max
-15.922  -4.968  -1.256   2.839  40.744
Coefficients:
              Estimate Std. Error t value Pr(>|t|)
(Intercept)  6.77316    0.40440  16.749 <2e-16 ***
Owners       1.24127    0.11658  10.647 <2e-16 ***
Ping         0.42191    0.23728   1.778  0.0755 .
Owners:ping -0.04813    0.02889  -1.666  0.0959 .
---
Signif. codes:  0 '***' 0.001 '**' 0.01 '*' 0.05 '.' 0.1 ' ' 1
Residual standard error: 7.794 on 2200 degrees of freedom
Multiple R-squared:  0.07659, Adjusted R-squared:  0.07533
F-statistic: 60.82 on 3 and 2200 DF, p-value: < 2.2e-16

```

Fig. 2. Output of OLS regression

4 Discussion and Related Work

Several interesting initial results emerge from our study. By categorizing the actor patterns into straight, loop and ping-pong, we found that straight patterns are often dominated by loop and ping-pong patterns with the same (or even more) number of owners. The OLS models confirmed that handoffs have a smaller effect on duration.

The superior performance of loop and ping-pong patterns suggests that rather than one actor holding onto an incident, frequent exchanges among actors are better. A second feature of loop, and also ping-pong patterns, is that a single actor may take ownership of the incident and monitor it. This accelerates its progress leading to faster resolution. In fact, the actor who appears more than once may be playing the role of a “coordinator” to facilitate the smooth transfer of work among others. Evidence of this is also found in the work of Liu, et al. [8] who have constructed social network analysis to develop an enhanced organizational model. In their model, various actors play social roles like team leader, coordinator, etc. arguably leading to superior team formations.

Although the loop and ping-pong patterns perform better, yet the straight patterns are predominant. This suggests that for relatively easy incidents straight patterns are perhaps the best. What our results also indicate is that resource allocation algorithms should be designed to take handoff patterns into consideration. In terms of pattern variety, out of 106 cases pertaining to Prod424, there were 32 actor patterns. Among

these, 28 had a frequency of 5 or less (24 patterns only 1). The longest pattern had 18 handoffs and the smallest 1. This illustrates the diversity of patterns that are used to resolve incidents.

Typically, there are many decisive factors that are used to determine what actor would be assigned to perform a task in a process. These include among others the role or position of the actor, experience, skills, etc. These factors should naturally be taken into consideration. There is a large body of work on resource allocation in BPM (see, e.g. [6,14]) that we cannot review for space reasons. However, one part of this work relates to resource assignment languages [2], resource preference models [3], etc. There is also some valuable work in the area of organizational mining that helps to understand resource assignment patterns and relates to how the involvement of resources influences the control flow of a process [9,15,16]. Related work has also looked into affordance networks that combine actors, actions and artifacts [13]. Event interval analysis [17] is also very relevant in the context of actor patterns to understand the nature of handoff intervals.

5 Conclusions

Our work here is complementary to a large body of work already published on human resource allocation in business processes. In this paper we presented an approach for analysis of actor pattern sequences that can help to improve our understanding of the resource perspective of a process and give fresh insights into work design practices. This empirical study was conducted in the context of a rich data set from an incident resolution process. We found that the straight, ping-pong and loop patterns were predominant in the dataset we analyzed and that often the straight pattern was dominated by the other two patterns.

In future work, we would like to examine some other data sets to see if the patterns found here are of a general nature and whether there are other kinds of frequent patterns that are found in them as well. Moreover, it would be nice to study how handoff patterns can be more tightly integrated into resource allocation methods. A resource allocation algorithm should be able to learn to distinguish good handoff patterns from bad ones and then promote those patterns. Finally, it would be helpful to analyze the role of variety of patterns to see whether more variety is conducive or detrimental to better performance.

References

1. BPI Challenge, 2013. <http://www.win.tue.nl/bpi/doku.php?id=2013:challenge>
2. Cabanillas, Cristina, Manuel Resinas, and Antonio Ruiz-Cortés: Defining and analysing resource assignments in business processes with RAL. ICSOC. Springer Berlin Heidelberg (2011)
3. Cabanillas, Cristina, et al.: Priority-based human resource allocation in business processes. International Conference on Service-Oriented Computing. Springer Berlin Heidelberg (2013)
4. Feldman, M.S. and B.T. Pentland: Reconceptualizing Organizational Routines as a Source of Flexibility and Change. *Administrative Science Quarterly*. 48(1): p. 94-121 (2003)

5. Gaskin, J., Berente, N., Lyytinen, K., and Yoo, Y.: Toward Generalizable Sociomaterial Inquiry: A Computational Approach for 'Zooming In & Out' of Sociomaterial Routines. *MIS Quarterly*, 38(3) (2014)
6. A. Kumar, W. M. P. van der Aaslt and E. M. W. Verbeek: Dynamic work distribution in workflow management systems: How to balance quality and performance. *J. Manage. Inf. Syst.* Vol. 18 No. 3 pp. 157-193 Winter 2002.
7. A. Lindberg, N. Berente, J. Gaskin, K. Lyytinen (2016): Coordinating Interdependencies in Online Communities: A Study of an Open Source Software Project. *Information Systems Research*. Published online in *Articles in Advance* (2016)
8. Liu, R., Agarwal, S., Sindhgatta, R. R., Lee, J.: Accelerating collaboration in task assignment using a socially enhanced resource model, *BPM 2013*: 251-258, Springer (2013)
9. Ly, L.T., Rinderle, S., Dadam, P., Reichert, M.: Mining staff assignment rules from event-based data. In: *BPM Workshops*, pp. 177–190 (2006)
10. Mazzocco, K., et al.: Surgical team behaviors and patient outcomes, *The American Journal of Surgery*. 197(5), 678–685 (2009)
11. Pentland, B.T.: Sequential Variety in Work Processes: *Organization Science* 14(5):528-540, 2003
12. Pentland, B.T., T. Haerem, and D.W. Hillison: Using workflow data to explore the structure of an organizational routine. *Organizational routines: Advancing empirical research* (2009)
13. Pentland, Brian, Jan Recker, and George Wyner. A thermometer for interdependence: Exploring patterns of interdependence using networks of affordances, manuscript (2015)
14. N. Russell, A. H. M. ter Hofstede, D. Edmond and W. M. P. van der Aalst. 2005: Workflow data patterns: identification, representation and tool support. In: *Proceedings of the 24th international conference on Conceptual Modeling (ER'05)*, L. Delcambre, C. Kop, H. C. Mayr, J. Mylopoulos and O. Pastor (Eds.). Springer-Verlag, Berlin, Heidelberg, 353-368.
15. Schönig, S., Cabanillas, C., Jablonski, S., Mendling, J.: A framework for efficiently mining the organisational perspective of business processes. *Decision Support Systems* 89: 87-97 (2016)
16. Schönig, S., Cabanillas, C., Di Ciccio, C., Jablonski, S., Mendling, J.: Mining team compositions for collaborative work in business processes. *Software & Systems Modeling*: 1-19. (2015)
17. Suriadi Suriadi, Chun Ouyang, Wil M.P. van der Aalst, and Arthur H.M. ter Hofstede: Event interval analysis. *Decis. Support Syst.* 79, C, 77-98 (2015)
18. Van der Aalst, W.M.P.: *Discovery, Conformance and Enhancement of Business Processes*. Springer, 2016

CatCare: Designing a serious game to foster hand hygiene compliance in health care facilities

Kai Klinker, Veronika Fries, Manuel Wiesche, and Helmut Krcmar

Technical University of Munich, Arcistrasse 21 Munich, Germany

kai.klinker@in.tum.de,

www.winfobase.de

Abstract. Lack of proper hand hygiene is often the source of hospital acquired infections. Despite many efforts, on average, health care workers still perform hand hygiene in less than 50% of the occasions in which they must. Serious games have been used successfully to achieve behavioral change in other health care domains. In order to tackle the complex problem of hand hygiene compliance we followed a design science research approach combining the build-phase with three evaluation cycles. In this paper, we present a preliminary design of a serious game to explore the possibilities of achieving better hand hygiene compliance of health care workers.

Keywords: hand hygiene, Serious Games, Augmented Reality, health care

1 Introduction

Healthcare associated infections (HAIs) are infections for which there is no evidence of presence or incubation at the time of admission. Patients with a HAI need longer to recover and have an increased probability to die. In the European Union alone, the estimated number of HAIs is 4.5 million annually, leading directly to around 37.000 deaths, 16 million extra days of hospital stay and 110.000 indirect deaths [7, 14]. The most effective counteractive measure to HAIs remains proper hand hygiene by health care workers [1]. It is estimated, that 20-30% of HAIs could be prevented by better hand hygiene compliance [7, 14].

The problem of hand hygiene in hospitals is a complex issue with two main aspects: (1) proper training in the cleaning technique and (2) compliance with disinfection procedures [15]. In recent years several applications to improve education of the hand cleaning technique have been implemented and tested in the field [10]. However, since health care workers wash their hands in less than 50% of the appropriate moments [23], the main issue is behavioral. Therefore, it is of interest to explore new approaches of improving health care workers' hand hygiene behavior. Thompson, Debbé, et al. found that theoretically based serious games can be effective at achieving behavioral change in both diet and physical activity [13].

In this paper, we describe the design of a serious game for the Microsoft HoloLens with the purpose of improving hand hygiene compliance. We have built a first prototype of an Augmented Reality application named CatCare. We decided to use Augmented Reality in order to make the users relate their actions and the lesson of the game to the real world and thus have implemented the application on the Microsoft HoloLens. The HoloLens is capable of markerless tracking and therefore does not require a set up procedure before users can play with it. In CatCare, the user needs to take care of sick cats by feeding them. Whenever the user touches a cat, his hands become visibly contaminated and he needs to wash them before touching another cat. If the user fails to do proper hand hygiene, other cats will get infected and the user loses the game. The application is still research in progress. However, three implementation iterations with evaluations have already been conducted. We contribute to the field of serious games and gamification for health care education by presenting design objectives gathered from the scientific literature and learnings that have emerged throughout the development of the application.

2 Research method

In order to design a serious game to educate and motivate health care workers, patients and visitors in health care facilities, our research applies the design science research method (DSRM) [22]. We follow the methodological steps described by Peffers [22] involving the following activities: (1) problem identification and motivation, (2) definition of the objectives for a solution, (3) design and development, (4) demonstration, (5) evaluation and (6) communication. In this article, we apply this methodology as follows: In the introduction section we motivate (1) the problem of hand hygiene compliance and define the central solution objective of the artifact. After reviewing the literature associated with the problem, we derive requirements for the artifact (2). Based on the background literature we develop an artifact iteratively (3). We demonstrate (4) the artifact's evolution and the design knowledge that was gained through iterative testing. The artifact was evaluated (5) in several stages of its evolution via questionnaires and interviews. This article fulfills the purpose of communicating the results (6).

3 Related work

CatCare was implemented with WHO five moments as educational basis. The WHO five moments is a simple conceptual framework for when hand hygiene should be performed is used as the basis for professional medical education [9].

Researchers have drawn upon psychological theory to explain the lack of hand hygiene compliance. Kretzer & Larson [4] found that beliefs, perceived health threat, cues, self-efficacy and attitude influence hand hygiene behavior. In order

to increase health care worker’s perceived threat we used Augmented Reality so the user sees virtual germs on his hands and surroundings.

Kretzer & Larson [4] also found consistent evidence, that self-efficacy is associated with behavioral change and that interventions targeting behavioral change should include the concept of self-efficacy [4]. Self-efficacy can be influenced in various ways. In the past serious games have been used to increase self-efficacy in various health care domains [13, 12, 11], such as diabetes and HIV prevention.

In recent years researchers have started to use gamification and serious games as interventions to improve hand hygiene compliance. Sanchez et al. [8] did a literature review on gamification but only identified four games related to hand hygiene.

Vazquez et al. [16] built a simulation, where users have to decide when and how they must perform hand hygiene. However, their simulation does not simulate a stressful situation as health care professionals experience throughout their daily routine. Marques et al. [18] used a gamification approach in a health care facility. Their system tracks the nurses’ actions and awards points for good hand hygiene behavior but does not focus on facilitating the education of health care workers.

Galluzi et al. and Kutafina et al. [17, 10] focus on teaching proper hand washing technique via gamification but do not teach in which situations hand hygiene is necessary.

3.1 Design objectives based on the literature

The factors that lead to poor hand hygiene compliance of individual health care workers have been researched extensively. Risk factors for hand hygiene compliance include understaffing, bad role models and working in an intensive care unit. Moreover, male health care workers and physicians are more likely to have low hand hygiene adherence (compared to nurses) [1, 7].

Many studies highlight that education is a cornerstone for improvement with handhygiene practices but there are limitations such as financial constraints or lack of teaching experience [1, 7]. Moreover, education has been found to be most effective, when it includes workshops, bedside teaching, and simulation-based training [7]. Therefore, in order to create a simulation that resembles the real world struggle in which health care workers need to do proper hand hygiene while having to treat many patients, we propose that the artifact should simulate a stressful activity that needs to be accomplished, while the user needs to perform proper hand hygiene.

Additionally, the artifact should be easily accessible to health care workers. it should not require prior knowledge, complicated setup procedures or a special infrastructure. Moreover, it should be easy to fit into the time schedule of health care workers. From this reasoning we argue that the artifact should be easily accessible to health care workers.

Furthermore, high-quality and timely feedback on hand hygiene behavior is important to raise the awareness of health care workers [7, 5]. Being caught red handed makes it easier for people to remember their actions that lead to the

mistake. Moreover, if nobody sees the mistake and judges, it might be more likely to achieve a mindshift and behavioral change. Therefore the user should get instant feedback when he does a severe hygiene mistake.

4 Artifact Design

To study hand hygiene compliance in a serious game context, we developed CatCare. Since it was developed iteratively some parts of it have changed over time. We will now briefly describe the latest version (version 3) of CatCare:

Figure 1 shows an overview of the holograms the user sees augmented in to his surroundings while playing CatCare. On the far right of the figure is the sink. The two beds with the sick cats are to the left of the sink. The food bowl is on the counter with the green symbol on the left and the water bowl is on the counter with the blue water drop. There are five cats wandering around on each bed. The cats on one bed have a different disease than the cats on the other bed and need to be held in quarantine from each other. The user can see that the cats are sick by coloured particles radiating around the cats. The cats on the first bed have green particles and the cats on the other bed have red particles. Over time a cat will become thirsty or hungry. The user then needs to pick up the cat and carry it to the food or the water bowl. Once the cat is done with eating or drinking, the user needs to carry it back to its bed. If the cats are not nourished within a certain period of time, they will starve and the game is over. Whenever the user picks up a cat, his virtual hands will get contaminated with the cat's disease. The virtual hand will then also have radiating color particles around it. The user can decontaminate his hands by clicking on the virtual sink. The virtual hands will then instantly become clean again. If the user transmits a disease to a kitten it dies and the game is over. Therefore, in order to win the game, the user needs to make sure the cats get their food in time, while he does proper hand hygiene in order to prevent transmitting a disease. So far, three iterations of the game have been implemented. Each iteration was evaluated using the System Usability Scale (SUS) and open questions for feedback. The first iteration was tested by 39 users and had a SUS of 71.5, the second iteration by 9 users (SUS: 74.1) and the third iteration by 14 users (SUS: 73.9)

Next we will discuss the differences between the three iterations of CatCare, why they were made and what conclusions we derived from them.

5 Discussion

Regarding existing design principles, there is a consensus in the scientific literature on serious gaming and gamification that games need to be fun for the user [21]. However, the use of gamification and serious game design principles in mHealth applications is yet a burgeoning innovations practice [20]. In order to make our application fun to use, we tested different game elements and regularly tested the usability of our application. To make design decisions we relied

on observations, verbal comments from the users, results of the SUS and written comments in the open ended comment section we added to the SUS.

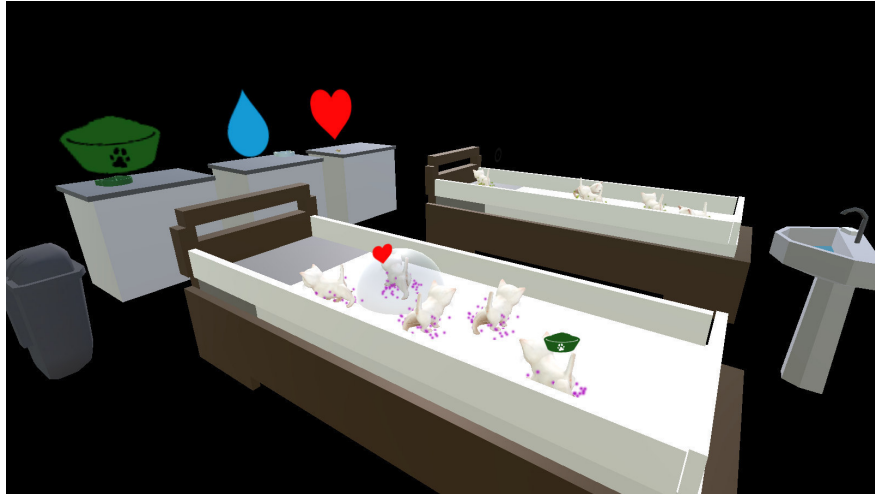

Fig. 1. This figure shows an overview of the holograms the user will see augmented in to his surroundings.

In version 1 we were using a virtual arrow to help the user learn the game. The arrow followed the naive strategy depicted in figure 2 without optimizations. However, during test we soon observed that users were ignoring the arrow and only started using it once we told them to use it. Moreover, they would then just click on whatever the arrow was pointing at without reflecting upon their actions. In version 2 we therefore read them written instructions explaining the setup and the goals of the game without using the arrow. Users then found optimizations to the naive strategy much faster and also seemed much more engaged in the game.

In versions 1 & 2 there was only one level and users often found that the game was not challenging enough. Two users wrote they would have liked "more difficulty, more variation" and "more complexity". Therefore, in version 3 we implemented four different levels so the users could adjust the difficulty to their preferences. Figure 2 shows a flow diagram of the game and table 1 shows an overview of the different levels of CatCare. When we tested the application with users we found that users seemed more engaged and tried out different levels, until they found a level that was appropriately challenging for them.

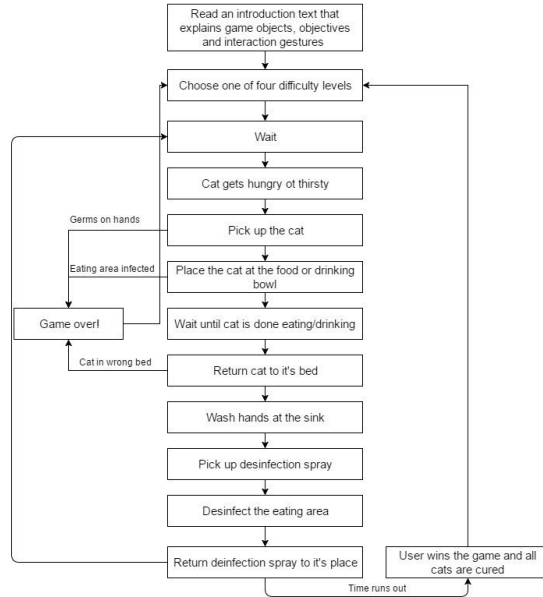

Fig. 2. This figure shows a flowchart of the CatCare application

6 Evaluation

There is no standard for measuring compliance with hand hygiene practices. [19] The three most frequently reported methods of measuring compliance are direct observation of practice, self-report of healthcare workers and indirect calculation based on hand hygiene product usage or electronic monitoring devices [19].

We are planning to evaluate CatCare with health care workers in a health care facility. We will let each health care worker in a ward play CatCare for half an hour following a standardized procedure. The treatment will be repeated every two weeks. Over the course of the intervention and the three succeeding months we will measure the disinfection fluid consumption in the ward and a second ward that we will treat as the control group. Consumption of hand-rub disinfection fluid is an accepted dependant variable of hand hygiene compliance [1].

7 Conclusion and potential contribution

Lack of hand hygiene compliance in health care facilities is a serious problem. Serious games have been used in other health care domains to achieve behavioral change. In this paper, we utilize a design science approach to design, develop and evaluate our serious game artifact. We are developing an Augmented Reality serious game called CatCare that could be used for health care worker's hand

Table 1. Differences between the levels

Level 1 (easy): One cat will randomly get thirsty every 40 seconds and the user has 40 seconds time to give water to the cat before it dies.
Level 2 (medium): Cats can get hungry or thirsty. One cat will randomly get hungry or thirsty every 30 seconds. Cats die if the user does not treat them within 30 seconds
Level 3 (hard): Hunger or thirst will appear every 20 seconds. Cats die if the user does not treat them within 30 seconds
Level 4 (extreme): Hunger or thirst will appear every 15 seconds and the germs become invisible. Cats die if the user does not treat them within 30 seconds

hygiene education. The novelty of our approach lies in the idea to employ a serious game that has parallels to health care workers daily routine. By using Augmented Reality, we enable the users of CatCare to see where germs are and how they are transmitted on to health care worker’s hands. By focusing the user’s attention to tending cats, we simulate the time pressure and stress that health care workers perceive in their everyday life and diverts them from doing proper hand hygiene. Since CatCare provides instant feedback when hand hygiene errors are made, users can test methods for themselves that will help them perform proper hand hygiene under stress.

We have described how we are planning to evaluate the application. If we can show that the application improves hand hygiene behavior of health care workers, the application could be used as a tool in the education of health care workers. Maybe it could also be used in regular intervals to refresh the hand hygiene motivation and knowledge of health care workers. If we can show that people without prior knowledge of hand hygiene can learn hand hygiene from the artifact, it could be used to make hospital visitors aware of HAIs.

Our work contributes to the literature on hand hygiene compliance by exploring a new design-oriented intervention. Finally, we contribute to the field of health care education by presenting design objectives for serious games derived from the scientific literature and learnings from implementing them into an artifact.

Acknowledgments. This research and development project was funded by the German Federal Ministry of Education and Research (BMBF) within the Program Innovations for Tomorrows Production, Services, and Work (02K14A080) and managed by the Project Management Agency Karlsruhe (PTKA). The author is responsible for the contents of this publication.

References

1. Centers for Disease Control and Prevention: Guideline for Hand Hygiene in Health-Care Settings: Recommendations of the Healthcare Infection Control Practices Advisory Committee and the HICPAC/SHEA/APIC/IDSA Hand Hygiene Task Force. *MMWR* 2002;51(No. RR- 16)
2. Gould, Dinah J., et al. Interventions to improve hand hygiene compliance in patient care. *The Cochrane Library* (2010). doi: 10.1002/14651858.CD005186.pub3
3. Pittet, Didier, et al. "Effectiveness of a hospital-wide programme to improve compliance with hand hygiene." *The Lancet* 356.9238 (2000): 1307-1312.
4. Kretzer, Edna K., and Elaine L. Larson. Behavioral interventions to improve infection control practices. *American journal of infection control* 26.3 (1998): 245-253.
5. Edwards, Rachel, et al. Optimisation of infection prevention and control in acute health care by use of behaviour change: a systematic review. *The Lancet infectious diseases* 12.4 (2012): 318-329.
6. Nicol, Paul W., et al. "The power of vivid experience in hand hygiene compliance." *Journal of Hospital Infection* 72.1 (2009): 36-42.
7. Zingg, Walter, et al. "Hospital organisation, management, and structure for prevention of health-care-associated infection: a systematic review and expert consensus." *The Lancet Infectious Diseases* 15.2 (2015): 212-224.
8. Castro-Snchez, Enrique, et al. "Serious electronic games as behavioural change interventions in healthcare-associated infections and infection prevention and control: a scoping review of the literature and future directions." *Antimicrobial Resistance & Infection Control* 5.1 (2016): 34.
9. Sax, Hugo, et al. "My five moments for hand hygiene": a user-centred design approach to understand, train, monitor and report hand hygiene." *Journal of Hospital Infection* 67.1 (2007): 9-21.
10. Kutafina, Ekaterina, et al. "Wearable Sensors for eLearning of Manual Tasks: Using Forearm EMG in Hand Hygiene Training." *Sensors* 16.8 (2016): 1221.
11. Thomas, Rosalind, John Cahill, and Loretta Santilli. "Using an interactive computer game to increase skill and self-efficacy regarding safer sex negotiation: field test results." *Health Education & Behavior* 24.1 (1997): 71-86.
12. Meluso, Angela, et al. "Enhancing 5th graders science content knowledge and self-efficacy through game-based learning." *Computers & Education* 59.2 (2012): 497-504.
13. Thompson, Debbe, et al. "Serious video games for health: How behavioral science guided the development of a serious video game." *Simulation & gaming* 41.4 (2010): 587-606.
14. European Centre for Disease Prevention and Control. *Surveillance of Healthcare-Associated Infections in Europe 2007*; ECDC: Stockholm, Sweden, 2012.
15. Erasmus, V.; Daha, T.J.; Brug, H.; Richardus, J.H.; Behrendt, M.D.; Vos, M.C.; van Beeck, E.F. Systematic Review of Studies on Compliance with Hand Hygiene Guidelines in Hospital Care. *Infect. Control Hosp. Epidemiol.* 2010, 31, 283294.
16. Viquez-Viquez, M., et al. "Hand hygiene training through a serious game: new ways of improving Safe Practices." *Serious Games and Applications for Health (SeGAH)*, 2011 IEEE 1st International Conference on. IEEE, 2011.
17. Galluzzi, Valerie, Ted Herman, and Philip Polgreen. "Hand hygiene duration and technique recognition using wrist-worn sensors." *Proceedings of the 14th International Conference on Information Processing in Sensor Networks*. ACM, 2015.

18. Marques, Rita, et al. "Improving Nurses Hand Hygiene Compliance using Gamification." (2016).
19. Haas, J. P., and E. L. Larson. "Measurement of compliance with hand hygiene." *Journal of Hospital Infection* 66.1 (2007): 6-14.
20. Miller, Aaron S., Joseph A. Cafazzo, and Emily Seto. "A game plan: Gamification design principles in mHealth applications for chronic disease management." *Health informatics journal* 22.2 (2016): 184-193.
21. McConigal, J.: *Besser als die Wirklichkeit!: Warum wir von Computerspielen profitieren und wie sie die Welt verndern.* Heyne Verlag, Mnchen (2012).
22. Peffers, Ken, et al. "A design science research methodology for information systems research." *Journal of management information systems* 24.3 (2007): 45-77.
23. Creedon, S. A. (2005). Healthcare workers' hand decontamination practices: compliance with recommended guidelines. *Journal of advanced nursing*, 51(3), 208-216.

Feedback, Affect, and Mediated Communication: Towards an Explanatory Design Theory

Katharina Jahn¹, Bastian Kordyaka¹, Oliver Heger¹, Henrik Kampling¹ and Bjoern Niehaves¹

¹University of Siegen, Chair of Information Systems, Siegen, Germany
{katharina.jahn, bastian.kordyaka, oliver.heger,
henrik.kampling, bjoern.niehaves}@uni-siegen.de

Abstract. Receiving feedback from colleagues and supervisors via computer-mediated communication (CMC) is part of daily work life and considered to be desirable. Unfortunately, negative feedback in connection with CMC can lead to misunderstandings and negative affect. Against this background, the psychological research field of “perspective-taking” provides options to reduce perceived feedback negativity and, in doing so, to increase the acceptance of negative feedback. With the ability to recognize and reflect human emotions, a new type of technology – so-called “affective technology” – has the potential to provide suitable support for perspective-taking. Aiming at developing an explanatory design theory, we propose a research model by identifying design options for affective technology which lead to perspective-taking in e-mail communication and increased negative feedback acceptance. The research-in-progress paper at hand then outlines the experimental approach planned for testing the presented research model.

Keywords: Affective Technology · Computer-Mediated Communication · Negative Feedback Acceptance · Perspective-Taking · Design Theory · Experiment

1 Introduction

As information and communication technology has become increasingly ubiquitous, computer-mediated communication (CMC) is an integral part of our daily life. Many people communicate online in a broad variety of contexts. Aside from contacting friends, CMC is used for education, health, games, work, and more.

In the work context, feedback – particularly negative feedback – in connection with CMC frequently leads to misunderstandings and negative affect. This might be explained by the fact that emotional expressions and the recognition of emotions lack visual and auditory cues when writing and reading e-mails [4]. As non-verbal emotion expression is faced with many obstacles in e-mails (e.g. emoticons are not only ambiguous, but also regarded as too informal), and verbal emotion expression is less likely communicated [10], the probability for misunderstandings increases. Consequently, feedback via e-mails might get interpreted more neutral or more negatively than intended [4]. Such e-mails may in turn lead to reduced feedback acceptance.

Although research indicates that there is a relationship between disclosing emotions when writing e-mails and reduced misunderstandings [4], to the best of our knowledge, no research exists regarding the question how to increase negative feedback acceptance without there being any need for the sender to actively verbalize or visualize their feelings. Wang et al. [27] have shown that emoticons can reduce negative reactivity even to intentional negative feedback. However, emoticons are often too informal and have to be actively applied by the sender of a message, which requires a certain effort.

Options to reduce perceived feedback negativity and, in doing so, to increase feedback acceptance are provided by the psychological research field of “perspective-taking”. Perspective-taking, as the cognitive dimension of empathy, takes place when an individual (the perspective taker) views a situation from the perspective of another individual (the target) to understand thoughts, feelings or behaviors [6, 7]. In other words, perspective-taking is the process of ‘putting oneself in other shoes’. Research has indicated that being aware of the self and being presented with cues about the perspective of the target can lead to increased perspective-taking [1, 2, 26].

How technology can be designed to increase perspective taking, and in doing so, feedback acceptance, is a question inherent to design science research and explanatory design theories. Specifically, explanatory design theories should show that “a system with feature X will perform better on measure M than a system without feature X” (p. 7) [15].

Our objective is to create a design theory for the design of so-called ‘affective technology’ which, with ability to recognize and reflect human emotions, have the potential to provide suitable support for perspective-taking. In accordance with the definition of affective computing [25], affective technology can be defined as technology which can sense and/or generate human emotions such as happiness, anger, or fear. It is an innovative type of technology that can support people in different areas, for example in car driving [18]. In the context of learning, for instance, an affect-aware system can detect boredom, confusion, frustration, or engagement of the learner based on conversational cues, body language, and facial features and respond adequately to improve the learning experience and to increase the learning effect [8]. In the CMC context, affective technologies could be used to recognize the emotions of both the sender and the receiver, and disclose them to both communication partners. As research has indicated that verbal information about emotions is largely interpreted congruently across individuals [23], the perspective of the communication partner might be accessed more easily, and negative affect due to misunderstandings might be reduced.

Thus, we aim to develop an explanatory design theory, proposing a research model, identifying design options for affective technology which lead to perspective-taking in e-mail communication and increased negative feedback acceptance. The paper is therefore guided by following research questions:

RQ1: *Can affective technology be used to disclose one’s own affective state to increase perspective-taking and feedback acceptance in CMC?*

RQ2: *Can affective technology be used to disclose the other’s affective state to increase perspective-taking and feedback acceptance in CMC?*

2 Related Work

Feedback acceptance is defined as "the recipient's belief that the feedback is an accurate portrayal of his or her performance. Whether or not this belief is itself correct is inconsequential to acceptance" (p. 356) [20]. Feedback acceptance has a diverse set of predictors, including (perceived) characteristics of the feedback provider (e.g. power), characteristics of the recipient (e.g. self-esteem), and characteristics of the feedback (e.g. perceived feedback valence) [20]. With respect to negative feedback – understood as critical comments given to identify areas for improvement [17] – and to emotions, a study of Wang et al. [27] has suggested two predictors that can be influenced by emotion-related stimuli. First, perceived good intention of feedback, is focused on the feedback provider. Second, perceived feedback negativity, is focused on the actual feedback the feedback provider has given. While Wang et al. have argued that the characteristics of the feedback recipient are unlikely to be influenced by means of emoticons, we propose that by having affective technology at hand, characteristics of the recipient, specifically increased perspective-taking, can nonetheless be altered.

Perspective-taking takes place when an individual views a situation from the perspective of another individual [5, 6]. Perspective-taking can be differentiated into a dispositional and situational construct. The dispositional construct refers to the general ability to adopt perspectives of others in various situations [6] whereas the situational construct refers to the degree to which an individual is able to adopt the perspective of another person in a specific situation [7]. In this paper, we focus on the situation-specific aspects of perspective-taking. In the context of feedback, perspective-taking has the potential to reduce aggression after receiving negative feedback [21].

Objective self-awareness and perspective-taking. Research has indicated that being aware of the self can lead to increased perspective-taking [1, 2, 26]. Objective self-awareness theory [9] helps to explain these results: Individuals who are aware of their own existence take a separate perspective from the self. Thus, the individuals see themselves as separate from others – an ability needed for taking the perspective of another person [26]. The influence of self-awareness on perspective-taking could be observed both in the laboratory [26] and in the field [1]. Specifically, in a field experiment, Abbate et al. [1] could demonstrate that perspective-taking is enhanced by showing an individual a mirror (versus a photo of a baby) and, in doing so, to induce self-awareness.

Although other results show that the relationship between self-awareness and perspective taking can be a negative one [12], there is strong experimental support for a moderating variable in the relationship of perspective-taking and self-awareness. When individuals are presented with cues about the perspective of the target (e.g. specific information on the target group), higher self-awareness leads to higher perspective-taking whereas this pattern reverses when no cues are present [1].

3 Hypothesis Development and Design Options

To gain scientific insights with a comprehensible theoretical basis for the design of technology, the “design science paradigm” provides appropriate methods. Within the

design science paradigm, two types of theory have evolved: “design practice theories” and “explanatory design theories” [3, 15, 16, 19, 22, 24]. Whereas the former describes the process of constructing an artifact (how), the latter explains the reasons for constructing an artifact in a specific way (why) [3, 15]. Comparable to structural equation modeling terminology, explanatory design theories consist of an “outer model” and an “inner model” [24]. The outer model comprises design options and measurement items whereas the inner model specifies the relationship between latent design variables and latent dependent variables. Design options can be understood as the characteristics of an artifact. The study at hand pursues the target to empirically propose a starting point to develop an explanatory design theory for the dependent variable perspective taking using two affective technology design features (emotional self-disclosure and emotional cue). Furthermore, aftermath impacts are illustrated utilizing perspective taking as a moderator for negative feedback acceptance making use of a recommended approach [24]. In the course of the section, we derive hypotheses (see Fig. 1).

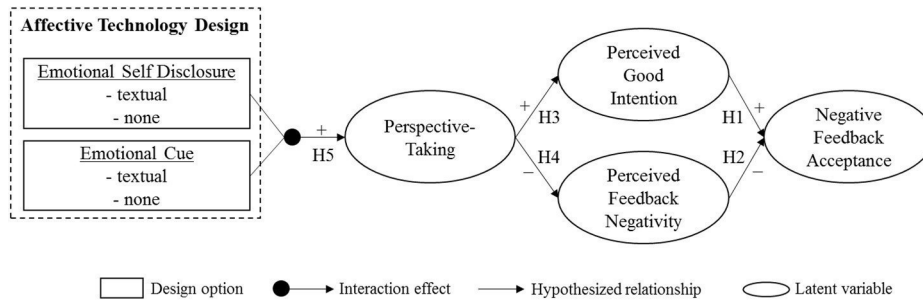

Fig. 1. Explanatory design theory

Perceived good intention of the feedback provider has been indicated to influence feedback acceptance in studies about, for example, leadership [11] and use of emoticons [27]. According to these studies, feedback is more readily accepted when a feedback recipient believes that the feedback provider had honest intentions to help (in contrast to negative intentions such as embarrassment). Thus, we hypothesize:

H1: *Perceived good intention of the feedback provider increases acceptance of negative feedback.*

As negative feedback poses a threat to a desired positive self-image [12], it is more likely rejected to prevent this [27]. As the negative relationship between perceived feedback negativity and feedback acceptance has already been shown by the results of Wang et al. [27], we aim to strengthen these results with our study:

H2: *Perceived negativity of feedback decreases feedback acceptance.*

When negative or ambiguous feedback is given, the feedback recipient has to estimate whether the intentions of the feedback provider were positive or negative [20]. If the recipient tries to understand what the feedback provider was thinking and feeling when they were writing the feedback, deciding that the feedback provider had good intentions might become more likely. This can be assumed because perspective-taking leads to

increased external attributions of behavior, e. g. when observing deviance at the workplace [13]. Thus, negative evaluations of the perspective-taking target are reduced. We therefore assume that perspective-taking is likely to play a relevant role in perceived good intentions of the feedback provider:

H3: *Perspective-taking increases perceived good intentions of feedback provider.*

Perspective taking has been shown to correlate negatively with aggressive reactions after receiving negative feedback [21]. Thus, when perspective-taking is high, perceived feedback negativity should be reduced:

H4: *Perspective-taking decreases perceived feedback negativity.*

Abbate et al. [2] showed that perspective-taking is influenced by an interaction between self-awareness and cues regarding the state of the perspective-taking target. When individuals' looks were disclosed by placing them in front of a mirror (high self-awareness condition) and were given cues about the target (cue condition), they showed higher perspective-taking than when one or both of these conditions were not met. Instead of using a mirror as a form of self-disclosure, we show participants their real-time emotional strain for inducing self-awareness and thus, perspective-taking. Congruently, we cue the emotional strain of the target to participants. Hence, our design-options are shown in Table 1 and we hypothesize the following interaction effect:

H5: *Disclosure of the own emotional state leads to increased perspective-taking when the communication partner's emotional state is cued.*

Table 1. Affective technology-based design options for increasing perspective taking and negative feedback acceptance

	Self-disclosure	Cue
Textual	Real-time assessment of feedback recipient's emotional strain is disclosed textually at the right side of the text insertion field as either low, moderate, or high (e.g.: "low emotional strain").	A text-field displayed at the left side of the messages from the feedback provider states: "high emotional strain".
None	No emotions are textually displayed for feedback recipient.	No emotions are textually displayed for feedback provider.

4 Method

4.1 Design, Participants, and Procedure

Design: To test our hypotheses, we want to conduct a fully randomized 2 (emotional self disclosure: textual vs. none) x 2 (emotional cue: textual vs. none) between-subjects laboratory experiment in a simulated work context.

Participants: We plan to recruit 80 students from our local university. To ensure the motivation of the participants we indicated the chance to win a reward of 25€.

Procedure: After participants receive an explanation about the alleged purpose of the experiment, they, in the self disclosure condition, put on the mood ring and are seated in front of a computer workplace in individual rooms. In the next step, to increase the credibility of the experiment, participants see the following information on the computer screen: “As we want to reward participants who have written the three best essays with 25€, another student will tell you how they evaluated your essay. Afterwards, you will have the opportunity to reply to their evaluation to improve your chances of getting the reward.”

Afterwards, the use of the e-mail program is explained. Participants in the self disclosure and cue conditions receive additional explanation that they can view their own emotions/their communication partner's emotion in the e-mail program. From this point forward, the self disclosure manipulation (recipients' emotional strain) and/or the emotional cue manipulation (feedback providers' high emotional strain) are displayed continuously until the e-mail program closes. The emotional cue manipulation is used as cue for a higher stress level. For participants in the control group (emotional disclosure: none & textual disclosure: none) there is no textual information on the level of their own or the feedback provider's level of emotional strain.

The experiment itself consists of five different phases. First, all participants are asked to write an essay about fake news in social media sites. Additionally, they receive the information that they have ten minutes to complete this task, have to write at least 150 words, and that another student will subsequently evaluate their essay after they have sent it via the e-mail program. After ten minutes, participants have to send their essay to their fictive communication partner. Second, participants are given the information, that their fictive communication partner is evaluating their essay right now and will respond soon. In the meantime, participants complete a questionnaire collecting different variables. Third, participants receive the following e-mail from their fictive communication partner:

“I did not like your essay and think it has a plethora of weaknesses: your arguments are rather weak and your train of thought is hard to understand.”.

Fourth, participants are given five minutes to answer to this e-mail and are told they have the opportunity to improve the chances of winning the 25€ by replying to the feedback. Afterwards, the e-mail program gets closed and participants complete the manipulation checks, and the scales for perspective-taking as well as feedback.

4.2 Measures and Data Analysis

Perspective-taking: We use a perspective-taking scale adapted from Grant & Berry [14]. An example item is "I imagined how my communication partner was feeling".

Feedback measures: Feedback acceptance, perceived good intentions and perceived feedback negativity scales are adapted from Wang et al. [27].

Manipulation checks: We ask participants whether they have seen their own/their partners' level of emotional strain.

Self-awareness and cue manipulation: In the disclosure self manipulation, the participants wear the Moodmetric ring¹ that collects data on electrodermal activity. The design-options are presented to as described in Table 1.

Data analysis: To test the effectiveness of our hypotheses, we aim to make use of different statistical tools. Specifically, we will utilize multiple regression analysis to protect our data from unwanted confounding effects, ANOVAs to see if the experimental groups show different values in the dependent variables more frequently than random, and PLS to test the whole postulated research model.

5 Limitations and Outlook

With the proposed paper, we will contribute to research on feedback as well as design science. Furthermore, we will inform practitioners on how affective technologies can be used and designed in at work to raise the acceptance of computer-mediated negative feedback. However, some limitations have to be noted. First, as we do not assess any neurophysiological measures because they could confound with the manipulation of the self-disclosure design-option, including these measures would be a promising road for future research. Second, we focused on feedback acceptance in the context of perceived good intention and perceived feedback negativity. Future studies could address additional variables such as sender credibility or message formality. In the next step, we plan to recruit participants and conduct the experiment in our laboratory.

Acknowledgements. This article was supported by the projects “INEMAS” (No. 16SV7235) and “ELISE” (No. 16SV7512) funded by a grant of the German Federal Ministry for Education and Research (BMBF).

References

1. Abbate, C.S. et al.: A Field Experiment on Perspective-Taking, Helping, and Self-Awareness. *Basic Appl. Soc. Psychol.* 28, 3, 283–287 (2006).
2. Abbate, C.S. et al.: Self-awareness, perspective-taking, and egocentrism. *Self Identity.* 15, 4, 371–380 (2016).
3. Baskerville, R., Pries-Heje, J.: Explanatory Design Theory. *Bus. Inf. Syst. Eng.* 2, 5, 271–282 (2010).
4. Byron, K.: Carrying Too Heavy a Load? The Communication and Miscommunication of Emotion by Email. *Acad. Manage. Rev.* 33, 2, (2008).
5. Cortina, L.M. et al.: Incivility in the workplace: incidence and impact. *J. Occup. Health Psychol.* 6, 1, 64–80 (2001).
6. Davis, M.H.: A multidimensional approach to individual differences in empathy. (1980).
7. Davis, M.H.: The effects of dispositional empathy on emotional reactions and helping: A multidimensional approach. *J. Pers.* 51, 2, 167–184 (1983).

¹ <http://www.moodmetric.com>

8. D'Mello, S., Graesser, A.: AutoTutor and Affective Autotutor: Learning by Talking with Cognitively and Emotionally Intelligent Computers That Talk Back. *ACM Trans Interact Intell Syst.* 2, 4, 23:1–23:39 (2013).
9. Duval, S., Wicklund, R.A.: *A Theory of Objective Self-Awareness*. Academic Press (1972).
10. Ekman, P. et al.: Facial signs of emotional experience. In: *Emotions in social psychology: Essential readings*. pp. 255–264 Psychology Press, New York, NY, US (2001).
11. Fedor, D.B. et al.: The contributory effects of supervisor intentions on subordinate feedback responses. *Organ. Behav. Hum. Decis. Process.* 44, 3, 396–414 (1989).
12. Fenigstein, A., Abrams, D.: Self-Attention and the Egocentric Assumption of Shared Perspectives. *J. Exp. Soc. Psychol.* 29, 4, (1993).
13. Fiori, M. et al.: Whose Side Are You On? Exploring the Role of Perspective Taking on Third-Party's Reactions to Workplace Deviance. *Basic Appl. Soc. Psychol.* 38, 6, 318–336 (2016).
14. Grant, A.M., Berry, J.W.: The Necessity of Others is the Mother of Invention: Intrinsic and Prosocial Motivations, Perspective Taking, and Creativity. *Acad. Manage. J.* 54, 1, 73–96 (2011).
15. Gregor, S.: Building Theory in the Sciences of the Artificial. In: *Proceedings of the 4th international conference on design science research in information systems and technology*. pp. 1–10 ACM (2009).
16. Gregor, S.: The nature of theory in information systems. *MIS Q.* 611–642 (2006).
17. Hartenian, L.S. et al.: Performance Feedback in a Virtual Team Setting. *J. Behav. Appl. Manag.* 4, 1, (2016).
18. Heger, O. et al.: Towards a Theory of Trust-based Acceptance of Affective Technology. In: *Proceedings of the 24th European Conference on Information Systems*. (2016).
19. Hevner, A.R. et al.: Design Science in Information Systems Research. *MIS Q.* 28, 1, 75–105 (2004).
20. Ilgen, D.R. et al.: Consequences of individual feedback on behavior in organizations. *J. Appl. Psychol.* 64, 4, 349–371 (1979).
21. Jones, C.E.: The effects of dispositional perspective taking, cognitive busyness, and situational information on retaliative aggression: An attributional interpretation. *Doctoral Thesis #2001-95006-310 ProQuest Information & Learning* (2001).
22. Kuechler, W., Vaishnavi, V.: A Framework for Theory Development in Design Science Research: Multiple Perspectives. *J. Assoc. Inf. Syst.* 13, 6, 395–423 (2012).
23. Mossholder, K.W. et al.: Measuring emotion in open-ended survey responses: An application of textual data analysis. *J. Manag.* 21, 2, 335–355 (1995).
24. Niehaves, B., Ortbach, K.: The inner and the outer model in explanatory design theory: the case of designing electronic feedback systems. *Eur. J. Inf. Syst.* 25, 4, 303–316 (2016).
25. Picard, R.W.: The Promise of Affective Computing. In: Calvo, R.A. et al. (eds.) *The Oxford Handbook of Affective Computing*. pp. 11–20 Oxford University Press (2015).
26. Stephenson, B., Wicklund, R.A.: Self-directed attention and taking the other's perspective. *J. Exp. Soc. Psychol.* 19, 1, 58–77 (1983).
27. Wang, W. et al.: Effects of Emoticons on the Acceptance of Negative Feedback in Computer-Mediated Communication. *J. Assoc. Inf. Syst.* 15, 8, 454–483 (2014).

stressOUT: Design, Implementation and Evaluation of a Mouse-based Stress Management Service

Tobias Kowatsch^{1(✉)}, Fabian Wahle² & Andreas Filler^{1,3}

¹ University of St. Gallen, Institute of Technology Management, St.Gallen, Switzerland
{tobias.kowatsch, andreas.filler}@unisg.ch

² ETH Zurich, Department of Management, Technology and Economics, Zurich, Switzerland
fwahle@ethz.ch

³ University of Bamberg, Energy Efficient Systems Group, Bamberg, Germany

Abstract. Work-related stress has the potential to increase the risk of chronic stress, major depression and other non-communicable diseases. Organizational stress monitoring usually applies long-term self-report instruments that are designed in a retrospective manner, and thus, is obtrusive, time-consuming and, most important, fails to detect and predict short-term episodes of stress. To address this shortcoming, we apply design science research with the goal to design, implement and evaluate a stress management service for knowledge workers (stressOUT) that senses the degree of work-related stress solely based on mouse movements. Using stress theory as justificatory knowledge, we implemented stressOUT that tracks mouse movements and perceived stress levels randomly twice a day with the goal to learn features of mouse movements that are related to stress perceptions. Results of a first longitudinal field study indicate that mouse cursor speed is negatively related to perceived stress. Future work is discussed.

Keywords: Stress monitoring · Mouse tracking · Human-computer interaction · Neuromotor noise · Stress theory · Longitudinal observational field study.

1 Introduction

Work has changed over the past decades, resulting in steadily increasing workloads [9]. By 2020, approximately five out of ten health issues worldwide will be stress-related and the workplace will constitute the primary source of stress [4]. In this work, stress is defined as the “psychological and physical state that results when the resources of the individual are not sufficient to cope with the demands and pressures of the situation” [25, p. 67]. It negatively impacts the health condition of employees and thus, also the performance of their organizations. That is, stress has a negative relationship with perceived quality of life, work-related goals, self-esteem or personal development [25, 27].

Detection of work-related stress represents therefore a prerequisite not only to anticipate any negative health effects in the long term but also to offer just-in-time (organizational) health promotion interventions [26]. Beyond organizational and psychological

barriers to directly report stress to colleagues or supervisors [7], there already exist several self-report instruments for measuring individual stress levels [5, 6, 18, 30].

However, applying these instruments has two major limitations: First, stress polls are usually conducted at a low frequency with several weeks or even months in between [33]. The resulting granularity of stress data is low, i.e. short-term episodes of stress with serious negative health outcomes cannot be identified reliably. Second, conducting work-related surveys several times a year, is time-consuming, obtrusive and costly due to data collection, analysis and interpretation activities. The measurement itself affects the performance of employees, too.

Recent findings in the field of human-computer interaction indicate a link between mouse movements and affective states of individuals [14, 17, 29]. It has been even shown a link between mouse movements and stress perceptions [32]. However, shortcomings of current findings are either the artificial mouse tasks employed or that the studies were conducted in a laboratory or experimental [14, 17, 32] or a highly-controlled field setup [17, 29]. Our research aims to address these shortcomings and thus, formulates the following research question: *Which features of mouse movements are related to stress perceptions at the workplace in the field?*

To address this question, we apply design science research [1, 16] with the goal to design, implement and evaluate a stress management service, denoted as stressOUT, that senses knowledge workers' stress solely based on mouse movements. We focus on knowledge workers, i.e. employees that are seen as "the most valuable asset of a 21st-century" [8, p. 79], because they usually use a computer mouse rendering these interactions a mirror of their work. We further adopt stress theory and its neuromotor noise concept [34] as justificatory knowledge to build stressOUT. In this research-in-progress paper, we describe the design and evaluation of a first version of stressOUT. This version does not yet automatically detect work-related stress but does record mouse movements together with subjective perceptions of stress with the goal to identify relevant mouse movement features that are related to these stress perceptions. To motivate employees to use this first and still obtrusive version of stressOUT, i.e. to provide their stress perceptions on a regular basis, the application also visualizes perceived stress over time in the form of a quantified-self diary and provides weekly intervention tips to support employees to better cope with their work-related stress.

The remainder of this work is structured as follows. Next, we present the justificatory knowledge of stressOUT from which concrete design requirements are derived. Then, the stressOUT application is described. With a focus on our research question, i.e. the identification of relevant mouse features, we describe a longitudinal field study and present preliminary findings. We finally discuss the results and provide an outlook on future work.

2 Justificatory Knowledge and Hypothesis

The goal of this section is to outline the theoretical underpinnings of the envisioned stressOUT application. Stress theory, as introduced by van Gemmert and van Galen [34] and adopted by research in human-computer interaction [e.g. 14, 22], is considered

in the current work because it aims at explaining the relationship between work-related stress, variations in the motor system through the concept of neuromotor noise, and human performance. It allows us therefore to theorize about the relationship between an employee’s motor performance as reflected by mouse movements and the degree of work-related stress.

In contrast to organizational stress detection approaches that employ self-report instruments [2], stress theory is derived from neurophysiology [34]. The theory suggests that an imbalance of high job demands and low job resources is reflected by increased information processing demands. These “increased processing demands (e.g. in dual-task situations) lead to increased levels of neuromotor noise and, therefore, to decreased signal-to-noise ratios in the [motor, the author(s)] system.” (ibid., p. 1300) Here, neuromotor noise is a key concept and outcome of stress that is generated by cognitive activities in the brain. In high-demand work situations, neuromotor noise results from a competition of individuals’ information processing resources (ibid.). The resulting decrease of the signal-to-noise ratio has direct effects on the motor system, which can be measured by increased variations of human movements. Against this background, mouse movements have already been shown to be valid proxies of cognitive and affective processing in laboratory settings [14, 23, 36] because they provide “continuous streams of output that can reveal ongoing dynamics of processing, potentially capturing the mind in motion with fine-grained temporal sensitivity.” [12, p. 1]

With respect to these considerations, we assume that mouse movements under work-related stress will still follow a trajectory towards a pre-defined mouse target, for example, a button or a position within a paragraph in a word processing application. However, in the sense of an neuromotor noise overlay, this trajectory will be *overwritten* by micro-movements (“shivering”) and needs to be re-adjusted several times as depicted in Fig. 1. First visual inspections support this assumption (see Fig. 2). Here subjects had to move the mouse pointer several times 600 pixels from the left to the right target.

As neuromotor noise results in a decreased signal-to-noise ratio of the motor system, we assume that mouse cursor speed will naturally decrease in high-stress situations due cognitive load required for these re-adjustments. Therefore, we hypothesize the following relationship with respect to our research question:

Hypothesis: Mouse cursor speed is negatively associated with perceived stress.

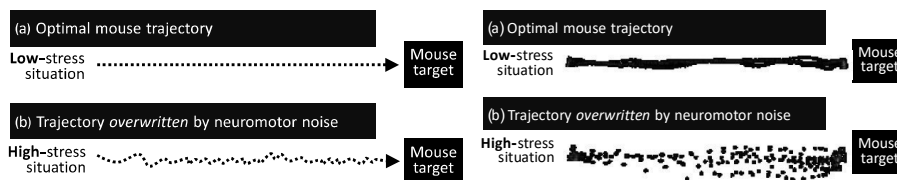

Fig 1. Assumed mouse trajectories in low-stress (a) and high-stress (b) situations

Fig 2. Actual mouse trajectories of one single subject in a low-stress (a) and high-stress (b) situation

3 Design Requirements for stressOUT

To test the hypothesis and to build the envisioned stressOUT service for knowledge workers, the following two design requirements (DR) were defined:

DR1: stressOUT must be able to record mouse movements unobtrusively.

DR2: stressOUT must provide a user interface to record subjective stress levels.

Although these design requirements focus directly on the research question and hypothesis of the current work, they do not provide any utility to knowledge workers per se with the consequence that they are not using stressOUT. Consequently, employees must be motivated in the first place to use stressOUT on a regular basis. Therefore, additional requirements have been identified. For this purpose, we collected feedback from eight knowledge workers (three females) of a business organization who were interested in testing stressOUT in a longitudinal field study. Here, the primary contact was the director of the human resources (HR) department. The following requirements resulted from a three-hour focus group discussion excluding the director of the HR department:

DR3: stressOUT must visualize perceived stress data in the form of a diary to foster an individual's self-reflection capabilities.

DR4: stressOUT must provide an option to share an individual's stress data with colleagues, friends or supervisors. The goal is to encourage a discussion about critical stress events and to better handle them in future situations.

DR5: stressOUT must provide a list of strategies and / or tips to better cope with work-related stress.

DR6: stressOUT must give employees the full control of their data. That is, employees must be able to delete the complete history of their stress recordings without any limitations or negative side effects, e.g. by the HR department or any of their supervisors.

4 Implementation of stressOUT

The stressOUT app is a cross-platform Java program that runs on several operating systems. It is planned as a module for the open source behavioral intervention platform MobileCoach (www.mobile-coach.eu) [10, 15]. A schematic overview of stressOUT is shown in Fig. 3. In line with DR1/2, stressOUT consists of two sensing modules, i.e. one for mouse movements and one for stress perceptions. In particular, mouse coordinates and meta information (e.g. single-click, double click, etc.) are stored together with timestamps in a text file. While previous experimental research used artificial high sampling rates (e.g. 500Hz), special mouse hardware and dedicated software drivers [e.g. 11, 32, 35], stressOUT employs a standard sampling rate of today's operating systems and of-the-shelf computer mouse hardware, i.e. about 125Hz on average.

According to the notion that "stress and emotion should be treated as a single topic" as "emotion encompasses all the phenomena of stress" [21, p. 53], we operationalize perceived stress as an emotional response to a stressor [e.g. 19-21, 25, 31]. Consistent

with prior work [13, 28], we used an adapted version of the Self-Assessment Manikin (SAM) [3] to measure the arousal and valence dimension of emotions several times a day as opposed to instruments designed to measure stress over several weeks such as the Perceived Stress Scale [5]. While arousal is used to measure the intensity of stress, i.e. it was anchored from completely relaxed (1) to fully stressed (7), valence measures whether the emotions are perceived rather negative (1) or positive (7), also known as distress and eustress [24, 31]. We did not include the dominance dimension of SAM because prior research on work-related stress focused on arousal and valence only [24]. Moreover, it has been recently shown that dominance ratings were not related to physiological stress but valence and arousal ratings [28]. A corresponding stressOUT screen is shown in Fig. 4 (all screenshots in this paper were translated into English) and pops up if an employee clicks on a small 120 square-pixel stressOUT icon on the lower right corner of the desktop, which slowly moves the eyes and hands, indicating that it is time to create a new perceived stress record. In accordance with the HR department and standard working hours of the employees of our industry partner, the stressOUT icon appears twice per day at a random point in time, once between 9:00 am and 11:00 am and once between 2:00 pm and 4:00 pm.

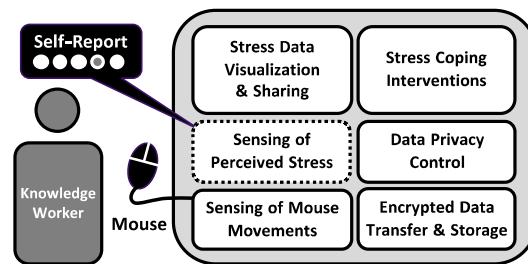

Fig. 3. Schematic overview of stressOUT. Note: The dotted sensing module is required only in the first version of stressOUT, i.e. to identify relevant features of mouse movements

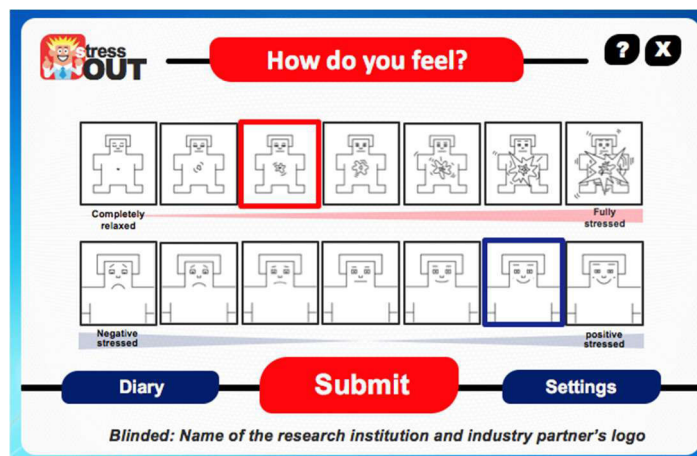

Fig. 4. Recording stress perceptions.

Furthermore, a stress visualization and sharing module (DR3 and DR4) as shown in Fig. 5 allows employees to monitor and share their stress perceptions in the form of a visual quantified-self diary. The stress intervention module (DR5) provides tips to better cope with work-related stress on a weekly basis. The tips are provided in the form of short text paragraphs as shown in Fig. 6 or audio files and covered topics such as relaxation exercises or recommendations to increase physical activity or to switch the smartphone off for several hours. In line with the last requirement, the privacy control module allows employees to take full control over their data. That is, they could use a button to share their stress data or delete the complete history of their stress reports. Finally, we implemented also an encrypted data transfer and storage module that allowed us to collect the stress data on a central server for data analyses.



Fig. 5. Visual stress diary with share option

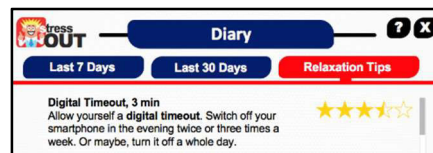

Fig. 6. The list of relaxation tips

5 Longitudinal Observational Study and First Results

To test our hypothesis, we conducted a longitudinal field study with a business organization between December 2015 and April 2016. The study was accepted by the authors' institutional review board. The HR department of our industry partner invited 496 knowledge workers with dedicated computer workstations by email. This invitation contained a link that allowed employees to participate and to directly install the stressOUT application by the company's software delivery platform. No financial incentives for participation were offered but the employees were invited to a social stressOUT event after the study that had the objective to present and discuss the results and to gather feedback from the participants with respect to further improvements of stressOUT. Overall, 62 (12.5%) employees (28, 45% females) accepted the invitation and submitted their stress levels at least ten and at most 62 times resulting in an overall dataset of 2.086 tuples of stress perceptions, i.e. arousal and valence values, at a specific point in time. Mouse cursor speed in pixel per millisecond was calculated and averaged for the last 30 minutes before each stress report.

Because of the data collection approach and the resulting data structure, i.e. stress perceptions and mouse interactions are nested within each participant, we adopted a linear mixed-effects model to test our hypothesis. We used the lme4 package version 1.1-12 for R version 3.3.3 for this purpose and calculated first a random intercept only (RIO) model with subjects as the random effect: $RIO_{arousal} = lmer(arousal \sim (1|subject))$,

data=stressOUT, REML=FALSE). Then, the random intercept model with cursor speed as fixed factor was calculated ($\text{RIMCS}_{\text{arousal}} = \text{lmer}(\text{arousal} \sim \text{speed} + (1|\text{subject}) \dots)$) and compared with the $\text{RIO}_{\text{arousal}}$ model by analysis of variance. We found no differences between the two models ($\chi^2(1) = 0.28, p = .600$). That is, mouse cursor speed is not significantly related to arousal ratings.

The same analysis was then applied to the valence ratings. Here again, no differences of the two models were found ($\chi^2(1) = 3.24, p = .071$). However, the probability to reject the null hypothesis by chance decreased considerably to .071. Here, mouse cursor speed explained $R^2 = 0.15\%$ of a total variance of $R^2 = 43.7\%$ for $\text{RIMCS}_{\text{valence}}$ (the `r.squaredGLMM` function of the `MuMIn` package version 1.15.6 for R was used to calculate marginal and conditional R^2 coefficients). That is, cursor speed increases valence ratings by about 0.15 ± 0.083 (standard errors) indicating that lower (higher) mouse cursor speed is associated with more distress (eustress).

Finally, we used the arousal ratings, i.e. the intensity of emotions, as weighting factor on the valence ratings. To separate distress from eustress, valence ratings were first recoded from -3 (negative valence) to +3 (positive valence). Cases with valence ratings of zero were dropped as multiplication with varying arousal ratings is not defined. With the resulting 209 cases, the RIO and RIMCS models differ significantly ($\chi^2(1) = 5.63, p = .018$). Now, cursor speed explains $R^2 = 2.13\%$ of the variance from a total of $R^2 = 48.6\%$ for RIMCS . That is, cursor speed increases the weighted valence ratings by about 1.24 ± 0.52 (standard errors) indicating that lower (higher) mouse cursor speed is associated with more distress (eustress). The data supports therefore our hypothesis.

6 Discussion and Future Work

To the best of our knowledge, this research-in-progress presents for the very first time results from a longitudinal field study in a realistic organizational (business) context that evaluates the relationship between work-related stress and mouse movements. Indeed, we could identify a significant and negative relationship between mouse cursor speed and the degree of perceived (di)stress when arousal and valence reports are combined. We also find that lower mouse cursor speed is associated with more distress measured by valence and that there is no association with emotional arousal ratings. These findings are promising as they are consistent with prior work [14, 17] that conducted their studies in more controlled environments as opposed to this work.

We presented only preliminary findings. We will therefore expand our analysis not only to additional features of mouse movements such as the standard deviation of speed, deviation from the shortest path between two mouse clicks or the time range used to aggregate the features, but we will also control for chronic stress conditions, personality traits and additional socio-demographic factors which we have also collected. In addition, we will build and evaluate a stress classification module for the stressOUT application. To conclude, there is only first evidence from data “in-the-wild” that cursor speed is related to stress and further analyses are required to come close to the envisioned stressOUT service that detects work-related stress with high accuracy.

References

1. Astor, P.J., Adam, M.T.P., Jercic, P., et al.: Integrating Biosignals into Information Systems: A NeuroIS Tool for Improving Emotion Regulation. *Journal of Management Information Systems* 30, 247-277 (2013).
2. Bakker, A.B., Demerouti, E.: The Job Demands-Resources Model: State of the Art. *Journal of Managerial Psychology* 22, 309-328 (2007).
3. Bradley, M.M., Lang, P.J.: Measuring Emotion: the Self-Assessment Manikin and the Semantic Differential. *Journal of Behavior Therapy and Experimental Psychiatry* 25, 49-59 (1994).
4. Cartwright, S., Cooper, C.L.: Towards Organizational Health: Stress, Positive Organizational Behavior, and Employee Well-being. In: Bauer, G.F., Hämmig, O. (eds.) *Bridging Occupational, Organizational and Public Health: A Transdisciplinary Approach*, pp. 29-42. Springer, Dordrecht (2014).
5. Cohen, S., Kamarck, T., Mermelstein, R.: A Global Measure of Perceived Stress. *Journal of Health and Social Behavior* 24, 385-396 (1983).
6. Demerouti, E., Bakker, A.B., Vardakou, I., et al.: The convergent validity of two burnout instruments: A multitrait- multimethod analysis. *European Journal of Psychological Assessment* 19, 12-23 (2003).
7. Demerouti, E., Le Blanc, P.M., Bakker, A.B., et al.: Present but sick: a three-wave study on job demands, presenteeism and burnout. *Career Development International* 14, 50-68 (2009).
8. Drucker, P.F.: Knowledge-Worker Productivity: The Biggest Challenge. *California Management Review* 41, 79-94 (1999).
9. Eurofound: Fifth European Working Conditions Survey. Publications Office of the European Union (2012).
10. Filler, A., Kowatsch, T., Haug, S., et al.: MobileCoach: A Novel Open Source Platform for the Design of Evidence-based, Scalable and Low-Cost Behavioral Health Interventions - Overview and Preliminary Evaluation in the Public Health Context. 14th annual Wireless Telecommunications Symposium (WTS 2015). IEEE, USA, New York (2015).
11. Freeman, J.B., Ambady, N.: MouseTracker: Software for studying real-time mental processing using a computer mouse-tracking method. *Behavior Research Methods* 42, 226-241 (2010).
12. Freeman, J.B., Dale, R., Farmer, T.A.: Hand in motion reveals mind in motion. *Frontiers in Psychology* 2, 1-6 (2011).
13. Gaggioli, A., Cipresso, P., Serino, S., et al.: Positive Technology: A Free Mobile Platform for the Self-Management of Psychological Stress. *Annual Review of Cybertherapy and Telemedicine* 12, 25-29 (2014).
14. Grimes, G.M., Jenkins, J.L., Valacich, J.S.: Exploring the Effect of Arousal and Valence on Mouse Interaction. *International Conference on Information Systems (ICIS)*, Milan, Italy (2013).
15. Haug, S., Paz, R., Kowatsch, T., et al.: Efficacy of a web- and text messaging-based intervention to reduce problem drinking in adolescents: Results of a cluster-randomised controlled trial. *Journal of Consulting and Clinical Psychology* 85, 147-159 (2017).
16. Hevner, A.R., March, S.T., Park, J., et al.: Design Science in Information Systems Research. *MIS Quarterly* 28, 75-105 (2004).
17. Hibbeln, M., Jenkins, J.L., Schneider, C., et al.: How Is Your User Feeling? Inferring Emotion Through Human-Computer interaction Devices. *MIS Quarterly* 41, 1-21 (2017).

18. Kessler, R.C., Barber, C., Beck, A.L., et al.: The World Health Organization Health and Work Performance Questionnaire (HPQ). *Journal of Occupational and Environmental Medicine* 45, 156-174 (2003).
19. Lazarus, R.S.: *Stress and Emotion: A New Synthesis*. Springer, New York (1999).
20. Lazarus, R.S., Folkman, S.: *Stress, Appraisal, and Coping*. Springer, New York, USA (1984).
21. Lazarus, R.S., Cohen-Charash, Y.: Discrete Emotions in Organizational Life. In: Payne, R.L., Cooper, C.L. (eds.) *Emotions at Work: Theory, Research and Applications for Management*, pp. 45-81. John Wiley, Chichester (2001).
22. Lin, C.-J., Wu, C.: Factors affecting numerical typing performance of young adults in a hear-and-type task. *Ergonomics* 54, 1159-1174 (2011).
23. Maehr, W.: *eMotion: Estimation of User's Emotional State by Mouse Motions*. VDM, Saarbrücken, Germany (2008).
24. McGowan, J., Gardner, D., Fletcher, R.: Positive and Negative Affective Outcomes of Occupational Stress. *New Zealand Journal of Psychology* 35, 92-98 (2006).
25. Michie, S.: Causes and Management of Stress at Work. *Occupational and Environmental Medicine* 59, 67-72 (2002).
26. Nahum-Shani, I., Hekler, E.B., Spruijt-Metz, D.: Building Health Behavior Models to Guide the Development of Just-in-Time Adaptive Interventions: A Pragmatic Framework. *Health Psychology* 34, 1209-1219 (2015).
27. Nyberg, S.T., Fransson, E.I., Heikkilä, K., et al.: Job Strain as a Risk Factor for Type 2 Diabetes: A Pooled Analysis of 124,808 Men and Women. *Diabetes Care* 37, 2268-2275 (2014).
28. Oldehinkel, A.J., Ormel, J., Bosch, N.M., et al.: Stressed out? Associations between perceived and physiological stress responses in adolescents: The TRAILS study. *Psychophysiology* 48, 441-452 (2011).
29. Rodrigues, M., Gonçalves, S.r., Carneiro, D., et al.: Keystrokes and Clicks: Measuring Stress on E-Learning Students. In: Casillas, J., Martínez-López, F.J., Vicari, R., de La Prieta, F. (eds.) *Management Intelligent Systems*, pp. 119-126. Springer, Heidelberg (2013).
30. Siegrist, J., Wege, N., Pühlhofer, F., et al.: A short generic measure of work stress in the era of globalization: effort-reward imbalance. *International Archives of Occupational or Environmental Health* 82, 1005-1013 (2009).
31. Simmons, B.L., Nelson, D.L.: Eustress at Work: The Relationship between Hope and Health in Hospital Nurses. *Health Care Management Review* 26, 7-18 (2001).
32. Sun, D., Paredes, P., Canny, J.: MouStress: detecting stress from mouse motion. CHI '14 Proceedings of the SIGCHI Conference on Human Factors in Computing Systems, pp. 61-70. ACM, Toronto, Canada (2014).
33. Tims, M., Bakker, A.B., Derks, D.: The Impact of Job Crafting on Job Demands, Job Resources, and Well-Being. *J Occup Health Psych* 18, 230-240 (2013).
34. van Gemmert, A.W.A., van Galen, G.P.: Stress, neuromotor noise, and human performance: A theoretical perspective. *Journal of Experimental Psychology: Human Perception and Performance* 23, 1299-1313 (1997).
35. Visser, B., Looze, M.P.D., Graaff, M.P.D., et al.: Effects of precision demands and mental pressure on muscle activation and hand forces in computer mouse tasks. *Ergonomics* 47, 202-217 (2004).
36. Zimmermann, P., Guttormsen, S., Danuser, B., et al.: Affective computing - a rationale for measuring mood with mouse and keyboard. *International Journal of Occupational Safety and Ergonomics* 9, 539-551 (2003).

An Assistance System for Business Information Visualization

Research-in-Progress

Michael Schelkle

University of Augsburg, Universitaetsstr.16, 86159 Augsburg, Germany
michael.schelkle@wiwi.uni-augsburg.de

Abstract. Business Information Visualization (BIV) is increasingly recognized in research and practice. Nevertheless, studies show that BIV is often inappropriately applied in business reporting, which may lead decision makers to wrong conclusions. Users who create these reports complain about difficulties to implement appropriate BIV due to insufficient software support. As a result BIV acceptance suffers. A promising approach to overcome this are user assistance systems (UAS). Hence, the overarching goal of our research project is to gain insight to what extent UAS affect the acceptance of BIV. Since we could not identify in literature a UAS that helps to apply appropriate BIV, we intend to develop such a UAS first. Based on design science research, the aim of this paper is to introduce a UAS prototype that may increase BIV acceptance. Besides evaluating UAS on acceptance, the artifact may help practitioners to adhere to appropriate BIV in their everyday work.

Keywords: User Assistance System · Self-Service Business Intelligence · Business Information Visualization · Guidelines · Design Science Research

1 Problem Identification and Motivation

The relevance of appropriate business information visualization (BIV) for decision support is supported by findings in literature [1] and is increasingly recognized by companies to avoid threats and realize opportunities [2]. A recent study shows that 78% of the respondents rate BIV important or very important due to the avoidance of misapprehensions and faster information transfer [2]. On the other hand, research shows that BIV is often not appropriately applied within business reporting [3, 4]. Such insufficient BIV may lead to selective or distorted perception [4]. For example, truncated axes exaggerate the magnitude of a trend, because the sizes of intervals on the vertical axis are unequal [5]. In consequence, these reports do not fulfil their central tasks: Creating business transparency and providing relevant information as basis for decision making [6] by drawing attention to critical areas and revealing needs for action. It has been shown that this deficiency may guide decision makers to wrong conclusions [4, 5], which can lead to tremendous negative results. For instance, the German project Airport

Berlin Brandenburg wasted billions of euros [7] since managers relied on poorly visualized reports [8].

A technology, which is used to create management reports and is gaining importance in the field of Business Intelligence, is Self-Service Business Intelligence (SSBI) [9]. Here, users have a variety of personal decision support features (e.g. visualizing) to independently develop their own management reports in a timely manner [10]. One pitfall however is, that this technology often gears its visualizations towards what is technically feasible, but not towards what is visually reasonable [11]. Since SSBI users can be regarded as relative BIV layman, they complain about difficulties to implement appropriate BIV, which leads to a lack of BIV acceptance [2]. One reason for this is insufficient software support that fails to assist in creating reports based on predetermined BIV guidelines [2], such as the International Business Communication Standards (IBCS). Since user assistance systems (UAS) help users to perform their tasks better [12], it appears to be a promising approach to increase the perceived usefulness and perceived ease of use of BIV. This leads to enhanced acceptance, referring to the technology acceptance model [13]. According to the design science research (DSR) methodology proposed by Peffers et al. [14], this paper aims to introduce a prototypically implemented software artifact as preliminary result.

The following sections will outline the research objective and the design and development of the prototype. Its demonstration and proposed evaluation is outlined, before the paper closes with a preliminary conclusion and a plan for future research.

2 Objective of the Research Project

2.1 Research Objective

The project's overarching goal is to gain insight to what extent UAS affect the acceptance of BIV in management reporting, in particular in an SSBI environment. To evaluate this, UAS that analyze business charts for inadequate BIV and correct shortcomings according to scientific found guidelines have to be investigated. Since after a systematic search we could not identify such UAS in literature, in a first step a UAS for BIV has to be developed. Thus, the research objective of this article is:

Designing a software-based user assistance system that increases the acceptance of appropriate business information visualization.

Herewith we follow the call of Maedche et al. [12] to study the effects of assistance systems in the field of information systems research and provide a specific solution in the form of a prototype, based on DSR [15].

2.2 Related Work

Before a UAS for fostering the acceptance of adequate BIV is developed, we want to characterize the state of the art of UAS that help to avoid misleading BIV. Since studies in BIV are fundamentally multidisciplinary, literature from prior research in computer

science, human visual perception, and an application domain (i.e., management accounting) [16] was included in our literature search. We conducted the search based on the term “user assistance system” in the databases IEEE Xplore, ACM digital library, AIS Electronic Library, and Emerald Insight to reflect the before mentioned multidisciplinary. To complement the search, management accounting as well as information systems journals were included (i.e., HMD Praxis der Wirtschaftsinformatik, Decision Support Systems, Management Accounting Research, Journal of Management Accounting Research, Journal of International Financial Management and Accounting, Advances in Management Accounting, Management Accounting Quarterly). Even so UAS could be identified (e.g., UAS for: a ticketing process of an issue tracking system [17], remote experimentation [18], fostering multimedia skills [19]), none of the articles characterizes a UAS for BIV.

Since this first search did not reveal a specific UAS, which focuses on BIV guidelines, a further search comprising the terms “chart” and “misleading” and synonyms thereof was conducted. Here several publications [20–23] got identified that deal with the topic of misleading BIV and show a demand for user assistance. However, these articles do not describe or develop a concrete software application.

Referring to these reviews, no approach for implemented software that assists to reveal and amend misleading graphics based on scientific found guidelines could be identified. This shows a research gap that we want to bridge with our research project.

3 Design and Development

3.1 Theoretical Background

Business Information Visualization.

Information visualization can be considered as an aid of thought to assist managers in decision making [1]. When information visualization technologies are used to visualize business information (e.g., charts or tables) it is referred to as BIV [24]. Hence, BIV is the use of computer-supported interactive visual representations of business data to amplify cognition for improved decision making [25]. This involves defining graphical elements and their relationships to display relevant information [1]. Based on the approach of external cognition (i.e. the use of the external world to accomplish cognition), the main idea of BIV is, that visual representations provide information to amplify cognition [26] to support decision making.

Cognitive theories help to determine how information has to be visually presented to amplify cognition. For example, cognitive load theory refers to the total amount of mental effort being used in the limited working memory and gives guidance on how to design the presentation of information for improved intellectual performance [27]. Cognitive fit theory proposes that the match between task (e.g., detect relationships) and presentation format (e.g., diagram) leads to superior task performance [28].

One approach to comply with this knowledge are guidelines [16]. In the context of BIV, we define a guideline as a general rule, principle, instruction, or piece of advice for the use of computer-supported visual representations of business data to amplify cognition. There are several guidelines for information visualization in general (e.g.,

[29], [30]), which draw on those insights. A framework that refers to these guidelines and highlights the design of business reports and presentations are the IBCS [31]. Moreover, the IBCS are increasingly recognized by industry [32] and showcase comprehensively inadequate BIV examples alongside their proposed corrections [33], which is the reason why we use these guidelines for our UAS.

Technology Acceptance Model and User Assistance Systems.

The technology acceptance model (TAM) was developed to improve our understanding of user acceptance processes and to provide a theoretical basis for a practical user acceptance testing methodology [13]. The TAM posits that perceived usefulness and perceived ease of use determine an individual's intention to use a system [26]. Davis [13] defines perceived usefulness as the extent to which a person believes that using a particular system will enhance job performance. Perceived ease of use is defined as the degree to which a person believes that using a particular system will be free of physical and mental effort [13].

Since UAS are defined as an intelligent and interactive information technology component that enables individuals to perform tasks better [12], it is a promising approach to improve the acceptance of adequate BIV. UAS guide users while performing a specific task [12] (e.g., creating visualizations), which may increase the perceived ease of use. Moreover, further determinants of perceived usefulness, such as job relevance, output quality or result demonstrability [34] may be positively affected. Job relevance is given as our UAS supports users (e.g., management accountants) in performing their task of creating visualizations for reports. The output quality may increase due to adherence to scientific found BIV guidelines. Since reports are a mean of communication and it can be measured if a visualization adheres to a set of predetermined guidelines, result demonstrability is given.

Since the TAM is a widely employed model of adoption and use and has shown to be highly predictive for these items [34], we are going to use it as theoretical background to evaluate our UAS on BIV acceptance.

3.2 Development Method

For the development of the prototype we draw on the human-centered design (HCD) process, that is frequently used in the domain of human computer interaction [35]. The four-staged iterative process comprises *specifying the context of use*, *specifying the user requirements*, *producing a design solution*, and *evaluating the artifact* [35].

The *context of use* is in our case SSBI, in which users widely generate and analyze relevant information without the support of reporting specialists [36]. These users are students of a management information system course. They can be regarded as prospective BIV professionals (e.g., information producer) as studies indicate that managers and students behave similarly [37]. In their role, they are confronted with management reports by either producing or consuming them or doing both.

The *user requirement* is to fulfill the specifications of predetermined BIV guidelines by using a UAS that helps to identify and correct inadequate BIV. As a result users may accept to adhere to adequate BIV.

With the subsequent step, *produce a design solution*, a prototype is developed, which follows the vertical prototyping concept since its system features are available in its final functionality, but limited in scope [38]. The final prototype will meet the requirements of the final application, but has not implemented all, but only a sample (e.g., truncated axis or inverted timelines) of the identified BIV guidelines.

The last step of the iterative part of the HCD process is the *evaluation of the artifact*. We use a two-staged approach for the evaluation. First we demonstrate the functionality of the prototype. In a second step we will evaluate the artifact on BIV acceptance referring to the TAM.

3.3 Design of the Software Prototype

Our UAS, the “BIV Assistant”, analyzes graphics for inadequate BIV, e.g., a truncated axis that exaggerates the magnitude of a trend and therefore may lead to wrong decision making. In case the visualization shows inadequate BIV elements, the BIV Assistant will prompt a warning message based on the respective IBCS guideline. Being warned, users receive an explanation why the visualization is inappropriate. Hence, users may perceive adequate BIV as being useful for supporting decision making. In a next step, they may decide if the BIV Assistant should automatically amend the inadequate BIV by applying the relevant IBCS guideline. Herewith, the BIV Assistant helps the user to identify and correct inadequate BIV. Hence, it facilitates to adhere to the IBCS, which may result in an increased perceived ease of use and perceived usefulness.

The prototype of the BIV Assistant, is the result of the first iteration of the HCD process as described in the previous section. The current version of the BIV Assistant detects four different misleading visualization patterns, which refer to Courtis [39]. In his work, Courtis [39] graphically illustrates four misleading charts extracted from annual reports, together with a correct construction of each graph. The BIV Assistant addresses these visualizations and detects their inappropriateness by referring to specific guidelines from the IBCS.

The first is a truncated axis. Here, the BIV Assistant examines, if the starting value of the axis is zero. If not, based on the IBCS guideline CH 1.1, the warning message “Avoid truncated axes: Charts with value axes not starting at zero [...] do not correspond to the numerical values upon which the chart is based. Therefore, value axes should generally start at zero” is displayed (see Figure 1). The user has the possibility to let the BIV Assistant automatically amend the inadequate BIV. Doing so, the BIV Assistant sets the starting value of the axis to zero.

The second misleading element, which can be detected by the BIV Assistant is an inverted timeline. Here the BIV Assistant examines if the values of the time axis are in descending order. In this case, the following message appears: “Your chart contains an inadequately visualized time series. In charts, horizontal axes visualize data series over time [...] moving from left to right” [31]. This refers to the guideline UN 3.3-1 [31]. The BIV Assistant sorts the values to an ascending order to amend this chart.

Revealing filtered elements on the ordinate axis is the third deceptive element that prompts a warning, based on the IBCS guideline ST 3.2: “Your chart contains filtered values. If some important arguments [...] are left out, the given answer will not be convincing” [31]. The correction of the element is done by clearing the filter.

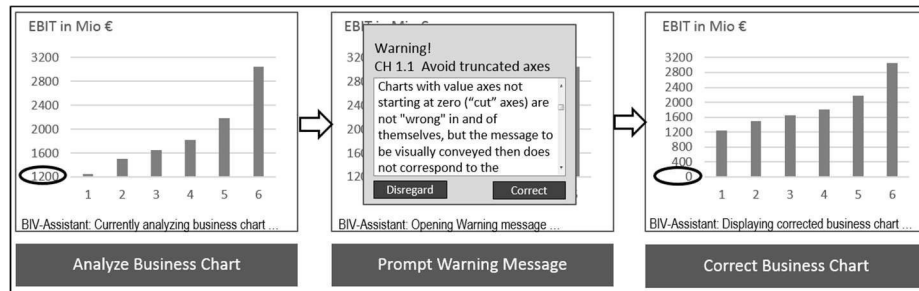

Fig. 1. BIV Assistant Prototype – Processing Steps

The last misleading element, which can be detected by the BIV Assistant are differently scaled axes in a combination chart. Referring to the IBCS guidelines CH4/ CH4.1, the following message appears: “Your chart contains differently scaled axes. Proper visual comparison requires the usage of identical scales [...]. If presenting more than one chart [...] on one page, use the identical scale for these charts” [31]. This distorted visualization is rectified by comparing the maximum values of the first and the second ordinate and adjusting the lower value to the higher.

4 Demonstration and Evaluation

Referring to Peffers et al. [14], a prototype has to demonstrate to solve one or more instances of the problem. Moreover it has to be evaluated how well the artifact supports a solution to the problem [14]. As suggested by Bucher et al. [40], the prototype got functionally evaluated by using a demonstration example. In our case, drawing on examples from Courtis [39], the prototype was successfully tested. The prototype demonstrated that it recognizes inadequate BIV, prompts a warning message in which the pitfalls of the diagram are described, and finally corrects the inadequate BIV to meet the respective requirements mentioned by Courtis [39].

Having finished the development of the prototype, it will be evaluated on BIV acceptance. The effect of the independent variable (i.e., assistance) on the dependent variable (i.e., acceptance of appropriate BIV) will be measured in a between-subject experimental design, where the subjects are randomly assigned into two groups. On a given business case, both groups will have to create or alter management reports using a SSBI tool while adhering to the IBCS. The treatment group may use the BIV Assistant, whereas the control group has to perform the task without any assistance. To evaluate the effect on acceptance, questionnaires with validated items from prior research from Venkatesh and Bala [34] will be used.

5 Discussion and Conclusion

BIV suffers from lack of acceptance due to insufficient software support. This unsatisfactory support can be confirmed by our study since no implemented software that assists to identify and correct misleading BIV could be found in literature. Even so, our prototype is a first approach to bridge this gap. At its current stage, it is limited with regard to the number of implemented guidelines. However, additional IBCS guidelines will be implemented during further development iterations. Although the prototype has demonstrated its functionality, the actual evaluation on BIV acceptance still has to be done. Therefore, in a next step the prototype will be evaluated in a between-subject experimental design, referring to validated items from prior research to test the BIV acceptance. Depending on the evaluation results, the overarching project's scientific contributions may be to underpin or disprove the relative importance of TAM constructs in the area of UAS for BIV. Generalizing our findings, we may contribute to how software-based UAS have to be designed to increase user acceptance. Practitioners who create management reports using SSBI (e.g., managers or management accountants) are addressed, as our artifact may assist in their everyday work.

References

1. Al-Kassab, J., Schiuma, G., Ouertani, M.Z., Neely, A.: Information Visualization to Support Management Decisions. *International Journal of Information Technology and Decision Making* 13, 407–428 (2014)
2. Riedner, T., Janoschek, N.: *Information Design 2014. Status quo, Nutzen und Herausforderungen von Information-Design-Initiativen in der DACH-Region.* Würzburg (2014)
3. Eisl, C., Losbichler, H., Falschlunger, L., Grabmann Elisabeth, Hofer, D., Greil, A.: *Information Design in den Geschäftsberichten der Dax 30-Unternehmen. Eine empirische Studie der FH Oberösterreich und von KPMG* (2015)
4. Eisl, C., Losbichler, H., Fischer, B., Hofer, P.: *Reporting Design – Status quo und neue Wege in der internen und externen Berichtsgestaltung* (2013)
5. Arunachalam, V., Pei, B.K.W., Steinbart, P.J.: Impression management with graphs: Effects on choices. *Journal of Information Systems* 16, 183–202 (2002)
6. Weide, G.: *Management Reporting.* CON 21, 5–12 (2009)
7. Timmler, V.: BER-Sprecher gibt zu ehrliches Interview - und fliegt, <http://www.sueddeutsche.de/wirtschaft/flughafen-berlin-brandenburg-ber-sprecher-gibt-zu-ehrliches-interview-und-fliegt-1.2943897>
8. Bullion, C. von and Ott, K.: Blamage mit Ansage, <http://www.sueddeutsche.de/wirtschaft/probleme-beim-berliner-flughafen-lange-bekannt-blamage-mit-ansage-1.1367491>
9. Bange, C., Bitterer, A., Derwisch, S., Fuchs, C., Grosser, T., Iffert, L., Janoschek, N., Keller, P., Seidler, L., Vitsenko, J.: *BI Trend Monitor 2016* (2016)

10. Poonnawat, W., Lehmann, P.: Using Self-service Business Intelligence for Learning Decision Making with Business Simulation Games. In: Zvacek, S., Restivo, M.T., Uhomobhi, J.O., Helfert, M. (eds.) CSEDU 2014 - Proceedings of the 6th International Conference on Computer Supported Education, Volume 2, pp. 235–240 (2014)
11. Griesfelder, R.: Eine vergessene Disziplin: Business Information Design (Teil 1). *Controlling & Management Review*, 66–68 (2014)
12. Maedche, A., Morana, S., Schacht, S., Werth, D., Krumeich, J.: Advanced User Assistance Systems. *Business & Information Systems Engineering* 58, 367–370 (2016)
13. Davis Jr, F.D.: A technology acceptance model for empirically testing new end-user information systems: Theory and results (1986)
14. Peffers, K., Tuunanen, T., Rothenberger Marcus A., Chatterjee, S.: A Design Science Research Methodology for Information Systems Research. *Journal of Management Information Systems* 24, 45–77 (2007)
15. Hevner, A.R., March, S.T., Park, J., Ram, S.: Design Science in Information Systems Research. *MIS Quarterly* 28, 75–105 (2004)
16. Ware, C.: *Information Visualization: Perception for Design*. Elsevier (2012)
17. Haake, P., Morana, S., Schacht, S., Zhou-Hartmann, L., Maedche, A.: Designing an End User Participation and Involvement Assistant for Continuous IS Development (2016)
18. J. Harkin, M. J. Callaghan, T. M. McGinnity, L. P. Maguire: Intelligent User-Support in Learning Environments for Remote Experimentation. In: Third International Conference on Information Technology and Applications (ICITA'05), 2, pp. 119–124 (2005)
19. Di Valentin, C., Emrich, A., Werth, D., Loos, P.: Assistance System for Personalized Learning in Vocational Education (2014)
20. Harding, B.A., Widener, E.R.: Lies, damn lies and statistics . . . : the use and abuse of business graphics. In: *Frontiers in Education Conference, 1988., Proceedings*, pp. 363–367 (1988)
21. Raschke, R.L., Steinbart, P.J.: Mitigating the Effects of Misleading Graphs on Decisions by Educating Users about the Principles of Graph Design. *Journal of Information Systems* 22, 23–52 (2008)
22. Beattie, V., Jones, M.J.: Measurement distortion of graphs in corporate reports: an experimental study. *Accounting, Auditing & Accountability Journal* 15, 546–564 (2002)
23. Woller-Carter, M.M., Okan, Y., Cokely, E.T., Garcia-Retamero, R.: Communicating and Distorting Risks with Graphs: An Eye-Tracking Study. *Proceedings of the Human Factors and Ergonomics Society Annual Meeting* 56, 1723–1727 (2012)
24. Tegarden, D.P.: Business Information Visualization. *Communications of the AIS* 1, 1–38 (1999)
25. Bačić, D., Fadlalla, A.: Business information visualization intellectual contributions: An integrative framework of visualization capabilities and dimensions of visual intelligence. *Decision Support Systems* 89, 77–86 (2016)

26. Card, S.K., Mackinlay, J.D., Shneiderman, B.: Readings in Information Visualization: Using Vision to Think. Morgan Kaufmann (1999)
27. Sweller, J.: Cognitive load theory. The psychology of learning and motivation: Cognition in education 55, 37–76 (2011)
28. Vessey, I.: Cognitive Fit: A Theory-Based Analysis of the Graphs Versus Tables Literature*. Decision Sciences 22, 219–240 (1991)
29. Few, S.: Show me the Numbers. Designing Tables and Graphs to Enlighten. Analytics Press, Burlingame, Calif. (2012)
30. Tufte, E.R.: Visual Explanations: Images and Quantities, Evidence and Narrative. Graphics Press (1997)
31. Hichert, R., Faisst, J.: International Business Communication Standards. IBCS Version 1.0 (2015)
32. Proff, D.U., Schulz, A.-K.: Visualisierungsgemeinschaft. Die Erstellung aussagekräftiger Berichte bekommt neuen Schub. Business Intelligence Magazine, 46–49 (2016)
33. Grund, C.K., Schelkle, M.: Developing a Serious Game for Business Information Visualization. In: Proceedings of the 22nd Americas Conference on Information Systems (AMCIS) (2016)
34. Venkatesh, V., Bala, H.: Technology Acceptance Model 3 and a Research Agenda on Interventions. Decision Sciences 39, 273–315 (2008)
35. Earchy, J., Jones, B.S., Bevan, N.: The improvement of human-centred processes—facing the challenge and reaping the benefit of ISO 13407. International Journal of Human-Computer Studies 55, 553–585 (2001)
36. Taschner, A.: Wie Management Reporting 2020 aussehen könnte. Controlling & Management Review, 8–15 (2014)
37. Gary E. Bolton, Axel Ockenfels, Ulrich W. Thonemann: Managers and Students as Newsvendors. Management Science 58, 2225–2233 (2012)
38. Floyd, C.: A Systematic Look at Prototyping. In: Budde, R., Kuhlenkamp, K., Mathiassen, L., Züllighoven, H. (eds.) Approaches to Prototyping, pp. 1–18. Springer Berlin Heidelberg, Berlin, Heidelberg (1984)
39. Curtis, J.K.: Corporate annual report graphical communication in Hong Kong: effective or misleading? Journal of Business Communication 34, 269–284 (1997)
40. Bucher, T., Riege, C., Saat, J.: Evaluation in der gestaltungsorientierten Wirtschaftsinformatik-Systematisierung nach Erkenntnisziel und Gestaltungsziel (2008)

An End-to-End Process Model for Supervised Machine Learning Classification: From Problem to Deployment in Information Systems

Robin Hirt, Niklas Kühn, and Gerhard Satzger

Karlsruhe Service Research Institute (KSRI),
Karlsruhe Institute of Technology (KIT),
Kaiserstr. 89, 76131 Karlsruhe
{hirt,kuehl,gerhard.satzger}@kit.edu
<http://www.kit.edu>

Abstract. Extracting meaningful knowledge from (big) data represents a key success factor in many industries today. Supervised machine learning (SML) has emerged as a popular technique to learn patterns in complex data sets and to identify hidden correlations. When this insight is turned into action, business value is created. However, common data mining processes are generally not tailored to SML. In addition, they fall short of providing an end-to-end view that not only supports building a "one off" model, but also covers its operational deployment within an information system.

In this research-in-progress work we apply a Design Science Research (DSR) approach to develop a SML process model artifact that comprises model initiation, error estimation and deployment. In a first cycle, we evaluate the artifact in an illustrative scenario to demonstrate suitability. The results encourage us to further refine the approach and to prepare evaluations in concrete use cases. Thus, we move towards contributing a general process model that supports the systematic design of machine learning solutions to turn insights into continuous action.

Keywords: Data Mining Process, Supervised Machine Learning, Information Systems

1 Introduction & Methodology

In parallel to the "data tsunami" triggered by sensor or social media data [1], also the availability of methods and tools to exploit data has quickly picked up. Thus, possibilities to take advantage from insights drawn from (big) data have dramatically increased [2]. While many early attempts in knowledge discovery or data mining have focused on one time analyses, organizations increasingly embed such machine learning approaches in operational processes to reap ongoing benefits, e.g. predictive maintenance provision, forecasting processes, or customer churn predictions. Significant importance has been attributed to supervised machine learning approaches [3, 4]—where developed models can be turned into analytics services embedded within larger applications [5].

While there are several different process models on data mining in general and although these models are widespread [6], existing approaches bear deficiencies in at least two aspects—as we will show in more detail later: First, they are not tailored to SML classification and, thus, not granular enough to serve as a hands-on guidance for data analysts. Second, they typically do not cover the critical step of the model error estimation and the ultimate process step to deploy an analytics service within an information system. In order to address both of these gaps, we apply a Design Science Research (DSR) approach [7] to design a comprehensive, end-to-end process model specifically for classification using SML. This artifact describes the activities and the data flow during the initiation, error estimation and deployment of a generic SML classification model built to predict a certain attribute from a given dataset. Thus, we aim to add knowledge in the form of operational principles/architecture, thus making a "level 2" contribution to knowledge ("nascent design theory") [8, p. 341]. As we aim to develop a new solution for a known problem, the DSR contribution type is an *improvement* [9]. Figure 1 depicts our approach—with the individual steps

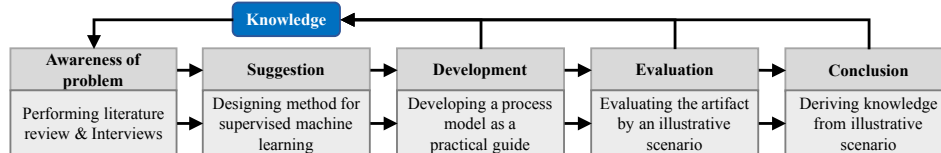

Fig. 1. DSR activities of the first cycle, according to Peffers et al. [10]

also serving to structure the remaining paper: At first, we review relevant literature and conduct exploratory interviews with two experts from industry—both confirming awareness of an issue (section 2). Then, we explain the suggestion and development of our novel process model (section 3). In the evaluation step, we test the artifact for suitability in an illustrative scenario [11] (section 4). According to Peffers et al. [10], an illustrative scenario is an evaluation method type and defined as "Application of an artifact to a synthetic or real-world situation aimed at illustrating suitability or utility of the artifact" [10]. In our case we apply the process model (*artifact*) to the development of a SML classification service to predict the age of Twitter users (*real-world situation*) to illustrate its suitability. Finally, we derive knowledge out of the completed design cycle—which then leads us into subsequent design cycles (section 5).

2 Awareness of Problem

There is a variety of different process models for data mining [6], common representatives amongst researchers and practitioners being Knowledge Discovery in Databases (KDD) [12] and Cross Industry Standard Process for Data Mining (CRISP-DM) [13]. While these process models are highly popular, they are either pursuing particular objectives or are focusing on a limited part of the overall process only [6]. None is specifically tailored to SML classification challenges nor

does any of them include the error estimation and deployment steps of a predictive model within an information system. Table 1 compares the most common models as to the full coverage of a SML process from model instantiation to model deployment.

Table 1. Comparison of different data mining process models regarding a holistic supervised machine learning process

Source	Model initiation	Model error estimation	Model deployment
Fayyad et al. [12] (KDD)	◐	◐	○
Chapman et al. [13] (Crisp-DM)	●	○	●
Witten et al. [14]	○	○	●
Cabena [15]	◐	○	○
Anand & Büchner [16]	●	○	○
Cios et al. [17]	◐	○	○
Brodley & Smyth [18]	●	●	○

○= Not addressed, ◐= Partially addressed, ●= Fully addressed

As the table shows, related work is very much focused on the process steps of the model initiation (like preprocessing and model training)—but usually misses out on the error estimation as well as the important final step to embed the generated models within an IS artifact (and thus to create an actionable analytics service). Furthermore, none of the existing processes is describing the data flow during the process, which is a crucial aspect for creating a well-performing SML model.

Therefore, in this research-in-progress paper we propose a holistic *process model* for SML classification—from problem to final deployment. Such an artifact can then be used for arbitrary *SML model* scenarios aiming at actionable SML analytics services, e.g. in predictive maintenance applications or any of the other scenarios mentioned before.

In order to contrast evidence from literature to current industry perception, we additionally conduct exploratory interviews with two experts that analyze data on a daily basis. They confirm the necessity of a fine-grained process model tailored to SML classification tasks and emphasize the importance of standardization in this context. According to them, currently established processes (e.g. KDD) are insufficient as a guideline for building a SML classification model that serves to derive knowledge out of data and is deployed for continuous use. Thus, insights from both the literature review and industry interviews confirm the lack of a holistic process model tailored to SML applications.

3 Suggestion & Development

Our goal is to design a process model that depicts the activities as well as the data flow throughout the initiation, error estimation and deployment of a SML classification process to predict a certain attribute from a large set of data. The process runs through three consecutive phases, and ends with a deployed SML classification model (figure 2). From a data perspective, we have to keep in mind that for any supervised learning a *ground truth data set* (where the targeted

attribute is known) is needed to train and test the model. To achieve this, the process starts with a well-defined problem that describes the (business) setting as well as the objective to be predicted. In the first phase, the *model initiation*, the *problem space is explored* to gain insights. Methods, like an exploratory data analysis [19], can be of use to find meaningful patterns and to identify the relevant data (features) that can later on be processed. Furthermore, the performance metrics are selected that are afterwards used to validate and test the model. Common metrics include F_β -score, ROC-AUC, sensitivity, recall, specificity, accuracy, Cohen's Cappa and others. The metrics are selected in light of the specific problem setting, e.g. reflecting classification error impacts.

After that, the *raw data* is gathered. Should the target attribute not already be included in the data, a manual *labelling* process is necessary. In that case, to ensure correctness of the ground truth data, it is advisable to categorize the data by more than one human assessor to minimize the manual classification bias [20]. Next, this data is cleaned and structured and further *preprocessed* (if necessary). Depending on the data input, fundamental preprocessing might be necessary. For instance, if text needs to be analyzed, common preprocessing techniques from the field of natural language processing (NLP) would be a n-gram generation [21] or stemming [22]. The result of this step is the *ground truth data*, which serves as the basis for the remaining process. The only remaining step is *choosing a classification algorithm*.

The second main phase is the *model error estimation*, where the goal is to estimate the expected performance of a model on unseen data. This is necessary, as a model selection without a previous error estimation cannot make meaningful estimations about performances and will result in too optimistic results [23]. As we aim at identifying a solid model, we also need to regard different *algorithm parameters*, which will characterize our machine learning model. A parameter, for instance, is the error term penalty in case of evaluating a support vector machine [24]. For each parameter a range of values has to be chosen (*search space*). Then, *data is split* to be handled in an outer and inner cross validation (*nested cross validation*). In the inner iteration, the *model is trained and validated* for different parameter sets towards its fit for the given problem. Various techniques for parameter tuning, such as a grid search, a bayesian optimization [25], a gradient-based optimization [26] or a random select [27] can be used. Ultimately, the previously defined metrics determine the *best performing parameters* on the inner iteration. After iterating through all possibilities (in case of a grid search), the best performing pair of parameters (on average) is then used to train on the whole data set from the inner fold and validate it on completely unseen data from the outer fold. Only by doing this, we can gain insight on how well the model would perform on new, unseen data—and how the results vary across different scenarios [28]. This process is repeated multiple times—depending on the amount of folds and runs from the outer cross validation. After all outer fold are iterated, we can calculate the mean, deviation and confidence interval for the different acquired performances from their validation on the outer folds. This result gives then insight about the expected performance of our model on

unseen data and how widely it varies—and therefore how stable the model is and how much it tends to over-fit [29].

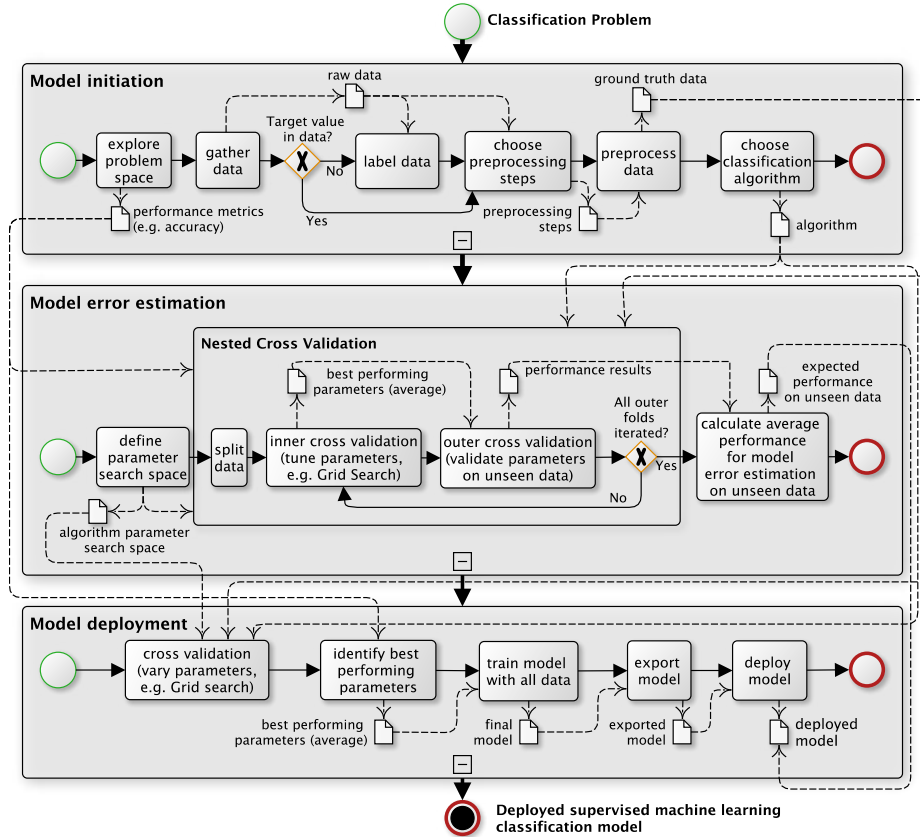

Fig. 2. End-to-end process model for SML classification including the data flow, divided into model initiation, error estimation and deployment.

The goal of the final *model deployment* phase is the generation, implementation and distribution of a built SML model—potentially as an analytics service—within an information system. First, we perform another *cross validation* with the identical parameter search space from the error estimation. We *identify the combination of parameters* which achieves the best results regarding our previously defined performance metrics. As data is always valuable and in most cases scarce, the complete data set is used to train the final machine learning classification model using the previously selected parameters. Then, an *export of the final model* (serialization) is needed to save the state of the model and the used preprocessing pipeline for further usage. Now, the serialized object can be included into a workflow, such as a connected web service, to predict the target value of new, incoming data. Hereby, data gets sent to the serialized object to be preprocessed and classified by the model. The *deployed SML classification*

model, including the preprocessing steps, is the final output of the third phase and the overall process.

4 Evaluation

The developed artifact is evaluated by performing an illustrative scenario [10] to show its suitability as an SML classification process model. As a real-world scenario, we want to predict the age-class (1-17, 18-24, 25+ years of age) of a Twitter user by applying NLP and SML to the user’s tweets. This information would be valuable, e.g., to analyze demographics of trending topics or the automatic elicitation of customer needs [20].

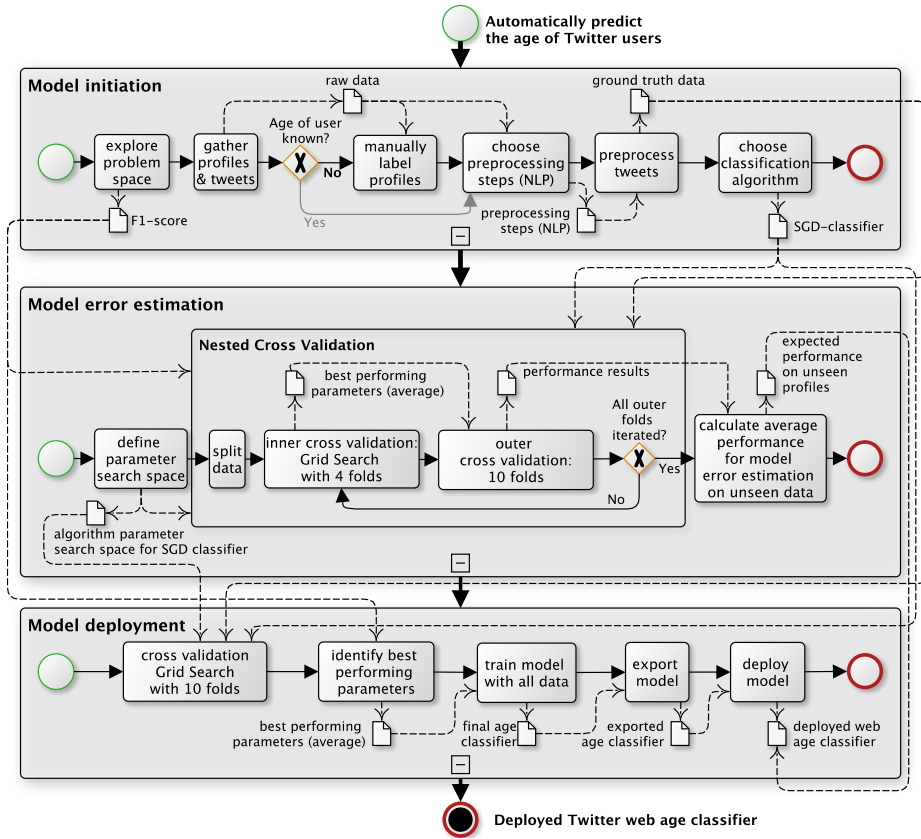

Fig. 3. Overview over the process that includes the three main sub-processes of solving a text mining problem.

As depicted in fig. 3, we follow the developed process to cope this challenge as an illustrative scenario. During the *model initiation*, we explore the problem space by comparing research about age classification and the feasibility of a tweet-based age classifier [30]. We define the F_1 -score as our *performance metric*,

which represents a trade-off between recall and precision. After that, we use the official Twitter API¹ to gather profiles and tweets of Twitter users who have at least 20 tweets and who mention their age in the profile description. Manually, we sort out profiles that might be misleading, e.g. bots (structure & clean data). We then link the profiles to the corresponding age class (*manually label profiles*). For each profile we concatenate 20 tweets that represent a text with a corresponding age-class. This yields in a imbalanced data set with 781 categorized texts with a distribution of 305 (1-17) to 285 (18-24) to 191 (25+). We use Natural Language Processing (NLP) techniques as preprocessing [30], such as an n-gram processing, emoticon-count, hashtag-count and hyperlink-count, and preprocess the tweets. The output now represents our ground truth data set. Now we perform a pre-test using several SML classifier algorithms and choose the Stochastic Gradient Descent classifier as the best performing algorithm.

During the *model error estimation* phase, we first define a range of parameters to tune the SML algorithm which defines our parameter search space. Now we perform a *nested cross validation* with an inner 4-fold cross validation and an outer 10-fold cross validation, to first tune and then validate the classifier parameters. As an output of the inner cross validation, we get the *best performing parameters*. Then, the outer cross validation outputs the *performance results* that we use to calculate the *expected performance on unseen data*. The mean is 47.47% F₁-score, a deviation of 5.05% and confidence interval of [36.12; 57.04].

In a last step, the *model deployment*, we perform a *10-fold cross validation* with a Grid Search to *identify the best performing parameters* out of the parameter search space. The best run scores a F₁-score of 52.02% which lays inside the confidence interval identified during the model error estimation phase. Now all ground truth data is used to train the final model. This final text classifier is *exported and deployed* in a web service architecture. Providing a REST-API, concatenated tweets of Twitter users can be sent to the API, triggering the classifier to predict the age and return the the response. The deployed model now has an expected performance on unseen data derived during the model error estimation phase. The classifier is made publicly accessible as a web service through a user interface for demonstration². With that, the age predicting SML classifier can be embedded in other applications to dynamically segment groups of users. As we tightly adhere to the developed process and succeed in building a text-based age classifier for Twitter users, we demonstrate that the developed artifact is suitable and helpful to guide both activities and data flow during the initiation, generation and deployment of a SML classification model.

5 Conclusion

We suggest and develop a holistic process model as an artifact to systematically build SML classification models that predict an attribute from a given dataset. It both attends to the specifics of a SML classification model and includes the

¹ <https://dev.twitter.com/rest/public>, last accessed on 23-02-2017.

² <http://age-prediction.science>, last accessed on 21-04-2017.

deployment into an information system for continuous use and actionability. In a first design cycle we run a first validation to test the suitability of the artifact via an illustrative scenario [11]: We build a text-based age classifier for Twitter users applying a step-by-step mapping to the developed process model.

Our future research will include additional evaluations of the artifact—in concrete case studies and in experimental benchmarks vs. established process models. We expect to generate more insights from the evaluations that will help us to further refine the artifact in future design cycles, e.g. by detailing sub-steps or providing decision guidance.

Thus, we contribute a first version of an artifact that will augment the inventory of concepts and methods in knowledge discovery. The managerial implications of a comprehensive process model for supervised machine learning are evident. As data availability and SML classification approaches soar in importance, a standardized and holistic process model is key to ensure flawless, high prediction quality and efficient SML classification models that can also be embedded in information systems for continuous support of decisions and actions.

Acknowledgements The authors would like to thank Björn Schmitz for his input and contributions to the process model.

References

1. Van der Aalst, W.M.: Data scientist: The engineer of the future. In: Enterprise Interoperability VI. Springer (2014) 13–26
2. Hashem, I.A.T., Yaqoob, I., Anuar, N.B., Mokhtar, S., Gani, A., Khan, S.U.: The rise of big data on cloud computing: Review and open research issues. *Information Systems* **47** (2015) 98–115
3. Jensen, L.J., Bateman, A.: The rise and fall of supervised machine learning techniques (2011)
4. Michalski, R.S., Carbonell, J.G., Mitchell, T.M.: Machine learning: An artificial intelligence approach. Springer Science & Business Media (2013)
5. Stokic, D., Scholze, S., Barata, J.: Self-learning embedded services for integration of complex, flexible production systems. In: IECON 2011-37th Annual Conference on IEEE Industrial Electronics Society, IEEE (2011) 415–420
6. Kurgan, L.A., Musilek, P.: A survey of knowledge discovery and data mining process models. *The Knowledge Engineering Review* **21**(01) (2006) 1–24
7. Kuechler, B., Vaishnavi, V., Systems, C.I.: Theory Development in Design Science Research: Anatomy of a Research Project. Conference on Design Science Research in Information Systems and Technology (2007) pp. 1–15
8. Gregor, S., Hevner, A.R.: Positioning and Presenting Design Science Types of Knowledge in Science Research. *MIS Quarterly* **37**(2) (2013) 337–355
9. March, S., G., S.: Design and Natural Science Research on Information Technology. *Decision Support Systems* **15** (1995) 251–266
10. Peffers, K., Rothenberger, M., Tuunanen, T., Vaezi, R.: Design Science Research Evaluation. *Design Science Research in Information Systems. Advances in Theory and Practice* (2012) 398–410

11. Peffers, K., Tuunanen, T., Rothenberger, M.A., Chatterjee, S.: A Design Science Research Methodology for Information Systems Research. *Journal of Management Information Systems* **24**(3) (2007) 45–77
12. Fayyad, U., Piatetsky-Shapiro, G., Smyth, P.: The kdd process for extracting useful knowledge from volumes of data. *Communications of the ACM* **39**(11) (1996) 27–34
13. Chapman, P., Clinton, J., Kerber, R., Khabaza, T., Reinartz, T., Shearer, C., Wirth, R.: *Crisp-dm 1.0 step-by-step data mining guide*. (2000)
14. Witten, I., Frank, E., Hall, M., Pal, C.: *Data Mining: Practical Machine Learning Tools and Techniques*. The Morgan Kaufmann Series in Data Management Systems. Elsevier Science (2016)
15. Cabena, P., Hadjinian, P., Stadler, R., Verhees, J., Zanasi, A.: *Discovering data mining: from concept to implementation*. Prentice-Hall, Inc. (1998)
16. Anand, S.S., Büchner, A.G.: *Decision support using data mining*. Financial Times Management (1998)
17. Cios, K.J., Teresinska, A., Konieczna, S., Potocka, J., Sharma, S.: Diagnosing myocardial perfusion from pect bulls-eye maps—a knowledge discovery approach. *IEEE Engineering in Medicine and Biology Magazine* **19**(4) (2000) 17–25
18. Bradley, C.E., Smyth, P.: *The process of applying machine learning algorithms*. Applying Machine Learning in Practice IMLC-95 (1998)
19. Borcard, D., Gillet, F., Legendre, P.: *Exploratory Data Analysis*. Applied Spatial Data Analysis with R **2**(1999) (2008) 21–54
20. Kuehl, N., Scheurenbrand, J., Satzger, G.: NEEDMINING: IDENTIFYING MICRO BLOG DATA CONTAINING CUSTOMER NEEDS. In: Proceedings of the 24th European Conference of Information Systems, AIS (2016)
21. Pustejovsky, J., Stubbs, a.: *Natural language annotation for machine learning*. (2013)
22. Andrews, N.O., Fox, E.A.: *Recent developments in document clustering*. Citeseer (2007) 1–25
23. Cawley, G.C., Talbot, N.L.: On over-fitting in model selection and subsequent selection bias in performance evaluation. *Journal of Machine Learning Research* **11**(Jul) (2010) 2079–2107
24. Joachims, T.: *Text categorization with support vector machines: Learning with many relevant features*. Lecture Notes in Computer Science **1398** (1998) 137–142
25. Snoek, J., Larochelle, H., Adams, R.P.: *Practical Bayesian Optimization of Machine Learning Algorithms*. Adv. Neural Inf. Process. Syst. **25** (2012) 1–9
26. Maclaurin, D., Duvenaud, D., Adams, R.P.: *Gradient-based Hyperparameter Optimization through Reversible Learning*. Proceedings of the 32nd International Conference on Machine Learning (2015) 1–10
27. Bergstra, J., Yoshua Bengio, U.: *Random Search for Hyper-Parameter Optimization*. *Journal of Machine Learning Research* **13** (2012) 281–305
28. Beleites, C., Salzer, R.: *Assessing and improving the stability of chemometric models in small sample size situations*. *Analytical and Bioanalytical Chemistry* **390**(5) (2008) 1261–1271
29. Varma, S., Simon, R.: *Bias in error estimation when using cross-validation for model selection*. *BMC bioinformatics* **7**(1) (2006) 91
30. Burger, J.D., Henderson, J., Kim, G., Zarrella, G.: *Discriminating Gender on Twitter*. *Association for Computational Linguistics* **146** (2011) 1301–1309

Designing Attention-aware Business Intelligence and Analytics Dashboards

Peyman Toreini¹ and Stefan Morana¹

¹ Institute of Information Systems and Marketing, Karlsruhe Institute of Technology,
Karlsruhe, Germany
{peyman.toreini; stefan.morana}@kit.edu

Abstract. The design of user interface is known to influence the users' attention while they are interacting with applications such as Business Intelligence and Analytics (BI&A) dashboards. BI&A dashboards are considered as critical because they contain a lot of compressed information and managers only spend a little time to process the provided information. Thereby, they need to manage their visual attention properly due to inattention blindness and change blindness issues. We propose to investigate the design of BI&A dashboards that are sensitive to the users' attention. So called attention-aware BI&A dashboards are of utmost importance in the field of BI&A systems since attention is known to play a major role in constructing decisions. We motivate our research project and present the initial design of attention-aware BI&A dashboards. Especially the inclusion of eye-tracking technology is an important aspect of our proposed design.

Keywords: Attention-aware · Eye-tracking devices · BI&A · Dashboards · Visual attention

1 Introduction

User interface (UI) design is known to influence attention of the users while they are interacting with applications [1]. The users' attention is assumed to be selective [2] as only a limited amount of visual information can be processed simultaneously [3]. There are two methods of directing attention while users are interacting with an UI, stimulus-driven and goal-directed selection [4]. In the stimulus-driven selection, the attention is guided by salient visual features, which make elements in the interface stand out from their neighbours and therefore grab the user's attention. In the goal-directed selection, the users' intention is considered and that users select specific parts of the interface consciously. However, even with a perfect UI design, users will allocate their attention differently, depending on their task, the environment, and the users' characteristics [5]. UIs that are sensitive to the users' attention are called attentive user interfaces [6] and managing the users' attention is one of the most pressing but also difficult challenges in human-computer interaction (HCI) research [7].

Business Intelligence & Analytics (BI&A) systems focus on supporting users in the decision making process. Specifically, BI&A dashboards refer to graphical UIs that contain analytical results and measures of the organization's business performance [8].

Such dashboards contain functional and visual features that support and enable managerial decision making [8]. The intersection of HCI and BI&A, such as designing proper BI&A dashboards, is considered as critical [9], because there is a lot of compressed information on them and managers only spend little time to process the presented information. On the one hand, using the powerful analytical capabilities and provided analytical results in BI&A dashboards promises to support decision makers. This is critical since including not enough information in a BI&A dashboard can make it useless and having relevant data that fits to the tasks of decision makers is crucial [10, 11]. On the other hand, processing such enormous amount of information is a difficult task for decision makers. A reason for that is the limitation of the capacity of humans to process visual information [12]. To cope with this limitation, decision makers process the vast amount of information provided in BI&A dashboards by using selective visual attention [13, 14]. Selective visual attention refers to the cognitive process in that decision makers are concentrating on the discrete aspect of analytical results on a dashboard while ignoring other parts. Simon [15] recognized that a wealth of information may create a poverty of attention. Thus, there is a need to allocate the decision maker's visual attention efficiently among the overabundance of information sources on a dashboard, since attention is known to play an important role in constructing decisions [16].

We propose to investigate the design of BI&A dashboards that are sensitive to the users' attention. So called attention-aware BI&A dashboards are of utmost importance in the field of BI&A systems, because of the constructing role of attention in human decision making. From a technological point of view, eye-tracking devices can be utilized for designing attention-aware dashboards. Visual attention is particularly relevant to attention-aware systems since the current predominant modality for computer-to-human communication is visual [17]. Researchers found that the users' eye movements can be used as an approximation for users' visual attention [18]. Moreover, eye movements can be used to approximate the users' cognitive processes and give a hint about what users are currently thinking or what their intentions are [19]. In addition to that, researchers in the IS domain suggest using these tools to design systems that reduce cognitive overload by enhancing the users' capabilities [20]. So far, there is only limited research examining BI&A systems and the related cognitive user states, despite their economic significance and widespread use [21]. Moreover, there is a lack of research in designing attention-aware BI&A dashboards. In our research, we focus on the design of attention-aware BI&A dashboards by applying a design science research (DSR) approach [22]. We specifically focus on the design of BI&A dashboards that are sensitive to the users' visual attention by analyzing their eye movement data. Summed up, our research project addresses the following overall research question:

How to design attention-aware BI&A dashboards in order to improve the individual performance of decision makers?

Our research project will contribute by providing design knowledge for attention-aware BI&A dashboards. In this research in progress paper, we motivate this important research topic, outline the structure of our research project, and present the initial design for attention-aware BI&A dashboards.

2 Conceptual Foundations and Related Work

2.1 Business intelligence and analytics dashboards

BI&A systems are a well-known class of supportive systems for decision makers. They refer to the techniques, technologies, systems, practices, methodologies, and applications that analyze critical business data to help an organization understanding its business and market better as well as to make timely business decisions [23]. To support decision makers, BI&A systems are generating insights by utilizing analytical techniques and then visualizing the insights in the form of dashboards. The dashboards should be designed in a way to help decision makers to maintain their cognitive tasks such as decision making in convenient ways. Therefore, dashboards need to be evaluated according to their design features and the way the users interact with them to make decisions [8]. The interaction between decision makers and BI&A dashboard is mainly focused on investigating the information visualization [24]. In fact, the proper usage of the BI&A front-end (e.g. dashboards) and matching it to the decision makers' tasks are known to affect the success of such systems [25]. The design of dashboards is important and there is an ongoing discourse in research on how to design them properly [8].

2.2 Eye-tracking and attention

The users' attention is assumed to be selective [2] and researchers refer to attention as the set of processes enabling and guiding the selection of incoming perceptual information [17]. Measuring the users' attention, or an approximation of it, is possible by applying subjective and objective measurements [12, 26]. Researchers use eye-tracking devices in neuroscience, psychology, ergonomics, advertising, and design [27] as the users' eye movements can be used as an approximation of their visual attention [13] [18], their cognitive processes, and the users' intentions [19]. Eye-tracking devices record the users' eye movements when interacting with UIs, and this information can be used as input for intelligent UIs [28], such as attentive UIs [6]. Duchowski [29] distinguishes between interactive and diagnostic eye-tracking applications. Based on this categorization, interactive applications utilize eye-tracking for attentive interactions such as moving the cursor or selecting an object through individuals' eyes. On the other hand, diagnostic applications record the eye movements, and use this source of data as an evidence of the users' visual and attentional processes [29]. Lack of attention while working in the digital environments can cause different errors which are known as attentional breakdowns [30]. The eye movement data can be used for the design of attention-aware systems in order to support users to avoid or recover from attentional breakdowns. The failure to notice a fully visible, but unexpected content in UIs can be explained by the phenomenon named inattention blindness. Failing to visually recognize an object can occur because of a lack of attention since this is a necessary precondition for visual perception [31]. Moreover, the ability to notice changes is important for users [32] and the inability to detect changes is called change blindness [33]. The phenomenon of change blindness has inspired strong claims about visual attention, visual

memory, and awareness [32]. Moreover, attention is important to support change detection [34]. The difference between change blindness and inattentional blindness is that inattentional blindness refers to missing information on one display at a specific point in time while change blindness refers to missing changes between related displays in different points of time.

3 Research Method

Our research project follows the DSR approach proposed by Kuechler and Vaishnavi [35] and is divided into two consecutive design cycles (see **Fig. 1**).

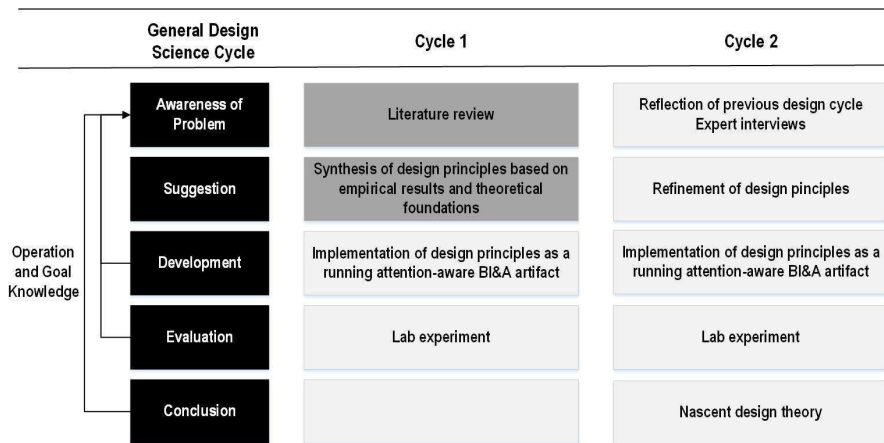

Fig. 1. Design cycles and research activities

In the first design cycle, we conducted a literature review on designing attention-aware UIs to get an overview on the topic and to identify research gaps. We identified the need to investigate the issue of missing important information because of attentional breakdowns, especially focusing on the two phenomena inattentional blindness [31] and change blindness [33]. Moreover, we identified the need to support BI&A dashboard users to manage their visual attention while using dashboards. The availability of new technology, such as affordable and reliable eye-trackers enables us to design an innovative solution to these issues. At the moment, we are in the suggestion phase of the first design cycle and identified initial meta-requirements for the design of attention-aware BI&A dashboards. Next, the meta-requirements will serve as the baseline for theory-grounded design principles. The derived design will be instantiated in the form of an attention-aware BI&A dashboard artifact that will be evaluated in a laboratory experiment.

In the second design cycle, we will start with the reflection of the previous design cycle’s results and refine our design accordingly. In addition, we will conduct a series of expert interviews with BI&A dashboard users. In these interviews, we will discuss

our current findings and present the instantiated attention-aware BI&A dashboard artifact to receive feedback from them. We will use the interviews' results and additional theoretical knowledge to adapt our design. Subsequently, we will develop an improved attention-aware BI&A dashboard artifact based on the adapted design and conduct a second laboratory experiment evaluation. The findings of both experiments will serve as the baseline to derive a nascent design theory for attention-aware BI&A dashboards.

4 Attention-aware BI&A Dashboard Design

In the following, we discuss the current state of deriving meta-requirements for the design of attention-aware BI&A dashboards by focusing on missing important information on BI&A dashboards as an attentional breakdown [30]. BI&A dashboards and the included interactive technologies have the potential to bias decisions by focusing attention on a limited set of alternatives, increasing the salience of less diagnostic information, and encouraging inappropriate comparisons [11]. What users see or do not see depends on how they allocate their attention while interacting with BI&A dashboards. Missing important information on BI&A dashboards can be approached by addressing the two phenomena inattention blindness [31] and change blindness [32]. Having a comprehensive overview of the presented information on BI&A dashboards and also notice changes from the past are essential for the decision makers. We especially include eye-tracking devices in our proposed design for BI&A dashboards, as eye movement data is an important aspect of the proposed solution to the addressed issues. First, we argue that an attention-aware BI&A dashboard should be able to capture the users' current visual attention. Thus, we propose our first meta-requirement (MR):

MR1: *Monitor the users' visual attention.*

There exist subjective as well as objective measurements for the users' visual attention. Researchers argue that the users' eye movements, as well as their current eye fixations, are an approximation for their visual attention and their cognitive processes [18, 19]. Eye-tracking technology can be used to detect the users' gaze position and collect the relevant eye movement data (such as fixation, saccade, etc.) in real-time. Based on this data, the users' visual attention can be analyzed. Thus, we propose the second MR:

MR2: *Utilize eye-tracking devices to collect users' eye movement data.*

Decision makers face the challenge to make biased decisions by focusing their attention on a limited set of alternatives on BI&A dashboards [11]. Having only a subset of the required information can result in inaccurate decision making. Providing feedback on their current visual attention can enable them to allocate their visual attention more efficient and avoid attentional breakdowns and miss important information [30]. Such feedback can direct users to allocate attention on missed important information and avoid inattentional blindness while investigating the BI&A dashboard. Moreover, having efficient attention allocation on the BI&A dashboard will support decision makers to compare the results and find the changes. Feedback refers to sending back information about what action has been done, and various kinds of feedback are available

for interaction design [36]. How and where users paid attention is known as a valuable source of information to provide feedback [37]. Thus, we propose the third MR:

MR3: *Provide feedback on the users' visual attention.*

Based on the three MRs, we propose a preliminary design as well as system architecture for attention-aware BI&A dashboard (see Fig. 2) in the following. Please note, as our design is not finalized yet, the presented design and system architecture is discussed only on an abstract level.

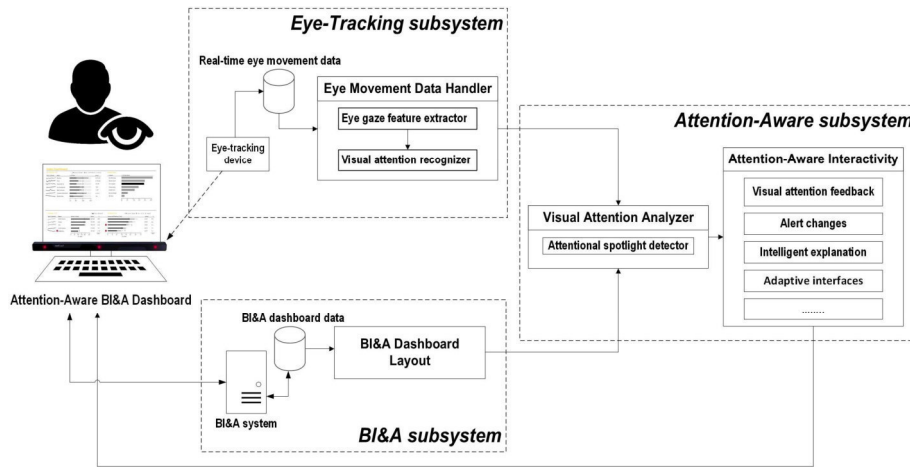

Fig. 2. Attention-aware BI&A dashboard system architecture

The proposed architecture includes the eye-tracking, BI&A, and attention-aware subsystems. The BI&A subsystem handles the relevant business data, data analysis, and visualizes the analytical results in the form of a BI&A dashboard. On the other hand, the eye-tracking subsystem is responsible for tracking the users' eye movements while interacting with the BI&A dashboard and stores the relevant eye movement data (such as fixation, saccades, etc.). This subsystem contains the "eye movement data handler" that is responsible for analyzing the real-time eye movement data and extracting the relevant information. This information is used to determine the users' visual attention. The attention-aware subsystem includes the "visual attention analyzer" component that merges the information from the "eye movement data handler" and the BI&A dashboard layout. It receives the gaze position from the eye-tracking subsystem and identifies the users' attentional spotlight in the BI&A dashboard. This component analyzes whether the decision maker missed some visible information or paid enough attention to the relevant content, determines the time to give feedback, and process the changed information, etc. The other component in this subsystem is the "attention-aware interactivity". Interactivity is the key IT's ability to affect cognitive processes and ultimately the performance of such systems [38]. This component implements and supports the attention-aware interaction between the decision maker and the BI&A dashboard. Each of these interactions can support decision makers in managing their visual attention in

an efficient way. An example of such interaction is “attention feedback” that provides real-time feedback to the decision makers about how they allocated their visual attention on the BI&A dashboard. Providing real-time feedback will help decision makers to reduce mental load and make the interaction easy [39]. Moreover, we argue that such attention feedback supports users to manage their visual attention in a better way. The current design is still work in progress and based on the provided information and MRs, there can be different attention-aware interactions.

5 Conclusion

This research in progress paper presents the motivation of our research project on the design of attention-aware BI&A dashboards. According to the classification by Gregor & Hevner [40] our research represents an improvement as we address an existing problem (support users to manage their visual attention) by combining eye-tracking devices and BI&A dashboards and providing the design of a new solution (attention-aware BI&A dashboards) [40]. Thereby, the research will contribute to research and practice by providing design knowledge for attention-aware BI&A dashboards. As next steps, we will finalize the design suggestion in the first design cycle and implement an artifact based on it. We will then evaluate this attention-aware BI&A dashboard artifact in a laboratory experiment with respect to the validity of the design as well as the effect on the users’ visual attention. In addition to the research activities planned for this research project, there are further opportunities for future research on this important issue. An attention-aware BI&A system is not limited to a feedback component. Instead, there are further attention-aware interactive elements such as guidance design features [41] to find changes, the provision of real-time explanations when users pay attention to the particular part of graphs, adaptive user interfaces based eye movement data, eye-based interactive information visualization, etc.

References

1. Lee, W., Benbasat, I.: Designing an electronic commerce interface: attention and product memory as elicited by web design. *Electronic Commerce Research and Applications*. 2, 240–253 (2003).
2. Treisman, A.M., Gelade, G.: A feature-integration theory of attention. *Cognitive Psychology*. 12, 97–136 (1980).
3. Johnston, W.A., Dark, V.J.: Selective Attention. *Annual Review of Psychology*. 37, 43–75 (1986).
4. Masciocchi, C.M., Still, J.D.: Alternatives to Eye Tracking for Predicting Stimulus-Driven Attentional Selection Within Interfaces. *Human–Computer Interaction*. 28, 417–441 (2013).
5. Egeth, H., Kahneman, D.: Attention and Effort. *The American Journal of Psychology*. 88, 339 (1975).
6. Vertegaal, R.: Attentive User Interfaces. *Communications of the ACM*. 46, 30 (2003).
7. Bulling, A.: Pervasive Attentive User Interfaces. *Computer*. 49, 94–98 (2016).

8. Yigitbasioglu, O.M., Velcu, O.: A review of dashboards in performance management: Implications for design and research. *International Journal of Accounting Information Systems*. 13, 41–59 (2012).
9. Holzinger, A.: Human-Computer Interaction and Knowledge Discovery (HCI-KDD): What is the benefit of bringing those two fields to work together? In: *Lecture Notes in Computer Science (including subseries Lecture Notes in Artificial Intelligence and Lecture Notes in Bioinformatics)*. pp. 319–328 (2013).
10. Kelton, A.S., Pennington, R.R., Tuttle, B.M.: The Effects of Information Presentation Format on Judgment and Decision Making: A Review of the Information Systems Research. *Journal of Information Systems*. 24, 79–105 (2010).
11. Dilla, W., Janvrin, D.J., Raschke, R.: Interactive Data Visualization: New Directions for Accounting Information Systems Research. *Journal of Information Systems*. 24, 1–37 (2010).
12. Carrasco, M.: Visual attention: The past 25 years. *Vision Research*. 51, 1484–1525 (2011).
13. Bundesen, C.: A theory of visual attention. *Psychology Review*. 97, 523–547 (1990).
14. Koch, C., Ullman, S.: Shifts in Selective Visual Attention: Towards the Underlying Neural Circuitry. In: *Matters of Intelligence*. pp. 115–141. Springer Netherlands, Dordrecht (1987).
15. Simon, H. a.: Designing organizations for an information-rich world. *Computers, communications, and the public interest*. 72, 37 (1971).
16. Orquin, J.L., Mueller Loose, S.: Attention and choice: A review on eye movements in decision making. *Acta Psychologica*. 144, 190–206 (2013).
17. Roda, C., Thomas, J.: Attention aware systems: Theories, applications, and research agenda. *Computers in Human Behavior*. 22, 557–587 (2006).
18. Kowler, E.: Eye movements: The past 25years. *Vision Research*. 51, 1457–1483 (2011).
19. Majaranta, P., Bulling, A.: Eye Tracking and Eye-Based Human–Computer Interaction. In: *Advances in Physiological Computing*. pp. 39–65 (2014).
20. Dimoka, A., Davis, F.D., Pavlou, P.A., Dennis, A.R.: On the Use of Neurophysiological Tools in IS Research : Developing a Research Agenda for NeuroIS. *MIS Quarterly*. 36, 679–702 (2012).
21. Davern, M., Shaft, T., Te'eni, D.: Cognition Matters: Enduring Questions in Cognitive IS Research. *Journal of the Association for Information Systems*. 13, 273–314 (2012).
22. Hevner, A.R., March, S.T., Park, J., Ram, S.: Design science in information systems research. *MIS Quaterly*. 28, 75–105 (2004).
23. Chen, H., Chiang, R.H.L., Storey, V.C.: Business Intelligence and Analytics: From Big Data to Big Impact. *MIS Quarterly*. 36, 1165–1188 (2012).
24. Tegarden, D.P.: Business Information Visualization. *Communications of the AIS*. 1, 1–37 (1999).
25. Watson, H.J.: Tutorial: Big Data Analytics: Concepts, Technologies, and Applications. *Communications of the Association for Information Systems*. 34, 24 (2014).
26. Bylinskii, Z., DeGennaro, E.M., Rajalingham, R., Ruda, H., Zhang, J., Tsotsos, J.K.: Towards the quantitative evaluation of visual attention models. *Vision Research*. 116, 258–268 (2015).
27. Richardson, D.C., Spivey, M.J.: Eye tracking: research areas and applications. *Encyclopedia of Biomaterials and Biomedical Engineering*. 573–582 (2004).
28. Henderson, J.M., Shinkareva, S. V., Wang, J., Luke, S.G., Olejarczyk, J.: Predicting

- Cognitive State from Eye Movements. *PLoS ONE*. 8, (2013).
29. Duchowski, A.T.: A breadth-first survey of eye-tracking applications. *Behavior Research Methods, Instruments, & Computers*. 34, 455–470 (2002).
 30. Roda, C.: Human attention and its implications for human–computer interaction. *Human Attention in Digital Environments*. 11–62 (2011).
 31. Mack, A., Rock, I.: *Inattention blindness*. MIT Press Cambridge. (1998).
 32. Simons, D.J., Rensink, R.A.: Change blindness: past, present, and future. *Trends in Cognitive Sciences*. 9, 16–20 (2005).
 33. Rensink, R.A., O’Regan, J.K., Clark, J.J.: To See or not to See: The Need for Attention to Perceive Changes in Scenes. *Psychological Science*. 8, 368–373 (1997).
 34. Rensink, R.: Change detection. *Annual Review of Psychology*. 53, 245–277 (2002).
 35. Kuechler, B., Vaishnavi, V.: On theory development in design science research: anatomy of a research project. *European Journal of Information Systems*. 17, 489–504 (2008).
 36. Sharp, H., Rogers, Y., Preece, J.: *Interaction Design: Beyond Human-Computer Interaction*. (2002).
 37. Buscher, G., Dengel, A., Biedert, R., van Elst, L.: Attentive Documents: Eye Tracking as Implicit Feedback for Information Retrieval and Beyond. *ACM Transactions on Intelligent Interactive Systems (TIIS)*. 1, 9:1-9:30 (2012).
 38. J.Browne, G., Parsons, J.: More Enduring Questions in Cognitive IS Research. *Journal of the Association for Information Systems*. 13, 1000–1011 (2012).
 39. Nielsen, J.: Noncommand user interfaces. *Communications of the ACM*. 36, 83–99 (1993).
 40. Gregor, S., Hevner, A.R.: Positioning and Presenting Design Science Research for Maximum Impact. *MIS Quarterly*. 37, 337–355 (2013).
 41. Morana, S., Schacht, S., Scherp, A., Maedche, A.: A review of the nature and effects of guidance design features. *Decision Support Systems*. (2017).

Towards a Reference Model for Data Management in the Digital Economy

Tobias Pentek¹, Christine Legner², Boris Otto³

¹ University of St. Gallen, Switzerland

tobias.pentek@student.unisg.ch

² University of Lausanne, Faculty of Business and Economics (HEC), Switzerland

christine.legner@unil.ch

³ TU Dortmund University, Germany

boris.otto@tu-dortmund.de

Abstract. The digital and data-driven economy requires enterprises from all industries to revisit their existing data management approaches. To address the changing and broader scope of data management activities in the digital economy, this research in progress paper proposes a reference model, that describes the design areas of data management.

Keywords: Data management · Reference model · Data governance · Data architecture · Master data · Big data

1 Introduction

In recent years, the digitalization of processes and the digital transformation of business models has altered many industries, and data is regarded as a key resource for companies enabling new products and services [1]. For example, Industry 4.0 scenarios in the manufacturing industry are transforming logistics and production processes. In the future, a smart product will steer itself through the production process, order transportation services, and inform the manufacturing stations about the required assembly steps [2]. For fulfilling this vision, data from multiple sources and sensors need to be gathered, aggregated, maintained, enriched, and provided.

Understanding data as a strategic and valuable resource is a change for corporations and requires them to broaden the scope, challenge existing practices, and refine current approaches of data management. Traditionally, data management comprises “policies, practices and projects that acquire, control, protect, deliver and enhance the value of data and information” [3]. To guide practitioners in the implementation and conduction of data management, a number of data management frameworks and reference models has been suggested. However, these have been designed in the 1990s and 2000s, and it is unclear whether they address the requirements of the digital and data-driven economy.

Following the design research paradigm, this paper identifies requirements and proposes a reference model for effective data management in the digital and data-driven

economy. In accordance with Fettke and Loos [4], this reference model describes solution patterns for data management professionals and researchers and provides recommendations for conducting effective data management. It has been developed based on a systematic action design research (ADR) approach in a joint effort with more than 15 European companies and researchers from three universities. The paper reports on the structure and design areas of the reference model as well as on the first evaluation results.

2 Background

Data Management

Data management aims at the efficient usage of data in companies [5]. Academic literature has traditionally elaborated on the role and importance of data assets as well as on data quality. It comprises all management tasks of the data lifecycle on a strategic, governing, and technical level [6]. Data management includes the formulation of a data strategy [7], the definition of data management processes, standards, and measures, the assignment of roles and responsibilities [8], the description of the data lifecycle and architecture – covering data models and data modeling standards – [9], and the management of applications and systems [10].

To guide practitioners in the implementation of data management, various data management frameworks and reference models have been suggested. These include contributions from consortia – such as the DAMA-DMBOK Functional Framework [11], the CDQ Framework [12], and the DGI Data Governance Framework [13] –, from consulting firms – including Capgemini [14], Gartner [15], Forrester [16], and Infosys [17] –, from software vendors – like Oracle [18], IBM [19], Informatica [20], and SAS [21] –, and with GS1 [22] from a standardization body. The majority of these frameworks as well as a large number of research considers the provision of high quality data as the most important goal of data management [23].

Research Gap: Data Management in the Digital Economy

Data is the key resource of companies in the digital economy. The term “digital economy” considers the digitalization of processes and the digital transformation of business models in corporations as well as the digitalization of the society [24]. It covers various trends such as Industrie 4.0, the Internet of Things (IoT), and Big Data and is mainly driven by technological advances, which led to falling prices for sensors and cheaper and faster processing of data. While data is considered a key concern in digitalization initiatives, the advances of data management are still limited. The majority of existing data management frameworks has a narrow scope and focuses on the quality of master data from company-internal sources. However, with the growing importance of data in the digital economy, data managers are challenged by additional requirements to fulfill compliance, privacy, and security concerns in their activities and to include further data types such as streaming data or data from external sources. There are first publications to address these aspects, such as data management for big data [25–27]. Nevertheless,

to the best of our knowledge, a comprehensive reference model providing guidance to data managers and researchers in the context of the digital economy does not exist. Our research addresses this gap by answering the following research question: How to design data management for the digital and data-driven economy?

3 Research Approach

Our research aims at developing a reference model that outlines the main design areas to be addressed by companies to effectively manage data as corporate resource. A reference model specifies the generally valid elements of a system that can serve as a reference for designing company-specific models [4]. Our research objectives thereby consist of developing prescriptive knowledge as described by Gregor’s [28] type V theory and constructing information system-related problem solutions. The emerging artefact has been designed in a consortium research program [29] since February 2016, following ADR. ADR combines design science research (DSR) and action research (AR) and constitutes “a research method for generating prescriptive design knowledge through building and evaluating ensemble IT artifacts in an organizational setting” [30]. Senior data management professionals from more than 15 European enterprises in various industries and researchers from three academic institutions have contributed to the artifact over a period of more than twelve months. After an initial discussion about the need for a reference model at a consortium workshop in February 2016, the requirements and the emerging reference model were discussed and evaluated at five consortium workshops between April 2016 and February 2017. **Fig. 1** provides an overview of the four main stages of ADR, which are described in the following.

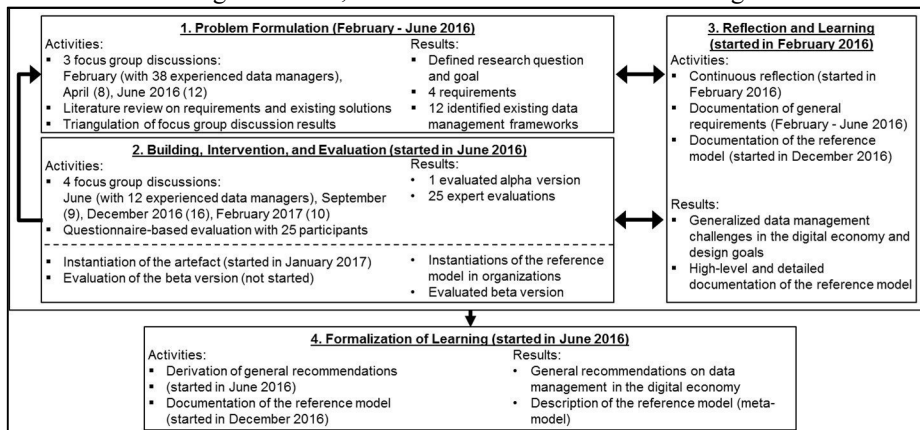

Fig. 1. Adopted ADR Process on the Basis of Sein et al. [30]

Problem formulation: The research activities were initiated by experienced data managers in the consortium research program. Although these data managers were using established data management frameworks, they were lacking guidance for facing the new data-related challenges in the digital economy. Based on this call for action,

the specific requirements as well as existing solutions were discussed during consortium workshops in three focus groups in February (with 38 experienced data managers), April (8), and June 2016 (12). The discussion results were documented and triangulated with scientific publications by the researchers.

Building, intervention, and evaluation (BIE) includes two cycles. As suggested by Sein et al. [30], the first BIE cycle aims at developing an early alpha version of the artefact, which is a stable version that will be instantiated, repeatedly tested, and continuously refined in the second cycle. In the first cycle, the emerging artefact was repeatedly discussed and refined by practitioners in four focus groups during consortium workshops in June (with twelve experienced data managers), September (9), December 2016 (16), and February 2017 (10). Each of the four sessions lasted two hours, was moderated by the same researcher and observed by a second researcher. The discussion results were documented and formed the basis for further adjustments of the artefact. The first three focus group sessions focused on the structure, design areas, content, and naming of the reference model, while the last session concentrated on the graphical visualization. Section 4 outlines the resulting alpha version of the artefact. In addition to evaluations in focus groups discussions, we conducted a questionnaire-based evaluation in December 2016. The results are presented in section 5. In the second BIE cycle, we are instantiating the artifact in selected companies. Based on the interventions and evaluations from these cases, a final beta version of the artefact will be developed. The research team has initiated the activities of this cycle and we are currently applying the reference model in several companies.

Reflection and learning is conducted in parallel to the first two stages. It includes the continuous reflection on the design and redesign of the artefact as well as the documentation of requirements and the detailed descriptions of the reference model and its design areas.

Formalization of learning ensures that learnings from company-specific instantiations are further developed and documented as general solutions. In addition to general recommendations on data management in the digital economy, we are preparing a formal description of the reference model in the form of a meta-model.

4 The Data Excellence Model – Reference Model for Data Management in the Digital Economy

4.1 Purpose and Requirements

The reference model aims at structuring the main design areas of effective data management, while – at the same time – addressing the requirements of the digital and data-driven economy. These requirements have been derived from the focus groups and are supported by literature. They are summarized in **Fehler! Verweisquelle konnte nicht gefunden werden.** Data are business-critical in the digital economy. Identifying and addressing data needs of the business requires – apart from technical capabilities – close alignment between data management and the business as the consumer of data-driven insights (R1) [31]. R2 refers to the growing number of digital services for business and

private purposes – such as smart factories, smart products or social media – that increases the number of data sources and the volume of data available. For making use of big data and generating data-driven insights, data management needs to expand its traditional scope on master and transactional data to include further data types – like meta, analytical, or sensor data [32]. R3 is motivated by the high portion of compliance-, privacy-, and security-critical data created in the digital economy [33]. Consequently, not only data quality but also these further aspects have to be taken into account by data managers. Finally, as the importance and scope of data management grow in the light of the digital economy, investments are required. To justify these investments, the value generated by data and the contribution of data management to the business activities need to be transparent (R4).

Table 1. Requirements of the Digital Economy on Data Management

Requirement	Description	Design Decision
R1: Address the increasing business criticality of data	Identification of business-critical data needs	Introduce the “goals” that translate business capabilities into data management capabilities
R2: Manage data from different sources and for different purposes	Inclusion of further data sources and types (e.g. meta, analytical, or sensor data) in addition to master and transactional data	Introduce data lifecycle as “enabler” and implicitly address further data types in all other “enablers”
R3: Address relevant data-related concerns	Focus on data compliance, data privacy and security in addition to data quality	Introduce data excellence as “result” of data management that covers quality, compliance, privacy, and security
R4: Demonstrate the value contribution of data management to business	Transparency about the value contribution of data management to the business	Introduce business value as “result” of data excellence contributing to processes, customers, financials, learning and growth

Model Overview

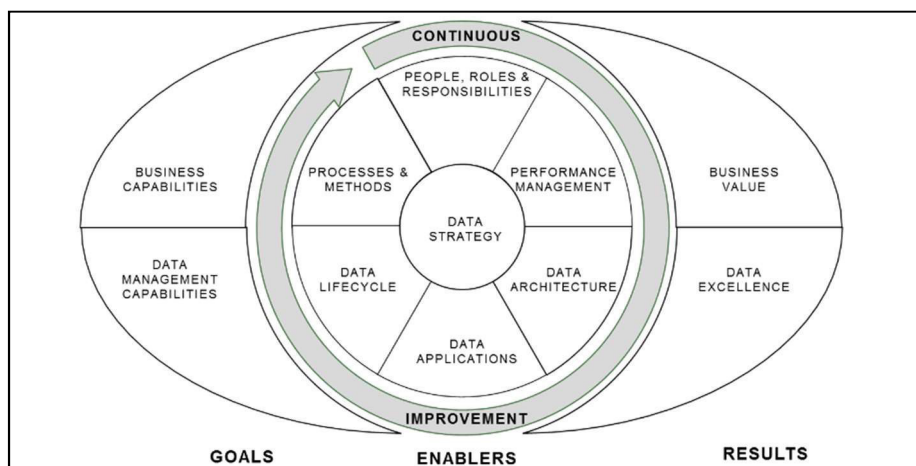

Fig. 2. Reference Model for Data Management in the Digital Economy

The first BIE cycle resulted in an alpha version of the reference model for data management in the digital and data-driven economy. **Fehler! Verweisquelle konnte nicht gefunden werden.** depicts this version. The descriptions of the design areas are detailed in **Fehler! Verweisquelle konnte nicht gefunden werden.**

4.2 Structure of the Reference Model

Given the understanding of data as a strategic resource for the digital economy, the structure of the reference model builds on existing work from performance management, which measures, controls, and communicates indicators to improve the organizational achievement of objectives [34]. Performance management approaches consider a continuous management cycle with four phases, which are often referred to as plan, do, check, act. The reference model reflects this. It organizes design areas for data management in three categories – **goals**, **enablers**, and **results** – that are interlinked in a **continuous improvement** cycle. Goals define the strategic direction for data management. Enablers facilitate the goals. Results measure the achievement of the goals. Improvement emphasizes the dynamic nature of the model, indicating a process to adjust the goals and improve the enablers.

Design Areas

As a starting point for defining the design areas of the reference model, we reviewed the elements of existing data management models (cf. [11–22]) and data management literature. This review identified the following most common design areas of data management that we consider as “enablers”: data strategy, performance management, organization, processes and methods, data architecture, and data management applications [35]. These design areas were confirmed as highly relevant by the data managers in the consortium research program. However, in order to address the requirements of the digital economy (see **Fehler! Verweisquelle konnte nicht gefunden werden.**), we consider – based on the practitioners’ input – five further design areas. For ensuring the alignment of data management with the business (R1), we introduced capabilities in the goals section of the model. Capabilities describe what a company does or it should be doing [36]. By first reviewing “business capabilities” and, then, identifying the required “data management capabilities”, data managers are able to directly align with the business. For the new data types introduced by digitalization (R2), we realized that they influence almost all other design areas. However, we added “data lifecycle” as an additional enabler to reflect the involved data managers’ need for documenting and reviewing sources, operational activities, consumers, and purposes of data. The outcomes of data management are twofold. First, data management has a direct impact on data itself, defined as “data excellence” in the reference model. These data-related results consider data quality levels as well as the fulfillment of data compliance, data security, or data privacy requests (R3). Second, data excellence contributes to creating value to

the business (R4). The “business value” design area reflects this. In line with the dimensions of the Balanced Scorecard [37], the impact of data management on the company’s financials, business processes, customers, and growth potential is reviewed.

Table 2. Descriptions of the Design Areas

Design Area	Description
Business Capabilities	are sets of skills, routines, and resources a company needs to have in order to achieve business objectives.
Data Management Capabilities	are sets of skills, routines, and resources a company needs to have in order to support business capabilities through data management.
Data Strategy	defines the scope and objectives of data management and specifies the roadmap for providing the data management capabilities required.
People, Roles and Responsibilities	defines the skills and organization to ensure effective data management and consistent use of data across the entire organization.
Performance Management	defines the measures to monitor and control the performance (i.e., progress and outcome) of data management with the help of a key performance indicator system.
Processes and Methods	defines procedures and standards for managing and using data properly and consistently.
Data Architecture	defines the conceptual data model, specifies which data is stored in which application, and describes how data flows between applications.
Data Lifecycle	defines data objects and documents, and reviews data sources, operational data activities (i.e., ranging from data acquisition and creation to data archiving), data consumers, and data use contexts.
Data Applications	defines the software components supporting data management activities.
Data Excellence	refers to the impact of data management on the data itself, first and foremost with regard to data quality (defined as “fitness for purpose”), but also with regard to additional data related aspects, such as data compliance, data security and privacy.
Business Value	refers to the impact of data management on business with regard to financials, business processes, customers, and organizational growth.

5 Evaluation

For evaluating the alpha version of the artifact, we conducted a questionnaire-based evaluation following the criteria presented by Prat et al. [38]. 25 experienced data managers participated in the survey, which comprised 24 five-point Likert-scale and seven open questions. After a presentation of the reference model, participants were asked to evaluate the structure (i.e. the completeness, simplicity, clarity, style, homomorphism, level of detail, consistency), the adaptability (i.e. robustness, learning capability), and the environmental fit (i.e. personal and organizational utility, understandability, organizational fit) of the reference model for data management in the digital economy. Overall, 86 percent of the respondents confirmed that the reference model is useful for their data management activities. On a more detailed level, 88 percent regard the reference model as complete (i.e. it covers all relevant areas), 83 percent agreed that the model depicts the reality of data management, and 80 percent regard it as robust enough to reflect future changes in the environment of data management.

First instantiations also confirm the utility of the artefact. For example, we applied the reference model for developing a data management strategy for a European-based healthcare company by first discussing the strategic objectives of the company, identifying required business capabilities, and deriving the necessary data management capabilities. We, then, reviewed the status of the six enablers, developed a target state for every design area of the enablers, and defined data excellence and business value metrics to measure and control the progress and performance of data management.

6 Conclusion and Outlook to Further Work

The paper presents a reference model for data management in the digital economy that was systematically developed in the four stages proposed by ADR. The emerging artefact provides a reference for structuring, reviewing, and establishing the design areas of data management. The evaluation of the alpha version of the artifact as well as first instantiations have demonstrated its utility. Limitations of the artefact stem from the consortium program as the research context. This program comprises only companies with a European origin. Furthermore, the data management activities of these companies have generally a high maturity and the participants share a common understanding of data management through a longtime membership in the program and frequent interactions on five workshops per year.

Further research activities are currently ongoing to instantiate the artifact in further companies and refine the reference model in the second BIE cycle. Planned results of these research activities include instantiations as well as more detailed descriptions of the scope and deliverables for every design area. To the best of our knowledge, the presented reference model is one of the first systematic approaches to extend data management in order to cover the requirements of the digital and data-driven economy.

References

1. Otto B, Auer S, Cirullies J et al. (2013) Industrial Data Space: Digital Sovereignty Over Data. Fraunhofer-Gesellschaft
2. Kagermann H, Wahlster W, Helbig J (2013) Recommendations on implementing the strategic initiative Industrie 4.0: Final report
3. Mosley M, Brackett M, Earley S et al. (2009) The DAMA Guide to the Data Management Body of Knowledge (DAMA-DMBOK guide), First edition
4. Fettke P, Loos P (eds) (2007) Reference Modeling for Business Systems Analysis. IGI Global
5. Wang RY (1998) A Product Perspective on Total Data Quality Management. *Communications of the ACM* 41(2): 58–65
6. Otto B (2011) Quality Management of Corporate Data Assets. In: Praeg C-P, Spath D (eds) *Quality Management for IT Services*. IGI Global, pp 193–209
7. Falge C, Otto B, Österle H (2013) Towards a Strategy Design Method for Corporate Data Quality Management. In: *Proceedings of the 11th International Conference on Wirtschaftsinformatik*, pp 801–815

8. van den Hoven J (1999) Information Resource Management: Stewards of Data. *Information Systems Management* 16(1): 88–90
9. Ofner MH, Straub K, Otto B et al. (2013) Management of the master data lifecycle: A framework for analysis. *Journal of Ent Info Management* 26(4): 472–491
10. Otto B, Hüner KM, Österle H (2012) Toward a functional reference model for master data quality management. *Inf Syst E-Bus Manage* 10(3): 395–425
11. Mosley M (2008) DAMA-DMBOK Functional Framework: Version 3.02
12. Otto B, Österle H (2016) *Corporate Data Quality: Prerequisite for Successful Business Models*. Springer Berlin Heidelberg, Berlin, Heidelberg
13. Thomas G (2014) *The DGI Data Governance Framework*
14. Capgemini (2010) *Data Governance & Stewardship*
15. Radcliffe J (2007) *The Seven Building Blocks of MDM: A Framework for Success*
16. Yuhanna N, Leganza G, Karel R et al. (2011) *Forrester's Data Management Reference Architecture: Align Data Management Roles To Create Stronger Business Value*
17. Sivaprakasam SR (2010) *Enterprise Data Management Approach: A Comprehensive Data Approach for CSPs*
18. Sun H, Xu S (2012) *Oracle Enterprise Architecture Framework: Information Architecture Domain*
19. IBM Corporation (2007) *The IBM Data Governance Council Maturity Model: Building a roadmap for effective data governance*
20. Informatica (2013) *Holistic Data Governance: A Framework for Competitive Advantage*
21. SAS (2014) *The SAS Data Governance Framework: A Blueprint for Success*
22. GS1 (2010) *GS1 Data Quality Framework: Version 3.0*
23. Batini C, Cappiello C, Francalanci C et al. (2009) Methodologies for data quality assessment and improvement. *ACM Comput. Surv.* 41(3): 1–52
24. Matt C, Hess T, Benlian A (2015) Digital Transformation Strategies. *Bus Inf Syst Eng* 57(5): 339–343
25. Chen J, Chen Y, Du X et al. (2013) Big data challenge: A data management perspective. *Front. Comput. Sci.* 7(2): 157–164
26. Atul S, Desale Girish B, Patil Swati P (2017) Big Data and Big Data Management (BDM) with current Technologies –Review. *IJERA* 07(04): 42–44
27. Chen H, Chiang RHL, Storey VC (2012) Business Intelligence and Analytics: From Big Data to Big Impact. *MIS Quarterly* 36(4): 1165–1188
28. Gregor S (2006) The Nature of Theory in Information Systems. *MIS Quarterly* 30(3): 611–642
29. Österle H, Otto B (2010) Consortium Research: A Method for Researcher-Practitioner Collaboration in Design-Oriented IS Research. *Bus Inf Syst Eng* 2(5): 283–293
30. Sein MK, Henfridsson O, Purao S et al. (2011) Action Design Research. *MIS Quarterly* 35(1): 37–56
31. Proper H, Lankhorst MM (2014) Enterprise Architecture: Towards essential sensemaking. *Enterprise Modelling and Information Systems Architectures* 9(1): 5–21
32. Lee YW, Madnick, Stuart E. et al. (2014) A Cubic Framework for the Chief Data Officer: Succeeding in a World of Big Data. *MIS Quarterly Executive* 13(1): 1–13
33. Sadeghi A-R, Wachsmann C, Waidner M (2015) Security and privacy challenges in industrial internet of things. In: *Proceedings of the 52nd Design Automation Conference*, pp 1–6
34. Fischer TM, Möller K, Schultze W (2012) *Controlling*. Schäffer-Poeschel, Stuttgart
35. Labadie C, Legner C *Overview of Data Management Frameworks*
36. Bērziša S, Bravos G, Gonzalez TC et al. (2015) Capability Driven Development: An Approach to Designing Digital Enterprises. *Bus Inf Syst Eng* 57(1): 15–25

37. Kaplan RS, Norton DP (1996) *The balanced scorecard: Translating strategy into action*. Harvard Business Review Press, Boston
38. Prat N, Comyn-Wattiau I, Akoka J (2015) A Taxonomy of Evaluation Methods for Information Systems Artifacts. *Journal of Management Information Systems* 32(3): 229–267

Design Science Research for Holistic Climate Services

Jaakko Helminen¹ and Erkki Sutinen¹

¹Department of Information Technology, University of Turku, Finland
{jaakko.a.helminen; erkki.sutinen}@utu.fi

Abstract. The innovated fitness-utility Systems Design Research (SDR) model is generalized from the Extended Action Design Research (EADR) model and discussed in terms of the Design Science Research (DSR) framework. In the context of SDR as well as the recent Paris Agreement, the 2030 Agenda for Sustainable Development and the Agenda for Humanity the challenges of holistic climate services are discussed. As an application of the trans-disciplinary SDR holistic grass-root mobile climate services are developed for local farmers in communities of an African developing country.

Keywords: Design science research · Fitness-utility model · Trans-disciplinary systems · Holistic climate services

1 Introduction

In the discussed research in progress we are concerned with obvious demands for designing holistic grass-root mobile climate services (HGMCSs) to empower local farmers in communities of an African developing country to cope with the changing climate. The services are critical because traditional tacit knowledge no more works. The task includes increased awareness of climate impacts and the improvement of our trans-disciplinary baselines to meet them. In concert with the recent Paris Agreement (PA) [1], Transforming our world: the 2030 Agenda for Sustainable Development (ASD) [2], Agenda for Humanity (AH) [3] and Natural Disasters and Climate Change: Managing Risks & Crises Differently (NDCC) [4] our effort is to get a holistic view included in climate services and our prototype HGMCSs landed for active use and further participatory development by local farmers. The subjective demand, not only the objective need for HGMCSs became apparent during our several pilot studies since 2011 in different grass-roots level contexts in Africa.

The four references [1-4] mentioned above give an overall view of the current situation of the global leadership in climate change issues. Formerly UN Framework Convention on Climate Change (UNFCCC) with its Conferences of Parties (COPs) kept the leading role in climate change issues by global agreements on climate change, like the Kyoto Protocol of 1997 and PA.

Recently the UN General Assembly has released as its resolution the ASD. This agenda includes nineteen Goals of Sustainable Development with Goal 13 “Take urgent action to combat climate change and its impacts”. ASD presents the social, economic, and environmental dimensions as the three dimensions of the sustainable development.

ASD integrates them, climate included, fully in a coherent, holistic, comprehensive and balanced way.

The Secretary-General of UN released AH in the World Humanitarian Summit (WHS) in 2016 in Istanbul. In addition WHS released also NDCC, in which the Core Commitment 1 repeated the urgency of ASD Goal 13.

As a consequence of the actions mentioned above UN has taken the global leadership in integrating the issues of climate change and its impacts into ASD and AH.

Regarding the climate change and its impacts PA gives to us recommendations how we can contribute to limit and to stop the human-induced climate change to a bearable extent. In changes of climate impacts we focus on two changes in climate, on changes in extreme values and on changes in climate variability. These are the aspects, which impact most directly the baselines of the societies.

One crucial question to accomplish sustainable development is to achieve a climate with stable mean values and stable variability. For design science SDR with its artifacts offers one possibility to contribute to the development of sustainable holistic climate services.

As the needed Design Science Research (DSR) [5] tool we present and discuss the setup, the stages and the objectives of the Systems Design Research (SDR) fitness-utility model, which is a generalization of the Extended Action Design Research (EADR) model by Mullarkey and Hevner [6]. In the same context, we introduce the Epistemic Implementation Delphi (EID) model with its stages as the design artifact of SDR. Finally, we outline some prospects of SDR and conclude our presentation.

2 Systems Design Research

We develop SDR to study several concurrently interacting systems. In fig. 1 we present the stages of our Systems Design Research (SDR) fitness-utility model on the continuum of the entry point chain of our trans-disciplinary Epistemic Implementation Delphi (EID) model.

The stages of SDR resemble the stages of EADR. However, in the first left-hand box we have replaced motivation by encountering, which in the case of developing countries means that the primary idea of the project should come up from the local grass-root discussions and preferably from local farmers. More generally the primary idea of the project should be presented by the end-users. The inclusion of end-users as experts of their own condition is complementary if not contradictory to conventional development projects where the motivation to set up a project is based on needs that are usually explicated by external experts.

Concurrently during the encountering, we search competent members to SDR completion team primarily from the local community and from local pertinent expert institutes. The role of outside supervisor parties, like representatives of foreign development aid should be relatively strong at the beginning of the project and decrease during the participatory working phase.

It is important to recognize that the epistemic base of EID is the General Theory of Consistency (GTC) [7]. According to GTC the local population participating to the

project experiment on grass-root level is divided into two groups: not-learning beings, who trust on the use of traditional tacit knowledge, and learning beings, who are willing to learn and use advised modern methods.

In the second box from the left the chosen EID expert team looks for possible rational artifacts during the opening stage and leaves them all available for the process. In case of considerable uncertainties, like in the development of HGMCSs, EID expert team together with SDR completion team determines the criteria of a sufficient solution in terms of both utility and fitness.

At the design and development stage of SDR the expert team of EID elaborates further the action lines as rational artifacts. This takes place at the opening and especially the argumentation stage of EID. It is important that the elaborated artifacts as different versions of the developed climate services are kept separate from each other. The outcome of the design and development stage of SDR is one artifact recommended by EID expert team to be implemented in the demonstration stage by EID management team.

The completion team of SDR together with the expert and management teams of EID evaluates the implemented artifact to check, whether this artifact meets the utility and fitness criteria of sufficiency. If so, then the concluding stage of EID is accomplished and SDR proceeds to the communication stage. In case the outcome of the implemented artifact is not sufficient, the completion team of SDR returns the process back to the design and development stage to pick up the artifact option next on the recommendation list for implementation. This iteration is executed in as many loops as needed to find a sufficient outcome or all available artifacts being scrutinized. Thereafter SDR completes the communication stage with appropriate scholarly and professional publications.

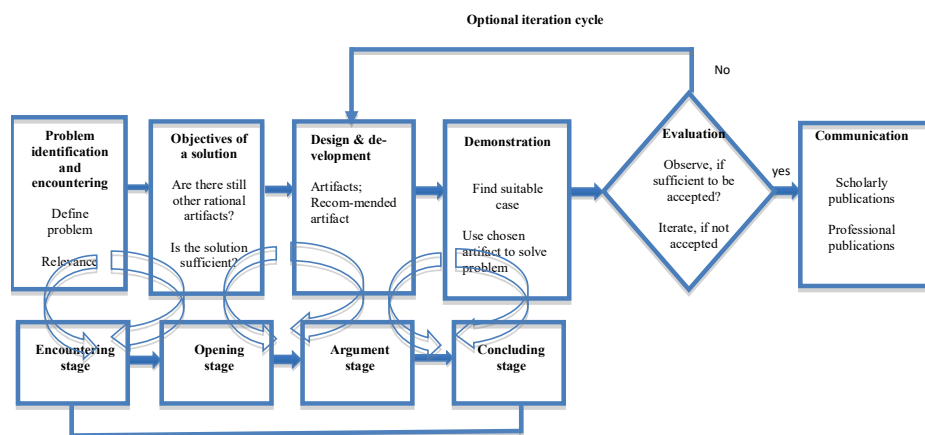

Fig. 1. Allocating the stages of SDR on the research entry point chain of EID (adapted from [6]).

3 Design Science Research

Next, we discuss SDR in terms of DSR framework [5] depicted in fig. 2. Where appropriate we focus our discussion on our particular application of SDR in the development of HGMCSs for local farmers in communities of an African developing country.

Environment. We start with the environment and in it with people. In our coming prototype project, we have three groups of people: the local farmers of the communities (LCG), the various kinds of local experts extending from the community to the national level (LNG), and the supervisors from the foreign development aid party (SFG).

Ideally the first encountering should take place by a meeting of LNG and SFG, when a letter of intent has been sent or preliminary discussions of intention on a joint SDR project have taken place. The expertise of LNG should include scientific experts on relevant invariances and experts on local social aspects and human behavior, decision makers with the authority to allocate needed local resources as well as funding, and synthesizers with the overall vision to become supervisors. Compared with LNG, the composition of SFG should rather be experts on decision-making issues and have the needed backup in funding issues. The outcome of this meeting should be a draft of the project agreement, the mutual written understanding of the joint objectives and commitments, and the written consent of the right to archive and use the compiled video-recorded interviews as well as other collected data.

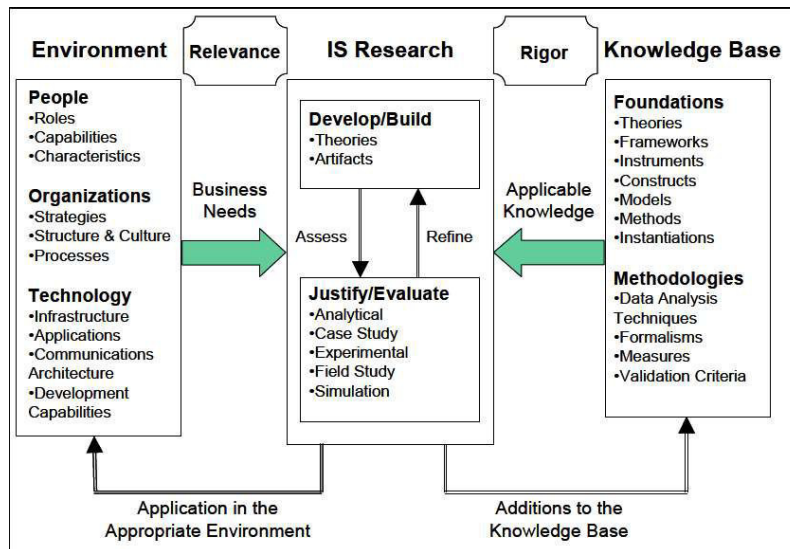

Fig. 2. Design Science Research Framework [5].

Early prior to the expected rain season LCG not-learning and learning groups of the participating communities should together make overall crop cultivation plans, where every community decides the cultivated crop species, the tilling method, and the possibly used fertilizer, pesticide or plant disease control agent. During this planning, the

local farmers consult the needed national expert institutes, like the national institute of agricultural research as well as the national meteorological and hydrological institute, in order to get advice on proper crop selection, expected precipitation, risk for draughts, floods, pests, and plant diseases for the coming rain season. Co-designing the services need to be closely tied to the planning activities.

After the overall cultivation plans are ready the local decision-makers plan the allocation of the needed separate experiment parcels for the not-learning and the learning farmers on a fair basis including also the access to eventual irrigation. The crop yields of the parcels are compared under the assumption that both groups have equal access to the information disseminated by HGMCSs. As our approach is holistic we cannot limit our scope just to develop technically appropriate trans-disciplinary climate services and compare their effects. In developing countries, we have several other factors affecting significantly the crop yield, like the use of quality seeds, fertilizers, pesticides, plant disease control agents as well as of modern tilling methods. The local experts need to consider, which of these factors need to be included explicitly in our field experiments in the form of additional parcels so that we can convincingly demonstrate the sufficient success of the developed HGMCSs.

All human-driven activities presented above tie the people, pertinent organizations and technologies to joint business needs, which are elaborated further under the develop/build and justify/evaluate phases of the trans-disciplinary DSR. The objective of these efforts is to develop beneficial local HGMCSs and to take place under SDR steered EID actions.

Knowledge Base. We introduced SDR combined with EID as a fitness-utility model [8]. It is our contribution to the knowledge base.

Regarding the fitness of our model we assess it in terms of the fitness definition #2 [8]. With HGMCSs and holistic views in mind we need to take into account pertinent aspects of human and social behavior. Here an essential part of the collected data consists of compiled and video-recorded interviews, including especially those from the co-design process. As guidance for the interviews we use the set of twelve questions of the Critical Systems Heuristics (CSH) [9], which in our application concern boundary judgments of particular HGMCSs. The consideration of boundary judgments and the possible extension of the boundaries of our design space stand both for an opportunity and a necessity in the development of HGMCSs. All in all, this makes our fitness considerations an exciting and demanding challenge where experience and resilience are needed.

In the context of our design artifact EID the utility has to cover two aspects, the metric utility for measurable quantities, like crop yield, and the epistemic utility for assessed qualities, like motivation. To build the metric utility function is a straightforward objective matter, whereas the epistemic utility is a different issue and involves subjective evaluations. As a first trial, we form an epistemic utility function by dichotomizing the observations on a one step scale from zero to five as follows: 0 = cannot be assessed, 1 = very poor, 2 = moderately poor, 3 = medium, 4 = moderately good, and 5 = very good. One more sophisticated way to assess the epistemic utility would process the original transcribed video-recorded interviews by applying the Computer Aided

Qualitative Data Analysis Service (CAQDAS) [10] with the Transana qualitative analysis software for text, audio and video data [11] to help us to explore the design space and to find new aspects in it.

The nine first questions of CSH apply to those, who use and develop HGMCSs and are involved in the process. The first three questions are on motivation, the next three on control and questions seven to nine on knowledge. The last three questions concern those affected by the process, like neighboring communities, and are on legitimacy. The interviewer presents the questions both in the form “ought to be” and “is/are”, the former pointing to the future and the latter to the presence. According to Ulrich and Reynolds [9] it is easier to start the interview with the “ought to be” questions, which allow the interviewee to respond by future wishes. Thereafter the “is/are” questions on the present situation become easier for the interviewee to answer. For newcomer CSH interviewers Ulrich and Reynolds [9] have recommended an order to present the questions. However, the questions are independent and can be presented in the order an experienced interviewer finds appropriate for a particular interview. As Ulrich [12] pointed out the quest for competence in CSH is a life-long learning process.

With the observed changes of climate and climate variability we recognized that our representative climate records were short. Therefore, our current climate records include considerable uncertainties in the epistemic meaning of the word. Then reliable risk estimates by statistical methods are not possible to make. In addition, in developing countries data records of other pertinent disciplines, like agriculture, are at their best sporadic and inhomogeneous. All in all, classical statistical methods cannot be applied. In concert with this we include CSH into our fitness-utility model. In addition, we will take into account advances in heuristics [13].

IS Research and the Design Cycle. With reference to the first framework Systems Design Research we discuss here only the box on justify/evaluate.

After having accomplished and submitted our article on the theory and artifacts of SDR, EID and CSH we implement a field experiment in some representative communities of an African developing country in Ethiopia or in Kenya as a prototype case study of our fitness-utility model. We start this by building our preliminary plan for the first encountering meeting, which we hope to take in the African host country in summer 2017.

At the first encountering meeting, we need to establish the core network of the joint project and ascertain our mutual engagement to it. In addition, the needed prior capacity building of local focal persons and students as well as practical arrangements for the whole period of the project need to be discussed, agreed and delegated in a truly participatory manner. Already from the beginning we need a convincing local commitment to the project and the development of HGMCSs so that by the end of the project its ownership is in active and firm local hands for further development. This means also that we have to ensure that our joint undertaking has the local funding for the needed operative expenses and sustainable development. We, the representatives of the foreign development aid funding, make clear our role as kicking off the development of HGMCSs to support local sustainable development in terms of improved crop cultivation and food security.

One crucial issue throughout our project is communication. Not to underestimate the role of the publications smooth, open and pertinent communication is a fundamental part of our project. In local practice this means that HGMCSs information must be disseminated also in forms, which illiterate community members can understand and make use of. However, our emphasis on co-designing the services means that every participant is involved even in the agile prototype design process, which requires learning communication within the highly heterogeneous co-design team.

After the survey of the existing IT networks the needed supplements are designed and established prior to the field experiments.

The local languages pose another interesting challenge. First of all, we need a sufficient number of interpreters (local language – English – local language), like local students, for CSH guided interviews and also to transcribe these interviews both in local language and in translated English. This is important for the reason that the correspondence between the answer in local language and its English translation is never one-to-one as the evolution of any language takes into account the local culture and habits, which are partly baked into the used expressions. These features are of importance in the context of epistemic assessments to extend our design space. The quest for common understanding is not limited to human languages, but will also cover more artificial languages, for the co-design team to control the technology.

One important item to be discussed at the first encountering meeting is the evaluation of our fitness-utility model and the project in terms of HGMCSs. This evaluation covers three aspects, namely the holistic, the metric and the epistemic evaluations. They all focus on the benefit, feasibility, validity, relevancy, and fitness of the model and the project.

The metric evaluation is based on variables with measurable quantities, like crop yield, cost of tilling, cost of fertilizers etc. With their values, we can determine the profit gained by the experiment parcel under consideration. The obtained profit numbers give one view on the considered evaluation qualities and especially on the benefits, which are of fundamental importance under conditions of poverty or nearby poverty. However, we need to keep in mind that the profit numbers alone give a limited scope of the synthesized view in the holistic context.

The epistemic evaluations of qualities like motive, truthlikeness, trust and willingness to participatory cooperation give us wider understanding to form the synthesized view on the sufficiency of the developed HGMCSs. Here we should keep ourselves to conclusions based on the primary projecting results as the dichotomized data is at least partly prone to subjective judgments and to possible biases associated with heuristics.

As pointed out by Gill and Hevner [8] in the context of a fitness-utility model the assessment of its fitness is a demanding task. Here we have at least three opportunities, by which we can have an influence on improved fitness of our model. The first option is the communication box of SDR. At least we could focus some of the publications in both categories to fitness related items so that the readers could become convinced of the benefits of our holistic model. The second option lies in the environment column of the DSR framework in various organizations of at least regional coverage. In the African context, we could proceed on this path up to the African Union. The third option is the needed landing of the recent global agreements and agendas [1-4] down to the grass-

root level as well as the associated need for synthesized views and messages. All in all, by doing our own job well we can let the publicity work for the fitness of our model.

4 Future Prospects of SDR

The impetus to innovate SDR was in our case the need to develop HGMCSs and to demonstrate the feasibility of our idea. Even if we still are in the midst of the task we are with our earlier experience already confident that we can reach sufficient outcomes. In addition, we can see that SDR itself is not bound to our particular application and can be explored in many other trans-disciplinary contexts.

Meinke [14] and most probably quite a few other scientists have presented the idea that during the present century it is time to emphasize the need of synthesizing approaches beside the earlier well established analytical research line. SDR can be seen as one response to this recent suggestion. The challenging part of SDR lies in the initial data of its design artifact EID. First the divide of the experiment population to not-learning and learning beings is by no means a straightforward task and needs careful considerations. Also, GTC sameness assumptions especially on the not-learning being group limits the step from the initial state to the final state. In many cases this limits the predictability, and the data for every prediction step has to be initialized. In addition, the theoretical feasibility of SDR framework remains to be analyzed. In our view SDR opens up to DSR the opportunity to become a major player on the synthesis research line.

Along our development of HGMCSs we hope that SDR can gain wider fitness and contribute significantly to the alleviation of poverty and hunger in developing countries. It should be recognized that SDR framework does not limit the possible climate service applications to the grass-root level. The reasons why we focused our attempts on the grass-root level in a developing country were our earlier experiences in this field, the expected feasibility of the attempt as a prototype project, and the urgent local need for help. However, the field is wide open for challenging undertakings and could lead to a snowball effect both in the fitness of SDR and an extended landing of pertinent global agreements and agendas [1-4]. We hope that SDR through our prototype experiment can convince the decision-makers to enhance the guidance of DSR also in climate-related issues.

5 Conclusions

With the SDR framework accomplished our progressing research has entered now the implementation of its prototype HGMCSs experiment in communities of an African developing country. By the outcomes we expect to demonstrate the feasibility, the validity and the relevancy of SDR as a fitness-utility model. We look forward to enhance its fitness with appropriate publications and contacts to relevant decision-makers.

We hope also that the outcomes of SDR prototype HGMCSs experiment encourage DSR community to seize on the need to develop tools suitable for designing trans-disciplinary interacting systems and to consider this as a challenging opportunity.

Acknowledgements. The authors express their gratitude to Dr. Ethiopia Nigussie in drawing the figure 1 and preparing our manuscript for submission.

References

1. UNFCCC, "Paris agreement," 2015. [Online]. Available: https://unfccc.int/files/meetings/paris_nov_2015/application/pdf/paris_agreement_english_.pdf. [Accessed 27 02 2017].
2. UN, "Transforming our world: the 2030 Agenda for Sustainable Development. Resolution adapted by the General assembly on 25 September 2015 (A/RES/70/1)," 2015. [Online]. Available: www.un.org/ga/search/view_doc.asp?symbol=A/RES/70/1&Lang=E. [Accessed 27 02 2017].
3. UN Office for the Coordination of Humanitarian Affairs, "Agenda for Humanity," 2016. [Online]. Available: <http://www.agendaforhumanity.org/summit..> [Accessed 27 02 2017]
4. UN Office for the Coordination of Humanitarian Affairs, "Natural Disasters and Climate Change: Managing Risks & Crises Differently," 2016. High-Level Leaders' Roundtable #5, Core Responsibility Four of the Agenda for Humanity. [Online]. Available: <https://www.worldhumanitariansummit.org/summit/roundtables>
5. A. Hevner, S. March, J. Park and S. Ram, "Design Science in Information Systems Research," *MIS Quarterly*, vol. 28, pp. 75-105, 2004.
6. M. T. Mullarkey and A. R. Hevner, "Entering Action Design Research," in *DESRIST 2015*, Heidelberg, Germany, 2015, doi:10.1007/978-3-3198-18718-3_8.
7. O. Kuusi, "Expertise in the Future Use of Generic Technologies – Epistemic and Methodological Considerations Concerning Delphi Studies," 1999. [Online]. Available: www.vatt.fi/en/publications/latestPublications/publication/Publication_1345_id/221. [Accessed 27 02 2017].
8. G. T. Gill and A. R. Hevner, "A Fitness-Utility Model for Design Science Research," in *DESRIST 2011*, Heidelberg, Germany, 2011, doi:10.1007/978-3-642-20633-7_17.
9. W. Ulrich and M. Reynolds, "Critical Systems Heuristics," in *Systems Approaches to Managing Change: a Practical Guide*, M. Reynolds and S. Holwell, Eds., London, Springer, 2010, pp. 243-292.
10. C. Silver and A. Lewins, *Using Software in Qualitative Research: a Step-by-Step Guide*, 2nd Edition ed., London: Sage Publications, 2014.
11. O. Afitska, "Review of Transana 2.30. Language Documentation & Conservation 3: 226-235," 2009. [Online]. Available: <https://www.transana.com>. [Accessed 27 02 2017] uri: <http://hdl.handle.net/10125/4441>.
12. W. Ulrich, "The Quest for Competence in Systemic Research and Practice," *Systems Research and Behavioral Science*, vol. 18, pp. 3-28, 2001, doi:10.1002/sres.366.
13. D. Kahnemann, *Thinking, Fast and Slow*, New York: Farrar, Straus and Giroux, 2011.
14. H. Meinke, Personal communication, 2007

Users' time preference based stochastic resource allocation in cloud spot market: Cloud provider's perspective

Research in Progress

Anik Mukherjee¹, R P Sundarraj¹, Kaushik Dutta²

¹Department of Management Studies, Indian Institute of Technology, Madras
Sardar Patel Road, Chennai, Tamil Nadu 600036 – India.

{anikit.jgcec@gmail.com; rpsundarra}@iitm.ac.in

²Department of Information Systems and Decision Sciences, Muma College of Business,
University of South Florida, Tampa, Florida, United States of America

duttak@usf.edu

Abstract. Cloud Computing spot markets have enabled the users to make use of the spare computing capacities of the cloud providers at a relatively cheaper price which in turn has given the providers such as Amazon and Google an opportunity to earn extra money by auctioning-off the underutilized resources. However, resource availability is a problem in the spot market owing to spot-price fluctuations. Ignoring the customer's preference is one of the potential reasons behind this. In this paper, we propose a time preference (value of service at different points of time) based stochastic integer linear programming model to allocate the cloud resources among the cloud users with a view to maximizing the revenue of cloud providers from the spot-market.

Keywords: Cloud Computing · Resource Allocation · Spot Market · Time Preference · Stochastic Programming.

1 Introduction

According to the National Institute of Standards and Technology, "Cloud computing is a model for enabling ubiquitous, convenient, on-demand network access to a shared pool of configurable computing resources (e.g., networks, servers, storage, applications and services) that can be rapidly provisioned and released with minimal management effort or service provider interaction." [NIST 2016]. In fact, cloud computing is an online marketplace where users with less computing capacity can make use of others' computing resources shared over the internet. There are mainly four types of cloud computing facilities available in the market namely On-Demand, Reserve, Dedicated Host and On-Spot¹. Each of the computing resources varies in terms of facilities provided by the cloud providers. First three types of the resources allow the cloud users to

¹ <https://aws.amazon.com/ec2/pricing/>

access the virtual machines² for a longer period of time whereas On-Spot users can use the cloud resource on an hourly basis.

This paper focuses on the Spot market, which was first introduced by Amazon in the year 2009 to make better use of computing resources available in the cloud computing market [Amazon 2016]. Spot market works like electricity market where a number of users bid for a resource, and resource is allocated to the winner [Muli et al. 2013, Song et al. 2012]. For example, in the case of Amazon AWS, users of the spot instances bid for a resource, and Amazon dynamically set a spot price depending on the incoming bid and the available resources. If the user's bid exceeds the spot price of the instance, the resource is assigned to the user. Thus, spot markets provide a mechanism for buying and selling of computing services in a form of Cloud Instance. Cloud users act as a buyer as they need to procure computing resources. Like other online markets, spot markets also influence buyers' decision making while buying resources. In this context, one of the most important factors is the willingness to buy a resource at a particular time. To elaborate on this, we can say that a user may want to access one resource at time t or $(t+1)$. But, (s)he prefers to get the resource at t to $(t+1)$ i.e. he should be willing to pay more at t for that resource than the time-period $(t+1)$. This behavior of customers in online marketplaces has been studied extensively in the literature of Intertemporal Choice Theory [Frederick et al. 2002], the study of trade-offs between cost/benefits of goods/ services and delivery at different times. In the context of spot market of cloud computing, we introduce this concept of the trade-off between time and cost as Time-preference where the cloud providers capture the time preferences of the interested users at the different point of time. Based on the captured preferences, cloud providers allocate the resources among the users. We term this special kind of market as an Extended Spot Market which considers Time Preference of the users as additional information during spot resource allocation. In the previous work of Mukherjee et al. (2016), authors have already mathematically proved that additional information such as Time Preference in spot resource allocation improves the cloud providers' revenue from the traditional spot allocation followed in Amazon [Mukherjee et al. 2016]. In this paper, we present a model and solution methodology to allocate cloud resources among the interested cloud users based on the time preference. Our paper is structured as follows: Section 2 presents a review of the relevant literature. Problem definition is included in Section 3, while Sections 4 and 5 detail the Mathematical Model and Solution Approach respectively. Implications and concluding remarks are available in Sections 6.

2 Literature Review

In the past, researchers have done extensive work on the revenue maximization and cost minimization for the cloud providers and cloud users in the context of resource allocation. Research on these domains can be broadly classified into the following two categories as follows:

² Note, the word Virtual Machine and Resource are used interchangeably in this paper.

Cloud Services

Cloud providers provide four types of services namely On-Spot, On-Demand, Reserved and Dedicated Host. Cloud users are charged based on the services they use. Researchers have identified that the cloud providers always try to maximize their revenue from the cloud services. On the contrary, cloud users tend to minimize the cloud computing cost incurred by them. So, algorithms have been proposed in the literature to address this kind of problem. As an example, Chaisiri et al. presented a stochastic programming and Benders decomposition based cloud resource provisioning technique to minimize the cost of cloud consumers [Chaisiri et al. 2012] whereas Toosi et al. employed a dynamic pricing based auction mechanism to generate near-optimal profit of the cloud provider in spot market resource allocation [Toosi et al. 2016]. In the context of revenue maximization, Alzhouri et al. have shown that the dynamic pricing scheme in spot market can help the cloud organizations utilize the spare resources (VMs) more efficiently [Alzhouri et al. 2017]. Toosi et al. devised dynamic programming based allocation algorithm to maximize the overall revenue of the cloud providers by allocating Virtual Machines to three different cloud service markets namely on-demand, on-spot and reservation [Toosi et al. 2015].

Cloud Auction & Pricing

In the realm of auction and pricing, researchers have proposed various schemes and methodology for the betterment of existing techniques. In Ijakian et al., a double auction based resource allocation mechanism is presented to allocate resources among the users for better resource utilization, profit allocation, and execution rate [Ijakian et al. 2010]. Few researchers have argued that the fixed price models, as adopted by Amazon EC2, Microsoft Azure [Amazon 2016, Azure 2015] etc., do not guarantee economically efficient resource allocation [Zaman and Daniel 2013]. Rather application of combinatorial auction with prior knowledge of user's demand in cloud resource allocation generates better revenue of the cloud providers by maximizing the user's utility with higher resource utilization [Zaman and Daniel 2013]. However, this article does not talk about the truthfulness of the bidders. Toosi et al. proposed a back-propagation based price formation algorithm to maximize the market surplus as well as truthful bidding by the users [Toosi et al. 2016].

In the context of bidding, user's response to the Quality of Service offered by the cloud providers plays a key role in resource allocation. De et al. considered user's patience while allocating the VMs to the different users [De et al. 2016]. Their experiment shows that the proposed strategy reduces the resource allocation cost and improves the Quality of Service (QoS) level.

However, the research on the time-preference based cloud resource allocation is almost scant in the literature. We pick up on this idea and try to address the gap by developing a time-preference based mathematical model to allocate resource in cloud spot-market.

3 Problem Definition

Set of jobs (henceforth called cloud users) arrive at the cloud spot marketplace (say Amazon Web Service) to access the cloud resources as per their needs/ requirements. Cloud providers ask the cloud users for their time preferences for the next t time periods (say 5 time periods). The rate of arrival jobs is purely stochastic³ in nature. The problem can be explained as follows:

First, the cloud provider captures the time preferences of the users/ customers arriving at time period t_1 for the next t time periods (i.e. up to t_1+t) and allocates resource for the t_1^{th} period. In the next time period (i.e. at t_2^{th} or $(t_1+1)^{\text{th}}$), an additional number of users arrive at the same cloud marketplace to access the cloud resources. Hence, the cloud provider needs to capture the time preferences of these customers for the next t time periods (i.e. up to t_2+t where $t_2 > t_1$). This process continues for each time period as soon as a new customer arrives at the cloud marketplace. On the contrary, the cloud provider needs to allocate resources to the existing customers at each time period on a rolling basis depending on the availability of the resources. Note, the number of available resource changes over time. So, the resource allocation should be done in such a way that the overall revenue of the cloud provider is maximized given that the waiting time of the customer to get the preferred resource is not exceeded by a certain threshold. However, the spot market is a highly unstable market. The choice of a resource to bring in the spot market from the reserve instances may influence the overall revenue of the cloud provider as the power consumption cost by a resource may vary over time. Thus, selecting the right resource for the current spot market is a key decision to be taken by the cloud provider. In this paper, we aim to develop a solution methodology to help the cloud provider maximize the overall revenue from the cloud spot market by selecting the right resource for the right users/ customers.

4 Stochastic Programming Model

As mentioned earlier, few parameters such as arrival rate of the customers etc. are stochastic in nature. Thus, Stochastic Programming Model will be a good option to address the real-life spot market resource allocation problem mentioned in this paper. In past, the researchers have captured the stochastic parameters using various distributions such as Normal distribution, Poisson distribution, Pareto distribution [Beloglazov and Buyya 2010, Alzhouri et al. 2017, Javadi et al. 2011]. Hence, we decide to use these distributions to develop the Stochastic Programming model. The detailed description of the model is given below.

³ Note, stochastic means the number of users bidding for a resource at a time is changing over time.

4.1 Model Description

The objective of the model is to maximize the revenue of the cloud provider by calculating the difference between the amount of money earned from the users' time preferences and the operational cost of the resources [Equation 1]. In the context of cloud computing, we assume that the operational cost⁴ is proportional to the power consumption. Further, we consider the cloud resources (Virtual Machines) as the key component of the allocation mechanism. Hence, we have added two constraints related to the resource namely resource requirement by the user as well as the resource availability [Equation 2]. The first part of the Equation 2 refers to the Requirement Constraint which indicates the total number of resources required by the cloud users at that time-period whereas the second part refers to the total number of available resources at that time-period. However, the cloud users too play a key role in the revenue maximization of the cloud provider. As the spot-market is highly competitive in nature, all the cloud users may not be able to get their preferred resources as soon as entering the market. They may have to wait for some time to get hold of the resource. In the Equation 3, we have captured the user's willingness to wait for a resource. Finally, we need to check the quality of resource present in the spot market. Equation 4 guarantees that the best revenue generating resources are brought into spot market by the cloud provider [Note, the term 'best' refers to the virtual machines capable of accommodating more number of cloud users with lesser operational cost]. In this paper, we are assuming that all the non-stochastic input parameters such as operational cost, waiting time of the users etc. are known beforehand.

4.2 Formulation

In the context of cloud computing, we have considered the user's time preference [$Pref_i^{(tr)}$] and the power consumption rate [$P(U)$] by the available resources as stochastic parameters. The term stochastic refers to the uncertain nature of the parameter. To explain it further, we can say that the power consumption rate depends on the resource utilization which varies over time. Again, the number of users may vary each time-period, so does the preferences [Alzhouri et al. 2017]. According to Beloglazov and Buyya, the power consumption rate can be modeled as Normal Distribution [Beloglazov and Buyya 2010] whereas many researchers suggested that the arrival rate of customers follow Poisson distribution [Alzhouri et al. 2017]. Similarly, the resource availability as well as requirements in the spot market changes with time. In this case, resource availability follows Pareto distribution and resource requirement follows Poisson distribution [Javadi et al. 2011]. A detailed description of the model is given below:

Allocation Constraint *A number of resources allocated to the users should lie between the required number of resources and available number of*

⁴ Operational cost can be found on the product of the power consumption (by the Virtual Machines) derived from the power model proposed by [Beloglazov and Buyya 2010] and per-unit power consumption cost.

resources. (Equation 2).
Waiting-Time Constraint Waiting time of the cloud users should be within a specified time duration. (Equation 3).
Resource Constraint Which resources to bring in the spot-market? (Equation 4)

Notations

Input Variables

$Pref_i^{(tr)}$ Time-Preference of i^{th} user at t^{th} time-period for r^{th} resource.
 $P(U)$ The power consumption of a resource as a function CPU-Utilization.
 $Cost_r$ Per-unit power consumption cost of the resource.
 $Required(t)$ The stochastic demand of number resources by the cloud users.
 $Available(t)$ Stochastic supply of a number of resources by the cloud provider.
 $wait(ir)$ Waiting time of the cloud users to access the resource.
 k The fraction of the power consumed by an idle-server.
 P_{max} Maximum power (e.g. 250W) usage by a cloud resource.
 $U(t)$ Utilization of resource at time t .
 \bar{U}_r Mean of CPU Utilization of each resource r .
 $S_{U_r}^2$ The variance of CPU utilization of each resource r .

Decision Variables

$X_i^{(tr)}$ 1, i^{th} user is allotted r^{th} resource at t^{th} time-period.
 0, otherwise
 Y_r 1, r^{th} resource type is selected.
 0, Otherwise

Objective

$$\text{Max } E \left[Pref_i^{(tr)} X_i^{(tr)} \right] - E [P(U) Cost_r Y_r] \quad (1)$$

SUBJECT TO CONSTRAINTS,

$$E(Required(t)Y_r) \leq \sum_{ir} X_i^{(tr)} \leq E(Available(t)Y_r) \quad , \forall t \quad (2)$$

$$\sum_t X_i^{(tr)} \leq wait(ir) \quad , \forall i,r \quad (3)$$

$$\sum_r Y_r = E(Available(t)) \quad , \forall t \quad (4)$$

$$X_i^{(tr)} \in \{0,1\} \quad (5)$$

$$Y_r \in \{0,1\} \quad (6)$$

Where,

$$P(U) = k P_{max} + (1 - k) P_{max} U(t) \quad (7)$$

$$U(t) \sim \text{Normal - Distribution} \left(\sum_{r=1}^m \bar{U}_r, \sqrt{\sum_{r=1}^m S_{U_r}^2} \right) \quad (8)$$

$$Available(t) \sim \text{Pareto-Distribution(Scale, Shape)} \quad (9)$$

$$Required(t) \sim \text{Poisson-Distribution}(\text{mean}) \quad (10)$$

$$Pref_i^{(ir)} \sim \text{Poisson-Distribution}(\text{mean}) \quad (11)$$

$$wait(tr) \sim \text{Poisson-Distribution}(\text{mean}) \quad (12)$$

5 Solution Approach

As discussed in the previous section, the mathematical model presented in this paper is stochastic in nature which is practically very difficult to solve in real-time. In the past, researchers have presented various approaches to solving stochastic programming. As an example, the detailed methodologies to solve linear programming under uncertainty have been addressed in the literature [Powell 2014, Minoux 2007, Dantzig 1955, Birge 1997]. In this section, we have presented a solution methodology in the context of spot market cloud resource allocation. To avoid the complexity of the problem, we have considered a special case of our model outlined before. In this regard, we have considered only one stochastic variable namely resource availability (available) and rest are kept deterministic. Further, we assume that the available resources are identical to each other. Hence, the resource utilization and power consumption cost are constant. So, we have discarded the second expression (pertaining to operational cost) from the objective function as well as the resource index r from the mathematical model. On the other hand, as we have considered identical resources, we do not need to have a separate decision variable to choose the best resource among all. Hence, the constraint pertaining to choose a resource is not required in the problem. Thus, we decide to remove Equation 4 from the mathematical model. Finally, we can rewrite the Stochastic Programming model as follows:

$$\text{Max} \quad Pref_i^{(t)} X_i^{(t)} \quad \text{[Problem P1]} \quad (13)$$

Subject to Constraints,

$$\sum_i X_i^{(t)} \leq Available(t) \quad , \forall_t \quad (14)$$

$$\sum_t X_i^{(t)} \leq wait(i) \quad , \forall_i \quad (15)$$

$$X_i^{(t)} \in \{0,1\} \quad (16)$$

To solve the problem (P1), we have adopted the methodology namely Stochastic Integer Linear Programming with Uncertainty in Right Hand Side proposed by Gabrel et al. 2010. As already mentioned earlier, the key objective of our work is to present a candidate solution methodology of the spot market resource allocation problem. Hence, the methodology proposed in Gabrel et al.'s paper is expected to work well in our problem as we are also dealing with uncertainty on the right-hand side of the constraint [i.e. $Available(t)$ of Equation 14]. According to [10], we can consider that the number of resources varies in the interval $[\underline{a}, \bar{a}]$ such that $Available(t)$ can take values from the defined closed interval. [Gabrel et al. 2010] have shown that the optimum solution of the problem can be found in polynomial time by including the interval constraint in the

linear program. After the inclusion of interval constraint [Equation 18], the math model becomes:

$$\begin{aligned}
 & \text{Optimize} && \text{Problem P1} && (17) \\
 & && \text{Subject to Constraints,} && \\
 & \underline{a} \leq && \text{Available}(t) && \leq \bar{a} \quad , \forall_t && (18)
 \end{aligned}$$

So, we need to solve this deterministic Integer Linear Programs for cloud resource allocation. To explain it further, if we add all the expressions which have been discarded earlier in this section for the sake of simplicity (provided the operational cost is known beforehand), the problem becomes a deterministic equivalent of the stochastic programming proposed in Section 4.2. This methodology gives us an initial direction to solve the basic Stochastic Programming for spot market cloud resource allocation.

6 Research Implications and Conclusions

The problem we have considered here is a resource allocation problem in the cloud computing domain. In our exhaustive search of the literature, we have not found any cloud resource allocation paper using the time-preference of the users. As this is a research-in-progress paper, we have proposed a candidate solution methodology to solve this problem. In future, we will extend this research further by considering multiple stochastic parameters simultaneously.

The key contribution of the paper is the incorporation of user's time preference in cloud computing paradigm. As this is a stochastic problem, it is very difficult to get a good solution of this problem in real time. So, our next aim is to come up with theorems/online algorithm for efficient resource allocation which will maximize the revenue of the cloud providers with better resource allocation capability in the cloud spot market. In addition to it, we aim to extend this problem by defining a market place which will help both the cloud users as well providers gaining better revenue by exchanging resources among different cloud providers across different zones (inter-zonal and intra-zonal transfers).

References

1. Amazon 2016. <https://aws.amazon.com/ec2/purchasing-options/>.
2. Alzhour, F., Anjali, A., Yan, L., and Ahmed, S. B.: Dynamic Pricing for Maximizing Cloud Revenue: A Column Generation Approach. 18th International Conference on Distributed Computing and Networking, 22. ACM, (2017).
3. Azure 2015. <https://azure.microsoft.com/en-in/pricing/>
4. Beloglazov, A., and Buyya, R.: Adaptive threshold-based approach for energy-efficient consolidation of virtual machines in cloud data centers. MGC@ Middleware. (2010).

⁵ Note, we need to solve a series of Linear Program to solve an Integer Linear Program. Hence, the methodology proposed by Gabriel et al., 2010 seems to work well in our problem.

5. Birge, J. R.: State-of-the-art-survey—Stochastic programming: Computation and applications. *INFORMS journal on computing* 9, 2, 111-133(1997).
6. Chaisiri, S., Bu-Sung, L. and Dusit, N.: Optimization of resource provisioning cost in cloud computing. *IEEE Transactions on Services Computing* 5.2, 164-177(2012).
7. Dantzig, G. B.: Linear programming under uncertainty. *Management science* 1, 3-4: 197-206(1955).
8. De, A., Marcos, D., Carlos, H. C., Marco, A. N. and Renato, L. C.: Impact of user patience on auto-scaling resource capacity for cloud services. *Future Generation Computer Systems* 55, 41-50(2016).
9. Frederick, S., Loewenstein, G., O'donoghue, T.: Time discounting and time preference: a critical review. *J Econ Lit* 40(2),351–401(2002).
10. Gabrel, V., Cécile, M., and Nabila, R.: Linear programming with interval right hand sides. *International Transactions in Operational Research* 17, 3, 397-408(2010).
11. Izakian, H., Ajith, A., and Behrouz, T. L.: An auction method for resource allocation in computational grids. *Future Generation Computer Systems* 26, 2, 228-235(2010).
12. Javadi, B., Derrick, K., Jean-Marc, V., and David, P. A.: Discovering statistical models of availability in large distributed systems: An empirical study of *seti@ home*. *IEEE Transactions on Parallel and Distributed Systems* 22, 11, 1896-1903(2011).
13. Minoux, M.: *Robust LP with Right-Handside Uncertainty, Duality and Applications*. (2007).
14. Mukherjee, A., Sundarraj, R. P., and Dutta, K.: On Considering Customer's Short-term Preferences for Resource Allocation in Cloud Computing Spot Markets. *Workshop on Information Technology and Systems (WITS 2016)* (2016).
15. Muli, B. Y., Assaf, S., Orna, A., Muli, B., Assaf, S., and Dan, T.: Deconstructing Amazon EC2 spot instance pricing. *ACM Transactions on Economics and Computation* (1:3), pp16:1-16, 20 (2013).
16. NIST 2016.: <http://www.nist.gov/itl/csd/cloud-102511.cfm>
17. Powell, W. B.: Clearing the jungle of stochastic optimization. In *Bridging Data and Decisions*, 109-137. *INFORMS*(2014).
18. Song, Y., Murtaza, Z., and Kang-Won, L.: Optimal bidding in spot instance market. *INFOCOM, 2012 Proceedings IEEE*. IEEE, (2012).
19. Toosi, A. N., Kurt Vanmechelen, K. R. and Buyya, R.: Revenue maximization with optimal capacity control in infrastructure as a service cloud markets. *IEEE transactions on Cloud Computing* 3, 3, 261-274 (2015).
20. Toosi, A. N., Kurt Vanmechelen, F. K., and Buyya, R.: An auction mechanism for cloud spot markets. *ACM Transactions on Autonomous and Adaptive Systems (TAAS)* 11, 1, 2(2016).
21. Zaman, S. and Daniel, G.: A combinatorial auction-based mechanism for dynamic VM provisioning and allocation in clouds. *IEEE Transactions on Cloud Computing* 1, 2, 129-141(2013).

Towards Comparable Business Model Concepts: Resource Description Framework (RDF) Schemas for Semantic Business Model Representations

Research in Progress

Johannes Schwarz^{1,2}, Nicola Terrenghi^{1,2} and Christine Legner¹

¹ University of Lausanne, Faculty of Business and Economics (HEC), Lausanne, Switzerland

² SAP (Schweiz) AG, Innovation Center Network, St.Gallen, Switzerland

{johannes.schwarz,nicola.terrenghi,christine.legner}@unil.ch

Abstract. Scholars have demonstrated that business model (BM) choices have a significant impact on the success of products, innovations and organizations. However, knowledge about key elements of BMs is disseminated across a large body of literature and builds on different conceptualizations. We take a step back and provide a new approach to formalize BM concepts and related BM knowledge, based on concepts from the semantic web. We introduce and evaluate the Resource Description Framework (RDF) as a data model for comparable and extensible BM descriptions. Moreover, we use this new perspective to analyze commonalities and differences between BM concepts, to reflect critically on the process of translating concepts to RDF and evaluate its relevance for BM design practice.

Keywords: Business Model · Business Model Representation · RDF · Semantics

1 Introduction

The business model (BM) is a highly interesting object for product owners, innovation managers and strategists alike [1]–[3]. It can represent the logic and capabilities of a business in a “remarkably concise way” [4] and serve as a holistic approach to renew and innovate organizations in times of digitization and change [5], [6]. Research seeks to develop “conceptual toolkit[s] that enables entrepreneurial managers to design their future business model, as well as to help managers analyze and improve their current designs to make them fit for the future.” [7].

A main challenge in the BM domain, however, is that multiple definitions, representations and formats of BMs exist [8], [9]. These conceptualizations are either very formal in terms of ontologies or taxonomies or less formal and result in many different perspectives of what the “key” constructs of the BM concept are [10]. At the same time, arguments have been made to make research “more cumulative in nature, and to effect a more efficient transfer of research results into practice” [11].

We assume that each (re-)conceptualization of a BM adds novel, partially overlapping yet equally relevant facets that, together, are a valuable source of knowledge for BM innovation and decision making. However, to translate these insights from rigor to relevance we address the challenges of how to find, integrate and use different BM conceptualizations. Consequently, the research question is the following: *How can varying BM conceptualizations be integrated to make key aspects of the concepts as well as attached BM knowledge comparable?*

We take a step back and provide a new approach to formalizing BM concepts and related BM knowledge, based on ideas from the semantic web. We introduce and evaluate the Resource Description Framework (RDF) as a data model for comparable and extensible description of BMs. This approach allows not only the representation of very formal BM ontologies but also of less-structured concepts that are primarily text-based – in a common format (schema). We do not focus on a specific kind of BM concept but on the underlying mechanisms of describing, comparing and transferring BM knowledge. Moreover, we use this new perspective to analyze commonalities and differences between BM concepts, to reflect critically on the process of translating concepts to RDF and evaluate its relevance for BM design practice.

2 Conceptual foundations

This section introduces the two key concepts – BMs and the resource description framework – before proposing why and how both can benefit from each other.

2.1 Business models

BMs have become a critical element for business success and the concept is identified “as the missing link between business strategy, processes, and Information Technology” [11]. Scholars from various disciplines use the concept to understand how organizations create, capture and deliver value in different markets [12]. [13] classify BM research in three streams: *overarching concept* (“meta-models that conceptualize them”), *taxonomies* (generic BM types with common characteristics), and the *instances* (that “consists of either concrete real world business models or [...] descriptions of real world business models”). Many scholars have tried to define BMs formally by developing ontologies, taxonomies or frameworks [13]–[15]. No definition seems to satisfy all purposes [9], [16]. Thus, our research provides a data model to describe different BM concepts (meta-models) and demonstrate the application of this data model based on BM types and instances.

2.2 Resource description framework

The resource description framework (RDF) is a standard model and abstract syntax to represent information [17] and is primarily used in the context of the semantic web [18]. In RDF, information is represented in a set of triples. Each triple consists of a

subject, predicate and object. By forming triples, we build *statements* about the relationship (predicate) between two *resources* (subject and object) [17]. For example, one could state that the city “Berlin” (subject) “has-major” (predicate) “Michael Müller” (object). Or that the customer segment “professionals” (subject) “have-a-need-for” (predicate) “seamless online shopping” (object).

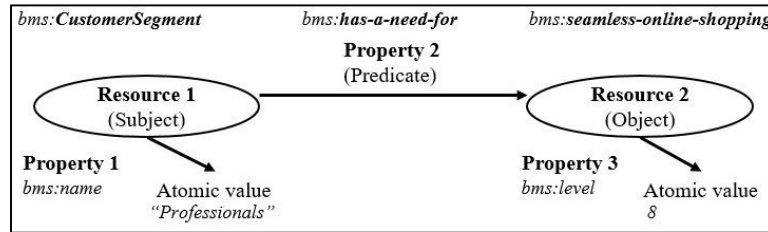

Fig. 1. An RDF graph with two nodes (subject and object), a triple connecting them (predicate) [17], additional properties and *examples* (“bms:” prefix serves as identifier for a namespace)

2.3 RDF schemas as flexible, comparable and reusable ontologies

Without constraints and additional semantics, the triple-logic could be used to describe any kind of (un-)meaningful data. For example, the following statements are meaningless in a BM context:

```
:large-enterprises :type :software
:customer-segment :customer-segment :customer-segment.
```

Therefore, predefined RDF vocabularies are available in the RDF namespaces that can be used to create simplified, domain-specific ontologies, called *schemas*, which provide a set of definitions and constraints for the underlying RDF data. For example, a schema could define “Customer Segment” as a meaningful “type” of RDF Resource, which can have a Property “has-a-need-for”¹. Schemas provide the meta-data for the actual information.

2.4 Towards comparable and extensible business model concepts based on RDF schemas

This research is motivated by the fact that the body of BM research has similar characteristics to the World-Wide-Web where data “covers diverse structures, formats, as well as content [...] and lacks a uniform organization scheme that would allow easy access to data and information” [18]. We assume that the business model is a complex, multi-faceted concept with different, equally relevant aspects that differ across context or purpose and that the concept will evolve even further in the future. Here, RDF and RDF

¹ Please refer to the official specifications [17] for additional information on the RDF concept and the set of predefined vocabularies.

schemas can help to create comparable, extensible and processible descriptions of BM (meta-)information. In specific, we see the following advantages of RDF:

- **Properties:** Unlike traditional object- and class-oriented data models, RDF provides a rich data model where *relationships* are also first class objects, “which means that relationships between objects may be arbitrarily created and be stored separately from the two objects. This nature of RDF is very suitable for dynamically changing, distributed, shared nature of the Web” [18]. In other words, relationships between objects can be added without changing the definition of the class. An existing BM construct such as “Customer Segment” can be enriched with idiosyncratic properties (e.g. linking customer segments with atomic values or other resources).
- **Namespaces:** A unique feature of RDF is that it uses the XML namespace mechanism: “A namespace can be thought of as a context or a setting that gives a specific meaning to what might otherwise be a general term. [...] using namespaces, RDF provides ability to define and *exchange semantics among communities.*” [18]. The advantage of this is that each BM concept can be associated with its own namespace and BM information building on different concepts be exchanged.
- **Mixing definitions:** One of the most interesting features of RDF is its extensibility and shareability. It “allows metadata authors to use multiple inheritance to mix definitions and provide *multiple views* to their data. In addition, RDF allows creation of instance data based on multiple schemas from multiple sources” [18]. Scholars, who document information about BM instances, often combine different BM conceptualizations.
- **Query language:** With SPARQL (an acronym for SPARQL Protocol and RDF Query Language) a powerful tool to query RDF data is available (see the following example that gets all BMs with a customer in the software industry).

```
@prefix bm: http://bm.example.com/exampleBmOntology#
SELECT ?businessModel ?customer
WHERE {
    ?businessModel bm:hasCustomer ?customer .
    ?customer bm:isInIndustry bm:Software;
}
```

3 Methodology

This research follows a design science paradigm [19] and Peffers et al’s. [20] specific guidelines. Peffers et al. suggest the following phases: problem identification & motivation, objectives of a solution, design & development, demonstration, evaluation, communication. Problem, motivation and objective were already outlined in the previous sections. Communication takes place in academic conference proceedings. The following sub-sections explain the remaining phases.

3.1 Design and development: eliciting conceptual meta-constructs and creating an exemplary BM schema vocabulary

We leverage an exemplary set of six BM conceptualizations (see table 2) and translate the underlying implicit or explicit constructs into RDF schemas. Conceptual literature is defined as peer-reviewed, scientific articles that explicitly discuss the nature of the BM concept (in contrast to case studies that use the BM lens, to understand how a company works, for example [21]) and have a significant number of citations (>150). In contrast to previous BM ontology mapping approaches [22], [23], we do explicitly include also more qualitative concept definitions. For example, [7] consider BMs as activity systems which are “a set of interdependent organizational activities centered on a focal firm” with two relevant design parameters “design elements and design themes”. The concept is not as formal as a taxonomy and rather implicit but holds valuable information about key BM constructs. Specifically, we translate text and concepts into a set of triple statements which will then be consolidated in an RDF schema in the namespace of the authors. To remain with the example of [7], the sentence “an activity in a focal firm’s business model can be viewed as the engagement of human, physical and/or capital resources of any party to the business model” is translated into the following schema (extract):

```
@prefix za: http://schema.bm.org/2010/Zott_and_Amit
za:BusinessModel    za:consistsOf    za:Activity
za:Activity          za:linkedTo      za:ActivityLink
za:Activity          za:uses          za:Resource
za:ActivityLink      za:hasNovelty    rdfs:Bag ["Novel", "Not-
Novel"]
za:Physical          a                za:Resource
```

In a parallel step, we review these concepts for commonalities to create a common BM schema within its own namespace (BMS) that represents a custom schema mapping – yet again extensible and comparable in RDF.

3.2 Demonstration: Representing business models and BM knowledge

To demonstrate the value of compatible BM RDF schemas for BM design purposes we select exemplary BMs from the BM literature (e.g. [21]) and represent them by manually selecting constructs from the concept schemas. Moreover, we want to demonstrate that BM knowledge that builds currently on different BM concepts (e.g. [24]) can be described and identified. We select in total 10 exemplary articles from the body of BM research that build on one (or a combination of) the above BM concepts. These articles represent BM design knowledge either by BM type or instance. We use an instance of Apache Jena, an open source framework for semantic web and linked data applications², to store and query the RDF data.

² <http://jena.apache.org/index.html>

3.3 Evaluation

We adopt the following evaluation criteria:

Table 1. Evaluation criteria

Criterion	Definition and measurement
RDF translatability	In general, any text or concept can be translated into more formal ontologies, regardless of the data format. Thus, we reflect on our experiences with RDF and provide qualitative insights, whether we perceived this process as easy or difficult and whether enhanced text-to-ontology methods could support this process. Moreover, we provide suggestions for researchers who want to code other BM information bases.
Construct-schema coverage	An interesting aspect is, to what extent different BM conceptualizations build on similar meta-constructs and whether a common schema is meaningful. We build the BMS iteratively, based on the body of knowledge identified as describe in section 3.1 and try to identify the lowest common denominator of constructs. We provide a simple measurement of construct coverage in our schema. This will support our understanding of differences and commonalities between BM concepts.
Knowledge extraction and comparability	The main research objective is to assess whether RDF supports the representation and extraction of meaningful BM knowledge for BM design purposes. We evaluate this aspect based on ten BM instances and interviews with at least three different BM experts (who have more than two years of experience working on BM innovation or BM development). In particular, we will assess whether the underlying semantics help to identify a) problems such as inconsistency between BM elements and b) additional, previously unknown BM knowledge to improve the BM design.

4 Preliminary results

4.1 Representing and comparing BM concepts in RDF (ongoing)

Table 2. Business model concept meta-constructs (legend: ● key construct, explicitly defined and explained ● defined and explained ◐ mentioned but not explicitly defined ◑ mentioned briefly ○ not mentioned)

Concept constructs (BMS vocabulary)	Named Elements													
	Element	Link	Resource	Activity	Offering	Other	Group	Attribute	Actor	Value	Transaction	Level	...	Completed?
<i>Author(s): concept name (if available) and source</i>														

Akkermans & Gordijn: e³-value ontology [14]	●	●	○	●	●	○	○	●	●	●	●	●	○
Osterwalder & Pigneur: business model ontology [13]	●	○	●	●	●	●	●	○	○	○	○	○	○
Zott & Amit: Activity system [7]	●	○	○	●	○	●	○	○	●	○	●	○	○
Johnson et al. [25]	●	○	●	●	●	●	○	○	○	○	○	○	○
Casadesus-Masanell & Ricart : Choices and consequences [26]	○	●	○	●	○	○	○	○	○	○	○	○	○
Demil & Lecocq : RCOV [27]	●	●	●	●	●	○	○	○	○	○	○	○	○

Our current results are mainly based on a detailed analysis of a subset of BM concepts and a simple analysis of all concepts for similar constructs (Table 2). For a subset of concepts [7], [27], [28], we have extracted all sentences and images that include relevant facts about the BM concept, for example “Choices, [...] are not the sole constituent of business models. As all authors highlight, choices must be connected to value creation and value capture, or to alternative goals the company may want to pursue” [28] and translated them into RDF statements. These statements were then consolidated to create an initial BM concept schema within the namespace of the corresponding authors (e.g. Casadesus-Masanell and Ricart). In general, our impression is that the process of translating text to RDF works very well and the resulting schema is consistent even when created independently by two authors of this paper. Moreover, we discover some constructs that appear frequently, such as the idea to decompose a BM into elements and links between these elements and novel constructs that are usually not explicitly modeled (for example the properties “novelty” of an activity link or “switching costs” of a customer [7]). This is also a main difference to previous ontologies and ontology mappings because we discover additional properties that may have important implications for the understanding of a BM. Moreover, our current impression is that, yes, concepts differ significantly but have certain constructs in common. These common constructs can then be used to make links between the concepts explicit. For example, [13] consider revenue models, costs and activities (besides others such as channels, customers etc.). In contrast, [7] focus mainly on activities and consider the revenue model as “conceptually distinct” and [28] introduce price as a “choice” and cost as a “consequence”. We look forward to evaluate whether a standard BM schema improves concept integration. Our preliminary results strengthen the assumption that each BM concept is unique and that attempts to conciliate them into one ‘ideal’ ontology are likely to remain impracticable because ontology mappings and simple taxonomies neglect relevant properties. Given that these concepts are then used to capture BM knowledge, for example about the development of cloud BMs in the software industry, a flexible and comparable schema language, such as RDF can then help to them in a simple, yet effective way and to model the underlying BM information.

References

1. D. J. Teece, “Business models, business strategy and innovation,” *Long Range Plann.*, vol. 43, no. 2–3, pp. 172–194, 2010.

2. M. Sosna, R. N. Trevinyo-Rodríguez, and S. R. Velamuri, "Business model innovation through trial-and-error learning: The naturhouse case," *Long Range Plann.*, vol. 43, no. 2–3, pp. 383–407, 2010.
3. Chesbrough and R. S. Rosenbloom, "The role of the business model in capturing value from innovation: evidence from Xerox Corporation' s technology spin-off companies," *Ind. Corp. Chang.*, vol. 11, no. 3, pp. 529–555, 2002.
4. [C. Baden-Fuller and M. S. Morgan, "Business models as models," *Long Range Plann.*, vol. 43, no. 2–3, pp. 156–171, 2010.
5. R. Amit and C. Zott, "Business Model Design: A Dynamic Capability Perspective," (*Working*), 2014.
6. C. Baden-Fuller and S. Haefliger, "Business Models and Technological Innovation," *Long Range Plann.*, vol. 46, no. 6, pp. 419–426, 2013.
7. C. Zott and R. Amit, "Business Model Design : An Activity System Perspective," *Long Range Plann.*, no. APRIL, 2010.
8. T. Burkhart, D. Werth, J. Krumeich, and P. Loos, "Analysing the business model concept - A comprehensive classification of literature.,," *Thirty Second Int. Conf. Inf. Syst.*, pp. 1–19, 2011.
9. B. W. Wirtz, A. Pistoia, S. Ullrich, and V. Göttel, "Business Models: Origin, Development and Future Research Perspectives," *Long Range Plann.*, 2015.
10. B. W. Wirtz, A. Pistoia, S. Ullrich, and V. Göttel, "Business Models: Origin, Development and Future Research Perspectives," *Long Range Plann.*, pp. 1–19, 2015.
11. D. Veit, E. Clemons, A. Benlian, P. Buxmann, T. Hess, D. Kundisch, J. M. Leimeister, P. Loos, and M. Spann, "Business Models An Information Systems Research Agenda," *Bus. Inf. Syst. Eng. - Res. Notes*2, no. 2014, pp. 45–53, 2014.
12. C. Zott, R. Amit, and L. Massa, "The Business Model: Recent Developments and Future Research," *J. Manage.*, vol. 37, no. 4, pp. 1019–1042, 2011.
13. A. Osterwalder, Y. Pigneur, and C. L. Tucci, "Clarifying business models: origins, present, and future of the concept," *Commun. Assoc. Inf. Syst.*, vol. 15, no. 1, pp. 1–43, 2005.
14. J. Gordijn and H. Akkermans, "Designing and Evaluating E-business," *Ieee*, no. July/August, pp. 11–17, 2001.
15. M. M. Al-Debei and D. Avison, "Developing a unified framework of the business model concept," *Eur. J. Inf. Syst.*, vol. 19, no. 3, pp. 359–376, 2010.
16. T. Burkhart, J. Krumeich, D. Werth, and P. Loos, "Analyzing the Business Model C Oncept — a Comprehensive Classification," *ICIS 2011 Proc.*, no. September, pp. 1–19, 2011.
17. W3C, "RDF 1.1 Concepts and Abstract Syntax," *W3C Recommendation 25 February 2014*, no. February. pp. 263–270, 2014.
18. K. S. Candan, H. Liu, and R. Suvarna, "Resource Description Framework : Metadata and Its Applications," *SIGKDD Explor.*, vol. 3, no. 1, pp. 6–19, 2001.
19. Hevner, S. T. March, and J. Park, "Design Science in Information Systems Research," *MIS Q.*, vol. 28, no. 1, pp. 75–105, 2004.
20. K. Peppers, T. Tuunanen, M. A. Rothenberger, and S. Chatterjee, "A Design Science Research Methodology for Information Systems Research.," *J. Manag. Inf. Syst.*, vol. 24, no. 3, pp. 45–77, 2008.
21. B. Moingeon and L. Lehmann-Ortega, "Creation and Implementation of a New Business Model: a Disarming Case Study," *M@ n@ gement*, vol. 13, no. 4, pp. 266–297, 2010.
22. T. Mettler, "Towards a unified business model vocabulary: A proposition of key constructs," *J. Theor. Appl. Electron. Commer. Res.*, vol. 9, no. 1, pp. 19–27, 2014.
23. B. Andersson, M. Bergholtz, A. Edirisuriya, T. Ilayperuma, E. Dubois, S. Abels, A. Hahn, B. Wangler, H. Weigand, P. Johannesson, B. Grégoire, M. Schmitt, and J. Gordijn,

- “Towards a Reference Ontology for Business Models,” *Proc. 25th Int. Conf. Concept. Model.*, vol. 4215, pp. 482–496, 2006.
24. T. Kessler and J. Brendel, “Planned Obsolescence and Product-Service Systems: Linking Two Contradictory Business Models,” *Jesm*, vol. 8, no. February, pp. 29–53, 2016.
 25. M. W. Johnson, C. M. Christensen, and H. Kagermann, “Reinventing Your Business Model,” no. December 2009, pp. 1–10, 2008.
 26. R. Casadesus-Masanell and J. E. Ricart, “From strategy to business models and onto tactics,” *Long Range Plann.*, vol. 43, no. 2–3, pp. 195–215, 2010.
 27. B. Demil and X. Lecocq, “Business model evolution: In search of dynamic consistency,” *Long Range Plann.*, vol. 43, no. 2–3, pp. 227–246, 2010.
 28. R. Casadesus-Masanell and J. E. Ricart, “Competing through business models,” *Business*, vol. 3, no. 713, pp. 1–43, 2007.

Action Design Research as a Method-in-Use: Problems and Opportunities

Amir Haj-Bolouri¹, Sandeep Purao², Matti Rossi³ and Lennarth Bernhardsson¹

¹ Department of Informatics, University West, Sweden
{amir.haj-bolouri, lennarth.bernhardsson}@hv.se

² Information and Process Management, Bentley University, USA
spurao@bentley.edu

³ Information Systems, Aalto University, Finland
matti.rossi@aalto.fi

Abstract. This paper reports on the results of a study to investigate how scholars engage with and use the action design research (ADR) approach. ADR has been acknowledged as an important variant of the Design Science Research approach, and has been adopted by a number of scholars, as the methodological basis for doctoral dissertations as well as multidisciplinary research projects. With this use, the research community is learning about how to apply ADR's central tenets in different contexts. In this paper, we draw on primary data from researchers who have recently engaged in or finished an ADR project to identify recurring problems and opportunities related to working in different ADR stages, balancing demands from practice and research, and addressing problem instance vs. class of problems. Our work contributes a greater understanding of how ADR projects are carried out in practice, how researchers use ADR, and pointers to possibilities for extending ADR.

Keywords: Action design research · Use · Design science research and practice

1 Introduction

After the publication of action design research as a research methodology [1], a number of projects [2-10] have been initiated or converted to follow Action Design Research (ADR) as their core research methodology. ADR represents a variant of Design Science Research (DSR) [11-13] that privileges the organizational influences on the design and evolution of the artifact, emphasizing the building-intervention-evaluation (BIE) cycles, as an alternative to the stage-gate model, allowing both the researchers as well as the organizational stakeholders to shape the artifact over the research lifecycle. As several new research projects [2-6] have been initiated with the ADR methodology, others [7-10] who completed their work before the publication of ADR have suggested that

they have implicitly followed the tenets of ADR. Scholars in the research community have also examined ADR proposing modifications and/or extensions to the methodology such as a stronger emphasis on how to elaborate the participatory aspect of conducting ADR with stakeholders and users [14-15], or elaborating a focus on agile software development methods as part of ADR [16].

These efforts along with others [17] have resulted in a better understanding of how to position the ADR methodology as a strategy for conducting a particular sub-class of design science research projects that deals two concerns. First, it addresses real world problems (e.g. specific client's problem in an organization), which requires the research team to consider at least two stakeholder groups: the client organization and the research community. Second, it requires that research team balance the specific problem against the need to consider that problem as an instance of a class of problems. How does the research team actually engage with these difficult concerns?

The question may be seen as an effort to understand the sufficiency of ADR, e.g., how it guides the researchers to address the two concerns outlined above. It may also be seen as an effort to understand how researchers operationalize the central tenets of ADR as they engage in research, and identify any problems they may face as they do this. These issues drive the work we report in this paper. We explore how ADR is being used in research projects and to understand the specific problems that researchers may face in operationalizing ADR in specific contexts. We do this by collecting primary data, via interviews of researchers who have used ADR within the context of a project, either ongoing or recently completed. The data is analyzed with a view to surfacing recurring themes, using modified content analysis techniques [18-19].

The key contribution of our work is to reveal how researchers actually use ADR in practice and what their experiences are. Based on such insights, our initial results we report in this paper can provide input for developing best practices that future practitioners of ADR can draw upon. They also suggest directions that may be followed for potential elaborations of ADR in response to concerns that have surfaced.

We proceed as follows. In the next section, we review prior work about the ADR methodology, including more recent efforts to extend the methodology, and briefly outline possible problems about using ADR in practice. Next, we describe the research approach including the use of specific techniques for data collection and analysis. The Findings section outlines key outcomes that resulted from this analysis. We conclude with a discussion of implications, and provide an outlook for next steps.

2 Prior Work

The introduction of ADR [1] was a direct response to the DSR paradigm [11]. ADR was described as a design research method for generating design knowledge through building and evaluating IT-artifacts in an organizational setting. The ADR methodology focused on two major challenges: (1) addressing a problem situation encountered in a certain organizational setting through intervention [e.g. 4]; (2) building and evaluating an IT-artifact, which addresses the class of problems typified by an encountered situation [e.g. 6-7]. Since its publication, ADR has been adopted by several researchers

to solve problems in organizations through building, intervention, and evaluation of IT-artifacts [2-6]. These scholars have communicated their experiences through design principles and design theories to the design science community [5-10]. The central tenets of ADR advocate significant collaboration with key stakeholders and end-users within the organization to encourage active participation and contributions that shape the IT artifact over the research lifecycle [14-16].

The ADR methodology emphasizes the collaborative philosophy by emphasizing the membership of stakeholders within the ADR research team. This allows the team to address the tension between addressing a particular instance of a problem against the demand to deal with a class of problems. Experts and scholars argue and agree that design can never be decontextualized [20]. Scholars also agree, starting from Rittel and Weber [21] that design remains a wicked problem that starts from an issue, a problem [21, p. 5]. The contextual nature of design poses a challenge for how the ADR methodology should be operationalized in practice.

3 Research Approach

To explore how researchers engage in a research project with the use of ADR methodology, we collected and analyzed primary data via interviews with ADR teams. The intent was to gain insights into how they used ADR during the research life cycle and how they addressed any issues that came up. Instead of self-reporting, which can be subject to vagaries of recall and interpretation [22], we collected data for our study via direct interviews. To identify subjects for the study, we located researchers who have published research papers that declared ADR as their core research methodology. At the time of this writing, these interviews continue. In this paper, we report findings based on an analysis of four subjects, selected based on the richness of their responses and the opportunity to share key recurring themes.

The data was gathered via semi-structured interviews following a variation of the critical incident technique [23-24], which suggests procedures for collecting data about human experiences. This allowed the research team to overcome recall concerns by providing the participants the ability to explore key concerns in the context of a specific scenario that they would identify within their ADR project. This was accomplished by encouraging the respondents to recall specific moments that concerned their use of ADR. The interviews were primarily conducted by one of the researchers, sometimes joined by another researcher. The procedure for conducting the interviews included the following phases.

First, an informational meeting was conducted using an audio/video platform, where the participants were asked to recall a specific incident in their ADR project. Using this anchor, the researchers followed a protocol that included initial and probe questions such as: When was it most challenging to work with stakeholders? How did you involve them? During which ADR-stages did they engage more or less? Each interview was recorded and transcribed. The researcher also took notes, which were captured in a document that was securely shared with the respondents, allowing them to adjust and refine the notes, as well as provide additional commentary. A second phase followed,

which included follow-up questions that allowed the respondents to build upon their responses. The same shared document was used to facilitate this phase of data collection, which included questions such as: What elements of ADR would you like to enhance further? How can other researchers engage better in the reflection and learning stage? Do you have any other concerns that you would like to discuss? The two-phase structure for data collection allowed the respondents to separate (a) sharing what they did as part of their ADR projects, and (b) their suggestions for further elaborating or improving the ADR methodology. The recorded interviews, followed by the co-editing of the notes also ensured member-checking [22] that added reliability to our data collection, and partially, to the data analysis process.

Table 1 shows a summary of the subject’s structure with essential elements such as the respondents’ name, age, gender, domain of research and so forth. Due to an ethical agreement with the respondents, we do not explicate the respondents’ actual name and age.

Table 1. Respondents and Summary of Data Collection

Name	Age	Project	Research Domain	Status	Length (Minutes)
Aaru	39	Dissertation	IS and Health Care	On-Going	58
Sofia	42	Dissertation	ICT for Smart Cities	Completed	38
Nasib	34	Dissertation	Competence Management	On-Going	32
Rafael	37	Dissertation	Innovation Ecosystems	On-Going	52

We coded the data following an open coding [18-19] approach to identify themes and categories to reveal how the researchers used ADR in their respective research projects.

4 Preliminary Findings

Several categories emerged from our analysis. We report some of these, first as impressions across the different ADR stages, and then in terms of the two specific concerns identified earlier. We note that the respondents (Sofia and Rafael) mentioned that they only loosely followed ADR stages although reported that the inspiration for their work could be described as ADR, and two other respondents (Aaru and Nasib) followed ADR implicitly during the earlier stages due to project initiation in 2010. However, all respondents described their categorical choice to frame and communicate the results of their research as outcomes of ADR projects, citing correspondence to the ADR tenets. Due to the small number, we do not report frequencies, relying, instead, on actual quotes from the respondents and interpretations.

4.1 Working with ADR Stages

Several themes emerged from the data. During the first stage, problem formulation, the researchers did not describe crafting of a research question as a key concern. Instead,

their concerns centered around working with stakeholders and addressing different priorities of stakeholders. Multiple respondents described this concern thus:

[it was] difficult to involve stakeholders from health care due to accessibility and time priority. Furthermore, Stakeholders did not take part of this stage due to lack of awareness of ADR in general (Aaru)

A living lab was established to involve stakeholders. Overall, the stakeholders were accessible and involved through focus groups, workshops and interviews. (Sofia)

Due to high degree of accessibility, there were no difficulties with involving stakeholders through daily work activities such as meetings and discussions. But it was a big challenge keeping them happy and motivated all the time. (Nasib)

Comments about the second stage, building, intervention and evaluation, continued this focus on working with the stakeholders. The respondents mentioned that the ongoing interactions suggested by ADR were clearly instrumental in making this stage a success. With mechanisms such as agile development, they were able to engage in the BIE stage with the stakeholders. Multiple respondents described this concern thus:

Efficient and rewarding to demonstrate increments of the IT-artifact continuously through workshop sessions. (Aaru)

[we] worked together through an agile approach to deliver early mock-ups and functionality. (Sofia)

Stakeholders were gathered to share their own data and mindset towards building a new artifact. They felt motivated when interacting with early prototype versions. (Rafael)

The third stage, reflection and learning, produced the most varied responses. Most respondents, however, commented about difficulties related to ongoing reflection and learning, and the need to document lessons learned. In response, they described the use of mechanisms such as workshops, which may provide specific opportunities for capturing reflections. Multiple respondents described this concern thus:

Difficult to document reflection and learning continuously, but easy to conduct dedicated workshops. (Aaru)

This stage was removed and replaced with a stage for defining design requirements. This due to the notion that reflection and learning occurred all the time, and was not necessary as a separate stage. (Sofia)

Workshop sessions were conducted for reflection and learning. However, there were a great lack of documenting the outcomes continuously in the project. (Nasib)

Table 2 describes the themes.

Table 2. Recurring Themes about Working in Different Stages of ADR

Theme	Description	Stage
Stakeholder Access, Awareness, Priorities	<ul style="list-style-type: none"> Access was not a significant concern Researchers used different approaches to work with stakeholders Awareness on the part of the stakeholders was a possible obstacle 	Problem Formulation
Ongoing Stakeholder Engagement	<ul style="list-style-type: none"> Early and frequent stakeholder interaction a motivating factor for stakeholders 	Building, Intervention,

	<ul style="list-style-type: none"> • Researchers used strategies such as agile development to facilitate this stage 	Evaluation
Problems with Ongoing Reflection and Learning	<ul style="list-style-type: none"> • Reflecting and document continuously considered difficult • Researchers used strategies such as dedicated workshops • One researcher (who managed ongoing reflection) removed it as a separate stage 	Reflection and Learning

4.2 Balancing Expectations from Industry Partners and Research Community

Three key themes emerged from the analysis related to balancing expectations from the industry partners and the research community. The respondents leaned towards seeing this as a concern to be managed. They acknowledged that ADR provided an opportunity to address a relevant problem and a chance to produce research outcomes.

They described this dichotomy between solving real-world problems and distilling design knowledge as an ongoing issue to be managed. They described it thus:

the stakeholders [could] see that the system worked because we delivered small increments of the IT-artifact so that the stakeholders could interact and evaluate early on... (Aaru)

we conducted 5 big workshops in the living lab and had discussions through base camp... we felt that early iterations were useful for balancing outcomes for practice and research... (Sofia)

the design iterations generated both outcomes for new design and functionality, but also input for formalization of learning for research ... (Sofia)

but the key success was to deliver everything coupled to the IT-artifact through small batches, and have some progress... (Nasib)

at the same time, it was rewarding for research because we could write and publish preliminary findings... (Rafael)

As the illustrative quotes above show, the balancing concerns manifested in a number of ways. Table 3 describes the themes we were able to discern from this data.

Table 3. Recurring Themes about Balancing Expectations

Theme	Description and Consequences
Impedance Mismatch	<ul style="list-style-type: none"> • The speed of business for the organizational partners versus the need for slow deliberation important for research writing was cited by respondents as a recurring problem • Research activities [were perceived as] slowing things down • Ongoing, incremental delivery of functionality via the IT artifact was considered a way to overcome the problem
Keeping the Research Team Engaged	<ul style="list-style-type: none"> • The multi-disciplinary composition of the research team meant different individuals within the research team were busy at different times • Keeping the industry partners engaged and motivated remained an ongoing concern • Researchers conducted activities (e.g. workshops) focusing on different areas of interest to keep the industry partners interested and motivated
Separate but Equal	<ul style="list-style-type: none"> • Involving stakeholders in discussion of research outcomes was not considered fruitful

	<ul style="list-style-type: none"> The researchers needed to make an effort to continue generating outcomes such as versions of prototypes and also generate research outcomes based on preliminary findings
--	---

4.3 Balancing the Problem Instance-Class Dichotomy

Here, respondents shared insights about how the practical problems were formulated working the stakeholders, whereas research problems were identified and formulated by the researchers alone. This lack of reciprocity among the stakeholders, practitioners and researchers was described by multiple respondents thus:

The research team had their research questions that were formulated within the research groups, which consisted of psychologists, doctors, nurses, IS-researchers etc... (Aaru)

however, the problems for research were identified by us researchers throughout the ADR-stages, and not separately identified... (Sofia)

people were mostly involved when they were brainstorming about ideas for developing the software and so forth... (Nasib)

the stakeholders were not interested in producing knowledge, but more interested in the actual artifact instead... (Nasib)

so it was hard to allocate class of problems for research together with stakeholders... this was done by us researchers instead ... (Rafael)

An analysis of this data revealed three concerns across the respondents. Table 4 describes the themes we were able to discern from this data.

Table 4. Balancing the Problem Instance-Class Dichotomy

Theme	Description
Problem Identification and Evolution	<ul style="list-style-type: none"> With multi-disciplinary teams, problem identification remains a problem (likely because of disciplinary requirements) New and interesting research problems continue to crop up as the team engages in the research life cycle
Taking on Research Responsibility	<ul style="list-style-type: none"> Hard to involve stakeholders for casting the problem instance to a class Easy to focus on solving the problem and ignore the class of problems Identifying the class of problems requires making a choice
Focus of IT Artifact Easier	<ul style="list-style-type: none"> It is easier to describe and elaborate features of the IT artifact It is easier to elicit and document solution requirements for the IT artifact It is important to cast these in terms of a class of problems

5 Discussion and Next Steps

In this paper, we have taken initial steps towards investigating the use of ADR in actual projects. Based on an analysis of data gathered from lead researchers in four ADR projects, we find that ADR did provide support to the research activities, such as continuously building, evaluating and demonstrating early prototype versions, and engaging in close collaboration with industry partners to allow mutual shaping of the IT artifact.

The preliminary findings also reveal that researchers continue to find it difficult to balance the (sometimes conflicting) demands from industry-partners versus those of the research community (e.g. impedance mismatch, see Table 3). This is also manifested in the need to focus on problem instance vs. considering the class of problems (e.g. problem evolution, see Table 4).

We note that there are a number of prior research streams that the research community can draw upon to further understand and develop solutions to these concerns. For instance, our preliminary findings indicate that there exists an interest for positioning and distinguishing ADR from other DSR-methods. ADR is not positioned as an explicitly isolated DSR-method. This due to the fact that it is used in multidisciplinary research settings by a team of researchers, practitioners, stakeholders, and end-users. Furthermore, ADR is – as indicated by our findings and previous use of ADR – considered as compatible for retrospectively framing and reporting research findings to a dual community of practitioners (e.g. through the prototype) and researchers (e.g. through scientific concepts such as design principles and theories). This implies that the ADR-method is flexible and adjustable for solving real world problems and generating knowledgeable learning outcomes. Finally, our preliminary findings also suggest possibilities for further refinements to ADR such as greater guidance for engaging in reflection and deriving outcomes such as design principles. We hope that these initial findings will provide the impetus for greater dialog within the research community to develop practices and refining the ADR approach for further research.

References

1. Sein, M.K., Henfridsson, O., Purao, S., Rossi, M., Lindgren, R.: Action Design Research. *MISQ*. Vol 35, No 1 (2011)
2. Lempinen, H., Rossi, M., and Tuunainen, V.K.: Design Principles for Inter-Organizational Systems Development - Case Hansel. *DESRIST2012*, LNCS 7286, pp. 52-65, (2012)
3. Haj-Bolouri, A., Bernhardsson, L., Bernhardsson, P., and Svensson, L.: An Information Systems Design Theory. *HICSS49*, (2016)
4. Schacht, S., and Mädche, A.: How to Prevent Reinventing the Wheel? - Design Principles for Project Knowledge Management Systems. *DESRIST2013*, LNCS 7939, pp. 1-17, (2013)
5. Maccani, G., Donnellan, B., and Helfert, M.: Action Design Research in Practice: The Case of Smart Cities. *DESRIST2014*, LNCS 8463, pp. 132-147, (2014).
6. Hilpert, H., Beckers, C., Kolbe, L.M., and Schumann, M.: Green IS for GHG Emission Reporting on Product-Level? An Action Design Research Project in the Meat Industry. *DESRIST2013*, LNCS 7939, pp. 324-339, (2013)
7. Keijzer-Broers, W., Florez-Atehortua, L., and de Reuver, M.: Prototyping a Health and Wellbeing Platform: an Action Design Research Approach. *HICSS49*, pp. 3462-3471, (2016)
8. Mustafa, M.I., and Sjöström, J.: Design Principles for Research Data Export: Lessons Learned in e-Health Design Research. *DESRIST2013*, LNCS 7939, pp. 34-49, (2013).
9. Niemi, E., and Laine, S.: Competence Management System Design Principles: Action Design Research. *ICIS2016*, (2016)
10. Huhtamäki, J.: Visualizing Co-authorship Networks for Actionable Insights: Action Design Research Experiment, *Academic Mindtrek Conference*, (2016)

11. Hevner, A.R., March, S.T., Park, J.: Design Science in Information Systems Research. *MISQ*, Vol 28, No 1 (2004)
12. March, S.T., Smith, G.F.: Design and Natural Science Research on Information Technology (1995)
13. Vaishnavi, V., and Kuechler, B.: Design Science Research in Information Systems. (2004)
14. Haj-Bolouri, A., Bernhardsson, L., and Rossi, M.: PADRE: a Method for Participatory Action Design Research. *DESRIST2016*, LNCS 9661, pp. 19-36, (2016)
15. Bilandzic, M., and Venable, J.: Towards a Participatory Action Design Research: Adapting Action Research and Design Science Research Methods for Urban Informatics. *J. Community Inform*, (2011)
16. Mullarkey, M.T., Hevner, A.R.: Entering Action Design Research. *DESRIST2015*, LNCS 9073, (2015)
17. Keijzer-Broers, W., de Reuver, M.: Applying Agile Design Sprint Methods in Action Design Research: Prototyping a Health and Wellbeing Platform. *DESRIST2016*, LNCS 9661, pp. 68-80, (2016)
18. Stemler, S.: An Overview of Content Analysis. *Practical Assessment, Research & Evaluation*. 7 (17). (2001).
19. Krippendorff, K.: Content Analysis: an Introduction to its Methodology (2nd ed.). Thousand Oaks, CA: Sage. p. 413, (2004).
20. Chandra Kruse, L., Seidel, S., and Puro, S.: Making use of Design Principles. *DESRIST2016*, LNCS 9661, pp. 37-51, (2016).
21. Rittel, H., and Webber, M.: Dilemmas in a General Theory of Planning. *Policy Sciences*, Vol. 4, pp. 155-169. (1973)
22. Paulhus, D.L., and Vazire, S.: The Self Report Method. In R.W. Robins, R.C. Fraley, and R.F. Krueger (Eds.), *Handbook of Research Methods in Personality Psychology*, pp. 224-239, (2007)
23. Flanagan, J.C.: The Critical Incident Technique. *Psychological Bulletin*, (1954)
24. Bradley, C.P.: Turning Anecdotes into Data: the Critical Incident Technique. *Family Practice*, Oxford Univ Press, (1992)

Positioning Living Labs within Action Design Research: Preliminary Findings from a Systematic Literature Review

Giovanni Maccani^{1*}, Shane McLoughlin¹, David Prendergast², Brian Donnellan¹

¹ Maynooth University, Co. Kildare, Ireland

{giovanni.maccani, shane.mcloughlin, brian.donnellan}@nuim.ie

² Intel Corporation

david.k.prendergast@intel.com

Abstract. In recent years, Living Labs (LLs) are emerging as relevant design methodologies among IS researchers. Prior research leveraged Action Design Research (ADR) to position LLs within this discipline. Through a systematic literature review, this paper proposes the positioning of LLs' methodologies within ADR. Based on preliminary findings of this study, we argue that, whilst LL's offer an opportunity to advance learning in ADR in several ways, some critical divergences can be identified in the literature to-date between the two methodologies.

Keywords: Living Labs · Action Design Research · Systematic Literature Review

1 Introduction: Living Labs and IS Research

The concept of Living Labs (LLs) is ascribed to be firstly introduced by MIT Professor William Mitchell in the context of urban planning and city design [1]. The central idea was about bringing citizens together for the design of solutions for their homes. These concepts were taken up and pushed forward in 2005 by the European Commission with the establishment of the European Network of Living Labs (ENoLL). The rationale of LLs concerns enabling users' involvement in the conceptualization, design, and evaluation of new solutions, products and services in real-life environments. Whilst, academic publications on LLs began to appear in 2005. Surprisingly, today, LLs have not yet entered Information Systems (IS) mainstream literature. In this way, recent literature acknowledges that "a theoretical and methodological gap continues to exist in terms of the restricted amount and visibility of living lab literature" [2] and, subsequently, its contributions to research [3]. In order to address this issue, IS scholars [4] started to propose LLs as a new form of Design Science Research (DSR) [5]. Following [6], Thapa et al. [7] propose LL as an exemplar of "the growing interest in conceptualizing the artefact in socio-technical terms, where the artefact is regarded not only as a stand-alone piece of technology, but also as something that is significantly interwoven with organizational and social elements and related logics" (p.2), thus relating LLs to

Action Design Research (ADR) methodology [8]. In this way, one attempt has been made in IS literature to compare ADR and LLs [9]. Their study reflects on a methodological overlap between LLs and ADR projects on the basis of four LL methodologies examined [10, 11, 12, 13] and their fit within the four activity-blocks and cycles of ADR (i.e. Problem Formulation, Building Intervention and Evaluation, Reflection and Learning, and Formalization of Learning) [8]. Based on these reflections, Coenen et al. [9] conclude that “Living Labs Methods are congruous with ADR” (p.4037).

In summary, our research focuses on establishing LLs as an IS methodological guidance for the iterative design and evaluation of IS-related artefacts in user-driven open innovation environments. In this research in progress paper, in response to previous research [9], we argue that before establishing LLs as an instance of ADR, some challenges need to be overcome. In particular, through a Systematic Literature Review (SLR) study we have undertaken on LLs methodologies, we propose a positioning of twenty different LL methodologies systematically identified in the literature to-date (within and beyond IS) within ADR.

This paper is structured as follows: section 2 outlines the SLR method that has been carried out. Section 3 focuses on the analysis of twenty LL methodologies and their positioning within the four phases of ADR. Ultimately, Section 4 proposes preliminary findings of this research and future research avenues that will be undertaken towards establishing LLs as a design-related methodological guidance for IS researchers.

2 Living Labs Systematic Literature Review

The Systematic Literature Review Process adhered to Okoli and Schabram’s 8 step methodology [14]. These steps are: (1) Purpose of the Literature Review, (2) Protocol and Training, (3) Searching for the Literature, (4) Practical Screen, (5) Quality Appraisal, (6) Data Extraction, (7) Synthesis of Studies, and (8) Writing the Review. In our case, this study was conducted to analyse the stream of research connected to Living Labs. In this way, the review question (RevQ) defined was: what are the proposed phases in Living Labs methodologies? To answer this RevQ, we used as guidance the Concept Matrix method proposed in [15]. Concerning the third step of [14]’s method, we considered both general and specific subject (i.e. related to IS) databases for searching academic literature. We searched across Google Scholar, Scopus, and the “AIS Basket of 8”. Given that the focus of the papers should be on methodological contributions to Living Lab research, the search strategy entailed searching for “Living Lab(s)” in the title or the keywords of academic papers.

In total, we collected 1,143 unique English language papers (after cleaning) from Scopus and GS, though the search across the “AIS Basket of 8” did not produce any result. We subsequently screened papers by analysing titles. At this stage, 427 articles were further considered. At this step, abstracts were read and 169 papers selected for final screening and extraction, by reading the full papers. In particular, we verified their consistency with the RevQ and identified twenty unique contributions for answering our RevQ (i.e. papers in which a unique LL methodology is outlined).

Consistent with the lack of LL-related publications in the mainstream literature, we did not undertake further evaluation of the quality of the papers as a further exclusion criterion, beyond selection of peer reviewed conference and journals only. At this stage, we had arrived at relevant articles needed to answer our RevQ, and proceeded to extraction and synthesis of twenty methodologies found through our SLR process.

3 Positioning Living Labs Methodological Phases within ADR

When extracting the data from these papers we developed an outline of each methodology based on the stages / phases proposed. All phases extracted from the methodologies identified were mapped using Webster and Watson's [15] Concept Matrix technique based on the four phases of ADR: (1) Problem Formulation; (2) Building Intervention and Evaluation; (3) Reflection and Learning; and (4) Formalization of Learning. While engaged in this exercise, we noticed that a number of LL methodologies include a set-up stage prior to the actual problem formulation. Although we recognize that activities such as ensuring long-term commitment and setting up roles and responsibilities are part of ADR (specifically at the end of the problem formulation stage) [8], these were considered separately within the developed concept matrix (see Appendix 1). As shown in Appendix 1, this exercise enabled us to achieve a comprehensive understanding on if and how (and how much) different LLs methodological phases can be positioned within ADR. The following sub-sections provide reflections for each of the four phases.

3.1 Set-up and Problem Formulation

In ADR, the problem formulation stage is drawn upon 2 principles: (1) *Practice Inspired Research*, and (2) *Theory Ingrained Artefact*. Sein et al. [8] acknowledge that a number of inputs can be leveraged for this phase including: practitioners, end-users, researchers, existing technologies, and review of existing research. The problem provides the motivation for undertaking the research effort.

In the context of LL methodologies, as shown in Appendix 1, 11 problem formulation phases were outlined across the 20 methodologies identified. The common denominators across these problem formulation stages are: (1) the active involvement of end-users; (2) the prior establishment of the LL's participants, their roles, and their responsibilities. However, two different typologies emerge from the literature. The first refers to the focus on identifying an actual problem (e.g. "when a change in a political legislation occurs" [16]) or need, emerging from the early stage interaction with members of a defined community [12]. The second one sees a problem or need emerging from predefined usage scenarios [17, 18], general classes of product or services [19], or particular technology-related prototypes or ideas [20]. From another angle, in LLs, this process can be supported by either the identification of an actual problem [10, 13, 16, 18] or through an appreciative form of enquiry for the generation and formalization of needs [12, 20]. Both approaches comply with ADR's Practice Inspired Research prin-

principle. In fact, in ADR a problem can be “perceived in practice or anticipated by researchers” [8, p.40]. In relation to the latter, it is noted that the process of generating and formalizing needs is seen as the result of research activities conducted with representatives of communities of users in which researchers are responsible for extracting and analysing narratives to finally generate and prioritise users’ needs (e.g. [21]).

On the other hand, the role of theories (i.e. “the power to generalise” [22]) and the need for theory-ingrained artefacts do not emerge as a scope of LL methodologies to-date. One further difference is that set-up activities are undertaken in different stages of the two methodologies. Whereas in ADR activities such as ensuring long-term commitment and assigning roles and responsibilities are undertaken after the problem has been substantially formulated, in LLs these activities are completed prior to the problem formulation stage.

3.2 Building Intervention and Evaluation

This second stage of ADR proposes the implementation of design, intervention, and evaluation cycles. These are undertaken as an iterative process in a defined environment in which design, testing, and evaluation activities operate concurrently. Although Sein et al. [8] distinguish between Organizational and IT dominant cycles based on the actual nature of the artefact, this stage is drawn upon 3 principles: (3) *Reciprocal Shaping*; (4) *Mutually Influential Roles*; and (5) *Authentic and Concurrent Evaluation*.

In LLs methodologies, the design and evaluation processes involve two different levels of iteration finally constituting a spiral process [12]. On a higher level, three iterations are generally proposed in terms of concepts, prototypes and final solutions [12, 17, 18, 23, 24]. The second level of iteration typically involves design, testing / trial, and evaluation cycles within each of these stages. Similar to ADR, these activities are meant to inform actions towards refining the artefact that is being designed (across its concepts, prototype, and final system iterations).

In relation to Principle (3) of ADR, it is noted that intervention in ADR is often described as experimentation in LLs, e.g. [18, 25]. Most of the proposed experimentation and evaluation stages of LLs are undertaken in “naturalistic, natural, and real life settings” [12]. The potential mismatch between LL and ADR in relation to this principle reflects the differences between intervention in ADR and experimentation in LLs. In fact, the shaping in LLs is unidirectional, i.e. the setting shapes the artefact that is being designed. The only exception is [10]’s methodology. This was partially drawn from Baskerville’s Action Research process [26]. However, as shown in previous research, ADR is understood as a specific case of Design Science Research in which action is incorporated as opposed to a specific approach of Action Research per se [27]. Overall, we argue that Principle (3) of ADR is not reflected in current formulations of LL methodologies. On the other hand, significant overlap is found for Principles (4) and (5). In relation to the former, the fact that all participants within the LL team have influential roles in the design, experimentation and evaluation activities is well acknowledged. Most of the methodologies found in the literature indicate this process as co-design, e.g. [28], or co-creation, e.g. [29]. Furthermore, this aspect is supported by one of the key principles of LLs: “influence” [12]. This stresses the importance of viewing “all

stakeholders” [30] (i.e. the LL team) as active and competent partners in the design process.

Finally, Principle (5) is at the heart of both ADR and LL methodologies. In fact, likewise ADR, design and evaluation in LLs are undertaken concurrently [11]. Also in alignment with ADR, two main iterative evaluation stages are proposed in LLs. In particular, the “alpha version” proposed in ADR is reflected in the evaluation of the actual usability of the prototype in LLs [12, 31], therefore contributing to the refinement of the artefact itself; on the other hand, the focus on the “beta version” of ADR is referred in LLs as the evaluation of the user experience of the final system [12].

3.3 Reflection and Learning

As shown in Appendix 1, only one of the LLs methodologies we found in the literature proposes a stage that partially overlaps with the Reflection and Learning stage of ADR. In this way, Schaffers et al. describe their “Learning” [10] phase as follows: “outcomes of the evaluation phase serve as input for the next development cycle. In a sense the spiral of incremental improvements eventually leads to the best fit of solution closest to the engineering target point” [10, p.6]. It is clear that this phase differs significantly from stage 3 of ADR which focuses on moving “conceptually from building a solution for a particular instance to apply that learning to a broader class of problems” [8, p.44]. Therefore, we argue that the Reflection and Learning stage of ADR (and subsequently principle (6) *Guided Emergence* upon which it is drawn) is lacking in LLs methodologies to-date.

3.4 Formalization of Learning

The last phase of ADR emphasizes the need for moving from “the situated learning [...] to general solution concepts for a class of field problems” [8, p.44]. This phase is drawn upon Principle (7) *Generalized Outcomes*. This conceptual move is argued in ADR as being required at three different levels: (a) generalization of the problem; (b) generalization of the solution; and (c) derivation of the design principles from the research design process. As shown in Appendix 1, LL methodologies propose set of activities to be conducted with the objective of moving from a solution in a specific real-world context, to a situation in which the artefact is commercialised [12, 29, 31, 32]. Other LL methodologies similarly stress the importance at this stage of fostering adoption and diffusion of the final artefact [13, 16, 19, 28]. This is meant as enabling market entry of the LL’s outcome [31] thus enabling scalability of the artefact [13]. Although this seemingly overlaps with Principle (7) of ADR, it is noted that scalability is understood in a commercial sense only. In other words, LLs methodologies do not address issues in terms of generalizability of the design principles and subsequently, of the contribution to existing theory from the researchers involved in LLs. In summary, we argue that LLs overlap with only two of the three levels proposed within the Formalization of Learning phase of ADR (i.e. generalization of both the problem and the solution).

4 Preliminary Findings

Preliminary findings from this study demonstrate that although LLs might seem congruous for ADR [9], some critical issues and differences still exist. These issues were outlined in the previous section of this paper. In particular, our SLR study demonstrates that ADR's Principles (2), (3), (6), and (partially) (7) are not reflected in current LL methodologies. These divergences support the fact that ADR aims at developing generalised prescriptive knowledge, whereas LLs' outcomes tend to be much more immediate, contextualised, and practice-oriented. In fact, existing methodological approaches do not address the need for academic researchers to reflect on the theoretical learning and to proceed towards its formalization into a contribution to existing IS theories. Partially related to this, the role of theory within LL's studies is vague and unclear. This is in contrast with the Theory-Ingrained Artefact proposition of ADR.

As part of our future research, multiple case studies will be carried out with a specific focus on how academic researchers can formalize the learning (e.g. design patterns and principles) from LLs-based design projects. The preliminary findings presented in this research in progress paper suggest that whilst LL's offer an opportunity to advance learning in ADR in several ways (e.g. its extension beyond organizational settings and its applicability in open environments), LLs should benefit from ADR in terms of conceptualizing and formalizing the prescriptive learning of these processes.

Acknowledgements. This research is funded by LERO, Science Foundation Ireland, and Intel Corp.

3. Schuurman, D., "Bridging the gap between Open and User Innovation? exploring the value of Living Labs as a means to structure user contribution and manage distributed innovation". Diss. Ghent University, 2015.
4. Krogstie, John., "Bridging research and innovation by applying living labs for design science research", Scandinavian Conference on Information Systems. Springer, 2012.
5. Hevner, A., March, S. T., Park, J., Ram, S., "Design science in information systems research". *MIS quarterly*, 28(1), 75-105, 2004.
6. Rossi, M., Henfridsson, O., Lyytinen, K. Siau, K., "Design Science Research: The Road Traveled and the Road That Lies Ahead". *Journal of Database Management*, 24(3), 2013.
7. Thapa, D., Harnesk, D., Ståhlbröst, A. Padyab, A.M., "Make way for the new wave: Living Labs as a DSR Approach". *IS Research Seminar in Scandinavia: IRIS 37*, 2014.
8. Sein, M.K., Henfridsson, O., Purao, S., Rossi, M. Lindgren, R., "Action design research". *MIS quarterly*, 2014, p.37-56.
9. Coenen, T., Donche, V. Ballon, P., "LL-ADR: action design research in living labs". In 48th Hawaii International Conference on System Sciences (pp. 4029-4038), IEEE, 2015.
10. Schaffers, H., Garcia Guzman, J. Merz, C., "An Action Research Approach to Rural Living Labs Innovation". *Collaboration and the Knowledge Economy*, IOS Press, 2008.
11. Pierson, J., Lievens, B., "Configuring living labs for a thick understanding of innovation". *Ethnographic Praxis in Industry Conference Proceedings*, Blackwell Publishing, 2005.
12. Bergvall-Kareborn, B., Hoist, M., Stahlbrost, A., "Concept design with a living lab approach". In 42nd Hawaii International Conference on System Sciences, IEEE, 2009.
13. Tang, T., Hämäläinen, M., "Living lab methods and tools for fostering everyday life innovation", 18th International Conference on Engineering Technology and Innovation, 2012.
14. Okoli, C., Schabram, K., "A guide to conducting a systematic literature review of information systems research". *Sprouts Work. Pap. Inf. Syst*, 10(26), 2010.
15. Webster, J., Watson, R. T., "Analyzing the Past to Prepare for the Future: Writing a Literature Review", *MIS Quarterly*, 26(2), p. 13-23, 2002.
16. Jessuru, B., Rukanova, B., Tan, Y.H., "Analyzing Living Labs as part of the complete innovation development process". *EIS 2008 Proceedings*, p.9, 2008.
17. Molinari, F., "Living labs as multi-stakeholder platforms for the egovernance of innovation". 5th International Conference on Theory and Practice of Electronic Governance. ACM, 2011.
18. Vicini, S., Bellini, S. Sanna, A., "User-driven service innovation in a smarter city Living Lab". In *International Conference on Service Sciences* (pp. 254-259). IEEE, 2013
19. Corallo, A., Latino, M.E. Neglia, G., "Methodology for User-Centered Innovation in Industrial Living Lab". *ISRN Industrial Engineering*, 2013.
20. Johansson, L.O., Snis, U.S. Svensson, L., "The dynamics of interaction: exploring a living lab innovation process from a community of practice perspective". In *Proceedings of Pacific Asia Conference on Information Systems (PACIS)*, 2011.
21. Ståhlbröst, A. Bergvall-Kåreborn, B., "Living Labs–real-world experiments to support open service innovation". In *eChallenges e-2011 Conference*, 2011.
22. Gregor, S., "The Nature of Theory in Information Systems". *MISQ*, 30(3), p.5, 2006.
23. Lucassen, I., Klievink, B. Tavasszy, L., "A Living Lab Framework: Facilitating the Adoption of Innovations in International Information Infrastructures". In *Transport Research Arena (TRA) 5th Conference: Transport Solutions from Research to Deployment*, 2014.
24. Schuurman, D., Lievens, B., Coorevits, L., De Meulenaere, J., Georges, A., Vandenbroucke, K. Baccarne, B., "Living labs for in-situ open innovation: from idea to product validation and beyond". In *17th ACM Conference on Computer Supported Cooperative Work*, 2014.

25. García-Guzmán, J., del Carpio, A.F., De Amescua, A. Velasco, M., “A process reference model for managing living labs for ICT innovation: A proposal based on ISO/IEC 15504”. *Computer Standards & Interfaces*, 36(1), pp.33-41, 2013.
26. Baskerville, R.L., “Investigating Information Systems with Action Research”. *Communications of the Association for Information Systems*, 2(1), p.19, 1999.
27. Maccani, G., Donnellan, B. Helfert, M., “Action design research: a comparison with canonical action research and design science”. *Research-in-Progress Papers from the 10th International Conference, DESRIST 2015*.
28. Coenen, T., van der Graaf, S. Walravens, N., “Firing up the city-a smart city living lab methodology”. *Interdisciplinary Studies Journal*, 3(4), p.118, 2014.
29. Katzy, B.R., Baltés, G.H. Gard, J., “Concurrent process coordination of new product development by Living Labs—an exploratory case study”. *International Journal of Product Development*, 17(1-2), pp.23-42, 2012.
30. Feurstein, K., Hesmer, A., Hribernik, K.A., Thoben, K.D., Schumacher, J., “Living Labs: a new development strategy”, *European Living Labs-a new approach for human centric regional innovation*, pp.1-14, 2008.
31. Schumacher, J. Feurstein, K., “Living Labs-the user as co-creator”. In *Technology Management Conference (ICE), IEEE International* (pp. 1-6), 2007.
32. Pallot, M., Pawar, K. Santoro, R., “A user experience framework and model within experiential living labs for Internet of Things”. In *Engineering, Technology and Innovation (ICE) Conference, IEEE*, 2013.

Evaluating a Mobile Crisis Response System for the Management of Disaster Volunteers

Florian Sobiegalla¹, Oliver Posegga¹, Kai Fischbach¹

¹ University of Bamberg, An der Weberei 5, 96052 Bamberg, Germany
{florian.sobiegalla, oliver.posegga, kai.fischbach}@uni-bamberg.de

Abstract. As part of an ongoing research project, we have designed and implemented a mobile crisis response system (MCRS), which creates a nexus between relief organizations and unaffiliated disaster volunteers. We developed the MCRS using a design science approach and address information management, coordination, and motivation challenges in the context of managing unaffiliated disaster volunteers in crisis response and disaster relief activities. In this research-in-progress paper, we propose a design for the evaluation of the MCRS prototype based on a field experiment, which will be conducted during a joint mission exercise performed by three major German relief organizations. We adapt the enterprise systems success model and suggest evaluating the system quality, information quality, individual impact, and organizational impact of the prototype.

Keywords: Design Science · Design Research · Evaluation · Unaffiliated Disaster Volunteers · Relief Organizations · Field Experiment · Crisis Response · Mobile Crisis Response Systems

1 Introduction

Relief organizations increasingly find themselves confronted with a scarcity of paid relief workers [1] and even growing frequency of man-made crises [2]. Unaffiliated disaster volunteers who participate voluntarily in disaster relief activities, and who often self-organize via social media [3], play an important role in coping with crisis and disaster situations (e.g., by providing goods, services, and time [4]). For example, when more than 80 percent of Thailand's provinces were surprised by a severe flooding crisis in 2011, citizens used social media to disseminate crisis-related information, provide emotional support, and coordinate their collaborative relief efforts, when authorities and official relief organizations were overwhelmed by the impact of the crisis [5]. The benefits of the volunteers' support, however, comes with the challenge of managing them in crisis situations. Unaffiliated disaster volunteers—that is, individuals not affiliated with official relief organizations who engage spontaneously in crisis response activities—are particularly difficult to integrate into the organizational processes and structures of professional relief organizations. One reason for this is the absence of a technical and organizational nexus between relief organizations and unaffiliated disas-

ter volunteers, which leads to various information management, coordination, and motivation issues that hamper the management of unaffiliated disaster volunteers [1, 6]. Motivational issues, for example, can occur with regards to the sustained encouragement of unaffiliated disaster volunteers. A concern frequently voiced by the relief organization officials we interviewed in the context of this study is the high of degree of volatility in the availability of unaffiliated disaster volunteers. While their help is a welcome resource to relief organizations, unaffiliated disaster volunteers are not bound by formal hierarchies and tend to operate on their own schedule, which can result in work being left undone when they leave without notice. By providing a nexus in the form of a technical artifact that connects unaffiliated disaster volunteers and relief organizations, we enable the integration of unaffiliated volunteers into the organizational structures and processes of relief organizations. In doing so, we aim to overcome some of these issues and improve the effectiveness and efficiency of unaffiliated disaster volunteers in crisis response activities.

As part of an ongoing research project, we have designed and developed such an artifact: a mobile crisis response system (MCRS) to support the management of unaffiliated disaster volunteers. It provides unaffiliated disaster volunteers with a central platform they can use to register as volunteers and offer their help with specific tasks. It offers relief organizations a simple interface for managing tasks with which they need help and allows them to receive information provided by unaffiliated disaster volunteers. In contrast to crisis response systems (CRS) typically used by relief organizations [7], we focus on providing a technical platform to connect unaffiliated disaster volunteers with relief organizations and integrate these volunteers into the organizational processes and structures of the relief organizations. We developed the MCRS using a design science approach [8, 9] and seek to answer the following research question: “Does MCRS usage improve the management of unaffiliated disaster volunteers?” Results from earlier stages of our design science approach have been published in [10]. In this research-in-progress paper, we present the design of our evaluation phase, which is based on a field experiment.

The remainder of this paper is structured as follows: Section 2.1 introduces the research problem we address. Section 2.2 briefly describes the proposed artifact. Section 2.3 focuses on the planned evaluation. Section 3 presents our conclusion.

2 Designing a MCRS

We use the design science approach [8] to develop a design for a MCRS that will support the management of unaffiliated disaster volunteers. This paper covers the first five steps of the methodology proposed by [9]: problem identification and motivation, objectives of a solution, design and development, demonstration, and evaluation (see Fig. 1). Thus far, we have generated a conceptual design based on knowledge drawn from theoretical and practical sources. We implemented this design as a responsive web application, which we demonstrated to relief organization employees, experts in the field, and professionals working on similar projects. We refined the artifact based on their

feedback and repeated this procedure several times before reaching a stable state in the artifact development.

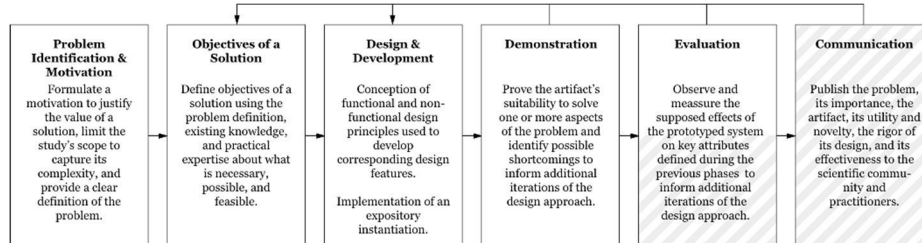

Fig. 1. Research approach; based on the interpretation of [11] of [9]

The following sections briefly illustrate the results of the steps already performed and describe in detail our plans for evaluating the artifact.

2.1 The Problem

We followed a problem-driven approach and conducted open interviews [12] as well as expert workshops [13] with official representatives of the three largest relief organizations in Germany, i.e. German Red Cross, Johanniter-Unfall-Hilfe, and Arbeiter-Samariter-Bund. Similar to organizations like the German Federal Agency for Technical Relief (THW) or UNICEF, the involved relief organizations employ professional full-time helpers, but depend on the support of volunteer helpers, which formally join and affiliate themselves with the organizations. The activity of the organizations involved in our work, however, focuses primarily on emergency services and social services. In this context, unaffiliated disaster volunteers play an increasingly important role in providing additional resources in crisis situations. The goal of this phase was to identify problems arising in the context of managing unaffiliated disaster volunteers in various types of crises and disaster situations. As a result, we defined the problem addressed in this research as follows: There is neither an organizational nor a technological nexus between unaffiliated disaster volunteers and relief organizations, which leads to several information management, coordination, and motivation challenges.

2.2 The Solution

To define the objectives of our solution, we first analyzed research on existing CRS solutions. This allowed us to identify limitations of similar projects and potential challenges for our own solution. In addition, we adopted an empirical approach and conducted semi-structured telephone interviews with the system's stakeholders, i.e. relief organization employees and unaffiliated disaster volunteers, using open-ended questions [12] to develop the conceptual MCRS design. By focusing on both, the relief organizations and the unaffiliated disaster volunteers, we developed a middle ground solution that avoids an overemphasis on the top-down model of disaster management,

which undermines the role of the community [5]. Further, we used user stories to describe the functionality of individual requirements and facilitate discussion about them [14]. These results formed the basis for the next step.

As part of the design and development phase, we derived design requirements for an artifact, which we propose as a solution to the problem identified, by analyzing the data collected in the preceding phases in three consecutive steps: descriptive coding, interpretive coding, and definition of overarching themes, that is, recurring motives [12]. We developed functional and non-functional requirements [15] based on the approach proposed by [16].

In the first step, we derived seven design requirements by integrating the overarching themes identified. Following [16], we then translated these requirements into three general design principles that describe the main functions of the conceptualized system in a generic and abstract manner: improve information management, improve coordination, and maintain engagement. Further, we mapped these principles to 13 concrete design features that would eventually constitute specific ways to implement a design principle in an actual artifact. Those comprise eight functional design features (FDFs) and five non-functional design features (NFDFs). The FDFs are: collect unaffiliated disaster volunteers' data (FDF 1), provide crisis related information to unaffiliated disaster volunteers (FDF 2), provide key performance indicators on volunteer activities to relief organizations (FDF 3), enable data aggregation for analysis (FDF 4), enable the creation of tasks for relief workers to call for support (FDF 5), provide a matching process to recommend tasks to unaffiliated disaster volunteers depending on their skills and qualifications (FDF 6), enable directed communication in the form of task related message boards (FDF 7), and enable broadcast communication in the form of mission-wide notifications and news provided by heads of operations (FDF 8). The NFDFs are: establish different levels of unaffiliated disaster volunteer participation (NFDF 1), enable data privacy (NFDF 2), minimize complexity (NFDF 3), facilitate the provision of insurance to unaffiliated volunteers (NFDF 4), and utilize personal approach (NFDF 5). The core functions of the artifact to address the most important specified design features comprise: a simple registration process; a management interface to create, update, and delete crisis response activities offered to unaffiliated disaster volunteers; message boards to provide a central communication nexus for response activities; and news feeds to distribute official information provided by relief organizations. To improve the coordination of tasks and helpers, we further specify design features for an appropriate matching process that presents available crisis response activities to unaffiliated volunteers who meet potential requirements (e.g., possess a driver's license; have first aid skills). The matching system provides unaffiliated disaster volunteers access to crisis response activities based on their preferences and qualifications. Further, it enables relief workers to prioritize specific activities by recommending them manually to individual volunteers. In addition, we propose features to motivate unaffiliated disaster volunteers during their involvement, such as a low entry threshold for new users, data privacy, and low complexity (for further information on the development of the design features and a more detailed description of the artifact, see [10]).

Finally, we developed an initial prototype of the artifact based on the results of this phase. To account for the unaffiliated disaster volunteers' independence and spontaneity, we implemented a prototype system as a "mobile first" solution by means of a responsive web application with a lightweight user management system. This allows for ad-hoc access using mobile and other devices (e.g., desktop computers). We arranged an expert workshop [13] and asked relief workers to conduct functional tests to demonstrate the artifact to a diverse audience and evaluate its capability for solving the problem. Based on the feedback, we refined the prototype, which will be used in the planned evaluation.

2.3 The Planned Evaluation

This section describes in detail the evaluation phase of our design science approach. Its goal is to measure meaningful characteristics of the artifact and to determine its adequacy for the specified problem [17].

To design the evaluation, we applied the four-step DSR (Design Science Research) evaluation research design method proposed by [18]. We plan to conduct a field experiment [19] to assess the system's quality. The experiment is based on a joint mission exercise which will be performed by the involved relief organizations (German Red Cross, Johanniter-Unfall-Hilfe, Arbeiter-Samariter-Bund). During the exercise, the relief organizations will simulate a crisis scenario under realistic conditions, which are derived from a real natural disaster that took place in a medium-size German city in 2013. During a festival located on the banks of a river, heavy rain resulted in a substantial rise in the river's water level, which in turn caused a rapidly rising flood that confronted the festival's organizers and responsible relief organizations with tremendous challenges. Visitors had to be evacuated from the affected area, and then employees of the relief organizations involved had to manage unaffiliated disaster volunteers who wanted to help with urgent tasks. For example, tents had to be taken down and injured persons provided with care. The situation is ideal for studying the phenomenon of unaffiliated disaster volunteering and to evaluate our artifact.

Within the limits of this mission exercise, we suggest an adjusted post-test only/control group design [20]. Accordingly, we will divide the experiment between two independent groups, the control group and the treatment group. Both groups will perform the same tasks with the same resources. The control group will manage unaffiliated disaster volunteers based on the traditional approach—oral communication—while the treatment group will use the MCRS prototype. Each group will be comprised of three types of participants: relief organization employees responsible for the coordination of the overall mission (i.e., heads of operations); relief workers directly involved in field activities and who are in contact with unaffiliated disaster volunteers; and unaffiliated disaster volunteers who appear spontaneously, are not affiliated with official relief organizations, and engage in self-organized disaster relief activities.

In total, there will be 73 experiment participants: one head of operations, located at a distant command center, who will be directing the operation and coordinating both the treatment and control groups (necessary due to a limitation imposed by the design of the mission exercise that provides the foundation for our field experiment); two

groups of 26 relief workers each (six coordinators and two task forces of ten in each group); and two groups of ten unaffiliated disaster volunteers each. As stated before, both groups of relief workers and disaster volunteers will be given identical assignments comprising various tasks of different natures and complexity and requiring varying degrees of cooperation. Once the experiment is completed, relief workers in the field and unaffiliated disaster volunteers will be asked to complete a survey, and some will participate in follow-up interviews. The head of operations will be interviewed based on differentiated, open-structured questions to analyze the effect of MCRS usage during the evaluation. Figure 2 shows the overall constellation of the experiment.

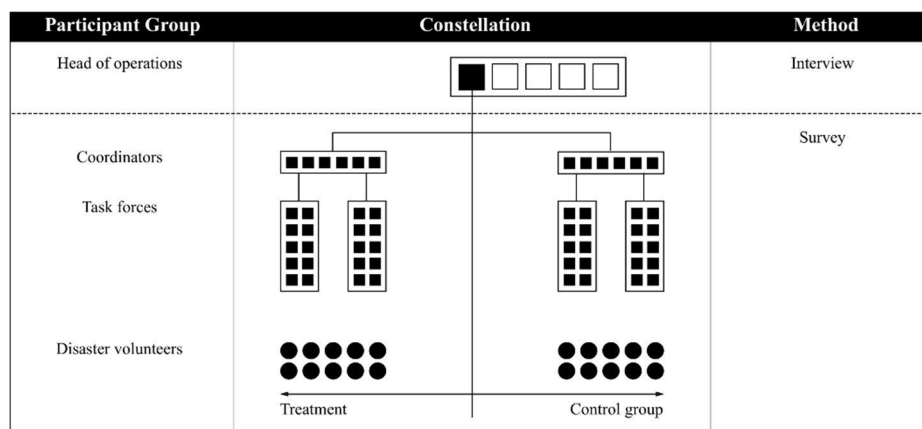

Fig. 2. Experimental Design

The central premise of our artifact's evaluation is to demonstrate that MCRS usage improves the management of unaffiliated disaster volunteers in a crisis context. In other words, we want to prove the success of our proposed design. That is why we use the IS Success Model [21, 22] as a basis for the survey design. In addition to describing a causal/process model of the dependent variable success, the IS Success Model also depicts a measurement model [23]. The model's constructs fit the core elements of the problem identified. Information quality addresses poor information management, individual impact addresses the unpredictable motivation of unaffiliated disaster volunteers, and organizational impact addresses coordination problems. In addition to the adequacy of our solution for the problem identified, we want to understand the artifact's system quality based on the respective constructs. Therefore, we use the proposed constructs as dimensions to design an adequate survey instrument. We adapt the Enterprise

System Success Model proposed by [21] to the context introduced and use it accordingly. For this purpose, we remove measurements that are not relevant for the context of an MCRS and add three additional constructs. The result is a model consisting of four dimensions: system quality (seven measurements), information quality (six measurements), individual impact (seven measurements), and organizational impact (five measurements) (see Table 1). The added constructs are necessary to measure properties that are distinctive for a MCRS and that are not part of a typical enterprise system. Both

matching effectiveness and matching efficiency address the quality of the implemented matching process, which helps to coordinate the accrual of tasks and available helpers. Similarly, we added a construct to determine the prototype’s effect on unaffiliated disaster volunteers’ motivation to maintain their engagement. We use the term “system” for the MCRS prototype in using the dimension system quality for both experimental groups; the term also describes the traditional system of managing unaffiliated disaster volunteers.

Table 1. Adaption of the *Enterprise System Success Model* [21]

System Quality		Information Quality		Individual Impact		Organizational Impact	
SQ1	Ease of use	IQ1	Availability	II1	Learning	O11	Organizational costs
SQ2	Ease of learning	IQ2	Usability	II2	Awareness/ Recall	O12	Staff requirements
SQ3	User requirements	IQ3	Understandability	II3	Decision effectiveness	O13	Increased capacity
SQ4	System features	IQ4	Relevance	II4	Individual productivity	O14	Overall productivity
SQ5	System accuracy	IQ5	Format	II5	Matching efficiency*	O15	Improved outcomes
SQ6	Flexibility	IQ6	Conciseness	II6	Matching effectiveness*		Cost reduction [†]
SQ7	Integration			II7	Motivation*		e-Government [†]
	Sophistication [†]						BP Change [†]
	Customizability [†]						

[†]removed, * added

The treatment and control groups will receive the same surveys. The first survey will be administered to relief workers in the field (i.e., the second type of participants described earlier) and will include all four described dimensions. The second survey will be administered to unaffiliated disaster volunteers (i.e., the third type of participants) and will comprise all but the last dimension, since this group is not part of the organization itself. The additional interviews with both participant types, as well as the open-structured interview with the head of operations, will also be based on these dimensions, but will leave room for additional comments and detailed feedback.

Since the size of the experiment and the number of participants is subject to limitations beyond our control, we plan to conduct qualitative and descriptive analyses of the results to assess the design’s success. If the feedback is unsatisfactory, we will revisit the design phase and revise our solution. Otherwise, the design study will enter the concluding communication phase.

3 Conclusion

The focus of this research-in-progress paper is on developing an appropriate evaluation design to determine the artifact’s adequacy for the problem of managing unaffiliated disaster volunteers during crisis response activities. To complete the study, we need to conduct the actual evaluation of the prototype. In particular, we need to assess whether the artifact developed, when used as part of managing unaffiliated disaster volunteers, increases the effectiveness and efficiency of collaboration compared to existing methods. To achieve this, we propose a detailed plan for a comprehensive field experiment involving 73 participants from all stakeholder groups. Subsequently, we need to analyze the elicited data to assess the success of our design, which may then inform another

build-and-evaluate iteration. If we can successfully test the appropriateness of the artifact for the problem identified, we can move to the last step of the design study—that is, the communication of our results. We plan to present the problem and its importance, the artifact, its utility and novelty, the rigor of its design, and its effectiveness to researchers and other relevant parties [9]. It is especially important to communicate the results of our research to relief organizations so they can employ an appropriate MCRS and improve the management of unaffiliated disaster volunteers.

To interpret the implications of the evaluation design presented, readers should consider the following limitations of our study. The field experiment will be restricted by organizational constraints of the relief organizations involved, which are ultimately responsible for the execution of the experiment. Hence, we have had to adjust the traditional post-test only/control group design. We are aware that the artifact will not be tested under optimal conditions, but we are certain that the field experiment will contribute considerably to the artifact's improvement. If, however, the evaluation we have described should not suffice, we plan to conduct an additional lab experiment that could, for example, place a stronger focus on the head of operations subgroup (the participant of the first type described earlier).

The proposed design provides a nexus in the form of a technical artifact that connects unaffiliated disaster volunteers and relief organizations. Choosing a more general context could result in different or additional design requirements and principles. We expect, however, that the design could be generalized and applied to contexts, in which groups of volunteers are willing to provide their time and resources to solve simple location-based tasks, which are specified and monitored by a coordinating organization (e.g., UNICEF and Doctors Without Borders). The generalizability of our solution is facilitated by the high degree of aggregation with regards to the functional and non-functional design principles and features.

Finally, [22] have shown that there are few design science studies that evaluate instantiated artifacts using illustrative scenarios, which allow for evaluation of the artifact under realistic conditions. Rather, researchers tend to apply limited technical experiments to test instantiations under laboratory conditions. We hope to contribute to the knowledge base about scenario-based evaluations in IS design studies by proposing an exemplary approach based on a combination of a comprehensive field experiment and a customized measurement framework derived from the IS Success Model.

References

1. Sargisson, R.J., Hunt, S., Hanlen, P., Smith, K., Hamerton, H.: Volunteering: A Community Response to the Rena Oil Spill in New Zealand. *J. Contingencies Cris. Manag.* 20, 208–218 (2012).
2. Coleman, L.: Frequency of Man-Made Disasters in the 20th Century. *J. Contingencies Cris. Manag.* 14, 3–11 (2006).
3. Eismann, K., Posegga, O., Fischbach, K.: Collective Behaviour, Social Media, and Disasters: A Systematic Literature Review. In: *Proceedings of the 24th European Conference on Information Systems* (2016).

4. St. John, C., Fuchs, J.: The Heartland Responds to Terror: Volunteering After the Bombing of the Murrah Federal Building. *Soc. Sci. Q.* 83, 397–415 (2002).
5. Leong, C.M.L., Pan, S.L., Ractham, P., Kaewkitipong, L.: ICT-Enabled Community Empowerment in Crisis Response: Social Media in Thailand Flooding 2011. *J. Assoc. Inf. Syst.* 16, 174–212 (2015).
6. Fischer, D., Posegga, O., Fischbach, K.: Communication Barriers in Crisis Management: A Literature Review. In: *Proceedings of the 24th European Conference on Information Systems (2016)*.
7. Yuan, Y., Detlor, B.: Intelligent Mobile Crisis Response Systems. *Commun. ACM.* 48, 95–98 (2005).
8. Hevner, A.R., March, S.T., Park, J., Ram, S.: Design Science in Information Systems Research. *MIS Q.* 28, 75–105 (2004).
9. Peffers, K., Tuunanen, T., Rothenberger, M.A., Chatterjee, S.: A Design Science Research Methodology for Information Systems Research. *J. Manag. Inf. Syst.* 24, 45–77 (2007).
10. Sobiegalla, F., Posegga, O., Fischbach, K.: Connecting Disaster Volunteers and Relief Organizations: A Design Science Approach. *Proc. 37th Int. Conf. Inf. Syst.* (2016).
11. Ernst, S.-J., Janson, A., Söllner, M., Leimeister, J.M.: When in Rome, do as the Romans do – Overcoming Culture Conflicts in Mobile Learning. In: *Proceedings of the 36th International Conference on Information Systems (2015)*.
12. King, N., Horrocks, C.: *Interviews in Qualitative Research*. Sage Publications (2010).
13. Alexander, I.F., Beus-Dukic, L.: *Discovering Requirements: How to Specify Products and Services*. Wiley Publishing (2009).
14. Cohn, M.: *User Stories Applied: For Agile Software Development*. Addison-Wesley, Boston (2004).
15. Sommerville, I.: *Software Engineering*. Pearson Addison Wesley (2007).
16. Meth, H., Mueller, B., Maedche, A.: Designing a Requirement Mining System. *J. Assoc. Inf. Syst.* 16, 799–837 (2015).
17. March, S.T., Smith, G.F.: Design and natural science research on information technology. *Decis. Support Syst.* 15, 251–266 (1995).
18. Venable, J., Pries-Heje, J., Baskerville, R.: A Comprehensive Framework for Evaluation in Design Science Research. In: Peffers, K., Rothenberger, M., and Kuechler, B. (eds.) *7th International Conference, DESRIST 2012*. pp. 423–438. Springer, Berlin (2012).
19. Gerber, A.S., Green, D.P.: *Field experiments: Design, analysis, and interpretation*. WW Norton (2012).
20. Field, A.P., Hole, G.: *How to Design and Report Experiments*. Sage Publications, London (2003).
21. Sedera, D., Gable, G.: A Factor and Structural Equation Analysis of the Enterprise Systems Success Measurement Model. In: *Proceedings of the 24th International Conference on Information Systems (2004)*.
22. Peffers, K., Rothenberger, M., Tuunanen, T., Vaezi, R.: Design Science Research Evaluation. In: Peffers, K., Rothenberger, M., and Kuechler, B. (eds.) *7th International Conference, DESRIST 2012*. pp. 398–410. Springer, Berlin (2012).

If You Want Your Research Done Right, Do You Have to Do It All Yourself? Developing Design Principles for Systematic Literature Search Systems

Benjamin Sturm¹ and Ali Sunyaev¹

¹University of Kassel, Kassel, Germany
{bsturm, sunyaev}@uni-kassel.de

Abstract. A review of existing knowledge builds the foundation of any research project. However, conducting a rigorous and systematic literature search that provides the required literature sample is a complex and tedious task. Existing technical solutions, like literature databases or scientific web search engines, provide only limited support for systematic literature searches, due to their narrow coverage, oversimplified user interfaces, or non-transparent search processes. In this paper, we report the first results of an ongoing design science research project focusing on how to design systematic literature search systems (SLSS) that effectively facilitate systematic literature searches. The meta-requirements and design principles derived in this paper provide a starting point for future research on SLSS. Our research results may also serve as blueprints for new SLSS that increase the comprehensiveness, precision, and reproducibility of systematic literature searches.

Keywords: Systematic literature searches · Design principles · Systematic literature search systems · Design science research

1 Introduction

Even though a review of literature is essential for any academic project [1] and all researchers like to find and use relevant literature, no one likes to search for it, perhaps, with the exception of librarians [2]. Conducting a rigorous literature search is often complex and time-consuming, especially for students and novice researchers [3,4]. However, identifying the literature to be analyzed determines the review's quality [5,6]. Carelessness during the search process will lead to an outdated, scattered, and irrelevant literature sample, which, eventually, reduces the quality of the research output [5]. A rigorous and systematic literature search is therefore a necessity for any high-quality research project [1,4]. To support reviewers, (i.e., researcher who is conducting a literature review) numerous approaches and guidelines exist. The proposed methods range from highly systematic approaches [7,8] to more traditional or narrative reviews [1,5,6,9]. Which method is best suited for a specific review depends on different aspects, such as the research question, available resources, and the topic under review [7,10]. Although there is no universal recipe for conducting literature reviews or

searches [9], any high-quality literature review requires a systematic approach to some degree [1,3,7]. Unsystematic reviews tend to be subjective, give no justification why certain literature is selected, and are often based on a partial examination of the available literature, which might result in inaccurate or even false findings [3,5]. Since it is difficult to draw a line between systematic and narrative reviews [7,10], in this paper we use the term ‘systematic’ synonymously for the degree to which a review follows a rigorous methodology.

Systematic literature searches are regarded as a complex task for different reasons. Due to the limited coverage, a literature search usually requires querying multiple literature databases, each with its own peculiarities (e.g., available features, search fields, and query syntax). This is even more of an issue when the topic under review is interdisciplinary. A good example is the information systems (IS) field, where scientific contributions are published in a wide variety of outlets (e.g., journals and conference proceedings), which are dispersed over numerous databases [4,11]. To address this issue, much research has been dedicated to investigating the applicability of alternative search systems. For instance, scientific web search engines (e.g., Google Scholar) were found to have a higher coverage of scientific outlets in comparison to individual literature databases, while being criticized for their oversimplified search interfaces, undocumented and fluctuating search indexes, and export limitations [12-14]. Another example are scientific meta-search engines, like EBSCO Discovery or ProQuest’s Summon, which are described as efficient but are also found to have a limited coverage and inflexible search interfaces inapt for systematic searches [15,16]. However, unlike studies on existing search tools, research on developing new systematic literature search systems (SLSS) for the specific purpose of facilitating systematic literature searches is scarce. Extant research focuses instead on, for instance, the design of retrieval systems with high user interaction [17], search systems with faceted or symbiotic interfaces [18,19], paper recommender tools [20,21], systems to support synthesis and analysis of research articles [22,23], meta-search engines for individual full-text articles [24,25], specialized web crawler for indexing research papers [26,27], and citation analysis tools for mining academics’ social networks [28,29]. While all these efforts seek to assist researchers during the literature review process, systems or individual features for the specific purpose of conducting systematic, rigorous searches are not investigated. However, a deeper understanding of the design and effects of SLSS would provide not only new design knowledge on this class of systems but also insights into why existing systems fail to sufficiently aid reviewers and guidance on the construction of innovative systems that, eventually, increase efficiency and quality of systematic literature reviews.

To address the existing literature gap, we want to answer the following research question: How to design a SLSS that effectively facilitate systematic literature searches? To approach this question, we use the design science research (DSR) paradigm [30,31]. Our research method consists of multiple design cycles (DC) comprising artifact development, evaluation, and refinement. This paper focuses on the results of the second DC, containing a first set of design principles for SLSS along with their instantiation in form of a prototype web application. We thereby contribute to both research and practice by providing novel design knowledge that may serve as a starting

point for future research on SLSS and guide the development of new information systems that aid reviewers in conducting rigorous, systematic literature searches.

2 Research Method

Following DSR guidelines [30-32], our research method comprises multiple DC. The first DC was informed by initial requirements from the application domain. We identified problems and opportunities through a requirements workshop with seven researchers from the IS field. Furthermore, we reviewed extant research on information retrieval systems and investigated existing artifacts in the application domain. Based on our insights a first prototype application was developed and afterwards evaluated through an expert review with five IS researchers and developers. The results of the expert review demonstrated the technical feasibility of the prototype and showed a necessity for further refinements (e.g., improvements of the search process and usability). Building on the knowledge elicited from the first DC, the goal of the second DC was to develop a first set design principles for SLSS. Design principles serve as an abstract blueprint for the construction of design products or methods [32]. The principles developed in this paper can be classified as materiality oriented design principles [33]. These principles describe the shape and features of an artifact rather than the intended use of the artifact (i.e., action oriented design principles) [33], similar to principles of form and function [30,32]. However, before design principles can be developed, a clear understanding of the purpose of a design artifact in form of meta-requirements is required [30,32]. In the literature search context, meta-requirements should reflect the acknowledged quality criteria for the search process and its results. To expand our initial understanding of the meta-requirements for SLSS, we conducted a systematic literature review of literature review guidelines. Following Webster, Watson [1], we searched the eight top IS journals (AIS Senior Scholar's Basket) and a special issue of the Communications of the AIS (Vol. 37, 2015) on literature reviews. The eight basket journals were selected due to their high methodical rigor and diversity [34], which makes them most likely to publish or reference the acknowledged review guidelines we were looking for. To identify such guidelines and review articles referencing them, we searched in titles, abstracts, and keywords using the broad query 'literature AND review*'. From the resulting 266 articles, 57 articles were either literature review guidelines or review articles referencing at least one guideline in their method section, which were also included (backward search). This way we were able to identify a total of 25 literature review guidelines. After coding all requirements related to either the literature search procedure or its results, we aggregated them incrementally into meta-requirements, as presented in section 3. In the second step, we derived five design principles for SLSS by reflecting on the design knowledge acquired through the first DC and on the insights from our literature review of review guidelines (see section 4). In the third step, we instantiated the developed design principles by refining the existing prototype web application. This allowed us to investigate potential implementations of the derived design principles and provide a first proof-of-concept [35] (see section 5). Finally, we conducted a naturalistic ex-post evaluation of the prototype implementation through nine semi-structured expert

interviews. The experts were researchers from the IS field with high expertise on the literature review process. The interview transcripts were analyzed using an iterative coding process to assess the utility, necessity, and sufficiency of the instantiated design principles. The interview results are briefly discussed in section 6.

3 SLSS Meta-Requirements

Our review of literature review guidelines shows that, despite their different approaches, there is a common understanding in the IS community on criteria that constitute a good literature search. The following three meta-requirements synthesize this understanding.

Comprehensiveness (MR1) of a literature review describes the degree to which all relevant literature on the investigated topic is covered. The main goal of literature reviews is to find the existing body of knowledge. A fragmented literature sample can lead to a partial view on a topic [3,5] and increases the chance that individual biased articles effect the integrity of an entire review [3,36]. A comprehensive overview of extant research is, thus, essential for finding and justifying research gaps [3]. The only way to achieve a comprehensive literature review is a comprehensive literature sample [5]. However, comprehensiveness usually does not equal completeness. Compiling a complete literature sample is usually either inefficient or even impossible [6,37]. Review guidelines therefore suggest “a good or reasonable coverage” [37, p. 246].

Precision (MR2) describes the fraction of documents in a result set that is relevant to the reviewer. Manually identifying relevant documents from a large result set is one of the most time-consuming tasks during a review [37], especially, when applying an iterative search and review approach [6,9]. Because reviewers’ resources are usually limited [7], guidelines recommend the definition of explicit inclusion and exclusion criteria that pre-filter search results. These criteria include selecting appropriate databases (database-centered strategies) or outlets (outlet-centered strategies) as well as parameters like keywords or authors [3,7,10]. However, a more precise search is also more restrictive and more likely to exclude relevant research contributions [37]. A good literature search is therefore both precise enough to exclude as many irrelevant articles as possible and comprehensive enough to include all vital contributions [5].

Reproducibility (MR3) defines the degree to which results of a literature review can be reproduced. A good literature search follows an approach that is reliable (i.e., results do not vary over time) and allows to communicate and justify each process step [4,5]. Hence, one major precondition for reproducibility of literature searches is transparency of the search process [6]. A transparent search process enables reviewers to be explicit about how a literature sample was compiled, including queried data sources (e.g., databases or outlets) and exclusion and inclusion criteria [3,6,7]. A reproducible literature search is more reliable [7,36] and contributes to the credibility of a review [3,4]. Fellow researchers are enabled to assess the exhaustiveness of a literature sample and are encouraged to use and extend a review [4,11]. Furthermore, a reproducible and well documented search process allows to refine previous search steps and increases the chance of publication [1,6].

4 SLSS Design Principles

[DP1] Multi-sourcing: A SLSS needs the ability to access and combine multiple data sources. To address MR1, a comprehensive search has to cover all sources that might contain literature relevant to the topic under review [5,6] and is not limited to one set of journals or geographic region [1]. In the IS field, like most interdisciplinary fields, there is no central literature database. IS related research is published in over 800 outlets [38], which are spread over numerous databases (e.g., ProQuest and AISEL) [5,9]. Even scientific search engines, like Microsoft Academic or Google Scholar, offer only limited coverage [12,13]. Thus, to provide a reasonable coverage for a comprehensive literature search, SLSS must access and merge (without overlaps) data from multiple sources, when either building their own catalogue or querying on behalf of reviewers.

[DP2] Flexibility: A SLSS must be flexible enough to support reviewers' individual search strategies. Reviewers require the ability to formulate search requests that balance the trade-off between comprehensiveness (MR1) and precision (MR2). Since this trade-off is unique for each search, providing the freedom to implement strategies and constraints (i.e., exclusion and inclusion criteria) appropriate for a review's goals and limitations is vital for any search tool [9,37]. Furthermore, a fit between an SLSS's functionality and the researchers' needs will not only lead to a higher task performance but also increases usage acceptance of the system [39].

[DP3] Transformation: A SLSS needs the ability to translate search requests into data-source-specific queries. Increasing comprehensiveness by searching multiple data sources with one request requires multiple queries, due to lack of database standards [9]. Most literature databases have their own request format (e.g., syntax, parameters and wildcards), catalog style (e.g., outlet names), and restrictions (e.g., number of terms or Boolean expressions). Ignoring such peculiarities can lead to unexpected results during a cross-database search [9], and eventually decreases its comprehensiveness, precision, and reproducibility. Hence, SLSS must transform reviewers' requests to take peculiarities of queried data source into account, either for indexing or querying purposes.

[DP4] Transparency: A SLSS must provide transparent information on the search process. Detailed information on how the search results were produced (e.g., queried data sources and outlets, applied parameters) enables reviewers to understand the comprehensiveness of their search and, if necessary, to either extend the search to increase comprehensiveness or document gaps to increase reproducibility [3,4,37]. For instance, the undocumented catalogue of web search engines makes it impossible to determine which sources were searched [12-14], whereas a transparent search tool provides ample information on where and how the presented results were attained.

[DP5] Reliability: A SLSS must produce similar search results for identical search requests. Unpredictable search algorithms or search catalogue with high content fluctuation, like Google Scholar [12,14], will lead to unique search results depending on when the search is performed or by whom [13], no matter how thoroughly the search process is described. To provide reproducible search results (MR3), SLSS not only have to provide a transparent search process but also a stable environment (i.e., catalogues and search algorithms) to replicate results when following this process.

5 Instantiation of the SLSS Design Principles

This section gives a brief overview on the instantiation of the five SLSS design principles in form of LitSonar (<http://litsonar.com>), a prototype web application designed to support systematic literature searches. For an extensive description of the prototype and its development process we refer to Sturm et al. [40]. LitSonar provides unified access to multiple literature databases by utilizing the meta-search approach and, thus, addressing DP1. Reviewers' search requests are dispatched to up to six curated databases containing IS-related literature (e.g., ProQuest and EBSCOhost). By utilizing curated data sources, LitSonar passes their catalogues' stability on to the reviewer, which contributes to the reliability of the search results (DP5). LitSonar's user interface provides two novel features for entering search requests to increase precision (DP2), besides typical filters, like time-span or articles types. First, a flexible keyword editor lets reviewers define complex nested query structures of any depth using graphical elements, instead of the usual "expert mode" (i.e., a single text field), as most databases provide for complex requests. Second, a data-source-selection-form allows reviewers to either select multiple databases directly (database-centered) or compile a list of journals and conferences (outlet-centered). In the latter case, reviewers can choose from individual outlets and predefined lists of outlets based on journal and conference rankings. LitSonar automatically identifies appropriate databases, so that all selected outlets in the specified timeframe are covered.

After receiving a reviewer's request, LitSonar transforms it into database-specific search queries, including the translation of syntax and parameter values (e.g., outlet names) to match the respective format (DP3). During this process, the semantic of queries is altered only with the reviewer's knowledge and consent to keep the search process transparent (DP4) and reliable (DP5). After dispatching the requests to the queried data source, returned results are presented in a homogenous, deduplicated list. Reviewers can browse through the list, download articles, compose individual result lists, and export article references. Additionally, LitSonar provides extensive reports on the coverage of literature databases and outlets to increase transparency of the search process (DP4). The database report shows which databases were searched and how many results per database were found. If a selected database could not be searched, an explicit warning is presented. In that case database-specific search query are provided, along with instructions on how to proceed manually. LitSonar also provides an outlet coverage report, if the reviewer restricted the search to certain outlets. This report gives detailed information about each selected outlet by listing the searched time periods and highlighting gaps in coverage. This information enables reviewers to assess and communicate the exhaustiveness of the conducted search and, if necessary, manually complement the results.

6 Qualitative Evaluation and Next Steps

The evaluation of LitSonar through expert interviews underline reviewers' need for SLSS. The manual search process is described as complex, time-consuming, and error-

prone. Furthermore, we find a fit between LitSonar and the task of systematically searching literature. The interviewed experts express strong intent to use the system. Using the system is expected to have a positive outcome on performance in form of a higher comprehensiveness and efficiency of the search process, which contributes to the quality of literature reviews. These findings indicate the technical feasibility and utility of our prototype implementation and, thus, also give evidence for the relevance of our five design principles. Another interesting finding from the evaluation of LitSonar is that the interview experts mentioned a lack of support from the prototype during the early stages of a systematic literature search (e.g., for identifying relevant search keywords). It was also mentioned that these activities are probably not fully automatable and therefore difficult to implement. This is in line with Levy, Ellis [5], who describe identifying the right keywords as a creative process and a classic cold-start problem. Often several search and analysis cycles are necessary to refine naïve search terms into a complete set of relevant keywords [5]. This finding raises the question of whether SLSS can support the entire systematic literature search process, or even the broader question of what are the limitations of SLSS. To answer these questions, further research is necessary.

In conclusion, we learn that the SLSS design principles and their instantiation are technically feasible and carry the potential to facilitate systematic literature searches. However, to rigorously examine the utility and relevance of the designed artifact and thereby make a valuable contribution to the design knowledge base, LitSonar must be studied directly in the application domain [30,31]. The results from our qualitative evaluation demonstrate that LitSonar reaches a sufficient level of maturity allowing us to subject the prototype to a large-scale field test. Building on the output of the previous two DC, the next steps of our research incorporate a third DC of artifact refinement and evaluation. To evaluate LitSonar's impact on the efficiency and quality of the search process and the acceptance of the artifact by users from the application domain, the prototype will be rigorously examined in a quantitative evaluation. The evaluation will be conducted in course of a large-scale field test at two German universities, allowing us to study LitSonar directly in the application domain. Students and researchers will have open access to the system. The data collection method will include both data logs and a voluntarily questionnaire. Besides completing the third DC, the quantitative evaluation will contribute to the DSR knowledge base. Studying LitSonar in its environment allows us to assess whether the SLSS design principles adequately address the prevailing challenges and improve the application domain as intended by DSR.

The contributions of this paper are twofold. We contribute to research by identifying an initial set of meta-requirements through a systematic literature review, deriving design principles for SLSS, and providing first evidence for their utility. This paper can serve as knowledge repository and starting point for future research on SLSS. Fellow researchers might use the presented design knowledge to explore its relevance in different contexts (i.e., research areas) or develop novel evaluation instruments to measure the suitability of systematic literature search solutions. We also contribute to practice by providing meta-requirements and blueprints (i.e., design principles) for SLSS that facilitate the systematic search process. Developers can use this knowledge to create innovative search systems or add systematic search features to existing solutions. Our

research results could help to increase comprehensiveness, precision, and reproducibility of future systematic literature searches and, eventually, have a positive effect on the overall quality of literature reviews.

References

1. Webster, J., Watson, R.T.: Analyzing the Past to Prepare for the Future: Writing a Literature Review. *MIS Quart.* **26**(2), xiii-xxiii (2002)
2. Tennant, R.: Cross-Database Search: One-Stop Shopping. *Lib. Jour.* **126**(17), 29-30 (2001)
3. Fink, A.: *Conducting Research Literature Reviews: From the Internet to Paper*, 4th ed. SAGE, California (2014)
4. vom Brocke, J., Simons, A., Riemer, K. et al.: Standing on the Shoulders of Giants: Challenges and Recommendations of Literature Search in Information Systems Research. *Commun. AIS* **37**(1), 205-224 (2015)
5. Levy, Y., Ellis, T.J.: A Systems Approach to Conduct an Effective Literature Review in Support of Information Systems Research. *Inform. Sci.* **9**, 181-212 (2006)
6. Wolfswinkel, J.F., Furtmueller, E., Wilderom, C.P.M.: Using Grounded Theory as a Method for Rigorously Reviewing Literature. *Eur. J. Inf. Syst.* **22**(1), 45-55 (2013)
7. Okoli, C., Schabram, K.: A Guide to Conducting a Systematic Literature Review of Information Systems Research. *SSRN Electron. J.* **26**(10), 1-49 (2010)
8. Kitchenham, B., Pearl Brereton, O., Budgen, D. et al.: Systematic Literature Reviews in Software Engineering. *Inf. Software Technol.* **51**(1), 7-15 (2009)
9. Boell, S., Cecez-Kecmanovic, D.: A Hermeneutic Approach for Conducting Literature Reviews and Literature Searches. *Commun. AIS* **34**(1), 257-286 (2014)
10. Boell, S., Cecez-Kecmanovic, D.: On Being 'Systematic' in Literature Reviews in IS. *J. Inf. Technol.* **30**(2), 161-173 (2015)
11. Barnes, S.J.: Assessing the Value of IS Journals. *Commun. ACM* **48**(1), 110-112 (2005)
12. Bramer, W.M., Giustini, D., Kramer, B.M., Anderson, P.: The Comparative Recall of Google Scholar Versus PubMed in Identical Searches for Biomedical Systematic Reviews. *Syst. Rev.* **2**(115), 1-9 (2013)
13. Boeker, M., Vach, W., Motschall, E.: Google Scholar as Replacement for Systematic Literature Searches: Good Relative Recall and Precision are not Enough. *BMC Med. Res. Method.* **13**(131), 1-12 (2013)
14. Beckmann, M., Wehrden, H.v., Palmer, M.: Where You Search is What You Get: Literature Mining. *J. Veg. Sci.* **23**(6), 1197-1199 (2012)
15. Fagan, J.C., Mandernach, M.A., Nelson, C.S. et al.: Usability Test Results for a Discovery Tool in an Academic Library. *Inf. Technol. Lib.* **31**(1), 83-112 (2012)
16. Wells, D.: Library Discovery Systems and Their Users: A Case Study from Curtin University Library. *Aust. Acad. Res. Lib.* **47**(2), 92-105 (2016)
17. Yuan, X., Belkin, N.J.: Evaluating an Integrated System Supporting Multiple Information-Seeking Strategies. *J. Am. Soc. Inf. Sci. Technol.* **61**(10), 1987-2010 (2010)
18. Atanassova, I., Bertin, M.: Faceted Semantic Search for Scientific Papers. Presented at the SemWebEval at ESWC 2014, Anissaras, Greece, May 25-29 (2014)
19. Gamberini, L., Spagnolli, A., Blankertz, B. et al.: Developing a Symbiotic System for Scientific Information Seeking: The MindSee Project. In: *Symbiotic Interaction. Lecture Notes in Computer Science*, vol. 9359, pp. 68-80. Springer, Cham (2015)

20. Beel, J., Langer, S., Genzmehr, M., Nürnberger, A.: Introducing Docear's Research Paper Recommender System. Presented at the 13th ACM/IEEE-CS JCDL, Indianapolis, USA, Jul. 22-26 (2013)
21. Huang, W., Wu, Z., Mitra, P., Giles, C.L.: RefSeer: A Citation Recommendation System. Presented at the 14th ACM/IEEE-CS JCDL, London, UK, Sept. 8-12 (2014)
22. Larsen, K.R., Bong, C.H.: A Tool for Addressing Construct Identity in Literature Reviews and Meta-Analyses. *MIS Quart.* **40**(3), 529-551 (2016)
23. Jonnalagadda, S.R., Del Fiol, G., Medlin, R. et al.: Automatically Extracting Sentences from Medline Citations to Support Clinicians' Information Needs. *J. Am. Med. Inform.* **20**(5), 995-1000 (2013)
24. Santos, R.L.T., Laender, A.H.F., Gonçalves, M.A. et al.: PaMS: A Component-Based Service for Finding the Missing Full Text of Articles Cataloged in a Digital Library. *Inf. Syst.* **35**(5), 544-556 (2010)
25. On, B.-W., Lee, D.: PaSE: Locating Online Copy of Scientific Documents Effectively. Presented at the 7th ICDL, Shanghai, China, Dec. 13-17 (2004)
26. McCallum, A., Nigam, K., Rennie, J., Seymore, K.: Automating the Construction of Internet Portals with Machine Learning. *Inf. Retr.* **3**(2), 127-163 (2000)
27. He, Y., Hui, S.C.: PubSearch: A Web Citation-Based Retrieval System. *Lib. Hi Tech* **19**(3), 274-285 (2001)
28. Chou, J.-K., Yang, C.-K.: PaperVis: Literature Review Made Easy. Presented at the 13th Eurographics, Bergen, Norway, Jun. 1-3 (2011)
29. Chen, H.-H., Gou, L., Zhang, X., Giles, C.L.: CollabSeer: A Search Engine for Collaboration Discovery. Presented at the 11th ACM/IEEE JCDL, Ottawa, Canada, (2011)
30. Gregor, S., Hevner, A.R.: Positioning and Presenting Design Science Research for Maximum Impact. *MIS Quart.* **37**(2), 337-356 (2013)
31. Hevner, A.R., March, S.T., Park, J., Ram, S.: Design Science in Information Systems Research. *MIS Quart.* **28**(1), 75-105 (2004)
32. Gregor, S., Jones, D.: The Anatomy of a Design Theory. *J. Assoc. Inf. Syst.* **8**(5), 312-335 (2007)
33. Chandra, L., Seidel, S., Gregor, S.: Prescriptive Knowledge in IS Research: Conceptualizing Design Principles in Terms of Materiality, Action, and Boundary Conditions. Presented at the 48th HICSS, Kauai, USA, Jan. 5-8 (2015)
34. Hirschheim, R., Klein, H.K.: A Glorious and Not-So-Short History of the Information Systems Field. *J. Assoc. Inf. Syst.* **13**(4), 188-235 (2012)
35. Nunamaker, J.F., Briggs, R.O.: Toward a Broader Vision for Information Systems. *Trans. Manag. Inf. Syst.* **2**(4), 20:21-20:12 (2011)
36. Cooper, H.M.: Scientific Guidelines for Conducting Integrative Research Reviews. *Rev. Educ. Res.* **52**(2), 291-302 (1982)
37. Rowe, F.: What Literature Review is not: Diversity, Boundaries and Recommendations. *Eur. J. Inf. Syst.* **23**(3), 241-255 (2014)
38. Lamp, A.J.: Index of Information Systems Journals. <http://lamp.infosys.deakin.edu.au/journals/>
39. Goodhue, D.L., Thompson, R.L.: Task-Technology Fit and Individual Performance. *MIS Quart.* **19**(2), 213-236 (1995)
40. Sturm, B., Schneider, S., Sunyaev, A.: Leave no Stone Unturned: Introducing a Revolutionary Meta-Search Tool for Rigorous and Efficient Systematic Literature Searches. Presented at the 23rd ECIS, Münster, Germany, May 26-29 (2015)

Representing Business Models in Primarily Physical Industries: An Ecosystem Perspective

Nicola Terrenghi^{1,2}, Johannes Schwarz^{1,2} and Christine Legner¹

¹ University of Lausanne, Faculty of Business and Economics (HEC), Lausanne, Switzerland
{nicola.terrenghi,johannes.schwarz,christine.legner}@unil.ch

² SAP AG, Innovation Center Network, St.Gallen, Switzerland
{nicola.terrenghi,johannes.schwarz}@sap.com

Abstract. The increasing ubiquity of sensors embedded in products enables innovative business logics in physical industries: value is co-created and exchanged among multiple organizations in a collaborative ecosystem. However, current means of business model design and analysis mainly offer an organizational centric perspective. By adopting a design science approach, we develop a model to represent business models in physical industries from an ecosystem perspective. In this research in progress, focused of the automotive industry, we describe the first cycle of problem identification and artifact design, as well as further steps in our approach.

Keywords: Business Ecosystem · Business Model Representation · Design Science

1 Introduction

In 1965, Gordon Moore suggested that the number of transistors, and thus the power, of an integrated circuit would double every two years, while the cost remained the same [1]. In other words, “the continuing miniaturization of computer and communication hardware [...] and more effective power management, has made the vision of ubiquitous computing very close to reality” [2]. This phenomenon, combined with rapidly changing consumer expectations shaped by digital technologies [3], enables the development of new business models (BMs), and organizational forms [4, 5]. Managers perceive the combination of the digital component with their analog product as “extremely challenging” [3]. For instance, car manufacturers are struggling to integrate various forms of computing capabilities into the existing integrated platforms [6]. The viability is also a major hurdle: the design of new BMs with valuable propositions through digital innovation is one of the top managerial concerns in car manufacturing [3]. Automotive is indeed an exemplary industry for research purpose: on-board microprocessors make it possible to design novel services that meet insurance, safety, and maintenance needs [2]. In practice, car connectivity, and therefore access to massive amounts of car data, is broadening the set of players in the car ecosystem, providing new value creation models [7].

This increasing inter-organizational exchange of data and other assets leads to high complexity in business model (BM) analysis and design, where the shift is from organizational to “ecosystemic” focus, or from value creation to value co-creation [8]. In this scenario, an ecosystem perspective in the representation of the business logic is more suited to organizations where both the product and supply and demand chain are digitized [9]. However, while most of BM representations propose an organizational centric perspective [10], only few authors (e.g., Turber et al. 2014) made a first attempt to provide guidelines for designing BMs from an ecosystem perspective. We address this gap by means of a design science approach, building a model for designing and analyzing BMs in physical industries from an ecosystem perspective.

2 Theoretical Background

2.1 Business Ecosystems

“It is no longer enough to think of a firm as a member of a closed system subject to uncontrollable outside shocks. It is actually part of a network that produces its own change” [9]. Building on biological research, [12] theorizes business ecosystems as an economic community that is supported by a foundation of interacting organizations and individuals – the organisms of the business world. Business ecosystems are nested commercial systems where each player contributes a specific component of an overarching solution [13, 14]. This perspective goes beyond suppliers and customers: “Moore expanded previous supply chain network theories to include other organizations such as universities, industry associations and other (non-commercial) stakeholders, as well as the interactions between them” [8]. Through collaboration in a value network, firms exploit their interdependencies and have a competitive advantage over isolated companies, which internalize all components of a value chain [15].

As intrinsic characteristic, business ecosystems do not follow a linear value creation process [14] and many of their players fall outside the traditional value chain [15]. It is not a linear process with upstream and downstream players but a network of companies with many horizontal relations that cooperate to jointly deliver a product or service to a customer, leading to a competition among ecosystems rather than individual organizations [14]. Therefore, the focus needs to shift from linear value creation and capture to value co-creation and co-capture [8].

2.2 Ecosystem Perspective in Business Model Representations

Among the variety of definitions, the BM concept is understood as a “focusing device that mediates between technology development and economic value creation” [16]. With the diffusion of the Internet in the 1990s, The IS community adopted the BM perspective to explain the new ways of value creation and value capture on the Web [17]. Multiple BM representations have been proposed, as combination of components related to either value proposition, creation or capture in the business logic (e.g., [18–20]). These representations are mainly focused on the single organization as core unit

of analysis and therefore not suitable for analyzing the interdependent nature of growth and success of companies evolving in an interconnected context [8, 21].

A broader perspective on BMs, where the focus is on multiple organizations, often defined as “actors”, is suggested by few authors. These perspectives take different shapes, such as ontologies [22, 23] or frameworks [11, 24] and, although they all refer to “multiple actors that co-create value for the same customer” [25], they are labeled with different terms - e.g., ecosystem or value network. At the best of our knowledge, the framework from [11], looking at BMs for Internet of Things, is the only attempt to provide a generic BM representation for primarily physical industries, taking an ecosystem perspective. However, as stated by the authors, such framework has “some limitations concerning the criteria ‘level of detail’” [11]. The component-based ontology from [26] provides instead a fair level of details in representing BMs. However, the authors’ focus, being the artifact designed during the diffusion of the Web, is on “real-world services”, which has different characteristics from today’s ubiquitous computing [2].

3 Proposed Research Approach

The objective of this research is the design of a model to represent BMs in primarily physical industries from an ecosystem perspective. To this purpose, we adopt a design science approach [27], following the method suggested by [28] combined with and adapted according to the four validation gateways proposed by [29]. Overall, our research will provide a contribution to the theory V., design and action [1], since we suggest explicit prescription for designing and analyzing BMs [30]. Table 1 provides an overview of how we apply the method in our research.

Through multiple semi-structured interviews with practitioners, we explore the actual requirements in designing and analyzing BMs from an ecosystem perspective. Secondly, building a taxonomy of the current BM representations (e.g., frameworks or ontologies) [31], we identify the relevant dimensions for our model. The focus on the automotive industry during the design and development phase enables an in-depth analysis of an ecosystem, which is key to reach completeness and effectiveness of the artifact.

Table 1. Design science research approach based on [34] and [35]

<i>Activity</i>	<i>Method</i>	<i>Outcome</i>
Problem identification and motivation <i>Status: ongoing</i>	<ul style="list-style-type: none"> Semi-structured interviews with multiple players in the automotive industry 	<ul style="list-style-type: none"> Collection and analysis of requirements for representing BMs
Definition of solution objectives <i>Status: ongoing</i>	<ul style="list-style-type: none"> Review of extant research Taxonomy of dimensions in current BM representations 	<ul style="list-style-type: none"> Consolidation of dimensions required in the model

	<ul style="list-style-type: none"> • Selection of relevant dimensions according to the requirements collected through interviews 	
<i>Evaluation 1 – Problem formulation, ex ante</i>	<ul style="list-style-type: none"> • Literature review to justify the research gap • Interviews with consultants in automotive industry to justify the problem statement 	
Design and development: <i>Status: ongoing</i>	<ul style="list-style-type: none"> • Iterative prototyping of the artifact in interdisciplinary team, based on specific conceptual modelling language 	<ul style="list-style-type: none"> • Multiple versions of model
<i>Evaluation 2 – Design validation, ex ante</i>	<ul style="list-style-type: none"> • Interviews with multiple industry players to validate design specifications, artifact clarity, simplicity, completeness and applicability 	
Demonstration <i>Status: planned 2017</i>	<ul style="list-style-type: none"> • Multiple pilot workshops with various players from automotive industry and its ecosystem • Cross-industry case study 	<ul style="list-style-type: none"> • Instantiation of the model in artificial setting
<i>Evaluation 3 – artificial setting, ex post</i>	<ul style="list-style-type: none"> • Instantiation of the artifact in workshops to evaluate its effectiveness, robustness and suitability 	
<i>Evaluation 4 – naturalistic setting, ex post</i>	<ul style="list-style-type: none"> • Validation of artifact’ fidelity with the real world phenomenon and its impact in a naturalistic setting, by case studies based on real projects 	
Communication <i>Status: planned 2017/18</i>	<ul style="list-style-type: none"> • Academic conferences • Articles in practitioners’ outlets • Workshop format 	<ul style="list-style-type: none"> • Peer reviewed publications

4 Preliminary Results

4.1 Problem Identification and Motivation (ongoing)

Two semi-structured interviews with a senior consultant in the automotive industry have been conducted so far. The broad knowledge of the interviewee, with about ten years of experience in consulting the major OEMs and their current or potential partners, allowed us to explore the phenomenon in analysis, reaching a good understanding of the current ecosystems in place and how their actors expect these ecosystems to evolve. The interviewee has also stated a first set of dimensions that need to be considered when designing or analyzing a BM from an ecosystem perspective (table 2).

A minimum of other 10 interviews with other actors are planned. In particular, we expect to collect critical dimensions from two OEMs, two startups, two insurances, two automotive suppliers, one roadside assistance provider one digital car-platform provide, one retailer and one public/government institution (e.g., police department).

Table 2. Dimensions for representing BMs from an ecosystem perspective (January 20th, 2017)

<i>Dimension</i>	<i>Description</i>	<i>Interview 1</i>	<i>Interview 2</i>
Actor's jobs-to-be-done	Needs and motivations for each organization and the end user to be part of the ecosystem	X	
Actor's role	Specific label for each actor according to the value they bring to the ecosystem	X	
Criticality degree of each actor	If and how an actor is essential to the viability of the ecosystem		X
Classification of value exchanged	E.g.: data, IP, money, hardware, etc.	X	
Rights on end user	Direct or indirect interaction of each actor with end user		X
Legal constraints	Legal feasibility of a value exchange (e.g., data security)		X
Bottlenecks analysis	Potentially dangerous value flows		X
Ecosystem opportunities	Overall value (revenues) of the ecosystem	X	

4.2 Definition of Solution Objectives (ongoing)

In this phase we aim at reviewing the literature [32] on representations of BMs to identify existing dimensions that might complement the ones identified in the interviews previously described. Through a key word search on AISEL database, a preliminary collection of relevant representations is currently in place. Out of ten representations collected, including ontologies, frameworks and meta-models, we selected those which have a core focus on ecosystem or network of organizations (e.g., value network as component). This selection led to a current set of five BM representations eligible for our taxonomy of relevant dimensions. To develop such a taxonomy for identifying existing dimensions in BM representations, we are following the method proposed by [31] in the information systems literature. This approach leads to a set of dimensions that complement the ones collected through our interviews. Due to paper-length constraints, in table 3 we propose an extract of the dimensions currently composing our model. We label as "TX" those dimensions gathered from the taxonomy of the existing literature and as "IN" the ones proposed by our interviewees.

Table 3. Partial set of dimensions from taxonomy (TX) or interviews (IN) (February 9th, 2017)

<i>Dimension</i>	<i>Example</i>	<i>Source</i>
Actor' role	End user	TX, IN
Actor's jobs-to-be-done	Enhanced infoteinment	IN
Devices	Car, smartphone	TX
Value object	Real-time location	TX, IN

Value classification	Data	IN
Value provider	End user (actor), car (device)	TX, IN
Value target (addressee)	Insurance	TX, IN
Value flow classification	Alpha (generic label)	TX
Legal constraints	EU regulations on data security	IN
Bottlenecks analysis	-	IN

4.3 Artifact Design and Development (ongoing)

In figure 1 we show an instantiation of the current version of the model. In this case the simplified ecosystem is composed of six actors (e.g., OEM), which co-create value for a car driver. Each actor has specific value propositions (upper part of the box) and specific jobs-to-be-done (lower part of the box). Each value proposition can be “plugged” to one or more of the jobs-to-be-done of other actors, working as value flow. Out of the two interviews conducted, six types of value flows have been currently identified: data, software, hardware, intellectual property, money, generic. Potential constraints for each value flow, e.g., legal, are represented with a specific symbol. Further dimensions to be included are currently subject to discussion.

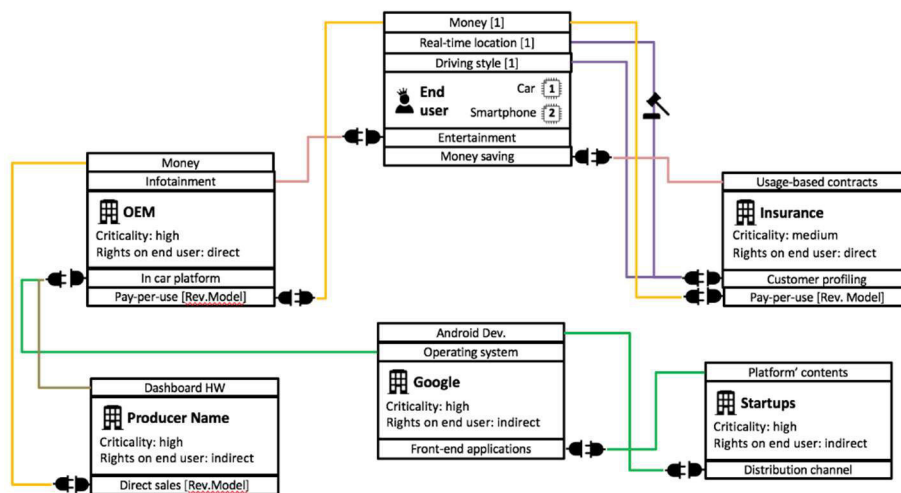

Fig. 1. Instance of the current status of the artifact (February 14th, 2017)

Our current version of the artifact complement the ontology from [33], showing the criticality degree of each actor in the ecosystem, which also enables an evaluation of potentially disruptive bottlenecks. Being privacy and data security critical to today's economy, our model provides also explicit representation of direct or indirect relationships with the end user, as well as potentially disruptive legal constraints. Differently from the framework from [11], our model enables a greater level of details. For instance, our artifact goes beyond the differentiation of monetary and non-monetary benefits, providing six types of value flows and their representation.

5 Further Work

The dimensions collected so far in an exploratory manner are rather generic. By means of in-depth interviews with multiple actors in the automotive ecosystem, we expect to describe specific requirements for representing BMs. This approach is critical to iteratively design and testing the model and improve each composing dimension. Moreover, design principles need to be defined in order to make the model usable by practitioners and scholars.

Although our focus is explicitly on primarily physical industries, we expect to extend our model to industries that leverage connected products to offer services. For instance, we consider public transportation, looking at smart traffic, and therefore potentially relevant for the automotive ecosystem, as relevant case study. The analysis of further industries would increase the generalizability of the artifact which, being focused on the automotive ecosystem, could lack of fundamental elements.

References

1. Gregor, S.: The Nature of Theory in Information Systems. *MIS Q.* 30, 611–642 (2006).
2. Yoo, Y.: Computing in Everyday Life: A Call for Research on Experiential Computing. *MIS Q.* 34, 213–231 (2010).
3. Piccinini, E., Gregory, R.W., Hanelt, A., Kolbe, L.M.: Transforming Industrial Business : The Impact of Digital Transformation on Automotive Organizations. In: Thirty Sixth International Conference on Information Systems. pp. 1–20 (2015).
4. Fichman, R.G., Dos Santos, B.L., Zheing, Z.E.: Digital Innovation as a Fundamental and Powerful Concept in the Information Systems Curriculum. *MIS Q.* 38, 329–353 (2014).
5. Yoo, Y., Boland, R.J., Lyytinen, K., Majchrzak, a.: Organizing for Innovation in the Digitized World. *Organ. Sci.* 23, 1398–1408 (2012).
6. Henfridsson, O., Lindgren, R.: Multi-contextuality in ubiquitous computing: Investigating the car case through action research. *Inf. Organ.* 15, 95–124 (2005).
7. McKinsey&Co.: Monetizing car data. (2016).
8. Iivari, M.M., Ahokangas, P., Komi, M., Tihinen, M., Valtanen, K.: Toward Ecosystemic Business Models in the Context of Industrial Internet. *J. Bus. Model.* 4, (2016).
9. Peppard, J., Rylander, A.: From Value Chain to Value Network: *Eur. Manag. J.* 24, 128–141 (2006).
10. Wirtz, B.W., Pistoia, A., Ullrich, S., Göttel, V.: Business Models: Origin, Development and Future Research Perspectives. *Long Range Plann.* 49, (2015).
11. Turber, S., Brocke, J., Gassmann, O., Fleisch, E.: Designing Business Models in the Era of Internet. In: *DESRIST*. pp. 17–31 (2014).
12. Moore, J.F.: Predators and prey: a new ecology of competition. *Harv. Bus. Rev.* 71, 75–86 (1993).
13. Christensen, C.M., Rosenbloom, R.S.: Explaining the attacker’s advantage: technological paradigms, organizational dynamics, and the value network 1. *ELSEVIER Res. Policy.* 24, 233–257 (1995).
14. Clarysse, B., Wright, M., Bruneel, J., Mahajan, A.: Creating value in ecosystems: Crossing

- the chasm between knowledge and business ecosystems. *Res. Policy*. 43, 1164–1176 (2014).
15. Iansiti, M., Levien, R.: *Strategy as Ecology*, (2004).
 16. Chesbrough, H., Rosenbloom, R.S.: The role of the business model in capturing value from innovation : evidence from Xerox Corporation' s technology spin-off companies. *Ind. Corp. Chang.* 11, 529–555 (2002).
 17. Magretta, J.: *Why Business Models Matter*, (2002).
 18. Osterwalder, A.: *The Business Model Ontology - A Proposition in a Design Science Approach*, (2004).
 19. Gassmann, O., Frankenberger, K., Csik, M.: *The St . Gallen Business Model Navigator*. *Int. J. Prod. Dev.* 18, 249–273 (2013).
 20. Hedman, J., Kalling, T.: *The Business Model: A Means to Comprehend the Management and Business Context of Information and Communication Technology*. In: *Proceedings of the Tenth European Conference on Information Systems*. pp. 148–162 (2002).
 21. Westerlund, M., Leminen, S., Rajahonka, M.: *Designing Business Models for the Internet of Things*. (2014).
 22. Gordijn, J.: *Value based requirements engineering: Exploring innovative e-commerce idea*, (2002).
 23. Al-Debei, M.M., Avison, D.: *Developing A Unified Framework Of The Business Model Concept*. *Eur. J. Inf. Syst.* 19, 359–376 (2010).
 24. El Sawy, O. a, Pereira, F.: *Business Modelling in the Dynamic Digital Space - An Ecosystem Approach*. *Springer Briefs Ser. Digit. Spaces*. 68 (2013).
 25. Storbacka, K., Frow, P., Nenonen, S., Payne, A.: *Designing Business Models for Value Co-Creation*. Presented at the January (2012).
 26. Akkermans, H., Baida, Z., Gordijn, J., Peña, N., Altuna, A., Laresgoiti, I.: *Value webs: Using ontologies to bundle real-world services*. *IEEE Intell. Syst.* 19, 57–66 (2004).
 27. Hevner, A.R., March, S.T., Park, J., Ram, S.: *DESIGN SCIENCE IN INFORMATION SYSTEMS RESEARCH I*. *Des. Sci. IS Res. MIS Q.* 28, 75–105 (2004).
 28. Peffers, K., Tuunanen, T., Rothenberger, M.A., Chatterjee, S.: *A Design Science Research Methodology for Information Systems Research*. *J. Manag. Inf. Syst.* 24, 45–78 (2007).
 29. Sonnenberg, C., vom Brocke, J.: *Design Science Research in Information Systems. Advances in Theory and Practice*. *Lect. Notes Comput. Sci. (including Subser. Lect. Notes Artif. Intell. Lect. Notes Bioinformatics)*. 7286, 9–27 (2012).
 30. Gregor, S., Hevner, A.R.: *POSITIONING AND PRESENTING D ESIGN S CIENCE Types of Knowledge in Design Science Research*. *MIS Q.* 37, 337–355 (2013).
 31. Nickerson, R.C., Varshney, U., Muntermann, J.: *A method for taxonomy development and its application in information systems*. *Eur. J. Inf. Syst.* 22, 336–359 (2013).
 32. Webster, J., Watson, R.T.: *Analyzing the Past to Prepare for the Future: Writing a Literature Review*. *MIS Q.* 26, xiii–xxiii (2002).
 33. Gordijn, J., Akkermans, H.: *Designing and evaluating E-business models*. *IEEE Intell. Syst. Their Appl.* 16, 11–17 (2001).

Enhancing Collaboration through Idea-level Granularity: from Information Sharing Across Security Levels to Collaborative Learning

John T. Nosek¹

¹ Temple University, Philadelphia, PA, 19122, USA
nosek@temple.edu

Abstract. This paper proposes that idea-level granularity is an innovative design construct that has the potential to extend the boundaries of a range of human and organizational capabilities. Two examples are provided of how technology based on idea-level granularity versus document-level granularity can broadly transform collaborative work. Organizational success will depend on enabling sufficient information sharing across teams and organizations while preserving essential confidentiality and integrity. This paper explores the problems of producing and consuming information at different levels of classification and presents how technology based on idea-level granularity can overcome these problems.

Collaborative learning works; but, instructors are frustrated in assessing individual contributions, students complain about freeloading, and worst, freeloaders may fail to learn. Over two years, technology based on idea-level granularity was used to mitigate these flaws by allowing individual contributions within collaborative work to be identified, tracked, and analyzed. Students liked the ability of the instructor to monitor contributions; do not like overwriting other's work, nor other's overwriting their work; and most importantly, enjoyed a more positive group experience than in prior classes.

Keywords: Collaboration Technology · Architecture · Collaboration · Secure Knowledge Sharing · Collaborative Learning · Idea-level Granularity.

1 Introduction

This paper proposes that idea-level granularity is an innovative design construct that has the potential to extend the boundaries of a range of human and organizational capabilities and meet Hevner et al's requirements for design-science research [1].

Evidence of this potential is provided through two examples of how technology based on idea-level granularity versus document-level granularity could transform a broad spectrum of collaborative work. Computer Supported Collaborative Work (CSCW) "as a research area devoted to exploring and meeting the support requirements of cooperative work arrangements ... is basically a design oriented research area [2]." The first describes the problem of enabling collaborative work across security levels,

within and among organizations. The second reports on the use of this technology to support collaborative learning.

In collaborating across security levels, knowledge management is expected to become more people-centric with the growing realization that it is the networking of competent and collaborating people that enable organizational success. Increasingly these teams are ad hoc, consist of people from multiple organizations who may work in different time zones and have dissimilar clearance levels. Organizational success will depend on how well organizations exploit synergies while minimizing risk in collaboration, i.e., enable sufficient information sharing while preserving essential confidentiality and integrity. This paper explores the problems of producing and consuming information at different levels of classification and presents how technology based on idea-level granularity could overcome these problems to enable successful collaboration across security levels at lower costs.

Collaborative learning works; but, instructors are frustrated in assessing individual contributions, students complain about freeloading, and worst, freeloaders may fail to learn. Two critical flaws of existing collaboration learning technologies are: (a) the inability to disassemble the unique contributions of each contributor from the work of the group as a whole; and (b) the inability to represent the instructor as a virtual presence in each group. Technology based on idea-level granularity allows individual contributions within collaborative work to be identified, tracked, and analyzed over time. In essence, the instructor and student become “visible to each other.” This visibility provides an opportunity for the instructor to unobtrusively insert himself or herself into the group process to provide instructor value around identifiable contributions. This paper reports on the use of such technology for two years in advanced, year-long capstone classes in software development.

2 Idea-Level Granularity

Documents are made up of many ideas. Idea-level technology allows the dynamic segmentation of a document into idea-level granularity. It provides a means to tear apart a whole software object, such as a document, into parts; independently control, store, and work separately on the parts; and automatically reconstitute the whole as if never torn apart, but with any changes to the parts incorporated (see Fig. 1).

This technology is structured to be integrated within existing applications to add advanced collaboration functionality. In this way, it leverages existing participant knowledge and advances in the underlying application. For example, instead of requiring users to learn and use a separate, less-capable word processor, this idea-level enabled functionality is currently integrated within MS Word, the leading word processor of choice with superior capabilities.

It is useful to better understand how this idea-level granularity uniquely supports collaboration by comparing it to current technologies that support collaborative work: Sharepoint™ from Microsoft and Google Docs™.

MS Sharepoint™ and Google Docs™ support a document/file-centric view. MS Sharepoint™ provides two types of co-authoring. The first, described by MS as regu-

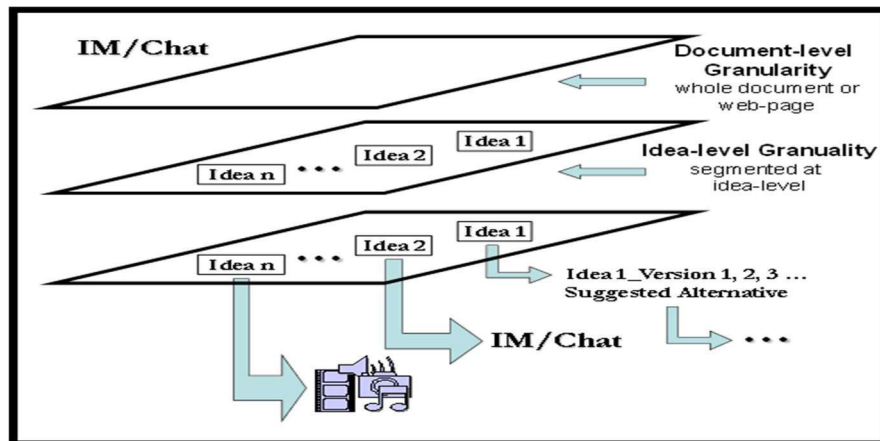

Fig. 1. Idea-level Granularity

lar co-authoring, temporarily locks a paragraph while being updated by others. The second, real-time co-authoring, is similar to Google Docs™. They use concurrency controls to allow users to simultaneously modify the same/document file, i.e., changes are allowed as long as they do not simultaneously conflict with other changes. In essence, they support “Last one in, wins”, i.e., the last one to save the document/file has that version saved. Idea-level granularity enables ideas to be captured as separate nodes in a database. This provides some of the following benefits:

Participants can work in parallel in a controlled way. Ideas can be controlled so that others can not overwrite them. This concept is especially important and deserves more discussion. There is an erroneous, implicit assumption that collaboration is always egalitarian. Users may not like others to overwrite their work and like less overwriting the work of others. There could be multiple reasons for this. In one case, the idea may move in phases to the point where the group feels comfortable with a version of an idea and wants more control over the change, or perhaps someone with the most expertise or authority is given control as to what is acceptable. With idea-level granularity, similar to what we would do socially in other situations, if one does not have control or does not feel comfortable in overwriting, one can suggest an alternative version and provide rationale for this alternative, i.e., why this change is needed. The participant who controls the idea/section can evaluate the suggested alternative and its rationale and accept/reject as he/she sees fit - and even provide rationale for his/her decision.

There is an assumption that simultaneous collaborative work is preferred, however, idea-level granularity better supports the various phases of collaborative work and the preferred method of work for a given phase as identified by Salcedo and Decouchant [3]. They identified five phases: Planning - collaborators establish the objectives, structure, and divide up parts of the shared work product to be created. Creation - collaborators compose their portion of the joint work product. Although they may work alone, it is important that they are aware of what the other collaborators are doing. Evaluation - collaborators review, propose changes, and add comments to each other’s work. Negotiation - collaborators discuss proposed changes with one another and decide on what

changes should be made. Consolidation - collaborators resolve conflicts and merge changes into the shared work product. It should be stressed that these phases are normally not sequential. There is continuing cycling through these phases for different sections of the shared work product, e.g., while negotiation is occurring for one part, creation could be occurring for another part. Dealing with these social, intellectual, and procedural complexities, collaborators work asynchronously and synchronously as they navigate through these phases [4]. Collaborators prefer to work synchronously when planning, negotiating, and consolidating and asynchronously when creating and evaluating.

One can temporarily or permanently identify separate ideas/sections. One can create a segment/idea for control and discussion, but then merge the segment/idea and remove the discussion when agreement has been reached and there is no longer value in segmentation. However, one can also have permanent divisions at the idea-level - for example, the instructor can create a template with segmented divisions. Although control of these divisions can be assigned and further subdivided, as long as the instructor retains control of the section that contains these divisions, they will remain extant, i.e., no one else can remove them.

One can further segment any idea/section into as small a section as one character. This provides the ability for someone who is in control of some idea/section to further subdivide and assign control. This allows for the orderly segmentation of collaborative work.

Any idea/section can be separately opened and worked on independently of others. This can be especially valuable when documents become large. The ability to just open an idea/section saves time and reduces complexity.

Whenever you open up a section/idea that includes other subsections/ideas, the latest versions of these subsections/ideas are automatically incorporated. This eliminates consolidations and allows participants to maintain situational awareness of what others are doing without necessarily opening up the entire document. This is especially difficult, yet critical to effective joint development [5].

Because ideas can remain extant, participants can track versions of ideas not just track versions of the document/file over time. This also allows participants to: track who made the change and at what time; compare versions of ideas not just versions of the document/files; and replace current versions of ideas with earlier versions.

Notification can be targeted so that if one has interest in some ideas and not others, one can be notified when a specific idea changes and directed to that change, rather than be notified at the grosser level that the document has changed. This functionality is complementary and separate from physically segmenting a document into sections/ideas for control and deserves some further discussion. Participants will be able to place watches on regions of interests (ROIs)/ideas. Many times participants have an interest in only one or several parts of a large document when these areas are not under their control and changed by some participant. These ROIs may require their expertise or pertain to their area of responsibility. When an ROI/idea is changed, participants can choose to be notified, via a range of communication channels, and directed to the specific ROI.

It can be recorded when someone reads an idea and one participant can selectively direct comments to those participants based on who has read an idea. For example, in one case, the instructor can monitor those students who have not read an idea yet and direct attention just to those who have not done so. In another case, this ability to monitor who has read an idea can support the process of more effectively and efficiently correcting an error. For example, if there are 30 people in the class and the instructor needs to correct a mistake in a part of the document, the instructor can see that only 2 of 30 have seen the error on this part and direct the attention of those 2 to that item to view the correction, rather than send notices to 28 others who have not seen the error. The instructor can monitor the progress of these 2 students to view the correction without bothering all 30 students with a blanket notice that the document has changed.

One can have chats around ideas, rather than have chats parallel to document creation. With idea-level granularity these are associated with an idea, but not included within the document and the content can be of any format - audio, video, etc. The association is itself important information and there is value, especially to formative and summative evaluations, in associating such discussions/rationale with specific ideas/sections.

Database management tools can be built to analyze these interactions at the idea-level to support formative and summative evaluation.

3 Sharing Information Across Security Levels

This section explores the problems of producing and consuming information at different levels of classification and presents an architecture and strategy based on idea-level granularity to overcome these problems to enable successful collaboration across security levels.

Producers and consumers of classified information require secure access to essential information chunks that exist within documents. “With 14 million new documents stamped secret in 2003, the government created 60% more secrets in 2003 than in 2001 – the biggest jump in secrecy for at least a decade [6]”. This trend has only accelerated. Government and non-government documents usually contain information of various classification levels, but are classified at the highest level. Serious problems include: collaboration across domains and security levels suffers; producers must classify too much information at higher levels; more people need higher security levels than warranted with concomitant increases in administrative costs to investigate; information is less secure while costs to manage escalate; producers restrict access to classified information because they fear leaks when non-essential consumers are granted access; consumers, who are denied access to essential information, fail.

Currently, multiple networks, file servers, and web servers are constructed for each sensitivity level, and individual documents are implicitly labeled by virtue of the network from which they each are accessible. Similarly, a user's workstation is attached to a network matching their clearance level. This separation-of-networks approach has many disadvantages. For example, many users have to use multiple workstations with

consequent high hardware, space, weight, and power costs. In addition, the network infrastructure is inflexible in response to the formation of new coalitions.

Consumers of classified information greatly outnumber producers. Therefore, providing consumers the right access, at the right time will provide immediate benefits while development will be easier and risk of failure reduced. Initially one can build a One-way, Multi-level Secure Access System [7] (see Fig. 2). Data will be stored only at a single level. A One-way Multi-level Security component could be constructed to mediate with a Secure Data Storage System provided by existing companies in the marketplace. Separate instances of the component would run for each security level. The component would only retrieve information from lower security levels, never write to lower security levels (one-way), never collate and display data that is above its security level, and be small to make formal testing easier. Then one can build separate functionality to produce (write) unclassified and classified information. Build one or more separate components for producers of classified information. Ultimately, integrate functionality described above into a single, two-way, multi-level secure access system.

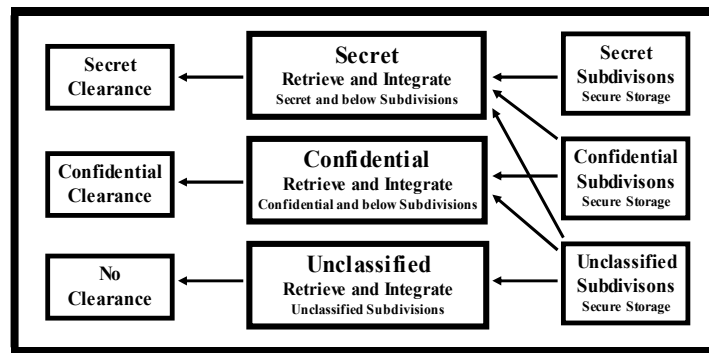

Fig. 2. Multi-level Secure Access System

In summary, idea-level granularity enables securing information to maximize benefits while minimizing costs: 1) Users may never view sections of documents for which they do not have clearance or approval. In fact since parts can be physically stored separately according to their classification, there is never a situation where a document contains classified information above the access level of the viewer. This is a major problem with redaction solutions. In redaction, the sensitive text does exist within the document and expensive, error-prone, and time-consuming actions must be taken to try and insure that it is blocked for certain levels of access before publishing. 2) Control is enhanced by controlling at the part-level what can be done; who can work on a part; when work can be performed; control from where work can be performed; control how work can be performed on a part, i.e., what procedures need to be followed, e.g., require two people at a certain access level, from authorized locations, to input unique codes before access to a part is allowed; and control work on a part based on why the work must be performed, e.g., viewing of a part is permitted in hot pursuit of terrorists in a homeland security emergency. 3) A statement within the shared document may be at a lower classified level, but there may be discussions and rationale associated with the

statement that are at a higher level, e.g., the design requirement for some part, such as a satellite, is specified for manufacturing, but the discussion, or parts of the discussion, for the rationale of the specification may be at a more secure level and not available for consumption by all.

4 Supporting Collaborative Learning

Collaborative learning can improve learning outcomes [8, 9, 10] and engender positive attitudes towards group work while overcoming racial and gender biases [11, 12, 13, 14]. However, teachers are disinclined to use collaborative learning pedagogy because some students freeload and instructors can not identify individual contributions of group members [8]. Freeloaders may fail to learn, and those, who don't freeload, develop negative attitudes towards group work [8, 15].

Mitigating these problems will encourage instructors to incorporate more collaborative learning opportunities, which matches the preference for women and non-traditional students for collaborative strategies. This will result in learning environments that encourage all students, including women and under-represented minorities, to actively engage in and enjoy learning more and develop more positive attitudes towards teamwork.

Virtual Instructional Presence (VIP) encompasses, but extends beyond mere instructor and student social presence. VIP provides information to the instructor about the quality and quantity of student input within the learning process, thus facilitating formative and summative assessments. Idea-level granularity allows individual contributions within collaborative group work to be identified, tracked, and analyzed over time. In essence, the instructor and student become "visible to each other." This visibility provides an opportunity for the instructor to unobtrusively insert himself or herself into the group process to provide instructor value around identifiable contributions. Instructional value includes such things as assessment (evaluation), encouragement, guidance, answers to questions, suggestions, rationale, etc. Content can be provided in almost in any format, such as videos, spreadsheets, voice messages, etc. and can be associated with, but separately stored from, ideas.

Research Method. Technology that supports idea-level granularity was used in multiple sections of the year-long capstone experience taught by the same instructor. Students work with real-world clients over an academic year. Students work in teams of approximately five people to a team, although team size can vary between 4 and 10 people depending on the complexity of the project. In the first semester they learn analysis and design techniques and create detailed analysis and design documents. These documents can become quite large and some have grown to over 100 pages. In the second semester, teams program, test, and develop the user manuals for the application. Online, anonymous surveys were given after the end of the 2nd semester, after grades were assigned. Students were given extra credit before completing the survey based on their professed willingness to complete the survey.

Results & Discussion. Samples from first class (13) and the second (12) were tested for independence and found to be from the same population, so they were combined.

This was the most difficult project ever for most students. We were trying to understand if there is a cut-off point of difficulty where freeloading becomes more important, i.e., for more difficult, complex tasks is it much more important that participants contribute equally and not freeload, and therefore more important for technology to help mitigate freeloading in group work? However, students thought that it was similarly important in prior and current group work that team members needed to contribute equally. Students felt they experienced less freeloading in the current, very demanding group task (although not statistically significant (.18)). Most importantly, students were more satisfied with their group experience at a statistically significant level of .01. It seems reasonable that if higher performing students were more satisfied with more accurate assessment of their contributions and lower performing students freeloaded less, then these two factors can help to explain the greater satisfaction with this group experience.

Students liked the fact that the instructor could more accurately ascertain individual contributions within their group work. Pearson correlations did not show a relationship between grade point average and the desire of students to have instructors assess their contributions. Because of the limited data points, several correlations were run to identify if there was a cutoff point where students would not like this ability, i.e., we collapsed the data into two values based on grade point average. There was a break point at 3.0, i.e., students above 3.0 liked it, but those below did not. There were few grades below 3.0, so this is being reported as something interesting that should be studied more.

Students do not like others overwriting their work and they like capabilities that keep them from overwriting other people's work. These data make sense and require more research. Some examples where the issue of control and overwriting are important include: some may have more expertise on parts of a document than others and should control content; some idea in a document moves to an accepted stage and should not be changed afterwards; instructionally, teachers need to understand who has contributed to ideas within group work and not just be provided with marked up versions that chronicle document changes.

Students were positive about the value of the technology supporting collaborative learning pedagogy. Students were especially positive concerning: technology usefulness, enhanced sharing, virtual nodding, enabling give-and-take with the instructor, and chatting.

5 Summary

Documents are made up of many ideas. Many collaborative processes occur around ideas within a document, while much process support remains at the document/file-level and not at the idea-level. The main purpose of this paper was to challenge accepted practices and explore the effect of moving away from document-level granularity towards idea-level granularity. Idea-level granularity is proposed as a powerful, innovative design construct that can impact a range of human work and organizations.

Two very different applications were presented as examples of how broadly technology based on idea-level granularity can transform collaborative work. One discussed

sharing information across security levels within and among organizations, while the other reported on its affect in collaborative learning.

References

1. Hevner, A., March, S., Park, J., Ram, S.: Design science in information systems research. *MIS Quarterly* 28(1), 75-105 (2004).
2. Schmidt, K., Bannon, L.: Taking CSCW seriously: Supporting articulation Work. *CSCW* 1(1), 7-40 (1992).
3. Salcedo, M., Decouchant, D.: Structured cooperative authoring for the World Wide Web. *CSCW* 6, 157-174 (1997).
4. Tamaro, S., Mosier, J., Goodwin, N., Spitz, G.: Collaborative writing is hard to support: A field study of collaborative writing. *CSCW* 6, 19-51 (1997).
5. Ede, L., Lunsford, A.: Singular texts/plural authors: Perspectives on collaborative writing. Southern Illinois University Press, Carbondale (1990).
6. OpenTheGovernment.org, Secrecy Report Card: Quantitative Indicators of Secrecy in the Federal Government, http://www.openthegovernment.org/otg/secrecy_reportcard.pdf, 2004.
7. Denning, D.: *Cryptography and data security*. Addison-Wesley Longman Publishing Co., Boston, MA (1982).
8. Barkley, E., Cross, K., Major, C.: *Collaborative learning techniques: A handbook for college faculty*. Jossey-Bass, San Francisco (2005).
9. Matthews, R.: Collaborative learning: Creating knowledge with students. In Menges, R., Weimer, M. (eds.) *Teaching on solid ground: Using scholarship to improve practice*, pp. 101-124. Jossey-Bass, San Francisco (1996).
10. Qin, Z., Johnson, D., Johnson, R.: Cooperative versus competitive efforts and problem solving. *Review of Educational Research* 65(2), 129-143 (1995).
11. Abrahamson, A.: An overview of teaching and learning research with classroom communication systems. Paper presented at the International Conference of the Teaching of Mathematics, Village of Pythagorean, Samos, Greece. Retrieved February 3, 2005 from <http://www.bedu.com/Publications/Samos.html>, 1998.
12. Brown, B.: Women and minorities in high-tech careers. *ERIC Digest*, Retrieved January 23, 2006 from <http://www.ericdigests.org/2002-1/high-tech.html>, 2002.
13. Ó Murchú, D.: Mentoring, technology and the 21st century's new perspectives, challenges and possibilities for educators," 2nd Global Conference, Virtual Learning & Higher Education, Oxford, UK, 2003.
14. Palloff, R., Pratt, K.: The role and responsibility of the learner in the on-line classroom. 19th Annual Conference on Distance Teaching and Learning, University of Wisconsin, July, 2003.
15. Miller, J., Trimbur, J., Wilkes, J.: Group dynamics: Understanding group success and failure in collaborative learning. In K. Bosworth and S. J. Hamilton (eds.), *Collaborative learning: Underlying processes and effective techniques*. Jossey-Bass, San Francisco (1994).

The Paradigm of Design Science Research: A Tool-Supported Literature Review

Alexander Herwix¹, Christoph Rosenkranz¹

¹ Professorship of Integrated Information Systems, University of Cologne, Cologne, Germany
{herwix, rosenkranz}@wiso.uni-koeln.de

Abstract. In this paper, a review of the state of the art of theory associated with the young and quickly evolving Design Science Research (DSR) paradigm is presented. The core of the review consists of a structured literature search covering the senior scholars' basket of eight from 1977 until the end of 2016, which resulted in data set of 196 sources. An iterative, selective coding of the title and abstracts revealed four major grounded clusters (138 papers). Three clusters (93 papers) were selected for co-citation analysis and augmented with additional forward and backward searches. The co-citation analysis affords an objective look at the current state of theory use in DSR and allows for the systematic identification of research opportunities. Altogether, the paper presents a multi-grounded DSR approach to literature reviews and contributes a reliable platform for further analysis and development of the DSR paradigm.

Keywords: Design Science Research · Literature Review · Co-Citation Analysis · Network Analysis

1 Introduction

One core idea of scientific enquiry is the generation of reliable abstract knowledge about phenomena that is applicable in a variety of contexts. Recognizing the importance of the design of artifacts, Simon [1] lay the foundations for a new kind of science, explicitly focused on design: the sciences of the artificial. Since then, research and design has been thoroughly entangled with many different perspectives regarding their relationship [2, 3]. Through the concerted effort of scholars providing evidence for the view that design is a valid form of scientific enquiry [4-7], design science research (DSR) has been emerging as a recognized research approach. During this process a key difference between traditional forms of scientific enquiry and DSR has become evident: whereas traditional forms of scientific enquiry are often focused on a specific aspect of a phenomenon (e.g., market transactions) investigated via a specific research method (e.g., qualitative or quantitative research) from the perspective of a specific discipline (e.g., economics), DSR is emerging as a generally boundary spanning and multi-paradigmatic research activity focused on the design of ever more complex artifacts, which shape and are reshaped by associated disciplines [8]. A central question that arises in

this context is *how does DSR deal with this complex entanglement of research areas and activities on a paradigm level?*

To start answering this question, this research-in-progress paper contributes a new perspective on the emerging DSR paradigm. It provides an up to date overview of the theories and opinions associated with DSR as presented in the IS senior scholars' basket. The analysis builds on a keyword search, which identified 196 article records in total. This data set was investigated with an inductive-deductive coding procedure, which lead to the identification of four major clusters representing qualitatively grounded themes in the data. Moreover, to gain deeper insight into the intellectual structure of the research, three clusters were selected for co-citation analysis [9]. The co-citation analysis suggests that the core concept at the center of research about DSR is the design theory. Furthermore, the co-citation analysis also supports the notion that DSR is still an emerging paradigm with research about DSR developing relatively isolated from other research areas and their knowledge bases.

This research makes two main contributions to the DSR knowledge base. First, the literature review provides several insights that may provide a platform for future research. For example, the co-citation analysis suggests that the relationships between research about DSR and other research areas are not yet well defined and may be fruitfully developed by future research. Second, an existing literature review method is refined and appropriated to the DSR paradigm. The resulting approach is useful in that it is conceptually simple, generic and, thus, easily tailorable to a specific context. As such, it can act as a framework for the analysis of the literature review process and support literature reviews that employ novel forms of analysis.

The rest of the paper is structured as follows. First, the general approach of literature review is described in detail. Second, the specific analyses and results are presented. Third, the findings are discussed and evaluated in terms of their contribution to the DSR paradigm. Fourth, a short summary and conclusion are given.

2 Literature Review

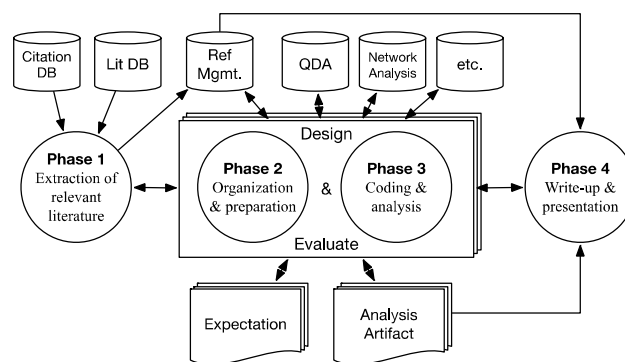

Fig. 1. Adapted tool-support literature review approach. Based on [10]

The literature review followed a version of the four-phase tool-supported literature review approach proposed by Bandara et al. [10] adapted to the DSR paradigm (see Fig. 1). The core idea of the approach is to increase the rigor of the literature review with comprehensive tool support. Tools such as reference managers, qualitative data analysis (QDA), or network analysis tools are used to extend the analyses that can be done based on the literature and associated metadata.

The approach can be summarized as follows. In phase 1, the relevant literature was extracted from the knowledge base. This phase corresponds to a multi-staged search process for journals, databases, and finally literature based on keywords, references or citations [11] utilizing tools such as literature databases or citation analysis tools [10]. Table 1 summarizes the initial keyword search that the rest of the review is based upon. The literature search was supported by LitSonar.com [12] an online tool which can generate appropriate search queries for a variety of literature databases (i.e., it converts a generic search query as shown in Table 1 into queries tailored for selected databases). The exact queries used for the literature search, the resulting data set and other supplementary data can be found at [13].

Based on a search of the IS senior scholar's basket covering the years from 1977-2016, a representative sample of 196 records from high quality research outlets was identified. A reference manager was used to consolidate the literature and associated meta data. Phase 1 was also revisited in a later stage when the Web of Science [14] was used to conduct a forward (a search for articles that reference a given article) and backward search (a search for the references of a given article) for selected articles.

Table 1. Overview of keyword search

Search (title, keywords, abstract)	("design science" OR "design theory" OR "design research" OR DSR OR artifact OR artefact) AND (framework OR theor* OR on- tolog* OR paradigm OR concept OR model OR discipline)			
Journal	Coverage	Database	Records	
JAIS	2000-2016	AISeL	53	27%
MISQ	1977-2016	EBSCO BSC	41	21%
JMIS	1984-2016	EBSCO BSC	23	12%
EJIS	1991-2016	ProQuest	21	11%
ISR	1990-2016	EBSCO BSC	18	9%
JIT	1986-2016	ProQuest	17	9%
JSIS	1991-2016	ScienceDirect	11	6%
ISJ	1998-2016	EBSCO BSC	10	5%
Total			196	100%

Afterwards, and extending Bandara et al. [10], the literature *processing* was realized in a multi-instance *Design & Evaluate cycle* with two main phases of *organization & preparation* as well as *coding & analysis*. The general goal or outcome of the literature processing are *analysis artifacts* (e.g., a concept matrix as described in [15] or illustrations and data based on co-citation analysis [16]) that are "worth-while" to present to the scientific audience. "Worth-while" in this context relates to the subjective *expectations* of the scholars that are engaged in the processing. Expectations mainly emerge in

the organization & preparation phase and set the boundaries for the coding & analysis of the literature. The processing of the literature may be paused and continued until the expectations of the involved scholars are met (e.g., reviewers might request additional processing).

In general, this literature review aims to *integrate a neutral representation* of DSR as a developing paradigm and its associated *central issues* for a *general scientific audience* by covering a *representative* sample of high quality research. Towards this goal, multiple analysis artifacts were constructed as presented in this paper.

3 Analysis and Results

3.1 Initial Classification of Major Themes in the Data Set

In an initial step, an inductive-deductive coding procedure was conducted by the first author utilizing a QDA environment. Inductive open-coding lead to the identification of *goals, kernel theories, research methods, thematic* as well as *theoretical focus* and *perspective* as core concepts that were used as a basis for further selective coding of the articles. This set the foundation for a thematic synthesis [17] which lead to the identification of four major themes (multi-classification possible), *sic.*, *applied DSR, about DSR, about information system as an artifact,* and *about information systems as a discipline* in the data set. Table 3 details these themes with a coding example and includes a record count to help the reader gauge the prevalence of a given theme within the data set. 58 articles or around 30% of the data set could not be classified as relevant to the research question and were, thus, excluded from further analysis.

Table 2. Overview of identified themes

Theme	Coding example	Records	
Applied DSR	"Using a design science approach [...]" [18]	64	33%
About information system as an artifact	"[...] the nature of trust in technological artifacts is still an under-investigated and not well understood topic. [...] Consumers treat online recommendation agents as 'social actors' and perceive human characteristics (e.g., benevolence and integrity) in computerized agents." [19]	44	22%
About DSR	"Our primary objective is to propose a methodology for theory-driven design. We enhance Walls et al.'s (1992) IS Design Theory by introducing the notion of "applied behavioral theory," as a means of better linking theory and system design." [20]	36	18%
About information systems as a discipline	"We present an alternative set of heuristics that can be used to assess what lies within the domain of IS scholarship." [21]	35	18%
Total (distinct)		138	70%

Based on this emersion in and parallel classification of the literature the goal of the review was refined into more specific research question: *how does DSR deal with the complex entanglement of associated research areas and activities on a paradigm level?*

To answer this question, a co-citation analysis of the three (meta-)research clusters was undertaken to gain insight into the intellectual structure of (meta-)research about DSR and how it has interacted with the rest of the research in the IS discipline [9, 16].

3.2 Co-Citation Analysis

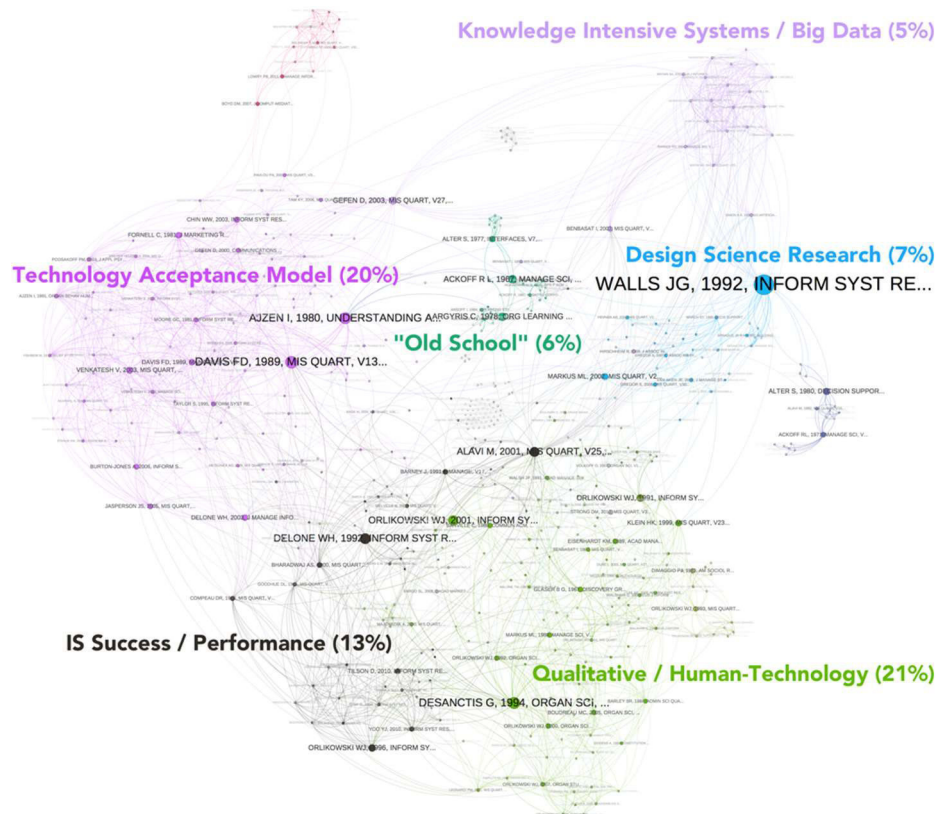

Fig. 2. Co-citation network (nodes: 512; links: 2156; diameter: 9; average path length: 3,741; modularity: 0,709) based on forward and backward searches of the articles in all three selected literature themes (2470 records).

Co-citation is a measure of the frequency with which two papers are cited together in a third paper [9]. Strong co-citation relationships have been argued to be associated with subject similarity or association of ideas and are, therefore, generally useful to identify and evaluate the intellectual structure of scientific literature [9, 16, 22]. In this view, a reference is seen as a symbol for a specific concept - it acts as a concept marker [23] - and if multiple authors cite the same references together, it reflects consensus in the co-usage of concepts [22]. In simpler terms, a co-citation analysis explicates the relationships that the general research community sees between a set of articles.

The goal of this specific co-citation analysis was to get a broad overview of how (meta-)research about DSR has interacted with the rest of the research in the IS discipline. Towards this end, the previously identified themes *about DSR*, *about information system as an artifact*, and *about information systems as a discipline* were selected as the core data set for further analysis. The Web of Science¹ (WoS) was utilized to perform forward and backward searches for every record in the data set.² In total 2470 records were identified. The co-citation analysis was conducted using CiteSpace [16] and Gephi [24]. CiteSpace was used for the construction of the co-citation network (configuration: time slicing: 1977-2016 in 1 year intervals; link retaining factor: 2; look back years: unlimited; selection criteria: g-index with $k = 10$; otherwise standard settings). Gephi was used for visualization and network analysis. As co-citation networks are just unimodal undirected graphs, the standard algorithms for the calculation of betweenness-centrality³ [25] and community detection [26] were used to facilitate the meaningful visualization and interpretation of the networks.

Fig. 2 shows the co-citation network of the core data set with node size reflecting betweenness-centrality (i.e., more central nodes are larger) and node color community affiliation. Six major communities (each greater than 5% coverage, together about 72% of all nodes) were identified by a community detection algorithm and are annotated in the figure.

4 Discussion

The co-citation network suggests that the core concept at the center of research about DSR is the design theory. Walls et al. [27] seminal paper about design theories acts as the central hub and "point of origin" for the DSR cluster and is also a major hub in the network connecting DSR to other established research areas. As can be seen from Fig. 2, research about DSR seems to be focused on developing this core concept of DSR and has not been co-cited with other research areas in a broad way. This is evidence for the notion that DSR is still an emerging paradigm with research about DSR being relatively isolated from other research areas so far – including the integration of existing knowledge bases from other IS research areas. This view is further supported by the small size of the DSR cluster, which only covers about seven percent of the entire network - even though the underlying data set is biased towards literature about DSR. The co-citation network also allows for a comparison between the clusters DSR and Knowledge-Intensive Systems / Big Data just above it. While both clusters consist of relatively new literature, Knowledge-Intensive Systems / Big Data is connected to several older research areas whereas DSR remains largely isolated. This demonstrates that DSR is indeed seen by the community as a unique and emerging paradigm that is only in the process of being tied to the more established research areas.

¹ <http://apps.webofknowledge.com/>

² Six records could not be found in the WoS citation index.

³ A general-purpose measure for the centrality of a node in a network. Defined as the number of shortest paths that pass through a node.

While this is somewhat to be expected as research about DSR is a rather new area, it leads to some interesting considerations regarding the way that the DSR community deals with the complex entanglement with associated research areas and activities. The clear separation indicates that the DSR community seems to pursue a defensive approach to the problem, with meta-research on DSR focused on defending the existence, identity and scientific rigor of DSR and prescriptive knowledge [5, 7, 27-29]. Research focused on integrating DSR with other research approaches has clearly not found its way into the mainstream, yet. This is somewhat surprising, as DSR is generally thought to encompass a diverse set of research activities [30] that resemble those found in established research approaches [4]. For example, *problem identification* is strongly related to qualitative research methods for *observation* (e.g., case studies) and *technology evaluation* is linked to *experimental* research methods. Some researchers even go as far as to argue that any research is always an act of design [31]. Thus, research focused on integrating DSR with established research methods and paradigms seems promising. Interesting research questions that come to mind are, for example: How does DSR relate to qualitative research? How does DSR relate to experimental research? Can DSR inform or support these established research areas? What is the role of DSR for the field? What is the best strategy to establish DSR as a core integrator for the IS field?

Future research should investigate the research question targeted in this paper in more detail. While the presented co-citation analysis allows for a rather unbiased view on the co-usage of concepts by the IS community, it necessarily lags cutting edge research and emphasizes only the most recognized articles. An in-depth analysis and classification of the articles in the core data set is, therefore, already planned.

While not the core focus of this paper, the presented literature review method is also viewed as a useful contribution to the knowledgebase. The existing literature review method by Bandara et al. [10] was refined and appropriated to the DSR paradigm. The resulting approach is useful in that it is conceptually simple, generic, extensible and, thus, easily tailorable to a specific context. It highlights that during a literature review many different types of analysis may be carried out (e.g., co-citation) and emphasizes the important coordinating and organizing role of reference management in this process. As such, it can act as a framework for the analysis of the literature review process and may inspire meta-research targeted at improvement of literature reviews. For example, reference management software vendors may use it to improve the coordination features (e.g., data storage, transformation and export capabilities) of their offerings.

5 Conclusion

This research-in-progress project set out to investigate the research question: *how does a generally multi-paradigmatic and boundary-spanning research areas such as DSR deal with the complex entanglement of associated research areas and activities on a paradigm level?* Towards this goal, a broad keyword search of high quality journals was performed. The resulting data set was qualitatively analyzed and segmented into a core data set of 93 article records. Additional forward and backward searches were then

conducted to augment the data set for a comprehensive co-citation analysis. The presented co-citation analysis affords a grounded view at the intellectual structure of research about DSR and highlights the focus (in mainstream research) on differentiation of DSR against other research methods. This finding provides a valuable contribution for DSR researchers who may want to push the integration of DSR with established research methods (e.g., [32]) and the development of DSR as an integrative methodology for the IS field (e.g., [33]) into the mainstream. The co-citation analysis highlights ample opportunities for future research into the integration of DSR into the IS-field.

References

1. Simon, H.A.: *Sciences of the Artificial*. MIT Press, Cambridge, MA (1996)
2. Bayazit, N.: Investigating Design: A Review of Forty Years of Design Research. *Design Issues* 20, 16-29 (2004)
3. Cross, N.: *Designerly ways of knowing*. Springer (2006)
4. Nunamaker Jr, J.F., Chen, M., Purdin, T.D.: Systems development in information systems research. *Journal of management information systems* 7, 89-106 (1990)
5. Hevner, A.R., Chatterjee, S.: *Design Research in Information Systems*. Springer (2010)
6. March, S.T., Smith, G.F.: Design and natural science research on information technology. *Decision Support Systems* 15, 251-266 (1995)
7. Hevner, A.R., March, S.T., Park, J., Ram, S.: DESIGN SCIENCE IN INFORMATION SYSTEMS RESEARCH. *MIS Quarterly* 28, 75-105 (2004)
8. Purao, S., Baldwin, C., Hevner, A.R., Storey, V.C., Pries-Heje, J., Smith, B., Zhu, Y.: The Sciences of Design: Observations on an Emerging Field. *Communications of the AIS* 23, 523-546 (2008)
9. Small, H.: Co-citation in the scientific literature: A new measure of the relationship between two documents. *Journal of the Association for Information Science and Technology* 24, 265-269 (1973)
10. Bandara, W., Furtmueller, E., Gorbacheva, E., Miskon, S., Beekhuyzen, J.: Achieving Rigor in Literature Reviews: Insights from Qualitative Data Analysis and Tool-Support. *Communications of the Association for Information Systems* 34, (2015)
11. vom Brocke, J., Simons, A., Niehaves, B.: RECONSTRUCTING THE GIANT: ON THE IMPORTANCE OF RIGOUR IN DOCUMENTING THE LITERATURE SEARCH PROCESS. pp. 1-13. (Year)
12. Sturm, B., Schneider, S., Sunyaev, A.: Leave No Stone Unturned: Introducing a Revolutionary Meta-search Tool for Rigorous and Efficient Systematic Literature Searches. *ECIS*, (2015)
13. osf.io/w29ng
14. Thomson Reuters: Web of Science [0.5.23.2]. Thomson Reuters (2017)
15. Webster, J., Watson, R.T.: Analyzing the Past to Prepare For the Future: Writing a Literature Review. *Management Information Systems Quarterly* 26, (2002)

16. Chen, C., Ibekwe-SanJuan, F., Hou, J.: The structure and dynamics of co-citation clusters: A multiple-perspective co-citation analysis. *Journal of the American Society for Information Science and Technology* 61, 1386-1409 (2010)
17. Cruzes, D.S., Dyba, T.: Recommended steps for thematic synthesis in software engineering. In: *Empirical Software Engineering and Measurement (ESEM), 2011 International Symposium on*, pp. 275-284. IEEE, (Year)
18. Abbasi, A., Zhang, Z., Zimbra, D., Chen, H., Nunamaker, J.J.F.: DETECTING FAKE WEBSITES: THE CONTRIBUTION OF STATISTICAL LEARNING THEORY. *MIS Quarterly* 34, 435-461 (2010)
19. Benbasat, I., Wang, W.: Trust In and Adoption of Online Recommendation Agents. *Journal of the Association for Information Systems* 6, (2005)
20. Arazy, O., Kumar, N., Shapira, B.: A Theory-Driven Design Framework for Social Recommender Systems. *Journal of the Association for Information Systems* 11, (2010)
21. Agarwal, R., Lucas Jr, H.C.: THE INFORMATION SYSTEMS IDENTITY CRISIS: FOCUSING ON HIGH-VISIBILITY AND HIGH-IMPACT RESEARCH. *MIS Quarterly* 29, 381-398 (2005)
22. Small, H.: Co-citation context analysis and the structure of paradigms. *Journal of documentation* 36, 183-196 (1980)
23. Small, H.G.: Cited documents as concept symbols. *Social studies of science* 8, 327-340 (1978)
24. Bastian, M., Heymann, S., Jacomy, M.: Gephi: An Open Source Software for Exploring and Manipulating Networks. *Proceedings of the Third International ICWSM Conference*, pp. 361-362 (2009)
25. Brandes, U.: A faster algorithm for betweenness centrality. *Journal of mathematical sociology* 25, 163-177 (2001)
26. Blondel, V.D., Guillaume, J.-L., Lambiotte, R., Lefebvre, E.: Fast unfolding of communities in large networks. *Journal of statistical mechanics: theory and experiment* 2008, P10008 (2008)
27. Walls, J.G., Widmeyer, G.R., El Sawy, O.A.: Building an Information System Design Theory for Vigilant EIS. *Information Systems Research* 3, 36-59 (1992)
28. Gregor, S., Jones, D.: The Anatomy of a Design Theory. *Journal of AIS* 8, (2007)
29. Gregor, S., Hevner, A.R.: POSITIONING AND PRESENTING DESIGN SCIENCE RESEARCH FOR MAXIMUM IMPACT. *MIS Quarterly* 37, 337-A336 (2013)
30. Venable, J.: The role of theory and theorising in design science research. *Proceedings of the 1st International Conference on Design Science in Information Systems and Technology (DESRIST 2006)* 1-18 (2006)
31. Glanville, R.: Researching design and designing research. *Design issues* 15, 80-91 (1999)
32. Sein, M.K., Henfridsson, O., Purao, S., Rossi, M., Lindgren, R.: ACTION DESIGN RESEARCH. *MIS Quarterly* 35, 37-56 (2011)
33. Iivari, J.: The IS Core - VII: Towards Information Systems as a Science of Meta-Artifacts. *Communications of the Association for Information Systems* 12, (2003)

Where is the Crowd?

Stephen Warren¹, Rob Gleasure¹, Phillip O'Reilly¹, Joseph Feller¹, Shanping Li² and Jerry Christoforo³

¹ Cork University Business School, University College Cork, Ireland
Stephen.warren@umail.ucc.ie
{r.gleasure, Philip.oreilly, jfeller}@ucc.ie

² Zhejiang University, China
shan@zju.edu.cn

³ State Street Corporation, China
jacristoforo@statestreet.com

Abstract. Crowdfunding has received increasing attention in the financial services space in the past few years. This is because crowdfunding has become a viable alternative to traditional capital investment and thus a threat to investors in that sector. Various platforms exist which allow fundraisers to pitch an idea and spread awareness with the intention of acquiring backers. Most backers of crowdfunding campaigns come to the platform with the fundraiser rather than from the platform itself [25]. Fundraisers must find and engage a crowd and not rely on the platform for provision of the crowd. This paper sets out four action design principles for identifying and engaging a crowd. Using a boundary object theory approach, the crowdfunding campaign is broken down based on backer's social worlds which define the crowd and their interests.

Keywords: Crowdfunding · Boundary Object Theory · Social Worlds · Design Science.

1 Introduction

The literature on crowdfunding has been defined as embryonic [5]. Crowdfunding has been described as an open call to financially support specific parts of a project or idea [20].

Research to date in the crowdfunding space has, for the most part, looked at the donations process and how projects become successful or not. There is a lack of prescriptive literature based around how the fundraiser should identify, engage, and manage potential backers and the campaign in a way that will lead to success.

Platforms such as Kickstarter aim to provide fundraisers with a 'crowd'. This paper takes a different view on backers and where they come from. We argue that crowds are often attracted to a project not through the platform itself but through other channels including the relationship with the fundraiser. This suggests that backers often give money to one or more projects and may never back another project on the platform. This is based on evidence that many backers come from the inner circle of a fundraiser

and they are backing the project due to their relationship with the backer [1,12]. The inner circle is made up of those who can be reached personally and have a high rate of donation to crowdfunding campaigns [24]. Thus, the key factor to a successful crowdfunding campaign is not the platform, but the crowd that a fundraiser brings to that platform [25]. The phrase ‘crowdfunding campaign’ in this study encapsulates the planning of and the execution of the fundraising and is not limited to the online aspect or the platform upon which the campaign exists.

To achieve the desired contributions, the remainder of the paper is structured as follows. First, crowds are conceptualized as dispersed groups and the literature that points to this is investigated. Following on from this, a boundary object perspective of crowdfunding is presented. We look at various applications of boundary object theory which are relevant to this study. The research method of action design research (ADR) is discussed next in relation to the needs of this study. The four concepts of boundary object theory are then applied to crowdfunding campaigns. This leads to four design principles which can be applied to crowdfunding campaigns to better understand and identify, engage, and manage backers. The principles aim to aid in the creation of successful crowdfunding campaigns. Finally, we apply these principles to real crowdfunding campaigns to test their reliability.

2 Crowds as Dispersed Groups

Crowdfunding allows entrepreneurs to fund their efforts by drawing on relatively small contributions from a relatively large number of individuals using the internet, without standard financial intermediaries [18]. Backers are not only motivated to collect rewards, but also to help others, be part of a community, and support specific causes or projects [14,10]. It is intuitive that some backers may stumble across the project simply because they are frequent users of the platform chosen by the fundraiser. However, this research focuses on the other groups of people for whom a project has value, yet will not become participants unless they are proactively and deliberately sought out. Different communities attach themselves to different settings. Understanding these communities is central to ensuring utilization of the right communication channels to reach backers be it social media, forums, email etc. This means fundraisers need to understand who the likely backers are and where they are to come from. Often a project in need of funding will appeal to multiple communities or crowds and this is when a fundraiser must prioritize and find the best strategy to spread awareness and gain backers [4,9]. Each of these communities may exist on different platforms so the fundraiser must try to bring these dispersed groups together to create the crowd which will support the project.

3 Applying Boundary Object Theory to Crowdfunding

This research will apply a boundary object approach to the crowdfunding campaign process. Before doing this the concept of boundary object theory and where it comes

from must be understood. Boundary objects are used to allow different social or socio-technical environments to coordinate activities and share information [2,7]. There are four core concepts in boundary object theory: social worlds, translation, boundary objects, and coherence [22]. Boundary objects are described by Star and Griesemer [22] as adaptable to different viewpoints and robust enough to maintain identity across them.

Applying a boundary object approach to an examination of crowdfunding platforms will lead to actionable findings which can be implemented in the creation of a crowdfunding campaign. Boundary objects can be abstract, concrete or a mix of both. The original case study looked at by Worrall [26] looked at the maps of life zones in California which were concrete for the more “professional biologists” but abstract for those from other worlds who were not as familiar with what life zones are. This idea can be seen when looking at crowdfunding platforms as backers see projects differently depending on their backgrounds and other factors influencing decision making. In another example, Albrechtsen [3] looked at classification system in the Electronic Library as boundary objects. Albrechtsen put forward the idea that within an information ecology which consists of multiple agents, users and technologies all interacting together simultaneously, a one-size-fits-all paradigm cannot work. Instead a cooperative interaction must be sought. Take for example an augmented reality (AR) headset as a project on a crowdfunding platform, for experts in technology or the AR industry, the projects, its details and the interest of the backers will be concrete. Some potential backers may not have any understanding of the product but are aware of the focus on AR in the tech industry. To these potential backers, the project will be more abstract. The viewpoints and prior knowledge of backers may differ greatly but people from opposite ends of the spectrum will back the project regardless.

A further example is the use of a boundary object perspective in cross-border disaster management systems [6]. These applications demonstrate the need to bring a diverse crowd of actors together as one, even if only for a small subset of tasks or short periods of time.

When creating a crowdfunding campaign, looking at the different possible backers and what motivates them to back a project, a one-size-fits-all approach will not work. Because of the different social worlds involved a key step in creating a successful crowdfunding campaign is acknowledging this fact.

4 Method

It was decided that the best way in which to derive principles to identify, engage, and manage backers in a crowdfunding campaign was to use action design research (ADR) [21]. ADR is similar to design science in that it focuses on the creation of prescriptive artefact-related knowledge [13,16]. However, it differs in that, while the IT artefact is still at the heart of the study, the design is also likely to include supporting institutional or social structures [15,19]. This often involves iterative improvements of design principles based on observed outcomes [21].

5 Applying 4 Concepts of Boundary Object Theory to Crowdfunding Campaigns

5.1 Social Worlds

The concept of social worlds was developed by Strauss [23] as part of the symbolic interaction school of sociology that originated at the University of Chicago. Since then, other scholars have operationalized this concept of social worlds to the study of groups in a variety of context [26]. One example involves McKnight and Zietsma's [17] study of the forest industry in British Columbia, specifically around Different social worlds were identified and a development partnership was formed that included forest companies, environmental NGOs, governments, and community members. In terms of creating a crowdfunding campaign, social worlds should identify the various groups of potential backers and, consistent with the symbolic interactionist origins of the concept, characterize their communication and interaction norms. Thus,

Design Principle 1: Crowdfunding campaigns need to identify different groups of potential backers and identify dominant norms in those groups

5.2 Translation

Translation is defined by Star and Griesemer [22] as follows:

In order to create scientific authority, entrepreneurs gradually enlist participants from a range of locations, re-interpret their concerns to fit their own programmatic goals and then establish them-selves as gatekeepers.

Thus, it can be concluded that translation is the act of reconciling alternative meanings for objects, methods and concepts across each of the related social worlds.

Translation is likely to be important when creating a crowdfunding campaign as it provides a clear link to all the different social worlds. Backers will not all have the same level of understanding or interest in certain aspects of a project; rather they will often latch onto certain aspects that appeal to their personal interests or values [11]. Innocentive, a crowdsourcing platform for large corporations understands the importance of translation. One of the benefits of using the platform is that they help challenge creators to draft the challenge in such a way that it will be understood by as many people as possible as they know that ideas can come from any background or discipline, not just the one specific to the project. Thus, in a crowdfunding context, translation requires that returns and the manner in which they are communicated match the values and interests of specific social worlds.

Design Principles 2: Crowdfunding campaigns need to design and pre-sent returns in a manner that appeals to the specifically targeted social worlds

5.3 Boundary Objects

The concept of a boundary objects is the most unique contribution from Star and Griesemer [22]. Boundary objects are needed where social worlds intersect, effectively enacting translation processes. Boundary objects can be molded to fit multiple social worlds simultaneously. The case study which led to the development of boundary objects was Star & Griesemer's look at the Berkley Museum of Vertebrate Zoology, in which they noted how similar artefacts took on subtly different meanings for different groups, generally with positive effects.

This view suggests crowdfunding campaigns must be treated as more than a webpage and seen as an ever-evolving sociotechnical artefact balancing participation and translating interactions between different social worlds. The crowdfunding campaign is where all backers come together as one and where there must be a common understanding as to what the project entails and what the funding is being used for. This is one reason why campaigns typically make use of social media, email, face-to-face and many other forms of interaction [18].

Design Principle 3: Crowdfunding campaigns must create an assemblage of artefacts capable of translating content and balancing participation across each of the related social worlds.

5.4 Coherence

The concept of coherence occurs if a boundary object successfully balances participation among social worlds over time [22]. The dynamic and shifting nature of this participation means that any number of coherent sets of translations may be possible at some point in time [26]. A failure to understand this is one reason why one-size-fits-all approaches to classification tools often fail to fulfil their full function [3]. Viewing backers in a crowdfunding context as users (at least of the boundary object) suggests that differing intentions and motives for backing a project means various groups must be managed independently at specific times. There is evidence that communication evolves over time in a way that may create new norms [4,8,10]. There is also evidence that communication tends to be stronger when first creating a crowdfunding campaign but falls away over time, e.g. a lack of regular check-ins with backers can cause unrest and support may waiver [18].

Design Principle 4: Crowdfunding campaigns should create an ongoing communication strategy which is specific to each social world.

6 Preliminary data gathering and anticipated conclusions

Preliminary research was performed by assisting in a small fundraising campaign for a board game café in north west Europe. The principles were applied to increase the reach of the campaign and encourage the use of stretch goals to increase participation. The campaign exceeded its target of €5,000, raising over €6,000 (€4,000 of which in the

final three weeks after the researchers became involved). Feedback from the fund-raiser was positive, though it was clear the principles required substantial interpretive work to operationalize, meaning examples were especially valuable. The fundraiser felt the principles were also useful as a general tool for mindfully considering potential customers in the future and for keeping them engaged as the campaign moves forward.

A larger study is currently underway to fundraise for a charity that focuses on homelessness. The principles have been used to identify several groups, to plan rewards targeting each and events to spread awareness. Champions are also being recruited for tighter social worlds where social media and email access is not feasible. Again, feedback from the fund-raiser has been positive, particularly with regards to increasing strategic clarity and providing a structure to fundraising activities.

7 Contributions

7.1 Contribution to crowdfunding

There has been research to date which has looked at crowdfunding campaigns and their success or failure. However there have been few comprehensive application of boundary theory when looking at crowdfunding campaigns to date. This new way of looking at campaigns brings a new insight to the process of creating a successful crowdfunding campaign. Boundary objects are flexible enough to be understood by individual groups while being rigid enough to be independent of any one group. As a means of understanding communication among heterogeneous groups, viewing a process as a boundary object can help bring together a crowd of diverse people with different knowledge bases, motivations and locations. This is why it fits perfectly into crowdfunding in terms of identifying and engaging backers.

7.2 Understanding Boundary Objects in General

Boundary object theory is well explored in research in general and has been applied to many different contexts. With each application it becomes easier to understand and opens it up for understanding by experts in a different field. The boundary object approach proved useful in the context of creating a crowdfunding campaign and thus can be used going forward as a successful application of boundary object theory.

7.3 Prescriptive Design Principles

The upshot of this paper is a set of principles which can be followed by fundraisers leading to a better understanding of potential backers and how to engage them. Although the paper is specific to crowdfunding, the principles which come out of the paper can be applied to other scenarios where a large dispersed crowd needs to be sought out and understood.

References

1. Agrawal, A., Catalini, C. and Goldfarb, A. (2015). Crowdfunding: Geography, Social Networks, and the Timing of Investment Decisions. *Journal of Economics & Management Strategy*, 24.
2. Akkerman, S. F., & Bakker, A. (2011). Boundary crossing and boundary objects. *Review of educational research*, 81(2), 132-169.
3. Albrechtsen, H. (1998). The Dynamics of Classification Systems as Boundary Objects for Cooperation in the Electronic Library. *Library Trends*.
4. Beaulieu, T., & Sarker, S. (2013). Discursive meaning creation in crowdfunding: A socio-material perspective.
5. Belleflamme, P., Lambert, T. and Schwienbacher, A. (2013). Individual Crowdfunding Practices. *SSRN Electronic Journal*.
6. Bharosa, N., Lee, J., Janssen, M. and Rao, H. (2012). An activity theory analysis of boundary objects in cross-border information systems development for disaster management. *Security Informatics*.
7. Carlile, P. R. (2002). A pragmatic view of knowledge and boundaries: Boundary objects in new product development. *Organization science*, 13(4), 442-455.
8. Feller, J., Gleasure, R., & Treacy, S. (2016). Information sharing and user behavior in internet-enabled peer-to-peer lending systems: an empirical study. *Journal of Information Technology* (forthcoming), retrieved from <http://link.springer.com/article/10.1057/jit.2016.1>
9. Gleasure, R. & Morgan, L (2017) The pastoral crowd: exploring self-hosted crowd-funding using activity theory and social capital. *Information Systems Journal* (in press, copy received from authors).
10. Gleasure, R., & Feller, J. (2016). A Rift in the Ground: Theorizing the Evolution of Anchor Values in Crowdfunding Communities through the Oculus Rift Case Study. *Journal of the Association for Information Systems*, 17(10), 708.
11. Gleasure, R., & Feller, J. (2016). Does Heart or Head Rule Donor Behaviors in Charitable Crowdfunding Markets?. *International Journal of Electronic Commerce*, 20(4), 499-524.
12. Gleasure, R., & Feller, J. (2016). Emerging technologies and the democratization of financial services: A metatriangulation of crowdfunding research. *Information and Organization*, 26(4), 101-115.
13. Hevner, A., March, S., Park, J. and Ram, S. (2004). Design Science in Information Systems Research. *MIS Q*, 28.
14. Hui, J., Greenberg, M. and Gerber, E. (2014). Understanding the Role of Community in Crowdfunding Work. In: *Proceedings of the 17th ACM conference on Computer supported cooperative work & social computing*. ACM.
15. Järvinen, P. (2007). Action research is similar to design science. *Quality & Quantity*, 41(1), 37-54.
16. March, S. T., & Smith, G. F. (1995). Design and natural science re-search on information technology. *Decision support systems*, 15(4), 251-266.
17. Mc Knight, B. and Zietsma, C. (2007). Local Understandings: Boundary Objects in High Conflict Settings. *OLKC*.
18. Mollick, E. (2014). The dynamics of crowdfunding: An exploratory study. *Journal of Business Venturing*, 29(1), pp.1-16.
19. Myers, M. D., & Venable, J. R. (2014). A set of ethical principles for design science research in information systems. *Information & Management*, 51(6), 801-809.
20. Schwienbacher, A. and Larralde, B. (2010). Crowdfunding of Small Entrepreneurial Ventures. *SSRN Electronic Journal*.

21. Sein, M., Henfridsson, O., Purao, S., Rossi, M. and Lindgren, R. (2011). Action Design Research. *MIS Q*, 35.
22. Star, S. and Griesemer, J. (1989). Institutional Ecology, 'Translations' and Boundary Objects: Amateurs and Professionals in Berkeley's Museum of Vertebrate Zoology, 1907-39. *Social Studies of Science*, 19(3), pp.387-420.
23. Strauss, Anselm. A social world perspective. *Stud. Symbolic Interaction* (1978) 1(1):119-128
24. Vassallo, W. (2016). *Crowdfunding for sustainable entrepreneurship and innovation*. 1st ed.
25. Wheat, R., Wang, Y., Byrnes, J. and Ranganathan, J. (2013). Raising money for scientific research through crowdfunding. *Trends in Ecology & Evolution*, 28(2), pp.71-72.
26. Worrall, A. (2016). *Boundary Object Theory: Concepts, Propositions, and Limitations*.

Tensions in Design Principle Formulation and Reuse

Leona Chandra Kruse and Stefan Seidel

University of Liechtenstein, Vaduz, Liechtenstein
{leona.chandra, stefan.seidel}@uni.li

Abstract. Designing can be viewed as a collective activity that accumulates and reuses knowledge over time and, in the information systems field, such knowledge often takes the form of design principles. While design principles are now a predominant form to capture, accumulate, and reuse design knowledge, their reusability cannot be taken for granted. In this paper, we present the preliminary findings of an ongoing series of experiments that aim to explore the characteristics of design principles that facilitate or inhibit their reuse. Our preliminary findings suggest that, interestingly, these characteristics occur as contradicting elements. We situate the tensions in the light of hermeneutics, expert intuition, and C-K design theory. We hope that, through our ongoing work, we can trigger further discussion on design principles reuse in the DSR community.

Keywords: Design principles · Knowledge reuse · C-K design theory

1 Introduction

It is not an overstatement to consider designing as a fundamental human activity, since we use it in various life domains, from solving problems and exploring the unknown territories in the universe to creating our future for better or worse [1]. Good design can go far beyond a single success story. Once the knowledge that underlies a specific design is captured in a sufficiently abstract way, it can inform other design endeavors in similar areas. On this view, designing is a collective activity that accumulates and reuses design knowledge over time. In the Information Systems (IS) field, design principles are now a predominant way to capture, accumulate, and reuse design knowledge [2, 10]. They have been defined as “knowledge about creating other instances of artifacts that belong to the same class” [3, p. 39].

As is the case for other forms of knowledge, design principles can be reused as they are, but designers can also modify or recombine them with other forms of abstract and practical knowledge [4]—and reuse can be facilitated by enhancing the reusability attribute of the design knowledge itself [5]. Therefore, we ask, *what characteristics can enhance the reusability of design principles?*

In this research-in-progress paper, we present and discuss the preliminary findings of a study that is part of larger series of experiments, with the main goal of addressing this question.

Interestingly, our preliminary findings suggest that the design principles formulated by expert designers are *rich in tensions and contradictions*, and they give us important insight about the reuse of design principles. By focusing on the characteristics of design principles, we contribute to the ongoing debate on how design principles should be formulated and used in IS [9, 30]. Notably, the characteristics of design principles have gained increased attention in various disciplines, such as educational technology [6], mechanical design [7], organizational design [8], and indeed IS [9]. Before presenting our preliminary findings and our discussion, we first characterize the key concepts and briefly describe the overall research design and more specific research procedures. We conclude with a brief outlook on future studies that aim at addressing the characteristics of reusable design principles in IS.

2 Characterizing Design and Design Principles Reuse

2.1 Design and Redesign

The analysis of design activities has undergone several paradigm shifts over the past years. Initially seen as being similar to decision making and problem solving [10] and structured into a process that emphasizes objectivity and rationality—what Cross [11, p. 1] dubbed “scientised”—design problems have been identified as wicked problems [12, 13] that call for a different approach. The last decades saw the turn into viewing design as a reflective practice [14-16] and an expandable rationality [17]. Considered a reflective practice, design incorporates both technical knowledge and artistry and occurs as a reflective conversation between designers, their actions, and their situations [14]. Seen as an expandable rationality—an extension of Simon’s concept of bounded rationality—design should not be reduced to problem solving, even though it involves problem solving [17]. Therefore, design is both rational and reflective [16, 18].

In spite of the differences between various approaches employed in studying design, all of them tend to follow complementary traits or logics of design [19]. These traits can be summarized as “recognition of the unknown, propagation of the concept based on available knowledge, and generation of new concepts” (p. 4). Design is also viewed as redesign [e.g., 20], because it “is never a process that begins from scratch [...] There is always something that exists first as a given, as an issue, as a problem” [21, p. 5]. This argument, however, is not to be confused with the notion of redesigning by users [cf. 22, p. 99] that rather deals with product adjustments or uses that differ from the intention of its designer.

2.2 Design Principle Reuse

We argue that *design knowledge* is passed from one (re)design situation to another. Design knowledge is generally defined as the knowledge “of and about the artificial world and how to contribute to the creation and maintenance of that world” [23, p. 6]. Such knowledge is

gained by engaging in the activity of designing and producing artifacts, as well as by reflecting upon and using those artifacts [23].

As is the case for other forms of knowledge, design principles can be reused as they are, but designers can also modify or recombine them with other forms of knowledge [4]. Even though reusing is often seen synonymous to repetition, reuse has been observed in contexts where innovation is the main goal [24, 25]. In reuse, design principles are often treated as “guidelines for making design decisions” and guidelines in navigating “through the design space and obtain an effective design” [24, p. 67]. Knowledge reuse can be facilitated by enhancing the reusability attribute of the design knowledge itself (e.g., capturing and documenting knowledge) or making knowledge transfer among designers easier (e.g., developing and maintaining good repositories for knowledge dissemination [5]). For knowledge reuse to take place, a community of practice needs to share a common knowledge base, which can also be assumed for the designer community [26]—including the IS field. The focus of this research is on inferring what specifically matters about design principles that makes them effectively reusable for designers.

2.3 Tensions and Paradoxes in Design and Design Principles Reuse

Paradoxes embrace “contradictory yet interrelated elements [27]—elements that seem ‘logical’ in isolation but absurd and irrational when appearing simultaneously [28, p. 760]. In this paper, we utilize the notion of tension to soften the claim of something being a paradox. Prominent scholars have noted that design is “nothing if not full of paradoxes and contradictions. Divergent and convergent thinking are at its core. The new and the old. Letting the mind wander and focusing it” [22, p. 7]. Some even went on to define design as “the resolution of paradoxes between discourses in a design situation” [16, p. 17]. Similarly, IS DSR scholars have identified the ambiguity of the word “design,” that is both a verb and a noun [e.g., 29]. The basic trait of design theory—and thus design principles—has even been put forward as the “creation of the language of the unknown and generativity” [19, p. 5], which again indicates a tension of known/unknown at work. Against this background, we postulate that design principles reuse contains tensions and even paradoxes. *The first step towards enlightenment, we argue, is therefore the recognition of the tensions and paradoxes to be resolved in order to enhance the reusability of design principles.*

3 Method

3.1 Overview of Research Design

This research continues the collective attempt to understanding what makes up design principles in IS [e.g., 9] and through which mechanisms designers reuse design principles [e.g., 30]. Inspired by Barbara Tversky’s works with her colleagues on designing instructions [e.g., 31, 32], this research is designed as a series of experiments that can be summarized in

three key stages: (1) production of design principles; (2) formulation preference; and (3) output comparison. Due to space restriction, this paper only elaborates on the design of the first study and reports on its preliminary findings.

3.2 Production of Design Principles

The voluntary participants in our study on the production of design principles (i.e., the first in a series of three key studies) are User Interface (UI) designers with several years of experience, who speak English in their professional setting. We provided the participants with a smartphone with an energy conservation application (app), two sheets of paper, two pens, and a box of coloring pencils. The particular app was selected for its high user rating and intuitive design and because its domain is not too familiar, so that the participants still need to think and reflect when completing the task.

The participants were first asked to use the already launched app on the smartphone given to them in any way they felt comfortable with. They were given the task to understand what the app is for, how it is designed, and what users can do with it. They were also specifically asked to think about how they can design a similar app. Next, they were asked to produce a set of design principles that is aimed at UI designers like themselves. We gave the participants neither time constraint nor brevity constraint in completing the task. The instruction goes as follows [adapted from 32]:

“Suppose other User Interface (UI) designers want to design a similar app and ask you for advice. Please write some guidelines to help them designing the app, so that they can make their design decisions efficiently. You can use a combination of pictures and words. The pictures can be sketches; there is no need to worry about the way they look, as an artist will do the actual drawings. Please ensure that the guidelines are straightforward and easy to understand by your fellow designers.”

4 Tensions and Paradoxes in Design Principles (DP) Formulation and Reuse

4.1 A Brief Summary of Preliminary Analysis and Findings

At the time of writing this research-in-progress paper, we have collected four sets of design principles from practicing designers (referred to as D1, D2, D3, and D4) with at least five years of professional experience. In accordance with the exploratory nature of this study we tried to identify similarities and differences among the four sets of design principles, as well as among the individual sets of design principles, without any predefined rules. Due to the brevity constraint, we summarize the preliminary findings as the following contradicting elements and discuss them in light of several theoretical narratives.

#1 Mapping problem space vs. solution space: D1 and D3 said much about the app features (e.g., “illustrate the savings-level of the user with a photo”), while D2 and D4 also considered the user’s perspective (e.g., “show and track how much energy, trees and water [people] saved with their actions”). The former corresponds to the solution space, while the latter to the problem space. These tendencies and their potential implications have been discussed in depth in [9].

#2 Design principles as rules vs. lessons learned: While most of the proposed guidelines are rule-like (i.e., they are based on what works well in the current app and other proofs-of-concept), we found some to be strikingly intuitive (e.g., “gamification makes the app interesting” and “don’t let people add as many activities as they want because they can lose the motivation to do any of them looking at the long list” by D4). The latter statements are rooted in expertise intuition gained by accumulating lessons learned in doing design. A similar distinction has been put forward in [33].

#3 Positive vs. negative knowledge: Two of our participants (D3 and D4) proposed how to improve the app design. While D3 suggested incremental improvement (such as the presentation of activities as push cards), D4 began critiquing the current design and stating guidelines on *what not to do* (e.g., “don’t put the formulas (calculation) on the app but on a separate webpage”) before saying *what to do*.

#4 Design principles in pure textual form vs. in combination with visual cues: While not being strictly paradoxical in nature, participants’ preference in using only text or a combination of text and sketch is worth noticing. Recall that all participants were given the same instruction (Section 3.2). We observed only very slight differences in the text lengths, where the standalone ones were slightly longer (by D3 and D4) and more elaborate than those that were in combination with sketches (by D1 and D2).

4.2 Discussion

What are the implications of these preliminary findings in the discourse of design principle formulation and reuse? In the following sections, we address this question in light of some established streams of thought.

DP Formulation and Reuse in Light of Hermeneutics

It has been suggested that the first act of understanding takes the form of a guess [34]. This means, “we have to guess the meaning of the text because the author’s intention is beyond our reach” (ibid). The important step comes thus after guessing, namely the validation of the guess. The validation is not necessarily an empirical verification that leads to a true/false conclusion, but rather showing that “an interpretation is more probably in the light of what we know” (p.76).

This idea can be applied to describe how a designer reuses design principles that are formulated in textual form. We can argue that reusing begins with understanding, which in turn starts with guessing the essential knowledge that can be derived from the design principles

and followed by a validation of the guess. A similar idea was also captured in Nonaka and Takeuchi's [35] SECI portrayal of knowledge dimensions and the dynamics among them. Using their terms, what Riceour has proposed can be restated as follows. The knowledge gained through and employed throughout designing is crystallized in a set of design principles. When other designers try to reuse the knowledge, they first internalize the design principles, combine them with their expertise and experience, and then generate new concepts to be applied into their design situation. But in how far does the expertise matter?

DP Formulation and Reuse, Best Practices and Expert Intuition

The debate between the importance of best practices (rules) drawn from evidence versus expert intuition has been going on among cognitive scientists [36]. Rules and expert intuition often contradict each other. On the one hand, rules are considered "an important opportunity for any community to shed outmoded traditions and unreliable anecdotal procedures" since "they enable organizations to act in a consistent way" [37, p. 253]. On the other hand, the same authors expressed their concern that "practitioners in a variety of disciplines may have trouble gaining expertise if they just mechanically apply prescribed rules" [37, p. 250]. Applying the tension to our preliminary findings, we can say that even though design principles can contribute to enhanced reliability of the design outcome, we need to find a right balance between design principle reuse and reliance on designers' expertise in order to avoid unreliable procedures on the one hand and not to constrain innovation on the other. This line of thinking is consistent with the common approach of managing codified knowledge in a learning organization that keeps a healthy amount of tacit knowledge [e.g., 38].

C-K Design Theory and DP Formulation and Reuse

The C-K design theory was proposed by Hatchuel and Weil [39, 40] with the goals of offering a clear and precise definition of design and going forward from the idea of design being nothing else than problem solving to design as being an integration of creative thinking within problem solving. According to this theory, design happens in two spaces—a knowledge space (K) and a concept space (C). All propositions of K have a logical status (true or false), while the propositions in the C space have no logical status in a space K and have a tree based structure.

Design is then defined as (a) the process "by which a concept generates other concepts or is transformed into knowledge, i.e., propositions in K" [40, p. 5] and (b) the process "by which $K \rightarrow C$ disjunctions are generated, then expanded by partition or inclusion into $C \rightarrow K$ conjunctions" (p. 8). Please consult [39, 40] for an in-depth explanation. This theory postulates two types of creativity (p. 12): *C-k* creativity or a "conceptual innovation" that involves adopting daring concepts but then quickly looking for new knowledge expansion outside the team; *c-K* creativity or an "applied science" where one adopts an acceptable concept that is not too daring, and is determined to persevere in developing the concept into a creative design.

The proponents of the C-K theory once asked, “what is the impact of knowledge codification on the ability to design?” [40, p. 13]. We can address this question by putting the C-K theory into the phenomenon of designers reusing design principles. On the one hand, we expect to find *c-K* creativity, because available design principles add to designers’ K space. In this case, designers already know what works well and can therefore apply the knowledge in attaining their goals. Nevertheless, this conjecture only holds given that we assume design principles to have a logical status following a rigorous validation and thus being part of the K space (i.e., rule-based). If design principles are assumed to be propositions in the C space (i.e., lessons learned), on the other hand, we can expect to see either a conceptual innovation (*C-k*) or simply a design activity that is not innovation-oriented. This tension will be addressed in our future studies.

5 Conclusion and Outlook

Good design can go far beyond a single success story. Once the underlying knowledge is captured, it can inform other design endeavors in similar areas. Design principles are an appropriate vehicle to disseminate knowledge contributions of design science research (DSR) endeavors [10], and it is thus important to account for artifacts’ instantiation validity [11, 12] and the reusability of design principles. Through this paper, we would like to kindle a discussion in the DSR community on the characteristics of reusable design principles or design theory [41, 42]. We took a first step by illuminating the contradicting elements in design principles formulation and by discussing the possible implications for design principle reuse in light of hermeneutics, expert intuition, and C-K design theory. Our ongoing and further research follows the previously discussed research design—we will empirically compare and contrast the contradicting elements of design principles in terms of designers’ preference (stage 2: formulation preference) and the resulting design process and products (stage 3: output comparison). We hope that this research will make a contribution to developing a strong body of prescriptive knowledge in IS that is reusable and actionable.

References

1. Reich, Y., Subrahmanian, E.: Philosophy of design, science of design, engineering (of) design: what is your choice? *Research in Engineering Design* 24, 321-323 (2013)
2. Gregor, S., Hevner, A.R.: Positioning and presenting design science research for maximum impact. *Management Information Systems Quarterly* 37, 337–355 (2013)
3. Sein, M.K., Henfridsson, O., Purao, S., Rossi, M., Lindgren, R.: Action design research. *Management Information Systems Quarterly* 35, 37–56 (2011)
4. Nickerson, J.V.: *Diagrams in Design*. In: J. M. Zacks and H. A. Taylor (eds.) *Psychological Representations in Mind and World*. Psychology Press., New York, NY. (2017)
5. Markus, L.M.: Toward a theory of knowledge reuse: Types of knowledge reuse situations and factors in reuse success. *Journal of management information systems* 18, 57-93 (2001)
6. Easterday, M.W., Rees Lewis, D.G., Gerber, E.M.: The logic of the theoretical and practical products of design research. *Australasian Journal of Educational Technology* 32, 125-144 (2016)
7. Fu, K.K., Yang, M.C., Wood, K.L.: Design Principles: Literature Review, Analysis, and Future Directions. *Journal of Mechanical Design* 138, 1-13 (2016)

8. Romme, A.G.L., Eendenburg, G.: Construction Principles and Design Rules in the Case of Circular Design. *Organization Science* 17, 287-297 (2006)
9. Chandra, L., Seidel, S., Gregor, S.: Prescriptive knowledge in IS research: Conceptualizing design principles in terms of materiality, action, and boundary conditions. In: Annual Hawaii International Conference on System Sciences, pp. 4039-4084. IEEE Computer Society (2015)
10. Simon, H.: *The sciences of the artificial*. MIT Press, Cambridge, MA (1996)
11. Cross, N.: *Design cognition: Results from protocol and other empirical studies of design activity*. (2001)
12. Rittel, H., Webber, M.M.: 2.3 planning problems are wicked. *Polity* 4, 155-169 (1973)
13. Rittel, H.W., Webber, M.M.: Dilemmas in a general theory of planning. *Policy sciences* 4, 155-169 (1973)
14. Schon, D.: *The Reflective Practitioner*. Basic Books, New York, NY. (1983)
15. Schön, D.A.: *Educating the reflective practitioner: Toward a new design for teaching and learning in the professions*. Jossey-Bass (1987)
16. Dorst, K.: Design problems and design paradoxes. *Design issues* 22, 4-17 (2006)
17. Hatchuel, A.: Towards Design Theory and expandable rationality: The unfinished program of Herbert Simon. *Journal of management and governance* 5, 260-273 (2002)
18. Cross, N.: Expertise in design: an overview. *Design studies* 25, 427-441 (2004)
19. Le Masson, P., Dorst, K., Subrahmanian, E.: *Special Issue on Design Theory: history, state of the arts and advancements*. Springer, Heidelberg, Germany (2013)
20. Gregor, S., Hevner, A.R.: *The Front End of Innovation: Perspectives on Creativity, Knowledge and Design*. *New Horizons in Design Science: Broadening the Research Agenda*, pp. 249-263. Springer (2015)
21. Latour, B.: A cautious prometheus? A few steps toward a philosophy of design (with special attention to Peter Sloterdijk). *Proceedings of the 2008 annual international conference of the design history society*, pp. 2-10 (2008)
22. Tversky, B.: Affording design, affording redesign. *Principia Designae-Pre-Design, Design, and Post-Design*, pp. 91-102. Springer (2015)
23. Cross, N.: Designerly ways of knowing: Design discipline versus design science. *Design issues* 17, 49-55 (2001)
24. Agrawala, M., Li, W., Berthouzoz, F.: Design principles for visual communication. *Communications of the ACM* 54, 60-69 (2011)
25. Majchrzak, A., Cooper, L.P., Neece, O.E.: Knowledge reuse for innovation. *Management science* 50, 174-188 (2004)
26. Grant, R.M.: Toward a Knowledge-Based Theory of the firm. *Strategic management journal* 17, 109-122 (1996)
27. Cameron, K.S., Quinn, R.E.: *Organizational paradox and transformation*. Ballinger Publishing Co/Harper & Row Publishers (1988)
28. Lewis, M.W.: Exploring paradox: Toward a more comprehensive guide. *Academy of Management review* 25, 760-776 (2000)
29. Hevner, A.R., March, S.T., Park, J.: Design Science in Information Systems Research. *MIS Quarterly* 28, 75-105 (2004)
30. Chandra Kruse, L., Seidel, S., Pura, S.: Making Use of Design Principles. In: *Tackling Society's Grand Challenges with Design Science: 11th International Conference, DESRIST 2016, St. John's, NL, Canada, May 23-25, 2016, Proceedings* 11, pp. 37-51. Springer (2016)
31. Heiser, J., Phan, D., Agrawala, M., Tversky, B., Hanrahan, P.: Identification and validation of cognitive design principles for automated generation of assembly instructions. In: *Proceedings of the working conference on Advanced Visual Interfaces*, pp. 311-319. ACM, (2004)
32. Daniel, M.-P., Tversky, B.: How to put things together. *Cognitive processing* 13, 303-319 (2012)
33. Iivari, J.: Distinguishing and contrasting two strategies for design science research. *Eur J Inf Syst* 24, 107-115 (2015)

34. Ricoeur, P.: Interpretation theory: Discourse and the surplus of meaning. TCU press, Fort Worth, TX (1976)
35. Nonaka, I., Takeuchi, H.: The Knowledge-Creating Company: How Japanese Companies Create the Dynamics of Innovation. Oxford University Press, Oxford, UK (1995)
36. Kahneman, D., Klein, G.: Conditions for intuitive expertise: a failure to disagree. *American psychologist* 64, 515 (2009)
37. Klein, D.E., Woods, D.D., Klein, G., Perry, S.J.: Can we trust best practices? Six cognitive challenges of evidence-based approaches. *Journal of Cognitive Engineering and Decision Making* 10, 244-254 (2016)
38. Guzman, G., Trivelato, L.F.: Drawing the boundaries of Codified Knowledge Transfer. *Organisational Learning, Knowledge and Capabilities (OLKC 2007)* (2007)
39. Hatchuel, A., Weil, B.: A new approach of innovative Design: an introduction to CK theory. In: *DS 31: Proceedings of ICED 03, the 14th International Conference on Engineering Design*, Stockholm. (2003)
40. Hatchuel, A., Weil, B.: CK design theory: an advanced formulation. *Research in engineering design* 19, 181 (2009)
41. Baskerville, R., Pries-Heje, J.: Design theory projectability. In: *Information Systems and global assemblages. (Re) Configuring actors, artefacts, organizations*, pp. 218-232, Springer (2014)
42. Lukyanenko, R., Parsons, J.: Reconciling theories with design choices in design science research. In: *Design science at the intersection of physical and virtual design*, pp. 165-180, Springer (2013)