



2022

 **Decatur Diamond**

A HERITAGE CUTTER BRAND





Decatur Diamond

First and foremost, we believe that Decatur Diamond currently offers the most complete suite of diamond cutting tools for the industrial market. We can provide both diamond coated and PCD milling cutters through the patented Ultra-Mill line. If your particular machining operation requires diamond coated, or grown on diamond, look no farther than our DIAbide series of solid carbide rounds with diamond coating. We also design, manufacture and sell brazed-on, PCD tooling. Finally, Decatur Diamond can also offer you complex, integrated shank, mono-bloc tooling that incorporates brazed-on, PCD diamond cutting surfaces. We are uniquely positioned to offer customers such a broad range of diamond based cutting tools. Whether it is high silica content aluminum for the automotive industry, multi-layer composites for aerospace, or any other difficult application, we have the diamond tooling solution for your machining challenge.

However, our products are only a portion of the story. Decatur Diamond stands ready to work with you to solve your machining challenges, and provide on-going assistance with best-in-class technical and logistic support. Our field technical sales, our inside tech support and our customer service team stand ready to help our customers select the right diamond tool for the job, apply that tool for maximum productivity, and provide ongoing service and logistics support for our products.

We remain committed to American industry and manufacturing. Please let us show you how we can work with you to help drive productivity and performance.





Table of Contents

Ultra-Mill Patented Milling Cutting System	4
Ultra-Mill Index	5
DIAbide Tool Grade and Type Description	30
DIAbide Index	31
PCD Tipped Inserts	52
PCD Tipped Inserts Index	53
How to Order	57



Ultra-Mill Patented Milling Cutting System

Ultra-Mill™

The design of the Ultra-Mill V-style milling cutter allows this system to accommodate a wide range of pitch or rake angle requirements for your particular cutting applications. This common body style allows the user to adapt to different applications simply by changing cartridge styles. For machining ferrous metals, brazed cBN cartridges are available. For non-ferrous materials brazed PCD cartridges are available.



Features

Higher density than most competitive milling cutters

Benefits

Higher machining speeds

Advantages

Faster throughput (increased production) or longer tool life (reduction in tool costs)



2 Stage design capacity

Rough and Finish in one pass, aids in reducing vibration on difficult to clamp or thin section parts

Faster throughput (increased production) or better asset utilization (increased capacity)



Symmetrical cutter body

Left hand and right hand mounting with the same body

Reduced cutter body inventory and increased flexibility (reduced tooling costs)



Open design

Improved chip evacuation – less chip damage

Increased cutter body life (lower tooling costs)



Geometry in the cartridge, not in the body

Fewer application limitations – PCD and cBN brazed cutting tips, positive or negative rake and lead angles are available

Faster throughput (increased production) or longer tool life (reduction in tool costs)



Ultra-Mill Index

Standard Shell Mill Cutter Body Offerings–Inch	6
Standard Shell Mill Cutter Body Offerings–Metric	7
Thru Spindle Coolant Attachments for Standard Cutters	8
Cartridge Identification for Standard Cutters.....	9
Intermediate Cutter Body Offerings–Inch.....	10
Intermediate Cutter Body Offerings–Metric.....	11
Thru Spindle Coolant Attachments for Intermediate Cutters.....	12
Cartridge Identification for Intermediate Cutters	13
Mini Endmill Shank Style Cutter Body Offerings–Inch.....	14
Mini Endmill Shank Style Cutter Body Offerings–Metric.....	15
Ultra Endmill Shank Style Cutter Offerings–Inch	16
Ultra Endmill Shank Style Cutter Offerings–Metric	17
Special Tools	18
Hardware and Adjustment Tools	20
Setup Procedure.....	21
Formulas, Legend, Milling Theory and Calculations.....	22
Cutting Data	23
Standard and Intermediate Shell Mills Quote Request Form	24
Intermediate and Mini Endmill Shank Style Mills Quote Request Form	25
Ultra Endmill Quote Request Form	26
Quote Request Form.....	27
PCD Monobloc Tools.....	28

Ultra-Mill Standard Shell Mill Cutter Body Offerings – Inch

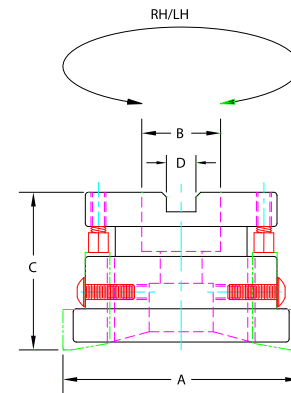
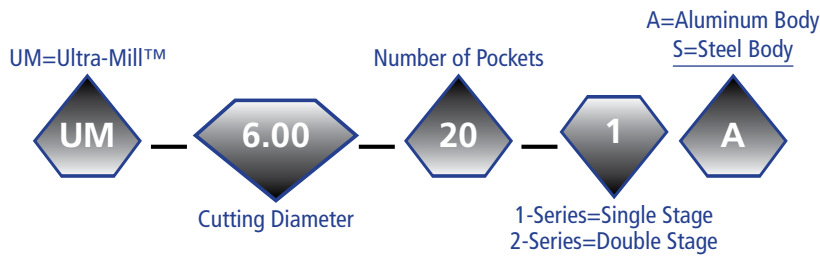

Ultra-Mill™ Standard Shell Mill Cutter Body Offerings – Inch

Effective Cutting Dia. A (Inches)	Cutter Order Number	Number of Pockets	B Dimension Bore Diameter	C Dimension Set Height	D Dimension Key Size	Max RPM
2.500	UM-2.50-3-1A/S	3	0.750	2.000	0.312	15,500
2.500	UM-2.50-6-1A/S	6	0.750	2.000	0.312	15,500
3.000	UM-3.00-4-1A/S	4	1.000	2.000	0.375	14,200
3.000	UM-3.00-8-1A/S	8	1.000	2.000	0.375	14,200
3.000	UM-3.00-10-1A/S	10	1.000	2.000	0.375	14,200
4.000	UM-4.00-6-1A/S	6	1.250	2.000	0.500	12,250
4.000	UM-4.00-12-1A/S	12	1.250	2.000	0.500	12,250
5.000	UM-5.00-8-1A/S	8	1.500	2.375	0.625	11,000
5.000	UM-5.00-16-1A/S	16	1.500	2.375	0.625	11,000
6.000	UM-6.00-8-1A/S	8	1.500	2.375	0.625	10,000
6.000	UM-6.00-12-1A/S	12	1.500	2.375	0.625	10,000
6.000	UM-6.00-20-1A/S	20	1.500	2.375	0.625	10,000
8.000	UM-8.00-10-1A/S	10	2.500	2.375	1.000	8,600
8.000	UM-8.00-12-1A/S	12	2.500	2.375	1.000	8,600
8.000	UM-8.00-24-1A/S	24	2.500	2.375	1.000	8,600
10.000	UM-10.00-12-1A/S	12	2.500	2.375	1.000	7,750
10.000	UM-10.00-28-1A/S	28	2.500	2.375	1.000	7,750
12.000	UM-12.00-18-1A/S	18	2.500	2.375	1.000	7,250
12.000	UM-12.00-36-1A/S	36	2.500	2.375	1.000	7,250
14.000	UM-14.00-16-1A/S	16	2.500	2.375	1.000	6,750
14.000	UM-14.00-32-1A/S	32	2.500	2.375	1.000	6,750
14.000	UM-14.00-42-1A/S	42	2.500	2.375	1.000	6,750

A = Aluminum Body S = Steel Body

Ultra-Mill Standard Shell Mill Cutter Body Offerings – Metric

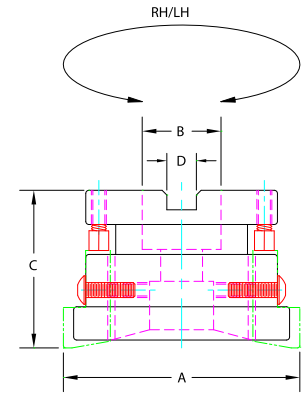
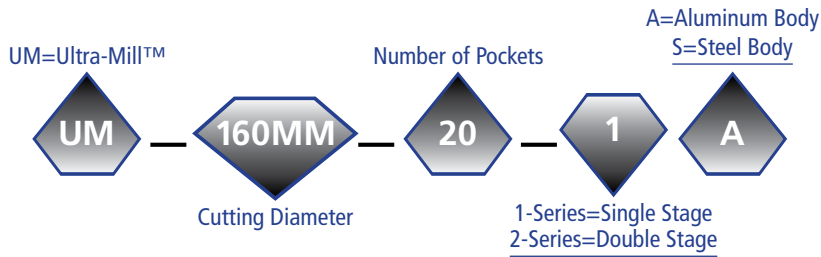

Ultra-Mill Standard Shell Mill Cutter Body Offerings – Metric

Effective Cutting Dia. A (mm)	Cutter Order Number	Number of Pockets	B Dimension Bore Diameter	C Dimension Set Height	D Dimension Key Size	Max RPM
63	UM-63MM-3-1A/S	3	22	63	10	15,000
63	UM-63MM-6-1A/S	6	22	63	10	15,000
80	UM-80MM-8-1A/S	8	22	50	10	14,000
80	UM-80MM-10-1A/S	10	22	50	10	14,000
100	UM-100MM-6-1A/S	6	32	50	14	12,250
100	UM-100MM-8-1A/S	8	32	50	14	12,250
100	UM-100MM-12-1A/S	12	32	50	14	12,250
125	UM-125MM-12-1A/S	12	40	63	16	11,000
125	UM-125MM-16-1A/S	16	40	63	16	11,000
160	UM-160MM-10-1A/S	10	40	63	16	10,000
160	UM-160MM-20-1A/S	20	40	63	16	10,000
200	UM-200MM-12-1A/S	12	60	63	25	8,600
200	UM-200MM-24-1A/S	24	60	63	25	8,600
250	UM-250MM-32-1A/S	32	60	63	25	7,750

A = Aluminum Body S = Steel Body

Decatur Diamond will design special cutter bodies to your specifications:

- Special mounts
- Application specific diameters
- Required number of pockets, ect.

Please call to inquire on further details or request a quote.

Ultra-Mill Thru Spindle Coolant Attachments for Standard Cutters

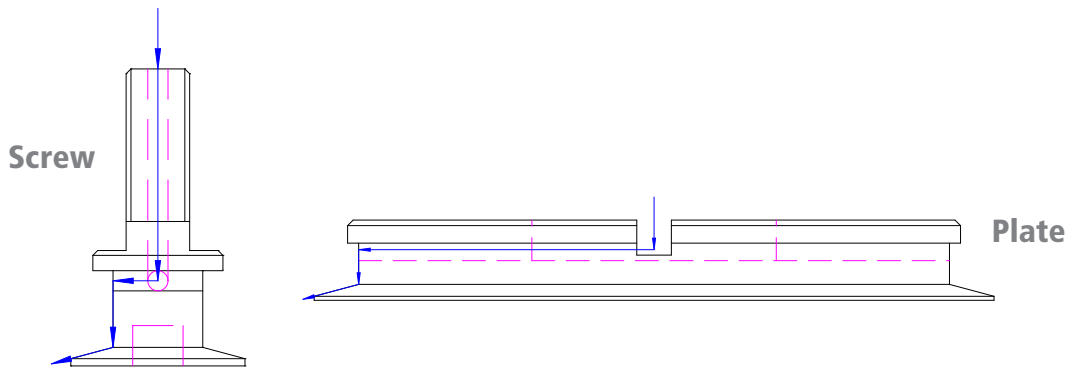

Inch

Coolant Attachment Order Number	Cutter Diameter	Thread	Torque	Hex Size
UM-SS-2.50	2.50"	3/8-24	35 ft/lbs	3/16
UM-SS-3.00	3.00"	1/2-20	40 ft/lbs	5/16
UM-SS-4.00	4.00"	5/8-18	45 ft/lbs	3/8
UM-SS-5.00	5.00"	3/4-16	55 ft/lbs	3/8
UM-SS-6.00	6.00"	3/4-16	55 ft/lbs	5/8
UM-SS-8.00	8.00"	—	—	—
UM-SS-10.00	10.00"	—	—	—
UM-SS-12.00	12.00"	—	—	—
UM-SS-14.00	14.00"	—	—	—

Metric

Coolant Attachment Order Number	Cutter Diameter	Thread	Torque	Hex Size
UM-SS-63MM	63mm	M10x1.5	45Nm	8mm
UM-SS-80MM-22	80mm	M10x1.5	45Nm	8mm
UM-SS-80MM-27	80mm	M12x1.75	60Nm	8mm
UM-SS-100MM	100mm	M16x2.0	68Nm	10mm
UM-SS-125MM	125mm	M20x2.5	80Nm	14mm
UM-SS-160MM	160mm	M20x2.5	80Nm	14mm
UM-SS-200MM	200mm	—	—	—
UM-SS-250MM	250mm	—	—	—

For operations that require light weight tooling, Decatur Diamond offers our LW-series Coolant Cap Assemblies

Inch

Coolant Attachment Order Number	Cutter Diameter	Thread*	Torque*	Hex Size*
UM-SS-5.00-LW	5.000	3/4-16	55 ft/lbs	3/8
UM-SS-6.00-LW	6.000	3/4-16	55 ft/lbs	3/8

Metric

Coolant Attachment Order Number	Cutter Diameter	Thread*	Torque*	Hex Size*
UM-SS-125MM-LW	125mm	M20x2.5	80Nm	10mm
UM-SS-160MM-LW	160mm	M20x2.5	80Nm	10mm

* Given values are for the arbor mount bolt

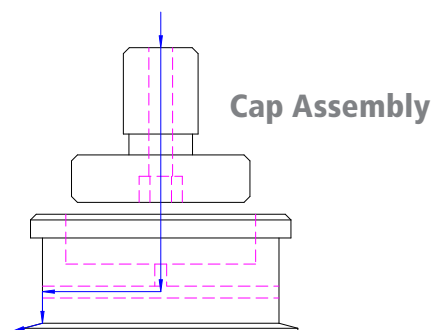

Ultra-Mill Cartridge Identification for Standard Cutters

Nose Radius

- 1=.010" (0,25mm)
- 2=.030" (0,76mm)
- 3=.060" (1,52mm)
- 4=.090" (2,28mm)
- 5=.016" (0,40mm)
- 6=.100" (2,54mm)
- 7=1,0mm (.039")
- 8=1,5mm (.059")
- 9=2,0mm (.078")
- 0=2,5mm (.098")

Axial/Radial Rake*

- 0=0/P
- 1=0/N
- 2=0/O
- 3=P/P
- 4=P/N
- 5=P/O
- 6=N/P
- 7=N/N
- 8=N/O



For information on chip control, contact **Decatur Diamond.**

UC=Ultra-Mill™

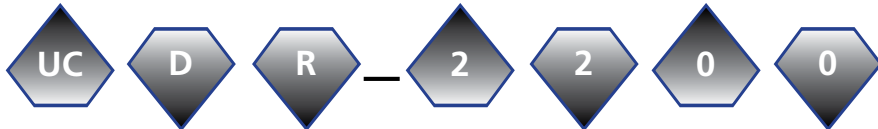

C=Carbide
D=PCD
B=cBN

R=Right Hand
L=Left Hand

Wiper Flat

0=No Wiper

- 1=.060" (1,52mm)
- 2=.080" (2,03mm)
- 3=.100" (2,54mm)
- 4=.120" (3,05mm)

Maximum Depth of Cut

- 0=.200" (5,0mm) Standard
- 1=.250" (6,3mm)
- 2=.375" (9,5mm)
- 3=.500" (12,7mm)
- 4=.625" (15,8mm)
- 5=.750" (19,0mm)

* 0= Neutral P= Positive N= Negative

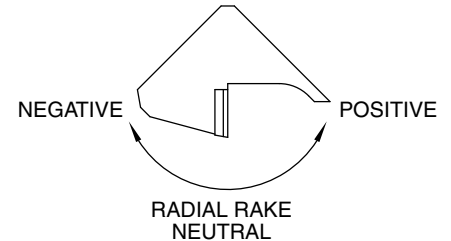
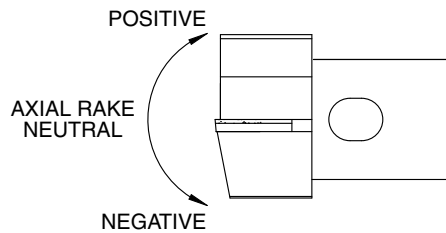
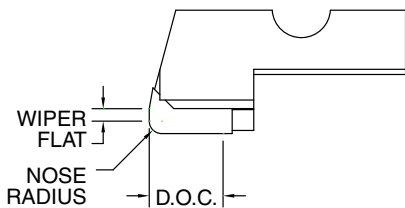

Wiper Cartridge Identification For Standard Cutters

UC=Ultra-Mill™

Wiper Type
W1=Crowned
W2=Flat



D=PCD
B=cBN

R=Right Hand
L=Left Hand

Axial Rake
P=Positive
N=Negative
O=Neutral

Crowned Wiper

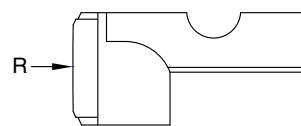

Flat Wiper

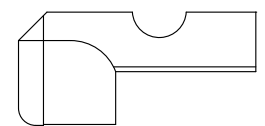

For recommendation on selecting the proper cartridge for your application please visit www.decaturdiamond.com or call the number on the bottom of this page.

Ultra-Mill Intermediate Cutter Body Offerings – Inch

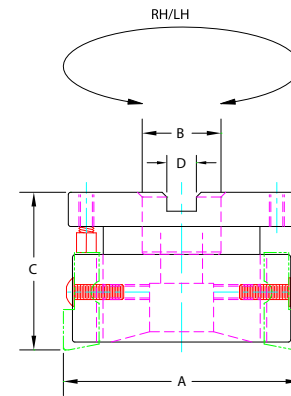
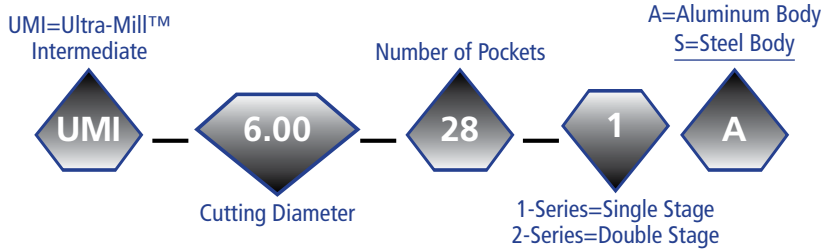

Ultra-Mill™ Intermediate Shell Mill Cutter Body Offerings – Inch

Effective Cutting Dia. A (Inch)	Cutter Order Number	Number of Pockets	B Dimension Bore Diameter	C Dimension Set Height	D Dimension Key Size	Max RPM
2.000	UMI-2.00-8-1A/S	8	0.750	2.375	0.312	17,000
2.500	UMI-2.50-10-1A/S	10	0.750	2.375	0.312	15,500
3.000	UMI-3.00-12-1A/S	12	1.000	2.375	0.375	14,200
4.000	UMI-4.00-18-1A/S	18	1.125	2.375	0.500	12,250
5.000	UMI-5.00-22-1A/S	22	1.500	2.375	0.625	11,000
6.000	UMI-6.00-28-1A/S	28	1.500	2.375	0.625	10,000
8.000	UMI-8.00-38-1A/S	38	2.500	2.375	1.000	8,600
10.000	UMI-10.00-48-1A/S	48	2.500	2.375	1.000	7,750

A = Aluminum Body S = Steel

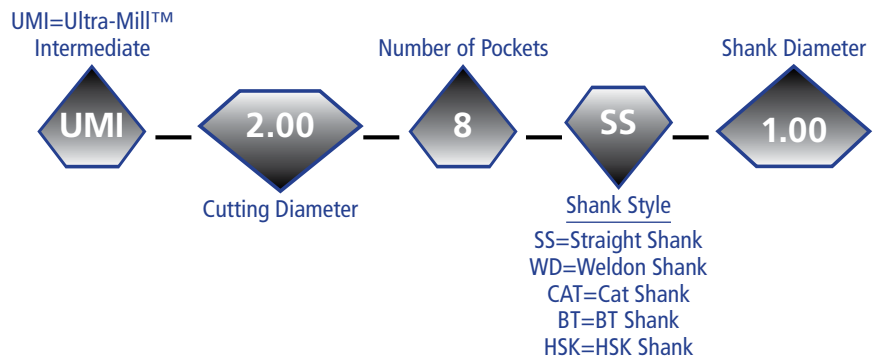
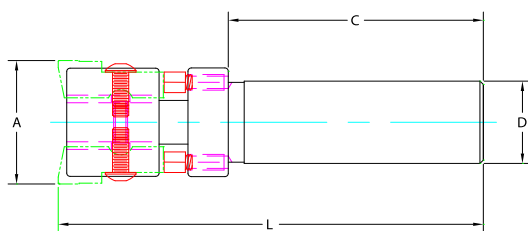

Ultra-Mill™ Intermediate Shank Style Cutter Body Offerings – Inch

Effective Cutting Dia. A (Inch)	Cutter Order Number	Number of Pockets	L Dimension Overall Length	C Dimension Shank Length	D Dimension Shank Diameter	Max RPM
1.500	UMI-1.50-4-SS-1.00	4	5.000	3.000	1.000	20,000
1.500	UMI-1.50-4-SS-1.50	4	5.750	3.750	1.500	20,000
2.000	UMI-2.00-8-SS-1.00	8	5.000	3.000	1.000	15,500
2.000	UMI-2.00-8-SS-1.50	8	5.750	3.750	1.500	15,500

Note: These cutter shanks are manufactured to H6 tolerance in order to maximize tool life, thus we discourage the use of standard endmill holders. We recommend hydraulic chucks or Shrink-fit adapters for these tools. Alternately, these tools can also be made with integral shanks such as HSK, CAT, ANSI, etc. Upon request, we can supply these cutters with a Weldon flat but tool life will suffer due to excessive runout.

Ultra-Mill Intermediate Cutter Body Offerings – Metric

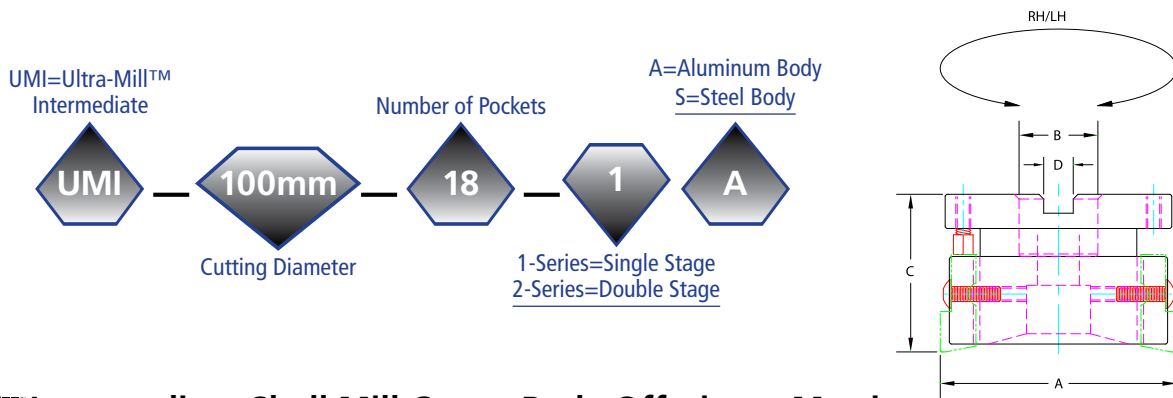

Ultra-Mill Intermediate Shell Mill Cutter Body Offerings – Metric

Effective Cutting Dia. A (mm)	Cutter Order Number	Number of Pockets	B Dimension Bore Diameter	C Dimension Set Height	D Dimension Key Size	Max RPM
50	UMI-50MM-8-1A/S	8	16	60	8	17,000
63	UMI-63MM-10-1A/S	10	22	60	10	15,500
75	UMI-75MM-12-1A/S	12	22	60	14	14,200
100	UMI-100MM-18-1A/S	18	32	60	14	12,250
125	UMI-125MM-22-1A/S	22	40	60	16	11,000
150	UMI-150MM-26-1A/S	26	40	60	16	10,000
200	UMI-200MM-36-1A/S	36	60	60	25	8,600
250	UMI-250MM-46-1A/S	46	60	60	25	7,750

A = Aluminum Body S = Steel

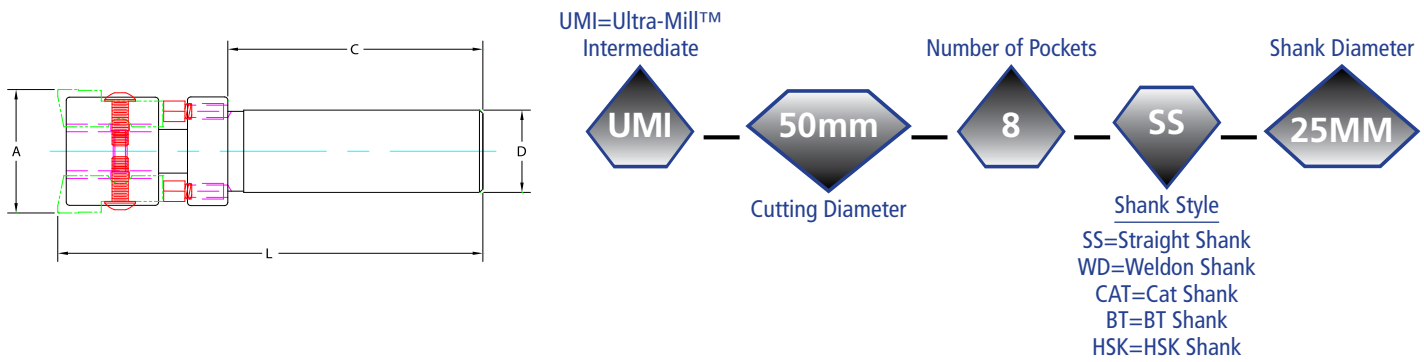

Ultra-Mill Intermediate Shank Style Cutter Body Offerings – Metric

Effective Cutting Dia. A (mm)	Cutter Order Number	Number of Pockets	L Dimension Overall Length	C Dimension Shank Length	D Dimension Shank Diameter	Max RPM
38	UMI-38MM-4-SS-25MM	4	126	76	25	20,000
38	UMI-38MM-4-SS-32MM	4	130	80	32	20,000
50	UMI-50MM-8-SS-25MM	8	126	76	25	15,500
50	UMI-50MM-8-SS-32MM	8	130	80	32	15,500

Note: These cutter shanks are manufactured to H6 tolerance in order to maximize tool life, thus we discourage the use of standard endmill holders. We recommend hydraulic chucks or Shrink-fit adapters for these tools. Alternately, these tools can also be made with integral shanks such as HSK, CAT, ANSI, etc. Upon request, we can supply these cutters with a Weldon flat but tool life will suffer due to excessive runout.

Ultra-Mill Thru Spindle Coolant Attachments for Intermediate Cutters

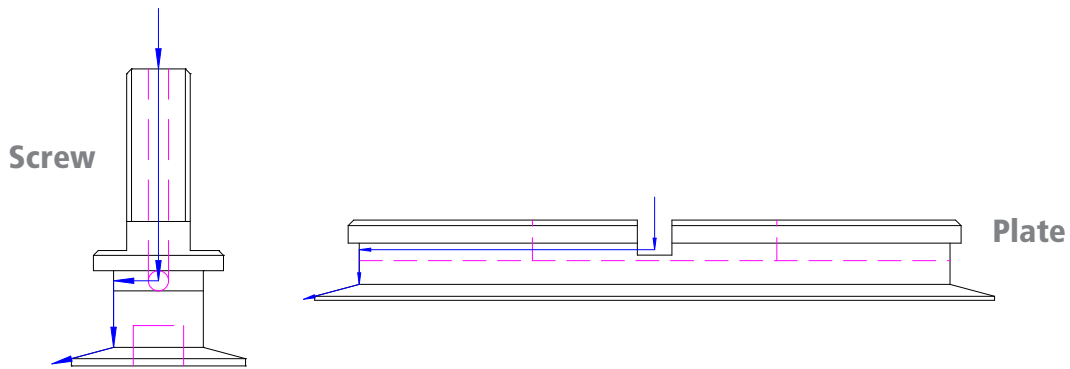

Inch

Coolant Attachment Order Number	Cutter Diameter	Thread	Torque	Hex Size
UI-SS-2.00	2.000	3/8-24	35 ft/lbs	3/16
UI-SS-2.50	2.500	3/8-24	35 ft/lbs	3/16
UI-SS-3.00	3.000	1/2-20	40 ft/lbs	5/16
UI-SS-4.00	4.000	5/8-18	45 ft/lbs	3/8
UI-SS-5.00	5.000	3/4-16	55 ft/lbs	3/8
UI-SS-6.00	6.000	3/4-16	55 ft/lbs	5/8
UI-SS-8.00	8.000	—	—	—
UI-SS-10.00	10.000	—	—	—
UI-SS-12.00	12.000	—	—	—
UI-SS-14.00	14.000	—	—	—

Metric

Coolant Attachment Order Number	Cutter Diameter	Thread	Torque	Hex Size
UI-SS-50MM	50mm	M8x1.25	50Nm	5mm
UI-SS-63MM	63mm	M10x1.5	45Nm	8mm
UI-SS-75MM	75mm	M10x1.5	45Nm	8mm
UI-SS-80MM-22	80mm	M10x1.5	45Nm	8mm
UI-SS-80MM-27	80mm	M12x1.75	60Nm	8mm
UI-SS-100MM	100mm	M16x2.0	68Nm	10mm
UI-SS-125MM	125mm	M20x2.5	80Nm	14mm
UI-SS-150MM	150mm	M20x2.5	80Nm	14mm
UI-SS-200MM	200mm	—	—	—
UI-SS-250MM	250mm	—	—	—

For operations that require light weight tooling, Decatur Diamond offers our LW-series Coolant Cap Assemblies

Inch

Coolant Attachment Order Number	Cutter Diameter	Thread*	Torque*	Hex Size*
UI-SS-5.00-LW	5.000	3/4-16	55 ft/lbs	3/8
UI-SS-6.00-LW	6.000	3/4-16	55 ft/lbs	3/8

Metric

Coolant Attachment Order Number	Cutter Diameter	Thread*	Torque*	Hex Size*
UI-SS-125MM-LW	125mm	M20x2.5	80Nm	10mm
UI-SS-150MM-LW	150mm	M20x2.5	80Nm	10mm

* Given values are for the arbor mount bolt

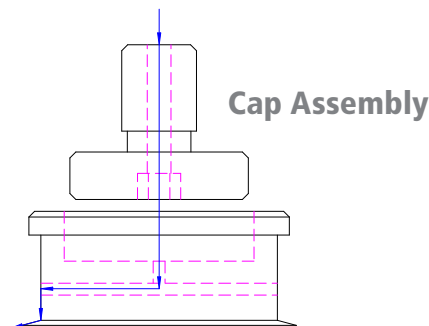

Ultra-Mill Cartridge Identification for Intermediate Cutters

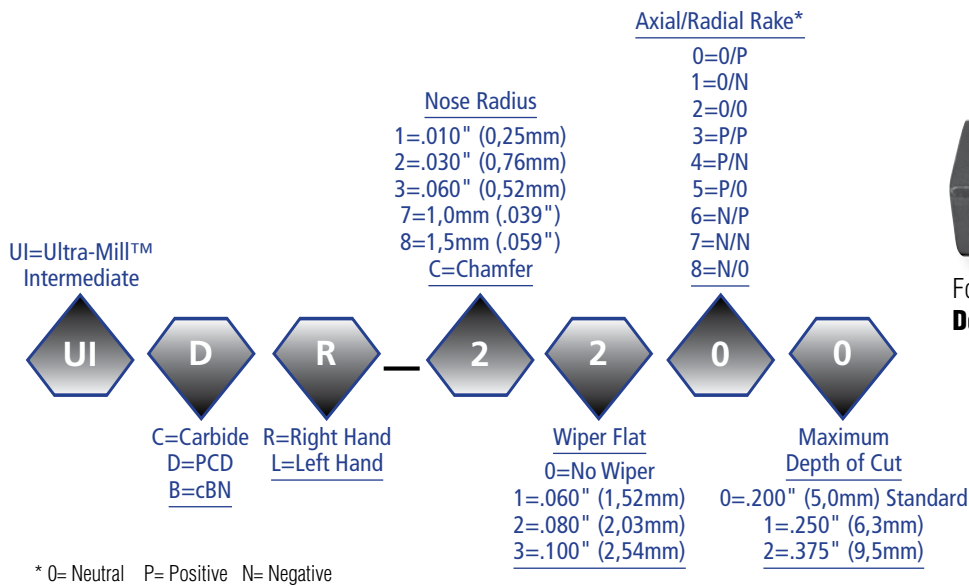

For information on chip control, contact **Decatur Diamond.**

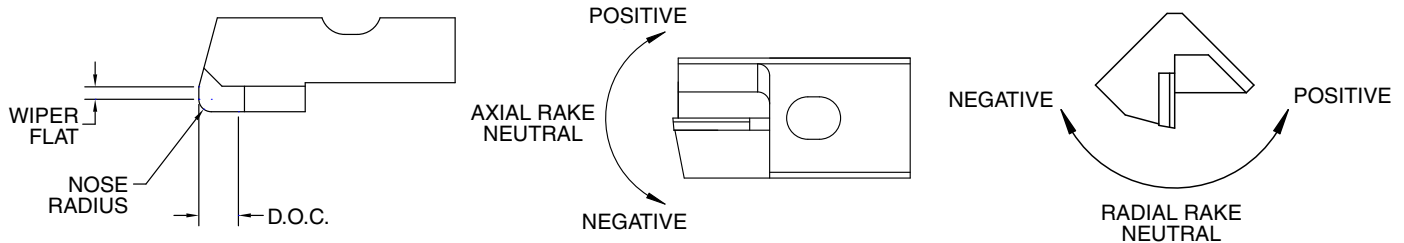

Wiper Cartridge Identification For Intermediate Cutters

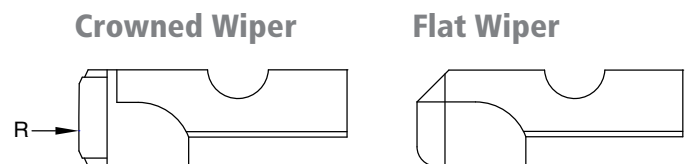
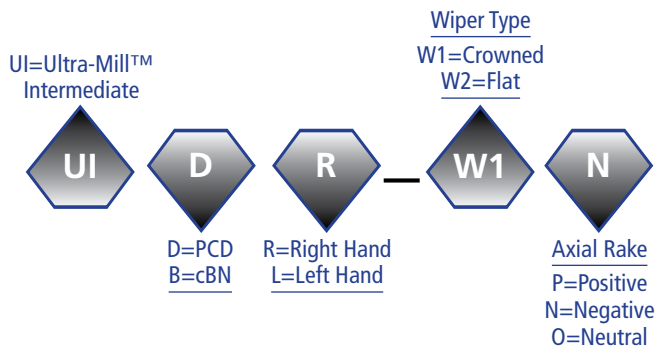

For recommendation on selecting the proper cartridge for your application please visit www.decaturdiamond.com or call the number on the bottom of this page.

Ultra-Mill Mini Endmill Shank Style Cutter Body Offerings – Inch

Decatur Diamond offers the Ultra-Mill Mini Endmill when machining small areas as well. What separates the Mini Endmill from its Ultra Endmill counterpart is that it has more cartridges per cutting diameter, which allows the user to increase the feed rate and hence increase throughput and production.

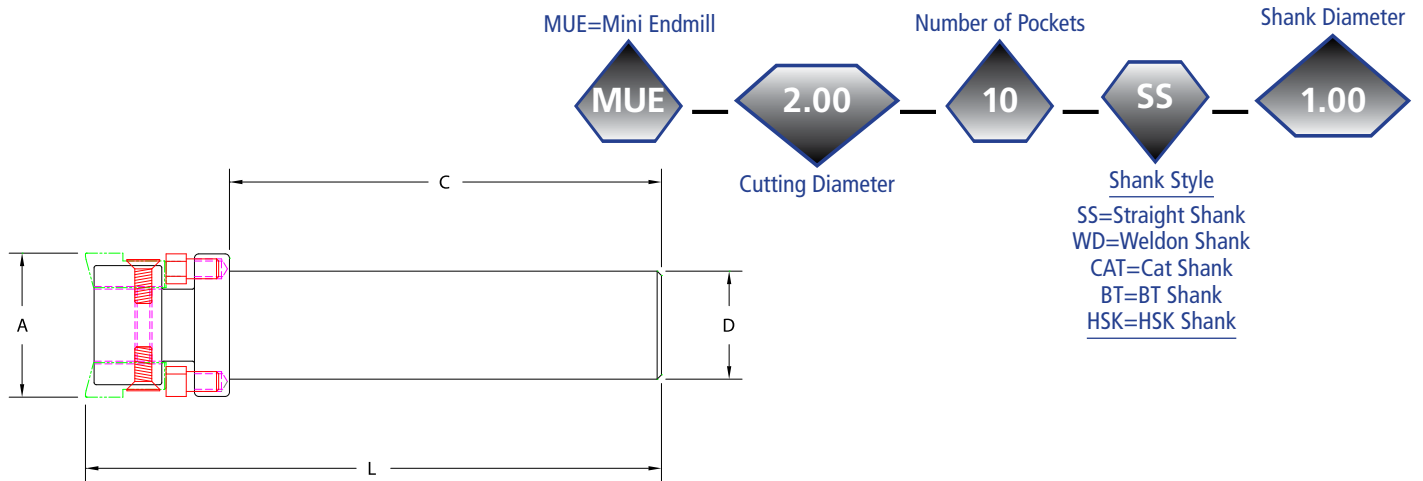

Effective Cutting Dia. A (Inch)	Cutter Order Number	Number of Pockets	L Dimension Overall Length	C Dimension Shank Length	D Dimension Shank Diameter	D.O.C. Max
1.00	MUE-1.00-6-SS-.75	6	3.75	2.75	0.750	0.150
1.00	MUE-1.00-6-SS-1.00	6	4.00	3.00	1.000	0.150
1.25	MUE-1.25-6-SS-.625	6	3.50	2.50	0.625	0.150
1.25	MUE-1.25-6-SS-.75	6	3.75	2.75	0.750	0.150
1.25	MUE-1.25-6-SS-1.00	6	4.00	3.00	1.000	0.150
1.50	MUE-1.50-6-SS-.625	6	3.50	2.50	0.625	0.150
1.50	MUE-1.50-6-SS-.75	6	3.75	2.75	0.750	0.150
1.75	MUE-1.75-8-SS-1.00	8	4.00	3.00	1.000	0.150
1.75	MUE-1.75-8-SS-1.25	8	4.25	3.25	1.250	0.150
2.00	MUE-2.00-10-SS-1.25	10	4.25	3.25	1.250	0.150

Note: These cutter shanks are manufactured to H6 tolerance in order to maximize tool life, thus we discourage the use of standard endmill holders. We recommend hydraulic chucks or Shrink-fit adapters for these tools. Alternately, these tools can also be made with integral shanks such as HSK, CAT, ANSI, etc. Upon request, we can supply these cutters with a Weldon flat but tool life will suffer due to excessive runout.

Cartridge Identification For Mini Endmills – Inch

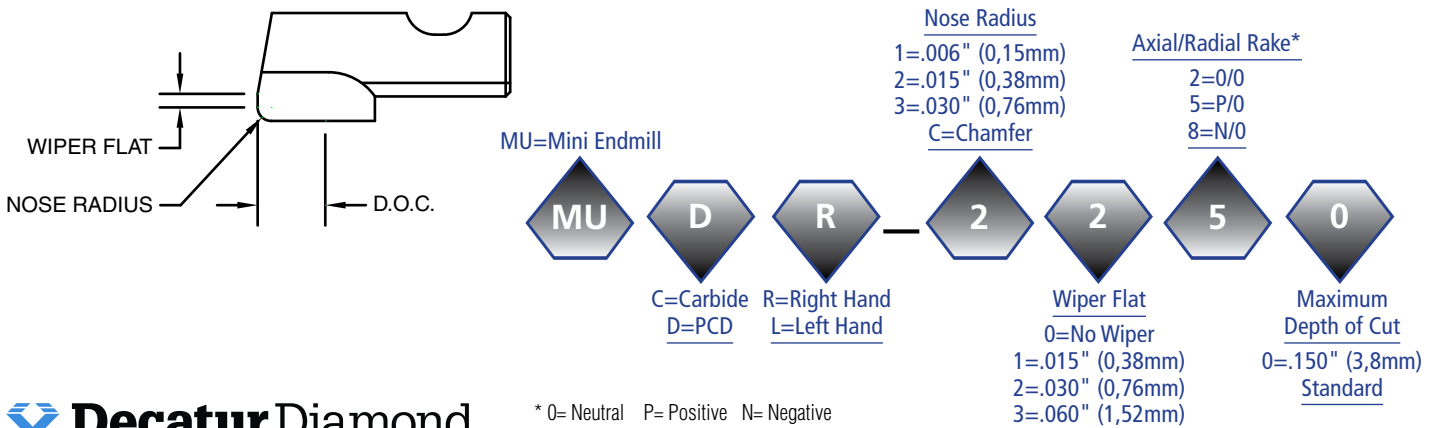

Ultra-Mill Mini Endmill Shank Style Cutter Body Offerings – Metric

Decatur Diamond offers the Ultra-Mill Mini Endmill when machining small areas as well. What separates the Mini Endmill from its Ultra Endmill counterpart is that it has more cartridges per cutting diameter, which allows the user to increase the feed rate and hence increase throughput and production.

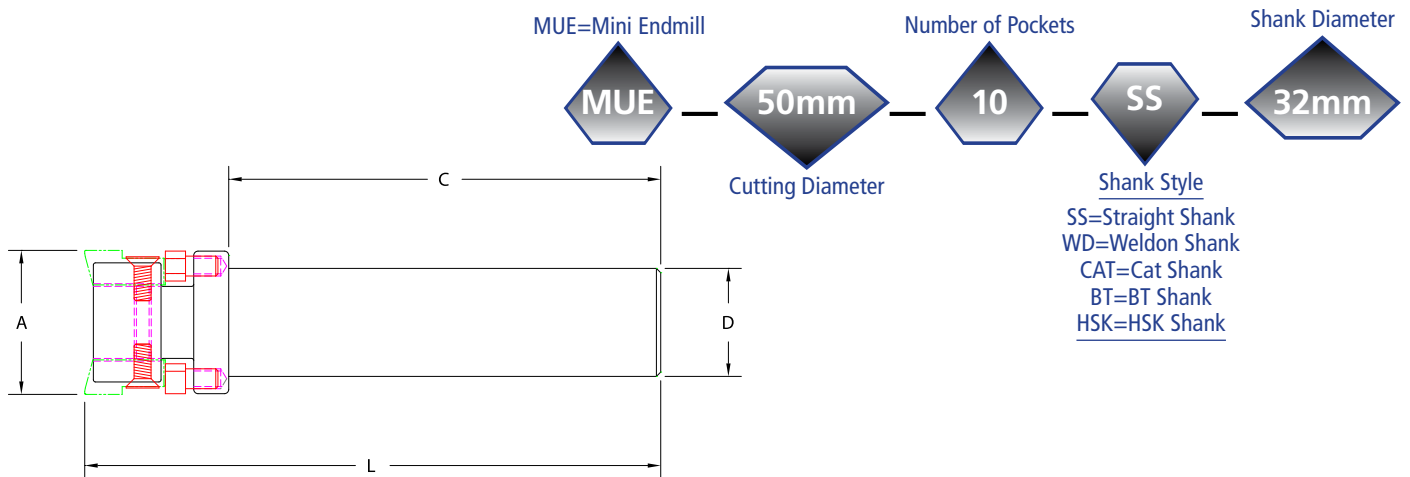

Effective Cutting Dia. A (mm)	Cutter Order Number	Number of Pockets	L Dimension Overall Length	C Dimension Shank Length	D Dimension Shank Diameter	D.O.C. Max
25	MUE-25MM-6-SS-20MM	6	104	74	20	3,8
25	MUE-25MM-6-SS-25MM	6	121	91	25	3,8
32	MUE-32MM-6-SS-20MM	6	104	74	20	3,8
32	MUE-32MM-6-SS-25MM	6	121	91	25	3,8
38	MUE-38MM-6-SS-20MM	6	104	74	20	3,8
38	MUE-38MM-6-SS-25MM	6	121	91	25	3,8
45	MUE-45MM-8-SS-20MM	8	104	74	20	3,8
45	MUE-45MM-8-SS-32MM	8	133	103	32	3,8
50	MUE-50MM-10-SS-32MM	10	133	103	32	3,8

Note: These cutter shanks are manufactured to H6 tolerance in order to maximize tool life, thus we discourage the use of standard endmill holders. We recommend hydraulic chucks or Shrink-fit adapters for these tools. Alternately, these tools can also be made with integral shanks such as HSK, CAT, ANSI, etc. Upon request, we can supply these cutters with a Weldon flat but tool life will suffer due to excessive runout.

Cartridge Identification For Mini Endmills – Metric

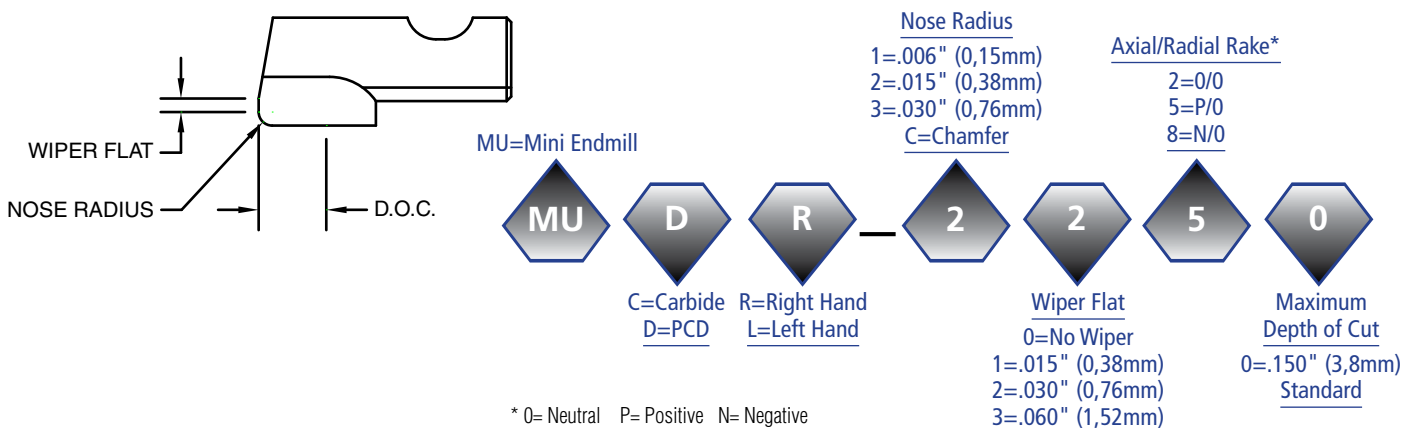

Ultra-Mill Ultra Endmill Shank Style Cutter Offerings–Inch

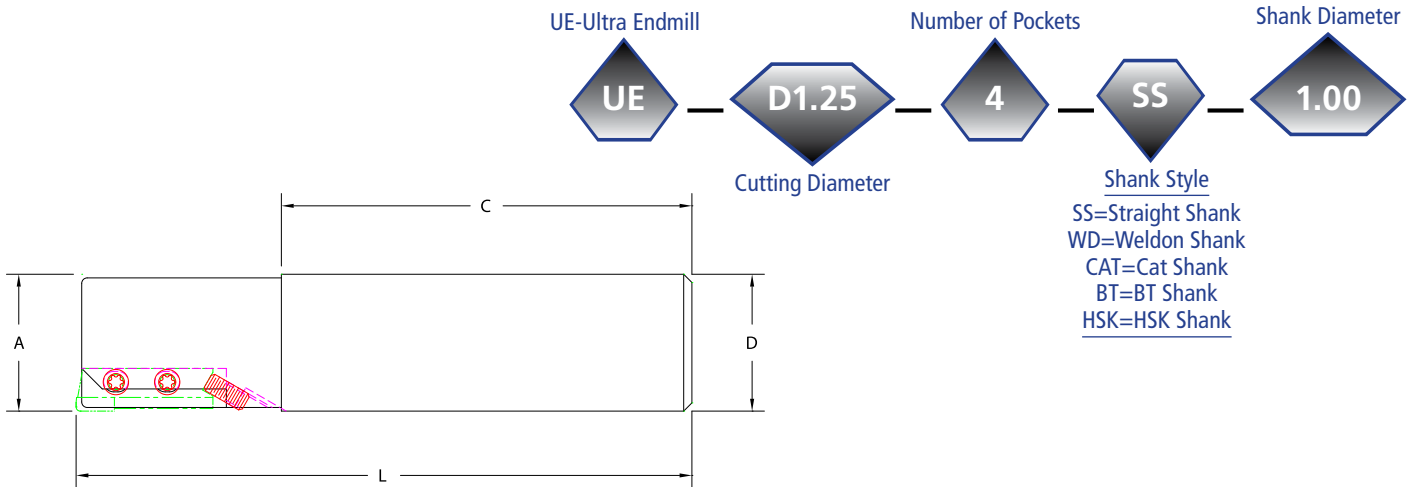

Effective Cutting Dia. A (Inch)	Cutter Order Number	Number of Pockets	L Dimension Overall Length	C Dimension Shank Length	D Dimension Shank Diameter	D.O.C. Max	Max RPM
0.75	UE-D0.75-3-SS-0.75	3	4.250	2.750	0.750	1.00	25,000
1.00	UE-D1.00-3-SS-1.00	3	4.500	3.000	1.000	1.00	25,000
1.25	UE-D1.25-4-SS-1.00	4	4.350	3.000	1.000	1.00	25,000
1.50	UE-D1.50-4-SS-1.00	4	4.500	3.000	1.000	1.00	25,000
1.75	UE-D1.75-4-SS-1.25	4	4.750	3.250	1.250	1.00	25,000
2.00	UE-D2.00-4-SS-1.25	4	4.750	3.250	1.250	1.00	19,000

Note: These cutter shanks are manufactured to H6 tolerance in order to maximize tool life, thus we discourage the use of standard endmill holders. We recommend hydraulic chucks or Shrink-fit adapters for these tools. Alternately, these tools can also be made with integral shanks such as HSK, CAT, ANSI, etc. Upon request, we can supply these cutters with a Weldon flat but tool life will suffer due to excessive runout.

Cartridge Identification For Ultra Endmills–Inch

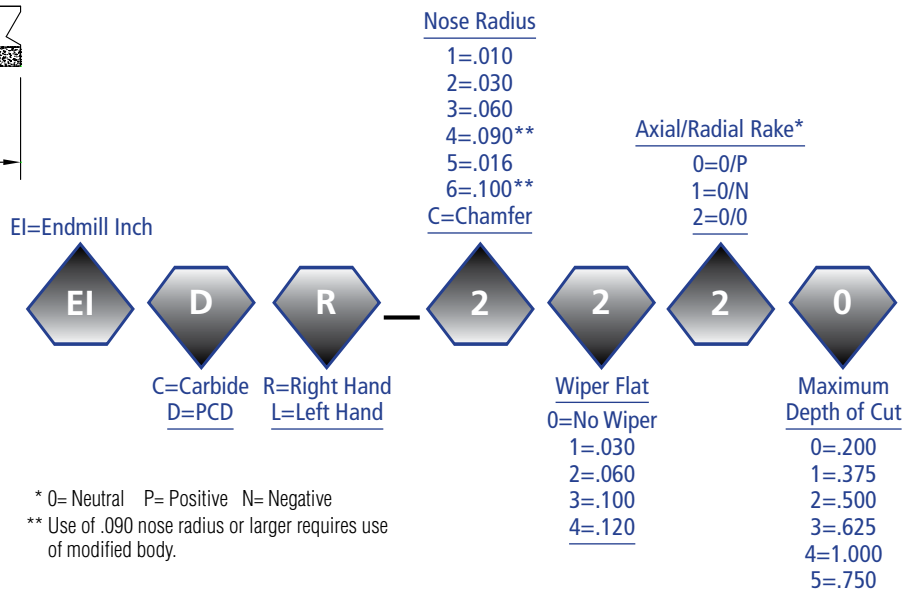
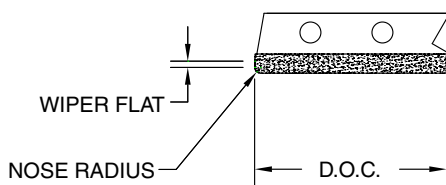

Ultra-Mill Ultra Endmill Shank Style Cutter Offerings – Metric

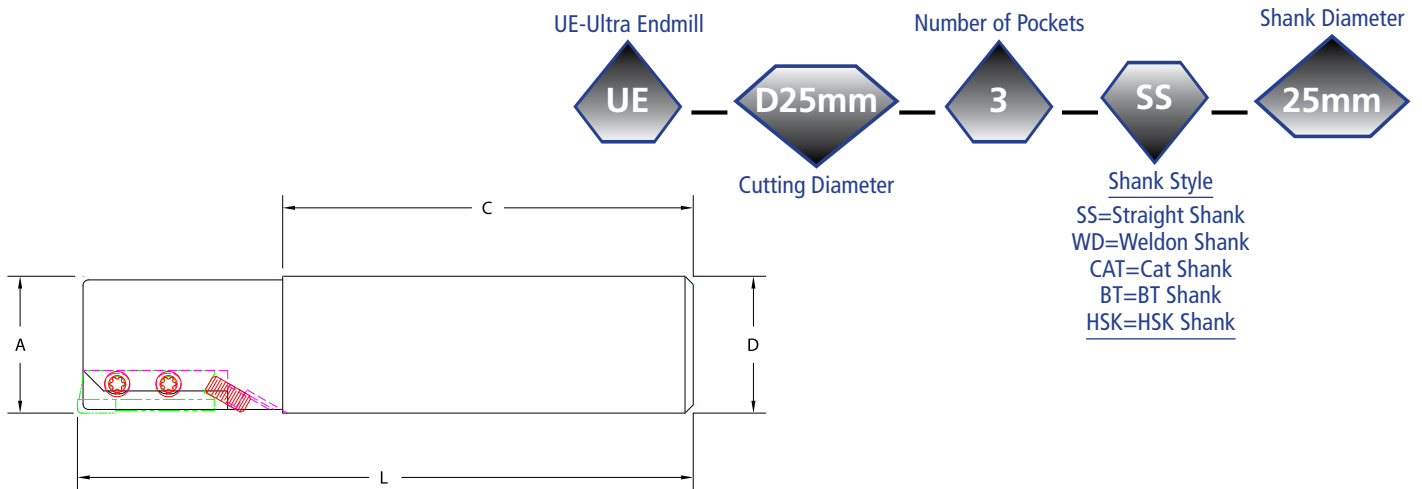

Effective Cutting Dia. A (mm)	Cutter Order Number	Number of Pockets	L Dimension Overall Length	C Dimension Shank Length	D Dimension Shank Diameter	D.O.C. Max	Max RPM
20	UE-D20MM-3-SS-20MM	3	106	66	20	25,0	25,000
25	UE-D25MM-3-SS-25MM	3	116	76	25	25,0	25,000
32	UE-D32MM-3-SS-32MM	3	120	80	32	25,0	25,000
40	UE-D40MM-4-SS-32MM	4	120	80	32	25,0	25,000
50	UE-D50MM-4-SS-32MM	4	120	80	32	25,0	19,000

Note: These cutter shanks are manufactured to H6 tolerance in order to maximize tool life, thus we discourage the use of standard endmill holders. We recommend hydraulic chucks or Shrink-fit adapters for these tools. Alternately, these tools can also be made with integral shanks such as HSK, CAT, ANSI, etc. Upon request, we can supply these cutters with a Weldon flat but tool life will suffer due to excessive runout.

Cartridge Identification For Ultra Endmills – Metric

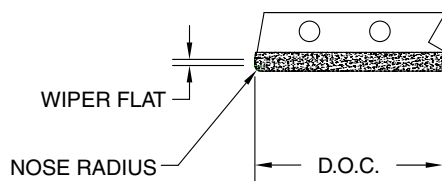

Nose Radius

- 1=0.25
- 2=0.75
- 3=1.50
- 4=2.25**
- 5=0.40
- 6=2.50**

C=Chamfer

Axial/Radial Rake*

- 0=0/P
- 1=0/N
- 2=0/0

EM=Endmill Metric

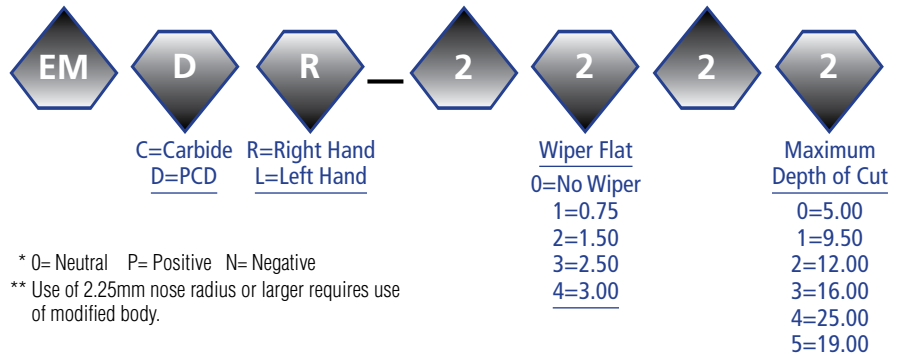

* 0= Neutral P= Positive N= Negative

** Use of 2.25mm nose radius or larger requires use of modified body.

Ultra-Mill Special Tools

In addition to our standard line of milling cutters, Decatur Diamond specializes in custom engineered solutions for your non-ferrous machining needs. Our staff of engineers develop solutions on a daily basis to solve customers' challenges around the world. The uniqueness of the Ultra-Mill system allows us to utilize its' basic components reconfigured into a multitude of application specific special tools. We are a leading manufacturer of PCD solutions and welcome the opportunity to work with you to improve your machining throughput and reduce costs at the same time.



Ultra-Mill™ Multi-Step Boring Bar

Tool Function: Drills thru from a blind hole, creates 3 diameters, a chamfer and 2 shoulders for a differential carrier housing.

Benefits: The Ultra-Mill Boring Bar features replaceable and axially adjustable cartridges. The adjustable cartridges vs. a fixed pocket insert provide a more uniform cut and load sharing which provides more even wear. Their replaceable trait reduces cost compared to a fixed pocket PCD tool. This boring bar also features coolant thru which removes the chips from the cutting edge.

Advantages: The Ultra-Mill Multi-Step Boring Bar replaced a core drill and a fixed pocket boring bar. It provides reduced tooling costs. In addition, the cost to refurbish the diamond components in the bar is much less than retipping a fixed pocket boring bar.



Ultra-Mill™ Core Drill and Facing Tool

Tool Function: Drills through for a pipe thread, chamfers and faces the holes and faces the outer seal surface for an oil filter housing.

Benefits: The replaceable core drill that threads into the tool body allows for easy maintenance and replacement. Axially and radially adjustable cartridges allow for more uniform wear, which enhances tool life and provides improved part finish.

Advantages: This tool configuration replaced 3 tools – therefore reducing cycle time and lowering overall tooling cost.



Ultra-Mill™ OD Form Trepanning Tool

Tool Function: Boring and chamfering 2 diameters and facing one surface.

Benefits: The full form is in each cartridge and each cartridge is radially adjustable for ease of setting.

Advantages: The Ultra-Mill Form Boring Tool replaced 2 tools that interpolated the form. Therefore, this tool has reduced cycle time and has provided a reduction in tool inventory, reducing tool costs.

Ultra-Mill Special Tools

Ultra-Mill™ Fin Mill

Tool Function: Removing casting flash and temporary reinforcements used to equalize cooling rates on die cast cylinder housings.

Benefits: We designed this mill to replace the additional handling and band saw labor used previously to allow the task to be completed within the machining center used to process the part from as-cast to finish machined part.

Advantages: A classic example of using the Ultra Mill base to design a special purpose cutter with special form cartridges allows for standardization of spare parts and hardware, as well as reduction of previously required operations.



Ultra-Mill™ Cubing Mill

Tool Function: Quickly and efficiently removing excess casting stock and establishing locating surfaces prior to loading the casting into a machining center for complete processing.

Benefits: This special Ultra-Mill Cubing Mill allows for higher metal removal rates, reducing machining time and longer tool life than the previous indexable carbide mill.

Advantages: The UltraMill provides almost unlimited freedom to create special tools for specific applications often replacing multiple tools in the process with one tool.



Ultra-Mill Hardware and Adjustment Tools

Decatur Diamond is not responsible for any defects caused by improper use or setting of its milling cutters. Care should be taken and exercised when handling aluminum cutter bodies. Although the outside surface is hard, aluminum will dent or nick from improper handling. Extreme caution should be taken when handling and setting to ensure maximum cutter performance.

Miscellaneous Adjustment Tools

Part No.	Description	Cutter Family
63600	3/16" & 1/4" Cartridge Adjustment Wrench	Ultra-Mills Standard and Intermediate - INCH
63601	Pre-set 45 in/lbs Torque Wrench	Ultra-Mills Standard and Intermediate - INCH
63615	Replacement T-25+ 1/4" Drive Socket	Ultra-Mills Standard and Intermediate - INCH
63602	Torx T-25+ T-Handle Wrench	Ultra-Mills Standard and Intermediate - INCH
63605	6mm & 7mm Cartridge Adjustment Wrench	Ultra-Mills Standard and Intermediate - METRIC
63606	Pre-set 50 in/lbs Torque Wrench	Ultra-Mills Standard and Intermediate - METRIC
63616	Replacement T-25 1/4" Drive Socket	Ultra-Mills Standard and Intermediate - METRIC
63611	Torx T-25 T-Handle Wrench	Ultra-Mills Standard and Intermediate - METRIC
63603	Pre-set 14.5 in/lbs Torque Wrench	Mini Ultra-Mills - INCH and METRIC
63619	Replacement T-9 1/4" Drive Socket	Mini Ultra-Mills - INCH and METRIC
63604	Torx T-9 T-handle Wrench	Mini Ultra-Mills - INCH and METRIC
63600	3/16" & 1/4" Cartridge Adjustment Wrench	Mini Ultra-Mills - INCH
63624	5mm Cartridge Adjustment Wrench	Mini Ultra-Mills - METRIC
63607	Torx T-15 Wing Style Handle Wrench	Ultra-Endmills - INCH and METRIC
63609	Pre-set 19 in/lbs Torque Wrench	Ultra-Endmills - INCH and METRIC
63627	1/16" Allen Cartridge Adjustment Wrench	Ultra-Endmills - INCH
63626	1.5mm Allen Cartridge Adjustment Wrench	Ultra-Endmills - METRIC
63350	UMPP - Pocket Protector	Ultra-Mill - INCH and METRIC
63351	UMIPP - Pocket Protector	Ultra-Mill Intermediate - INCH and METRIC

Hardware

Description	Cartridge Mount Screw	Cartridge Adjustment Nut	Stud for Adjustment Nut	Cartridge Adjustment Screw
Ultra-Mill 2-1/2" Diameter thru 4.0" using UCxx style cartridges	63501	63500	63502	
Ultra-Mill 4-1/2" Diameter or larger using UCxx style cartridges	63503	63500	63504	
Ultra-Mill 63.5mm Diameter thru 76.2mm using UCxx style cartridges	63521	63520	63522	
Ultra-Mill 76.3mm Diameter or larger using UCxx style cartridges	63523	63520	63524	
Ultra-Mill Intermediate 2" Diameter thru 4.0" using Ulxx cartridges	63501	63500	63502	
Ultra-Mill Intermediate 4-1/2" Diameter or larger using Ulxx cartridges	63503	63500	63504	
Ultra-Mill Intermediate 50.0mm using Ulxx cartridges	63529	63520	63522	
Ultra-Mill Intermediate 63.0mm using Ulxx cartridges	63536	63520	63522	
Ultra-Mill Intermediate 75.0mm using Ulxx cartridges	63521	63520	63522	
Ultra-Mill Intermediate 80.0mm Diameter or larger using Ulxx cartridges	63523	63520	63524	
Mini Ultra Endmill 1.0" Diameter Only using MUxx cartridges	63540			63541
Mini Ultra Endmill 1.25" Diameter and Larger using MUxx cartridges	63542			63541
Mini Ultra Endmill 25mm Diameter Only using MUXx cartridges	63540			63568
Mini Ultra Endmill 32mm Diameter and Larger using MUXx cartridges	63542			63568
Ultra Endmill .75" Diameter thru 1.25" using Elxx cartridges	63300			63547
Ultra Endmill 1.50" and larger using Elxx cartridges	63302			63547
Ultra Endmill 20mm Diameter thru 32mm using EMxx cartridges	63527			63528
Ultra Endmill 40mm Diameter and larger using EMxx cartridges	63549			63528

Ultra-Mill Setup Procedure

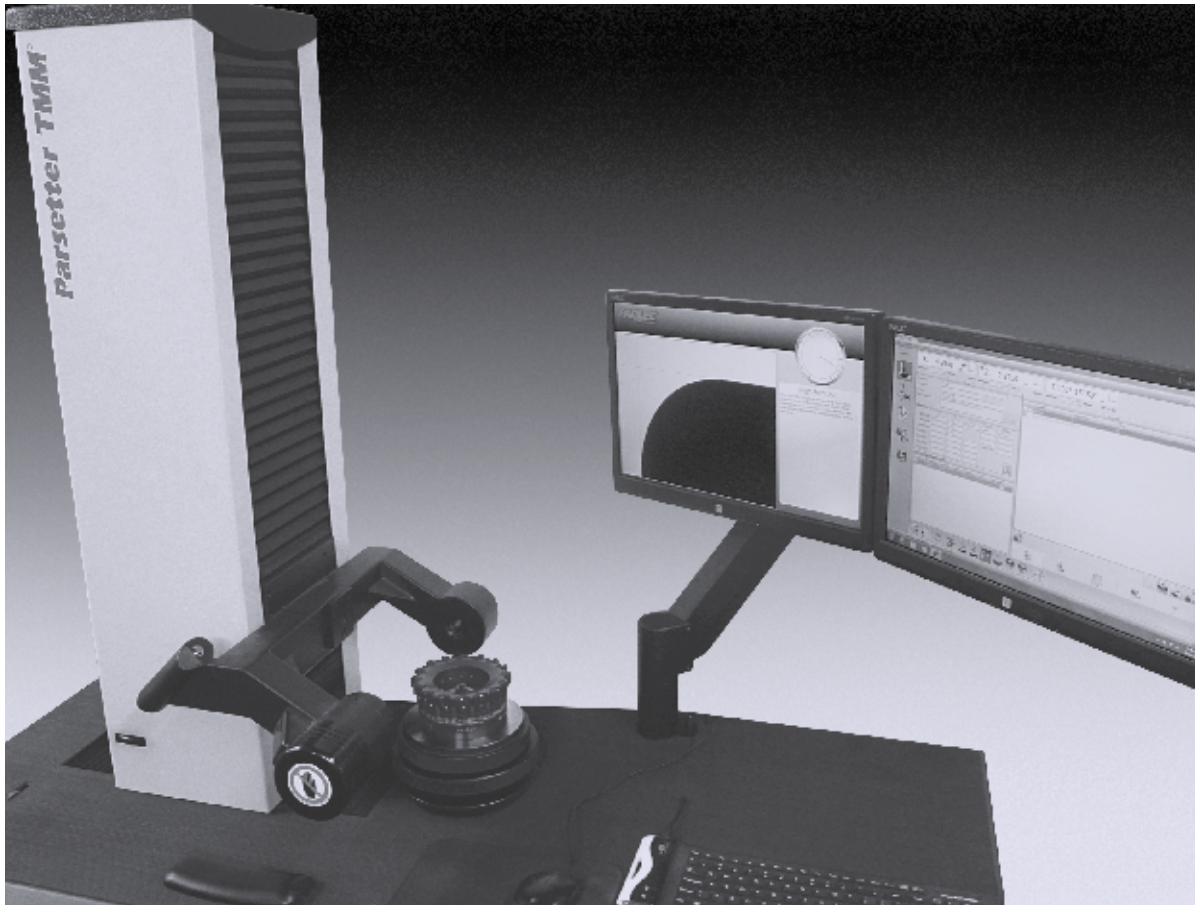

Note:

Decatur Diamond recommends that any tool running at 10,000 rpm or greater be balanced as an assembly G2.5 or better.

- 1.) When installing new cartridges, ensure pockets are clean and free of burrs.
- 2.) Clean bottom of cutter to ensure it is free of burrs and dirt. Cutter must sit flat on surface or setting fixture.
- 3.) Turn axial adjusting nuts or screws down one turn.
- 4.) Install cartridges in body and tighten mounting screw to:
 - a.) Ultra-Mill and Ultra-Mill Intermediate - 15-20 in/lbs or 1.7-2.3 Nm
 - b.) Ultra-Mill Mini Endmill – 8-10 in/lbs or .9-1.2 Nm
 - c.) Ultra Endmill – 10-12 in/lbs or 1-1.5 Nm
- 5.) Set indicator to desired height.
- 6.) Using the proper wrench, adjust cartridges to within .001" or .03mm from setting height.
- 7.) Tighten mounting screws to:
 - a.) Ultra-Mill and Ultra-Mill Intermediate - INCH - 45 in/lbs or 5.1 Nm
 - b.) Ultra-Mill and Ultra-Mill Intermediate - METRIC - 50 in/lbs or 5.7 Nm
 - c.) Ultra-Mill Mini Endmill – 14.5 in/lbs or 1.8 Nm
 - d.) Ultra Endmill – 19 in/lbs or 2.1 Nm
 - i.) Make sure screws are securely tightened
- 8.) Using the proper wrench, adjust cartridges to finished setting height. To achieve the best surface finishes, all cartridges need to be within +/- .0001" or .0025mm.

Ultra-Mill

Formulas, Legend, Milling Theory and Calculations

Note:

The equations and quick-reference charts below do not take into account the condition of the machine or spindle, fixture design or condition, part configuration, size/condition of taper or any other application specific data. Before relying on data gathered from any calculations, please make an assessment of your specific machining conditions and adjust feeds, speeds and depths of cut accordingly. Please do not adjust feed-per-tooth to a value greater than your wiper flat.

Milling Theory and Calculations

Metal Removal Rates:

$$Q = a_e \cdot a_p \cdot v_f$$

Cutting Speed and RPM–Inch:

$$V_c = \frac{n \cdot \pi \cdot D}{12} \quad | \quad V_c = n \div 3.82 \cdot D$$

$$n = \frac{V_c \cdot 12}{\pi \cdot D} \quad | \quad n = V_c \cdot 3.82 \div D$$

Cutting Speed and RPM–Metric:

$$V_c = \frac{n \cdot \pi \cdot D}{1000} \quad | \quad V_c = n \cdot .00314 \cdot D$$

$$n = \frac{V_c \cdot 1000}{\pi \cdot D} \quad | \quad n = V_c \cdot 318.057 \div D$$

Average Chip Thickness:

$$h_m = f_z \cdot \sqrt{\frac{a_e}{D}} \quad | \quad f_z = h_m \cdot \sqrt{\frac{D}{a_e}}$$

Axial chip thinning requires increase in feed rate to maintain proper chip thickness.

- If $a_p \leq 25\%$ of cartridge radius, increase feed by 4x
- If $a_p = 26-50\%$ of cartridge radius, increase feed by 2x
- If $a_p = 51-75\%$ of cartridge radius, increase feed by 25%
- If $a_p = 100\%$ or more of cartridge radius, do not increase feed

Formulas and Legend

D = Cutting Diameter

D_w = Working Diameter

R = Cutter Radius

z = Number of Teeth

z_c = Effective Number of Teeth

n = RPM

V_c = Surface Feet/Meters per Minute

v_f = Cutter Feed–Inches/mm per Minute

f = Feed per Revolution

f_z = Feed per Tooth

h_m = Average Chip Thickness

a_e = Width of Cut–Radial Depth of Cut

a_p = Depth of Cut–Axial Depth of Cut

Q = Metal Removal Rate–in³/min or mm³/min

K = Lead Angle

π = Pi (3.1415)

Note:

If using a two- or three- stage Ultramill, use the effective (z_c) number of teeth to calculate feed rate.

Feed Rates:

$$V_f = n \cdot z \cdot f_z \quad \text{or} \quad V_f = n \cdot z_c \cdot f_z$$

$$f = z \cdot f_z \quad \text{or} \quad f = z_c \cdot f_z$$

Note:

Use to calculate when width of cut (a_e) is less than 50% of D.

Quick Reference:

a_e =	increase feed by:
35%	1.20
25%	1.45
10%	2.05
5%	3.00

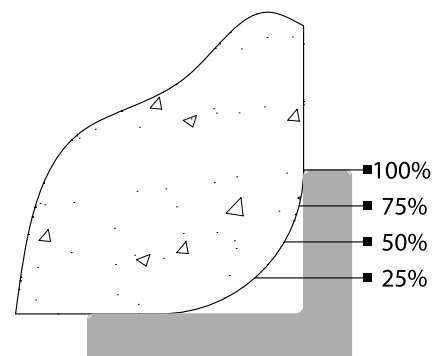

Ultra-Mill Cutting Data

Inch

Cutter Family	Low Silicon Aluminums			Medium Silicon Aluminums			High Silicon Aluminums		
	<8% Silicon			8-10% Silicon			>10% Silicon		
	Cutting Speed Vc			Cutting Speed Vc			Cutting Speed Vc		
	2000	4000	10,000	2000	3000	6000	1000	1500	2000
	Feed Rate per Tooth fz			Feed Rate per Tooth fz			Feed Rate per Tooth fz		
Ultramill	0.001	0.004	0.008	0.001	0.004	0.008	0.001	0.004	0.008
Ultramill Intermediate	0.001	0.004	0.006	0.001	0.004	0.006	0.001	0.004	0.006
Ultramill Mini	0.001	0.003	0.004	0.001	0.003	0.004	0.001	0.003	0.004
Ultra Endmill	0.001	0.003	0.004	0.001	0.003	0.004	0.001	0.003	0.004
Cutter Family	Copper – Bronze – Zinc			Free Machining Alloys			Carbide and Ceramic (Green)		
				ie: Gold, Platinum, Lead					
	Cutting Speed Vc			Cutting Speed Vc			Cutting Speed Vc		
	1000	1500	2500	500	1000	1500	500	1000	1500
	Feed Rate per Tooth fz			Feed Rate per Tooth fz			Feed Rate per Tooth fz		
Ultramill	0.001	0.003	0.006	0.003	0.004	0.007	0.002	0.004	0.008
Ultramill Intermediate	0.001	0.003	0.005	0.003	0.004	0.006	0.002	0.004	0.006
Ultramill Mini	0.001	0.002	0.005	0.002	0.003	0.005	0.001	0.003	0.004
Ultra Endmill	0.001	0.002	0.005	0.002	0.003	0.005	0.001	0.003	0.004
Cutter Family	Unfilled Plastics			Reinforced Plastics			Manufactured Wood		
				ie: Carbon Fiber Composites					
	Cutting Speed Vc			Cutting Speed Vc			Cutting Speed Vc		
	1500	2500	5000	1500	2500	5000	3000	6000	8000
	Feed Rate per Tooth fz			Feed Rate per Tooth fz			Feed Rate per Tooth fz		
Ultramill	0.001	0.003	0.006	0.002	0.003	0.005	0.004	0.006	0.010
Ultramill Intermediate	0.001	0.003	0.005	0.002	0.003	0.004	0.004	0.006	0.008
Ultramill Mini	0.001	0.002	0.005	0.001	0.002	0.004	0.003	0.005	0.008
Ultra Endmill	0.001	0.002	0.005	0.001	0.002	0.004	0.003	0.005	0.008

Metric

Cutter Family	Low Silicon Aluminums			Medium Silicon Aluminums			High Silicon Aluminums		
	<8% Silicon			8-10% Silicon			>10% Silicon		
	Cutting Speed Vc			Cutting Speed Vc			Cutting Speed Vc		
	610	1220	3050	610	915	1830	305	460	610
	Feed Rate per Tooth fz			Feed Rate per Tooth fz			Feed Rate per Tooth fz		
Ultramill	0.025	0.100	0.200	0.025	0.100	0.200	0.025	0.100	0.200
Ultramill Intermediate	0.025	0.100	0.150	0.025	0.100	0.150	0.025	0.100	0.150
Ultramill Mini	0.025	0.075	0.100	0.025	0.075	0.100	0.025	0.075	0.100
Ultra Endmill	0.025	0.075	0.100	0.025	0.075	0.100	0.025	0.075	0.100
Cutter Family	Copper – Bronze – Zinc			Free Machining Alloys			Carbide and Ceramic (Green)		
				ie: Gold, Platinum, Lead					
	Cutting Speed Vc			Cutting Speed Vc			Cutting Speed Vc		
	305	460	760	150	305	460	150	305	460
	Feed Rate per Tooth fz			Feed Rate per Tooth fz			Feed Rate per Tooth fz		
Ultramill	0.025	0.075	0.150	0.075	0.100	0.180	0.050	0.100	0.200
Ultramill Intermediate	0.025	0.075	0.120	0.075	0.100	0.150	0.050	0.100	0.150
Ultramill Mini	0.025	0.050	0.120	0.050	0.080	0.120	0.025	0.075	0.100
Ultra Endmill	0.025	0.050	0.120	0.050	0.080	0.120	0.025	0.075	0.100
Cutter Family	Unfilled Plastics			Reinforced Plastics			Manufactured Wood		
				ie: Carbon Fiber Composites					
	Cutting Speed Vc			Cutting Speed Vc			Cutting Speed Vc		
	460	760	1525	460	760	1525	915	1830	2440
	Feed Rate per Tooth fz			Feed Rate per Tooth fz			Feed Rate per Tooth fz		
Ultramill	0.025	0.075	0.150	0.050	0.075	0.120	0.100	0.150	0.250
Ultramill Intermediate	0.025	0.075	0.150	0.050	0.075	0.100	0.100	0.150	0.200
Ultramill Mini	0.025	0.050	0.150	0.025	0.050	0.100	0.075	0.120	0.200
Ultra Endmill	0.025	0.050	0.120	0.025	0.050	0.100	0.075	0.120	0.200

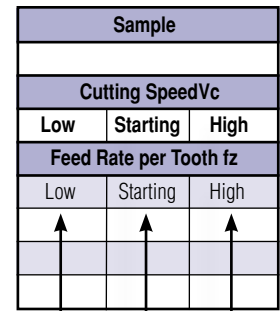

Lowest recommended cutting data

Recommended starting cutting data

Not recommended to exceed without calling **Decatur Diamond**

Note:

Do not exceed maximum RPM listed on product pages.

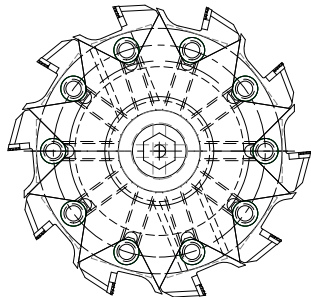

CARTRIDGE:

L: Depth of Cut _____

M: Nose Radius _____

N: Width of Wiper Flat _____

O: Tip Material: PCD _____ CBN _____

Axial Rake: _____

Radial Rake: _____

NEUTRAL 0
POSITIVE P
NEGATIVE N

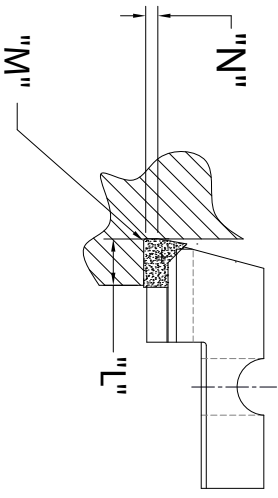
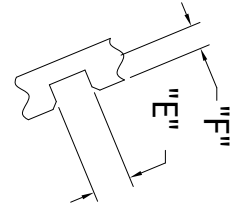

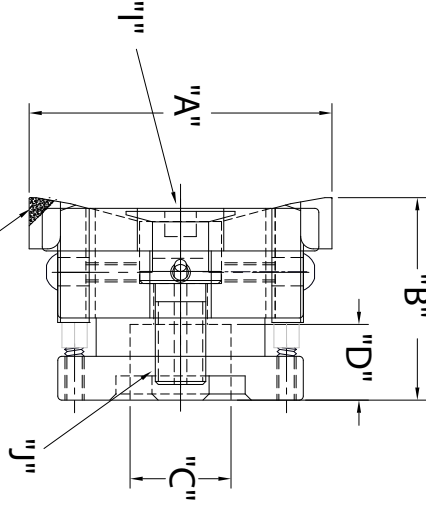
CUTTER TYPE: _____
STANDARD INTERMEDIATE

A: Cutter Diameter _____

B: Set Height _____

C: Pilot Diameter _____

D: Pilot Depth _____

E: Key Way Width _____

F: Key Way Depth _____

G: Number of Teeth _____

H: Matl Being Cut _____

I: Shower Screw Needed? _____

J: Shower Screw Thread _____

K: Cutter Body Material _____

PLEASE PRINT OR TYPE CLEARLY IN ALL CAPS. ALL DIMENSIONS ARE IN INCHES UNLESS OTHERWISE SPECIFIED. ANGLES ARE IN DEGREES UNLESS OTHERWISE SPECIFIED. DECUTUR DIAMOND IS NOT RESPONSIBLE FOR ANY DAMAGE TO OR LOSS OF MATERIAL OR EQUIPMENT CAUSED BY THE USER'S MISUSE OF THE PRODUCT. THE USER SHALL BE RESPONSIBLE FOR THE PROPER USE OF THE PRODUCT. THE USER SHALL BE RESPONSIBLE FOR THE PROPER USE OF THE PRODUCT. THE USER SHALL BE RESPONSIBLE FOR THE PROPER USE OF THE PRODUCT.

DISTRIBUTOR

Decatur Diamond
3031 WEST US HIGHWAY 24
DECATUR, GA 30033
PHONE 578-4214

DRAWN BY: _____

CUSTOMER

DRAWN	DATE	APPROVED	DATE
CHECKED	DATE		DATE

REV	DATE	DESCRIPTION	BY
B			
A			

Ultra-Mill Intermediate and Mini Endmill Shank Style Mills

Quote Request Form

CUTTER

A: Cutter Diameter _____
 B: Overall Length _____
 C: Set Height _____
 D: Shank Diameter _____
 E: Shank Tolerance _____
 F: Flat Width _____
 G: Number of Teeth _____
 H: Mat'l Being Cut _____
 I: Through Coolant? _____

CUTTER

A: Cutter Diameter _____
 B: Overall Length _____
 C: Set Height _____
 D: Shank Diameter _____
 E: Shank Tolerance _____
 F: Flat Width _____
 G: Number of Teeth _____
 H: Mat'l Being Cut _____
 I: Through Coolant? _____

CARTRIDGE :

J: Depth of Cut _____
 K: Nose Radius _____
 L: Width of Wiper Flat _____
 Axial Rake: _____
 Radial Rake: _____

NEUTRAL 0
 POSITIVE P
 NEGATIVE N

DISTRIBUTOR

DRAWN BY:

NOT OTHERWISE SPECIFIED: ANGLE L 25°
 DEC: 3-03 JAN: 01 JAN: 4 001-3007610005

DRAWN	DATE	APPROVED	DATE
CHECKED	DATE	DATE	DATE
Decatur Diamond CUSTOMER		5833 WEST 45TH AVENUE DECATUR, GA 30033 Phone: (770) 547-4156 Fax: (770) 547-4174	
DRAWING NO		REV	
A		B	
132		132	

Ultra-Mill Quote Request

Reference Quote # _____

Sales Person: _____

Date Entered _____ Date Required: _____

Customer Data

Distributor: _____

End User: _____

Contact Person: _____

Contact Person: _____

Phone Number: _____

Phone Number: _____

Address: _____

Address: _____

Current Process Conditions

Milling: Turning: Boring: Drilling: Other: _____

Material to Cut: _____ Spindle RPM: _____ Feed Rate RPM: _____ DOC: _____

Current Tool: Carbide: PCD: Other: _____

Surface Finish Required: _____ Coolant: _____ Thru Spindle: Shower Screw: Flood:

Common Failure Mode: Finish: Wear: Chipping: Burr: Other: _____

Desired Improvement Over Current Tool: Life: Cost: Finish: Other: _____

Proposed Tool

Projected Annual Usage: _____ Catalog: Yes No

New Tool: _____ Quote Quantity: _____

Description: _____

Cutter Diameter / IC: _____

of Stations / Blades: _____ LH: _____ RH: _____

Cartridge Style / Insert: (Geometry) _____

Depth of Cut: _____

Customer Supplied Insert / Tool: Yes No Grade: _____ Manufacturer _____

Special Requirements

PCD Monobloc Tools



Monobloc Tool

Tool Design: PCD tipped monobloc tools with multiple steps and cutting edges. All tool bodies are machined from tool steel and are precision ground from the taper to the PCD blades between centers for the best possible TIR. HSK, CAT, BT and tapers for wet and MQL machining are available. All tools are balanced by design as well as mechanically before shipment.

Application: This tool is used in a cylinder head for the cup plug bore. Challenges are machining the feature in one step and not allowing chips/swarf to fall into the water passages.

Advantages: No assembly, no runout adjustment, no setup of cutting edges to size.



Monobloc Tool

Tool Design: PCD tipped monobloc tools with multiple steps and cutting. All tool bodies are machined from tool steel and are precision ground from the taper to the PCD blades between centers for the best possible TIR. HSK, CAT, BT and tapers for wet and MQL machining are available. All tools are balanced by design as well as mechanically before shipment.

Application: This tool is used in a cylinder head for the springseat face and diameter. Challenges are machining the hole in one step into the casting and not allowing chips in the head nor ring or half ring inside the part.

Advantages: No assembly, no runout adjustment, no setup of cutting edges to size.



Modular Tooling

Tool Design: Built of modular exchangeable components to accommodate exhaust and intake machining of the parent seat and valve guide holes. The body is solid carbide with solid carbide guide pads and PCD blades for precision reaming. Mounted on the reamer is a bushing made from tool steel and PCD tipped. All parts are precision ground between centers for the best possible TIR.

Application: Components are interchangeable to accommodate different exhaust and intake valve seat parent holes. Similar modular solutions are available for engine, transmission, fluid technology, chassis and brake as well as aircraft parts.

Advantages: No assembly, no runout adjustment, no setup of cutting edges to size.



High Precision Reamer

Tool Design: This high precision reaming system is based on using multiple solid carbide guides and PCD inserts to ensure precision hole making with diametric and geometric consistency. For optimal TIR the system is paired with a simple runout adjustment and clamping system designed for this precision reamer system.

Application: For use in all reaming operations requiring precise diameter consistency, straightness and roundness requirements.

Advantages: Precision holes; the operation doesn't follow the pre-bored holes. This system is ideal when more open tolerance requirements exist in situations with low component, fixture or machine spindle rigidity.

*Solutions are available for engine, transmission, fluid technology, chassis and brake as well as aircraft parts.

PCD Monobloc Tools

PCD Contour Milling Cutter

Tool Design: Multiple contoured, precision PCD tips match your required complex contouring operation. The tools are available as steel body monobloc tools, with solid carbide body, and as combination tools.

Application: All axial, radial, circular milling, grooving, and plunging contour operations.

Advantages: No restrictions due to clamping/location of inserts. No difficult set up of multiple inserts to match your contour.



PCD Drills

Tool Design: Our drills are based on solid carbide bodies and either PCD wing tipped, across center or sandwich diamond tipped.

Application: If diametric consistency is needed in your drilled hole or longer life is needed, or you have high silicon content in your material this is the way to go.

Advantages: PCD drills will hold hole size to your specification longer than solid carbide drills can.



Tool Holders for Runout Adjustment

Tool Design: We have multiple precision ground holder solutions with adjustment capabilities for HSK, CAT and BT.

Application: All precision machining operations with weak spindle interface conditions, or high length to diameter ratios.

Advantages: Eliminate runout issues and improve the quality of your machining operation.

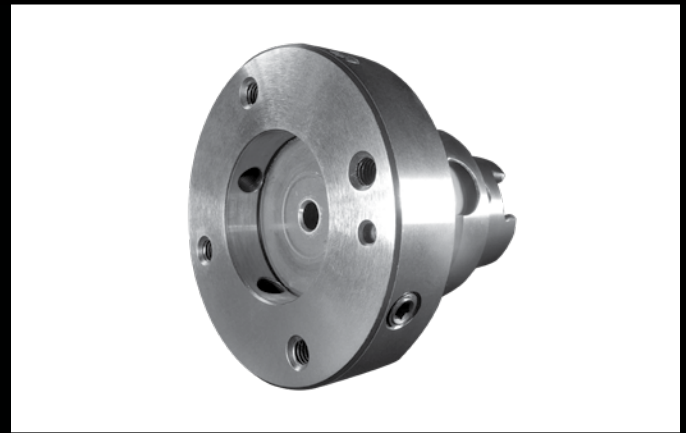

Special Tools

Tool Design: If you did not see an obvious solution above, please contact us with your requirements and we will develop one for you.

Application: Solutions are available for engine, transmission, fluid technology, chassis and brake as well as aircraft parts.

Advantages: If you are using multiple tools and cycle time is an issue, let us deal with tooling solutions that work and which will improve your operations, lower your costs, and improve throughput.



*Solutions are available for engine, transmission, fluid technology, chassis and brake as well as aircraft parts.

DIAbide Tool Grade and Type Description

Decatur Diamond offers a variety of coating options that will satisfy most manufacturing needs. We do have other grades and geometries available for those special applications where general tooling may not provide optimal performance. If you are unsure which tool is best for your application, please contact us for guidance in tool coating and geometry. We are confident we can find a solution for your application.

Decatur Diamond has updated our grade designations; the chart below shows a cross reference from our most common grades you are familiar with to the new designations.

Round Tool Grade Designation:

Previous Grade	Current Grade
03	D23
05	D25
07	D27
08	DDC

Insert Grade Designation:

Previous Grade	Current Grade
18	D38

Unlike conventional PCD diamond, DIAbide can be applied to the surfaces of endmills, drills, inserts and other types of carbide fabricated tools. Producing these tools is an exacting process conducted in high tech CVD reactors over an extended period of time. **Decatur Diamond** supplies the most consistent, highest quality tools for machining of difficult, non-metallic, highly abrasive workpieces.

Decatur Diamond offers six varieties of endmills for your application. They are known by the following codes:

SEP – Square End Profiling

BEP – Ball End Profiling

CRP – Corner Radius Profiling

SEM – Square End Mill

BEM – Ball End Mill

CRM – Corner Radius End Mill

All varieties ending with a “P” are profiling mills that have reduced shanks to allow the user to reach down a vertical wall without interference. All varieties ending with an “M” consist of a non-reduced shank for general purpose milling operations.

All standard endmills are center cutting with a 30 degree right hand spiral flute and can be used for plunge milling.

Complete Diamond Tool Solutions

The world's leading supplier of diamond tooling

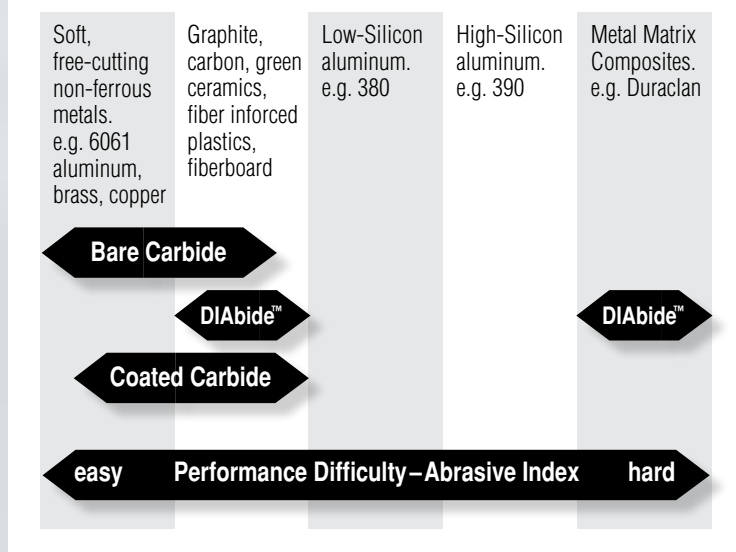

DIAbide™

Thin Film Diamond. The Chemical Vapor Deposition, or CVD, coating process of tungsten carbide enables Decatur Diamond to provide diamond coated carbide tools as the ideal solution for many machining operations. The DIAbide material has gained worldwide acceptance as the proven diamond tool solution for high-speed CNC machining applications of graphite, green ceramic, green carbide, carbon fiber, and other highly abrasive materials. We offer a wide array of DIAbide tools including endmills, profiling endmills, drills, indexable inserts, and profiling inserts. The DIAbide process allows much greater freedom of geometry, which PCD tipped tools cannot achieve, so when unique tool geometry is needed, DIAbide is the solution. Beyond our standard tool offering we can develop special tools for your needs; please give Decatur Diamond a call to inquire about your needs.

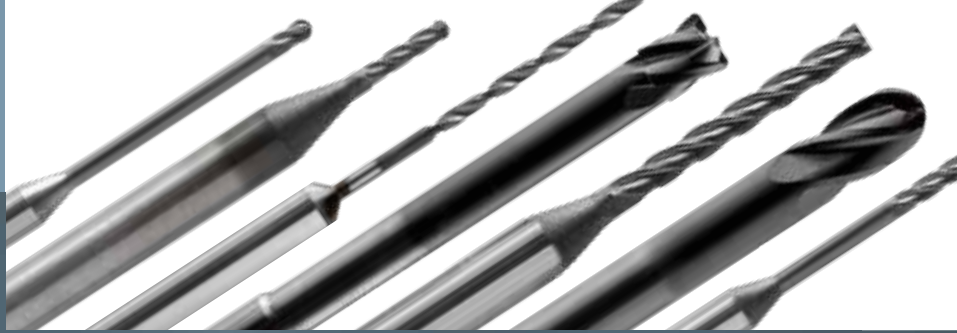

DIAbide Index

Grade Recommendation Chart.....	32
Square End Profiling Endmills (SEP) – Inch/Metric.....	33
Ball End Profiling Endmills (BEP) – Inch/Metric	34
Corner Radius Profiling Endmills (CRP) Inch/Metric...	35
Square Endmills (SEM) – Inch	36
Square Endmills (SEM) – Metric.....	37
Ball Endmills (BEM) – Inch.....	38
Ball Endmills (BEM) – Metric.....	39
Corner Radius Endmills (CRM) – Inch/Metric	40
Ultra Premium Endmills – Inch	41
Jobber Drills, U.S. Fractional and Wire Sizes – Inch/Metric	42
Standard ANSI/ISO Inserts	44
Standard Profiling Inserts (Millstar and Dapra)	45
Tool Tolerance Specifications	46
Cutting Data: Milling Parameters	47
Cutting Data: Turning and Drilling	48
Square/Corner Radius Endmill Quote Request Form	49
Ball Endmill Quote Request Form	50
Drill Quote Request Form	51

DIAbide Grade Recommendation Chart

Decatur Diamond offers CVD diamond coated tools (DIAbide) in a variety of different grades. While the composition of diamond does not change when selecting a different grade, the thickness of the diamond coating does. The thickness of the coating affects the cutting edge of the tool, therefore different thicknesses are recommended for different applications based on the material to be machined. The thinner the diamond, the sharper the cutting edge. **Decatur Diamond** recommends using the thinnest coating that is suitable for the material you are machining. The grade of the tool is added as a suffix to the Part/EDP number, for example an endmill 12002 will become 12002-D25 or 12002-D27 once the grade number is selected.

Material Type	Drilling	Endmilling Roughing	Endmilling Finishing	Turning Roughing	Turning Finishing
Graphite	D25	D25	D23 / D25	D38	D38
Hard Carbon	D27	D27	D25	D38	D38
Green Carbide	D27	D27	D25	D38	D38
Green Ceramic	D25	D25	D23	D38	D38
CMC (Ceramic Matrix Composite)	D27	D27	—	D38	D38
Concrete Materials	—	—	—	—	D38
Plastic (Unfilled)	D25	—	—	D38	—
Filled Plastics	D25 / D27	D25 / D27	D25	D38	—
Thermoset Plastics	D27	D27	D25	D38	—
Carbon Fiber Composites	D27 / DDC	D27 / DDC	D25	D38	—
Glass Fiber Composites	D27 / DDC	D27 / DDC	D25	D38	—
Metal Clad Glass Fiber Composites	D25	D25	—	D38	—
Aramid Fiber Composites	D27 / DDC	D27 / DDC	—	D38	—
Kevlar Composites	DDC	DDC	—	—	—
Free Machining Aluminums	D25	D27 / DDC	—	—	—
Low Silicon Aluminums (<12%)	D27 / DDC	D27 / DDC	—	D38	—
High Silicon Aluminums (>12%)	D27 / DDC	D27 / DDC	—	D38	D38
MMC (Metal Matrix Composites)	D27 / DDC	D27 / DDC	DD07	D38	D38
Copper	D25 / D27	D27	—	—	—
Brass	D25 / D27	D27	—	—	—
Bronze	D25 / D27	D27	—	—	—
Nickel	—	—	—	—	—
Cast Iron	—	—	—	—	—
Steel	—	—	—	—	—
Cobalt	—	—	—	—	—
Chrome	—	—	—	—	—
Molybdenum	—	—	—	—	—
Tungsten	—	—	—	—	—
Titanium	—	—	—	—	—

DIAbide Square End Profiling Endmills (SEP)

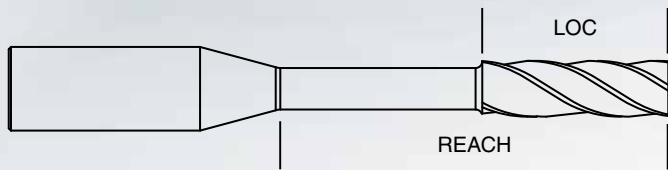

When ordering, choose part number from below and include -D25 or -D27, dependent upon material being machined. For grade recommendations, please see page 32 or call the number at the bottom of the page for assistance.

Inch

Diameter	LOC	OAL	No. of Flutes	Type	Reach	Radius	Part/EDP No.
1/64	3/64	1-1/2	2	SEP	1/8	—	12156
1/32	3/32	3	4	SEP	5/16	—	12127
3/64	3/16	3	4	SEP	15/32	—	12128
1/16	3/32	2-1/2	4	SEP	1	—	12866
1/16	3/32	2-1/2	4	SEP	1/2	—	12392
3/32	3/32	3	4	SEP	3/4	—	12851
3/32	3/8	3	4	SEP	1	—	12130
3/32	9/64	2-1/2	4	SEP	1/2	—	12394
3/32	3/32	3	4	SEP	1-1/2	—	12867
1/8	1/8	4	4	SEP	1	—	12854
1/8	1/8	3	4	SEP	1-1/2	—	12852
3/16	3/16	3	4	SEP	1	—	12398
3/16	1	4	4	SEP	1-7/8	—	12133
1/4	1/4	4	4	SEP	1	—	12491
1/4	1/4	4	4	SEP	2	—	12856
5/16	5/16	4	4	SEP	2	—	12747
3/8	3/8	4	4	SEP	2	—	12859
1/2	1/2	4	4	SEP	2	—	12861

Metric

Diameter	LOC	OAL	No. of Flutes	Type	Reach	Radius	Part/EDP No.
1mm	4	75	4	SEP	10mm	—	12135
2mm	10	75	4	SEP	20mm	—	12136
3mm	3	75	4	SEP	20mm	—	12470
3mm	15	75	4	SEP	30mm	—	12137
4mm	25	75	4	SEP	35mm	—	12720
6mm	6	100	4	SEP	38mm	—	12473
8mm	8	100	4	SEP	50mm	—	12476
10mm	10	100	4	SEP	50mm	—	12479
12mm	12	100	4	SEP	50mm	—	12482

DIAbide Ball End Profiling Endmills (BEP)

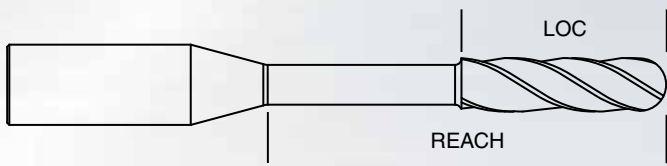

When ordering, choose part number from below and include -D25 or -D27, dependent upon material being machined. For grade recommendations, please see page 32 or call the number at the bottom of the page for assistance.

Inch

Diameter	LOC	OAL	No. of Flutes	Type	Reach	Radius	Part/EDP No.
1/64	3/64	1-1/2	4	BEP	5/32	—	12138
1/32	3/32	3	4	BEP	5/16	—	12139
3/64	3/16	3	4	BEP	15/32	—	12140
3/64	3/16	3	4	BEP	3/4	—	12746
1/16	1/16	3	4	BEP	3/4	—	12810
1/16	3/32	2-1/2	4	BEP	1/2	—	12393
1/16	3/16	3	4	BEP	1	—	12721
3/32	9/64	2-1/2	4	BEP	1/2	—	12395
3/32	3/32	3	4	BEP	3/4	—	12811
3/32	3/8	3	4	BEP	1	—	12142
3/32	9/32	3	4	BEP	1-1/2	—	12722
1/8	1/8	3	4	BEP	1-1/2	—	12812
1/8	1/8	4	4	BEP	1	—	12342
1/8	1	3	4	BEP	1-1/2	—	12143
1/8	3/8	3	4	BEP	2	—	12723
3/16	9/32	4	4	BEP	1-7/8	—	12816
3/16	3/16	3	4	BEP	1	—	12399
3/16	1	4	4	BEP	1-7/8	—	12145
1/4	1/4	4	4	BEP	1	—	12492
1/4	1/4	4	4	BEP	2	—	12813
1/4	1-1/2	4	4	BEP	2	—	12146
5/16	5/16	4	4	BEP	2	—	12815
3/8	3/8	4	4	BEP	2	—	12814
1/2	1/2	4	4	BEP	2	—	12819
1/2	1/2	6	4	BEP	1-1/2	—	12724

Metric

Diameter	LOC	OAL	No. of Flutes	Type	Reach	Radius	Part/EDP No.
1mm	4	75	4	BEP	10mm	—	12147
2mm	10	75	4	BEP	20mm	—	12148
3mm	3	75	4	BEP	20mm	—	12472
3mm	15	75	4	BEP	30mm	—	12149
4mm	25	75	4	BEP	35mm	—	12725
6mm	6	100	4	BEP	38mm	—	12475
8mm	8	100	4	BEP	50mm	—	12478
10mm	10	100	4	BEP	50mm	—	12481
12mm	12	100	4	BEP	50mm	—	12484

DIAbide Corner Radius Profiling Endmills (CRP)

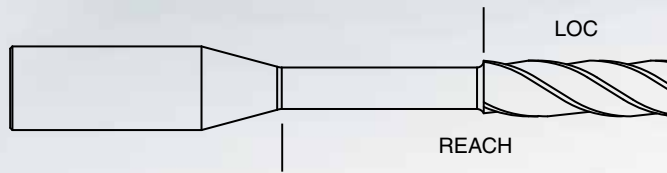

When ordering, choose part number from below and include -D25 or -D27, dependent upon material being machined. For grade recommendations, please see page 32 or call the number at the bottom of the page for assistance.

Inch

Diameter	LOC	OAL	No. of Flutes	Type	Reach	Radius	Part/EDP No.
1/32	3/64	2-1/2	4	CRP	1/2	.010	12566
1/32	3/32	3	4	CRP	1/2	.005	12726
3/64	9/64	3	4	CRP	9/16	.010	12727
3/64	3/64	2-1/2	4	CRP	5/8	.010	12567
1/16	3/32	2-1/2	4	CRP	5/8	.010	12568
1/16	3/16	3	4	CRP	1	.010	12728
5/64	5/64	2-1/2	4	CRP	5/8	.010	12569
3/32	9/64	2-1/2	4	CRP	1	.010	12570
3/32	9/32	3	4	CRP	1-1/2	.010	12729
1/8	1/8	4	4	CRP	1	.015	12455
1/8	3/8	3	4	CRP	2	.010	12730
1/8	1/8	3	4	CRP	1-1/2	.015	12853
1/8	3/4	3	4	CRP	1-1/2	.020	12731
1/8	3/4	3	4	CRP	1-1/2	.030	12153
3/16	3/16	4	4	CRP	1-1/2	.020	12581
1/4	1/4	4	4	CRP	1	.015	12864
1/4	1/4	4	4	CRP	2	.062	12458
1/4	1/4	4	4	CRP	2	.030	12574
1/4	1-1/2	4	4	CRP	2-1/2	.030	12155
1/4	1/4	4	4	CRP	2	.020	12463
1/4	1/4	6	4	CRP	3	.020	12577
1/4	1	4	4	CRP	2-1/2	.030	12732
1/4	1	4	4	CRP	2-1/2	.060	12733
3/8	3/8	4	4	CRP	2	.020	12576
3/8	3/8	6	4	CRP	3	.020	12578
1/2	1/2	4	4	CRP	2	.015	12862
1/2	1/2	6	4	CRP	3	.020	12579

Metric

Diameter	LOC	OAL	No. of Flutes	Type	Reach	Radius	Part/EDP No..
1mm	3	75	4	CRP	10mm	.2mm	12734
2mm	3	75	4	CRP	20mm	.2mm	12735
3mm	3	75	4	CRP	20mm	.2mm	12471
4mm	4	75	4	CRP	35mm	.5mm	12736
6mm	6	100	4	CRP	38mm	.5mm	12474
8mm	8	100	4	CRP	50mm	.5mm	12477
10mm	10	100	4	CRP	50mm	.5mm	12480
12mm	12	100	4	CRP	50mm	.5mm	12483

DIAbide Square Endmills (SEM) – Inch

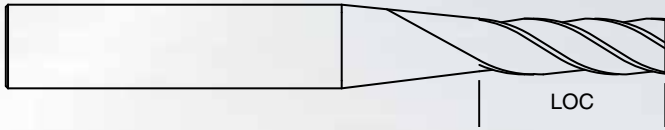

When ordering, choose part number from below and include -D25 or -D27, dependent upon material being machined. For grade recommendations, please see page 32 or call the number at the bottom of the page for assistance.

Inch

Diameter	LOC	OAL	No. of Flutes	Type	Reach	Radius	Part/EDP No.
1/64	3/64	1-1/2	4	SEM	—	—	12121
1/32	3/32	1-1/2	4	SEM	—	—	12103
1/16	1/4	1-1/2	4	SEM	—	—	12092
1/16	1/2	3	4	SEM	—	—	12161
1/16	1/2	2-1/2	4	SEM	—	—	12900
5/64	1/4	1-1/2	4	SEM	—	—	12111
3/32	3/8	1-1/2	4	SEM	—	—	12039
1/8	1/2	1-1/2	4	SEM	—	—	12002
1/8	1	3	4	SEM	—	—	12040
3/16	5/8	2	4	SEM	—	—	12005
3/16	1	4	4	SEM	—	—	12041
1/4	3/4	2-1/2	4	SEM	—	—	12008
1/4	1-1/2	4	4	SEM	—	—	12042
1/4	1-1/2	6	4	SEM	—	—	12043
5/16	7/8	2-1/2	4	SEM	—	—	12011
5/16	1-1/2	4	4	SEM	—	—	12044
3/8	1	2-1/2	4	SEM	—	—	12014
3/8	1-1/2	4	4	SEM	—	—	12045
3/8	1-1/2	6	4	SEM	—	—	12046
1/2	1	3	4	SEM	—	—	12017
1/2	2	4	4	SEM	—	—	12047
1/2	3	6	4	SEM	—	—	12019
3/4	1-1/2	4	4	SEM	—	—	12198
1	1-1/2	4	4	SEM	—	—	12199

DIAbide Square Endmills (SEM) – Metric

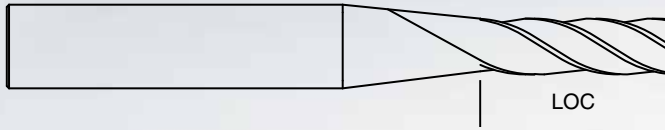

When ordering, choose part number from below and include -D25 or -D27, dependent upon material being machined. For grade recommendations, please see page 32 or call the number at the bottom of the page for assistance.

Metric

Diameter	LOC	OAL	No. of Flutes	Type	Reach	Radius	Part/EDP No.
1mm	4	38	4	SEM	—	—	12115
2mm	10	65	4	SEM	—	—	12058
3mm	15	40	4	SEM	—	—	12059
3mm	25	75	4	SEM	—	—	12060
4mm	15	50	4	SEM	—	—	12061
4mm	25	75	4	SEM	—	—	12062
6mm	20	60	4	SEM	—	—	12063
6mm	40	150	4	SEM	—	—	12065
8mm	20	65	4	SEM	—	—	12066
8mm	40	100	4	SEM	—	—	12067
10mm	26	65	4	SEM	—	—	12068
10mm	40	150	4	SEM	—	—	12070
12mm	30	75	4	SEM	—	—	12071
12mm	50	100	4	SEM	—	—	12072
12mm	75	150	4	SEM	—	—	12073

DIAbide Ball Endmills (BEM) – Inch

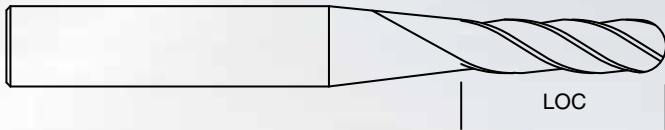

When ordering, choose part number from below and include -D25 or -D27, dependent upon material being machined. For grade recommendations, please see page 32 or call the number at the bottom of the page for assistance.

Inch

Diameter	LOC	OAL	No. of Flutes	Type	Reach	Radius	Part/EDP No.
1/64	3/64	1-1/2	2	BEM	—	—	12179
1/32	1/4	3	4	BEM	—	—	12181
3/64	3/16	1-1/2	4	BEM	—	—	12109
1/16	1/2	3	4	BEM	—	—	12183
1/16	1/4	1-1/2	4	BEM	—	—	12182
5/64	1	3	4	BEM	—	—	12901
3/32	1/2	3	4	BEM	—	—	12185
3/32	1	3	4	BEM	—	—	12902
1/8	1/2	1-1/2	4	BEM	—	—	12021
1/8	1	3	4	BEM	—	—	12049
3/16	5/8	2	4	BEM	—	—	12024
3/16	1	4	4	BEM	—	—	12050
1/4	3/4	2-1/2	4	BEM	—	—	12190
1/4	1-1/2	4	4	BEM	—	—	12191
1/4	2	4	4	BEM	—	—	12905
1/4	1-1/2	6	4	BEM	—	—	12052
5/16	13/16	2-1/2	4	BEM	—	—	12737
5/16	1-1/2	4	4	BEM	—	—	12053
5/16	1-1/2	6	4	BEM	—	—	12371
3/8	1-1/2	6	4	BEM	—	—	12055
3/8	1	2-1/2	4	BEM	—	—	12033
3/8	1-1/2	4	4	BEM	—	—	12054
1/2	1	3	4	BEM	—	—	12036
1/2	2	4	4	BEM	—	—	12195
1/2	3	6	4	BEM	—	—	12038
3/4	1-1/2	4	4	BEM	—	—	12200
1	1-1/2	4	4	BEM	—	—	12201

DIAbide Ball Endmills (BEM) – Metric

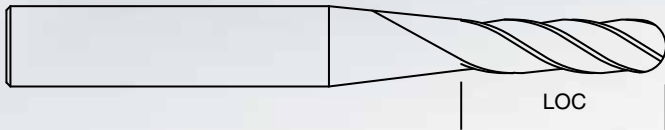

When ordering, choose part number from below and include -D25 or -D27, dependent upon material being machined. For grade recommendations, please see page 32 or call the number at the bottom of the page for assistance.

Metric

Diameter	LOC	OAL	No. of Flutes	Type	Reach	Radius	Part/EDP No.
1mm	4	38	4	BEM	—	—	12117
2mm	10	65	4	BEM	—	—	12075
3mm	15	40	4	BEM	—	—	12076
3mm	25	75	4	BEM	—	—	12077
4mm	15	50	4	BEM	—	—	12078
4mm	25	75	4	BEM	—	—	12079
6mm	20	60	4	BEM	—	—	12080
6mm	40	150	4	BEM	—	—	12082
8mm	20	65	4	BEM	—	—	12083
8mm	40	100	4	BEM	—	—	12084
10mm	26	65	4	BEM	—	—	12085
10mm	40	150	4	BEM	—	—	12087
12mm	30	75	4	BEM	—	—	12088
12mm	50	100	4	BEM	—	—	12089
12mm	75	150	4	BEM	—	—	12090

DIAbide Corner Radius Endmills (CRM)

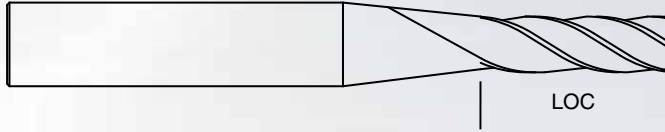

When ordering, choose part number from below and include -D25 or -D27, dependent upon material being machined. For grade recommendations, please see page 32 or call the number at the bottom of the page for assistance.

Inch

Diameter	LOC	OAL	No. of Flutes	Type	Reach	Radius	Part/EDP No.
1/16	1/4	1-1/2	4	CRM	—	.010	12351
1/16	1/4	1-1/2	4	CRM	—	.015	12123
1/8	1/2	1-1/2	4	CRM	—	.015	12095
1/8	1/2	1-1/2	4	CRM	—	.020	12358
1/8	1	3	4	CRM	—	.030	12124
3/16	5/8	2	4	CRM	—	.020	12362
3/16	5/8	2	4	CRM	—	.030	12363
1/4	3/4	2-1/2	4	CRM	—	.020	12365
1/4	3/4	2-1/2	4	CRM	—	.030	12125
1/4	1-1/2	4	4	CRM	—	.030	12099
3/8	1	2-1/2	4	CRM	—	.020	12372
3/8	1	2-1/2	4	CRM	—	.030	12373
1/2	1	3	4	CRM	—	.030	12375
1/2	1	3	4	CRM	—	.062	12376
1/2	1-1/2	4	4	CRM	—	.030	12379
1/2	3	6	4	CRM	—	.030	12101

Metric

Diameter	LOC	OAL	No. of Flutes	Type	Reach	Radius	Part/EDP No.
1mm	3	75	4	CRM	—	.2mm	12738
2mm	3	75	4	CRM	—	.2mm	12739
3mm	3	75	4	CRM	—	.2mm	12740
4mm	4	75	4	CRM	—	.5mm	12741
6mm	6	100	4	CRM	—	.5mm	12742
8mm	8	100	4	CRM	—	.5mm	12743
10mm	10	100	4	CRM	—	.5mm	12744
12mm	12	100	4	CRM	—	.5mm	12745

DIAbide Ultra Premium Endmills



MADE TO ORDER

Diabide Ultra Premium Endmills are available only as grade D25. When ordering, choose Part/EDP number from below and include D25. Diabide Ultra Premium Endmills are manufactured to a diameter tolerance of +0.000/-0.0005. All other tolerances are the same as our standard grade D25 endmills as called out on page 46.

Inch

Diameter	LOC	OAL	No. of Flutes	Type	Reach	Radius	Part/EDP No.
1/16	1/4	1-1/2	4	CRM	—	.010	12409
5/64	1/4	1-1/2	4	BEM	—	—	12417
3/32	3/8	1-1/2	4	CRM	—	.010	12410
3/32	3/8	2	4	CRP	15/16	.010	12448
1/8	1/2	1-1/2	4	SEM	—	—	12404
1/8	1/2	1-1/2	4	CRM	—	.015	12425
1/8	1/2	1-1/2	4	BEM	—	—	12418
1/8	3/4	3	4	SEP	1-1/2	—	12400
1/8	3/4	3	4	CRP	1-1/2	.015	12402
1/8	3/4	3	4	SEP	1-1/2	—	12403
1/8	1	3	4	SEM	—	—	12405
1/8	1	3	4	CRM	—	.015	12411
1/8	1	3	4	BEM	—	—	12419
1/4	3/4	2-1/2	4	SEM	—	—	12406
1/4	3/4	2-1/2	4	BEM	—	—	12420
1/4	3/4	2-1/2	4	CRM	—	.015	12449
1/4	1	4	4	SEP	2-1/2	—	12401
1/4	1-1/2	4	4	CRM	—	.015	12412
3/8	7/8	2-1/2	4	CRM	—	.020	12414
3/8	7/8	2-1/2	4	SEM	—	—	12407
3/8	7/8	2-1/2	4	BEM	—	—	12421
3/8	7/8	2-1/2	4	CRM	—	.015	12426
3/8	1-1/2	4	4	CRM	—	.020	12415
3/8	1-1/2	4	4	BEM	—	—	12422
1/2	1	3	4	SEM	—	—	12408
1/2	1	3	4	CRM	—	.030	12416
1/2	1	3	4	BEM	—	—	12423

DIAbide Jobber Drills U.S. Fractional and Wire Sizes

ANSI/ISO Style Shanks

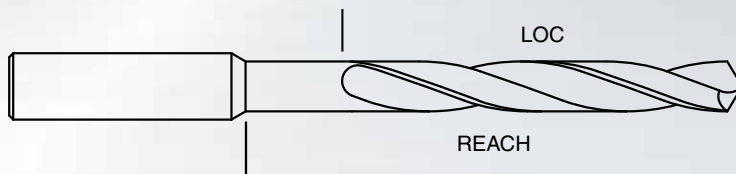

Decatur Diamond offers a full selection of drill sizes from .028"-.75" that includes letter, number, and fractional drill sizes; metric sizes are also available from 1mm-12.5mm. **Decatur Diamond** drills are industry standard 2 flute spiral jobber drills with a 118 degree four facet point. All drills over .042 diameter are furnished with back taper for clearance. When ordering, include -D25 or -D27, depending upon material being machined.

Inch

Size	Dec. Equiv.	LOC	OAL	Shank Size	Shank Length	Reach Length	Part Number
#70	0.0280	5/16	2	1/8	1-7/16	9/16	0.0280 DRILL
#69	0.0292	5/16	2	1/8	1-7/16	9/16	0.0292 DRILL
#68	0.0310	5/16	2	1/8	1-7/16	9/16	0.0310 DRILL
1/32	0.0312	5/16	2	1/8	1-7/16	9/16	0.0312 DRILL
#67	0.0320	5/16	2	1/8	1-7/16	9/16	0.0320 DRILL
#66	0.0330	5/16	2	1/8	1-7/16	9/16	0.0330 DRILL
#65	0.0350	5/8	2	1/8	1-1/8	7/8	0.0350 DRILL
#64	0.0366	5/8	2	1/8	1-1/8	7/8	0.0366 DRILL
#63	0.0370	5/8	2	1/8	1-1/8	7/8	0.0370 DRILL
#62	0.0380	5/8	2	1/8	1-1/8	7/8	0.0380 DRILL
#61	0.0390	5/8	2	1/8	1-1/8	7/8	0.0390 DRILL
#60	0.0400	3/4	2-1/2	1/8	1-1/2	1	0.0400 DRILL
#59	0.0410	3/4	2-1/2	1/8	1 1/2	1	0.0410 DRILL
#58	0.0420	3/4	2-1/2	1/8	1-1/2	1	0.0420 DRILL
#57	0.0430	3/4	2-1/2	1/8	1-1/2	1	0.0430 DRILL
#56	0.0465	3/4	2-1/2	1/8	1-1/2	1	0.0465 DRILL
3/64	0.0469	3/4	2-1/2	1/8	1-1/2	1	0.0469 DRILL
#55	0.0520	3/4	2-1/2	1/8	1-1/2	1	0.0520 DRILL
#54	0.0550	3/4	2-1/2	1/8	1-1/2	1	0.0550 DRILL
#53	0.0595	3/4	2-1/2	1/8	1-1/2	1	0.0595 DRILL
1/16	0.0625	3/4	2-1/2	1/8	1-1/2	1	0.0625 DRILL
#52	0.0635	3/4	2-1/2	1/8	1-1/2	1	0.0635 DRILL
#51	0.0670	3/4	2-1/2	1/8	1-1/2	1	0.0670 DRILL
#50	0.0700	7/8	2-1/2	1/8	1-3/8	1-1/8	0.0700 DRILL
#49	0.0730	7/8	2-1/2	1/8	1-3/8	1-1/8	0.0730 DRILL
#48	0.0760	7/8	2-1/2	1/8	1-3/8	1-1/8	0.0760 DRILL
5/64	0.0781	7/8	2-1/2	1/8	1-3/8	1-1/8	0.0781 DRILL
#47	0.0785	7/8	2-1/2	1/8	1-3/8	1-1/8	0.0785 DRILL
#46	0.0810	7/8	2-1/2	1/8	1-3/8	1-1/8	0.0810 DRILL
#45	0.0820	7/8	2-1/2	1/8	1-3/8	1-1/8	0.0820 DRILL
#44	0.0860	1	2-1/2	1/8	1-1/4	1-1/4	0.0860 DRILL
#43	0.0890	1	2-1/2	1/8	1-1/4	1-1/4	0.0890 DRILL
#42	0.0935	1	2-1/2	1/8	1-1/4	1-1/4	0.0935 DRILL
3/32	0.0938	1	2-1/2	1/8	1-1/4	1-1/4	0.0938 DRILL
#41	0.0960	1	2-1/2	1/8	1-1/4	1-1/4	0.0960 DRILL
#40	0.0980	1	2 1/2	1/8	1 1/4	1 1/4	0.0980 DRILL
#39	0.0995	1 1/4	3	1/8	1 1/2	1 1/2	0.0995 DRILL
#38	0.1015	1 1/4	3	1/8	1 1/2	1 1/2	0.1015 DRILL
#37	0.1040	1 1/4	3	1/8	1 1/2	1 1/2	0.1040 DRILL
#36	0.1065	1 1/4	3	1/8	1 1/2	1 1/2	0.1065 DRILL

Size	Dec. Equiv.	LOC	OAL	Shank Size	Shank Length	Reach Length	Part Number
7/64	0.1094	1-1/4	3	1/8	1-1/2	1-1/2	0.1094 DRILL
#35	0.1100	1-1/4	3	1/8	1-1/2	1-1/2	0.1100 DRILL
#34	0.1110	1-1/4	3	1/8	1-1/2	1-1/2	0.1110 DRILL
#33	0.1130	1-1/4	3	1/8	1-1/2	1-1/2	0.1130 DRILL
#32	0.1160	1-1/4	3	1/8	1-1/2	1-1/2	0.1160 DRILL
#31	0.1200	1-1/4	3	1/8	1-1/2	1-1/2	0.1200 DRILL
1/8	0.1250	1-1/4	3	1/8	1-1/2	1-1/2	0.1250 DRILL
#30	0.1285	1-3/8	3	3/16	1-3/8	1-5/8	0.1285 DRILL
#29	0.1360	1-3/8	3	3/16	1-3/8	1-5/8	0.1360 DRILL
#28	0.1405	1-3/8	3	3/16	1-3/8	1-5/8	0.1405 DRILL
9/64	0.1406	1-3/8	3	3/16	1-3/8	1-5/8	0.1406 DRILL
#27	0.1440	1-3/8	3	3/16	1-3/8	1-5/8	0.1440 DRILL
#26	0.1470	1-3/8	3	3/16	1-3/8	1-5/8	0.1470 DRILL
#25	0.1495	1-3/8	3	3/16	1-3/8	1-5/8	0.1495 DRILL
#24	0.1520	1-3/8	3	3/16	1-3/8	1-5/8	0.1520 DRILL
#23	0.1540	1-3/8	3	3/16	1-3/8	1-5/8	0.1540 DRILL
5/32	0.1562	1-3/8	3	3/16	1-3/8	1-5/8	0.1562 DRILL
#22	0.1570	1-3/8	3	3/16	1-3/8	1-5/8	0.1570 DRILL
#21	0.1590	1-3/8	3	3/16	1-3/8	1-5/8	0.1590 DRILL
#20	0.0161	1-3/8	3	3/16	1-3/8	1-5/8	0.1610 DRILL
#19	0.1660	1-5/8	3	3/16	1-1/8	1-7/8	0.1660 DRILL
#18	0.1695	1-5/8	3	3/16	1-1/8	1-7/8	0.1695 DRILL
11/64	0.1719	1-5/8	3	3/16	1-1/8	1-7/8	0.1719 DRILL
#17	0.1730	1-5/8	3	3/16	1-1/8	1-7/8	0.1730 DRILL
#16	0.1770	1-5/8	3	3/16	1-1/8	1-7/8	0.1770 DRILL
#15	0.1800	1-5/8	3	3/16	1-1/8	1-7/8	0.1800 DRILL
#14	0.1820	1-5/8	3	3/16	1-1/8	1-7/8	0.1820 DRILL
#13	0.1850	1-5/8	3	3/16	1-1/8	1-7/8	0.1850 DRILL
3/16	0.1875	1-5/8	3	3/16	1-1/8	1-7/8	0.1875 DRILL
#12	0.1890	1-5/8	3	1/4	1-1/8	1-7/8	0.1890 DRILL
#11	0.1910	1-5/8	3	1/4	1 1/8	1 7/8	0.1910 DRILL
#10	0.1935	1-5/8	3	1/4	1 1/8	1 7/8	0.1935 DRILL
#9	0.1960	1-3/4	3 1/2	1/4	1 1/2	2	0.1960 DRILL
#8	0.1990	1-3/4	3 1/2	1/4	1 1/2	2	0.1990 DRILL
#7	0.2010	1-3/4	3 1/2	1/4	1 1/2	2	0.2010 DRILL
13/64	0.2031	1-3/4	3-1/2	1/4	1 1/2	2	0.2031 DRILL
#6	0.2040	1-3/4	3-1/2	1/4	1 1/2	2	0.2040 DRILL
#5	0.2055	1-3/4	3-1/2	1/4	1 1/2	2	0.2055 DRILL
#4	0.2090	1-3/4	3-1/2	1/4	1-1/2	2	0.2090 DRILL
#3	0.2130	1-3/4	3-1/2	1/4	1-1/2	2	0.2130 DRILL

DIAbide Jobber Drills U.S. Fractional and Wire Sizes

ANSI/ISO Style Shanks

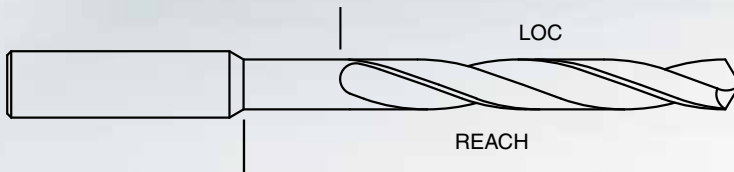

Decatur Diamond offers a full selection of drill sizes from .028"-.75" that includes letter, number, and fractional drill sizes; metric sizes are also available from 1mm-12.5mm. **Decatur Diamond** drills are industry standard 2 flute spiral jobber drills with a 118 degree four facet point. All drills over .042 diameter are furnished with back taper for clearance. When ordering, include -D25 or -D27, depending upon material being machined

Inch continued

Size	Dec. Equiv.	LOC	OAL	Shank Size	Shank Length	Reach Length	Part Number
7/32	0.2188	1-3/4	3-1/2	1/4	1-1/2	2	0.2188 DRILL
#2	0.2210	1-3/4	3-1/2	1/4	1-1/2	2	0.2210 DRILL
#1	0.2280	1-3/4	3-1/2	1/4	1-1/2	2	0.2280 DRILL
A	0.2340	2	3-1/2	1/4	1-1/4	2-1/4	0.2340 DRILL
15/64	0.2344	2	3-1/2	1/4	1-1/4	2-1/4	0.2344 DRILL
B	0.2380	2	3-1/2	1/4	1-1/4	2-1/4	0.2380 DRILL
C	0.2420	2	3-1/2	1/4	1-1/4	2-1/4	0.2420 DRILL
D	0.2460	2	3-1/2	1/4	1-1/4	2-1/4	0.2460 DRILL
1/4	0.2500	2	3-1/2	1/4	1-1/4	2-1/4	0.2500 DRILL
F	0.2570	2	3-1/2	5/16	1-1/4	2-1/4	0.2570 DRILL
G	0.2610	2-1/8	3-1/2	5/16	1-1/8	2-3/8	0.2610 DRILL
17/64	0.2656	2-1/8	3-1/2	5/16	1-1/8	2-3/8	0.2656 DRILL
H	0.2660	2-1/8	3-1/2	5/16	1-1/8	2-3/8	0.2660 DRILL
I	0.2720	2-1/8	3-1/2	5/16	1-1/8	2-3/8	0.2720 DRILL
J	0.2770	2-1/8	3-1/2	5/16	1-1/8	2-3/8	0.2770 DRILL
K	0.2810	2-1/8	3-1/2	5/16	1-1/8	2-3/8	0.2810 DRILL
9/32	0.2812	2-1/8	3-1/2	5/16	1-1/8	2-3/8	0.2812 DRILL
L	0.2900	2-1/8	3-1/2	5/16	1-1/8	2-3/8	0.2900 DRILL
M	0.2950	2-3/8	4	5/16	1-3/8	2-5/8	0.2950 DRILL
19/64	0.2969	2-3/8	4	5/16	1-3/8	2-5/8	0.2969 DRILL
N	0.3020	2-3/8	4	5/16	1-3/8	2-5/8	0.3020 DRILL
5/16	0.3125	2-3/8	4	5/16	1-3/8	2-5/8	0.3125 DRILL
O	0.3160	2-3/8	4	3/8	1-3/8	2-5/8	0.3160 DRILL
P	0.3230	2-3/8	4	3/8	1-3/8	2-5/8	0.3230 DRILL
21/64	0.3281	2-1/2	4	3/8	1-1/4	2-3/4	0.3281 DRILL
Q	0.3320	2-1/2	4	3/8	1-1/4	2-3/4	0.3320 DRILL
R	0.3390	2-1/2	4	3/8	1-1/4	2-3/4	0.3390 DRILL
11/32	0.3438	2-1/2	4	3/8	1-1/4	2-3/4	0.3438 DRILL
S	0.3480	2-1/2	4	3/8	1-1/4	2-3/4	0.3480 DRILL
T	0.3580	2-3/4	4-1/2	3/8	1-1/2	3	0.3580 DRILL
23/64	0.3594	2-3/4	4-1/2	3/8	1-1/2	3	0.3594 DRILL
U	0.3680	2-3/4	4-1/2	3/8	1-1/2	3	0.3680 DRILL
3/8	0.3750	2-3/4	4-1/2	3/8	1-1/2	3	0.3750 DRILL
V	0.3770	2-3/4	4-1/2	7/16	1-1/2	3	0.3770 DRILL
W	0.3860	2 7/8	4 1/2	7/16	1 3/8	3 1/8	0.3860 DRILL
25/64	0.3906	2 7/8	4 1/2	7/16	1 3/8	3 1/8	0.3906 DRILL
X	0.3970	2 7/8	4 1/2	7/16	1 3/8	3 1/8	0.3970 DRILL
Y	0.4040	2 7/8	4 1/2	7/16	1 3/8	3 1/8	0.4040 DRILL
13/32	0.4062	2-7/8	4-1/2	7/16	1-3/8	3-1/8	0.4062 DRILL
Z	0.4130	2-7/8	4-1/2	7/16	1-3/8	3-1/8	0.4130 DRILL

Size	Dec. Equiv.	LOC	OAL	Shank Size	Shank Length	Reach Length	Part Number
27/64	0.4219	2-7/8	4-1/2	7/16	1-3/8	3-1/8	0.4219 DRILL
7/16	0.4375	2-7/8	4-1/2	7/16	1-3/8	3-1/8	0.4375 DRILL
29/64	0.4531	3	5	1/2	1-3/4	3-1/4	0.4531 DRILL
15/32	0.4688	3	5	1/2	1-3/4	3-1/4	0.4688 DRILL
31/64	0.4844	3	5	1/2	1-3/4	3-1/4	0.4844 DRILL
1/2	0.5000	3	5	1/2	1-3/4	3-1/4	0.5000 DRILL
5/8	0.6250	4	6	5/8	1-1/2	4-1/4	0.6250 DRILL
3/4	0.7500	4	6	3/4	1-1/2	4-1/4	0.7500 DRILL

Metric

Size (mm)	Dec. Equiv.	LOC	OAL	Shank Size	Shank Length	Reach Length	Part Number
1.00	0.0393	16	60	3mm	38	22	0.0393 DRILL
1.50	0.0591	19	60	3mm	35	25	0.0591 DRILL
2.00	0.0787	22	60	3mm	32	28	0.0787 DRILL
2.50	0.0984	26	65	3mm	33	32	0.0984 DRILL
3.00	0.1181	32	75	3mm	37	38	0.1181 DRILL
3.25	0.1279	35	75	4mm	34	41	0.1279 DRILL
3.50	0.1378	35	75	4mm	34	41	0.1378 DRILL
4.00	0.1575	35	75	4mm	34	41	0.1575 DRILL
4.50	0.1772	41	100	6mm	53	47	0.1772 DRILL
5.00	0.1969	45	100	6mm	49	51	0.1969 DRILL
5.50	0.2165	45	100	6mm	49	51	0.2165 DRILL
6.00	0.2362	51	100	6mm	43	57	0.2362 DRILL
6.50	0.2559	51	100	8mm	43	57	0.2559 DRILL
7.00	0.2756	54	100	8mm	40	60	0.2756 DRILL
7.50	0.2953	61	100	8mm	33	67	0.2953 DRILL
8.00	0.3150	61	100	8mm	33	67	0.3150 DRILL
8.50	0.3346	61	100	10mm	33	67	0.3346 DRILL
9.00	0.3543	70	125	10mm	49	76	0.3543 DRILL
9.50	0.3740	70	125	10mm	49	76	0.3740 DRILL
10.00	0.3937	73	150	10mm	71	79	0.3937 DRILL
10.50	0.4134	73	150	12mm	71	79	0.4134 DRILL
11.00	0.4331	73	150	12mm	71	79	0.4331 DRILL
11.50	0.4528	76	150	12mm	68	82	0.4528 DRILL
12.00	0.4724	76	150	12mm	68	82	0.4724 DRILL
12.50	0.4921	76	150	14mm	68	82	0.4921 DRILL

DIAbide Standard ANSI/ISO Inserts

Decatur Diamond offers a selection of standard ANSI/ISO DIAbide coated inserts as listed below. DIAbide inserts are either purchased from traditional insert manufacturers or ground from **Decatur Diamond** specified carbide grades. The industry standard ANSI/ISO tolerance protocols are followed and insert size and tolerance are established before coating is applied. **Decatur Diamond** standard grade for inserts is D38. For information on special grades for your specific application, please call the number at the bottom of the page to speak with the product manager.

ANSI ID	ISO ID	I.C.	Part/EDP No.
CCMT-21.51	CCMT-060204	1/4	16107-D38
CCMT-21.52	CCMT-060208	1/4	16108-D38
CCMT-32.51	CCMT-09T304	3/8	16109-D38
CCMT-32.52	CCMT-09T308	3/8	16110-D38
CNMP-431	CNMP-120404	1/2	16118-D38
CNMP-432	CNMP-120408	1/2	16119-D38
DCMT-21.52	DCMT-070208	1/4	16155-D38
DCMT-32.51	DCMT-11T304	3/8	16156-D38
DCMT-32.52	DCMT-11T308	3/8	16157-D38
DNMP-431	DNMP-150404	1/2	16159-D38
DNMP-432	DNMP-150408	1/2	16160-D38
TCMT-21.51	TCMT-110204	1/4	16274-D38
TCMT-21.52	TCMT-110208	1/4	16275-D38
TCMT-32.51	TCMT-16T304	3/8	16276-D38
TCMT-32.52	TCMT-16T308	3/8	16277-D38
TPG-221	TPG-110304	1/4	16324-D38
TPG-222	TPG-110308	1/4	16326-D38
TPG-321	TPG-160304	3/8	16327-D38
TPG-322	TPG-160308	3/8	16328-D38
TPG-431	TPG-220404	1/2	16331-D38
TPG-432	TPG-220408	1/2	16332-D38
TPGH-221	TPGH-110304	1/4	16336-D38
TPGH-321	TPGH-160304	3/8	16337-D38
TPGH-322	TPGH-160308	3/8	16338-D38
VBMT-331	VBMT-160404	3/8	16366-D38
VBMT-332	VBMT-160408	3/8	16367-D38
VBMW-331	VBMW-160404	3/8	16368-D38
VNMP-331	VNMP-160404	3/8	16381-D38
VNMP-332	VNMP-160408	3/8	16382-D38



Note:

Decatur Diamond will quote other ANSI/ISO standard and special insert geometries upon request. Please contact **Decatur Diamond** with your inquiry at the number at the bottom of the page.



DIAbide Tool Tolerance Specifications

DIAbide **Endmill Tolerances**

All standard grade D25 endmills are produced to +0.000/-0.001 on diameter, -0.0001/-0.0003 on the shank, 0.001 runout, +0.060/-0.000 on flute length and +/-0.060 on OAL.

All standard grade D27 endmills are produced to +0.001/-0.001 on diameter, -0.0000/-0.0003 on the shank, 0.002 runout, +0.060/-0.000 on flute length and +/-0.060 on OAL.

DIAbide **Ultra Premium Endmill Tolerances**

All Ultra Premium grade D25 endmills are produced to +0.000/-0.0005 on diameter, -0.0001/-0.0003 on the shank, 0.001 runout, +0.060/-0.000 on flute length and +/-0.060 on OAL.

DIAbide **Drill Tolerances**

All standard grade D25 drills are produced to +0.001/-0.000 on diameter, +0.060/-0.000 on flute length and +/-0.060 on OAL.

All standard grade D27 drills are produced to +0.0025/-0.000 on diameter, +0.060/-0.000 on flute length and +/-0.060 on OAL.

Decatur Diamond drills are industry standard 2 flute spiral jobber drills with a 118 degree four facet point. All drills over .042 diameter are furnished with back taper for clearance.

DIAbide **Insert Tolerances**

DIAbide inserts are either purchased from traditional insert manufacturers or ground to **Decatur Diamond** specifications. The industry standard ISO and ANSI tolerance protocols are followed and insert size and tolerance are established before coating is applied. The thickness of the diamond coating will affect the insert size. Please contact **Decatur Diamond** for further information.

DIAbide Cutting Data: Milling Parameters

Endmill Diameter	Starting Parameters – Graphite, Hard Carbon			
	RPM n	Cutting Speed Vc	Operation	Feed Rate per Tooth fz
1/64	20,000 - 40,000	80 - 160	Finish	0.0002 - 0.0005
1/32	18,000 - 40,000	150 - 325	Finish	0.0005 - 0.001
1/16	12,000 - 40,000	200 - 650	General	0.001 - 0.002
			Finish	0.0005 - 0.001
1/8	6,000 - 40,000	200 - 1,300	General	0.001 - 0.002
			Finish	0.0005 - 0.001
3/16	4,000 - 40,000	200 - 1,950	General	0.001 - 0.002
			Finish	0.0005 - 0.001
1/4	3,000 - 36,700	200 - 2,450	General	0.002 - 0.004
			Finish	0.001 - 0.002
5/16	2,500 - 31,800	200 - 2,600	General	0.002 - 0.004
			Finish	0.001 - 0.002
3/8	2,000 - 28,500	200 - 2,800	General	0.003 - 0.005
			Finish	0.001 - 0.003
1/2	1,500 - 23,000	200 - 3,000	General	0.003 - 0.005
			Finish	0.001 - 0.003

Endmill Diameter	Starting Parameters – Glass Fiber Filled Plastics			
	RPM n	Cutting Speed Vc	Operation	Feed Rate per Tooth fz
1/64	—	—	—	—
1/32	—	—	—	—
1/16	3,700 - 7,300	60 - 120	General	0.001 - 0.002
	5,200 - 10,400	85 - 170	Finish	0.0005 - 0.001
1/8	3,600 - 7,300	120 - 240	General	0.0005 - 0.001
	5,200 - 9,200	170 - 300	Finish	0.00025 - .0005
3/16	4,100 - 7,100	200 - 350	General	0.001 - 0.002
	6,100 - 10,200	300 - 500	Finish	0.0005 - 0.001
1/4	4,600 - 6,900	300 - 450	General	0.001 - 0.002
	5,300 - 8,400	350 - 550	Finish	0.0005 - 0.001
5/16	4,300 - 6,100	350 - 500	General	0.001 - 0.002
	4,300 - 7,300	350 - 600	Finish	0.0005 - 0.001
3/8	4,100 - 5,600	400 - 550	General	0.002 - 0.004
	3,500 - 6,600	350 - 650	Finish	0.001 - 0.002
1/2	3,400 - 4,600	450 - 600	General	0.002 - 0.004
	2,600 - 5,700	350 - 750	Finish	0.001 - 0.002

Endmill Diameter	Starting Parameters – Green Ceramics, Green Carbide, Powder Filled and Thermoset Plastics			
	RPM n	Cutting Speed Vc	Operation	Feed Rate per Tooth fz
1/64	6,100 - 20,000	25 - 80	Finish	0.0002 - 0.0005
1/32	6,100 - 20,000	50 - 160	Finish	0.0005 - 0.001
1/16	6,100 - 20,000	100 - 325	General	0.001 - 0.002
			Finish	0.0005 - 0.001
1/8	4,600 - 16,000	150 - 500	General	0.001 - 0.002
			Finish	0.0005 - 0.001
3/16	4,100 - 15,000	200 - 750	General	0.001 - 0.002
			Finish	0.0005 - 0.001
1/4	3,050 - 12,000	200 - 750	General	0.002 - 0.004
			Finish	0.001 - 0.002
5/16	2,400 - 11,000	200 - 900	General	0.002 - 0.004
			Finish	0.001 - 0.002
3/8	2,000 - 11,200	200 - 1,00	General	0.003 - 0.005
			Finish	0.001 - 0.003
1/2	1,500 - 10,000	200 - 1,300	General	0.003 - 0.005
			Finish	0.001 - 0.003

Machining Graphite:

DIAbide diamond tools are a perfect match for machining graphite moldforms for EDM. The abrasive nature of EDM graphite grades severely limit the life of carbide tools, and PCD diamond tools are not available in the configurations required for detailed moldmaking. Tools with diamond on the surface wear longer and have a lower coefficient of friction. These characteristics provide substantial benefit to the machining operation.

Because diamond tools last much longer – 15 to 50x the life of carbide – they:

- Easily pay for themselves
- Greatly reduce the number of tool changes, increasing productivity
- Allow for longer periods of unattended machining
- Improve the dimensional consistency of the machined parts
- Eliminate changing tools mid-cut

DIAbide

Cutting Data: Turning and Drilling

Turning Data

Unfilled Plastics

Application	Cutting Speed Vc	Feed Rate per Rev, f
Rough	2000 - 3000	0.010 - 0.020
Finish	—	—

Graphite/Carbon

Application	Cutting Speed Vc	Feed Rate per Rev, f
Rough	—	—
Finish	3000 - 4000	0.003 - 0.010

Green-Ceramic/Carbide

Application	Cutting Speed Vc	Feed Rate per Rev, f
Rough	100 - 500	0.002 - 0.010
Finish	100 - 500	0.002 - 0.010

Reinforced Plastics

Application	Cutting Speed Vc	Feed Rate per Rev, f
Rough	500 - 1000	0.008 - 0.020
Finish	—	—

Composite Material

Application	Cutting Speed Vc	Feed Rate per Rev, f
Rough	—	—
Finish	1000 - 1500	0.003 - 0.010

Drilling Data

Drill Diameter	Graphite Hard Carbon	Green Ceramic, Green Carbide, Powder Filled Plastics	Unfilled Plastics	Glass Fiber Reinforced Plastics
	Cutting Speed, Vc	Cutting Speed, Vc	Cutting Speed, Vc	Cutting Speed, Vc
	Feed Rate per Rev, f	Feed Rate per Rev, f	Feed Rate per Rev, f	Feed Rate per Rev, f
500 - 2500	200 - 1000	200 - 700	200 - 500	
1/32 - 1/16	0.00025 - 0.001	0.0002 - 0.00075	0.00025 - 0.001	0.00025 - 0.001
1/16 - 1/8	0.0005 - 0.002	0.0005 - 0.002	0.0005 - 0.002	0.0005 - 0.002
1/8 - 3/16	0.001 - 0.004	0.001 - 0.003	0.001 - 0.004	0.001 - 0.004
3/16 - 1/4	0.002 - 0.005	0.002 - 0.004	0.002 - 0.005	0.002 - 0.005
1/4 - 5/16	0.002 - 0.006	0.002 - 0.005	0.002 - 0.006	0.002 - 0.006
5/16 - 3/8	0.002 - 0.008	0.002 - 0.006	0.002 - 0.008	0.002 - 0.008
3/8 - 1/2	0.002 - 0.010	0.002 - 0.008	0.002 - 0.010	0.002 - 0.010

DIAbide Square/Corner Radius Endmill Quote Request Form

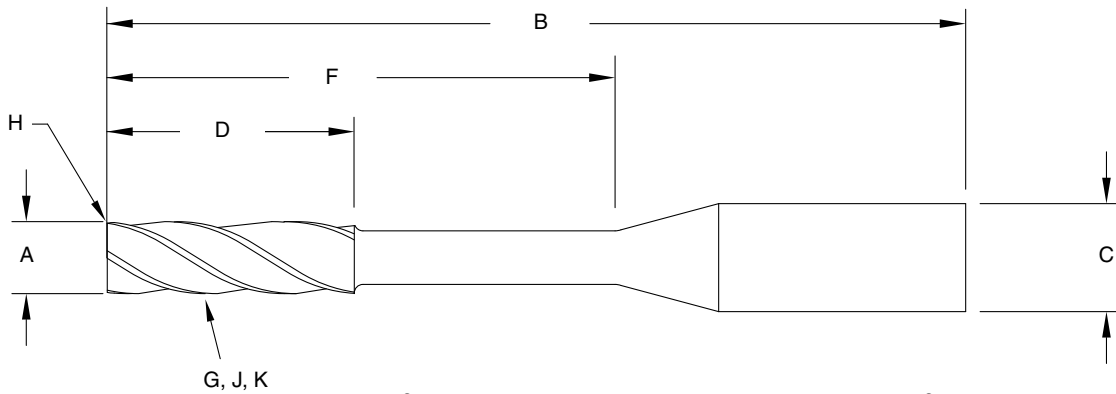

Check one:
 "P": Profiling
 "M": Standard

A: Cutter Diameter _____
 B: Overall Length _____
 C: Shank Diameter _____
 D: Length of Cut _____
 F: Length of Reach _____
 G: Number of Flutes _____

H: Corner Radius _____
 I: Material Being Cut _____
 J: Spiral (RH/LH/STR) _____
 K: Helix Angle _____
 L: Coating _____

Reference Quote # _____
 Sales Person: _____
 Date Entered _____ Date Required: _____

Customer Data

Distributor: _____
 Contact Person: _____
 Phone Number: _____
 Address: _____

End User: _____
 Contact Person: _____
 Phone Number: _____
 Address: _____

Current Process Conditions

Slot Milling: Side Milling: Cavity Milling: Other: _____
 Material to Cut: _____ Spindle RPM: _____ Feed Rate RPM: _____ DOC: _____
 Current Tool: Carbide: PCD: Other: _____
 Surface Finish Required: _____ Coolant: _____ Thru Spindle: Shower Screw: Flood:
 Common Failure Mode: Finish: Wear: Chipping: Burr: Other: _____
 Desired Improvement Over Current Tool: Life: Cost: Finish: Other: _____

DIAbide Ball Endmill Quote Request Form

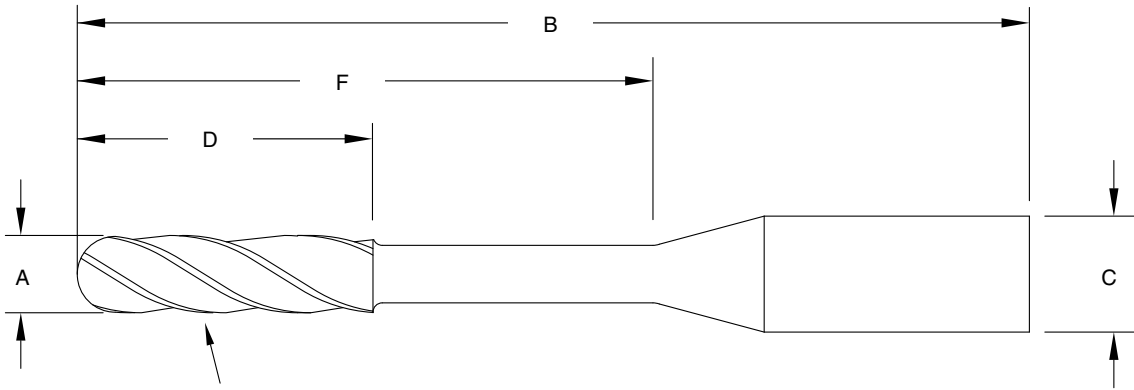

Check one:
 "P": Profiling
 "M": Standard

A: Cutter Diameter _____
 B: Overall Length _____
 C: Shank Diameter _____
 D: Length of Cut _____
 F: Length of Reach _____
 G: Number of Flutes _____

H: Corner Radius _____
 I: Material Being Cut _____
 J: Spiral (RH/LH/STR) _____
 K: Helix Angle _____
 L: Coating _____

Reference Quote # _____
 Sales Person: _____
 Date Entered _____ Date Required: _____

Customer Data

Distributor: _____
 Contact Person: _____
 Phone Number: _____
 Address: _____

End User: _____
 Contact Person: _____
 Phone Number: _____
 Address: _____

Current Process Conditions

Slot Milling: Side Milling: Cavity Milling: Other: _____
 Material to Cut: _____ Spindle RPM: _____ Feed Rate RPM: _____ DOC: _____
 Current Tool: Carbide: PCD: Other: _____
 Surface Finish Required: _____ Coolant: _____ Thru Spindle: Shower Screw: Flood:
 Common Failure Mode: Finish: Wear: Chipping: Burr: Other: _____
 Desired Improvement Over Current Tool: Life: Cost: Finish: Other: _____

DIAbide Drill Quote Request Form

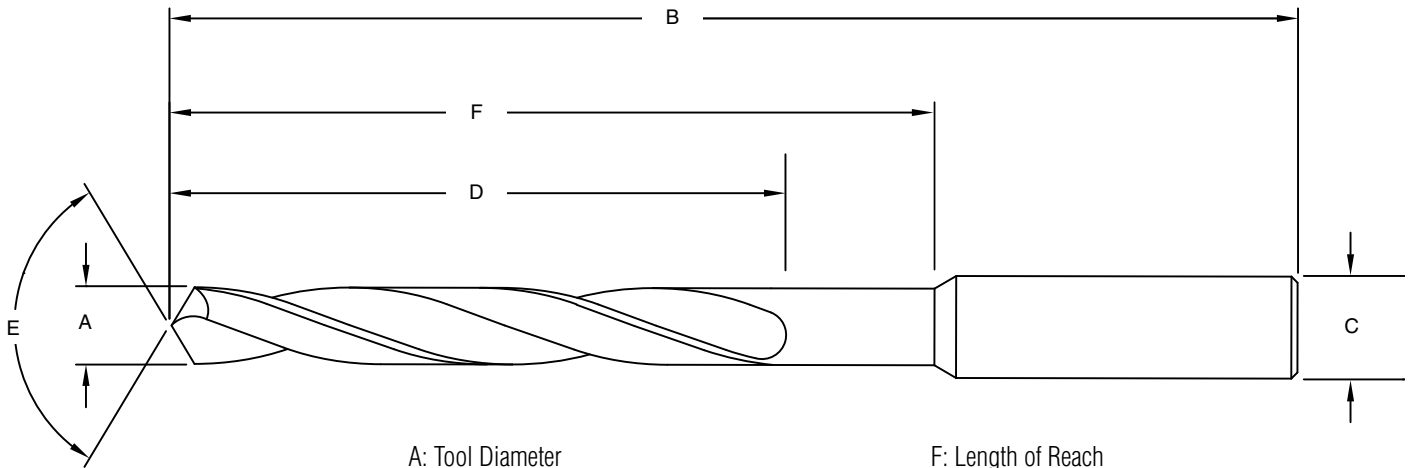

- A: Tool Diameter _____
- B: Overall Length _____
- C: Shank Diameter _____
- D: Length of Cut _____
- E: Point Angle _____
- F: Length of Reach _____
- G: Number of Flutes _____
- I: Material Being Cut _____
- J: Spiral (RH/LH/STR) _____
- K: Helix Angle _____
- L: Coating _____

Reference Quote # _____
 Sales Person: _____
 Date Entered _____ Date Required: _____

Customer Data

Distributor: _____
 Contact Person: _____
 Phone Number: _____
 Address: _____

End User: _____
 Contact Person: _____
 Phone Number: _____
 Address: _____

Current Process Conditions

Blind Hole: Through Hole: From Solid: From Cored: Other: _____
 Material to Cut: _____ Spindle RPM: _____ Feed Rate RPM: _____ DOC: _____
 Current Tool: Carbide: PCD: Other: _____
 Surface Finish Required: _____ Coolant: _____ Thru Spindle: Shower Screw: Flood:
 Common Failure Mode: Finish: Wear: Chipping: Burr: Other: _____
 Desired Improvement Over Current Tool: Life: Cost: Finish: Other: _____

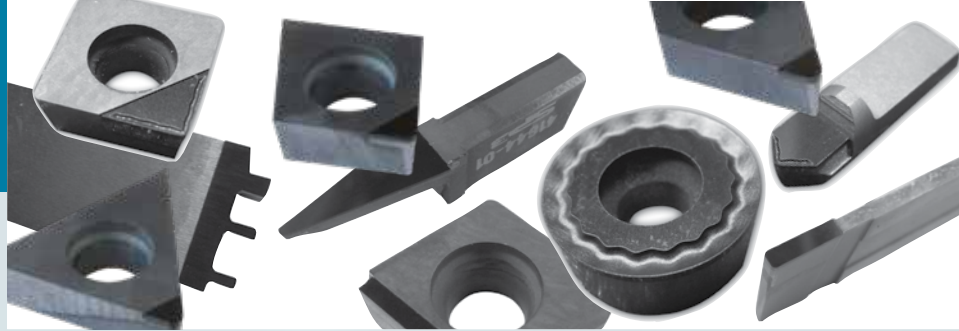

PCD Inserts Index

PCD Tipped ANSI/ISO Screwdown Inserts	
5° Positive Rake.....	54
Neutral Rake.....	55

Decatur Diamond also offers a PCD tipped line of common ANSI/ISO inserts for your turning and boring needs. The following pages list our quick delivery offering and we can also create PCD tipped inserts in other geometries not found in the catalog. Below are some photos of special inserts we have created for customers upon request over the years. You no longer need a separate supplier for your milling and turning needs. Give us a call and let us help improve any of your machining applications.

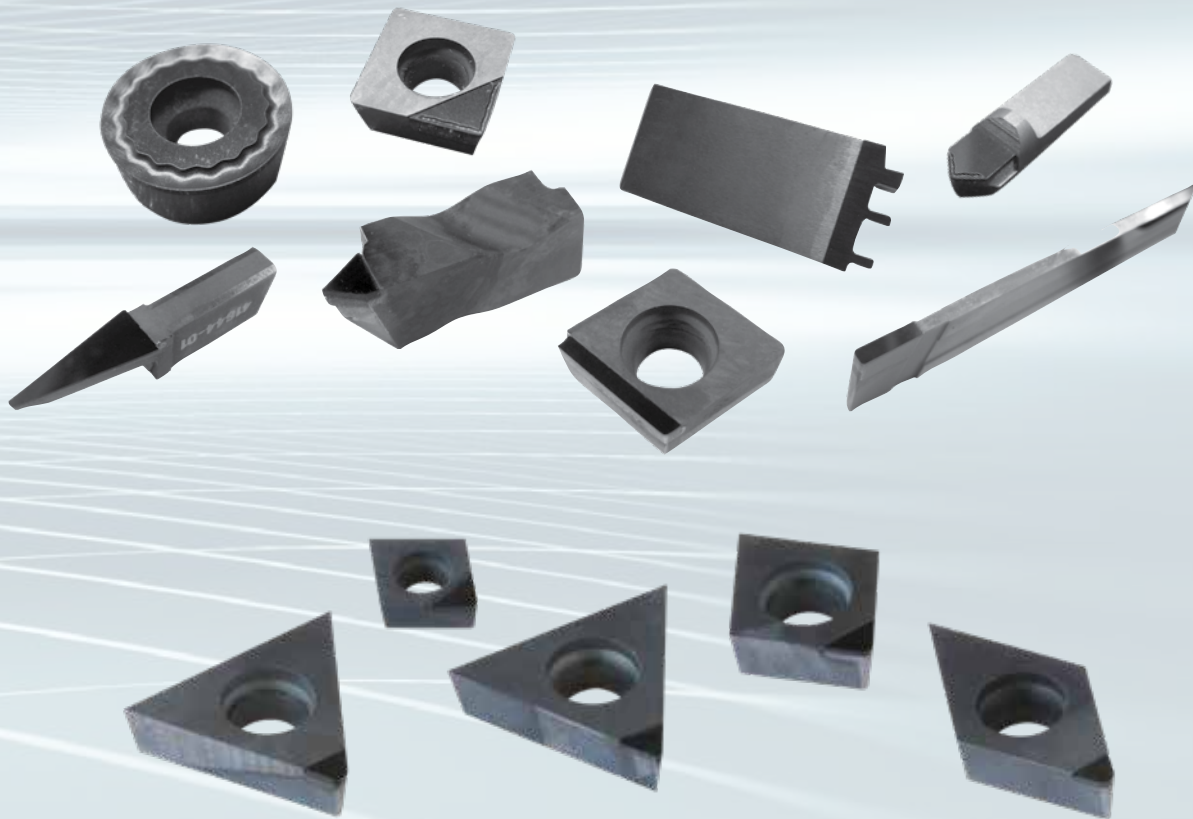

41990-03 / 41992-01 / 41994-04 / 41984-04 / 41986-04

Decatur Diamond offers a standard family of Positive Rake PCD tipped ANSI/ISO inserts for your turning and boring needs. Utilizing a premium grade of PCD, our inserts offer excellent tool life and performance to suit your application. Please contact your local **Decatur Diamond** sales representative for assistance in selecting the proper insert for your requirements.

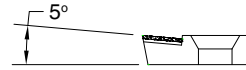
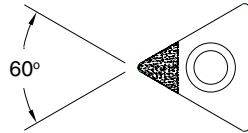

Part/EDP No.	ANSI Description	ISO Description	Tip Size	Top Rake
41990-01	TCGX-21.51 4mm PCD	TCGX-110204	4.0MM	5°
41990-02	TCGX-21.52 4mm PCD	TCGX-110208	4.0MM	5°
41990-03	TCGX-32.51 4mm PCD	TCGX-16T304	4.0MM	5°
41990-04	TCGX-32.52 4mm PCD	TCGX-16T308	4.0MM	5°
41991-01	TPGX-21.51 4mm PCD	TPGX-110204	4.0MM	5°
41991-02	TPGX-21.52 4mm PCD	TPGX-110208	4.0MM	5°
41991-03	TPGX-32.51 4mm PCD	TPGX-16T304	4.0MM	5°
41991-04	TPGX-32.52 4mm PCD	TPGX-16T308	4.0MM	5°

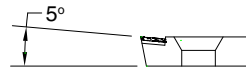
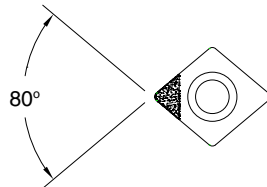

41992-01	CCGX-21.51 4mm PCD	CCGX-060204	4.0MM	5°
41992-02	CCGX-21.52 4mm PCD	CCGX-060208	4.0MM	5°
41992-03	CCGX-32.51 4mm PCD	CCGX-09T304	4.0MM	5°
41992-04	CCGX-32.52 4mm PCD	CCGX-09T308	4.0MM	5°
41993-01	CPGX-21.51 4mm PCD	CPGX-060204	4.0MM	5°
41993-02	CPGX-21.52 4mm PCD	CPGX-060208	4.0MM	5°
41993-03	CPGX-32.51 4mm PCD	CPGX-09T304	4.0MM	5°
41993-04	CPGX-32.52 4mm PCD	CPGX-09T308	4.0MM	5°

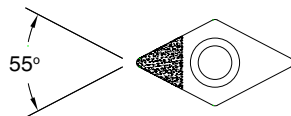

41994-01	DCGX-21.51 4mm PCD	DCGX-070204	4.0MM	5°
41994-02	DCGX-21.52 4mm PCD	DCGX-070208	4.0MM	5°
41994-03	DCGX-32.51 4mm PCD	DCGX-11T304	4.0MM	5°
41994-04	DCGX-32.52 4mm PCD	DCGX-11T308	4.0MM	5°
41995-01	DPGX-21.51 4mm PCD	DPGX-070204	4.0MM	5°
41995-02	DPGX-21.52 4mm PCD	DPGX-070208	4.0MM	5°
41995-03	DPGX-32.51 4mm PCD	DPGX-11T304	4.0MM	5°
41995-04	DPGX-32.52 4mm PCD	DPGX-11T308	4.0MM	5°

PCD Tipped ANSI/ISO Screwdown Inserts

Neutral Rake

Decatur Diamond offers a standard family of Neutral Rake PCD tipped ANSI/ISO inserts for your turning and boring needs. Utilizing a premium grade of PCD, our inserts offer excellent tool life and performance to suit your application. Please contact your local **Decatur Diamond** sales representative for assistance in selecting the proper insert for your requirements.

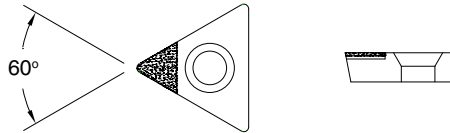

Part/EDP No.	ANSI Description	ISO Description	Tip Size	Top Rake
41984-01	TCGW-21.51 4mm PCD	TCGW-110204	4.0MM	0°
41984-02	TCGW-21.52 4mm PCD	TCGW-110208	4.0MM	0°
41984-03	TCGW-32.51 4mm PCD	TCGW-16T304	4.0MM	0°
41984-04	TCGW-32.52 4mm PCD	TCGW-16T308	4.0MM	0°
41985-01	TPGW-21.51 4mm PCD	TPGW-110204	4.0MM	0°
41985-02	TPGW-21.52 4mm PCD	TPGW-110208	4.0MM	0°
41985-03	TPGW-32.51 4mm PCD	TPGW-16T304	4.0MM	0°
41985-04	TPGW-32.52 4mm PCD	TPGW-16T308	4.0MM	0°

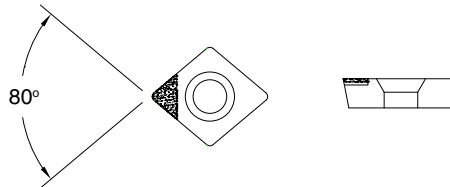

41986-01	CCGW-21.51 4mm PCD	CCGW-060204	4.0MM	0°
41986-02	CCGW-21.52 4mm PCD	CCGW-060208	4.0MM	0°
41986-03	CCGW-32.51 4mm PCD	CCGW-09T304	4.0MM	0°
41986-03	CCGW-32.52 4mm PCD	CCGW-09T308	4.0MM	0°
41987-01	CPGW-21.51 4mm PCD	CPGW-060204	4.0MM	0°
41987-02	CPGW-21.52 4mm PCD	CPGW-060208	4.0MM	0°
41987-03	CPGW-32.51 4mm PCD	CPGW-09T304	4.0MM	0°
41987-04	CPGW-32.52 4mm PCD	CPGW-09T308	4.0MM	0°

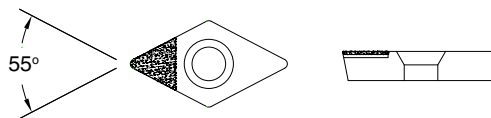

41988-01	DCGW-21.51 4mm PCD	DCGW-070204	4.0MM	0°
41988-02	DCGW-21.52 4mm PCD	DCGW-070208	4.0MM	0°
41988-03	DCGW-32.51 4mm PCD	DCGW-11T304	4.0MM	0°
41988-04	DCGW-32.52 4mm PCD	DCGW-11T308	4.0MM	0°
41989-01	DPGW-21.51 4mm PCD	DPGW-070204	4.0MM	0°
41989-02	DPGW-21.52 4mm PCD	DPGW-070208	4.0MM	0°
41989-03	DPGW-32.51 4mm PCD	DPGW-11T304	4.0MM	0°
41989-04	DPGW-32.52 4mm PCD	DPGW-11T308	4.0MM	0°

How to Order

Ordering is as simple as contacting your local authorized distributor. Alternatively, you can call us directly to get a list of authorized distributors in your area. For technical support, please use the numbers listed below and ask to speak with an applications engineer. Thank you for your business and your support of American manufacturing.



Decatur Diamond, LLC
3531 W. U.S. Hwy. 224
Decatur, IN. 46733

Phone: 888-547-4156
Fax: 260-547-4214
www.decaturdiamond.com

Limited Warranty

Decatur Diamond warrants to original equipment manufacturers, distributors and industrial and commercial users of its products that each new product that it manufactures or supplies is free from defects in material and workmanship. Its sole obligation under this warranty is limited to furnishing, without additional charge, a replacement for, or, at its option, repairing or issuing credit for any such product which shall, within one year from the date of sale by **Decatur Diamond** be returned freight prepaid to **Decatur Diamond** and which, upon inspection, is determined by **Decatur Diamond** to be defective in materials or workmanship. The provisions of this warranty shall not apply to any product which has been subjected to misuse, improper operating conditions, or which has been repaired or altered, if such would adversely affect performance of the product. Complete written information with respect to all such matters must be furnished to **Decatur Diamond** as a prerequisite to its consideration of any claim or complaint under this warranty.

The repair, replacement or issuance of credit for parts provided for in this warranty constitutes the Buyer's exclusive remedy. The warranty is in lieu of all other warranties, express or implied, including any implied warranty of merchantability or fitness for a particular purpose. **Decatur Diamond** has no liability or responsibility on any claim of any kind, whether in contract, tort or otherwise, for any loss or damage arising out of, connected with, or resulting from the manufacture, sale, delivery or use of any product sold hereunder, in excess of the cost of replacement or repair as provided herein. In no event shall **Decatur Diamond** be liable for any special, incidental or consequential damages. **Decatur Diamond** makes no other warranty, express or implied, except as set forth above; and neither assumes nor authorizes any other person or entity to assume for it any other obligation or liability in connection with any of its products.

WARNING

Any cutting tool may break or shatter under improper use. Government regulations require use of safety glasses and other appropriate safety equipment at all times in the vicinity of use. Wet or dry grinding of cutting tools produces potentially hazardous dusts or mists; to avoid adverse health effects, use adequate ventilation and read the material Safety Data Sheet for further applicable tool material or grade before grinding.



HERITAGE CUTTER



Decatur Diamond

3531 West US Hwy 224, Decatur, IN 46733
Ph. 888-547-4156 • Ph. 260-547-4150 • Fx. 260-547-4214
www.decaturdiamond.com

ISO 9001:2015