

# MERCUISER

## Cooling System

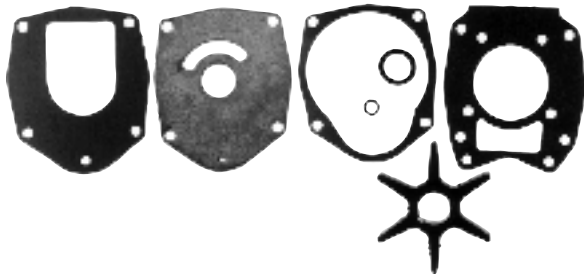

**18-3214<sup>①</sup>**  
**18-3214N<sup>②</sup>**  
**AP# 1811**  
**IMPELLER REPAIR KIT**  
For Alpha I - Generation 2 - S/N D494569 & Above  
—CONTAINS—

Sierra #	Desc.	O.E. #	Qty.
18-2564	Impeller Gasket	22-43033-1, 27-43033-1	1
18-2565	Impeller Gasket	27-43047-1	1
18-2566	Impeller Gasket	27-817277	1
18-2944	Seal Ring	12-19183	1
18-3056	Impeller	47-43026-1, 47-43026-2	1
18-3122	Impeller Plate	817276	4
18-7420	O-Ring	25-21836	1



**18-3237**  
**AP# 3127**  
**IMPELLER REPAIR KIT**  
For: Bravo I, II, III (1998 & up) B664190  
& up Fits Bravo drives with 1 piece housing

—CONTAINS—

Sierra #	Desc.	O.E. #	Qty.
18-3087	Impeller	47-59362	1
18-3350	Wear Plate	94576	1
18-7163	O-Ring	25-33465	1

**18-3570**  
**WATER PUMP KIT**  
Replaces: 817275A1, 817275A2  
—CONTAINS—

Sierra#	Desc.	O.E. #	Qty.
NSS	Water Pump Housing	—	1
18-3056	Impeller	47-430262-1	1
18-2599	Face Seal & Tool	26-816575A2	1
18-3122	Impeller Plate	817276	1

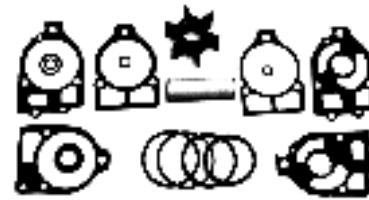

**18-3217<sup>①</sup>**  
**18-3217N<sup>②</sup>**  
**AP# 091**  
**IMPELLER REPAIR KIT**  
For #1 Units thru S/N D494568  
(Similar to #46-96148A5 without base or housing)

—CONTAINS—

Sierra #	Desc.	O.E. #	Qty.
18-3109	Water Tube	23-29804	1
18-3017	Impeller	47-89984	1
18-2919	Water Pump Base to Gear Housing Gasket	27-42631-1	1
18-3110	Grommet	26-38970	1
18-2945	Gear Hsg. Drain Screw Gasket	12-19183	2
18-2826	Water Pump Base to Gear Housing Gasket	27-85610-1	1
18-2914	Lower Water Pump to Wear Plate Gasket	27-85608-1	1
18-2915	Upper Water Pump to Wear Plate Gasket	27-85609-1	1
18-2944	Seal Ring	26-45577	1
18-3117	Plate	32435	1
18-7158	O-Ring	25-30613	1
18-7162	O-Ring	25-33145	1
18-7173	O-Ring	25-30224	1
18-7176	O-Ring	25-90011	1
18-2801	Gasket	27-32438	1
18-7196	O-Ring	25-38099	1
18-7426	O-Ring	35-30271	1

817275A2 APPLICATION		817275A2 APPLICATION (Cont.)	
40 (4 stroke)		80 Jet	OD283222 & UP
(4 cyl.) Bigfoot	OT228405 & UP	90 (3 cyl.)	OA996142 & UP
50 (4 stroke)		90 (4 stroke)	OG960500 & UP
935cc Big Foot	OG231123 OT178499	100 (4 cyl.)	OB209468 & UP
50 (4 stroke)		115 (4 cyl.)	OC100000 & UP
996cc Big Foot	OT178500 & UP	125 (4 cyl.)	OD283222 & UP
60 (3 cyl.)		<b>817275A1 APPLICATION</b>	
Bigfoot	OD000750 & UP	45 (4 stroke)	
60 (4 stroke)		Bigfoot Bodensee	OG231123 & UP
Bigfoot	OT178500 & UP	V-200 DFI (3.0L)	OG386496 OGS589999
65 Jet	OC283222 & UP	V-200 DFI (3.0L)	OG590000 & UP
70 (3 cyl.)	OA996142 & UP	V-225 (3.0L)	
75 (3 cyl.)	OC222000 & UP	Carb & EFI	OD280813 & UP
75 (4 stroke)	OG960500 & UP	V-225 DFI	OG590000 & UP
80 (3 cyl.)	OA996142 & UP	V-250 (3.0L) EFI	OG129222 & UP



**18-3224**  
**WATER PUMP REPAIR KIT**  
Replaces: 47-59362T6  
For: Bravo (Plastic 1 piece body)  
—CONTAINS—

Sierra #	Desc.	O.E. #	Qty.
18-3087	Impeller	47-59362	1
18-3350	Wear Plate	94576	1



**18-3150**  
**AP# 13159**  
**WATER PUMP KIT**  
Replaces: 46-807151A14  
For: Bravo











**18-3309**  
**AP# 3909**  
**WATER PUMP KIT**  
For: Bravo  
—CONTAINS—

Sierra #	Desc.	O.E. #	Qty.
18-3350	Wear Plate	94576	1
18-3351	Wear Plate	94916	1
18-3087	Impeller	47-59362	1
18-0386	Body Gasket	27-94914	2
18-0916	Water Pump Gasket	27-805215-1	1



**18-3147**  
**WATER PUMP KIT**  
Replaces: 817275T4  
For: Gen II-Lower  
s/n D469859 and Up

① Display Pack    ② Bulk Pack

 <p><b>18-3293</b> <b>AP# 2677</b> <b>IMPELLER DRIVE KEY</b> Replaces: 28-43037 Also large O/B's</p>	 <p><b>18-2352</b> <b>AP# 2639</b> <b>COUPLING</b> Replaces: 816597A1</p>	 <p><b>18-3417</b> <b>AP# 046</b> <b>WATER PUMP BASE</b> Replaces: 46-57234A1</p>																																																																																																																																																																			
 <p><b>18-3420</b> <b>AP# 1844</b> <b>WATER PUMP BASE</b> Replaces: 46-44292A3</p>	 <p><b>18-3421</b> <b>AP# 049</b> <b>WATER PUMP BASE</b> Replaces: 46-48748A1</p>	 <p><b>18-3116</b> <b>AP# 043</b> <b>UPPER PUMP HOUSING</b> Replaces: 46-96148A1</p>																																																																																																																																																																			
 <p><b>18-3317</b> <b>AP# 047</b> <b>COMPLETE PUMP HOUSING KIT</b> —CONTAINS—</p>		 <p><b>18-3320</b> <b>AP# 048</b> <b>COMPLETE PUMP HOUSING KIT</b> —CONTAINS—</p>																																																																																																																																																																			
<table border="1"> <thead> <tr> <th>Sierra #</th> <th>Desc.</th> <th>O.E. #</th> <th>Qty.</th> </tr> </thead> <tbody> <tr><td>18-3109</td><td>Water Tube</td><td>23-29804</td><td>1</td></tr> <tr><td>18-3017</td><td>Impeller</td><td>47-89984</td><td>1</td></tr> <tr><td>18-3116</td><td>Housing</td><td>46-96148A1</td><td>1</td></tr> <tr><td>18-2919</td><td>Water Pump Base to Gear Housing Gasket</td><td>27-42631-1</td><td>1</td></tr> <tr><td>18-3417</td><td>Water Pump Base</td><td>46-57234A1</td><td>1</td></tr> <tr><td>18-3110</td><td>Grommet</td><td>26-38970</td><td>1</td></tr> <tr><td>18-2945</td><td>Gear Hsg. Drain Screw Gasket</td><td>12-19183</td><td>2</td></tr> <tr><td>18-2826</td><td>Water Pump Base to Gear Housing Gasket</td><td>27-85610-1</td><td>1</td></tr> <tr><td>18-2914</td><td>Lower Water Pump to Wear Plate Gasket</td><td>27-85608-1</td><td>1</td></tr> <tr><td>18-2915</td><td>Upper Water Pump to Wear Plate Gasket</td><td>27-85609-1</td><td>1</td></tr> <tr><td>18-2944</td><td>Seal Ring</td><td>26-45577</td><td>1</td></tr> <tr><td>18-3117</td><td>Plate</td><td>32435</td><td>1</td></tr> <tr><td>18-7158</td><td>O-Ring</td><td>25-30613</td><td>1</td></tr> <tr><td>18-7162</td><td>O-Ring</td><td>25-33145</td><td>1</td></tr> <tr><td>18-7173</td><td>O-Ring</td><td>25-30224</td><td>1</td></tr> <tr><td>18-7176</td><td>O-Ring</td><td>25-90011</td><td>1</td></tr> <tr><td>18-2801</td><td>Water Pump Gasket</td><td>27-32438</td><td>1</td></tr> <tr><td>18-7196</td><td>O-Ring</td><td>25-38099</td><td>1</td></tr> <tr><td>18-7426</td><td>O-Ring</td><td>35-30271</td><td>1</td></tr> <tr><td>18-2919</td><td>Water Pump Gasket</td><td>27-46231-1</td><td>1</td></tr> </tbody> </table>	Sierra #	Desc.	O.E. #	Qty.	18-3109	Water Tube	23-29804	1	18-3017	Impeller	47-89984	1	18-3116	Housing	46-96148A1	1	18-2919	Water Pump Base to Gear Housing Gasket	27-42631-1	1	18-3417	Water Pump Base	46-57234A1	1	18-3110	Grommet	26-38970	1	18-2945	Gear Hsg. Drain Screw Gasket	12-19183	2	18-2826	Water Pump Base to Gear Housing Gasket	27-85610-1	1	18-2914	Lower Water Pump to Wear Plate Gasket	27-85608-1	1	18-2915	Upper Water Pump to Wear Plate Gasket	27-85609-1	1	18-2944	Seal Ring	26-45577	1	18-3117	Plate	32435	1	18-7158	O-Ring	25-30613	1	18-7162	O-Ring	25-33145	1	18-7173	O-Ring	25-30224	1	18-7176	O-Ring	25-90011	1	18-2801	Water Pump Gasket	27-32438	1	18-7196	O-Ring	25-38099	1	18-7426	O-Ring	35-30271	1	18-2919	Water Pump Gasket	27-46231-1	1	<table border="1"> <thead> <tr> <th>Sierra #</th> <th>Desc.</th> <th>O.E. #</th> <th>Qty.</th> </tr> </thead> <tbody> <tr><td>18-3109</td><td>Water Tube</td><td>23-29804</td><td>1</td></tr> <tr><td>18-3017</td><td>Impeller</td><td>47-89984</td><td>1</td></tr> <tr><td>18-3116</td><td>Housing</td><td>46-96148A1</td><td>1</td></tr> <tr><td>18-3420</td><td>Water Pump Base</td><td>46-44292A3</td><td>1</td></tr> <tr><td>18-2919</td><td>Water Pump Base to Gear Housing Gasket</td><td>27-42631-1</td><td>1</td></tr> <tr><td>18-3110</td><td>Grommet</td><td>26-38970</td><td>1</td></tr> <tr><td>18-2945</td><td>Gear Hsg. Drain Screw Gasket</td><td>12-19183</td><td>2</td></tr> <tr><td>18-2826</td><td>Water Pump Base to Gear Housing Gasket</td><td>27-85610-1</td><td>1</td></tr> <tr><td>18-2914</td><td>Lower Water Pump to Wear Plate Gasket</td><td>27-85608-1</td><td>1</td></tr> <tr><td>18-2915</td><td>Upper Water Pump to Wear Plate Gasket</td><td>27-85609-1</td><td>1</td></tr> <tr><td>18-2944</td><td>Seal Ring</td><td>26-45577</td><td>1</td></tr> <tr><td>18-3117</td><td>Plate</td><td>32435</td><td>1</td></tr> <tr><td>18-7158</td><td>O-Ring</td><td>25-30613</td><td>1</td></tr> <tr><td>18-7162</td><td>O-Ring</td><td>25-33145</td><td>1</td></tr> <tr><td>18-7173</td><td>O-Ring</td><td>25-30224</td><td>1</td></tr> <tr><td>18-7176</td><td>O-Ring</td><td>25-90011</td><td>1</td></tr> <tr><td>18-2801</td><td>Water Pump Gasket</td><td>27-32438</td><td>1</td></tr> <tr><td>18-7196</td><td>O-Ring</td><td>25-38099</td><td>1</td></tr> <tr><td>18-7426</td><td>O-Ring</td><td>35-30271</td><td>1</td></tr> </tbody> </table>	Sierra #	Desc.	O.E. #	Qty.	18-3109	Water Tube	23-29804	1	18-3017	Impeller	47-89984	1	18-3116	Housing	46-96148A1	1	18-3420	Water Pump Base	46-44292A3	1	18-2919	Water Pump Base to Gear Housing Gasket	27-42631-1	1	18-3110	Grommet	26-38970	1	18-2945	Gear Hsg. Drain Screw Gasket	12-19183	2	18-2826	Water Pump Base to Gear Housing Gasket	27-85610-1	1	18-2914	Lower Water Pump to Wear Plate Gasket	27-85608-1	1	18-2915	Upper Water Pump to Wear Plate Gasket	27-85609-1	1	18-2944	Seal Ring	26-45577	1	18-3117	Plate	32435	1	18-7158	O-Ring	25-30613	1	18-7162	O-Ring	25-33145	1	18-7173	O-Ring	25-30224	1	18-7176	O-Ring	25-90011	1	18-2801	Water Pump Gasket	27-32438	1	18-7196	O-Ring	25-38099	1	18-7426	O-Ring	35-30271	1
Sierra #	Desc.	O.E. #	Qty.																																																																																																																																																																		
18-3109	Water Tube	23-29804	1																																																																																																																																																																		
18-3017	Impeller	47-89984	1																																																																																																																																																																		
18-3116	Housing	46-96148A1	1																																																																																																																																																																		
18-2919	Water Pump Base to Gear Housing Gasket	27-42631-1	1																																																																																																																																																																		
18-3417	Water Pump Base	46-57234A1	1																																																																																																																																																																		
18-3110	Grommet	26-38970	1																																																																																																																																																																		
18-2945	Gear Hsg. Drain Screw Gasket	12-19183	2																																																																																																																																																																		
18-2826	Water Pump Base to Gear Housing Gasket	27-85610-1	1																																																																																																																																																																		
18-2914	Lower Water Pump to Wear Plate Gasket	27-85608-1	1																																																																																																																																																																		
18-2915	Upper Water Pump to Wear Plate Gasket	27-85609-1	1																																																																																																																																																																		
18-2944	Seal Ring	26-45577	1																																																																																																																																																																		
18-3117	Plate	32435	1																																																																																																																																																																		
18-7158	O-Ring	25-30613	1																																																																																																																																																																		
18-7162	O-Ring	25-33145	1																																																																																																																																																																		
18-7173	O-Ring	25-30224	1																																																																																																																																																																		
18-7176	O-Ring	25-90011	1																																																																																																																																																																		
18-2801	Water Pump Gasket	27-32438	1																																																																																																																																																																		
18-7196	O-Ring	25-38099	1																																																																																																																																																																		
18-7426	O-Ring	35-30271	1																																																																																																																																																																		
18-2919	Water Pump Gasket	27-46231-1	1																																																																																																																																																																		
Sierra #	Desc.	O.E. #	Qty.																																																																																																																																																																		
18-3109	Water Tube	23-29804	1																																																																																																																																																																		
18-3017	Impeller	47-89984	1																																																																																																																																																																		
18-3116	Housing	46-96148A1	1																																																																																																																																																																		
18-3420	Water Pump Base	46-44292A3	1																																																																																																																																																																		
18-2919	Water Pump Base to Gear Housing Gasket	27-42631-1	1																																																																																																																																																																		
18-3110	Grommet	26-38970	1																																																																																																																																																																		
18-2945	Gear Hsg. Drain Screw Gasket	12-19183	2																																																																																																																																																																		
18-2826	Water Pump Base to Gear Housing Gasket	27-85610-1	1																																																																																																																																																																		
18-2914	Lower Water Pump to Wear Plate Gasket	27-85608-1	1																																																																																																																																																																		
18-2915	Upper Water Pump to Wear Plate Gasket	27-85609-1	1																																																																																																																																																																		
18-2944	Seal Ring	26-45577	1																																																																																																																																																																		
18-3117	Plate	32435	1																																																																																																																																																																		
18-7158	O-Ring	25-30613	1																																																																																																																																																																		
18-7162	O-Ring	25-33145	1																																																																																																																																																																		
18-7173	O-Ring	25-30224	1																																																																																																																																																																		
18-7176	O-Ring	25-90011	1																																																																																																																																																																		
18-2801	Water Pump Gasket	27-32438	1																																																																																																																																																																		
18-7196	O-Ring	25-38099	1																																																																																																																																																																		
18-7426	O-Ring	35-30271	1																																																																																																																																																																		

# MERCUISER

## Cooling System





**18-3321**  
**AP# 13171**  
**COMPLETE PUMP HOUSING KIT**

—CONTAINS —

Sierra #	Desc.	O.E. #	Qty.
18-3109	Water Tube	23-29804	1
18-3017	Impeller	47-89984	1
18-3116	Housing	46-96148A1	1
18-3421	Water Pump Base	46-48748A1	1
18-2919	Water Pump Base to Gear Housing Gasket	27-42631-1	1
18-3110	Grommet	26-38970	1
18-2945	Gear Hsg. Drain Screw Gasket	12-19183	2
18-2826	Water Pump Base to Gear Housing Gasket	27-85610-1	1
18-2914	Lower Water Pump to Wear Plate Gasket	27-85608-1	1
18-2915	Upper Water Pump to Wear Plate Gasket	27-85609-1	1
18-2944	Seal Ring	26-45577	1
18-3117	Plate	32435	1
18-7158	O-Ring	25-30613	1
18-7162	O-Ring	25-33145	1
18-7173	O-Ring	25-30224	1
18-7176	O-Ring	25-90011	1
18-2801	Water Pump Gasket	27-32438	1
18-7196	O-Ring	25-38099	1
18-7426	O-Ring	35-30271	1



**18-3517**  
**AP# 090**  
**UPPER PUMP HOUSING KIT**  
**Without Base**  
Replaces: 46-96148A5,46-60367A1

—CONTAINS —

Sierra #	Desc.	O.E. #	Qty.
18-3109	Water Tube	23-29804	1
18-3017	Impeller	47-89984	1
18-3116	Housing	46-96148A1	1
18-2919	Water Pump Base to Gear Housing Gasket	27-42631-1	1
18-3110	Grommet	26-38970	1
18-2945	Gear Housing Drain Screw Gasket	26-20260, 12-19183	2
18-2826	Water Pump Base to Gear Housing Gasket	27-85610-1	1
18-2914	Lower Water Pump to Wear Plate Gasket	27-85608-1	1
18-2915	Upper Water Pump to Wear Plate Gasket	27-85609-1	1
18-2944	Seal Ring	26-45577	1
18-3117	Plate	32435	1
18-7158	O-Ring	25-30613	1
18-7162	O-Ring	25-33145	1
18-7173	O-Ring	25-30224	1
18-7176	O-Ring	25-90011	1
18-2801	Water Pump Gasket	27-32438	1
18-7196	O-Ring	25-38099	1
18-7426	226	O-Ring	35-30271

### COMPLETE WATER PUMP KIT, IMPELLER REPAIR KIT, IMPELLER APPLICATION

Model	Serial Number	Complete Water Pump Kit	Upper Pump Hsg.	Upper Pump Kit	Water Pump Base	Impeller Repair Kit	Impeller
#1 Units with plastic flush screw in gear housing	2495186-2763441	18-3321	18-3116	18-3517	18-3421	18-3217	18-3017
#1 Units (Except MR/ALPHA) w/o flush screw in gear housing	2763442-6854392	18-3317 <sup>①</sup>	18-3116	18-3517	18-3417 <sup>①</sup>	18-3217	18-3017
MR/ALPHA I	6854393 - D594568	18-3320	18-3116	18-3517	18-3420	18-3217	18-3017
ALPHA I - Generation 2	D494569 & ABOVE	—	—	—	—	18-3214	18-3056
BRAVO/Inboards with externally mounted pump	3040411 & ABOVE	—	—	—	—	—	18-3087

<sup>①</sup> Models which have been retro-fitted with an Alpha style lower unit (no pre-load pin in top of driveshaft) must use Alpha style parts (18-3320 and 18-3420)

## GENERATION II WATER PUMP ASSEMBLY

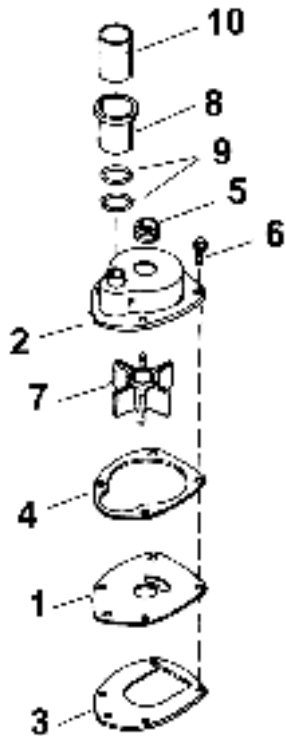

Sequence	Description	Sierra #	O.E. #	Qty.
1.	Face Plate .....	18-3122	817276	1
2.	Housing Assembly .....	N.S.S	—	1
3.	Gasket, Base .....	18-2564	27-43033-1	1
4.	Gasket, Housing .....	18-2566	27-817277	1
5.	Seal, Face .....	18-2599	26-816575A2	1
6.	Screw, Housing .....	N/A	—	4
7.	Impeller .....	18-3056	47-43026-2	1
8.	Coupling Assembly .....	N/A	—	1
9.	O-Ring .....	18-7420	25-21836	2
10.	Sleeve .....	N/A	—	1

## MR ALPHA WATER PUMP ASSEMBLY

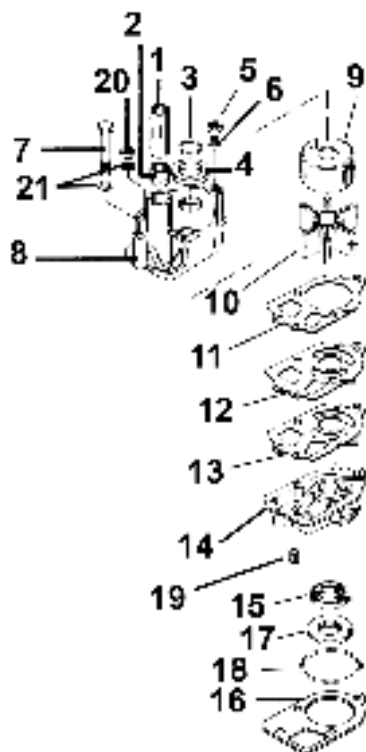

Sequence	Description	Sierra #	O.E. #	Qty.
1.	Guide, Sleeve .....	18-3109	23-29804	1
2.	Seal, Sleeve Guide (Included in 18-3109) .....	18-3110	26-38970	1
3.	Ring, Upper .....	18-7158	25-30613	1
4.	Ring, Dust .....	18-7426	25-30271	1
5.	Nut, Housing .....	N/A	—	1
6.	Washer, Housing .....	18-4270	12-36001	3
7.	Screw, Housing .....	N/A	—	—
8.	Housing, Water Pump .....	18-3116	46-96148A1	1
9.	Cup, Impeller .....	—	—	—
10.	Impeller .....	18-3017	47-89984	1
11.	Gasket, Impeller .....	18-2915	27-85609-1	1
12.	Plate, Impeller .....	18-3117	32435	1
13.	Gasket, Stainless Steel Plate .....	18-2914	27-85608-1	1
14.	Water Pump Base Assembly .....	18-3420	46-44292A3	1
15.	Oil Seal, Water Pump Base (Included in 18-3420) .....	18-2013	26-16977	1
16.	Gasket, Water Pump Base .....	18-2919	27-42631-1	1
17.	Oil Seal, Water Pump Base (Included in 18-3420) .....	18-2014	26-89238	1
18.	O-Ring, Water Pump Base .....	18-7176	25-90011	1
19.	Pin, Alignment .....	N/A	—	—
20.	Nut, Housing .....	N/A	—	—
21.	Washer, Housing .....	18-4269	12-29245	2

Courtesy of Seloc Publishing

# MERCUISER

## Cooling System



### R/MR WATER PUMP ASSEMBLY

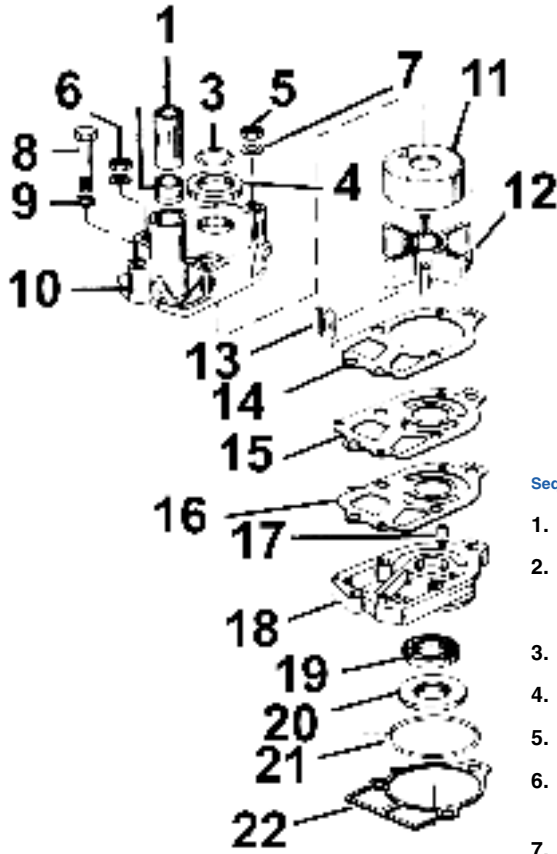

Sequence	Description	Sierra #	O.E. #	Qty.
1.	Guide, Water Tube .....	18-3109	23-29804	1
2.	Grommet, Water Tube Guide (Included with 18-3109) .....	18-3110	26-38970	1
3.	O-Ring .....	18-7158	25-30613	1
4.	Seal, Dust Cover .....	18-7426	25-30271	1
5.	Nut, Housing Retainer .....	18-3723	11-45592	1
6.	Nut, Housing Retainer .....	18-3722	11-20361, 11-35888	2
7.	Washer, Housing Retainer .....	18-4269	12-29245	3
8.	Bolt, Housing Retainer .....	18-3226	10-30720	1
9.	Washer, Housing Retainer .....	18-4270	12-36001	1
10.	Housing, Impeller .....	18-3116	46-96148A1	1
11.	Cup, Impeller (Included with 18-3116) .....	18-3114	48752	1
12.	Impeller .....	18-3017	47-89984	1
13.	Key, Impeller .....	N/A	—	—
14.	Gasket, Impeller .....	18-2915	27-85609-1	1
15.	Wear Plate, Impeller .....	18-3117	32435	1
16.	Gasket, Wear Plate .....	18-2914	27-85608-1	1
17.	Pin, Alignment .....	18-3227	17-35973	1
18.	Base Assembly .....	18-3417	46-57234A1	1
19.	Oil Seal, Base Assembly (Included in 18-3417) .....	18-2013	26-16977	1
20.	Oil Seal, Base Assembly (Included in 18-3417) .....	18-2014	26-89238	1
21.	O-Ring, Base Assembly .....	18-7162	25-33145	1
22.	Gasket, Base Assembly .....	18-2826	27-85610-1	1

Courtesy of Seloc Publishing





# MERCURUISER



## Features...

- ★ All kits feature high-grade stainless and brass bi-metal thermostats.
- ★ Correct operating ranges for proper cooling performance.

 <p><b>18-3550</b> AP# 401 <b>THERMOSTAT</b> Replaces: 59078 140°</p>	 <p><b>18-3551</b> AP# 3057 <b>THERMOSTAT</b> Replaces: 59137 142°</p>	 <p><b>18-3552</b> <b>THERMOSTAT</b> Replaces: 76270, 76270T 160°</p>	 <p><b>18-3555</b> AP# 409 <b>THERMOSTAT</b> Replaces: 99155A1 160°</p>																																						
 <p><b>18-3557</b> AP# 422 <b>THERMOSTAT</b> Replaces: 47594 143°</p>	 <p><b>18-3649</b> AP# 13199 <b>THERMOSTAT</b> Replaces: 807252-2 160°</p>	 <p><b>18-3648</b> AP# 13198 <b>THERMOSTAT KIT</b> 160°</p>	<div style="text-align: right; font-size: small;"> <span style="border: 1px solid black; padding: 2px;">Display Package</span> </div>  <p><b>18-3650</b> <b>THERMOSTAT KIT</b> —CONTAINS—</p> <table border="1" style="width: 100%; font-size: x-small;"> <thead> <tr> <th>Sierra #</th> <th>Description</th> <th>O.E.#</th> </tr> </thead> <tbody> <tr> <td>18-2831</td> <td>Gasket</td> <td>27-47590-1</td> </tr> <tr> <td>18-3550</td> <td>Thermostat</td> <td>59078</td> </tr> </tbody> </table>	Sierra #	Description	O.E.#	18-2831	Gasket	27-47590-1	18-3550	Thermostat	59078																													
Sierra #	Description	O.E.#																																							
18-2831	Gasket	27-47590-1																																							
18-3550	Thermostat	59078																																							
<div style="text-align: right; font-size: small;"> <span style="border: 1px solid black; padding: 2px;">Display Package</span> </div>  <p><b>18-3651</b> AP# 2367 <b>THERMOSTAT KIT</b> —CONTAINS—</p> <table border="1" style="width: 100%; font-size: x-small;"> <thead> <tr> <th>Sierra #</th> <th>Description</th> <th>O.E.#</th> </tr> </thead> <tbody> <tr> <td>18-2551</td> <td>Thermostat Cover Gasket</td> <td>27-90556</td> </tr> <tr> <td>18-2553</td> <td>Thermostat Cover Gasket</td> <td>27-47510</td> </tr> <tr> <td>18-2834</td> <td>Thermostat Cover Gasket</td> <td>27-60208</td> </tr> <tr> <td>18-2844</td> <td>Thermostat Cover Gasket</td> <td>27-48818-1</td> </tr> <tr> <td>18-3551</td> <td>Thermostat</td> <td>59137</td> </tr> </tbody> </table>	Sierra #	Description	O.E.#	18-2551	Thermostat Cover Gasket	27-90556	18-2553	Thermostat Cover Gasket	27-47510	18-2834	Thermostat Cover Gasket	27-60208	18-2844	Thermostat Cover Gasket	27-48818-1	18-3551	Thermostat	59137	 <p><b>18-3652</b> AP# 407 <b>THERMOSTAT KIT</b> —CONTAINS—</p> <table border="1" style="width: 100%; font-size: x-small;"> <thead> <tr> <th>Sierra #</th> <th>Description</th> <th>O.E.#</th> </tr> </thead> <tbody> <tr> <td>18-2555</td> <td>Thermostat Cover Gasket</td> <td>27-89656-1</td> </tr> <tr> <td>18-2843</td> <td>Thermostat Cover Gasket</td> <td>27-74830</td> </tr> <tr> <td>18-3552</td> <td>Thermostat</td> <td>76270</td> </tr> </tbody> </table>	Sierra #	Description	O.E.#	18-2555	Thermostat Cover Gasket	27-89656-1	18-2843	Thermostat Cover Gasket	27-74830	18-3552	Thermostat	76270	 <p><b>18-3667</b> AP# 409 <b>THERMOSTAT KIT</b> —CONTAINS—</p> <table border="1" style="width: 100%; font-size: x-small;"> <thead> <tr> <th>Sierra #</th> <th>Description</th> <th>O.E.#</th> </tr> </thead> <tbody> <tr> <td>18-2555</td> <td>Thermostat Cover Gasket</td> <td>27-89656-1</td> </tr> <tr> <td>18-3555</td> <td>Thermostat</td> <td>99155A1</td> </tr> </tbody> </table>	Sierra #	Description	O.E.#	18-2555	Thermostat Cover Gasket	27-89656-1	18-3555	Thermostat	99155A1
Sierra #	Description	O.E.#																																							
18-2551	Thermostat Cover Gasket	27-90556																																							
18-2553	Thermostat Cover Gasket	27-47510																																							
18-2834	Thermostat Cover Gasket	27-60208																																							
18-2844	Thermostat Cover Gasket	27-48818-1																																							
18-3551	Thermostat	59137																																							
Sierra #	Description	O.E.#																																							
18-2555	Thermostat Cover Gasket	27-89656-1																																							
18-2843	Thermostat Cover Gasket	27-74830																																							
18-3552	Thermostat	76270																																							
Sierra #	Description	O.E.#																																							
18-2555	Thermostat Cover Gasket	27-89656-1																																							
18-3555	Thermostat	99155A1																																							

THERMOSTAT APPLICATION BEGINS ON PAGE 541

# MERCUISER Cooling System



**18-3644**  
**AP# 3222**  
**THERMOSTAT KIT**  
—CONTAINS—

Sierra #	Description	O.E.#
18-3649	Thermostat 160°	807252T2
18-2553	Thermostat CoverGasket	27-47510
18-2917	Thermostat CoverGasket	27-53045-1

**18-3646**  
**THERMOSTAT KIT**  
Replaces: 807252Q3  
—CONTAINS—

Sierra #	Description	O.E.#
18-3551	Thermostat	59137
18-2917	Thermostat Housing Gasket	27-53045-1, 27-33918
18-2844	Thermostat Cover Gasket	27-48818-1
18-2553	Thermostat Cover Gasket	27-47510
18-2834	Thermostat Cover Gasket	27-60208

**18-3647**  
**THERMOSTAT KIT**  
Replaces: 807252Q5  
—CONTAINS—

Sierra #	Description	O.E.#
18-3649	Thermostat	807252-2
18-2844	Thermostat Cover Gasket	27-48818-1
18-2552	Thermostat Cover Gasket	27-33179-2
18-2553	Thermostat Cover Gasket	27-47510
18-7173	O-Ring	25-30224
18-2917	Thermostat Housing Gasket	27-53045-1, 27-33918

**18-3668**  
**AP# 3948**  
**THERMOSTAT KIT**  
—CONTAINS—

Sierra #	Description	O.E.#
18-2552	Thermostat Cover Gasket	27-33179-2
18-2553	Thermostat Cover Gasket	27-47510
18-2554	Thermostat Cover Gasket	27-41812
18-3551	Thermostat	59137
18-7173	O-Ring	25-30224

**18-3568**  
**THERMOSTAT KIT**  
Replaces: 99155T1

Model	Year	Serial #
5.7MIE	1998-2001	OL002003 & Up
MX6.2LMPi	2000-2001	OL680003 & Up
454 Horizon MIE	1998-2001	OL002200 & Up
502 Mag. MPI	1998-2001	OL017000 & Up

**18-1993**  
**AP# 5002**  
**THERMOSTAT HOUSING**  
Replaces: 78984A01, 861493A3

**18-1994**  
**AP# 5004**  
**THERMOSTAT HOUSING**  
Replaces: 87290A4  
For: Stainless Steel Version use AP# 5040

**18-1989**  
**AP# 5040**  
**STAINLESS STEEL THERMOSTAT HOUSING**  
Replaces: 87290A4, 861006A1

THERMOSTAT APPLICATION BEGINS ON NEXT PAGE



# MERCUISER Cooling System

THERMOSTAT APPLICATION							
Engine Model	Beg. S/N	End. S/N	Thermostat	Cover	Gaskets	Housing	Thermostat Kit
ROVER	3140000	UP	18-3551	—	—	—	—
60	1887079	2049044	18-3551	—	—	—	—
80	2049045	2851423	18-3551	—	—	—	—
90	2851424	3226957	18-3557	—	18-2831	—	—
110	1537370	2044033	18-3551	—	—	—	—
120	① 1666601	3377340	18-3551	—	—	—	—
120	② 1725593	2324346	18-3551	—	—	—	—
120/2.5L	② 2324347	UP	18-3550	18-1969	18-2831	18-7750	18-3650
140 (6 CYL)	1538930	1725960	18-3551	—	—	—	—
140 (4 CYL)/3.0L	2508261	UP	18-3550	18-1969	18-2831	18-7750	18-3650 ⑧
3.0L/3.0LX	C856559	UP	18-3550	18-1969	18-2831	18-7750	18-3650
150	1666495	2048046	18-3551	—	—	—	—
160	① 2048022	2770031	18-3551	—	—	—	—
160	② 2048022	2233574	18-3557	—	—	—	—
160	② 2326069	2770031	18-3557	—	18-2831	—	—
165	2770032	5813433	18-3550	18-1969	18-2831	18-1968	18-3650
165/3.7L (4 CYL)	6916779	UP	18-3555	—	18-2555	—	18-3667
170 (4 CYL)	6916779	UP	18-3555	—	18-2555	—	18-3667
175/4.3L, 4.3LX (262 CID) ③	B527955	UP	18-3551	—	18-2553, 18-2554	—	18-3668
175/4.3L, 4.3 LX (262 CID) ④	B527955	UP	18-3551	—	18-2552, 18-7173	—	18-3668
175/4.3L, 4.3 LX (262 CID) ④	F001220	UP	18-3649 ⑦	—	18-2552, 18-7173	—	18-3648
180/3.7L-LX (4 CYL)	6916779	UP	18-3555	—	18-2555	—	18-3667
185 (229 CID)	6330183	6919655	18-3551	—	18-2553, 18-2554	18-1994 ⑨	18-3668
185 (262 CID)	A331455	B527954	18-3551	—	18-2553, 18-2554	18-1994 ⑨	18-3668
190	1564539	1730903	18-3551	—	—	—	—
190 (4 CYL)	6916779	UP	18-3555	—	18-2555	—	18-3667
200	2453769	2712072	18-3557	—	18-2831	—	—
200 GM	6218462	B525981	18-3551	—	18-2553, 18-2554	18-1994 ⑨	18-3668
200/5.0L	0B525982	0F600999	18-3649	—	18-2917	—	18-3647
200/5.0L GM ③	B525982	UP	18-3551	—	18-2553, 18-2554	18-1994 ⑨	18-3668
200/5.0L GM ④	B525982	UP	18-3649 ⑦	—	18-2552, 18-7173	18-1994 ⑨	18-3648
205 (262 CID)	A331455	B527954	18-3551	—	18-2553, 18-2554	18-1994 ⑨	18-3668
205/4.3L, 4.3LX (262 CID) ③	B527955	D714369	18-3551	—	18-2553, 18-2554	18-1994 ⑨	18-3668
205/4.3L, 4.3 LX (262 CID) ④	B527955	D714369	18-3551	—	18-2552, 18-7173	—	18-3668
205/4.3L, 4.3 LX (262 CID) ④	F001220	UP	18-3649 ⑦	—	18-2552, 18-7173	—	18-3648
215 FORD	2781153	3040410	18-3551	—	—	—	—
215 FORD	3040411	UP	18-3551	—	18-2834	—	18-3651
215 FORD MCM/MIE	3040411	3385720	18-3649	—	18-2834	—	18-3646
225 FORD MCM/MIE	3385721	4176999	18-3649	—	18-2834	—	18-3646
225 GM	1539620	2278646	18-3551	—	—	—	—
225 GM	2278647	2399197	18-3551	—	18-2552, 18-7173	—	18-3668
225 GM	2399198	2694014	18-3551	—	18-2553, 18-2844	—	18-3651
225/225S FORD	3385721	UP	18-3551	—	18-2834	—	18-3651
228 GM MCM/MIE	4765100	6218461	18-3649	—	18-2844, 18-2917	—	18-3646
228 GM	4765100	6218461	18-3551	—	18-2844, 18-1993	18-3651	—
228 GM	6218462	B525981	18-3551	—	18-2553, 18-2554	18-1994 ⑨	18-3668
230 GM	6218462	B525981	18-3551	—	18-2553, 18-2554	18-1994 ⑨	18-3668
230 MIE	5907058	0B5225505	18-3649	—	18-2553, 18-2844, 18-2917	—	18-3646
230 GM IB ⑤	5907058	B522505	18-3551	—	18-2553, 18-2554	—	18-3668
230 GM IB ⑥	5907058	B522505	18-3551	—	18-2553, 18-2844	—	18-3651
230/5.0L GM IB ③ ⑤	B522506	B525981	18-3551	—	18-2553, 18-2554	—	18-3668
230/5.0L GM IB ④ ⑤	B522506	B525981	18-3649 ⑦	—	18-2552, 18-7173	—	18-3648
230/5.0L GM IB ⑥	B522506	B525981	18-3551	—	18-2553, 18-2844	—	18-3651
230/5.0L-LX GM ③	B525982	F600999	18-3551	—	18-2553, 18-2554	18-1994 ⑨	18-3668
230/5.0L-LX GM ④	B525982	UP	18-3551	—	18-2552, 18-7173	—	18-3668
230/5.0L GM IB ④	B522506	B525981	18-3649 ⑦	—	18-2552, 18-7173	—	18-3648
230/5.0L-LX GM	B525982	F600999	18-3649 ⑦	—	18-2552, 18-7173	18-1994 ⑨	18-3648
230/5.0L MIE	0B522506	0B788151	18-3649	—	18-2553, 18-2844, 18-2917	—	18-3646
230/5.0LX GM	0B525982	0F600999	18-3649	—	18-2917	—	18-3647
233 FORD	4173000	UP	18-3551	—	18-2834	—	18-3651
233 FORD MIE	4173000	4902304	18-3649	—	18-2834	—	18-3646

- ① Aluminum Manifold
- ② Cast Iron
- ③ Old Design

- ④ New Design
- ⑤ Std. Cooling
- ⑥ Closed Cooling

- ⑦ 160°
- ⑧ S/N 6229718 & up
- ⑨ For stainless steel version use 18-1989

I/O



# MERCUISER

## Cooling System



THERMOSTAT APPLICATION (Cont.)							
Engine Model	Beg. S/N	End. S/N	Thermostat	Cover	Gaskets	Housing	Thermostat Kit
250 GM	2314301	2639854	18-3551	—	18-2553, 18-2844	—	18-3651
250 GM	4768000	4908849	18-3551	—	18-2844	18-1993	18-3651
250 GM	4768000	4908849	18-3649	—	18-2844, 18-2917	—	18-3646
250 GM MCM/MIE	2314301	2639854	18-3649	—	18-2533, 18-2844, 18-2917	—	18-3646
250 GM MCM/MIE	4175500	5907057	18-3649	—	18-2844, 18-2917	—	18-3646
255 FORD	3258728	UP	18-3551	—	18-2834	—	18-3651
255 FORD MCM/MIE	3258728	4178299	18-3649	—	18-2834	—	18-3646
255 GM	4175500	4767999	18-3551	—	18-2844	18-1993	18-3651
260 GM	4908850	6218461	18-3551	—	18-2844	—	18-3651
260 GM	6218462	B525981	18-3551	—	18-2553, 18-2554	18-1994 ⑨	18-3668
260 GM	4908850	6218461	18-3649	—	18-2844, 18-2917	—	18-3646
260 GM IB ⑤	5907058	B522505	18-3551	—	18-2553, 18-2554	—	18-3668
260 GM IB ⑥	5907058	B522505	18-3551	—	18-2553, 18-2844	—	18-3651
260 MIE	5907058	OB522505	18-3649	—	18-2553, 18-2844, 18-2917	—	18-3646
260/5.7L GM IB ③ ⑤	B522506	B525981	18-3551	—	18-2553, 18-2554	—	18-3668
260/5.7L GM IB ④ ⑤	B522506	B525981	18-3551	—	18-2552, 18-7173	—	18-3668
260/5.7L GM IB ④ ⑤	B522506	B525981	18-3649 ⑦	—	18-2552, 18-7173	—	18-3648
260/5.7L GM IB ⑥	B522506	B525981	18-3551	—	18-2553, 18-2844	—	18-3651
260/5.7L GM ③	B525982	F600999	18-3551	—	18-2553, 18-2554	18-1994 ⑨	18-3668
260/5.7L GM ④	B525982	F600999	18-3551	—	18-2552, 18-7173	—	18-3668
260/5.7L GM ④	B525982	F600999	18-3649 ⑦	—	18-2552, 18-7173	—	18-3648
260/5.7L GM	OB525982	OF600999	18-3649	—	18-2917	—	18-3647
260/5.7L MIE	OB522506	OF024999	18-3649	—	18-2553, 18-2844, 18-2917	—	18-3646
262 MAG ALPHA	OF803800	OK999999	18-3649	—	18-2917	—	18-3647
262 MAG BRAVO	OF803800	OK999999	18-3649	—	18-2917	—	18-3647
350 Mag	B525982	F600999	18-3551	—	18-2552, 18-7173	18-1994 ⑨	18-3668
4.3L/LX GM	OF000878	OF601126	18-3649	—	18-2917	—	18-3647
4.3L/LX/LXH ALPHA	OF601127	OK999999	18-3649	—	18-2917	—	18-3647
4.3L/LX/LXH BRAVO	OF601127	OK999999	18-3649	—	18-2917	—	18-3647
4.3L/LH/EFI ALPHA	OL010044	UP	18-3649	—	18-2917	—	18-3647
4.3L/LH/EFI	OL010044	UP	18-3649	—	18-2917	—	18-3647
5.0L/EFI ALPHA	OL012052	UP	18-3649	—	18-2917	—	18-3647
5.0L/EFI BRAVO	OL012052	UP	18-3649	—	18-2917	—	18-3647
5.7 GM ALPHA	OF225560	OK999999	18-3649	—	18-2917	—	18-3647
5.7 GM BRAVO	OF225560	OK999999	18-3649	—	18-2917	—	18-3647
5.7L/EFI GM ALPHA	OL010037	UP	18-3649	—	18-2917	—	18-3647
5.7L/EFI GM BRAVO	OL010037	UP	18-3649	—	18-2917	—	18-3647
5.7 GM (SKI)	A338553	B514626	18-3551	—	18-2553, 18-2554	18-1994 ⑨	18-3668
5.7L SKI	OB514627	UP	18-3649	—	18-2917	—	18-3647
5.7 GM SKI/BRAVO ③	B514627	UP	18-3551	—	18-2553, 18-2554	—	18-3668
5.7 GM SKI/BRAVO ④	B514627	UP	18-3551	—	18-2552, 18-7173	—	18-3668
5.7 GM SKI/BRAVO ④	B514627	UP	18-3649 ⑦	—	18-2552, 18-7173	—	18-3648
5.7L MIE	OF025000	OF622099	18-3649	—	18-2844	—	18-3647
5.7L MIE	OF622100	OK999999	18-3649	—	18-2917	—	18-3647
5.7L MIE	OF622100	OK999999	18-3649	—	18-2844	—	18-3647
5.7L MIE	OL002003	UP	18-3649	—	18-2917	—	18-3647
270 GM	2851074	3077735	18-3551	—	18-2553, 18-2844	—	18-3651
270 GM MCM/MIE	2851074	3385720	18-3649	—	18-2553, 18-2844, 18-2917	—	18-3646
280 GM	4176250	4770199	18-3649	—	18-2844, 18-2917	—	18-3646
280 GM TRS	4176250	4770199	18-3551	—	18-2844	18-1993	18-3651
300 MR/TRS GM	6668677	B430367	18-3551	—	18-2553, 18-2554	18-1994 ⑨	18-3668
320 GM EFI	A543604	UP	18-3551	—	18-2553, 18-2844	—	18-3651
320 GM	OA543604	OC622418	18-3649	—	18-2553, 18-2844, 18-2917	—	18-3646
325 GM MCM/MIE	2278747	3780449	18-3649	—	18-2553, 18-2844, 18-2917	—	18-3646
325 GM	2278747	2313964	18-3551	—	18-2553	—	18-3668
325 GM	2313965	3042730	18-3551	—	18-2553, 18-2844	—	18-3651
325 GM	3042731	UP	18-3551	—	18-2844	—	18-3651
330 GM	4623115	UP	18-3551	—	18-2844	—	18-3651
330 GM MCM/MIE	4623115	OB816540	18-3649	—	18-2553, 18-2844, 18-2917	—	18-3646
330 GM W/BW ⑤	6083145	UP	18-3551	—	18-2553, 18-2554	—	18-3668
330 GM W/BW ⑥	6083145	UP	18-3551	—	18-2553, 18-2844	—	18-3651
340/7.4L GM IB ③ ⑤	5889914	UP	18-3551	—	18-2553, 18-2554	—	18-3668

① Aluminum Manifold

② Cast Iron

③ Old Design

④ New Design

⑤ Std. Cooling

⑥ Closed Cooling

⑦ 160°

⑧ S/N 6229718 & up

⑨ For stainless steel version use 18-1989



# MERCUISER Cooling System

THERMOSTAT APPLICATION (Cont.)								
Engine Model	Beg. S/N	End. S/N	Thermostat	Cover	Gaskets	Housing	Thermostat Kit	
340/7.4L GM IB	④ ⑤	5889914	UP	18-3551	—	18-2552, 18-7173	—	18-3668
340/7.4L GM IB	⑥	5889914	UP	18-3551	—	18-2553, 18-2844	—	18-3651
340/7.4L MIE		5889914	0D715493	18-3649	—	18-2553, 18-2844, 18-2917	—	18-3646
350 MAG		0B252882	0K999999	18-3649	—	18-2917	—	18-3647
350 MAG		0B252882	0K999999	18-3649	—	18-2917	—	18-3647
350 MAG SKI		0D505450	0K999999	18-3649	—	18-2917	—	18-3647
350 MAG EFI SKI		0F215561	0K999999	18-3649	—	18-2917	—	18-3647
350 MAG MPI/MIE		0L010019	UP	18-3649	—	18-2917	—	18-3647
350 MAG MPI SKI		0F350583	UP	18-3649	—	18-2917	—	18-3647
SCORPION SKI		0F800000	UP	18-3649	—	18-2917	—	18-3647
7.4 BRAVO GM	③	B771113	D603117	18-3551	—	18-2553, 18-2554	—	18-3668
7.4 BRAVO GM	④	B771113	UP	18-3551	—	18-2552, 18-7173	—	18-3668
7.4 BRAVO GM	④	D603118	UP	18-3649 ⑦	—	18-2552, 18-7173	—	18-3648
7.4L W/HURTH IB	⑤	C391564	D715493	18-3551	—	18-2552, 18-7173	—	18-3668
7.4L W/HURTH IB	⑥	C391564	UP	18-3551	—	18-2553, 18-2844	—	18-3651
7.4L W/HURTH IB		D715494	UP	18-3649 ⑦	—	18-2553, 18-2844	—	18-3648
7.4L LX GM		0F352000	0K999999	18-3649	—	18-2917	—	18-3647
7.4L MPI/TBI		0F563052	UP	18-3649	—	18-2917	—	18-3647
7.4L MIE		0C391564	0D715493	18-3649	—	18-2553, 18-2844, 18-2917	—	18-3646
7.4L MIE		0C391564	0F349999	18-3649	—	18-2553, 18-2844, 18-2917	—	18-3646
7.4L MIE		0D715494	0F820141	18-3649	—	18-2553, 18-2844, 18-2917	—	18-3646
7.4L MIE		0F820142	0K999999	18-3649	—	18-2917	—	18-3647
7.4L MIE		0F820142	0K999999	18-3649	—	18-2844, 18-2917	—	18-3647
350 GM		3780450	UP	18-3551	—	18-2844	—	18-3651
350 GM (MAGNUM)		A635178	B525981	18-3551	—	18-2553, 18-2554	—	18-3668
350 GM (MAGNUM)	③	B525982	UP	18-3551	—	18-2553, 18-2554	—	18-3668
350 GM (MAGNUM)	④	B525982	UP	18-3551	—	18-2552, 18-7173	—	18-3668
350 GM (MAGNUM)	④	B525982	UP	18-3649 ⑦	—	18-2552, 18-7173	—	18-3648
350 MIE		3780450	4623109	18-3649	—	18-2844, 18-2917	—	18-3646
370 GM		4179554	6721527	18-3649	—	18-2553, 18-2844, 18-2917	—	18-3646
370 TRS GM		4179554	6721527	18-3551	—	18-2553, 18-2844	—	18-3651
370 TRS GM		6721528	UP	18-3551	—	18-2553, 18-2554	—	18-3668
390 GM		2781129	2825059	18-3551	—	18-2553, 18-2844	—	18-3651
390 GM MCM/MIE		2781129	3042731	18-3649	—	18-2553, 18-2844, 18-2917	—	18-3646
400 GM		4179554	0B457644	18-3649	—	18-2553, 18-2844, 18-2917	—	18-3646
400 TRS GM		4179554	UP	18-3551	—	18-2553, 18-2844	—	18-3651
420 GM		A398941	UP	18-3551	—	18-2553, 18-2844	—	18-3651
420 GM		0A398941	0B622418	18-3649	—	18-2553, 18-2844, 18-2917	—	18-3646
440 TRS GM		4179554	UP	18-3551	—	18-2553, 18-2844	—	18-3651
454 GM MAGNUM/ALPHA	③	A631894	B785148	18-3551	—	18-2553, 18-2554	—	18-3668
454 GM MAGNUM/BRAVO	④	A631894	UP	18-3551	—	18-2552, 18-7173	—	18-3668
454 GM MAGNUM/BRAVO	④	B721206	UP	18-3649 ⑦	—	18-2552, 18-7173	—	18-3648
454 MAG MCM/SKI		0F305000	0K999999	18-3649	—	18-2917	—	18-3647
460 TRS GM		4179554	UP	18-3551	—	18-2553, 18-2844	—	18-3651
470		4208730	6218036	18-3552	—	18-2843	—	18-3652
470		6218037	UP	18-3555	—	18-2555	—	18-3667
485		5685394	UP	18-3552	—	18-2555	—	18-3652
488		6170297	UP	18-3555	—	18-2555	—	18-3667
500(Gen V)		F213293	F615766	18-3551	—	18-2844	18-1994 ⑨	18-3651
502 EFI/MPI MCM		0F8026000	0K999999	18-3649	—	18-2917	—	18-3647
502 MAG MPI		0L017000	UP	18-3649	—	18-2917	—	18-3647
575 GM		0A677429	0D763716	18-3649	—	18-2553, 18-2844, 18-2914	—	18-3646
575		A677429	UP	18-3551	—	18-2553, 18-2844	—	18-3651
8.2L MIE		0D857200	0F350274	18-3649	—	18-2917	—	18-3647
8.2L MIE		0F350275	0F819619	18-3649	—	18-2917	—	18-3647
8.2L MIE		0D857200	0F819619	18-3649	—	18-2844, 18-2917	—	18-3647
8.2L MPI/MIE		0F819620	UP	18-3649	—	18-2917	—	18-3647
888 FORD		3108723	UP	18-3551	—	18-2834	—	18-3651
888 FORD MCM		3108723	4887829	18-3649	—	18-2834	—	18-3646
898/198 GM		4762210	6218461	18-3551	—	18-2844	—	18-3651
898/198 GM MCM/MIE		4762210	6218461	18-3649	—	18-2844, 18-2917	—	18-3646
898 GM		6218462	UP	18-3551	—	18-2553, 18-2554	—	18-3668

- ① Aluminum Manifold
- ② Cast Iron
- ③ Old Design
- ④ New Design
- ⑤ Std. Cooling
- ⑥ Closed Cooling
- ⑦ 160°
- ⑧ S/N 6229718 & up
- ⑨ For stainless steel version use 18-1989



# MERCUISER

## Cooling System



**18-5897**  
**AP# 1942**  
**TEMPERATURE SENDER**  
Replaces: 97257A1  
For Water Temperature  
3/8" - 18 NPT



**18-5898**  
**AP# 1943**  
**TEMPERATURE SENDER**  
Replaces: 97258A1  
For Water Temperature  
1/2" -14 NPT













**18-5899**  
**AP# 1940**  
**OIL SENDER**  
Replaces: 90806, 815425T  
For Oil Pressure

### TEMPERATURE SENDER/OIL SENDER APPLICATION

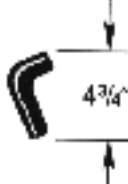
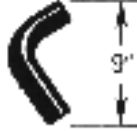
Model	Serial #	Oil Pressure	Water Temperature	Model	Serial #	Oil Pressure	Water Temperature
ROVER	3140000F & UP	—	18-5897	270	2851074-3077735	18-5899	18-5897
110	1565944-1566081	18-5899	18-5898	280	4176250 & UP	18-5899	18-5898
110	1602980 & UP	18-5899	18-5898	300 MR/TRS	6668677 & UP	18-5899 ②	18-5897 ②
120	2324346 & BELOW	18-5899	18-5898	320	A543604 & UP	18-5899 ②	18-5897 ②
120	2324347 & UP	18-5899 ① ②	18-5897 ②	325	2278747 & UP	18-5899	18-5897 ⑥ ⑨
140 (4 cyl/3.0)	2508061 - 3462607	18-5899 ②	18-5897 ②	330	4623115 & UP	18-5899	18-5898
140 (4cyl/3.0)	4512156 & UP	18-5899 ②	18-5897 ②	330/W.B.W.	6083145 & UP	18-5899 ②	18-5897 ②
3.0L/3.0LX	C856559 & UP	18-5899 ②	18-5897 ②	340/7.4L	5889914 & UP	18-5899 ②	18-5897 ②
140 (6 cyl)	1566119-1725960	18-5899	18-5898	350	3780450 & UP	18-5899	18-5898
150	1666495-2048046	18-5899	18-5898	350 (Magnum)	A635178- B525981	18-5899 ②	18-5897 ②
160	2048022-2770031	18-5899	18-5897 ④ ⑤	350 (Magnum)	B525982-0505449	—	18-5897 ② ⑥ ⑦
165	2770032 & UP	18-5899	18-5897	350 (Magnum)	D505450 & UP	18-5899 ②	18-5897 ②
165/3.7L/170/180	6916779 & UP	18-5899	—	370 (TRS)	4179554 & UP	18-5899 ②	18-5897 ②
175 (262 CID)	B527955 & UP	18-5899 ②	18-5897 ② ⑥ ⑦	390	2781129-2825059	18-5899	18-5897
4.3L (Generation II)	D714107 & UP	18-5899 ②	18-5897 ②	400	4179554 & UP	18-5899	18-5897
185 (229 CID)	6330183 & UP	18-5899 ②	18-5897 ②	420/425	A398941 & UP	18-5899 ②	18-5897 ②
185 (262 CID)	A331455 & UP	18-5899 ②	18-5897 ②	440	4179554 & UP	18-5899	18-5897
190	1504311-1730903	18-5899	18-5898	454 (Magnum)	A631894 & UP	18-5899 ②	18-5897 ②
190 (4 cyl)	6916779 & UP	18-5899	—	454 (Bravo)	B721206-D805068	18-5899 ②	18-5897 ② ⑥ ⑦
200	2453769-271202	18-5899	18-5897	460	4179554	18-5899	18-5897
200	6218462 & UP	18-5899 ②	18-5897 ②	465	C849992 & UP	18-5899 ②	18-5897 ②
200/5.0	B525982 & UP	—	18-5897 ② ⑥ ⑦	500	C577254 & UP	18-5899 ②	18-5897 ②
205 (262 CID)	A331455 & UP	18-5899 ②	18-5897 ②	502 (Bravo)	C878221 & UP	18-5899 ②	18-5897 ②
205 (4.3L)	B527955 & UP	18-5899 ②	18-5897 ② ⑥ ⑦	502 (Bravo Gen V)	D824589 & UP	—	18-5897
4.3LX (Generation II)	D714370 & UP	18-5899 ②	18-5897 ②	525	D456000 & UP	18-5899 ②	18-5897 ②
215	2781153 & UP	18-5899	18-5897	575	A677429 & UP	18-5899 ②	18-5899 ②
225 (Ford)	3385721 & UP	18-5899	18-5897	888	3108723 & UP	18-5899	18-5897
225 (GM)	1632308-2694014	18-5899	18-5897 ⑥ ⑨	898	4762210-6218461	18-5899	18-5898
228	4765100-6218461	18-5899	18-5898	898	6218462 & UP	18-5899 ②	18-5897 ②
228 & 230	6218462 & UP	18-5899 ②	18-5897 ②	5.7	A338553-B514626	18-5899 ②	18-5897 ②
230 (I.B.)	5907058 & UP	18-5899 ②	18-5897 ②	5.7	B514627-B525981	18-5899 ②	18-5897 ② ⑥ ⑦
230 (5.0)	B522506 & UP	18-5899 ⑩	18-5897 ⑥ ⑦	5.7 (Bravo)	B525982 & UP	—	18-5897 ⑥ ⑦
233 Ford	4173000 & UP	18-5899	18-5898	7.4 (Bravo)	B771113-D803117	18-5899 ②	18-5897 ② ⑥ ⑦
250	9314301-4908849	18-5899	18-5897 ⑧ ⑨	7.4 (Bravo Gen V)	D803118 & UP	—	18-5897 ②
255	3258728 & UP	18-5899	18-5898	7.4L (Hurth)	ALL	18-5899 ②	18-5897 ②
260	4908850-6218461	18-5899	18-5898	454	D805069 & UP	—	18-5897 ②
260	6218462 & UP	18-5899 ②	18-5897 ②	8.2	C878221-D857199	18-5899 ②	18-5897 ②
260/5.7	B522506 & UP	18-5899 ⑩	18-5897 ⑥ ⑦	8.2	D857200 & UP	—	18-5897 ②
260	5907058 & UP	18-5899 ②	18-5897 ②				

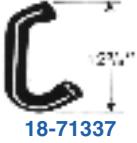
① S/N - 3377341-3461707 & 5192049 & UP      ⑤ 2233574 & Below use 18-5898      ⑧ Electric Choke  
 ② Does not include Dual application      ⑥ (3/8 - 18)      ⑨ Auto Choke  
 ③ S/N 6229718 & UP does not include dual application      ⑦ (1/2 -14) Use 18-5898      ⑩ Thru S/N B525981 only

 <p><b>18-3601</b> <b>AP# 1052</b> <b>WATER SYSTEM HOSE</b> Dia. 5/8" Length 50"</p>	<p><b>NEW</b></p>  <p><b>18-70925</b> <b>AP# 1180</b> <b>MOLDED WATER HOSE</b> Replaces: 32-16021-1 For: 4.3L, 5.0L, &amp; 5.7L For: Thermostat Cover to Port Manifold</p>	<p><b>NEW</b></p>  <p><b>18-70930</b> <b>AP# 1522</b> <b>MOLDED WATER HOSE</b> Replaces: 32-52481 For: GM Inline 4 &amp; 6 cyl. For: Water Distribution Block to End Cap</p>
<p><b>NEW</b></p>  <p><b>18-70928</b> <b>AP# 1515</b> <b>MOLDED WATER HOSE</b> Replaces: 32-71613 For: 5.0L &amp; 5.7L For: Thermostat Housing to Oil Cooler</p>	<p><b>NEW</b></p>  <p><b>18-70929</b> <b>AP# 1516</b> <b>MOLDED WATER HOSE</b> Replaces: 32-73794 For: 5.0L &amp; 5.7L Starboard For: Thermostat Housing to Starboard Manifold</p>	<p><b>NEW</b></p>  <p><b>18-70927</b> <b>AP# 1218</b> <b>MOLDED WATER HOSE</b> Replaces: 32-73795 For: 5.0L &amp; 5.7L Port For: Thermostat Housing to Port Manifold</p>
<p><b>NEW</b></p>  <p><b>18-70926</b> <b>AP# 1181</b> <b>MOLDED WATER HOSE</b> Replaces: 32-73796 For: 5.0L &amp; 5.7L For: Thermostat Cover to Exhaust Elbow</p>	<p><b>NEW</b></p>  <p><b>18-70932</b> <b>AP# 1563</b> <b>MOLDED WATER HOSE</b> Replaces: 32-87117-1 For: 4.3L, 5.0L, &amp; 5.7L Starboard For: Thermostat Cover to Starboard Manifold</p>	<p><b>NEW</b></p>  <p><b>18-70931</b> <b>AP# 1529</b> <b>MOLDED WATER HOSE</b> Replaces: 32-96879 For: 2.5L &amp; 3.0L For: Distribution Block to Water Pump</p>
<b>SINGLE DIAMETER HOSE</b>		
 <p><b>18-70021</b> 3/4" ID</p>	 <p><b>18-70704</b> <b>AP# 1592</b> 1 1/4" ID For: 3.7L</p>	 <p><b>18-70924</b> 1 3/4" ID</p>
 <p><b>18-71218</b> <b>AP# 1514</b> 1" ID For: 230 &amp; 260 MIE</p>	 <p><b>18-71337</b> <b>AP# 1526</b> 1 3/4" ID For: 4.3L, 5.0L, 5.7L Circulating Pump Hose</p>	 <p><b>18-80411</b> 3/4" x 4" x 90° x 6"</p>
<b>STRAIGHT HOSE</b>		
 <p><b>18-75100</b> <b>AP# 1518</b> Straight 48" 1" ID</p>	 <p><b>18-75125</b> Straight 48" 1 1/4" ID</p>	

# MERCUISER

## Cooling System



HOSE INTERCHANGE											
Mercruiser Part#	Sierra Part#	AP Part#	Mercruiser Part#	Sierra Part#	AP Part#	Sierra Part#	AP Part#	Mercruiser Part#	Sierra Part#	AP Part#	Mercruiser Part#
32-12817	18-75125	—	32-87108	18-71337	1526	18-70704	1592	32-89653	18-75100	1518	32-87117 1
32-12818	18-75125	—	32-87116	18-75100	1518	18-71218	1514	32-48132	18-75100	1518	32-89730
32-16021 1	18-75100	1518	32-87117 1	18-75100	1518	18-71337	1526	32-33189	18-75100	1518	32-89749
32-33189	18-71337	1526	32-88795	18-75125	—	18-71337	1526	32-87108	18-75100	1518	32-92836
32-33220-70	18-75100	1518	32-89653	18-70704	1592	18-75100	1518	32-16021 1	18-75125	—	32-12817
32-41940	18-75100	1518	32-89730	18-75100	1518	18-75100	1518	32-33220-70	18-75125	—	32-12818
32-48132	18-71218	1514	32-89749	18-75100	1518	18-75100	1518	32-41940	18-75125	—	32-53461-70
32-52481	18-75100	1518	32-92836	18-75100	1518	18-75100	1518	32-52481	18-75125	—	32-88795
32-53461-70	18-75125	—	32-92837	18-75125	—	18-75100	1518	32-87116	18-75125	—	32-92837

HOSE APPLICATION							
Engine	Serial #	Sierra #	AP #	Engine	Serial #	Sierra #	AP #
175/205(262 CID)	B527955 & Later	18-71337	1526	300 Tempest	6668677 & Later	18-75100/18-71337	1526
198/200/230/260	6218462 & Later	18-75100/18-71337	1526	320 EFI	A543604 & Later	18-75100/18-71337	1526
185/205	A331455 & Later	18-75100/18-71337	1526	350 Mag (Non EFI Models)	A635178 & Later	18-75100/18-71337	1526
260(Log Style)	4908850-6218461	18-75100/18-71337	1526				
230/260/(5.7L)	5907085 & Later	18-75100/18-71337	1526	898(198 HP)	6218462 & Later	18-75100/18-71337	1526
				5.7L(Ski)	A338553 & Later	18-75100/18-71337	1526

## V-BELTS

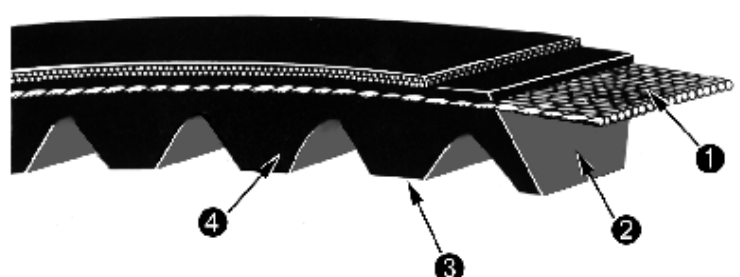

- 1 High strength synthetic cords resist shockload failure. Their low stretch properties assure uniform performance over the life of the belt.
- 2 The compression section is a special rubber compound that assures smooth and even transfer of load forces to the cords.
- 3 Cogs are molded to precise engineering tolerances to improve flexibility and maintain cord support. Cog geometry provides a large area for air circulation to keep the belt cool and prevent damaging heat build up in the cushion section.
- 4 Rubber edges maintain positive, no-slip contact with pulley grooves for reliable energy transfer.

1/0





# MERCUISER Cooling System

## BELT SIZE LISTING BY NUMBER

Sierra#	AP #	Effective Length (Inches)	Top Width (Inches)	Sierra#	AP #	Effective Length (Inches)	Top Width (Inches)
18-15290	1531	29	29/64	18-15435	4304	43 1/2	29/64
18-15300	—	30	29/64	18-15440	—	44	29/64
				18-15450	—	45	29/64
18-15325	1555	32 1/2	29/64				
18-15345	1553	34 1/2	29/64	18-15455	—	45 1/2	29/64
18-15370	1549	37	29/64	18-15460	1540	46	29/64
18-15380	—	38	29/64	18-15470	1556	47	29/64
18-15390	—	39	29/64				
				18-15480	1542	48	29/64
18-15400	—	40	29/64	18-15495	1557	49 1/2	29/64
18-15405	—	40 1/2	29/64	18-15500	1558	50	29/64
18-15410	1548	41	29/64	18-15520	1535	52	29/64
18-15415	1661	41 1/2	29/64				
				18-15525	—	52 1/2	29/64
18-15430	—	43	29/64	18-15550	1532	55	29/64

## V-BELT INTERCHANGE

MerCruiser Part#	Sierra Part#	AP Part#	MerCruiser Part#	Sierra Part#	AP Part#	Sierra Part#	AP Part#	MerCruiser Part#	Sierra Part#	AP Part#	MerCruiser Part#
57-13457	18-15290	1531	57-57298	18-15280	—	18-15290	1531	57-13457T	18-15430	—	57-49211
57-13457T,Q	18-15290	1531	57-64032A1	18-15410	1548			57-13457	18-15435	4304	57-64416
57-13458T	18-15550	1532	57-64416	18-15435	4304	18-15300	—	57-49756	18-15440	1544	57-49213A1
57-32850	18-15400	1551	57-65607T	18-15370	1549	18-15325	1555	57-77274A1	18-15440	1544	57-93658
57-33170	18-15520	1535	57-69143T	18-15400	1551	18-15345	1553	57-74271T	18-15440	1659	57-45856
57-36356	18-15415	1661	57-74271T	18-15345	1553	18-15370	1549	57-65607T	18-15460	1540	57-48120A1
57-37619T,Q	18-15520	1535	57-76269	18-15405	—	18-15390	—	57-52692	18-15470	1556	57-78200A1
57-45856	18-15440	1659	57-77274A1	18-15325	1555	18-15400	1551	57-32850	18-15480	1542	57-48122
57-48120A1	18-15460	1540	57-78200A1	18-15470	1556	18-15400	1551	57-69143T	18-15495	1557	57-91035A1
57-48122	18-15480	1542	57-91035A1	18-15495	1557	18-15405	—	57-76269	18-15500	1558	57-96834T,Q
57-49043A1	18-15410	1548	57-93658	18-15440	1544	18-15410	1548	57-49043A1	18-15520	1535	57-33170,Q
57-49211	18-15430	—	57-96834T,Q	18-15500	1558	18-15410	1548	57-64032A1	18-15520	1535	57-37619T
57-49213A1	18-15440	1544	57-96834	18-45500	1558	18-15410	1548	57-98043	18-15550	1532	57-13458T
57-49756	18-15300	—	57-98043	18-15410	1548	18-15415	1661	57-36356			
57-52692	18-15390	—	57-57298	18-15280	1546						



# MERCUISER

## Cooling System



### V-BELT APPLICATION

Engine	Years	Serial #	Sierra Alternator/ Water Pump	Sierra Power Steering	Sierra Sea Water Pump
110	1963-66	1537370-2044033	18-15410	—	—
120	1964-73	1666601-3770649	18-15410	—	—
120	1974-82	3770650-6229717	18-15410	18-15370 (37")	—
120	1974-82	3770650-6229717	18-15410	18-15400 (40")	—
120(2.5L)	1982-89	6229718 - C853255	18-15410	—	—
120(2.5L)	1982-89	6229718 - C853255 W/P/S	18-15400	18-15370	—
140	1968-73	2508261-3770649	18-15410	—	—
140	1974-82	3770650-6229717	18-15410	18-15370 (37")	—
140	1974-82	3770650-6229717	18-15410	18-15400 (40")	—
140/3.0L/3.0LX	1982-newer	6229718 & UP	18-15410	—	—
140/3.0L/3.0LX	1982-newer	6229718 & UP W/P/S	18-15400	18-15370	—
150	1964-66	1666495-2048646	18-15410	—	—
160	1967-69	2048022-2770031	18-15410	—	—
165	1970-73	2770032 - 3774864	18-15410	—	—
165	1974-81	3774865 - 5813433	18-15410	18-15370 (37")	—
165	1974-81	3774865 - 5813433	18-15410	18-15400 (40")	—
165/170/180/190/3.7L	1985-89	6916779 - C762299	—	18-15410	—
470 (170HP)	1976-82	4208730 - 6218036	—	18-15405	—
470 (170HP)	1983-84	6218037 - 6916778	—	18-15410	—
488	1983-84	6170297 - 6916778	—	18-15410	—
175/185/4.3L	1985-92	A331455 - D714106	18-15440	18-15520	18-15345
4.3L	1992-96	D714107 - F802999	18-15460	—	18-15290
888	1971-77	3108723-4887829	18-15440	—	—
888	1971-77	3108723 - 4887829	18-15440	18-15290 (30")	18-15440
898 W/O HIGH MT P/S	1977-84	4762210 - 6218461	18-15460	18-15325	18-15345
898 W/ HIGH MT P/S	1977-84	4762210 - 6218461	18-15440	18-15495	18-15345
898/200/5.0L	1985-95	6218462 - F600999	18-15440	18-15495	18-15345 w/ closed cooling
898/200/5.0L	1985-95	6218462 - F600999	18-15460	18-15520	18-15290 w/o closed cooling
200	1969	2453769 - 2712072	18-15410	—	—
205	1985-1991	A331455-D714369	18-15440	18-15520	18-15345
215	1970-72	2781153-3563181	18-15440	—	—
215 MIE	1970-72	2781153-3563181	18-15440	—	—
225	1973-74	3385721 - 4166999	18-15440	18-15520	18-15345
225 MIE	1973-74	3385721 - 4166999	18-15440	—	18-17350
225 MCM/MIE	1967-69	2278647 - 2694014	18-15460	—	—
228 W/O HIGH MT P/S	1977-82	4765100-6218461	18-15460	18-15325	18-15345
228 W/ HIGH MT P/S	1977-82	4765100-6218461	18-15440	18-15495	18-15345
228/230/5.0L	1983-95	6218462 - F600999	18-15440	18-15495	18-15345 w/ closed cooling
228/230/5.0L	1983-95	6218462 - F600999	18-15460	18-15520	18-15290 w/o closed cooling
228 MIE	1977	4765100 - 4929030	18-15460	—	18-15325
228/230/5.0L MIE	1978-87	4929030 - B788151	18-15440	18-15495	18-15345 w/stamped steel pulley
228/230/5.0L MIE	1978-87	4929030 - B788151	18-15460	18-15520	18-15290 w/cast alum. Pulley
233	1975-77	4173000-4902304	18-15440	—	—
233	1975-77	4173000-4902304	18-15440	18-15290	18-15345 w/stamped steel pulley
233 MIE	1975-76	4173000-4775784	18-15440	—	—
250	1968-69	2314301-2639854	18-15460	—	—
250	1977	4768000 - 4908849	18-15440	18-15345	18-15345
255 MCM/MIE	1973-74	3258728 - 4175499	18-15440	18-15280	—
255	1975-76	4175500 - 4498700	18-15460	18-15300	18-17343
255	1976	4498701-4499060	18-15460	18-15315	18-17345
255	1976	4499061-4767999	18-15460	—	18-17345
255 MIE	1975-77	4175500 - 4498700	18-15460	—	18-17343
255 MIE	1977-78	4498701 - 4924564	18-15460	—	18-15345
255/260/5.7L MIE & Ski	1978-86	4924565 - B522505	18-15440	—	18-15345
260/5.7L MIE & Ski	1987-93	B522506 - F024999	18-15440	—	18-15345 w/stamped steel pulley
260/5.7L MIE & Ski	1987-93	B522506 - F024999	18-15460	—	18-15290 w/cast alum. Pulley
5.7L MIE & Ski	1994-96	F025000 - K040306	18-15460	N/A	18-15290
260 W/HM P/S	1978-82	4908850 - 6218461	18-15440	18-15495	18-15345



# MERCUISER Cooling System

## V-BELT APPLICATION (Cont.)

Engine	Years	Serial #	Sierra Alternator/ Water Pump	Sierra Power Steering	Sierra Sea Water Pump
260 W/LM P/S	1978-82	4908850 - 6218461	18-15460	—	18-15345
260/5.7L	1983-95	6218462 - F600999	18-15440	18-15495	18-15345 w/ closed cooling
260/5.7L	1983-95	6218462 - F600999	18-15460	18-15520	18-15290 w/o closed cooling
5.7L/5.7LX	1996	F601000 - K001505	18-15460	—	18-15290
350 MAG	1986-95	A635178 - F600999	18-15440	18-15520	18-15345 w/ closed cooling
350 MAG	1986-95	A635178 - F600999	18-15460	—	18-15290 w/o closed cooling
350 MAG	1996	F601000 - K001500	18-15460	—	18-15290
350 MAG Ski	1991-96	D505450 - K040005	18-15460	—	18-15290
Black Scorpion Ski	1996	F800000 - K040000	18-15460	—	18-15290
270 MCM/MIE	1969-72	2851074 - 3385720	18-15460	—	—
280	1975	4176250 - 4176468	18-15460	18-15300	18-17343
280	1975-76	4176469 - 4499390	18-15460	18-15300	18-17345
280	1976	4499391 - 4499780	18-15460	—	18-17345
280	1976	4499781 - 4770199	18-15460	18-15325	18-17345
320(EFI)	1987-89	A543604 - C622418	18-15440	18-15520	18-17345
325 MCM/MIE	1968-74	2278747 - 3780449	18-15480	—	18-17343
330	1977-81	4623115-6083144	18-15470	—	18-15345
330	1982-87	6083144 - B816540	18-15470	18-15500 (50")	18-15345 w/stamped steel pulley
330	1982-87	6083144 - B816540	18-15470	18-15550 (55")	18-15290 w/cast alum. Pulley
340 (7.4L)	1981-92	5889914 - D715493	18-15470	—	18-15345 w/stamped steel pulley
340 (7.4L)	1981-92	5889914 - D715493	18-15470	—	18-15290 w/cast alum. Pulley
350 MIE	1974-75	3780450-4501640	18-15480	—	18-17343
350 MIE	1976	4501641 - 4623109	18-15480	—	18-15345
7.4L BRAVO	1988-91	B771113 - D603117	18-15470	18-15550	18-15290
7.4L BRAVO	1988-91	B771113 - D603117	18-15480	—	18-15290
7.4L/LX BRAVO	1992-97	D603118 - K999999	18-15480	—	18-15400
7.4LX Bravo (TBI)	1996-97	F820000 - K999999	18-15480	—	18-15290
7.4LX Bravo (MPI)	1996-97	F602010 - K147349	18-15480	—	18-15400
7.4LX Bravo (MPI)	1997	K147350 - K999999	18-15480	—	18-15290
7.4L MIE	1989-92	C391564 - D715493	18-15470	—	18-15290
7.4L MIE	1989-92	C391564 - D715493	18-15480	—	18-15290
7.4L MIE	1992-97	C391564 - K999999	18-15480	—	18-15400
454 MAG Alpha	1986-88	A631894 & UP	18-15470	18-15500 (50")	—
454 MAG Alpha	1986-88	A631894 & UP	18-15470	18-15550 (55")	—
454 MAG	1988-92	B721206 - D805068	18-15470	18-15550	18-15290
454 MAG	1988-92	B721206 - D805068	18-15480	—	18-15290
454 MAG	1992-97	D805069 - K999999	18-15480	—	18-15400
454 MAG (MPI)	1994-97	F115700 - K147349	18-15480	—	18-15400
454 MAG (MPI)	1997	K147350 - K999999	18-15480	—	18-15290
454 MAG Ski	1995-97	F215800 - K999999	18-15480	—	18-15400
370(TRS)	1978-85	4179554 - 6721527	18-15480	—	18-17343
370(TRS)	1985-87	6721528 - B714586	18-15480	18-15500	18-17345
390 MCM/MIE	1969-70	2781129 - 3042731	18-15480	—	—
400 (TRS)	1980-86	4179554 - B457644	18-15480	—	18-17343
420/425	1987-92	A398941 - D725499	18-15480	18-15500	18-17345
420/425	1992	D725500 - D937011	18-15480	—	18-15400
440 (TRS)	1983-86	4179554 - B485220	18-15480	—	18-17343
450	1995-96	F347100 - F347227	18-15480	—	18-15400
460 (TRS)	1983-86	4179554 - 6181046	18-15480	—	18-17343
502 MAG	1990-97	C878221 - D824588	18-15480	—	18-15290
502 MAG	1990-97	C824589 - K999999	18-15480	—	18-15400
502 MAG (MPI)	1994-97	D840650 - K147349	18-15480	—	18-15400
502 MAG (MPI)	1997	K147350 - K999999	18-15480	—	18-15290
8.2L MIE	1990-93	C878221 - D857199	18-15480	—	18-15290
8.2L MIE	1993-97	D857200 - K999999	18-15480	—	18-15400
8.2L MPI MIE	1996-97	F819620 - K147349	18-15480	—	18-15400
8.2L MPI MIE	1997	K147350 - K999999	18-15480	—	18-15290

1/0

**NEW** **SERPENTINE BELTS** **NEW**



**BELT INTERCHANGE**

Sierra No.	O E	O E No.	Width	Length	Sierra No.	O E	O E No.	Width	Length
18-15100	Mercruiser	57-863876 3	26/32	52	18-15113	Mercruiser	57-807755-5	26/32	36.5
18-15101	Mercruiser	57-863876 4	26/32	37	18-15114	Mercruiser	57-861049	26/32	51
18-15102	Mercruiser	57-863876 6	26/32	51.5	18-15115	Mercruiser	57-861757	26/32	47.5
18-15103	Mercruiser	57-863876 7	26/32	47	18-15116	Mercruiser	57-861758	26/32	42
18-15104	Mercruiser	57-863876 8	26/32	48.5	18-15117	Mercruiser	57-861759	26/32	45
18-15105	Mercruiser	57-863876 9	26/32	33.5	18-15119	Mercruiser	57-863876 1	26/32	53
18-15112	Mercruiser	57-807755-4	26/32	42.5	18-15120	Mercruiser	57-863876 2	26/32	43.5

**BELT APPLICATION**

Engine	Years	Serial #	Sierra #	Mercruiser #	Footnote	Engine	Years	Serial #	Sierra #	Mercruiser #	Footnote
4.3L Alpha	1996-99	OF803000-OL618999	18-15113	57-807755-5	4	5.7L Alpha	2002-04	OM600000 & up	18-15102	57-863876 6	3, 5, 7
4.3L Alpha	1996-99	OF803000-OL618999	18-15116	57-861758	2, 6	5.7L Alpha	2000-04	OL619000 & up	18-15104	57-863876 8	4, 5, 7
4.3L Alpha	1996-99	OF803000-OL618999	18-15117	57-861759	2, 5	5.7L Alpha	2000-04	OL619000 & up	18-15105	57-863876 9	4, 6, 7
4.3L Alpha	2000-04	L619000 & up	18-15101	57-863876 4	3, 6, 7	5.7L Bravo	1997-99	OK001506-OL618999	18-15114	57-861049	2, 5
4.3L Alpha	2000-04	OL619000 & up	18-15104	57-863876 8	4, 5, 7	5.7L Bravo	1997-99	OK001506-OL618999	18-15115	57-861757	2, 6
4.3L Alpha	2000-04	OL619000 & up	18-15105	57-863876 9	4, 6, 7	5.7L Bravo	2002-04	OM600000 & up	18-15102	57-863876 6	3, 5, 7
4.3L Bravo	1996-99	OF803000-OL618999	18-15114	57-861049	2, 5	5.7L Bravo	2000-04	OL619000 & up	18-15104	57-863876 8	4, 7
4.3L Bravo	1996-99	OF803000-OL618999	18-15115	57-861757	2, 6	5.7L Ski	1997-02	K040004-M316999	18-15112	57-807755 4	
4.3L Bravo	2000-04	OL619000 & up	18-15104	57-863876 8	4, 7	377 Scorpion MCM	1999-04	OL416146 & up	18-15115	57-861757	
5.0L Bravo	2002-04	OM600000 & up	18-15102	57-863876 6	3, 5, 7	377 Scorpion Ski	1997-98	K000656 & up	18-15112	57-807755 4	
5.0L Alpha	1998-99	OL012052-OL618999	18-15113	57-807755-5	4, 6	454 Mag MPI	1998-01	OL010029-OM024999	18-15114	57-861049	1
5.0L Alpha	1998-99	OL012052-OL618999	18-15114	57-861049	5	454 Mag MPI	1998-01	OL010029-OM024999	18-15102	57-863876 6	2
5.0L Alpha	1998-99	OL012052-OL618999	18-15116	57-861758	2, 6	454 Mag MPI	1998-01	OL010029-OM024999	18-15103	57-863876 7	4
5.0L Alpha	2000-04	OL619000 & up	18-15102	57-863876 4	3, 6, 7	454 Mag MPI Horizon MIE	1998-01	OL002200-OL674000	18-15103	57-863876 7	
5.0L Alpha	2002-04	OM600000 & up	18-15102	57-863876 6	3, 5, 7	496 Mag & HO	2000-04	OM025000 & up	18-15119	57-863876 1	
5.0L Alpha	2001-04	OL619000 & up	18-15104	57-863876 8	4, 5, 7	500 EFI	1999-04	L001477 & up	18-15112	57-807755 4	
5.0L Alpha	2000-04	OL619000 & up	18-15105	57-863876 9	4, 6, 7	502 Mag MPI	1998-01	OL017000-OM024999	18-15114	57-861049	1
5.0L Bravo	1998-99	OL012052-OL618999	18-15114	57-861049	2, 5	502 Mag MPI	1998-01	OL017000-OM024999	18-15103	57-863876 7	4
5.0L Bravo	1998-99	OL012052-OL618999	18-15115	57-861757	2, 6	502 Mag MPI	1998-01	OL017000-OM024999	18-15102	57-863876 6	2
5.0L Bravo	2000-04	OL619000 & up	18-15104	57-863876 8	4, 7	525 EFI	2003-04	OM900146 & up	18-15120	57-863876 2	
350 Mag, Alpha	1997-04	OK001501-OL618999	18-15113	57-807755-5	4, 6	575 Sci	2000-04	OL306696 & up	18-15113	57-807755 4	
350 Mag, Alpha	1997-04	OK001501-OL618999	18-15114	57-861049	2, 5	7.4L MPI	1998-01	OL010003-OM024330	18-15114	57-861049	1
350 Mag, Alpha	1997-04	OK001501-OL618999	18-15116	57-861758	2, 6	7.4L MPI	1998-01	OL010003-OM024330	18-15102	57-863876 6	2
350 Mag, Alpha	2000-04	OL619000 & up	18-15103	57-863876 4	3, 6, 7	7.4L MPI	1998-01	OL010003-OM024330	18-15103	57-863876 7	4
350 Mag, Alpha	2002-04	OM600000 & up	18-15102	57-863876 6	3, 5, 7	7.4L MPI MIE	1998-01	OL002006-OM025999	18-15103	57-863876 7	
350 Mag, Alpha	2000-04	OL619000 & up	18-15104	57-863876 8	4, 5, 7	Black Scorpion Ski	1997-01	K040001-M391599	18-15112	57-807755 4	
350 Mag, Alpha	2000-04	OL619000 & up	18-15105	57-863876 9	4, 6, 7	MX 6.2L Blk Scorpion Ski	2001	L670015-M391599	18-15112	57-807755 4	
350 Mag, Bravo	1997-04	OK001501-OL618999	18-15114	57-861049	2, 5	MX 6.2L MPI	2002-04	OM600000 & up	18-15102	57-863876 6	3, 5
350 Mag, Bravo	1997-04	OK001501-OL618999	18-15115	57-861757	2, 6	MX 6.2L MPI	2000-04	OL680003 & up	18-15104	57-863876 8	4, 7
350 Mag, Bravo	2002-04	OM600000 & up	18-15102	57-863876 6	3, 5, 7	MX 6.2L MPI Horizon	2002-04	OM600000 & up	18-15102	57-863876 6	3
350 Mag, Bravo	2000-04	OL619000 & up	18-15104	57-863876 8	4, 7	MX 6.2L MPI Horizon	2001-04	OM300000 & up	18-15104	57-863876 8	4
5.7L Alpha	1997-99	OK001506-OL618999	18-15113	57-807755-5	4, 6	MX 6.2L MPI Horizon MIE	2001	M300000-M310099	18-15112	57-807755 4	
5.7L Alpha	1997-99	OK001501-OL618999	18-15114	57-861049	2, 5	MX 6.2L MPI MIE	1999-01	L670000-M310099	18-15112	57-807755 4	
5.7L Alpha	1997-99	OK001506-OL618999	18-15116	57-861758	2, 6	8.1S MPI MIE & HO	2000-04	OM025000 & up	18-15120	57-863876 2	
5.7L Alpha	2000-04	OL619000 & up	18-15104	57-863876 4	3, 6, 7	8.2L MPI MIE	1998-01	OL002450-OL674200	18-15103	57-863876 7	

**Footnote**

- 1: Use with plastic 4-3/4" dia. p/s pump pulley
- 2: Use with metal 5-3/4" dia. p/s pump pulley
- 3: For engines with power steering
- 4: For engines without power steering
- 5: For engines with closed cooling
- 6: For engines with standard cooling
- 7: Engines with high mounted alternators







# MERCUISER



## Features...

- ★ Manifolds cast by the leading gray-iron foundries in the United States of America.
- ★ Built to exact OEM specifications. Guaranteed to fit, function and install precisely.
- ★ Manifolds are ready to be installed out of the box.
- ★ New e-coat painting process promotes better paint adhesion and provides superior corrosion resistance.
- ★ Many manifolds feature semi-tuned runners for increased performance at no additional cost.
- ★ All manifolds packed to resist damage during shipping and handling.
- ★ Backed by Sierra's famous comprehensive warranty.
- ★ 100% leak tested.

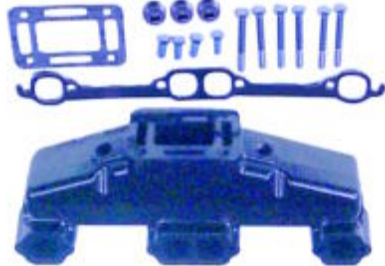
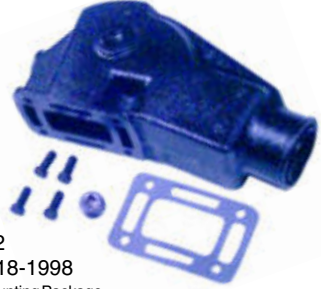
### ALL MANIFOLDS ARE PAINTED, PACKAGED AND LEAK TESTED

  <p><b>18-1979 EXHAUST MANIFOLD</b></p> <p>Universal Center Rise Manifold For: FOrd Small Block V8 221, 255, 260, 289, 302 and 351 Use: 18-8541 Mounting Kit</p>	 <p><b>18-1998-1 AP# 5504 EXHAUST MANIFOLD</b></p> <p>Replaces: Barr FM-1-83</p> <p>Universal Center Riser Manifold <b>FITS: Ford 302 and 351 CID engines</b> Comes with 18-4363/AP# 13311 Mounting Package - Replaces: Barr FM 1-83-P Use 18-0603/AP# 1721 Exhaust Manifold Gasket Set</p>
 <p><b>18-1997-1 AP# 5517 EXHAUST MANIFOLD</b></p> <p>Replaces: Barr CHV-1-83 Universal Center Riser Manifold <b>FITS: GM 283, 305, 307 and 350 CID engines</b> Use 18-0604/AP# 1808 Exhaust Manifold Gasket Set</p>	 <p><b>18-1999 AP# 5705 EXHAUST MANIFOLD RISER</b></p> <p>Replaces: Barr 200-0082 For use with 18-1997 or 18-1998 Comes with 18-4364/AP# 13312 Mounting Package - Replaces: Barr 20-0082-P Use 18-2854/AP# 5517 Riser Gasket</p>
 <p><b>18-1951-1* AP# 5509 MANIFOLD</b></p> <p>Supplied with Mounting Package Replaces: 77235A2, A8 STARBOARD SIDE Fits most Mercruiser (GM) small blocks with end riser</p>	 <p><b>18-1950-1* AP# 5508 MANIFOLD</b></p> <p>Supplied with Mounting Package Replaces: 77234A2 PORT SIDE Fits most Mercruiser (GM) small blocks with end riser</p>









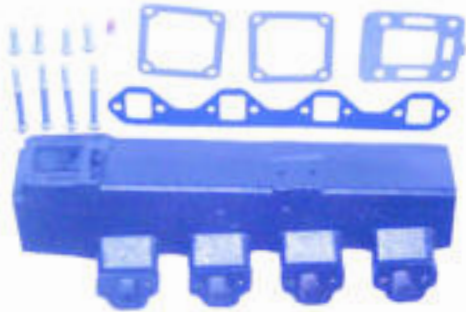

# MERCUISER

## Cooling System

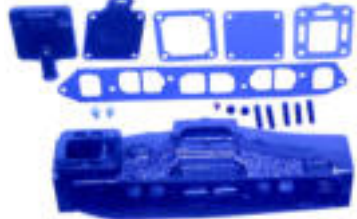
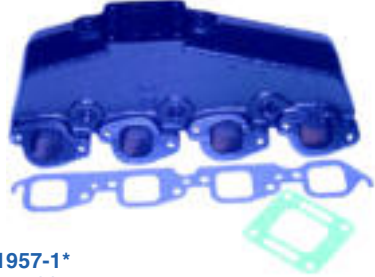

 <p><b>18-1952-1*</b> <b>AP# 5505</b> <b>MANIFOLD</b> Replaces: 99746A8, A17 Fits most 4.3L (262 CID) V-6 application</p>	 <p><b>18-1953-1</b> <b>AP# 5500</b> <b>MANIFOLD</b> Supplied with Mounting Package Replaces: 87114A19,86024A10 Will fit either side - Fits most Mercruiser(GM) small blocks with center riser. Supplied with gaskets</p>	
 <p><b>18-1954-1*</b> <b>AP# 5502</b> <b>MANIFOLD</b> Supplied with Mounting Package Replaces: 95862A5 Fits most late Model 2.5L 153 CID &amp; 3.0L 181 CID with Rochester Carb 5 BOLT PATTERN</p>	 <p><b>18-1958*</b> <b>AP# 5511</b> <b>MANIFOLD</b> Replaces: 65604A4, A12 PORT SIDE ONLY Fits most Mercruiser (Ford) V-8 small blocks</p>	
 <p><b>18-1955-1*</b> <b>AP# 5501</b> <b>MANIFOLD</b> <b>New Style</b> Supplied with Mounting Package Replaces: 96705A1 Fits most early Model 3.0L 181 CID with Rochester Carb. 5 BOLT PATTERN</p>	 <p><b>18-1956-1*</b> <b>AP# 5503</b> <b>MANIFOLD</b> Supplied with Mounting Package Replaces: 99798A18, 806867A8 Fits most late Model 2.5L 153 CID and 3.0L 181 CID with MerCarb 5 BOLT PATTERN</p>	 <p><b>18-1957-1*</b> <b>AP# 5506</b> <b>MANIFOLD</b> Replaces: 89011A8, 807078A6 WILL FIT EITHER SIDE Fits most Mercruiser (GM) V-8 big blocks with center riser</p>
<p><b>18-1987 AP# 5499 EXHAUST MANIFOLD CONVERSION KIT</b> Not for use on engines with high mounted power steering pumps</p> <p><b>KIT INCLUDES:</b></p> <ul style="list-style-type: none"> <li>2 Center rise manifolds</li> <li>2 Exhaust elbows</li> <li>1 Thermostat housing</li> <li>1 Thermostat cover</li> <li>1 Thermostat</li> </ul> <p>All hoses, hardware, gaskets plus complete instructions to do the job right!</p>  <p><i>This Manifold Kit is designed to convert all Mercruiser Stern Drive Engines with GM 305 &amp; 350 CID Blocks that have Log Style Exhaust Manifolds and Raw Water Cooling to the Newer More Efficient Center Rise Manifolds</i></p> <p>* SEE APPLICATION CHART ON PAGE 558 FOR SPECIFIC MODELS</p>		









 <p><b>18-1960-1*</b> <b>AP# 5528</b> <b>MANIFOLD</b> Replaces: 58759A10, A14 Fits most Mercruiser (GM) Inline 6 Cyl. Engines</p>	 <p><b>18-1962*</b> <b>AP# 5510</b> <b>MANIFOLD</b> Replaces: 65603A4, A12 STARBOARD SIDE ONLY Fits most Mercruiser Engines (Ford) V-8 Small blocks</p>
 <p><b>NEW</b></p> <p><b>18-1898</b> <b>MANIFOLD</b> Replaces: Barr CHVA-1-84 &amp; Marine Power 0991-110 Fits 454 cu. in. GM big block V8 engines</p>	 <p><b>18-1964</b> <b>MANIFOLD</b> GM Small Block V8 265, 283, 305, 307, 327, 350, &amp; 400 cu. in.</p>
 <p><b>18-1970-1*</b> <b>AP# 5700</b> <b>ELBOW</b> Replaces: 98504A3 Fits V-6 &amp; V-8 applications 15" (3" O.D. Riser)</p>	 <p><b>18-1971*</b> <b>AP# 5701</b> <b>ELBOW</b> Replaces: 76351A2 Fits most early Model Mercruiser 140 HP (4 cyl) applications <b>Use Mounting Package 18-4362/AP# 13310</b> Replaces: Barr MC20-60426P</p>
 <p><b>18-1992-1</b> <b>AP# 5016</b> <b>80° EXHAUST ELBOW</b> For 3" I.D. Exhaust Hose (As used in 18-1987 Exhaust Manifold Conversion Kit)</p>	 <p><b>18-1972*</b> <b>AP# 5703</b> <b>ELBOW</b> Replaces: 76325A2 Fits most late Model 120, 140 HP Mercruiser applications</p>
 <p><b>18-1973*</b> <b>AP# 5702</b> <b>ELBOW</b> Replaces: 55538A2 Fits most early Model 120 HP Mercruiser applications</p>	 <p><b>18-1978</b> <b>AP# 5707</b> <b>ELBOW</b> Replaces: 76771A3, A2 V-8 Inboard Applications Only Use with 18-1950-1, 18-1951-1, 18-1958/AP# 5511, 18-1962/AP# 5510 Manifolds and 18-2833/AP# 398 Elbow Gasket</p>

\* SEE APPLICATION CHART BEGINNING ON PAGE 558 FOR SPECIFIC MODELS











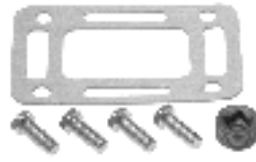

# MERCURISER Cooling System

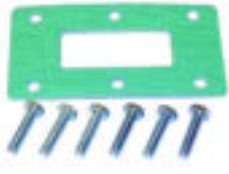

 <p><b>18-1905 Elbow</b> Mercuriser 4 Cylinder 224cu. in. 3.7L (Models: 165, 170, 180, 190). Used with: Mercuriser 99908 Manifold Replaces: Mercuriser 90880</p>	 <p><b>18-1937 Elbow</b> Mercuriser 4 Cylinder 224cu. in. 3.7L (Models: 165, 170, 180, 190). Replaces: Mercuriser 98561</p>																																					
<p><b>NEW</b></p>  <p><b>18-1980 RISER</b> 10° down angle For: Ford Small Block V8 221, 255, 260, 289, 302 and 351; GM Small Block V8 265, 283, 305, 307, 327, 350 and 400; GM Big Block 369, 427 and 454; For use with 18-1979 &amp; 18-1964 Manifolds: Use 18-8542 Mounting Kit</p>	<p><b>NEW</b></p>  <p><b>18-1981 RISER</b> 30° down angle For: Ford Small Block V8 221, 255, 260, 289, 302 and 351; GM Small Block V8 265, 283, 305, 307, 327, 350 and 400; GM Big Block 369, 427 and 454; For use with 18-1979 &amp; 18-1964 Manifolds: Use 18-8542 Mounting Kit</p>	 <p><b>18-1974-1* AP# 5733 RISER</b> Replaces: 98502A2 Fits V-6 &amp; V-8 applications 0° (3" O.D. Riser)</p>																																				
 <p><b>18-1975* AP# 5726 RISER</b> Replaces: 12076A2 Fits late Model Mercuriser 4 cyl. Engines</p>	 <p><b>18-1976-1* AP# 5706 RISER</b> Replaces: 44354A3, 807988A2 Fits most Mercuriser V-6 &amp; V-8 applications 7° (4" O.D. Riser)</p>	 <p><b>18-1939 RISER</b> Barr, Indmar and Marine Power Ford Small Block V8 302-351cu. in. GM Small Block V8 305-350cu. in., GM Big Block V8 454cu in. Replaces: Barr 20-0100 &amp; Marine Power 0992-593</p>																																				
 <p><b>18-1907 RISER</b> Barr, Indmar Ford Small Block V8 302-351cu. in. Replaces: Barr 20-0102 &amp; Indmar 53-2009 and 53-2018</p>	 <p><b>18-1908K AP# 5751 RISER</b> Replaces: 807476A6, 93320A5 Complete with Mounting Hardware Center Rise 3" PACKAGED AS SET</p>	<p><b>NEW</b></p>  <p><b>18-3530 THERMOSTAT HOUSING</b> Replaces: 860256A4 For: GM V6 and V8 (305 &amp; 350 ci) with Bravo Drive or MIE</p>	<p><b>NEW</b></p>  <p><b>18-3678 THERMOSTAT HOUSING</b> Replaces: 90736A18 For: GM 370, 425, 454 Mag &amp; 465 V8</p>																																			
<p><b>NEW</b></p>  <p><b>18-1989 THERMOSTAT HOUSING</b> Replaces: 860256A4 For: GM V8 454-502ci engines</p>	 <p><b>18-1977* AP# 5009 THERMOSTAT HOUSING</b> Replaces: 47441A1 Fits 225, GM 260, 228, 898/198, 185R, 898R, 228R, 2GR</p>	<p><b>NEW</b></p>  <p><b>PIPE PLUGS</b></p> <table border="1"> <thead> <tr> <th>Sierra#</th> <th>AP#</th> <th>Replaces</th> <th>Thread Size</th> <th>Description</th> </tr> </thead> <tbody> <tr> <td>18-4257</td> <td>5188</td> <td>—</td> <td>1/4"</td> <td>Blacksteel Plug</td> </tr> <tr> <td>18-4258</td> <td>5151</td> <td>—</td> <td>3/4"</td> <td>Blacksteel Plug</td> </tr> <tr> <td>18-4263</td> <td>5181</td> <td>22-32802, 23-328022</td> <td>1/8" - 27 NPT</td> <td>Pipe Plug</td> </tr> <tr> <td>18-4264</td> <td>5182</td> <td>22-32803</td> <td>3/8" - 18 NPT</td> <td>Pipe Plug</td> </tr> <tr> <td>18-4265</td> <td>—</td> <td>22-42861-1</td> <td>3/4" - 14 NPT</td> <td>Pipe Plug</td> </tr> <tr> <td>18-8111</td> <td>5153</td> <td>22-36392</td> <td>1/4" - 18 NPT</td> <td>Pipe Plug</td> </tr> </tbody> </table> <p><b>18-9004/AP# 3914</b> Pipe Sealant with Teflon is recommended for use on plug threads.</p>	Sierra#	AP#	Replaces	Thread Size	Description	18-4257	5188	—	1/4"	Blacksteel Plug	18-4258	5151	—	3/4"	Blacksteel Plug	18-4263	5181	22-32802, 23-328022	1/8" - 27 NPT	Pipe Plug	18-4264	5182	22-32803	3/8" - 18 NPT	Pipe Plug	18-4265	—	22-42861-1	3/4" - 14 NPT	Pipe Plug	18-8111	5153	22-36392	1/4" - 18 NPT	Pipe Plug	 <p><b>18-4363 AP# 13311 MOUNTING PACKAGE</b> Replaces: Barr FM-1-83-P Use with 18-1998-1</p>
Sierra#	AP#	Replaces	Thread Size	Description																																		
18-4257	5188	—	1/4"	Blacksteel Plug																																		
18-4258	5151	—	3/4"	Blacksteel Plug																																		
18-4263	5181	22-32802, 23-328022	1/8" - 27 NPT	Pipe Plug																																		
18-4264	5182	22-32803	3/8" - 18 NPT	Pipe Plug																																		
18-4265	—	22-42861-1	3/4" - 14 NPT	Pipe Plug																																		
18-8111	5153	22-36392	1/4" - 18 NPT	Pipe Plug																																		

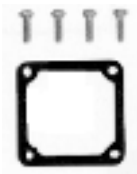
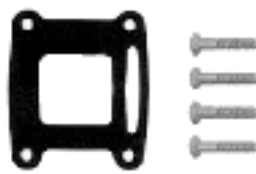
1/1

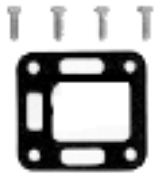

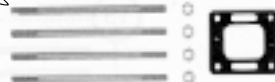











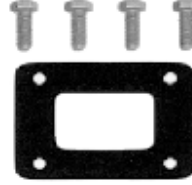



 <p><b>18-4364</b> <b>AP# 13312</b> <b>MOUNTING PACKAGE</b> Replaces: Barr 20-0082-P Use with 18-1999/AP#5705</p>	 <p><b>18-4362</b> <b>AP# 13310</b> <b>MOUNTING PACKAGE</b> Replaces: Barr MC20-60426P Use with 18-1971/AP#5701</p>	 <p><b>NEW</b> <b>18-8514</b> <b>MOUNTING KIT</b> Mercuriser Ford Small Block V8 302-351cu.in. (Models: 215, 225, 233, 255, 888), GM Small Block V8 305-351cu.in. (Models: 198, 228, 898) Used with: 18-1971 &amp; 18-1978 Risers (Not for Fresh Water/Closed Cooling Systems)</p>
 <p><b>NEW</b> <b>18-8554</b> <b>MOUNTING KIT</b> For: 229 and 262 ci V6, 305 and 350 SB V8, 454 Big Block V8. Used with Mercuriser 93320 A5 Riser kit (Sierra 18-1908K kit and 18-1908 Spacer), 98504A3 Riser (Sierra 18-1970-1) with 99746A17 Manifolds (Sierra 18-1952-1)</p>	 <p><b>NEW</b> <b>18-8555</b> <b>MOUNTING KIT</b> For: 229 and 262 ci V6, 305 and 350 SB V8, 454 Big Block V8. Used with Mercuriser 93320 A5 Riser kit (Sierra 18-1908K kit and 18-1908 Spacer), 98504A3 Riser (Sierra 18-1970-1) with 99746A17 Manifolds (Sierra 18-1952-1)</p>	 <p><b>NEW</b> <b>18-8556</b> <b>MOUNTING KIT</b> For: 229 and 262 ci V6, 305 and 350 SB V8, 454 Big Block V8. Used to mount Mercuriser 93322A12 Spacer (Sierra 18-1985) to 860246A10 (18-1953-1), 807078A6 (Sierra 18-1957-1) and 99746A17 (Sierra 18-1952-1) Manifolds</p>
 <p><b>NEW</b> <b>18-8542</b> <b>MOUNTING KIT</b> For: Ford Small Block V8 221, 255, 260, 289, 302, 351 ci, GM Small Block V8 265, 283, 305, 307, 327, 350 and 400 ci, GM Big Block V8 427 and 454 ci engines with Raw Water Cooled Manifolds. Used with 18-1980 and 18-1981 Risers with Raw Water Cooled Manifolds.</p>	 <p><b>NEW</b> <b>18-8543</b> <b>MOUNTING KIT</b> For: Ford Small Block V8 221, 255, 260, 289, 302 and 351 ci, GM Small Block V8 265, 283, 305, 307, 327, 350 and 400 ci, GM Big Block V8 427 and 454 ci engines. Used with Closed Cooled or Recirculating Manifolds.</p>	 <p><b>NEW</b> <b>18-8541</b> <b>MOUNTING KIT</b> For: Ford Small Block V8 221, 255, 260, 289, 302 and 351 ci. Used with 18-1979 Exhaust Manifold</p>
 <p><b>NEW</b> <b>18-8512</b> <b>MOUNTING KIT</b> Mercuriser GM 4 Cylinder 181cu.in. (Models: 120, 140, 2.5L, 3.0L), GM Inline 6 Cylinder 250-292cu.in. (Models: 165 and 200), Ford Small Block V8 302-351cu.in. (Models: 215, 225, 233, 255, 888), GM Small Block V8 305350cu.in. (Models: 198, 228, 898) Used with: 18-4009 &amp; AP 5021 End Plates</p>	 <p><b>NEW</b> <b>18-8500</b> <b>MOUNTING KIT</b> Mercuriser 4 Cylinder 224cu.in. 3.7L (Models: 165, 170, 180, 190) Used with: 18-1905 Elbow/Reservoir (Includes AP 5625 Hardware Kit)</p>	 <p><b>NEW</b> <b>18-8531</b> <b>MOUNTING KIT</b> Mercuriser GM Inline 6 Cylinder 250cu.in. (Models: 165 and 200) Used with 18-1960-1 Manifold (Includes AP 5403 Hardware Kit)</p>
 <p><b>NEW</b> <b>18-8513</b> <b>MOUNTING KIT</b> Mercuriser GM Inline 6 Cylinder 250cu.in. (Models: 165 equipped w risers 76351, 76325, 60426, 49964, 76771, 60427), GM Inline 6 Cylinder 250 and 292cu.in. (Models: 165 and 200), Ford Small Block V8 302-351cu.in. (Models: 215, 225, 233, 255, 888), GM Small Block V8 305-350cu.in. (Models: 198, 228, 898) Used with: 18-1971 &amp; 18-1978 Risers</p>	 <p><b>NEW</b> <b>18-8508</b> <b>MOUNTING KIT</b> Mercuriser Gm 4 Cylinder 153cu.in. (Early models 110/120), GM Inline Cylinder 250cu.in. (Model: 160) Used with: 18-1973 Riser</p>	 <p><b>NEW</b> <b>18-8505</b> <b>MOUNTING KIT</b> Mercuriser GM V6 229 and 262cu.in. (Models 185 and 205), GM Small Block V8 305-350cu.in. (Models: 200, 228, 230, 260, 898), GM Big Block V8 454cu.in. (Models: 330, 340 and 7.4L) Used with: 18-1976-1 Riser (Includes AP 5606 Hardware Kit)</p>



# MERCURISER Cooling System



<p><b>NEW</b></p>  <p><b>18-8520 MOUNTING KIT</b> Replaces: 10-53728 Mercuriser GM Small Block V8 305-350cu.in. (Models: 198, 200, 228, 230, 260, 898) Used with: 18-1950-1, 18-1951-1 &amp; 18-1953-1 (Includes AP 5161 Screw &amp; AP 5400 Hardware Kit)</p>	<p><b>NEW</b></p>  <p><b>18-8532 MOUNTING KIT</b> Mercuriser GM Big Block V8 454cu.in. (Models: 330, 340 and 7.4L) Used with: 18-1957-1 Manifold (Includes AP 5406 Hardware Kit)</p>	<p><b>NEW</b></p>  <p><b>18-8533 MOUNTING KIT</b> Mercuriser GM V6 229 and 262cu.in. (Models 185 and 205) Used with 18-1952-1 Manifold</p>																
<p><b>NEW</b></p>  <p><b>18-8530 MOUNTING KIT</b> Mercuriser 4 Cylinder 224cu.in. 3.7L (Models: 165, 170, 180, 190) Used with: 18-1937 Elbow/Reservoir</p>	<p><b>NEW</b></p>  <p><b>18-8535 MOUNTING KIT</b> Barr, Indmar and Marine Power Ford Small Block V8 302-351cu.in., GM Small Block V8 305-350cu.in., GM Big Block V8 454cu.in. Used with: 18-1939, 18-1999, and 18-1907 Risers (Includes AP 5405 Hardware Kit)</p>	<p><b>NEW</b></p>  <p><b>18-8536 MOUNTING KIT</b> Barr, Indmar and Marine Power GM Small Block V8 305-350cu.in. Used with: 18-1997-1 Manifold</p>																
<p><b>NEW</b></p>  <p><b>18-8529 MOUNTING KIT</b> Mercuriser GM V6 229 and 262cu.in. (Models 185 and 205), GM Small Block V8 305-350cu.in. (Models: 200, 228, 230, 260, 898), GM Big Block V8 454cu.in. (Models: 330, 340 and 7.4L) Used with: 18-1970-1 Riser (Includes AP 5600 Hardware Kit)</p>	<p><b>HARDWARE MOUNTING KITS</b></p> <table border="1"> <thead> <tr> <th>Sierra#</th> <th>AP#</th> <th>Fits</th> </tr> </thead> <tbody> <tr> <td>18-8548</td> <td>5408</td> <td>18-1950-1 &amp; 18-1951-1 Manifold</td> </tr> <tr> <td>18-8549</td> <td>5401</td> <td>18-1955-1 Manifold</td> </tr> <tr> <td>18-8551</td> <td>5626</td> <td>18-1975 Exhaust Elbow</td> </tr> <tr> <td>18-8552</td> <td>5603</td> <td>18-1972 Exhaust Elbow</td> </tr> </tbody> </table>	Sierra#	AP#	Fits	18-8548	5408	18-1950-1 & 18-1951-1 Manifold	18-8549	5401	18-1955-1 Manifold	18-8551	5626	18-1975 Exhaust Elbow	18-8552	5603	18-1972 Exhaust Elbow	<p><b>NEW</b></p>  <p><b>18-8509 MOUNTING KIT</b> Mercuriser Small Block V8 302-351cu.in. (Models : 215, 225, 233, 255, 888) Used with: 18-1962 &amp; 18-1958 Manifolds (Includes AP 5410 Hardware Kit)</p>	<p><b>NEW</b></p>  <p><b>18-8538 MOUNTING KIT</b> Barr and Indmar Ford Small Block V8 302-351cu.in. Used with: 18-1998-1 Manifold</p>
Sierra#	AP#	Fits																
18-8548	5408	18-1950-1 & 18-1951-1 Manifold																
18-8549	5401	18-1955-1 Manifold																
18-8551	5626	18-1975 Exhaust Elbow																
18-8552	5603	18-1972 Exhaust Elbow																
<p><b>NEW</b></p>  <p><b>18-8537 MOUNTING KIT</b> GM Small Block V8 (265, 283, 305, 307, 327, 350, and 400cu.in.) Used with: 18-1964 Manifold</p>	 <p><b>18-2896 AP# 324 END CAP TO MANIFOLD GASKET</b> Replaces: 27-52546</p>	 <p><b>18-1203 AP# 325 MANIFOLD TO CYLINDER HEAD GASKET</b> Replaces: 27-53354</p>	 <p><b>18-1204 MANIFOLD TO CYLINDER HEAD GASKET</b> Replaces: 27-96429</p>															
<p>PKG. OF 2</p>  <p><b>18-1209 AP# 312 END CAP TO MANIFOLD GASKET</b> Replaces: 27-39917</p>	<p>PKG. OF 2</p>  <p><b>18-1210 AP# 316 END CAP TO MANIFOLD GASKET</b> Replaces: 27-39923</p>	<p>PKG. OF 2</p>  <p><b>18-0885 AP# 313 EXHAUST ELBOW TO MANIFOLD GASKET</b> Replaces: 27-48042</p>	 <p><b>18-0897 AP# 524 EXHAUST ELBOW TO MANIFOLD GASKET</b> Replaces: 27-41813</p>															

1/0



 <p><b>18-2854</b> AP# 1499 <b>EXHAUST RISER GASKET</b></p> <p>Replaces: Barr 01-0107 Use with 18-1999/AP#5705</p>	<p>PKG. OF 2</p>  <p><b>18-0418</b> AP# 740 <b>MANIFOLD TO CYL. HEAD GASKET</b></p> <p>Replaces: 27-46820</p>	<p>PKG. OF 2</p>  <p><b>18-2949</b> AP# 099 <b>MANIFOLD GASKET</b></p> <p>Replaces: Barr CHV-47-000 Use with 18-1997-1/AP#5517</p>	 <p><b>18-0470</b> <b>MANIFOLD GASKET</b></p> <p>GM Small Block V8 283-350cu. in. Used with: 18-1914 Manifold (both ends)</p>	 <p><b>18-1995</b> <b>END PLATE</b></p> <p>Replaces: 47638</p>
<p><b>18-1912</b> <b>END PLATE</b></p> <p>Mercruiser GM Inline 6 Cylinder 250 and 292cu.in. (Models: 165 and 200), Ford Small Block V8 302-351cu.in. (Models: 215, 225, 233, 255 and 888), GM Small Block V8 305-350cu.in. (Models: 198, 228 and 898)</p> <p>Replaces: Mercruiser 54870</p>	 <p><b>18-4008</b> AP# 5008 <b>BLOCK-OFF PLATE</b></p> <p>Replaces: 60207</p>	 <p><b>18-4227</b> <b>DRAIN ELBOW</b></p> <p>Replaces: 22-806926</p>		
 <p><b>18-4009</b> AP# 5005 <b>END PLATE</b></p> <p>Replaces: 60252A2</p>	 <p><b>18-1906</b> <b>MANIFOLD SPACER</b></p> <p>3" Spacer for 18-1950, 18-1951, 18-1958 &amp; 18-1962 manifolds</p> <p>Replaces: Mercruiser 61851</p>	<p><b>18-1908</b> <b>RISER SPACER</b></p> <p>Mercruiser GM V6 229 and 262cu.in. (Models: 185 and 205), GM Small Block V8 305-350cu.in. (Models: 200, 228, 230, 260 and 898), GM Big Block V8 454cu.in. (Models: 330, 340 and 7.4L)</p> <p>Replaces: 93320 Used with: 18-1952-1, 18-1953-1, 18-1957-1 Manifolds</p>		
<p><b>18-1994</b> <b>MANIFOLD SPACER</b></p> <p>Barr, Indmar and Marine Power Ford Small Block V8 302-351cu.in., GM Small Block V8 305-350cu.in., GM Big Block V8 454cu.in.</p> <p>Used with: 18-1998-1, 18-1997-1 and 18-1898 Manifolds</p>	 <p><b>18-3601</b> AP# 1054 <b>WATER INTAKE HOSE</b></p> <p>Replaces: 32-32461 13 7/8" Length - 5/8" I.D. For: MCI, R, MR, Alpha I</p>	 <p><b>18-3602</b> AP# 1053 <b>WATER INTAKE HOSE</b></p> <p>Replaces: 32-41725-33 13 7/8" Length - 3/4" I.D. For: MR, Alpha I, Gen II</p>	 <p><b>18-3603</b> <b>WATER INTAKE HOSE</b></p> <p>Mercruiser 32-43437</p>	
 <p><b>18-1991</b> AP# 5053 <b>30° EXHAUST ELBOW ADAPTER</b></p> <p>For use with 3" I.D. Exhaust Hose Use 18-1999/AP#5705 Manifold Riser</p>	<p><b>NEW</b></p>  <p><b>18-1985</b> <b>SPACER</b></p> <p>Replaces: 93322 For: 229 and 262 V6, 305-350 Small Block V8, 454 Big Block V8</p>	 <p><b>18-4226</b> <b>DRAIN PLUG</b></p> <p>Replaces: 22-806608A1</p>	 <p><b>18-2434</b> AP# 5099 <b>FLYWHEEL HOUSING</b></p> <p>Replaces: 814309A1 For: GM v-8's Big &amp; Small Blocks Inboard/Ski Models</p>	
 <p><b>18-4461</b> AP# 5187 <b>HOSE BARB</b></p> <p>3/4" - 14 NPT x 1" Hose Corrosion Resistant Brass Fitting</p>	 <p><b>18-4224</b> <b>DRAIN ELBOW ASSEMBLY</b></p> <p>Replaces: 22-806926A1</p>	 <p><b>18-1990</b> AP# 5006 <b>BLOCK OFF PLATE</b></p> <p>Replaces: 73813A1</p>	 <p><b>18-4218</b> AP# 5154 <b>BLOCK DRAIN TAP</b></p> <p>Replaces: 22-87238, 22-16951A1, 22-16951T1, Q1 1/4" NPT 18-3223 — AP#5154B Bulk pack of 12 — 18-4218/AP#5154</p>	



# MERCUISER

## Cooling System



### MANIFOLD/MANIFOLD GASKET APPLICATION

Model	Serial Number	Manifold Stb (*) Port (#)	Elbow Stb (*) Port (#)	End Cap	Manifold Block-Off Plate	Manifold Gasket	Elbow Gasket	End Cap Gasket	End Cap Water Port Gasket	Gasket Set
120	1666601 - 2046624	—	—	—	N/A	18-2896	—	N/A	—	N/A
120	2046625 - 2324346	—	18-1973	N/A	N/A	18-2896	18-2819	18-1210	18-1209	18-4395
120	2324347 - 3377340	—	18-1973	18-1995	N/A	18-2896	18-2819	18-1210	18-1209	18-4395
120	3377341 - 5192408	—	18-1973	18-1995	N/A	18-2896	18-2819	18-1210	18-1209	18-4395
120	5192049 - 6229717	—	18-1973	18-1995	N/A	18-2896	18-2819	18-1210	18-1209	18-4395
120/2.5L	6229718 & up	18-1956-1	18-1972 ⑨	18-4009	N/A	18-1204	18-2833	18-0928	18-2832	18-4367
140(4Cyl)	2508261 - 3332137	18-1955-1	18-1971	18-4009 ②	18-1990	18-1203	18-2833	18-2832	18-2832	—
140(4Cyl)	3332138 - 5157668	18-1955-1	18-1971	18-4009	18-1990	18-1203	18-2833	18-2832 ⑥	18-2832	18-4398
140(4Cyl)	5157669 - 6229717	18-1955-1	18-1971	18-4009	18-1990	18-1203	18-2833	—	18-2832	18-4398
140/3.0L	6229718 & up	18-1956-1	18-1972 ⑨	18-4009	N/A	18-1204	18-2833	18-0928	18-2832	18-4367
3.0L/3.0LX	C856559 - F603999	18-1956-1	18-1975	18-4009 ⑩	N/A	18-1204	18-2833	18-0928	18-2832	—
140(6Cyl)	1538930 - 1725960	—	—	N/A	N/A	18-2830	—	—	—	—
150	1666495 - 2048046	—	—	—	N/A	18-2830	—	N/A	—	—
160	2048022 - 2770031	* —	18-1973	N/A	N/A	18-2830	—	18-1210	18-1209	—
165	2770032 & up	18-1960-1	18-1971	18-4009	18-1990	18-2830	18-2833	18-2832 ⑦	18-2832	18-4396
165/170/3.7L	6916779 & up	—	—	—	—	—	—	—	—	—
180/190/3.7LX	6916779 & up	—	—	—	—	—	—	—	—	—
175/4.3L (262 CID)	B527955 & up	*18-1952-1 *18-1952-1	* ⑨ # N/A	N/A	N/A	18-2909	18-0897	N/A	N/A	18-4347
4.3L (GEN II)	D714107 & up	*18-1952-1 *18-1952-1	* ⑨ * ⑨	N/A	N/A	18-2909	18-0897	N/A	N/A	18-4347
4.3L (GEN II)	F000878 & up	*18-1952-1 *18-1952-1	* ⑨ * ⑨	N/A	N/A	18-2909	18-0897	N/A	N/A	18-4347
185 (229 CID)	6330183 & up	*18-1952-1 *18-1952-1	* ⑨ * ⑨	N/A	N/A	18-2909	18-0897	N/A	N/A	18-4347
185 (262 CID)	A331455 & up	*18-1952-1 *18-1952-1	* ⑨ # NA	N/A	N/A	18-2909	18-0897	N/A	N/A	18-4347
200	2453769 - 2712072	*18-1960-1	*18-1971	—	N/A	18-2830	18-2833	18-2832	18-2832	18-4396
200-GM	6218462 & up	*18-1953 18-1953	* ⑨ ④ * ⑨ ④	N/A	N/A	18-0872	18-0897	N/A	N/A	18-4394
200/5.0L(GM)	B525982 & up	*18-1953 *18-1953	* ⑨ ⑤ * ⑨ ④	N/A	N/A	18-0872	18-0897	N/A	N/A	18-4394

<p># Port if necessary</p> <p>* Starboard if necessary</p> <p>② S/N 2816417 &amp; up only</p> <p>③ Not including inboard</p> <p>④ V-Drive use 18-1971</p> <p>⑥ S/N 4481626 &amp; up use 18-0928</p> <p>⑦ S/N 4471566 &amp; up use 18-0928</p>	<p>⑨ Two piece elbow assembly only</p> <p>⑩ Manifold with end caps only</p> <p>② Inboards not included</p> <p>④ V-Drive not included</p> <p>④ Inboards use 18-1978</p> <p>⑤ Cast iron elbow only</p> <p>⑥ S/N 4625580 &amp; up use</p>	<p>⑨ For 0° - 3" O.D. use 18-1974-1; For 15° - 3" O.D. use 18-1970-1; For 7° - 4" O.D. use 18-1976-1</p> <p>⑩ Electric choke only</p> <p>■ Mercruiser system only</p> <p>★ Adapter to Elbow Gasket use 18-0885</p>
---	--	--



# MERCUISER Cooling System



MANIFOLD/MANIFOLD GASKET APPLICATION (Cont.)										
Model	Serial Number	Manifold Stb (*) Port (#)	Elbow Stb (*) Port (#)	End Cap	Manifold Block-Off Plate	Manifold Gasket	Elbow Gasket	End Cap Gasket	End Cap Water Port Gasket	Gasket Set
260-GM	6218462 & up	* 18-1953 * 18-1953	* ⑨ * ⑨	N/A	18-4008	18-0872	18-0897	N/A	N/A	18-4349
260/5.7L (GM)	B525982 & up	* 18-1953 * 18-1953	* ⑨ ⑤ * ⑨ ⑤	N/A	18-4008	18-0872	18-0897	N/A	N/A	18-4349
260-GM (INBRD)	5907058 & up	* 18-1953 * 18-1953	* ⑨ * ⑨	N/A	18-4008	18-0872	18-0897	N/A	N/A	18-4349
260/5.7	B588506 & up	* 18-1953	* ⑨	N/A	18-4008	18-0872	18-0897	N/A	N/A	18-4349
GM (IB)		* 18-1953	* ⑨							
270-GM	2851074-3077735	—	—	18-4009	N/A	18-0872	18-0885	18-2832	18-2832	18-4394
280-GM	4176250 & up	—	—	18-4009	N/A	18-0872	18-0885	18-2832	18-2832	18-4394
300MR/TRS (GM)	6668677 & up	* 18-1953 * 18-1953	—	N/A	N/A	18-0872	18-2849	N/A	N/A	—
320-GM (EFI)	A543604 & up	* 18-1953 * 18-1953	* ⑨ * ⑨	N/A	N/A	18-0872	18-2849	N/A	N/A	—
320-GM (EFI)	B157603 & up	* 18-1953 * 18-1953	* ⑨ * ⑨	N/A	N/A	18-0872	18-2849	N/A	N/A	—
325-GM	2313965-3042730	—	—	—	N/A	18-0418	18-0885	—	—	18-4397
325-GM	3042731 & up	—	—	18-4009	N/A	18-0418	18-0885	18-2832	18-2832	18-4397
330-GM	4623115 & up	—	—	18-4009	N/A	18-0418	18-0885	18-2832	18-2832	18-4397
330-GM	6083145 & up	—	* ⑨	N/A	N/A	18-0418	18-0897	N/A	N/A	18-4348
340/7.4L-GM	5889914 & up	—	* ⑨ * ⑨	N/A	N/A	18-0418	18-0897	N/A	N/A	18-4348
350-GM	3780450 & up	—	—	18-4009	N/A	18-0418	18-0885	18-2832	18-2832	18-4349
350-GM (Mag)	A635178 & up	* 18-1953 * 18-1953	* ⑨ * ⑨	N/A	N/A	18-0872	18-0897	N/A	N/A	18-4349
350-GM (Mag)	B525982 & up	* 18-1953 * 18-1953	* ⑨ ⑤ * ⑨ ⑤	N/A	N/A	18-0872	18-0897	N/A	N/A	18-4349
350 (Mag-Trm.Ski)	D505450 & up	* 18-1953 * 18-1953	* ⑨ * ⑨	N/A	N/A	18-0872	18-0897	N/A	N/A	18-4349
370 TRS-GM	4179554 & up	—	—	18-4009	18-1990	18-0418	18-0885	18-2832	18-2832	18-4397
370 TRS-GM	6721528 & up	* 18-1957 * 18-1957	* ⑨ * ⑨	N/A	N/A	18-0418	18-2849H	N/A	N/A	—
390-GM	2781129-2825059	—	—	18-4009	N/A	18-0418	18-0885	18-2832	18-2832	18-4397
400 TRS-GM	4179554 & up	—	—	18-4009	18-1990	18-0418	18-0885	18-2832	18-2832	18-4397
420-GM	A398941 & up ■	—	—	N/A	N/A	18-0418	—	N/A	N/A	—
425-GM	A398941 & up ■	—	—	N/A	N/A	18-0418	—	N/A	N/A	—
440 TRS-GM	4179554 & up	—	—	18-4009	18-1990	18-0418	18-0885	18-2832	18-2823	18-4397

# Port if necessary * Starboard if necessary ② S/N 2816417 & up only ③ Not including inboard ④ V-Drive use 18-1971 ⑥ S/N 4481626 & up use 18-0928 ⑦ S/N 4471566 & up use 18-0928 ⑨ Two piece elbow assembly only	⑩ Manifold with end caps only ② Inboards not included ③ V-Drive not included ④ Inboards use 18-1978 ⑤ Cast iron elbow only ⑥ S/N 4625580 & up use 18-1972 ⑦ MCM 228 & MCM 228-TR S/N 4888930 & up	⑨ For 0° - 3" O.D. use 18-1974-1; For 15° - 3" O.D. use 18-1970-1; For 7° - 4" O.D. use 18-1976-1 ⑩ Electric choke only ■ Mercruiser system only ★ Adapter to Elbow Gasket use 18-0885 ▲ Cast iron manifold ▼ Aluminum manifold
---	---	--





# MERCUISER Cooling System

MANIFOLD/MANIFOLD GASKET APPLICATION (Cont.)										
Model	Serial Number	Manifold Stb (*) Port (#)	Elbow Stb (*) Port (#)	End Cap	Manifold Block-Off Plate	Manifold Gasket	Elbow Gasket	End Cap Gasket	End Cap Water Port Gasket	Gasket Set
454-GM (Mag)	A631894 & up	* 18-1957 * 18-1957	* ① * ①	N/A	N/A	18-0418	18-0897	N/A	N/A	18-4348
454 Mag Bravo (GM)	B721206 & up	* 18-1957 * 18-1957	* ① * ①	N/A	N/A	18-0418	18-0897	N/A	N/A	18-4348
454 Mag Bravo (Gen V)	D805069 & up	* 18-1957 * 18-1957	—	N/A	N/A	18-0418	18-0897	N/A	N/A	18-4348
460 TRS-GM	4179554 & up	—	—	18-4009	18-1990	18-0418	18-0885	18-2832	18-2832	18-4397
465	C849992 & up	—	—	N/A	N/A	18-0418	—	N/A	N/A	—
470	4208730-5520114	—	* 18-1971 ⑥ * 18-1971 ⑥	—	N/A	—	18-2833	18-2832	18-2832	—
470	5520115-6218036	—	* 18-1972 ②	N/A	18-1990	—	18-2833	18-2832	18-2832	—
500	C577254 & up	—	—	N/A	N/A	18-0418	—	N/A	N/A	—
502 Mag Bravo (GM)	C878221 & up	* 18-1957 * 18-1957	* ① * ①	N/A	N/A	18-0418	18-0897	N/A	N/A	18-4348
502 Mag Bravo (Gen V)	D824589 & up	* 18-1957 * 18-1957	—	N/A	N/A	18-0418	18-0897	N/A	N/A	18-4348
502 EFI	D840650 & up	* 18-1957 * 18-1957	—	N/A	N/A	18-0418	18-0897	N/A	N/A	18-4348
525	D456000 & up	—	—	N/A	N/A	18-0418	—	N/A	N/A	—
888-FORD	3108723 & up	* 18-1958 * 18-1962	* 18-1971 * 18-1971	18-4009	18-4008	18-0183	18-2833	18-2832	18-2832	18-4399
898/198-GM	4762210-6218461	* 18-1950-1 * 18-1950-1	* 18-1971 ② * 18-1971 ②	18-4009	18-4008	18-0872	18-2833	18-2832	18-2832	18-4394
898-GM	6218462 & up	* 18-1953 * 18-1953	* ① * ①	N/A	18-4008	18-0872	18-0897	N/A	N/A	18-4349
5.7-GM (Ski)	A338553 & up	* 18-1953 * 18-1953	* ① * ①	N/A	N/A	18-0872	18-0897	N/A	N/A	18-4349
5.7-GM (Ski)	B514627 & up	* 18-1953 * 18-1953	* ① * ①	N/A	N/A	18-0872	18-0897	N/A	N/A	18-4349
5.7L Bravo (GM)	B525982 & up	* 18-1953 * 18-1953	* ① ⑤ * ① ⑤	N/A	N/A	18-0872	18-0897	N/A	N/A	18-4349
7.4L Bravo (GM)	B771113 & up	* 18-1957 * 18-1957	* ① * ①	N/A	N/A	18-0418	18-0897	N/A	N/A	18-4348
7.4L Mag Bravo (Gen V)	D603118 & up	* 18-1957 * 18-1957	—	N/A	N/A	18-0418	18-0897	N/A	N/A	18-4348
7.4L w/Hurth (IB)	ALL	* 18-1957 * 18-1957	* ① * ①	N/A	N/A	18-0418	18-0897	N/A	N/A	18-4348
7.4L (IB/LHR/Gen V)	D715494 & up	* 18-1957 * 18-1957	—	N/A	N/A	18-0418	18-0897	N/A	N/A	18-4348
8.2L w/Hurth (IB)	C878221 & up	* 18-1957 * 18-1957	—	N/A	N/A	18-0418	18-0897	N/A	N/A	18-4348
8.2L (IB) (Gen V)*	D857200 & up	* 18-1957 * 18-1957	—	N/A	N/A	18-0418	18-0897	N/A	N/A	18-4348

# Port if necessary  
\* Starboard if necessary  
② S/N 2816417 & up only  
③ Not including inboard  
④ V-Drive use 18-1971  
⑥ S/N 4481626 & up use 18-0928  
⑦ S/N 4471566 & up use 18-0928  
⑨ Two piece elbow assembly only

⑩ Manifold with end caps only  
⑪ Inboards not included  
⑫ V-Drive not included  
⑬ Inboards use 18-1978  
⑭ Cast iron elbow only  
⑮ S/N 4625580 & up use 18-1972  
⑯ MCM 228 & MCM 228-TR S/N 4888930 & up

⑰ For 0° - 3" O.D. use 18-1974-1;  
For 15° - 3" O.D. use 18-1970-1;  
For 7° - 4" O.D. use 18-1976-1  
⑱ Electric choke only  
■ Mercruiser system only  
★ Adapter to Elbow Gasket use 18-0885  
▲ Cast iron manifold  
▼ Aluminum manifold

