











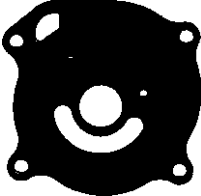





 <p><b>18-3368</b> AP# 1922 <b>IMPELLER</b> Replaces: 396809</p>	 <p><b>18-3102</b> <b>IMPELLER PLATE</b> Replaces: 305303</p>	 <p><b>18-3103</b> AP# 13155 <b>IMPELLER PLATE</b> Replaces: 303069</p>	 <p><b>18-3127</b> AP# 1755 <b>IMPELLER PLATE</b> Replaces: 319275</p>	 <p><b>18-3182</b> AP# 13161 <b>IMPELLER PLATE</b> Replaces: 317841</p>																				
 <p><b>18-3346</b> <b>CUP &amp; PLATE ASSEMBLY</b> Replaces: 435027 Contains: AP# 1398 Plate &amp; AP# 1399 Cup</p>	 <p><b>18-3352</b> AP# 2919 <b>IMPELLER PLATE</b> Replaces: 325398</p>	 <p><b>18-3359</b> AP# 1880 <b>IMPELLER PLATE</b> Replaces: 328755</p>	 <p><b>18-3179</b> AP# 2354 <b>WATER PUMP CUP</b> Replaces: 324097</p>	<p><b>IMPELLER KEYS</b></p> <table border="1"> <thead> <tr> <th>Sierra #</th> <th>AP #</th> <th>Replaces:</th> <th>Std. Pkg.</th> </tr> </thead> <tbody> <tr> <td>18-3295</td> <td>—</td> <td>330619</td> <td>3</td> </tr> <tr> <td>18-3138</td> <td>① 1757</td> <td>334897</td> <td>2</td> </tr> <tr> <td>18-3108</td> <td>1407</td> <td>308928</td> <td>1</td> </tr> <tr> <td>18-3299</td> <td>② 1408</td> <td>331107</td> <td>5</td> </tr> </tbody> </table> <p>① PKG OF 2    ② PKG OF 3</p>	Sierra #	AP #	Replaces:	Std. Pkg.	18-3295	—	330619	3	18-3138	① 1757	334897	2	18-3108	1407	308928	1	18-3299	② 1408	331107	5
Sierra #	AP #	Replaces:	Std. Pkg.																					
18-3295	—	330619	3																					
18-3138	① 1757	334897	2																					
18-3108	1407	308928	1																					
18-3299	② 1408	331107	5																					
 <p><b>18-3358</b> <b>WATER PUMP CUP</b> Replaces: 328751</p>	 <p><b>18-3129</b> AP# 1751 <b>HOUSING</b> Replaces: 435673</p>	 <p><b>18-3130</b> AP# 011 <b>HOUSING</b> Replaces: 435485</p>	 <p><b>18-3405</b> <b>HOUSING</b> Replaces: 435959</p>																					
 <p><b>18-3180</b> AP# 2912 <b>HOUSING</b> Replaces: 435390</p>	 <p><b>18-3336</b> AP# 1929 <b>HOUSING</b> Replaces: 384087</p>	 <p><b>18-3363</b> <b>HOUSING</b> Replaces: 330560</p>	 <p><b>18-3367</b> AP# 2911 <b>HOUSING</b> Replaces: 393632</p>																					
 <p><b>18-3126</b> AP# 1753 <b>WEAR PLATE</b> Replaces: 321940</p>	 <p><b>18-3178</b> AP# 2356 <b>WEAR PLATE</b> Replaces: 318995</p>	 <p><b>18-3343</b> AP# 1916 <b>WEAR PLATE</b> Replaces: 320981</p>	 <p><b>18-3326</b> AP# 2357 <b>PIN</b> Replaces: 300611</p>																					

**OUTBOARD**





APPLICATIONS BEGIN ON PAGE 170

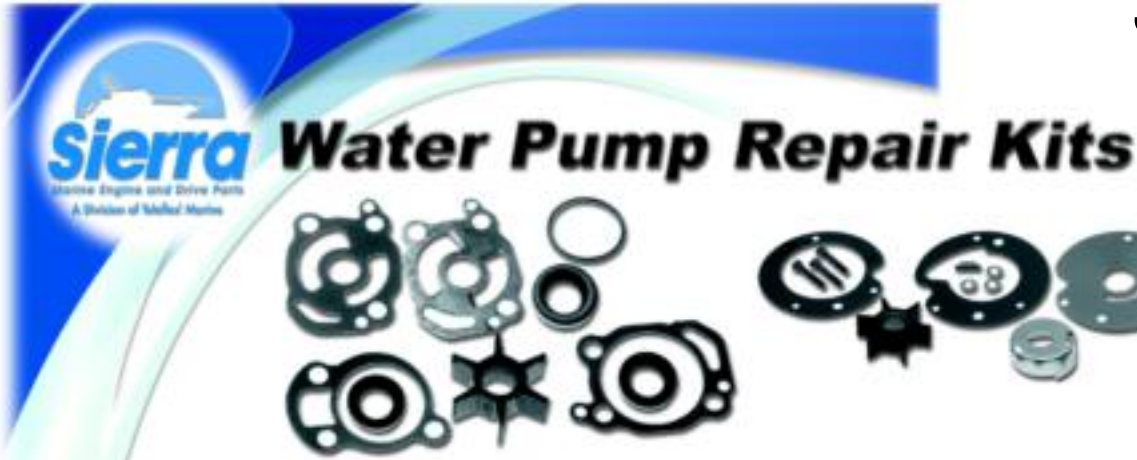

### Features...

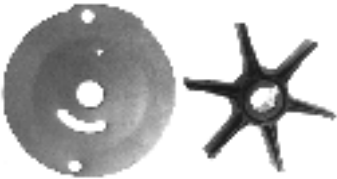
- ★ Complete kits contain all of the parts necessary to do the job right.
- ★ All components are manufactured from premium materials and held to stringent quality standards.
- ★ Many exclusive products you can't get from any other after-market supplier.

**OUTBOARD**

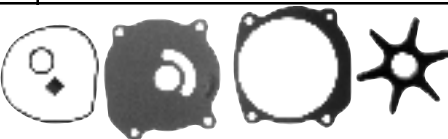
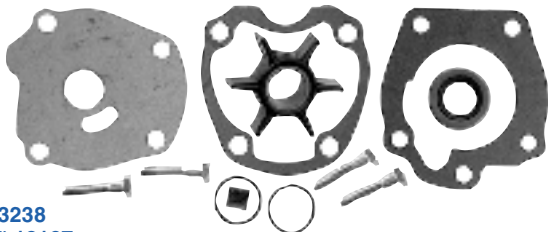
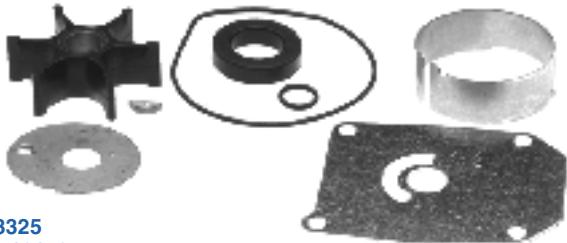
 <p><b>18-3201</b> <b>AP# 2478</b> <b>IMPELLER REPAIR KIT</b> — CONTAINS —</p>		 <p><b>18-3202</b> <b>AP# 2479</b> <b>IMPELLER REPAIR KIT</b> — CONTAINS —</p>		 <p><b>18-3203</b> <b>AP# 2480</b> <b>IMPELLER REPAIR KIT</b> — CONTAINS —</p>																																																									
<table border="1"> <thead> <tr> <th>Sierra #</th> <th>Desc.</th> <th>O.E.#</th> <th>Qty.</th> </tr> </thead> <tbody> <tr> <td>18-3001</td> <td>Impeller</td> <td>277181,434424</td> <td>1</td> </tr> <tr> <td>18-3101</td> <td>Impeller Plate</td> <td>203132</td> <td>1</td> </tr> </tbody> </table>	Sierra #	Desc.	O.E.#	Qty.	18-3001	Impeller	277181,434424	1	18-3101	Impeller Plate	203132	1	<table border="1"> <thead> <tr> <th>Sierra #</th> <th>Desc.</th> <th>O.E.#</th> <th>Qty.</th> </tr> </thead> <tbody> <tr> <td>18-3001</td> <td>Impeller</td> <td>277181,434424</td> <td>1</td> </tr> <tr> <td>18-3102</td> <td>Impeller Plate</td> <td>305303</td> <td>1</td> </tr> </tbody> </table>	Sierra #	Desc.	O.E.#	Qty.	18-3001	Impeller	277181,434424	1	18-3102	Impeller Plate	305303	1	<table border="1"> <thead> <tr> <th>Sierra #</th> <th>Desc.</th> <th>O.E.#</th> <th>Qty.</th> </tr> </thead> <tbody> <tr> <td>18-3002</td> <td>Impeller</td> <td>375638</td> <td>1</td> </tr> <tr> <td>18-3103</td> <td>Impeller Plate</td> <td>303069</td> <td>1</td> </tr> </tbody> </table>	Sierra #	Desc.	O.E.#	Qty.	18-3002	Impeller	375638	1	18-3103	Impeller Plate	303069	1																							
Sierra #	Desc.	O.E.#	Qty.																																																										
18-3001	Impeller	277181,434424	1																																																										
18-3101	Impeller Plate	203132	1																																																										
Sierra #	Desc.	O.E.#	Qty.																																																										
18-3001	Impeller	277181,434424	1																																																										
18-3102	Impeller Plate	305303	1																																																										
Sierra #	Desc.	O.E.#	Qty.																																																										
18-3002	Impeller	375638	1																																																										
18-3103	Impeller Plate	303069	1																																																										
 <p><b>18-3210</b> <b>AP# 13162</b> <b>IMPELLER REPAIR KIT</b> — CONTAINS —</p>		 <p><b>18-3211<sup>①</sup></b> <b>18-3211N<sup>②</sup></b> <b>AP# 13163</b> <b>IMPELLER REPAIR KIT</b> — CONTAINS —</p>																																																											
<table border="1"> <thead> <tr> <th>Sierra #</th> <th>Desc.</th> <th>O.E.#</th> <th>Qty.</th> </tr> </thead> <tbody> <tr> <td>18-3043</td> <td>Impeller</td> <td>389642</td> <td>1</td> </tr> <tr> <td>18-2536</td> <td>Rubber Seal</td> <td>321120</td> <td>1</td> </tr> <tr> <td>18-2557</td> <td>Impeller Gasket</td> <td>324701,338484</td> <td>1</td> </tr> <tr> <td>18-7158</td> <td>O-Ring</td> <td>310967,310585</td> <td>1</td> </tr> </tbody> </table>	Sierra #	Desc.	O.E.#	Qty.	18-3043	Impeller	389642	1	18-2536	Rubber Seal	321120	1	18-2557	Impeller Gasket	324701,338484	1	18-7158	O-Ring	310967,310585	1	<table border="1"> <thead> <tr> <th>Sierra #</th> <th>Desc.</th> <th>O.E.#</th> <th>Qty.</th> </tr> </thead> <tbody> <tr> <td>18-3059</td> <td>Impeller</td> <td>395864,397131,435821</td> <td>1</td> </tr> <tr> <td>18-2536</td> <td>Rubber Seal</td> <td>321120</td> <td>1</td> </tr> <tr> <td>18-2557</td> <td>Impeller Gasket</td> <td>324701,338484</td> <td>1</td> </tr> <tr> <td>18-3299</td> <td>Impeller Key</td> <td>331107</td> <td>1</td> </tr> <tr> <td>18-7158</td> <td>O-Ring</td> <td>310967,310585</td> <td>1</td> </tr> <tr> <td>18-3138</td> <td>Impeller Key</td> <td>334897</td> <td>1</td> </tr> </tbody> </table>	Sierra #	Desc.	O.E.#	Qty.	18-3059	Impeller	395864,397131,435821	1	18-2536	Rubber Seal	321120	1	18-2557	Impeller Gasket	324701,338484	1	18-3299	Impeller Key	331107	1	18-7158	O-Ring	310967,310585	1	18-3138	Impeller Key	334897	1												
Sierra #	Desc.	O.E.#	Qty.																																																										
18-3043	Impeller	389642	1																																																										
18-2536	Rubber Seal	321120	1																																																										
18-2557	Impeller Gasket	324701,338484	1																																																										
18-7158	O-Ring	310967,310585	1																																																										
Sierra #	Desc.	O.E.#	Qty.																																																										
18-3059	Impeller	395864,397131,435821	1																																																										
18-2536	Rubber Seal	321120	1																																																										
18-2557	Impeller Gasket	324701,338484	1																																																										
18-3299	Impeller Key	331107	1																																																										
18-7158	O-Ring	310967,310585	1																																																										
18-3138	Impeller Key	334897	1																																																										
 <p><b>18-3238</b> <b>AP# 13167</b> <b>WATER PUMP REPAIR KIT</b> Replaces: 388891 — CONTAINS —</p>		 <p><b>18-3325</b> <b>AP# 13172</b> <b>WATER PUMP REPAIR KIT</b> Replaces: 387326 — CONTAINS —</p>																																																											
<table border="1"> <thead> <tr> <th>Sierra #</th> <th>Desc.</th> <th>O.E.#</th> <th>Qty.</th> </tr> </thead> <tbody> <tr> <td>18-3051</td> <td>Impeller</td> <td>395289</td> <td>1</td> </tr> <tr> <td>18-3364</td> <td>Impeller Key</td> <td>300611</td> <td>1</td> </tr> <tr> <td>18-0446</td> <td>Water Pump Gasket</td> <td>323311</td> <td>1</td> </tr> <tr> <td>18-0445</td> <td>Water Pump Gasket</td> <td>323312</td> <td>1</td> </tr> <tr> <td>18-2030</td> <td>Oil Seal</td> <td>321786</td> <td>1</td> </tr> <tr> <td>18-7105</td> <td>O-Ring</td> <td>311338</td> <td>2</td> </tr> <tr> <td>18-3133</td> <td>Stainless Steel Bolt</td> <td>331979</td> <td>4</td> </tr> </tbody> </table>	Sierra #	Desc.	O.E.#	Qty.	18-3051	Impeller	395289	1	18-3364	Impeller Key	300611	1	18-0446	Water Pump Gasket	323311	1	18-0445	Water Pump Gasket	323312	1	18-2030	Oil Seal	321786	1	18-7105	O-Ring	311338	2	18-3133	Stainless Steel Bolt	331979	4	<table border="1"> <thead> <tr> <th>Sierra #</th> <th>Desc.</th> <th>O.E.#</th> <th>Qty.</th> </tr> </thead> <tbody> <tr> <td>18-7134</td> <td>O-Ring</td> <td>339543</td> <td>1</td> </tr> <tr> <td>18-3108</td> <td>Flywheel Key</td> <td>308928</td> <td>1</td> </tr> <tr> <td>18-3337</td> <td>Grommet</td> <td>315837</td> <td>1</td> </tr> <tr> <td>18-3083</td> <td>Impeller</td> <td>377230</td> <td>1</td> </tr> <tr> <td>18-3343</td> <td>Impeller Plate</td> <td>320981</td> <td>1</td> </tr> <tr> <td>18-2705</td> <td>Grommet</td> <td>315748</td> <td>1</td> </tr> </tbody> </table>	Sierra #	Desc.	O.E.#	Qty.	18-7134	O-Ring	339543	1	18-3108	Flywheel Key	308928	1	18-3337	Grommet	315837	1	18-3083	Impeller	377230	1	18-3343	Impeller Plate	320981	1	18-2705	Grommet	315748	1
Sierra #	Desc.	O.E.#	Qty.																																																										
18-3051	Impeller	395289	1																																																										
18-3364	Impeller Key	300611	1																																																										
18-0446	Water Pump Gasket	323311	1																																																										
18-0445	Water Pump Gasket	323312	1																																																										
18-2030	Oil Seal	321786	1																																																										
18-7105	O-Ring	311338	2																																																										
18-3133	Stainless Steel Bolt	331979	4																																																										
Sierra #	Desc.	O.E.#	Qty.																																																										
18-7134	O-Ring	339543	1																																																										
18-3108	Flywheel Key	308928	1																																																										
18-3337	Grommet	315837	1																																																										
18-3083	Impeller	377230	1																																																										
18-3343	Impeller Plate	320981	1																																																										
18-2705	Grommet	315748	1																																																										

APPLICATIONS BEGIN ON PAGE - 170 ALL PARTS SHOWN ARE INCLUDED IN KIT. 18-#S LISTED, ARE AVAILABLE INDIVIDUALLY

① Display Pack    ② Bulk Pack



# JOHNSON/EVINRUDE (OMC) Cooling System



**18-3327**  
**AP#2855**  
**WATER PUMP REPAIR KIT**  
With Housing  
Replaces: 394711, 386697, 391698  
— CONTAINS —

Sierra #	Desc.	O.E. #	Qty.
18-3050	Impeller	386084	1
18-3180	Housing	435390	1
18-3178	Wear Plate	318995	1
18-3179	Water Pump Cup	324097	1
18-3329	Grommet	302497	1
18-2392	Grommet	327035	1
18-2025	Oil Seal	318972	1
18-7116	O-Ring	303097	1
18-7139	O-Ring	319085	1
18-3326	Pin	300771	1
18-3369	Stainless Steel Bolt	319126	4



**18-3376**  
**AP# 13178**  
**WATER PUMP REPAIR KIT**  
Without Housing  
Replaces: 384956  
— CONTAINS —

Sierra #	Desc.	O.E. #	Qty.
18-3083	Impeller	377230	1
18-3343	Impeller Plate	320981	1
18-3108	Flywheel Key	308928	1
18-3337	Grommet	315837	1
18-7134	O-Ring	339543	1
18-2705	Grommet	315748	1
18-3136	Screw (Long)	324430	2
18-3369	Stainless Steel Bolt	319126	2



**18-3377**  
**AP# 13179**  
**WATER PUMP REPAIR KIT**  
Without Housing  
Replaces: 382468  
— CONTAINS —

Sierra #	Desc.	O.E. #	Qty.
18-3002	Impeller	375638	1
18-3103	Impeller Plate	303069	1
18-3329	Water Tube Grommet	302497	1
18-3330	Stainless Steel Bolt	302508	3
18-3326	Pin	300771	1



**18-3378**  
**AP# 1824**  
**WATER PUMP REPAIR KIT**  
With Housing  
Replaces: 391635  
— CONTAINS —

Sierra #	Desc.	O.E. #	Qty.
18-3055	Impeller	389589	1
18-3343	Impeller Plate	320981	1
18-3336	Housing	384067	1
18-2709	Wear Plate Gasket	336530	1
18-3342	Wear Plate	320776	1
18-3365	Stainless Steel Bolt	909533	2
18-3369	Stainless Steel Bolt	319126	2
18-2705	Seal	315748	1
18-3337	Water Tube Grommet	315837	1
18-7134	O-Ring	303059	1



**18-3379**  
**AP# 13180**  
**WATER PUMP REPAIR KIT**  
Without Housing  
Replaces: 390381  
— CONTAINS —

Sierra #	Desc.	O.E. #	Qty.
18-3366	Impeller	390286	1
18-3352	Impeller Plate	325398	1
18-3354	Water Pump Gsk	325399	2
18-3353	Water Pump Cup	325397	1
18-3332	Grommet	304056	1

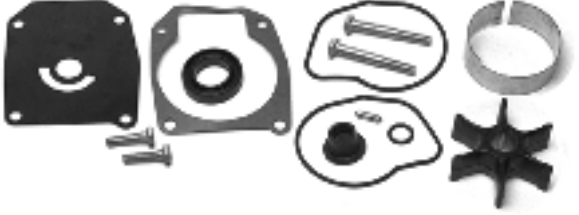

**18-3380**  
**WATER PUMP REPAIR KIT**  
Without Housing  
Replaces: 390770  
— CONTAINS —

Sierra #	Desc.	O.E. #	Qty.
18-3055	Impeller	389589	1
18-3343	Impeller Plate	320981	1
18-2709	Wear Plate Gasket	336530	1
18-3342	Wear Plate	320776	1
18-3365	Stainless Steel Bolt	909533	2
18-3136	Stainless Steel Bolt	319126	2
18-2705	Seal	315748	1
18-3337	Water Tube Grommet	315837	1
18-7134	O-Ring	303059	1

**OUTBOARD**

APPLICATIONS BEGIN ON PAGE - 170 ALL PARTS SHOWN ARE INCLUDED IN KIT. 18-#S LISTED, ARE AVAILABLE INDIVIDUALLY

# JOHNSON/EVINRUDE (OMC) Cooling System



**OUTBOARD**



**18-3381**  
**AP# 2857**  
**WATER PUMP REPAIR KIT**  
Without Housing  
Replaces: 393509  
— CONTAINS —

Sierra #	Desc.	O.E. #	Qty.
18-3051	Impeller	395289	1
18-3359	Impeller Plate	328755	1
18-0124	Impeller Plate Gasket	325537	1
18-3358	Water Pump Cup	328751	1
18-2539	Rubber Seal	328753	1
18-3329	Grommet	302497	1
18-7100	O-Ring	301877	1
18-7105	O-Ring	311338	2
18-7146	O-Ring	554545	1
18-3133	Stainless Steel Bolt	331979	6

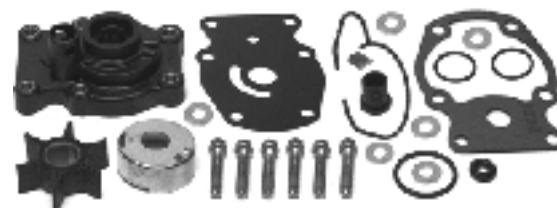

**18-3382**  
**WATER PUMP REPAIR KIT**  
With Housing  
Replaces: 393630  
— CONTAINS —

Sierra #	Desc.	O.E. #	Qty.
18-3051	Impeller	395289	1
18-3359	Impeller Plate	328755	1
18-3367	Housing	393632	1
18-3358	Water Pump Cup	328751	1
18-0124	Impeller Plate Gasket	325537	1
18-2539	Rubber Seal	328753	1
18-3329	Grommet	302497	1
18-7100	O-Ring	301877	1
18-7105	O-Ring	311338	2
18-7146	O-Ring	554545	1
18-3133	Stainless Steel Bolt	331979	6



**18-3383**  
**AP# 13181**  
**WATER PUMP REPAIR KIT**  
With Housing  
Replaces: 395270  
— CONTAINS —

Sierra #	Desc.	O.E. #	Qty.
18-3051	Impeller	395289	1
18-3363	Housing	330560	1
18-3358	Water Pump Cup	328751	1
18-3360	Impeller Housing Gasket	329390	1
18-3329	Grommet	302497	1
18-3133	Stainless Steel Bolt	331979	4

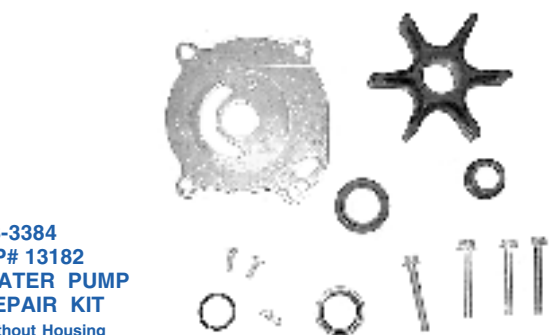

**18-3384**  
**AP# 13182**  
**WATER PUMP REPAIR KIT**  
Without Housing  
Replaces: 386124  
— CONTAINS —

Sierra #	Desc.	O.E. #	Qty.
18-7158	O-Ring	310585	1
18-3108	Flywheel Key	308928	1
18-3043	Impeller	389642	1
18-3182	Impeller Plate	317841	1
18-2026	Oil Seal	321453	1
18-3135	Screw	306643	2
18-3136	Screw	323626	4
18-2390	Grommet	317844	1
18-2389	Grommet	314832	2



**18-3385**  
**WATER PUMP REPAIR KIT**  
Without Housing  
Replaces: 396932  
— CONTAINS —

Sierra #	Desc.	O.E. #	Qty.
18-3368	Impeller	396809	1
18-3343	Impeller Plate	320981	1
18-3361	Impeller Liner	320775	1
18-2705	Seal	315748	1
18-7481	Rubber Seal	324981	1
18-7134	O-Ring	303059	1
18-3337	Water Tube Grommet	315837	1
18-3365	Stainless Steel Bolt	909533	2
18-3369	Stainless Steel Bolt	319126	2



**18-3387**  
**WATER PUMP REPAIR KIT**  
Without Housing  
Replaces: 432956  
— CONTAINS —

Sierra #	Desc.	O.E. #	Qty.
18-2703	Grommet	314008	1
18-3053	Impeller	396725	1
18-2705	Seal	315748	1
18-3133	SS Bolt	908158	4
18-7174	O-Ring	326649	1
18-7481	O-Ring	324981	1
18-2709	Wear Plate Gasket	336530	1
18-3126	Wear Plate	321940	1
18-3127	Impeller Plate	319275	1
18-3138	Impeller Key	334897	1
18-3299	Flywheel Key	331107	1
18-3153	Stainless Steel Bolt	908158	1

APPLICATIONS BEGIN ON PAGE - 170 ALL PARTS SHOWN ARE INCLUDED IN KIT. 18-#S LISTED, ARE AVAILABLE INDIVIDUALLY





# JOHNSON/EVINRUDE (OMC) Cooling System



**18-3388**  
**AP# 1875**  
**WATER PUMP REPAIR KIT**  
Without Housing  
Replaces: 389143  
— CONTAINS —

Sierra #	Desc.	O.E. #	Qty.
18-0969	Impeller Housing Gasket	319586	1
18-3108	Stainless Steel Key	323950	1
18-2703	Grommet	314008	1
18-3127	Impeller Plate	319275	1
18-2705	Seal	315748	1
18-3082	Impeller	382547	1
18-3153	Stainless Steel Bolt	334597	1
18-2709	Wear Plate Gasket	336530	1
18-3133	Stainless Steel Bolt	331979	4
18-3126	Wear Plate	321940	1

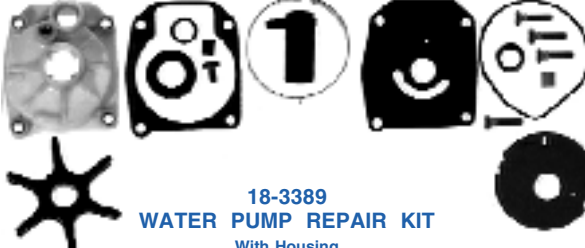

**18-3389**  
**WATER PUMP REPAIR KIT**  
With Housing  
Replaces: 436957  
— CONTAINS —

Sierra #	Desc.	O.E. #	Qty.
18-7481	O-Ring	324981	1
18-2703	Grommet	314008	1
18-3053	Impeller	396725	1
18-3112	Water Tube Guide	319276	1
18-3127	Impeller Plate	319275	1
18-2705	Seal	315748	1
18-3133	Stainless Steel Bolt	908158	1
18-3299	Flywheel Key	331107	1
18-7174	O-Ring	326649	1
18-2709	Wear Plate Gasket	336530	1
18-3129	Housing	435673	1
18-3138	Impeller Key	334897	1
18-3126	Wear Plate	321940	1



**18-3390**  
**WATER PUMP REPAIR KIT**  
Without Housing  
Replaces: 395060  
— CONTAINS —

Sierra #	Desc.	O.E. #	Qty.
18-3059	Impeller	397131,435821	1
18-2557	Impeller Gasket	324701,338484	1
18-3299	Impeller Key	331107	1
18-7158	O-Ring	310967,310585	1
18-3135	Stainless Steel Screw	306643	2
18-2703	Grommet	314008	1
18-2704	Grommet	320943	1
18-2706	Grommet	321008	1
18-3136	Stainless Steel Bolt	323626	4
18-2769	Rubber Seal	332000	1
18-3133	Stainless Steel Bolt	331979	4
18-3131	Pump Cover	338893	1
18-3346	Cup Plate Assy.	435027	1
18-3138	Impeller Key	334897	1

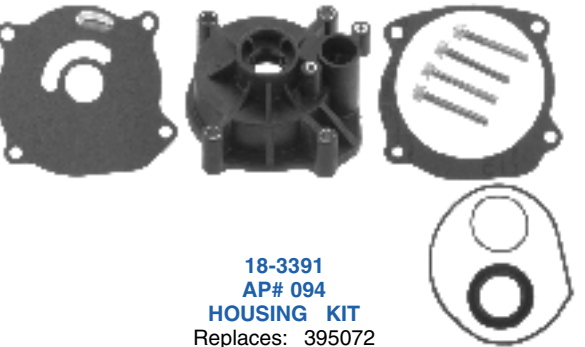

**18-3391**  
**AP# 094**  
**HOUSING KIT**  
Replaces: 395072  
— CONTAINS —

Sierra #	Desc.	O.E. #	Qty.
18-3346	Cup & Plate Assy.	435027	1
18-7482	O-Ring	331353	1
18-2769	O-Ring	332000	1
18-2557	Impeller Plate Gasket	338484,324701	1
18-3130	Housing	4358485	1
18-2704	Grommet	320943	1
18-3136	Stainless Steel Bolt	323626	4
18-3299	Flywheel Key	331107	1
18-3153	Stainless Steel Bolt	908158	1

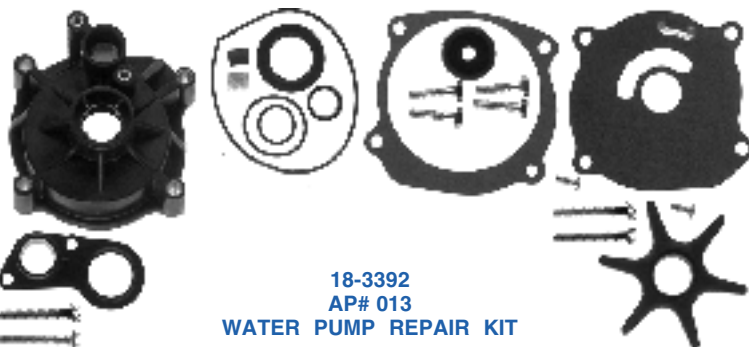

**18-3392**  
**AP# 013**  
**WATER PUMP REPAIR KIT**  
With Housing  
Replaces: 434421  
— CONTAINS —

Sierra #	Desc.	O.E. #	Qty.
18-3059	Impeller	395864,397131,435821	1
18-3346	Cup & Plate Assy.	435027	1
18-3299	Imp.Key	331107	1
18-7158	O-Ring	310967,310585	1
18-3135	Stainless Steel Screw	306643	2
18-2703	Grommet	314008	1
18-2704	Grommet	320943	1
18-2706	Grommet	321008	1
18-3136	Stainless Steel Bolt	323626	4
18-2769	Rubber Seal	332000	1
18-3130	Housing	4358485	1
18-2557	Impeller Gasket	324701,338484	1
18-3131	Pump Cover	338893	1
18-3138	Impeller Key	334897	1
18-3133	Stainless Steel Bolt	331979	4

**OUTBOARD**

APPLICATIONS BEGIN ON PAGE - 170 ALL PARTS SHOWN ARE INCLUDED IN KIT. 18-#S LISTED, ARE AVAILABLE INDIVIDUALLY

# JOHNSON/EVINRUDE (OMC) Cooling System

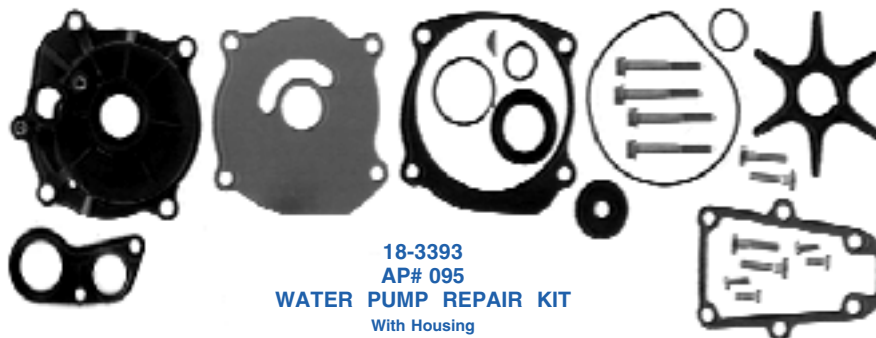

**18-3393  
AP# 095  
WATER PUMP REPAIR KIT**

With Housing  
Replaces: 395073

— CONTAINS —

Sierra #	Desc.	O.E.#	Qty.	Sierra #	Desc.	O.E.#	Qty.
18-3043	Impeller	389642	1	18-2704	Grommet	320943	1
18-2557	Impeller Gasket	324701,338484	1	18-2706	Grommet	321008	1
18-3346	Cup & Plate Assy.	435027	1	18-3136	Stainless Steel Bolt	323626	4
18-3108	Water Pump Key	323950	1	18-2769	O-Ring	332000	1
18-0110	Shift Housing Gasket	324670	1	18-7143	O-Ring	322501	1
18-7158	O-Ring	310967,310585	1	18-3133	Stainless Steel Bolt	331979	4
18-3135	Stainless Steel Screw	306643	2	18-3130	Housing	435485	1
18-2703	Grommet	314008	1	18-3131	Pump Cover	336893	1



**18-3394  
AP# 1917  
WATER PUMP REPAIR KIT**

Without Housing  
Replaces: 433548

— CONTAINS —

Sierra #	Desc.	O.E.#	Qty.
18-7481	O-Ring	324981	1
18-2708	Grommet	333758	1
18-2709	Wear Plate Gasket	336530	1
18-3104	Impeller	432941	1
18-3138	Impeller Key	334897	1
18-2705	Seal	315748	1
18-3128	Impeller Liner	324980	1
18-3133	Stainless Steel Bolt	331979	4
18-3126	Wear Plate	321940	1



**18-3399  
AP# 1990  
WATER PUMP REPAIR KIT**

With Housing  
Replaces: 396933

— CONTAINS —

Sierra #	Desc.	O.E.#	Qty.
18-7134	O-Ring	303059	1
18-3337	Grommet	315837	1
18-3368	Impeller	396809	1
18-2709	Wear Plate Gasket	336530	1
18-3369	Screw (Short)	319126	2
18-2705	Seal	315748	1
18-3331	Water Tube Guide	315838	1
18-3336	Housing	384087	1
18-3365	Screw (Long)	909533	2
18-3343	Wear Plate	320981	1
18-3361	Impeller Liner	320775	1



**18-3400  
AP# 2358  
WATER PUMP REPAIR KIT**

Without Housing  
Replaces: 391698

— CONTAINS —

Sierra #	Desc.	O.E.#	Qty.
18-3050	Impeller	386084	1
18-3178	Impeller Plate	318995	1
18-3179	Water Pump Cup	324097	1
18-3329	Grommet	302497	1
18-2392	Grommet	327035	1
18-2025	Oil Seal	318972	1
18-7116	O-Ring	303097	1
18-3369	Screw	319126	4
18-3326	Pin	300771	1
18-7139	O-Ring	319085	1



**18-3401  
AP# 13186  
WATER PUMP REPAIR KIT**

Without Housing  
Replaces: 395271

— CONTAINS —

Sierra #	Desc.	O.E.#	Qty.
18-3051	Impeller	395289	1
18-3360	Gasket	329398	1
18-3358	Cup	328773	1
18-3340	Washer	318452	4
18-7440	O-Ring	301967	2
18-2013	Oil Seal	321786	1
18-3329	Grommet	302497	1
18-3364	Key	300611,330619	1
18-0108	Gasket	324449	1
18-3133	Stainless Steel Bolt	331979	4

APPLICATIONS BEGIN ON PAGE - 170 ALL PARTS SHOWN ARE INCLUDED IN KIT. 18-#'S LISTED, ARE AVAILABLE INDIVIDUALLY

OUTBOARD



# JOHNSON/EVINRUDE (OMC) Cooling System

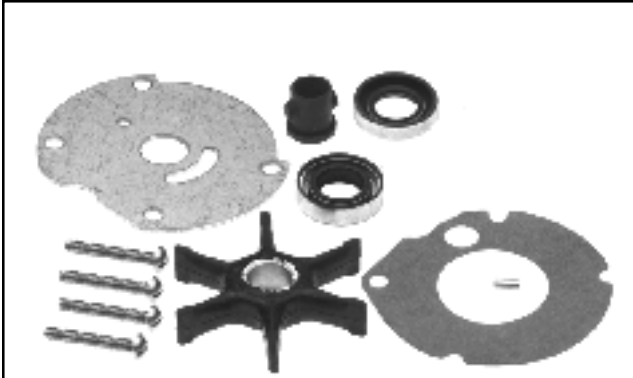

**18-3402**  
**AP# 13187**  
**WATER PUMP REPAIR KIT**  
Without Housing  
Replaces: 382296

— CONTAINS —

Sierra #	Desc.	O.E. #	Qty.
18-3003	Impeller	377178	1
18-3102	Impeller Plate	305303	1
18-2891	Gasket	303339	1
18-3326	Pin	300771	1
18-3329	Grommet	302497	1
18-2023	Oil Seal	313282	1
18-0178	Oil Seal	309607	1



**18-3403**  
**AP# 13188**  
**WATER PUMP REPAIR KIT**  
Without Housing  
Replaces: 388644

— CONTAINS —

Sierra #	Desc.	O.E. #	Qty.
18-7158	O-Ring	310585	1
18-3108	Key	308928	1
18-2703	Grommet	314008	1
18-3135	Screw	306643	4
18-2026	Seal	321453	1
18-3136	Housing Screw	323626	1
18-3043	Impeller	389642	1
18-3120	Impeller Plate	435027	1
18-2536	Gasket	321120	1
18-2704	Grommet	320943	1

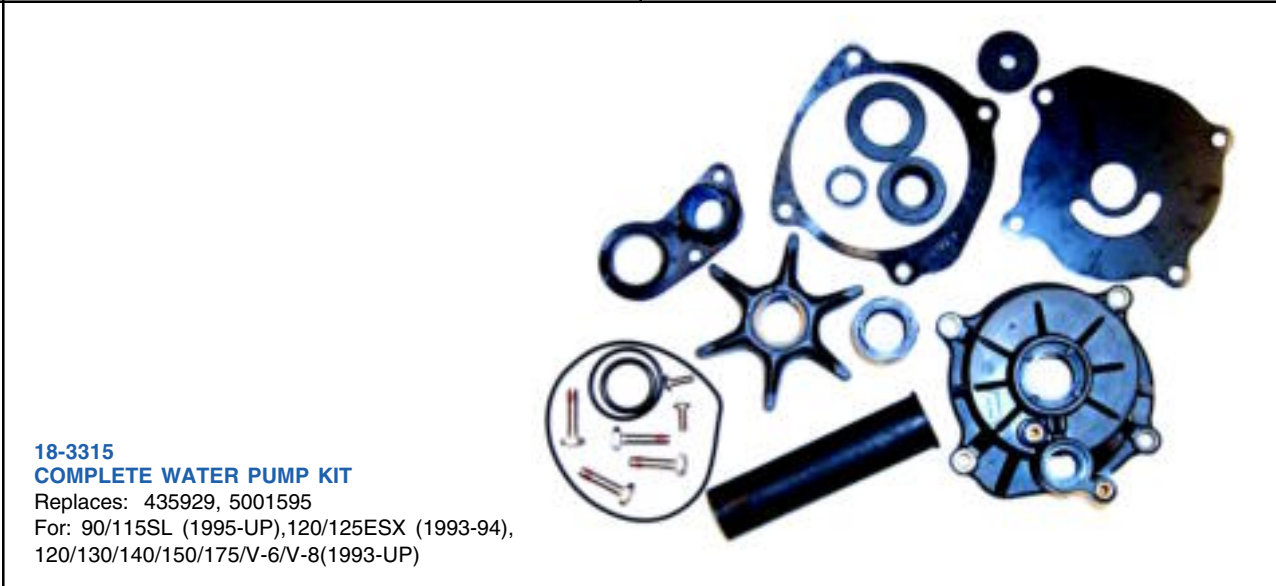

**18-3315**  
**COMPLETE WATER PUMP KIT**  
Replaces: 435929, 5001595  
For: 90/115SL (1995-UP), 120/125ESX (1993-94),  
120/130/140/150/175/V-6/V-8(1993-UP)



**STAINLESS STEEL BOLTS**

Sierra #	AP #	O.E. #	Size	Sierra #	AP #	O.E. #	Size
18-3133	—	331979	1/4 x 20 x 1 1/16"	18-3365	—	909533	1/4 x 20 x 1"
18-3134	—	324960	1/4 x 20 x 1"	18-3369	—	319126	1/4 x 20 x 1"
18-3135 <sup>①</sup>	5194	306643	1/8 x 20 x 1/2"	18-4276	②	324334	1/4 x 20 x 1 1/32"
18-3136 <sup>①</sup>	5189	323626	1/4 x 20 x 1 3/4"	18-4277	②	324430	1/4 x 20 x 2"
18-3153	1758	908158	1/4 x 20 x 1/2"				

① Std. Pkg. of 2    ② Std. Pkg. of 5

APPLICATIONS BEGIN ON NEXT PAGE

**OUTBOARD**

# JOHNSON/EVINRUDE (OMC) Cooling System



Horsepower	Year	Impeller	Impeller Plate	Plate & Cup	Cup	Repair Kit	Pump Kit w/o Hsg.	Pump Kit W/Hsg.	Housing Kit
2 Jr, Colt	1985-90	18-3090	—	—	—	—	—	—	—
3	1952-78	18-3001	18-3101	—	—	18-3201	—	—	—
4	1969-72	18-3001	18-3101	—	—	18-3201	—	—	—
4 ⑦	1973-83	18-3001	18-3101	—	—	18-3201	—	—	—
4 ⑧	1976-80	18-3090	—	—	—	—	—	—	—
4 Deluxe	1980-97	18-3091	—	—	—	—	—	—	—
4.5	1980-97	18-3091	—	—	—	—	—	—	—
5	1965-68	18-3001	—	—	—	—	—	—	—
5 (4-Stroke)	1998-Up	18-3901	—	—	—	—	—	—	—
5.5	1954-64	18-3001	18-3102	—	—	18-3202	—	—	—
6	1952-78	18-3001	18-3102	—	—	18-3202	—	—	—
6	1979	18-3090	—	—	—	—	—	—	—
6	1984-97	18-3091	—	—	—	—	—	—	—
6 (4-Stroke)	1998-Up	18-3901	—	—	—	—	—	—	—
7.5	1954-58	18-3001	18-3102	—	—	18-3202	—	—	—
8 (2-Stroke)	1986-97	18-3091	—	—	—	—	—	—	—
9.5	1964-73	18-3003	18-3102	—	—	—	18-3402	—	—
10	1958-63	18-3003	18-3102	—	—	—	18-3402	—	—
10	1949-57	18-3002	18-3103	—	—	18-3203	18-3377	—	—
9.9/15	1974-Up	18-3050	18-3178	—	18-3179	—	18-3400	18-3327	18-3180
9.9/15 (4-Stroke)	1995-Up	18-3050	18-3178	—	18-3179	—	18-3400	18-3327	18-3180
15,18	1953-65	18-3002	—	—	—	18-3203	18-3377	—	—
20	1966-73	18-3002	—	—	—	18-3203	18-3377	—	—
20	1982-84	18-3051	18-3362	—	18-3358	—	18-3401	18-3383	18-3363
20	1985-Up	18-3051	18-3359	—	18-3358	—	18-3381	18-3382	18-3367
25	1951-55	18-3006	—	—	—	—	—	—	—
25	1969-78	18-3002	18-3103	—	—	18-3203	18-3377	—	—
25	1979-84	18-3051	18-3362	—	18-3358	—	18-3401	18-3383	18-3363
25	1985-Up	18-3051	18-3359	—	18-3358	—	18-3381	18-3382	18-3367
28	1962-64	18-3006	—	—	—	—	—	—	—
28	1978-Up	18-3051	18-3362	—	18-3358	—	18-3401	18-3383	18-3363
30	1951-57	18-3006	—	—	—	—	—	—	—
30	1984-Up	18-3051	18-3359	—	18-3358	—	18-3381	18-3382	18-3367
33	1962-71	18-3006	—	—	—	—	—	—	—
35	1951-57	18-3006	—	—	—	—	—	—	—
35	1958-59	18-3083	—	—	—	—	—	—	—
35	1976-77	18-3006	—	—	—	—	—	—	—
35	1978-79	18-3051	—	—	—	—	18-3238	—	—
35	1980-82	18-3051	N/A	—	18-3358	—	—	18-3382	18-3367
35	1983-Up	18-3051	18-3359	—	18-3358	—	—	—	—
35 Jet	1992-93	18-3104	—	—	—	—	18-3394	—	—
40	1960-70	18-3083	—	—	—	—	—	—	—
40	1971-73	18-3006	—	—	—	—	—	—	—
40 Comm.	1981-90	18-3366	18-3352	—	18-3353	—	18-3379	—	—
40	1984-85	18-3055	18-3343	—	—	—	18-3385	18-3399	18-3336
40	1986-88	18-3368	18-3343	—	—	—	18-3385	18-3399	18-3336
40	1989-98	18-3104	—	—	—	—	18-3394	—	—
40	1999-Up	18-3053	—	—	—	—	18-3394	—	—
45/55 Comm.	1985	18-3055	18-3338	—	—	—	18-3380	—	18-3336
45/55	1989	18-3368	18-3343	—	—	—	18-3385	18-3399	18-3336
45/55 Comm.	1986-88,	18-3368	18-3120	—	—	—	18-3385	18-3399	18-3336
48	1987-88	18-3368	18-3343	—	—	—	18-3385	18-3399	18-3336
48	1989-96	18-3104	18-3127	—	—	—	18-3394	—	—
50	1971-78	18-3083	18-3343	—	—	—	18-3376	—	—
50	1979-85	18-3055	18-3343	—	—	—	18-3380	18-3378	18-3336
50	1986-88	18-3368	18-3343	—	—	—	18-3385	18-3399	18-3336
50	1989-98	18-3104	—	—	—	—	18-3394	—	—
55	1968-69	18-3082	—	—	—	—	—	—	—
55	1976-78	18-3083	—	—	—	—	—	—	18-3336
55	1979-85	18-3055	18-3343	—	—	—	18-3380	18-3378	18-3336
60	1964-67	18-3005	—	—	—	—	—	—	—
60	1970-71	18-3082	—	—	—	—	—	—	—
60	1980-85	18-3055	—	—	—	—	18-3380	18-3378	18-3336
60	1986-94	18-3053	18-3127	—	—	—	18-3387	18-3389	—
60	1995-Up	18-3053	18-3127	—	—	—	18-3387	—	—

① Except chrome pumps      ③ "S" Suffix      ⑤ Except 1993-94 25" & 30" V6 & V8  
 ② Except SL models 1995 & Up/FFI models      ④ "F" Suffix      ⑦ For water pumps using 1 water tube      ⑧ 90 degree gearcase

**OUTBOARD**





# JOHNSON/EVINRUDE (OMC) Cooling System

Horsepower	Year	Sierra Impeller	Sierra Impeller Plate	Sierra Plate & Cup	Sierra Cup	Sierra Repair Kit	Sierra Pump Kit w/o Hsg.	Sierra Pump Kit W/Hsg.	Sierra Housing Kit
65	1968	18-3005	—	—	—	—	—	—	—
65	1972-73	18-3082	—	—	—	—	—	—	—
65 Comm.	1984-94	18-3053	18-3127	—	—	—	18-3387	18-3389	—
65 Comm.	1995-Up	18-3053	18-3127	—	—	—	18-3387	—	—
70	1974-78	18-3082	18-3127	—	—	—	18-3388	—	—
70	1979-94	18-3053	18-3127	—	—	—	18-3387	18-3389	—
70	1995-Up	18-3053	18-3127	—	—	—	18-3387	—	—
75	1960-65	18-3005	—	—	—	—	—	—	—
75	1974-78	18-3082	18-3127	—	—	—	18-3388	—	—
75	1979-88	18-3053	18-3127	18-3127	—	—	18-3387	18-3389	18-3129
80	1966-67	18-3005	—	—	—	—	—	—	—
85	1968	18-3005	—	—	—	—	—	—	—
85	1969-72	18-3044	18-3182	—	—	—	—	—	—
85	1973-77	18-3043	18-3182	—	—	—	18-3384	—	—
85	1978	18-3043	—	18-3346	—	—	—	18-3393 <sup>⑦</sup>	18-3391
85	1979-95	18-3059	—	18-3346	—	18-3211	18-3390	18-3392	18-3391
90	1964-68	18-3005	—	—	—	—	—	—	—
90	1979-Up	18-3059	—	18-3346	—	18-3211	18-3390	18-3392 <sup>②</sup>	18-3391
90 SL,DI	1995 & UP	18-3059	—	18-3346	—	18-3211	18-3390	18-3315	18-3405
100	1969-72	18-3044	—	—	—	—	—	—	—
100	1979-Up	18-3059	—	18-3346	—	18-3211	18-3390	18-3392	18-3391
100 Comm. ①	1984-Up	18-3059	—	18-3346	—	18-3211	18-3390	18-3392	18-3391
105 Comm.	1998-2001	18-3059	—	18-3346	—	18-3211	18-3390	18-3315	18-3405
115	1969-70	18-3044	—	—	—	—	—	—	—
115	1973-76	18-3043	—	—	—	—	18-3384	—	—
115	1977-78	18-3043	—	18-3346	—	—	—	18-3393 <sup>⑦</sup>	18-3391
115	1979-Up	18-3059	—	18-3346	—	18-3211	18-3390	18-3392 <sup>②</sup>	18-3391
115 SL,DL	1995 & UP	18-3059	—	18-3346	—	18-3211	18-3390	18-3315	18-3405
120 25" ④	1993-2000	18-3059	—	18-3346	—	18-3211	18-3390	18-3315	18-3405
125	1971-72	18-3044	—	—	—	—	—	—	—
125 ESX 25" ③	1993-94	18-3059	—	18-3346	—	18-3211	18-3390	18-3392	18-3391
125 ESX 25" ④	1994-95	18-3059	—	18-3346	—	18-3211	18-3390	18-3392	18-3391
125 ESX 25" ④	1993-94	18-3059	—	18-3346	—	18-3211	18-3390	—	—
130	1997 & UP	18-3059	—	18-3346	—	18-3211	18-3390	18-3315	18-3405
130 25"	1994-2000	18-3059	—	18-3346	—	18-3211	18-3390	18-3315	18-3405
135	1973-75	18-3043	18-3182	—	—	18-3210	18-3384	—	—
135	1976	18-3043	18-3182	—	—	—	—	—	—
135 25"	2001	18-3059	—	18-3346	—	18-3211	18-3390	18-3315	18-3405
140	1977-78	18-3043	—	18-3346	—	—	—	18-3393 <sup>⑦</sup>	18-3391
140	1979-Up	18-3059	—	18-3346	—	18-3211	18-3390	18-3392	18-3391
140 25" ④	1993	18-3059	—	18-3346	—	18-3211	18-3390	18-3315	18-3405
140 25"	1994-2000	18-3059	—	18-3346	—	18-3211	18-3390	18-3315	18-3405
150	1976-78	18-3043	—	18-3346	—	18-3210	—	18-3393 <sup>⑦</sup>	18-3391
150	1979-Up	18-3059	—	18-3346	—	18-3211	18-3390	18-3392	18-3391
150 20"	1993 & UP	18-3059	—	18-3346	—	18-3211	18-3390	18-3392	18-3391
150 SL 20"	1994-98	18-3059	—	18-3346	—	18-3211	18-3390	18-3315	18-3405
150 EL 20"	1996-98	18-3059	—	18-3346	—	18-3211	18-3390	18-3315	18-3405
150 25"	1993 & UP	18-3059	—	18-3346	—	18-3211	18-3390	18-3315	18-3405
150 DI	1997 & UP	18-3059	—	18-3346	—	18-3211	18-3390	18-3315	18-3405
150	2000 & UP	18-3059	—	18-3346	—	18-3211	18-3390	18-3315	18-3405
175	1976-78	18-3043	—	18-3346	—	18-3210	—	18-3393 <sup>⑦</sup>	18-3391
175 SL 20"	1994-98	18-3059	—	18-3346	—	18-3211	18-3390	18-3315	18-3405
175 EL 20"	1996-98	18-3059	—	18-3346	—	18-3211	18-3390	18-3315	18-3405
175 25"	1993 & UP	18-3059	—	18-3346	—	18-3211	18-3390	18-3315	18-3405
175 DI	1997 & UP	18-3059	—	18-3346	—	18-3211	18-3390	18-3315	18-3405
175	2000 & UP	18-3059	—	18-3346	—	18-3211	18-3390	18-3315	18-3405
200	1976-78	18-3043	—	18-3346	—	—	—	18-3393 <sup>⑦</sup>	18-3391
200 Comm.	1990	18-3059	—	18-3346	—	18-3211	18-3390	18-3392	18-3391
200 25" & 30"	1993-97	18-3059	—	18-3346	—	18-3211	18-3390	18-3315	18-3405
225 20"	1993 & UP	18-3059	—	18-3346	—	18-3211	18-3390	18-3392	18-3391
225 25" & 30"	1993-97	18-3059	—	18-3346	—	18-3211	18-3390	18-3315	18-3405
235	1978	18-3043	—	18-3346	—	—	—	18-3393 <sup>⑦</sup>	18-3391
235	1979-Up	18-3059	—	18-3346	—	18-3211	18-3390	18-3392	18-3391
V4 Cross 20" & 25"	1993 & UP	18-3059	—	18-3346	—	18-3211	18-3390	18-3392	18-3391
V4 Loop 20"	1993 & UP	18-3059	—	18-3346	—	18-3211	18-3390	18-3392	18-3391
V4,V6,V8 ⑤	1982-94	18-3059	—	18-3346	—	18-3211	18-3390	18-3392	18-3391
V6,V8 20"	1993 & UP	18-3059	—	18-3346	—	18-3211	18-3390	18-3392	18-3391
V6&V8 25"&30"	1993 & UP	18-3059	—	18-3346	—	18-3211	18-3390	18-3315	18-3405
Sea Drives	1979-Up	18-3059	—	18-3346	—	18-3211	18-3390	18-3392 <sup>⑥</sup>	18-3391

① Except chrome pumps

④ "F" Suffix

⑦ For water pumps using 1 water tube

② Except SL models 1995 & Up/FFI models

⑤ Except 1993-94 25" & 30" V6 & V8

⑧ 90 degree gearcase

③ "S" Suffix

⑥ Except high pressure pumps

# JOHNSON/EVINRUDE (OMC) Cooling System



OUTBOARD

 <p><b>18-3563</b> AP# 2656 <b>VALVE</b> V-6 Crossflow Replaces: 321027</p>	 <p><b>18-3564</b> AP# 2652 <b>VALVE</b> V-4 Crossflow Replaces: 318395</p>	 <p><b>18-1219</b> AP# 1960 <b>VALVE SEAT</b> V-6 Crossflow Replaces: 320880</p>	<p>PKG. OF 2</p>  <p><b>18-1221</b> AP# 1961 <b>VALVE CUP</b> V-4/V-6 Loop Charge Replaces: 330273</p>	 <p><b>18-3562</b> AP# 2657 <b>VALVE CUP</b> V-6 Crossflow Replaces: 321222</p>																												
 <p><b>18-1243</b> AP# 2653 <b>VALVE SPRING</b> V-4/V-6 Crossflow Replaces: 317245</p>	 <p><b>18-1222</b> AP# 2210 <b>VALVE DIAPHRAGM</b> V-4/V-6 Loop Charge Replaces: 394408</p>	 <p><b>18-3567</b> AP# 2655 <b>VALVE DIAPHRAGM</b> V-6 Crossflow Replaces: 321221</p>	 <p><b>18-3565</b> AP# 2654 <b>VALVE RETAINER</b> V-6 Crossflow Replaces: 321220</p>	 <p><b>18-2391</b> AP# 2651 <b>GROMMET</b> V-4 Crossflow Replaces: 321692</p>																												
<p><b>NEW</b></p>  <p><b>18-3500</b> <b>THERMOSTAT 140°</b> Replaces: 434137 For: 3 cyl. (1992 &amp; UP), 90° Looper (1990-1992)</p>	<p>Display Package</p>  <p><b>18-3553</b> AP# 403 <b>THERMOSTAT</b> Replaces: 393659, 434841, 378065, 508626 143°</p>	 <p><b>18-3557</b> AP# 422 <b>THERMOSTAT</b> Replaces: 396987, 382385 143°</p>	 <p><b>18-3561</b> <b>THERMOSTAT</b> Replaces: 436195 143°</p>	<p><b>NEW</b></p>  <p><b>18-1506</b> <b>VERNATHERM</b> Replaces: 394411 For: 10/15 (1993-95), 60/125/185 (1989-90), 65 (1987-89), 70/200/225 (1986-90), 120/140/300 (1985-90), 275 (1985-88)</p>																												
 <p><b>18-3560</b> AP# 13196 <b>VERNATHERM</b> Replaces: 384719 105° Fits most 3 &amp; 4 cyl., 1985-90</p>	<p>Display Package</p>  <p><b>18-3669</b> AP# 423 <b>THERMOSTAT KIT</b> — CONTENTS —</p> <table border="1"> <thead> <tr> <th>Sierra #</th> <th>AP#</th> <th>Description</th> <th>O.E. #</th> </tr> </thead> <tbody> <tr> <td>18-3557</td> <td>422</td> <td>Thermostat</td> <td>396987</td> </tr> <tr> <td>18-2548</td> <td>777</td> <td>Thermostat Cover Gasket</td> <td>332108</td> </tr> <tr> <td>18-0929</td> <td>946</td> <td>Thermostat Gasket</td> <td>313416</td> </tr> </tbody> </table>		Sierra #	AP#	Description	O.E. #	18-3557	422	Thermostat	396987	18-2548	777	Thermostat Cover Gasket	332108	18-0929	946	Thermostat Gasket	313416	 <p><b>18-3672</b> AP# 456 <b>THERMOSTAT KIT</b> — CONTENTS —</p> <table border="1"> <thead> <tr> <th>Sierra #</th> <th>AP#</th> <th>Description</th> <th>O.E. #</th> </tr> </thead> <tbody> <tr> <td>18-3553</td> <td>403</td> <td>Thermostat</td> <td>434841</td> </tr> <tr> <td>18-0182</td> <td>424</td> <td>Thermostat Gasket</td> <td>310058</td> </tr> </tbody> </table>		Sierra #	AP#	Description	O.E. #	18-3553	403	Thermostat	434841	18-0182	424	Thermostat Gasket	310058
Sierra #	AP#	Description	O.E. #																													
18-3557	422	Thermostat	396987																													
18-2548	777	Thermostat Cover Gasket	332108																													
18-0929	946	Thermostat Gasket	313416																													
Sierra #	AP#	Description	O.E. #																													
18-3553	403	Thermostat	434841																													
18-0182	424	Thermostat Gasket	310058																													
 <p><b>AP# 2658</b> <b>18-3673</b> <b>THERMOSTAT KIT</b> V-4 Crossflow</p>	 <p><b>AP# 2659</b> <b>18-3674</b> <b>THERMOSTAT KIT</b> V-6 Crossflow</p>	 <p><b>18-3566</b> AP# 2782 <b>TELL TALE</b> <b>HOSE ELBOW</b> Replaces: 331894</p>	<p><b>NEW</b></p>  <p><b>18-1507</b> <b>THERMOSTAT</b> <b>SEAL</b> Replaces: 335981 For: 60° V-4 &amp; V-6</p>	<p><b>NEW</b></p>  <p><b>18-1734</b> <b>THERMOSTAT</b> <b>SEAL</b> Replaces: 334742 For: OMC thermostat application 6, 8, 10, 15, 40, 48, 50 HP (1989-94)</p>																												

APPLICATION BEGINS ON PAGE 174

**Crossflow  
V-4 Engine**

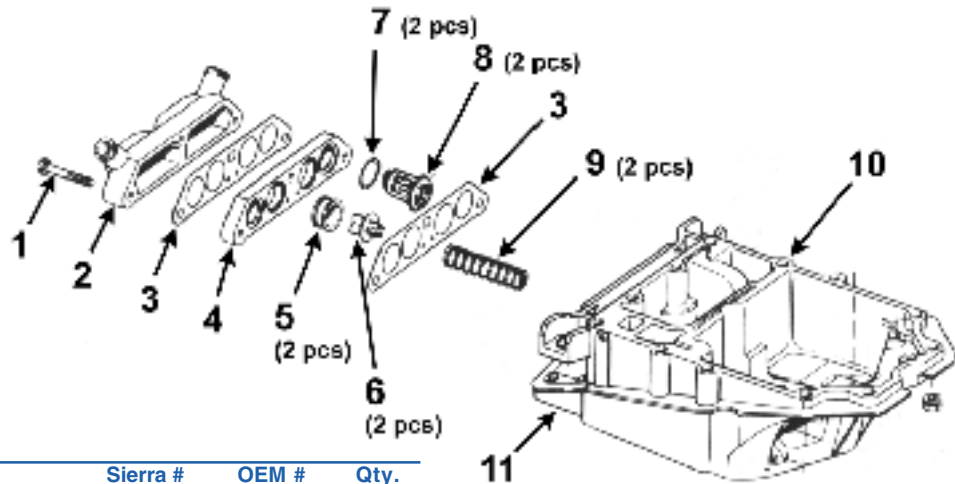

Fig. #	Description	Sierra #	OEM #	Qty.
1.	Screw Cover	—	305652	3
2.	Cover	—	321690	1
3.	Gasket	18-0977	332369	2
4.	Valve Body	—	321693	1
5.	Grommet	18-2391	321692	2
6.	Valve	18-3564	318395	2
7.	Thermostat Gasket	—	321932	2
			434841,	
8.	Thermostat	18-3553	393659	2
9.	Spring	18-1243	317245	2
10. ①	Adapter to Powerhead Gasket	18-0957	318373	1
10. ②	Adapter to Powerhead Gasket	18-2864	321727	1
11.	Adapter	—	331039	1

① Year/Models 1973-1977    ② Year/Models 1978-1996

**Crossflow  
V-6 Engine**

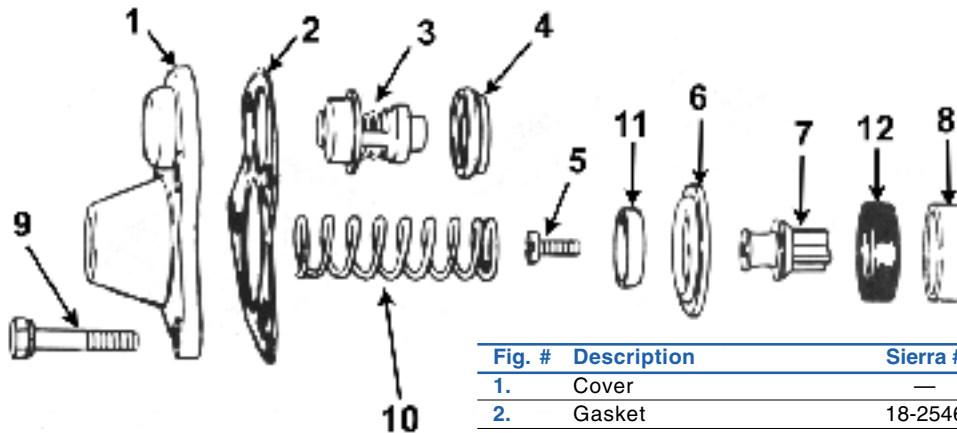

Fig. #	Description	Sierra #	OEM #	Qty.
1.	Cover	—	321013	1
2.	Gasket	18-2546	321184	1
3.	Thermostat	18-3553	434841, 393659	1
4.	Thermostat Gasket	18-0182	310058	1
5.	Stainless Steel Bolt	18-3135	306643	1
6.	Seal	18-3567	321221	1
7.	Valve	18-3563	321027	1
8.	Washer	18-3562	321222	1
9.	Screw	—	306778	4
10.	Spring	18-1243	317245	1
11.	Retainer	18-3565	321220	1
12.	Grommet	18-1219	320880	1

Courtesy of Seloc Publishing

APPLICATION ON NEXT PAGE

# JOHNSON/EVINRUDE (OMC) Cooling System



**OUTBOARD**

HP	Years	Thermostat Kit	Thermostat	Valve	Valve Seat	Valve Diaphragm	Valve Retainer	Valve Cup	Valve Spring	Grommet
5	1965-68, 1986	18-3672 ⑤	18-3553	—	—	—	—	—	—	—
5.5	1959-64	18-3672 ⑤	18-3553	—	—	—	—	—	—	—
6	1965-79, 1986	18-3672 ⑤	18-3553	—	—	—	—	—	—	—
7.5	1980-86	18-3672 ⑤	18-3553	—	—	—	—	—	—	—
8	1986	18-3672 ⑤	18-3553	—	—	—	—	—	—	—
9.5	1964-73	18-3672 ⑤	18-3553	—	—	—	—	—	—	—
9.9	1974-86	18-3672 ⑤	18-3553	—	—	—	—	—	—	—
10	1959-63	18-3672 ⑤	18-3553	—	—	—	—	—	—	—
15	1974-86	18-3672 ⑤	18-3553	—	—	—	—	—	—	—
18	1959-73	18-3672 ⑤	18-3553	—	—	—	—	—	—	—
20	1981-94	18-3672 ⑤	18-3553	—	—	—	—	—	—	—
25 ①	1969-94	18-3672 ⑤	18-3553	—	—	—	—	—	—	—
28	1989-94	18-3672 ⑤	18-3553	—	—	—	—	—	—	—
30	1986-94	18-3672 ⑤	18-3553	—	—	—	—	—	—	—
35	1959, 1976-94	18-3672 ⑤	18-3553	—	—	—	—	—	—	—
40	1960-69	18-3672 ⑤	18-3553	—	—	—	—	—	—	—
45	1989-92 ②	18-3672 ⑤	18-3553	—	—	—	—	—	—	—
50	1971-75, 1979, 1981-86	18-3672 ⑤	18-3553	—	—	—	—	—	—	—
55	1976-92 ③	18-3672 ⑤	18-3553	—	—	—	—	—	—	—
60	1969-70	18-3669 ⑤	18-3557	—	—	—	—	—	—	—
60	1980-86	18-3672 ⑤	18-3553	—	—	—	—	—	—	—
60, 60TTL	1993	—	18-3561	—	—	—	—	—	—	—
65	1971-73	18-3669	18-3557	—	—	—	—	—	—	—
65	1993	—	18-3561	—	—	—	—	—	—	—
65C	1984-86	18-3669	18-3557	—	—	—	—	—	—	—
65 Jet	1994-95	18-3673	18-3553	18-3564	—	—	—	—	18-1243	18-2391
70	1974-86	18-3669	18-3557	—	—	—	—	—	—	—
70,70TTL	1993	—	18-3561	—	—	—	—	—	—	—
75	1978-88	18-3669	18-3557	—	—	—	—	—	—	—
80 Jet	1994-95	18-3673	18-3553	18-3564	—	—	—	—	18-1243	18-2391
85	1978-80	18-3673	18-3553	18-3564	—	—	—	—	18-1243	18-2391
85	1993-95	18-3673	18-3553	18-3564	—	—	—	—	18-1243	18-2391
88	1987-95	18-3673	18-3553	18-3564	—	—	—	—	18-1243	18-2391
90 ④	1983-95	18-3673	18-3553	18-3564	—	—	—	—	18-1243	18-2391
90 Jet	1994	18-3673	18-3553	18-3564	—	—	—	—	18-1243	18-2391
100	1979-80	18-3673	18-3553	18-3564	—	—	—	—	18-1243	18-2391
100	1990-95	18-3673	18-3553	18-3564	—	—	—	—	18-1243	18-2391
100 Comm	1984-95	18-3673	18-3553	—	18-3564	—	—	—	—	—
110	1985-89	18-3673	18-3553	18-3564	—	—	—	—	18-1243	18-2391
112	1994-95	18-3673	18-3553	18-3564	—	—	—	—	18-1243	18-2391
115 ④	1978-95	18-3673	18-3553	18-3564	—	—	—	—	18-1243	18-2391
120	1988-91	—	—	—	—	18-1222	—	18-1221	—	—
140	1978-85	18-3673	18-3553	18-3564	—	—	—	—	18-1243	18-2391
140	1988-91	—	—	—	—	—	18-1222	—	18-1221	—
150	1978-91	18-3672 ⑤	18-3553	18-3563	18-1219	18-3567	18-3565	18-3562	18-1243	180182
155	1984-91	18-3672 ⑤	18-3553	18-3563	18-1219	18-3567	18-3565	18-3562	18-1243	18-0182
175	1977-91	18-3672 ⑤	18-3553	18-3563	18-1219	18-3567	18-3565	18-3562	18-1243	18-0182
185	1984-85	18-3672 ⑤	18-3553	18-3563	18-1219	18-3567	18-3565	18-3562	18-1243	18-0182
200	1977-83	18-3672 ⑤	18-3553	18-3563	18-1219	18-3567	18-3565	18-3562	18-1243	18-0182
200	1988-93	—	—	—	—	18-1222	18-3565	18-1221	—	—
225	1988-93	—	—	—	—	18-1222	18-3565	18-1221	—	—
235	1978-85	18-3672 ⑤	18-3553	18-3563	18-1219	18-3567	18-3565	18-3562	18-1243	18-0182

① All 1989-91 models except DR & DT

② Commercial

③ Commercial also

④ Except 60 degree models

⑤ For complete Thermostat Kit including gaskets & spring use 18-3674