



Gear Housing Seal Kits







Gear Housing Seal Kits

Features...

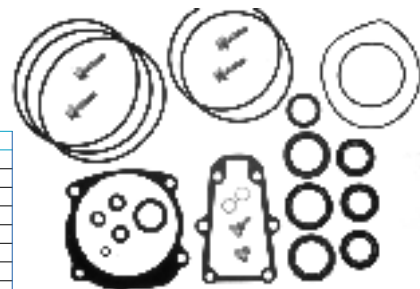
- ★ Seals and o-rings designed for marine use.
- ★ Kits include all necessary parts to do a complete reseal.
- ★ Easy, quick reference application chart in our catalog.









OUTBOARD

<p style="text-align: center;">— CONTAINS —</p> <table border="1"> <thead> <tr> <th>Sierra #</th> <th>Desc.</th> <th>O.E.#</th> <th>Qty.</th> </tr> </thead> <tbody> <tr><td>18-0110</td><td>Shift Housing Gasket</td><td>314082</td><td>1</td></tr> <tr><td>18-2001</td><td>Seal</td><td>330137</td><td>2</td></tr> <tr><td>18-2002</td><td>Seal</td><td>320862</td><td>2</td></tr> <tr><td>18-2026</td><td>Seal</td><td>321453</td><td>2</td></tr> <tr><td>18-2061</td><td>Seal</td><td>329922</td><td>1</td></tr> <tr><td>18-2062</td><td>Seal</td><td>329923</td><td>1</td></tr> <tr><td>18-2377</td><td>Screw</td><td>316563</td><td>4</td></tr> <tr><td>18-2378</td><td>Magnetic Drain Screw</td><td>318544</td><td>1</td></tr> <tr><td>18-2536</td><td>O-Ring</td><td>315788</td><td>1</td></tr> <tr><td>18-2557</td><td>Impeller Gasket</td><td>338484</td><td>1</td></tr> <tr><td>18-4248</td><td>Washer</td><td>311598</td><td>2</td></tr> <tr><td>18-7109</td><td>O-Ring</td><td>317178</td><td>1</td></tr> <tr><td>18-7120</td><td>O-Ring</td><td>307853</td><td>1</td></tr> <tr><td>18-7127</td><td>O-Ring</td><td>313446</td><td>1</td></tr> <tr><td>18-7130</td><td>O-Ring</td><td>314728</td><td>1</td></tr> <tr><td>18-7133</td><td>O-Ring</td><td>305123</td><td>2</td></tr> <tr><td>18-7137</td><td>O-Ring</td><td>318372</td><td>2</td></tr> <tr><td>18-7142</td><td>O-Ring</td><td>322119</td><td>1</td></tr> <tr><td>18-7144</td><td>O-Ring</td><td>333572</td><td>3</td></tr> <tr><td>18-7145</td><td>O-Ring</td><td>332584</td><td>1</td></tr> <tr><td>18-7475</td><td>Washer</td><td>328743</td><td>4</td></tr> <tr><td>18-8300</td><td>Seal</td><td>341280</td><td>1</td></tr> <tr><td>18-8301</td><td>Seal</td><td>341281</td><td>1</td></tr> </tbody> </table>		Sierra #	Desc.	O.E.#	Qty.	18-0110	Shift Housing Gasket	314082	1	18-2001	Seal	330137	2	18-2002	Seal	320862	2	18-2026	Seal	321453	2	18-2061	Seal	329922	1	18-2062	Seal	329923	1	18-2377	Screw	316563	4	18-2378	Magnetic Drain Screw	318544	1	18-2536	O-Ring	315788	1	18-2557	Impeller Gasket	338484	1	18-4248	Washer	311598	2	18-7109	O-Ring	317178	1	18-7120	O-Ring	307853	1	18-7127	O-Ring	313446	1	18-7130	O-Ring	314728	1	18-7133	O-Ring	305123	2	18-7137	O-Ring	318372	2	18-7142	O-Ring	322119	1	18-7144	O-Ring	333572	3	18-7145	O-Ring	332584	1	18-7475	Washer	328743	4	18-8300	Seal	341280	1	18-8301	Seal	341281	1	 <p style="text-align: center;">18-2623 AP# 3951 GEAR HOUSING SEAL KIT Replaces: 439141</p>	 <p style="text-align: center;">18-2656 GEAR HOUSING SEAL KIT Replaces: 396350</p> <p style="text-align: center;">— CONTAINS —</p> <table border="1"> <thead> <tr> <th>Sierra #</th> <th>Desc.</th> <th>O.E.#</th> <th>Qty.</th> </tr> </thead> <tbody> <tr><td>18-0189</td><td>Shift Rod Washer</td><td>321738</td><td>1</td></tr> <tr><td>18-2025</td><td>Oil Seal</td><td>318971</td><td>1</td></tr> <tr><td>18-2028</td><td>Oil Seal</td><td>321480</td><td>2</td></tr> <tr><td>18-2029</td><td>Oil Seal</td><td>321481</td><td>2</td></tr> <tr><td>18-4248</td><td>Washer</td><td>311598</td><td>2</td></tr> <tr><td>18-7100</td><td>O-Ring</td><td>301877</td><td>1</td></tr> <tr><td>18-7104</td><td>O-Ring</td><td>308627</td><td>1</td></tr> <tr><td>18-7120</td><td>O-Ring</td><td>307853, 322598</td><td>1</td></tr> <tr><td>18-7139</td><td>O-Ring</td><td>319085</td><td>1</td></tr> <tr><td>18-7145</td><td>O-Ring</td><td>333572</td><td>2</td></tr> </tbody> </table>	Sierra #	Desc.	O.E.#	Qty.	18-0189	Shift Rod Washer	321738	1	18-2025	Oil Seal	318971	1	18-2028	Oil Seal	321480	2	18-2029	Oil Seal	321481	2	18-4248	Washer	311598	2	18-7100	O-Ring	301877	1	18-7104	O-Ring	308627	1	18-7120	O-Ring	307853, 322598	1	18-7139	O-Ring	319085	1	18-7145	O-Ring	333572	2																																			
Sierra #	Desc.	O.E.#	Qty.																																																																																																																																																																															
18-0110	Shift Housing Gasket	314082	1																																																																																																																																																																															
18-2001	Seal	330137	2																																																																																																																																																																															
18-2002	Seal	320862	2																																																																																																																																																																															
18-2026	Seal	321453	2																																																																																																																																																																															
18-2061	Seal	329922	1																																																																																																																																																																															
18-2062	Seal	329923	1																																																																																																																																																																															
18-2377	Screw	316563	4																																																																																																																																																																															
18-2378	Magnetic Drain Screw	318544	1																																																																																																																																																																															
18-2536	O-Ring	315788	1																																																																																																																																																																															
18-2557	Impeller Gasket	338484	1																																																																																																																																																																															
18-4248	Washer	311598	2																																																																																																																																																																															
18-7109	O-Ring	317178	1																																																																																																																																																																															
18-7120	O-Ring	307853	1																																																																																																																																																																															
18-7127	O-Ring	313446	1																																																																																																																																																																															
18-7130	O-Ring	314728	1																																																																																																																																																																															
18-7133	O-Ring	305123	2																																																																																																																																																																															
18-7137	O-Ring	318372	2																																																																																																																																																																															
18-7142	O-Ring	322119	1																																																																																																																																																																															
18-7144	O-Ring	333572	3																																																																																																																																																																															
18-7145	O-Ring	332584	1																																																																																																																																																																															
18-7475	Washer	328743	4																																																																																																																																																																															
18-8300	Seal	341280	1																																																																																																																																																																															
18-8301	Seal	341281	1																																																																																																																																																																															
Sierra #	Desc.	O.E.#	Qty.																																																																																																																																																																															
18-0189	Shift Rod Washer	321738	1																																																																																																																																																																															
18-2025	Oil Seal	318971	1																																																																																																																																																																															
18-2028	Oil Seal	321480	2																																																																																																																																																																															
18-2029	Oil Seal	321481	2																																																																																																																																																																															
18-4248	Washer	311598	2																																																																																																																																																																															
18-7100	O-Ring	301877	1																																																																																																																																																																															
18-7104	O-Ring	308627	1																																																																																																																																																																															
18-7120	O-Ring	307853, 322598	1																																																																																																																																																																															
18-7139	O-Ring	319085	1																																																																																																																																																																															
18-7145	O-Ring	333572	2																																																																																																																																																																															
 <p>18-2657 AP# 079 GEAR HOUSING SEAL KIT Replaces: 396352</p> <p style="text-align: center;">— CONTAINS —</p> <table border="1"> <thead> <tr> <th>Sierra #</th> <th>Desc.</th> <th>O.E.#</th> <th>Qty.</th> </tr> </thead> <tbody> <tr><td>18-0882</td><td>Shift Rod Gasket</td><td>304764</td><td>1</td></tr> <tr><td>18-0108</td><td>Lower Gearcase Gasket</td><td>324449</td><td>1</td></tr> <tr><td>18-3360</td><td>Impeller Housing Gasket</td><td>329390</td><td>1</td></tr> <tr><td>18-7411</td><td>O-Ring</td><td>—</td><td>1</td></tr> <tr><td>18-2027</td><td>Oil Seal</td><td>321459</td><td>2</td></tr> <tr><td>18-2031</td><td>Oil Seal</td><td>321787</td><td>1</td></tr> <tr><td>18-2063</td><td>Oil Seal</td><td>330327</td><td>1</td></tr> <tr><td>18-4248</td><td>Washer</td><td>311598</td><td>2</td></tr> <tr><td>18-7100</td><td>O-Ring</td><td>301877</td><td>1</td></tr> <tr><td>18-7145</td><td>O-Ring</td><td>333572</td><td>2</td></tr> <tr><td>18-7475</td><td>Quad Ring</td><td>332583</td><td>—</td></tr> </tbody> </table>	Sierra #	Desc.	O.E.#	Qty.	18-0882	Shift Rod Gasket	304764	1	18-0108	Lower Gearcase Gasket	324449	1	18-3360	Impeller Housing Gasket	329390	1	18-7411	O-Ring	—	1	18-2027	Oil Seal	321459	2	18-2031	Oil Seal	321787	1	18-2063	Oil Seal	330327	1	18-4248	Washer	311598	2	18-7100	O-Ring	301877	1	18-7145	O-Ring	333572	2	18-7475	Quad Ring	332583	—	 <p>18-2658 AP# 078 GEAR HOUSING SEAL KIT Replaces: 396351</p> <p style="text-align: center;">— CONTAINS —</p> <table border="1"> <thead> <tr> <th>Sierra #</th> <th>Desc.</th> <th>O.E.#</th> <th>Qty.</th> </tr> </thead> <tbody> <tr><td>18-0124</td><td>Impeller Plate Gasket</td><td>325537</td><td>1</td></tr> <tr><td>18-0189</td><td>Shift Rod Washer</td><td>321738</td><td>1</td></tr> <tr><td>18-2026</td><td>Oil Seal</td><td>321453</td><td>2</td></tr> <tr><td>18-2033</td><td>Oil Seal</td><td>321928</td><td>1</td></tr> <tr><td>18-2065</td><td>Oil Seal</td><td>332261</td><td>1</td></tr> <tr><td>18-2539</td><td>Rubber Seal</td><td>328753</td><td>1</td></tr> <tr><td>18-4248</td><td>Washer</td><td>311598</td><td>2</td></tr> <tr><td>18-7100</td><td>O-Ring</td><td>301877</td><td>1</td></tr> <tr><td>18-7105</td><td>O-Ring</td><td>311338</td><td>2</td></tr> <tr><td>18-7108</td><td>O-Ring</td><td>313893</td><td>1</td></tr> <tr><td>18-7109</td><td>O-Ring</td><td>317178</td><td>3</td></tr> <tr><td>18-7145</td><td>O-Ring</td><td>333572</td><td>2</td></tr> <tr><td>18-7146</td><td>O-Ring</td><td>554545</td><td>1</td></tr> <tr><td>18-7180</td><td>O-Ring</td><td>303347</td><td>1</td></tr> <tr><td>18-2030</td><td>Oil Seal</td><td>321786</td><td>1</td></tr> <tr><td>18-2027</td><td>Oil Seal</td><td>321459</td><td>1</td></tr> </tbody> </table>	Sierra #	Desc.	O.E.#	Qty.	18-0124	Impeller Plate Gasket	325537	1	18-0189	Shift Rod Washer	321738	1	18-2026	Oil Seal	321453	2	18-2033	Oil Seal	321928	1	18-2065	Oil Seal	332261	1	18-2539	Rubber Seal	328753	1	18-4248	Washer	311598	2	18-7100	O-Ring	301877	1	18-7105	O-Ring	311338	2	18-7108	O-Ring	313893	1	18-7109	O-Ring	317178	3	18-7145	O-Ring	333572	2	18-7146	O-Ring	554545	1	18-7180	O-Ring	303347	1	18-2030	Oil Seal	321786	1	18-2027	Oil Seal	321459	1	 <p>18-2659 AP# 082 GEAR HOUSING SEAL KIT Replaces: 396355</p> <p style="text-align: center;">— CONTAINS —</p> <table border="1"> <thead> <tr> <th>Sierra #</th> <th>Desc.</th> <th>O.E.#</th> <th>Qty.</th> </tr> </thead> <tbody> <tr><td>18-0969</td><td>Impeller Housing Gasket</td><td>319586</td><td>1</td></tr> <tr><td>18-2059</td><td>Oil Seal</td><td>321466</td><td>1</td></tr> <tr><td>18-2060</td><td>Oil Seal</td><td>321467</td><td>2</td></tr> <tr><td>18-2064</td><td>Oil Seal</td><td>332205</td><td>1</td></tr> <tr><td>18-2532</td><td>Foam Seal</td><td>305762</td><td>1</td></tr> <tr><td>18-2537</td><td>Rubber Seal</td><td>324937</td><td>1</td></tr> <tr><td>18-2855</td><td>Shift Housing Cover to Gear Case Gasket</td><td>314082</td><td>1</td></tr> <tr><td>18-4248</td><td>Washer</td><td>311598</td><td>2</td></tr> <tr><td>18-7115</td><td>O-Ring</td><td>302588</td><td>1</td></tr> <tr><td>18-7120</td><td>O-Ring</td><td>307853</td><td>1</td></tr> <tr><td>18-7137</td><td>O-Ring</td><td>318372</td><td>1</td></tr> <tr><td>18-7140</td><td>O-Ring</td><td>320303</td><td>1</td></tr> <tr><td>18-7145</td><td>O-Ring</td><td>333572</td><td>2</td></tr> <tr><td>18-7475</td><td>Quad Ring</td><td>332584</td><td>3</td></tr> </tbody> </table>	Sierra #	Desc.	O.E.#	Qty.	18-0969	Impeller Housing Gasket	319586	1	18-2059	Oil Seal	321466	1	18-2060	Oil Seal	321467	2	18-2064	Oil Seal	332205	1	18-2532	Foam Seal	305762	1	18-2537	Rubber Seal	324937	1	18-2855	Shift Housing Cover to Gear Case Gasket	314082	1	18-4248	Washer	311598	2	18-7115	O-Ring	302588	1	18-7120	O-Ring	307853	1	18-7137	O-Ring	318372	1	18-7140	O-Ring	320303	1	18-7145	O-Ring	333572	2	18-7475	Quad Ring	332584	3
Sierra #	Desc.	O.E.#	Qty.																																																																																																																																																																															
18-0882	Shift Rod Gasket	304764	1																																																																																																																																																																															
18-0108	Lower Gearcase Gasket	324449	1																																																																																																																																																																															
18-3360	Impeller Housing Gasket	329390	1																																																																																																																																																																															
18-7411	O-Ring	—	1																																																																																																																																																																															
18-2027	Oil Seal	321459	2																																																																																																																																																																															
18-2031	Oil Seal	321787	1																																																																																																																																																																															
18-2063	Oil Seal	330327	1																																																																																																																																																																															
18-4248	Washer	311598	2																																																																																																																																																																															
18-7100	O-Ring	301877	1																																																																																																																																																																															
18-7145	O-Ring	333572	2																																																																																																																																																																															
18-7475	Quad Ring	332583	—																																																																																																																																																																															
Sierra #	Desc.	O.E.#	Qty.																																																																																																																																																																															
18-0124	Impeller Plate Gasket	325537	1																																																																																																																																																																															
18-0189	Shift Rod Washer	321738	1																																																																																																																																																																															
18-2026	Oil Seal	321453	2																																																																																																																																																																															
18-2033	Oil Seal	321928	1																																																																																																																																																																															
18-2065	Oil Seal	332261	1																																																																																																																																																																															
18-2539	Rubber Seal	328753	1																																																																																																																																																																															
18-4248	Washer	311598	2																																																																																																																																																																															
18-7100	O-Ring	301877	1																																																																																																																																																																															
18-7105	O-Ring	311338	2																																																																																																																																																																															
18-7108	O-Ring	313893	1																																																																																																																																																																															
18-7109	O-Ring	317178	3																																																																																																																																																																															
18-7145	O-Ring	333572	2																																																																																																																																																																															
18-7146	O-Ring	554545	1																																																																																																																																																																															
18-7180	O-Ring	303347	1																																																																																																																																																																															
18-2030	Oil Seal	321786	1																																																																																																																																																																															
18-2027	Oil Seal	321459	1																																																																																																																																																																															
Sierra #	Desc.	O.E.#	Qty.																																																																																																																																																																															
18-0969	Impeller Housing Gasket	319586	1																																																																																																																																																																															
18-2059	Oil Seal	321466	1																																																																																																																																																																															
18-2060	Oil Seal	321467	2																																																																																																																																																																															
18-2064	Oil Seal	332205	1																																																																																																																																																																															
18-2532	Foam Seal	305762	1																																																																																																																																																																															
18-2537	Rubber Seal	324937	1																																																																																																																																																																															
18-2855	Shift Housing Cover to Gear Case Gasket	314082	1																																																																																																																																																																															
18-4248	Washer	311598	2																																																																																																																																																																															
18-7115	O-Ring	302588	1																																																																																																																																																																															
18-7120	O-Ring	307853	1																																																																																																																																																																															
18-7137	O-Ring	318372	1																																																																																																																																																																															
18-7140	O-Ring	320303	1																																																																																																																																																																															
18-7145	O-Ring	333572	2																																																																																																																																																																															
18-7475	Quad Ring	332584	3																																																																																																																																																																															

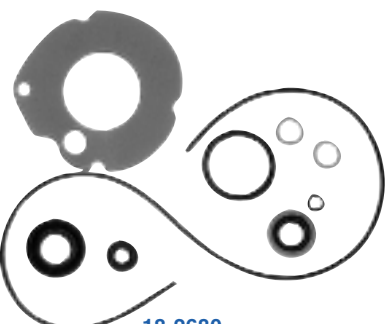
APPLICATION BEGINS ON PAGE 235

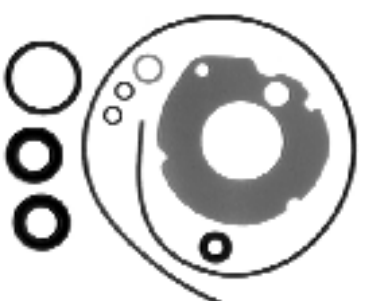

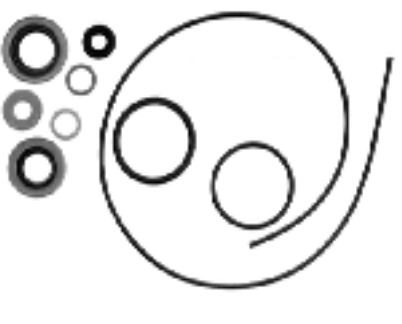
JOHNSON/EVINRUDE (OMC) Gear Housing Seal Kits

 <p>18-2660 AP# 076 GEAR HOUSING SEAL KIT Replaces: 396349 — CONTAINS —</p> <table border="1"> <thead> <tr> <th>Sierra #</th> <th>Desc.</th> <th>O.E. #</th> <th>Qty.</th> </tr> </thead> <tbody> <tr><td>18-2059</td><td>Oil Seal</td><td>321466</td><td>1</td></tr> <tr><td>18-2064</td><td>Oil Seal</td><td>332205</td><td>1</td></tr> <tr><td>18-2537</td><td>Rubber Seal</td><td>324937</td><td>1</td></tr> <tr><td>18-2855</td><td>Shift Housing Cover to Gearcase Gasket</td><td>314082</td><td>1</td></tr> <tr><td>18-4248</td><td>Washer</td><td>311598</td><td>2</td></tr> <tr><td>18-7120</td><td>O-Ring</td><td>307853</td><td>1</td></tr> <tr><td>18-7127</td><td>O-Ring</td><td>313446</td><td>1</td></tr> <tr><td>18-7128</td><td>O-Ring</td><td>313754</td><td>1</td></tr> <tr><td>18-7137</td><td>O-Ring</td><td>318372</td><td>1</td></tr> <tr><td>18-7145</td><td>O-Ring</td><td>333572</td><td>2</td></tr> <tr><td>18-7475</td><td>Quad Ring</td><td>332584</td><td>4</td></tr> <tr><td>18-7174</td><td>O-Ring</td><td>326649</td><td>1</td></tr> <tr><td>18-2001</td><td>Oil Seal</td><td>330137</td><td>2</td></tr> </tbody> </table>				Sierra #	Desc.	O.E. #	Qty.	18-2059	Oil Seal	321466	1	18-2064	Oil Seal	332205	1	18-2537	Rubber Seal	324937	1	18-2855	Shift Housing Cover to Gearcase Gasket	314082	1	18-4248	Washer	311598	2	18-7120	O-Ring	307853	1	18-7127	O-Ring	313446	1	18-7128	O-Ring	313754	1	18-7137	O-Ring	318372	1	18-7145	O-Ring	333572	2	18-7475	Quad Ring	332584	4	18-7174	O-Ring	326649	1	18-2001	Oil Seal	330137	2	 <p>18-2679 AP# 13102 GEAR HOUSING SEAL KIT — CONTAINS —</p> <table border="1"> <thead> <tr> <th>Sierra #</th> <th>Desc.</th> <th>O.E. #</th> <th>Qty.</th> </tr> </thead> <tbody> <tr><td>18-2022</td><td>Oil Seal</td><td>303345</td><td>1</td></tr> <tr><td>18-2035</td><td>Oil Seal</td><td>327031</td><td>1</td></tr> <tr><td>18-2891</td><td>Bearing Housing Gasket</td><td>303339</td><td>1</td></tr> <tr><td>18-4248</td><td>Washer</td><td>311598</td><td>2</td></tr> <tr><td>18-7100</td><td>O-Ring</td><td>301877</td><td>1</td></tr> <tr><td>18-7117</td><td>O-Ring</td><td>303360</td><td>1</td></tr> <tr><td>18-7120</td><td>O-Ring</td><td>307853</td><td>1</td></tr> <tr><td>18-2534</td><td>Spaghetti Seal</td><td>309044</td><td>1</td></tr> </tbody> </table>				Sierra #	Desc.	O.E. #	Qty.	18-2022	Oil Seal	303345	1	18-2035	Oil Seal	327031	1	18-2891	Bearing Housing Gasket	303339	1	18-4248	Washer	311598	2	18-7100	O-Ring	301877	1	18-7117	O-Ring	303360	1	18-7120	O-Ring	307853	1	18-2534	Spaghetti Seal	309044	1																
Sierra #	Desc.	O.E. #	Qty.																																																																																																																
18-2059	Oil Seal	321466	1																																																																																																																
18-2064	Oil Seal	332205	1																																																																																																																
18-2537	Rubber Seal	324937	1																																																																																																																
18-2855	Shift Housing Cover to Gearcase Gasket	314082	1																																																																																																																
18-4248	Washer	311598	2																																																																																																																
18-7120	O-Ring	307853	1																																																																																																																
18-7127	O-Ring	313446	1																																																																																																																
18-7128	O-Ring	313754	1																																																																																																																
18-7137	O-Ring	318372	1																																																																																																																
18-7145	O-Ring	333572	2																																																																																																																
18-7475	Quad Ring	332584	4																																																																																																																
18-7174	O-Ring	326649	1																																																																																																																
18-2001	Oil Seal	330137	2																																																																																																																
Sierra #	Desc.	O.E. #	Qty.																																																																																																																
18-2022	Oil Seal	303345	1																																																																																																																
18-2035	Oil Seal	327031	1																																																																																																																
18-2891	Bearing Housing Gasket	303339	1																																																																																																																
18-4248	Washer	311598	2																																																																																																																
18-7100	O-Ring	301877	1																																																																																																																
18-7117	O-Ring	303360	1																																																																																																																
18-7120	O-Ring	307853	1																																																																																																																
18-2534	Spaghetti Seal	309044	1																																																																																																																
 <p>18-2680 AP# 13103 GEAR HOUSING SEAL KIT — CONTAINS —</p> <table border="1"> <thead> <tr> <th>Sierra #</th> <th>Desc.</th> <th>O.E. #</th> <th>Qty.</th> </tr> </thead> <tbody> <tr><td>18-2023</td><td>Oil Seal</td><td>313282</td><td>1</td></tr> <tr><td>18-2035</td><td>Oil Seal</td><td>327031</td><td>1</td></tr> <tr><td>18-2891</td><td>Bearing Housing Gasket</td><td>303339</td><td>1</td></tr> <tr><td>18-4248</td><td>Washer</td><td>311598</td><td>2</td></tr> <tr><td>18-7100</td><td>O-Ring</td><td>301877</td><td>1</td></tr> <tr><td>18-7117</td><td>O-Ring</td><td>303360</td><td>1</td></tr> <tr><td>18-7120</td><td>O-Ring</td><td>307853</td><td>1</td></tr> <tr><td>18-2534</td><td>Spaghetti Seal</td><td>309044</td><td>1</td></tr> </tbody> </table>				Sierra #	Desc.	O.E. #	Qty.	18-2023	Oil Seal	313282	1	18-2035	Oil Seal	327031	1	18-2891	Bearing Housing Gasket	303339	1	18-4248	Washer	311598	2	18-7100	O-Ring	301877	1	18-7117	O-Ring	303360	1	18-7120	O-Ring	307853	1	18-2534	Spaghetti Seal	309044	1	 <p>18-2681 AP# 1769 GEAR HOUSING SEAL KIT — CONTAINS —</p> <table border="1"> <thead> <tr> <th>Sierra #</th> <th>Desc.</th> <th>O.E. #</th> <th>Qty.</th> </tr> </thead> <tbody> <tr><td>18-2023</td><td>Oil Seal</td><td>313282</td><td>1</td></tr> <tr><td>18-2024</td><td>Oil Seal</td><td>314167</td><td>1</td></tr> <tr><td>18-2891</td><td>Bearing Housing Gasket</td><td>303339</td><td>1</td></tr> <tr><td>18-4248</td><td>Washer</td><td>311598</td><td>2</td></tr> <tr><td>18-7100</td><td>O-Ring</td><td>301877</td><td>1</td></tr> <tr><td>18-7117</td><td>O-Ring</td><td>303360</td><td>1</td></tr> <tr><td>18-7120</td><td>O-Ring</td><td>307853</td><td>1</td></tr> <tr><td>18-2534</td><td>Spaghetti Seal</td><td>309044</td><td>1</td></tr> </tbody> </table>				Sierra #	Desc.	O.E. #	Qty.	18-2023	Oil Seal	313282	1	18-2024	Oil Seal	314167	1	18-2891	Bearing Housing Gasket	303339	1	18-4248	Washer	311598	2	18-7100	O-Ring	301877	1	18-7117	O-Ring	303360	1	18-7120	O-Ring	307853	1	18-2534	Spaghetti Seal	309044	1	 <p>18-2682 AP# 1727 GEAR HOUSING SEAL KIT — CONTAINS —</p> <table border="1"> <thead> <tr> <th>Sierra #</th> <th>Desc.</th> <th>O.E. #</th> <th>Qty.</th> </tr> </thead> <tbody> <tr><td>18-2022</td><td>Oil Seal</td><td>303345</td><td>2</td></tr> <tr><td>18-2891</td><td>Bearing Housing Gasket</td><td>303339</td><td>1</td></tr> <tr><td>18-4248</td><td>Washer</td><td>311598</td><td>2</td></tr> <tr><td>18-7100</td><td>O-Ring</td><td>301877</td><td>1</td></tr> <tr><td>18-7117</td><td>O-Ring</td><td>303360</td><td>1</td></tr> <tr><td>18-7120</td><td>O-Ring</td><td>307853</td><td>1</td></tr> <tr><td>18-2534</td><td>Spaghetti Seal</td><td>309044</td><td>1</td></tr> </tbody> </table>				Sierra #	Desc.	O.E. #	Qty.	18-2022	Oil Seal	303345	2	18-2891	Bearing Housing Gasket	303339	1	18-4248	Washer	311598	2	18-7100	O-Ring	301877	1	18-7117	O-Ring	303360	1	18-7120	O-Ring	307853	1	18-2534	Spaghetti Seal	309044	1
Sierra #	Desc.	O.E. #	Qty.																																																																																																																
18-2023	Oil Seal	313282	1																																																																																																																
18-2035	Oil Seal	327031	1																																																																																																																
18-2891	Bearing Housing Gasket	303339	1																																																																																																																
18-4248	Washer	311598	2																																																																																																																
18-7100	O-Ring	301877	1																																																																																																																
18-7117	O-Ring	303360	1																																																																																																																
18-7120	O-Ring	307853	1																																																																																																																
18-2534	Spaghetti Seal	309044	1																																																																																																																
Sierra #	Desc.	O.E. #	Qty.																																																																																																																
18-2023	Oil Seal	313282	1																																																																																																																
18-2024	Oil Seal	314167	1																																																																																																																
18-2891	Bearing Housing Gasket	303339	1																																																																																																																
18-4248	Washer	311598	2																																																																																																																
18-7100	O-Ring	301877	1																																																																																																																
18-7117	O-Ring	303360	1																																																																																																																
18-7120	O-Ring	307853	1																																																																																																																
18-2534	Spaghetti Seal	309044	1																																																																																																																
Sierra #	Desc.	O.E. #	Qty.																																																																																																																
18-2022	Oil Seal	303345	2																																																																																																																
18-2891	Bearing Housing Gasket	303339	1																																																																																																																
18-4248	Washer	311598	2																																																																																																																
18-7100	O-Ring	301877	1																																																																																																																
18-7117	O-Ring	303360	1																																																																																																																
18-7120	O-Ring	307853	1																																																																																																																
18-2534	Spaghetti Seal	309044	1																																																																																																																
 <p>18-2683 GEAR HOUSING SEAL KIT — CONTAINS —</p> <table border="1"> <thead> <tr> <th>Sierra #</th> <th>Desc.</th> <th>O.E. #</th> <th>Qty.</th> </tr> </thead> <tbody> <tr><td>18-2023</td><td>Oil Seal</td><td>313282</td><td>2</td></tr> <tr><td>18-2891</td><td>Bearing Housing Gasket</td><td>303339</td><td>1</td></tr> <tr><td>18-4248</td><td>Washer</td><td>311598</td><td>2</td></tr> <tr><td>18-7100</td><td>O-Ring</td><td>301877</td><td>1</td></tr> <tr><td>18-7117</td><td>O-Ring</td><td>303360</td><td>1</td></tr> <tr><td>18-7120</td><td>O-Ring</td><td>307853</td><td>1</td></tr> <tr><td>18-2534</td><td>Spaghetti Seal</td><td>309044</td><td>1</td></tr> </tbody> </table>				Sierra #	Desc.	O.E. #	Qty.	18-2023	Oil Seal	313282	2	18-2891	Bearing Housing Gasket	303339	1	18-4248	Washer	311598	2	18-7100	O-Ring	301877	1	18-7117	O-Ring	303360	1	18-7120	O-Ring	307853	1	18-2534	Spaghetti Seal	309044	1	 <p>18-2684 AP# 1728 GEAR HOUSING SEAL KIT — CONTAINS —</p> <table border="1"> <thead> <tr> <th>Sierra #</th> <th>Desc.</th> <th>O.E. #</th> <th>Qty.</th> </tr> </thead> <tbody> <tr><td>18-0882</td><td>Shift Rod Gasket</td><td>304764</td><td>1</td></tr> <tr><td>18-2032</td><td>Oil Seal</td><td>321788</td><td>1</td></tr> <tr><td>18-4248</td><td>Washer</td><td>311598</td><td>2</td></tr> <tr><td>18-7100</td><td>O-Ring</td><td>301877</td><td>1</td></tr> <tr><td>18-7120</td><td>O-Ring</td><td>307853</td><td>1</td></tr> <tr><td>18-2031</td><td>Oil Seal</td><td>321787</td><td>1</td></tr> <tr><td>18-2534</td><td>Spaghetti Seal</td><td>309044</td><td>1</td></tr> </tbody> </table>				Sierra #	Desc.	O.E. #	Qty.	18-0882	Shift Rod Gasket	304764	1	18-2032	Oil Seal	321788	1	18-4248	Washer	311598	2	18-7100	O-Ring	301877	1	18-7120	O-Ring	307853	1	18-2031	Oil Seal	321787	1	18-2534	Spaghetti Seal	309044	1	 <p>18-2685 AP# 13104 GEAR HOUSING SEAL KIT — CONTAINS —</p> <table border="1"> <thead> <tr> <th>Sierra #</th> <th>Desc.</th> <th>O.E. #</th> <th>Qty.</th> </tr> </thead> <tbody> <tr><td>18-2030</td><td>Oil Seal</td><td>321786</td><td>3</td></tr> <tr><td>18-2031</td><td>Oil Seal</td><td>321787</td><td>1</td></tr> <tr><td>18-4248</td><td>Washer</td><td>311598</td><td>2</td></tr> <tr><td>18-7100</td><td>O-Ring</td><td>301877</td><td>1</td></tr> <tr><td>18-7112</td><td>O-Ring</td><td>302493</td><td>1</td></tr> <tr><td>18-7120</td><td>O-Ring</td><td>307853</td><td>1</td></tr> <tr><td>18-2534</td><td>Spaghetti Seal</td><td>309044</td><td>1</td></tr> <tr><td>18-0882</td><td>Shift Rod Gasket</td><td>304764</td><td>1</td></tr> </tbody> </table>				Sierra #	Desc.	O.E. #	Qty.	18-2030	Oil Seal	321786	3	18-2031	Oil Seal	321787	1	18-4248	Washer	311598	2	18-7100	O-Ring	301877	1	18-7112	O-Ring	302493	1	18-7120	O-Ring	307853	1	18-2534	Spaghetti Seal	309044	1	18-0882	Shift Rod Gasket	304764	1				
Sierra #	Desc.	O.E. #	Qty.																																																																																																																
18-2023	Oil Seal	313282	2																																																																																																																
18-2891	Bearing Housing Gasket	303339	1																																																																																																																
18-4248	Washer	311598	2																																																																																																																
18-7100	O-Ring	301877	1																																																																																																																
18-7117	O-Ring	303360	1																																																																																																																
18-7120	O-Ring	307853	1																																																																																																																
18-2534	Spaghetti Seal	309044	1																																																																																																																
Sierra #	Desc.	O.E. #	Qty.																																																																																																																
18-0882	Shift Rod Gasket	304764	1																																																																																																																
18-2032	Oil Seal	321788	1																																																																																																																
18-4248	Washer	311598	2																																																																																																																
18-7100	O-Ring	301877	1																																																																																																																
18-7120	O-Ring	307853	1																																																																																																																
18-2031	Oil Seal	321787	1																																																																																																																
18-2534	Spaghetti Seal	309044	1																																																																																																																
Sierra #	Desc.	O.E. #	Qty.																																																																																																																
18-2030	Oil Seal	321786	3																																																																																																																
18-2031	Oil Seal	321787	1																																																																																																																
18-4248	Washer	311598	2																																																																																																																
18-7100	O-Ring	301877	1																																																																																																																
18-7112	O-Ring	302493	1																																																																																																																
18-7120	O-Ring	307853	1																																																																																																																
18-2534	Spaghetti Seal	309044	1																																																																																																																
18-0882	Shift Rod Gasket	304764	1																																																																																																																

OUTBOARD

APPLICATION BEGINS ON PAGE 235

JOHNSON/EVINRUDE (OMC) Gear Housing Seal Kits



OUTBOARD



18-2686
AP# 1729
GEAR HOUSING SEAL KIT

— CONTAINS —

Sierra #	Desc.	O.E.#	Qty.
18-0882	Shift Rod Gasket	304764	1
18-2005	Oil Seal	313284	1
18-2021	Oil Seal	302564	1
18-4248	Washer	311598	2
18-7100	O-Ring	301877	1
18-7115	O-Ring	302588	1
18-7120	O-Ring	307853,322598	1

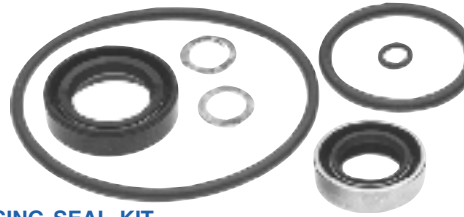

18-2687
AP# 13105
GEAR HOUSING SEAL KIT

— CONTAINS —

Sierra #	Desc.	O.E.#	Qty.
18-2005	Oil Seal	313284	1
18-4248	Washer	311598	2
18-7120	O-Ring	307853,322598	1
18-7152	O-Ring	307082	1
18-2027	Oil Seal	321459	1
18-7143	O-Ring	322501	1
18-0173	Oil Seal	313283	1
18-7428	Rubber Seal	307103	1



18-2688
AP# 1777
GEAR HOUSING SEAL KIT

— CONTAINS —

Sierra #	Desc.	O.E.#	Qty.
18-2027	Oil Seal	321459	2
18-2855	Shift Housing Cover to Gearcase Gasket	314082	1
18-4248	Washer	311598	2
18-7100	O-Ring	301877	1
18-7109	O-Ring	317178	4
18-7127	O-Ring	313446	1
18-7128	O-Ring	313754	1
18-2001	Oil Seal	330137	2
18-7129	O-Ring	314491	1



18-2689
AP# 13106
GEAR HOUSING SEAL KIT

— CONTAINS —

Sierra #	Desc.	O.E.#	Qty.
18-0173	Oil Seal	313283	1
18-0174	Oil Seal	326716	1
18-0886	Lower Gearcase Gasket	307099	1
18-4248	Washer	311598	2
18-7115	O-Ring	302588	1
18-7118	O-Ring	305242	1
18-7120	O-Ring	307853,322598	4
18-7152	O-Ring	307082	1
18-7428	O-Ring	307103	1

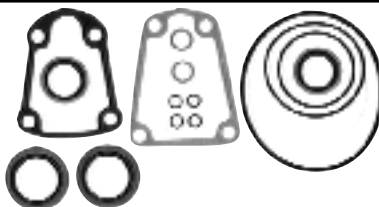

18-2690
AP# 1775
GEAR HOUSING SEAL KIT

— CONTAINS —

Sierra #	Desc.	O.E.#	Qty.
18-2855	Shift Housing Cover to Gearcase Gasket	314082	1
18-2874	Solenoid Cover Gasket	314876	1
18-4248	Washer	311598	2
18-7120	O-Ring	307853,322598	4
18-7127	O-Ring	313446	1
18-7129	O-Ring	314491	1
18-7130	O-Ring	314728	1
18-7126	O-Ring	313340	1

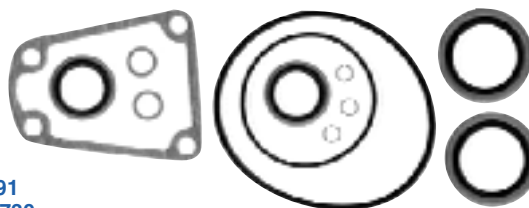

18-2691
AP# 1730
GEAR HOUSING SEAL KIT

— CONTAINS —

Sierra #	Desc.	O.E.#	Qty.
18-2874	Solenoid Cover Gasket	314876	1
18-4248	Washer	311598	2
18-7109	O-Ring	317178	4
18-7127	O-Ring	313446	1
18-2001	Oil Seal	330137	2
18-7130	O-Ring	314728	1
18-2059	Oil Seal	321466	2

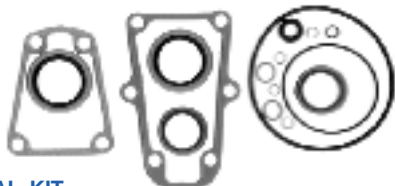

18-2692
AP# 13107
GEAR HOUSING SEAL KIT

— CONTAINS —

Sierra #	Desc.	O.E.#	Qty.
18-0110	Shift Housing Gasket	324670	1
18-2026	Oil Seal	321453	2
18-2874	Solenoid Cover Gasket	314876	1
18-4248	Washer	311598	2
18-7109	O-Ring	317178	4
18-7120	O-Ring	322598	1
18-7127	O-Ring	313446	1
18-7130	O-Ring	314728	1
18-7137	O-Ring	318372	1
18-2001	Oil Seal	330137	2



18-2694
AP# 13108
GEAR HOUSING SEAL KIT
Replaces: 433550

— CONTAINS —

Sierra #	Desc.	O.E.#	Qty.	Sierra #	Desc.	O.E.#	Qty.
18-2709	Wear Plate Gasket	336530	1	18-7481	Seal	315788	1
18-7115	O-Ring	302588	1	18-2708	Seal	333758	1
18-7127	O-Ring	313446	1	18-2059	Oil Seal	321466	2
18-7120	O-Ring	307853,322598	1	18-2018	Oil Seal	305987	2
18-7172	O-Ring	553126	1	18-2064	Oil Seal	332205	1
18-7137	O-Ring	318372	1	18-2705	Seal	315748	1
18-7475	O-Ring	332584	1	18-4248	Washer	311598	1
				18-7173	O-Ring	310327,910582	1

APPLICATIONS BEGINS ON PAGE 235 ALL PARTS SHOWN ARE INCLUDED IN KIT,
PART#S LISTED ARE AVAILABLE INDIVIDUALLY



JOHNSON/EVINRUDE (OMC) Gear Housing Seal Kits

EXPANDED APPLICATION

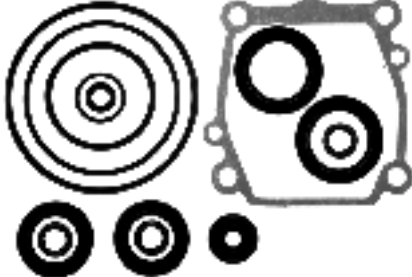

18-8336
AP# 13547
LOWER UNIT SEAL KIT
Replaces: 5030973
For: 60 HP 4 stroke (2002-2003), 70 HP 4 stroke (1998-2003)
— CONTAINS —

Sierra #	Desc.	O.E.#	Qty.
18-0457	Water Pump Gasket	—	1
18-7118	O-Ring	305242	1
18-7127	O-Ring	313446	1
18-7183	O-Ring	—	1
18-7503	O-Ring	—	1
18-8320	Seal	—	2
18-8324	Seal	—	2
18-8328	Shift Shaft Seal	—	1
18-8331	Drain Plug Gasket	—	3

EXPANDED APPLICATION

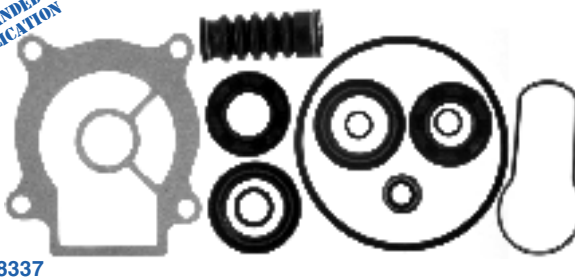

18-8337
AP# 13548
LOWER UNIT SEAL KIT
Replaces: 5031456
For: 40/50 HP 4 stroke (1999-2003)
— CONTAINS —

Sierra #	Desc.	O.E.#	Qty.
18-0461	Water Pump Gasket	—	1
18-7151	O-Ring	—	1
18-7413	O-Ring	303191	2
18-7501	O-Ring	—	1
18-8315	Seal	—	2
18-8331	Drain Plug Gasket	—	3
18-8334	Shift Shaft Seal	—	1
18-8342	Seal Ring	—	1
18-8345	Seal	—	2

GEAR HOUSING SEAL KITS APPLICATION

Model	Year	Sierra Seal Kit	AP Seal Kit	Model	Year	Sierra Seal Kit	AP Seal Kit	
5.5	⑧	1955-67	18-2679	—	50	1976-88	18-2659	082
6	⑧	1955-67	18-2679	—	50	1989-Up	18-2694	—
6	⑨	1967-68	18-2680	—	50 (3 cyl.)	1995-Up	18-2660	076
6	⑩	1968-79	18-2681	—	55	1968-69	18-2690	—
7.5	⑧	1955-67	18-2679	—	55	1976-88	18-2659	082
9.5 (B Suffix)		1958-67	18-2682	—	60 (Manual/Elect.)	1960-68	18-2689	—
9.5 (M Suffix)		1967-73	18-2683	—	60	1970-71	18-2690	—
9.9/15		1974-Up	18-2656	—	60 (2 cyl.)	1976-88	18-2659	082
9.9/15 (4 Stroke)		1974-Up	18-2656	—	60 (3 cyl.)	1978-Up	18-2660	076
10		1958-67	18-2682	—	65 (Manual/Elect.)	1960-68	18-2689	—
18		1958-73	18-2684	1728	65	1978-Up	18-2660	076
20		1966-73	18-2684	1728	70	1978-Up	18-2660	076
20		1979-82	18-2684	1728	75 (Manual/Elect.)	1960-68	18-2689	—
20		1985-Up	18-2658	078	75	1978-91	18-2660	076
25		1955-59	18-2686	1729	75 (Small Gearcase)	1976-88	18-2659	082
25		1968-78	18-2684	1728	V-4	1978-84	18-2623	3951
25		1979-82	18-2685	—	85 (Manual/Elect.) 1968	18-2689	—	—
25		1984	18-2657	—	85 (Small Prop Shaft)	1969-71	18-2690	—
25		1985-Up	18-2658	078	85 (Large Prop Shaft)	1971-72	18-2691	—
25	①	1990-95	18-2694	—	85 (V-4)	1973-83	18-2692	—
25 (Comm)		1985-Up	18-2657	—	85	1991-95	18-2623	3951
28		1962-70	18-2686	1729	88	1985-Up	18-2623	3951
28		1985-98	18-2657	—	90 (Elect.)	1964-65	18-2689	—
30		1955-59	18-2686	1729	90 (V-4)	1973-83	18-2692	—
30		1976-95	18-2658	078	90	1985-Up	18-2623	3951
33		1962-70	18-2686	1729	100 (Large Prop Shaft)	1971-72	18-2691	—
35		1955-59	18-2686	1729	100 (V-4)	1973-83	18-2692	—
35		1977-92	18-2658	078	100 (Comm)	1984-90	18-2623	3951
40 (Manual Shift)		1960-73	18-2686	1729	100 (Comm)	1991-95	18-2623	3951
40 (Elect. Shift)		1962-70	18-2687	—	100	1991-92	18-2623	3951
40		1976-88	18-2659	082	110 (V-4) ③	1973-83	18-2692	—
40		1989-Up	18-2694	—	110	1985-89	18-2623	3951
48		1976-88	18-2659	082	115 (Small Prop Shaft)	1969-71	18-2690	—
48		1989-96	18-2694	—	115 (V-4)	1973-83	18-2692	—
50		1971-74	18-2688	—	115	1985-Up	18-2623	3951

- ① "D" Suffix Only
- ② Models "GL" & "EX" only
- ③ 1992 Models except WTLNE, WTXENE
- ④ 1992 ESX Models only
- ⑤ 1992 TL Models only
- ⑥ CX Models only
- ⑦ 1992 Counter Rotation
- ⑧ 1967 "D" Suffix Only
- ⑨ 1967 "S" Suffix Only
- 1968 "C" Suffix Only
- ⑩ 1968 "A" & "R" Suffixes Only
- ⑪ TX & Counter Rotation Models

APPLICATIONS CONTINUED ON NEXT PAGE. ALL PARTS SHOWN ARE INCLUDED IN KIT, PART#S LISTED, ARE AVAILABLE INDIVIDUALLY

OUTBOARD

JOHNSON/EVINRUDE (OMC)

Gear Housing Seal Kits/Oil Kits



Model	Year	Sierra Seal Kit	AP Seal Kit	Model	Year	Sierra Seal Kit	AP Seal Kit
120	1985	18-2623	—	175	⑦ 1992	18-2623	—
120	1986-92	18-2623	—	175	1991-95	18-2623	—
120	1993	18-2623	—	185	1991-93	18-2623	—
125 (Large Prop Shaft)	1971-72	18-2691	—	200 (V-6)	1976-86	18-2623	—
125 ④	1991-92	18-2623	—	200	1991-95	18-2623	—
125	1993	18-2623	—	225	1991-95	18-2623	—
125 (Comm)	1991-93	18-2623	—	235 (V-6)	1977-86	18-2623	—
135 (V-4)	1973-83	18-2692	—	V-8 ⑦	1985-91	18-2623	—
140 (V-4)	1973-83	18-2692	—	250 (V-8)	1991-95	18-2623	—
140	1985	18-2623	—	300 (V-8)	1991-95	18-2623	—
140 ⑤	1986-92	18-2623	—	OMC SEA DRIVE			
140 ⑥	1992-93	18-2623	—	1.6L	1985-90	18-2623	—
140 ①	1992-95	18-2623	—	1.8L	1987	18-2623	—
150 (V-6)	1978-86	18-2623	—	2.0L	1988-90	18-2623	—
150 ⑦	1991	18-2623	—	2.5L	1984-85	18-2623	—
150	1991-95	18-2623	—	2.6L	1984-86	18-2623	—
155 (Comm)	1984-90	18-2623	—	2.7L	1987	18-2623	—
155 (Comm)	1991-93	18-2623	—	3.0L	1988-90	18-2623	—
175 (V-6)	1977-86	18-2623	—	3.6L	1987	18-2623	—
175 ②	1991	18-2623	—	4.0L	1989-90	18-2623	—

- ① "D" Suffix Only
- ② Models "GL" & "EX" only
- ③ 1992 Models except WTLNE, WTXENE
- ④ 1992 ESX Models only
- ⑤ 1992 TL Models only
- ⑥ CX Models only
- ⑦ 1992 Counter Rotation
- ⑧ 1967 "D" Suffix Only
- ⑨ 1967 "S" Suffix Only
1968 "C" Suffix Only
- ⑩ 1968 "A" & "R" Suffixes Only
- ⑪ TX & Counter Rotation Models

OUTBOARD

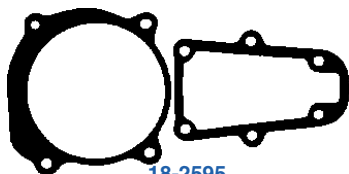

**18-2595
AP# 1673
SHIFT ROD & WEAR PLATE GASKET SET**
Replaces: 982132

18-2595/AP# 1673 SHIFT ROD & WEAR PLATE GASKET SET APPLICATION

HP	YEARS	HP	YEARS	HP	YEARS
85	1978-80	120	1985-90	185	1984-90
88	1987-90	125	1989-90	200	1976-90
90	1981-90	140	1977-90	225	1986-90
100	1979-90	150	1978-90	235	1978-85
100C	1984-89	155C	1984-90	275	1985-90
110	1986-89	175	1977-90	3.6L	1985-90
115	1978-90			300	1985-90

OIL SEALS



Sierra Part #	AP Part #	O.E. #	Shaft Size	Dimensions (in)		Sierra Part #	AP Part #	O.E. #	Shaft Size	Dimensions (in)	
				O.D.	Width					O.D.	Width
18-0173	1670	313283	0.795	1.320	0.307	18-2027	064	321459	0.625	1.125	0.250
18-0174	1582	326716	0.750	1.382	0.242	18-2028	067	321480	0.500	1.250	0.188
18-0542	1770	321831	0.750	1.253	0.186	18-2029	068	321481	0.687	1.250	0.250
18-0543	1581	321895	1.540	1.926	0.243	18-2030	1048	321786	0.625	1.125	0.188
18-0559	2143	332585	0.285	0.357	0.940	18-2031	065	321787	0.625	1.125	0.312
18-2000	1583	309989	1.375	2.000	0.313	18-2032	1049	321788	0.500	1.000	0.188
18-2001	027	330137	1.125	1.624	0.250	18-2033	028	321928	0.625	1.375	0.250
18-2002	238	320862	1.188	1.692	0.250	18-2034	—	324639	0.437	0.937	0.188
18-2005	1046	313284	0.625	1.128	0.250	18-2035	1630	327031	0.425	0.875	0.313
18-2012	1579	310599	1.000	1.499	0.250	18-2058	020	313353	1.938	2.438	0.250
18-2016	230	313992	1.187	1.875	0.250	18-2059	062	321466	0.750	1.126	0.200
18-2018	—	305987	1.000	1.375	0.250	18-2060	021	321467	1.000	1.375	0.250
18-2020	070	310649	2.500	3.000	0.250	18-2061	025	329922	0.822	1.375	0.195
18-2021	1043	302564	0.750	1.375	0.250	18-2062	026	329923	0.875	1.375	0.207
18-2022	1584	303345	0.554	1.000	0.375	18-2063	066	330327	0.625	1.124	0.188
18-2023	1045	313282	0.554	1.062	0.312	18-2064	—	332205	0.730	1.130	0.194
18-2024	—	314167	0.425	0.937	0.312	18-2065	—	332261	0.625	1.375	0.195
18-2025	—	318972	0.500	0.875	0.250	18-2066	278	911019	1.000	1.375	0.435
18-2026	024	321453	0.875	1.250	0.188	18-2067	1958	911685	2.000	2.509	0.315