

Agilent PNA-X Network Analyzer 10 MHz to 26.5 GHz

Application Note 1408-17

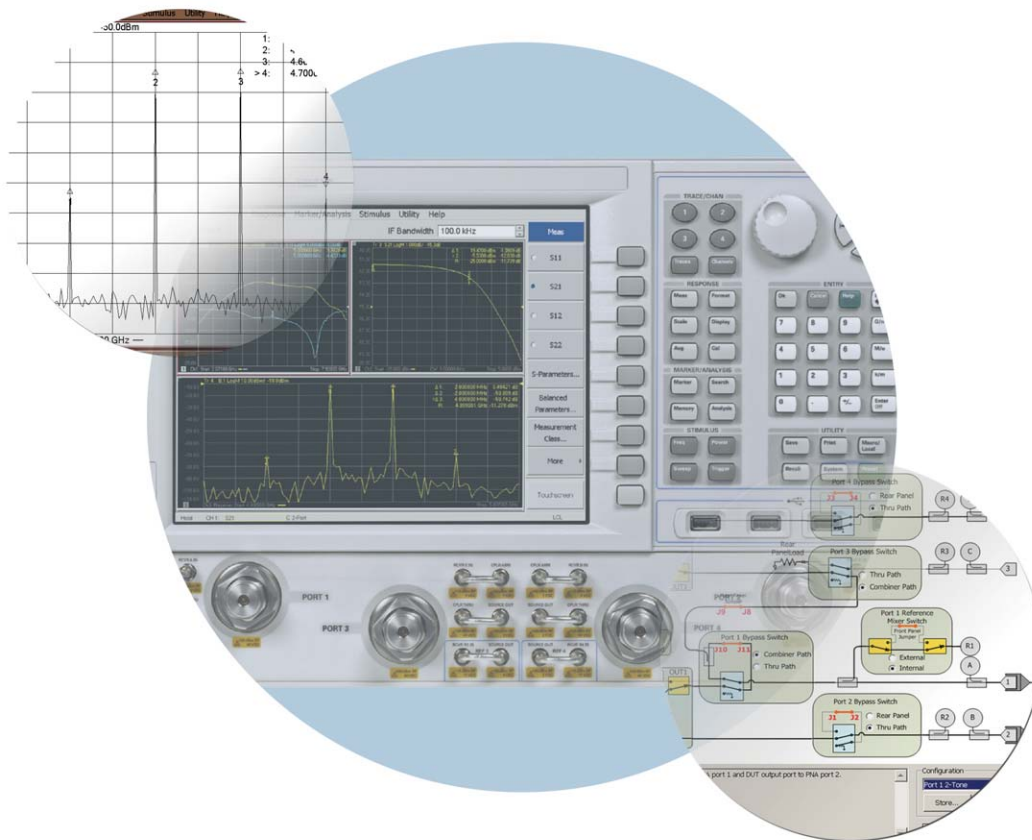

Making Accurate Intermodulation Distortion Measurements with the PNA-X Network Analyzer



Agilent Technologies

Table of Contents

Overview	2
Legend/Symbols	5
Receiver considerations	6
Low-level random noise	6
High-level random noise	8
Receiver generated intermodulation distortion	10
Combining receiver errors, calculating the error vector magnitude (EVM)	12
Measurement example	13
Setting the receiver attenuator	23
Source considerations	25
Port power available from combined sources	25
Impact of source harmonics	26
Source cross-modulation	28
Avoiding spurious signals in IMD measurements	29
1. Center frequency protocol	32
2. Tone frequency protocol	32
Appendix A: IMD Optimization tables for the PNA-X	33
Appendix B: The amplifier I want to test has an IP3 of +38 dBm. Can the PNA-X make this measurement?	34
Appendix C: Quick checklist for two-tone CW IMD measurements using a PNA-X with dual internal sources	35

Overview

Intermodulation distortion (IMD) is a measure of the nonlinearity of an amplifier. When two or more sinusoidal frequencies are applied to an amplifier, any non-linear behavior of the amplifier will produce additional frequency components called intermodulation products. For an amplifier with input signals at f_1 and f_2 , the output will contain signals at the following frequencies: $nf_1 + mf_2$, where $n, m = 0, \pm 1, \pm 2$, etc. The third-order products, $2f_2 - f_1$ and $2f_1 - f_2$, are a major concern because of their proximity to the fundamental frequencies; and the fact that their power levels increase by a factor of three, relative to an increase in the power level of the fundamental tones. Additionally, their proximity to the fundamental frequencies precludes their removal by filtering. The third-order intercept point (IP3) or the third-order intercept (TOI), often used interchangeably, are figures of merit for intermodulation distortion.

This application note describes accuracy considerations when using the Agilent PNA-X microwave network analyzer for two-tone intermodulation distortion measurements. One of the unique attributes of the PNA-X is its inclusion of an internal second source and an internal combining network¹, which together allow for an exceptionally convenient setup for two-tone intermodulation distortion measurements. Since these measurements are unique in a number of ways, it is important to understand how the attributes of the test system contribute to the measurement uncertainty, and how to best optimize the test setup to make accurate distortion measurements. The block diagram of a 2-port PNA-X is shown in Figure 1.

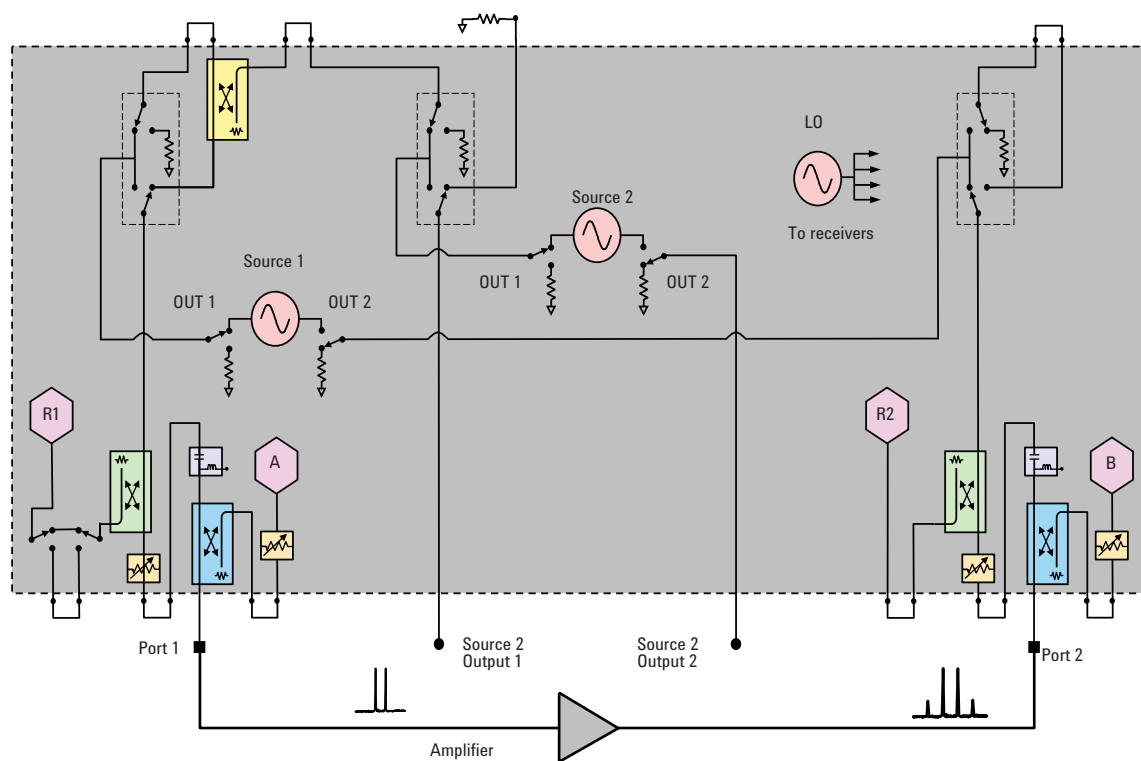

Figure 1. Block diagram of a 2-port fully loaded PNA-X (N5242A with option 224).

1. Available in 2-port analyzers with option 224 (Internal 2nd Source, Combiner and Mechanical Switches for 2-Port Test Set), and 4-port analyzers with option 423 (Combiner and Mechanical Switches for 4-Port Test Set)

Figure 2 shows a simplified setup for an IMD measurement, depicting areas of measurement uncertainty discussed in this application note. Table 1 lists the main sources of uncertainty in an IMD measurement with the setup shown as in Figure 2.

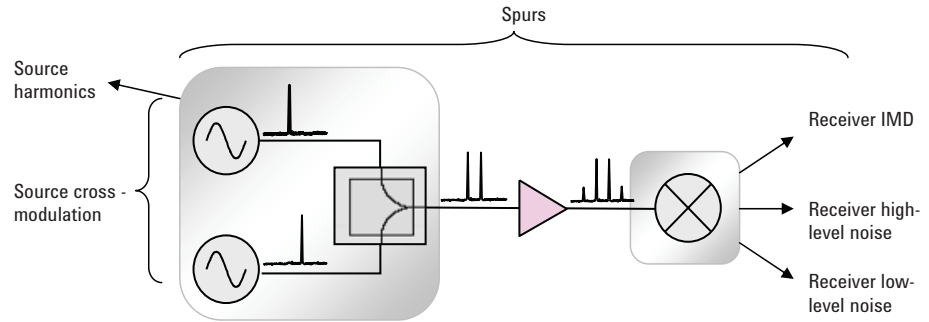

Figure 2. Simplified block diagram of a two-tone measurement, depicting areas of measurement uncertainty examined in this application note. Shaded areas are inside the PNA-X network analyzer.

Table 1. Sources of measurement uncertainty in an IMD measurement

Source considerations

Source harmonics: The second harmonic of the low-side tone can mix with the high-side tone, inside the DUT, creating a signal at the same frequency as the intermodulation product that is not the desired intermod generated inside the DUT. Since the PNA-X has excellent source harmonics (-60 dBc at $+10$ dBm output power), this error is often small. You can add external filtering to further reduce the impact of source harmonics.

Source cross-modulation: PNA-X's source cross-modulation is approximately -90 dBc, sufficient for most measurements. You can add external isolation amplifiers or circulators to further reduce source cross-modulation.

Source power accuracy: Since the IMD of a device is dependant upon the absolute power levels, uncertainties in the reported incident power level result in uncertainties in device distortion measurements.

Receiver considerations

Low-level noise or noise floor effects: You can reduce the IF bandwidth (BW) or reduce the amount of receiver attenuation to reduce the error due to low-level noise.

High-level noise or phase noise: You can change the power level, tone spacing, or decrease the IFBW to reduce high-level noise.

Receiver IMD: The PNA-X receiver's IP3 is about $+25$ dBm, for -5 dBm input power. You can use the receiver attenuators inside the PNA-X to reduce the error due to the receiver IP3.

Spurs and mismatch errors

Spurs: You can identify spurs and try to avoid them by selecting appropriate frequencies.

Mismatch errors: Mismatch errors also contribute to measurement uncertainty in two-tone measurements. We do not examine mismatch errors in this application note.

Legend/Symbols

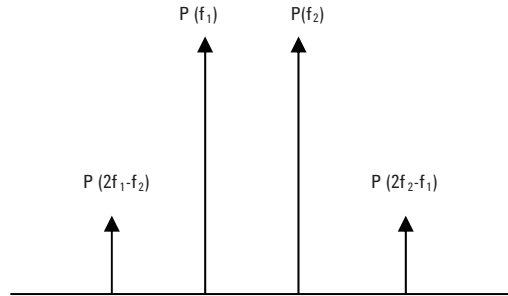

Figure 3. Two-tone distortion measurement frequencies.

f_1	Low-side tone
f_2	High-side tone
$2f_1 - f_2$	Low-side distortion product
$2f_2 - f_1$	High-side distortion product
$P(f_1)$	Low-side tone output power level
$P(f_2)$	High-side tone output power level
$P(2f_1 - f_2)$	Low-side distortion product power level
$P(2f_2 - f_1)$	High-side distortion product power level
N_L	Low-level noise
N_H	High-level noise
EVM	Error-vector magnitude
IMD	Intermodulation distortion
IP3	Third-order intercept point
LO	Local oscillator

All logarithmic equations refer to log in base 10.

In this document, the terms source and synthesizer are used interchangeably. They both refer to the internal synthesizers of the PNA-X.

The example in this document is an amplifier that is tested under the following conditions:

f_1	= 5.00001 GHz
f_2	= 5.00011 GHz
$2f_1 - f_2$	= 4.99991 GHz
$2f_2 - f_1$	= 5.00021 GHz
$P(f_1)$ input	= -20 dBm
$P(f_1)$ output	= -10 dBm
Gain	= 10 dB

Note: The step-by-step procedures in this application note were written for the PNA-X N5242A network analyzer with firmware revision A.07.22.01. If you have a PNA-X with a different firmware revision, the step-by-step procedures or screenshots may vary. The concepts and general guidelines still apply.

Receiver Considerations

The measurement receiver contributes to three important sources of error in an IMD measurement. These are low-level random noise, high-level random noise, and the intermod generated by the network analyzer receivers. By individually characterizing these three error contributors, the total receiver error can be calculated. The errors due to low-level noise and high-level noise can be reduced by increasing the tone power or decreasing the IFBW. However, the problem is that once we increase the tone power, the error due to receiver distortion increases, and when we reduce the IFBW, the measurement speed is reduced. The key is finding the optimum receiver attenuator setting where the total error is at its lowest point for a given IFBW, not just one of the sources of error. In this section, we describe the method for optimizing a distortion measurement and finding the settings which provide the highest accuracy, in the shortest possible time.

Low-level random noise

Random noise occurs both as low-level noise, which is independent of the signal power, and high-level noise, which is relative to the signal power. Low-level noise is present in all receiver measurements. In the PNA-X data sheet, you can find the specification for noise floor, which is representative of the low-level noise. The PNA-X noise floor specification is reproduced here for convenience.

Table 2. Test port noise floor (dBm), measured with a 10 Hz bandwidth, N5242A PNA-X

Test port noise floor (dBm)	Specification	Typical
10 MHz to 50 MHz	-80	-87
50 MHz to 100 MHz	-90	-95
100 MHz to 500 MHz	-104	-110
500 MHz to 2 GHz	-114	-117
2 GHz to 20 GHz	-114	-117
20 GHz to 24 GHz	-110	-115
24 GHz to 26.5 GHz	-107	-113

Low-level noise can be reduced by decreasing the measurement bandwidth. PNA-X has an IFBW range of 1 Hz to 600 kHz¹. Bandwidths between 10 Hz and 1 kHz are often used for IMD measurements. Low-level noise does not depend on the tone power or tone spacing, but may depend on the frequency of measurement. Low-level noise can be measured by removing both the low and high frequency fundamental tones and measuring the noise power at the frequency of the low side intermodulation product. Figure 4 shows the result of low-level noise measurement. Since low-level noise (N_L) is proportional to the bandwidth, we can state:

$$N_L \text{ (dBm/Hz)} = 10 * \log (N_L \text{ (mW)} - 10 * \log (\text{measurement bandwidth (Hz)}))$$

$$N_L \text{ (dBm)} = N_L \text{ (dBm/Hz)} + 10 * \log (\text{measurement bandwidth (Hz)})$$

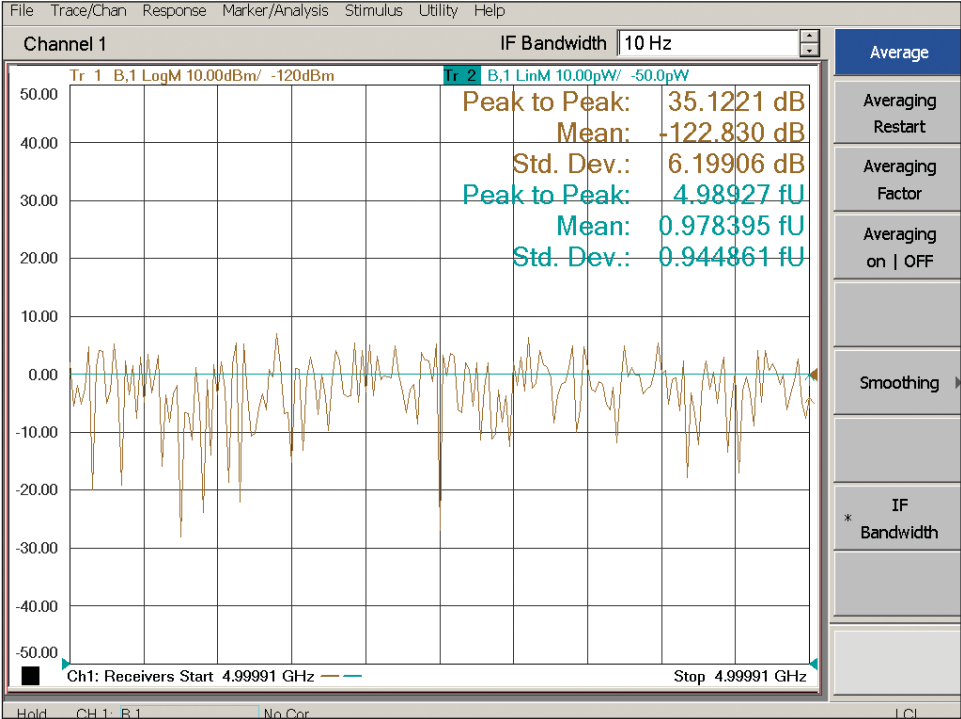

Figure 4. Low-level noise characterization of PNA-X's receivers.

1. PNA-X allows the user to set wider bandwidths, up to 5 MHz. These wider bandwidths are not recommended for distortion measurements.

High-level random noise

The principle sources of high-level noise are phase noise in the RF source and the receiver LO. In the case of two-tone measurements, the high-level noise is primarily caused by the fundamental tone closest in frequency to the intermodulation distortion product being measured. High-level noise is affected by tone separation and by measurement frequency. The measurement error contributed by this type of noise can be reduced by decreasing the measurement bandwidth or by decreasing the tone power. The values for the high-level noise are available from the PNA-X data sheet. The high-level noise is available from the phase noise table, reproduced here for convenience.

Table 3. Phase noise performance of the sources in the N5242A PNA-X

	Ports 1, 2, 3, 4, Source 2 Out 1, Source 2 Out 2, Typical performance (dBc/Hz)			
	1 kHz Offset	10 kHz Offset	100 kHz Offset	1 MHz Offset
10 MHz to 500 MHz	-85	-85	-85	-120
500 MHz to 1 GHz	-105	-115	-110	-127
1 GHz to 2 GHz	-100	-110	-105	-121
2 GHz to 4 GHz	-95	-105	-100	-115
4 GHz to 8 GHz	-89	-100	-94	-110
8 GHz to 16 GHz	-83	-94	-88	-105
16 GHz to 26.5 GHz	-78	-89	-82	-100

High-level noise can be measured by removing the high frequency tone signal and measuring the noise power at the frequency of the low side intermodulation signal. Figure 5 shows the result of this measurement.

Since low-level noise is present in the high-level noise measurement, the low-level noise power is subtracted from the apparent high-level noise power to obtain the actual high-level noise power.

$$N_H = N_H \text{ measured (mW)} - N_L \text{ measured (mW)}$$

Note that N_H measured and N_L measured are both measured with the same IF bandwidth. Also, N_H cannot be less than zero. Since the high-level noise is proportional to the signal power, and also to the IF bandwidth, we determine the high-level noise (N_H) in dBc/Hz as

$$N_H \text{ (dBc/Hz)} = 10 * \log [N_H \text{ (mW)}] - 10 * \log (\text{measurement bandwidth}) - T_L \text{ (dBm)}$$

T_L is the tone power of the tone present when the high-level noise was measured.

$$N_H \text{ (dBm)} = N_H \text{ (dBc/Hz)} + \text{Tone Power of nearest tone (in dBm)} + 10 * \log (\text{bandwidth (Hz)})$$

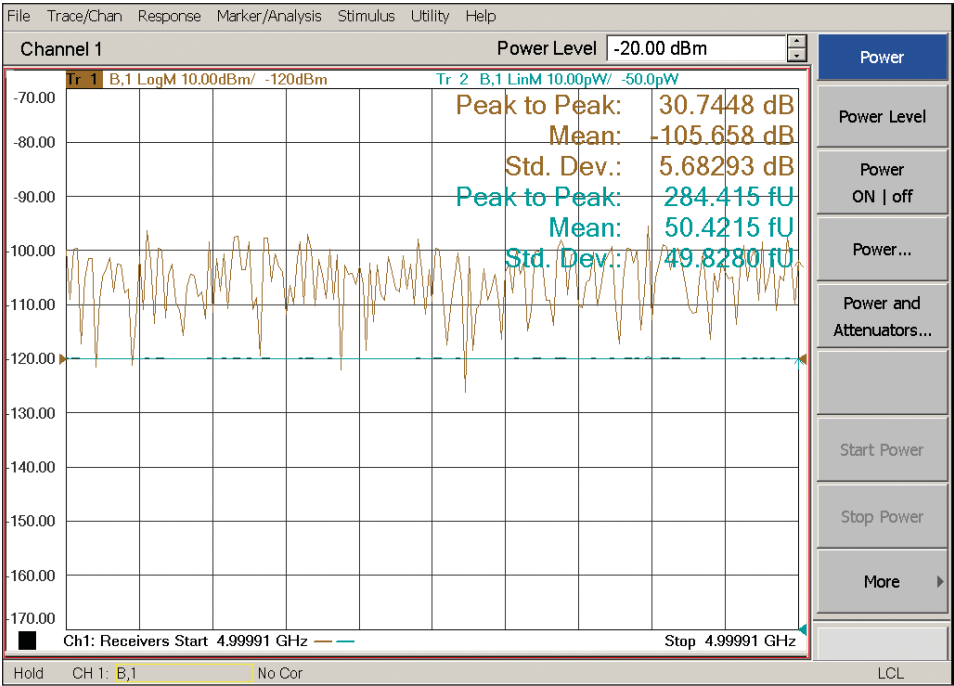

Figure 5. High-level noise characterization of PNA-X's receivers.

Receiver generated intermodulation distortion

Receiver generated intermodulation is similar to the intermodulation of the DUT and depends on the tone powers incident on the active components of the receiver. The receiver intermodulation can be calculated directly from the incident tone powers and the receiver third-order intercept. The third-order intercept of the receiver can vary with the tone spacing and frequency of measurement.

While the primary source of receiver intermodulation is normally the mixer and amplifiers in the network analyzer, in some situations other active devices in the analyzer may also introduce distortion, especially if the power into the analyzer is high. In particular, the transfer switch, which allows the analyzer to switch rapidly between sourcing the signal at different ports, can generate intermodulation distortion. To prevent this, the source step attenuator on the output side of the DUT can be increased as required. Each 5 dB of source attenuation reduces the unwanted intermodulation distortion signal of the transfer switch by 20 dB. In the remainder of this discussion, we will assume that the error due to transfer switch distortion is negligible.

PNA-X's receiver IMD can be determined by injecting a two-tone stimulus into the receiver port with the desired frequency and offset, and measuring the power of the two tones and one of the third-order intermodulation products. If the tone powers are insufficient to produce a large enough intermodulation distortion product in the receiver, the signal may be input directly into the "RCVR B IN" connector (if port 2 is being used to measure IMD). Care should be taken that the intermodulation signal measured is not the result of a spurious response, and is generated in the receiver, not in the sources or combiner network. The receiver IP3 can be calculated using the formula:

$$\text{IP3 (dBm)} = P(f_1) + (P(f_2) - P(2f_1 - f_2)) / 2$$

Where IP3 is the receiver IP3 in dBm, $P(f_1)$ and $P(f_2)$ are the measured power levels of the low-tone and the high tone in dBm, and $P(2f_1 - f_2)$ is the power of the low frequency intermodulation signal in dBm. The high intermod signal may also be used, in which case the equation becomes

$$\text{IP3 (dBm)} = P(f_2) + (P(f_1) - P(2f_2 - f_1)) / 2$$

Figure 6 shows the result of this measurement.

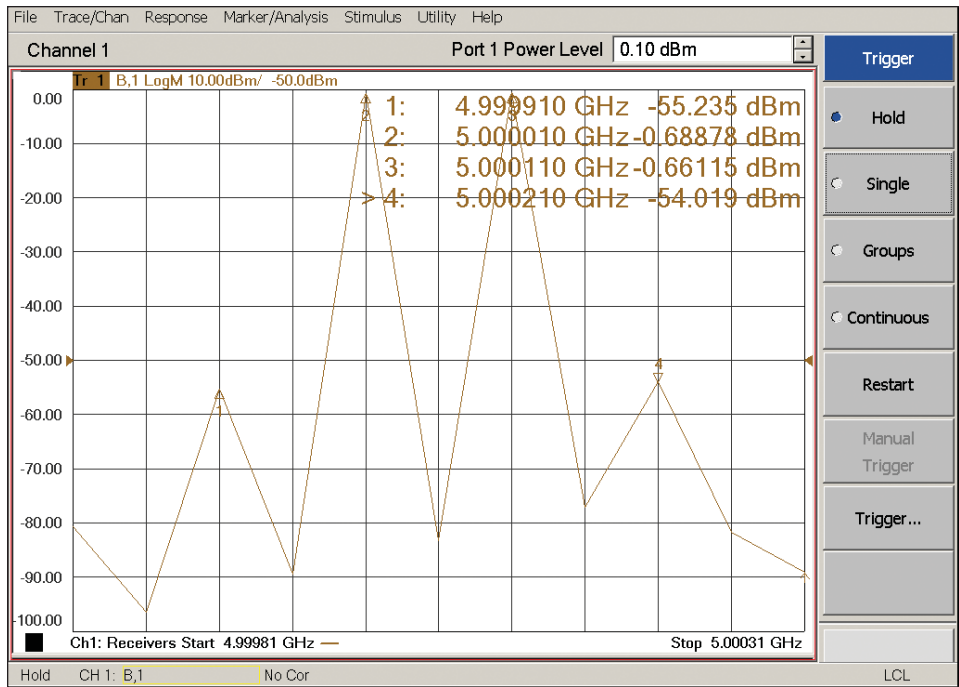

Figure 6. Intermodulation distortion characterization of PNA-X's receivers.

Each receiver intermodulation distortion signal power can be calculated from the receiver IP3 and the high and low-tone power:

$$\text{High side receiver intermod (dBm)} = P(f_1) - 2 * (\text{PNA-X Receiver IP3} - P(f_2))$$

$$\text{Low side receiver intermod (dBm)} = P(f_2) - 2 * (\text{PNA-X Receiver IP3} - P(f_1))$$

Combining receiver errors, calculating the error vector magnitude (EVM)

Once the three values of low-level noise, high-level noise and receiver IP3 are known, their error contribution to the intermodulation measurement can be calculated for any given IF bandwidth and tone power. The error terms can be combined into a single error vector, which then can be used to predict the error for a given measurement. To do this, the low-level noise power and high-level noise power are added.

$$\text{Total noise power (dBm)} = 10 * \log (10^{\text{low-level noise (dBm)}/10} + 10^{\text{high-level noise (dBm)}/10})$$

Since noise is a random signal, we can only say with a certain confidence that the error due to the noise will be bound by a certain amount. By adding 6 dB to the total noise power, we obtain a peak noise error signal that can be used to predict the measurement error with 99.7% confidence.

The receiver generated intermod signal, however, is a phasor at the same frequency as the signal we wish to measure. The worst-case error caused by a phasor can be readily calculated from the relative magnitude of the error signal and the signal being measured.

The peak noise signal and the receiver intermod signal are added to obtain an error contribution signal, which can be treated as an error vector for calculating worst-case errors in the measurement with approximately 99.7% confidence. We will call this the error vector magnitude (EVM).

$$\text{EVM (dBm)} = 20 * \log (10^{\text{receiver intermod}/20} + 10^{(\text{Total noise power} + 6)/20})$$

Note that this calculation assumes the worst-case phase for the receiver intermodulation error. For a fixed combination of tone powers, it is often convenient to express the error vector magnitude in terms relative to the closest tone:

$$\text{EVM (dBc)} = \text{EVM (dBm)} - \text{Tone Power (closest tone) (dBm)} \text{ (For a given set of tone powers and IF bandwidth)}$$

The table below shows the measurement errors (99.7% confidence) for several values of EVM and DUT intermodulation signals.

Table 4. Measurement error due to receiver EVM (dB) (99.7 % confidence)

Receiver EVM (dBc)	DUT IMD relative to tone power (dBc)					
	-30	-40	-50	-60	-70	-80
-60	0.28	0.90	3.2			
-70	0.09	0.28	0.9	3.2		
-80	0.027	0.09	0.28	0.9	3.2	
-90	0.009	0.027	0.09	0.28	0.9	3.2
-100		0.009	0.027	0.09	0.28	0.9

Measurement example

As an example of receiver characterization and EVM calculation, a PNA-X will be characterized for an IMD measurement at approximately 5 GHz, with a tone spacing of 100 kHz. In all of the characterizations, it is important to maintain a common point of reference for the power levels measured. For the purpose of performing these characterizations on a PNA-X, it is recommended that a receiver calibration with the receiver attenuator set to zero dB be performed and used. In this case, all of the power readings will refer to the equivalent power at the input of the calibrated measurement port, even if the signal is actually applied to the receiver input during the characterization.

Also, for all characterizations and measurements, set the PNA-X receivers to use the crystal filter path (the narrowband path), versus the standard wideband path. To set the crystal filter path, use the GPIB Window and enter the following SCPI command.

```
SENS:PATH:CONF:ELEM "IFSIGPATHALL ","NBF"
```

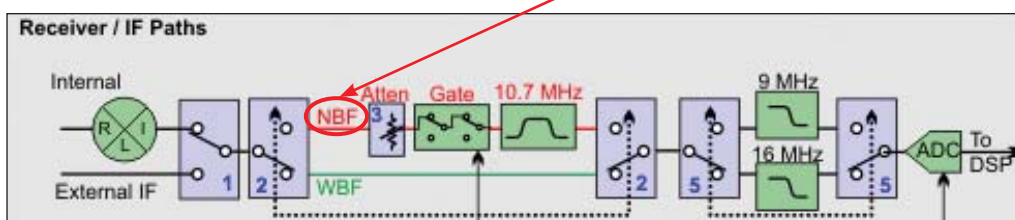

Figure 7. For all distortion measurements, it is recommended that you use the PNA-X crystal filter or narrowband path, depicted as NBF in this Figure.

Before the source and receiver performances are characterized, we connect the DUT to set up the network analyzer stimulus as desired. Configure the network analyzer to use the internal combiner, and set the power/attenuator and frequency-offset dialogs to the desired levels (see Figures 8, 9 and 10). Measure the power levels using the B trace, or B receiver, if your DUT is connected between ports 1 and 2. The tone and intermod powers can be read from the markers, preferably discrete markers, to ensure that the actual tones are being measured.

The amplifier examined here is tested under the following conditions:

- f_1 = 5.00001 GHz
- f_2 = 5.00011 GHz
- $2f_1 - f_2$ = 4.99991 GHz
- $2f_2 - f_1$ = 5.00021 GHz
- $P(f_1)$ = -10 dBm (input power: -20 dBm, gain: 10 dB)

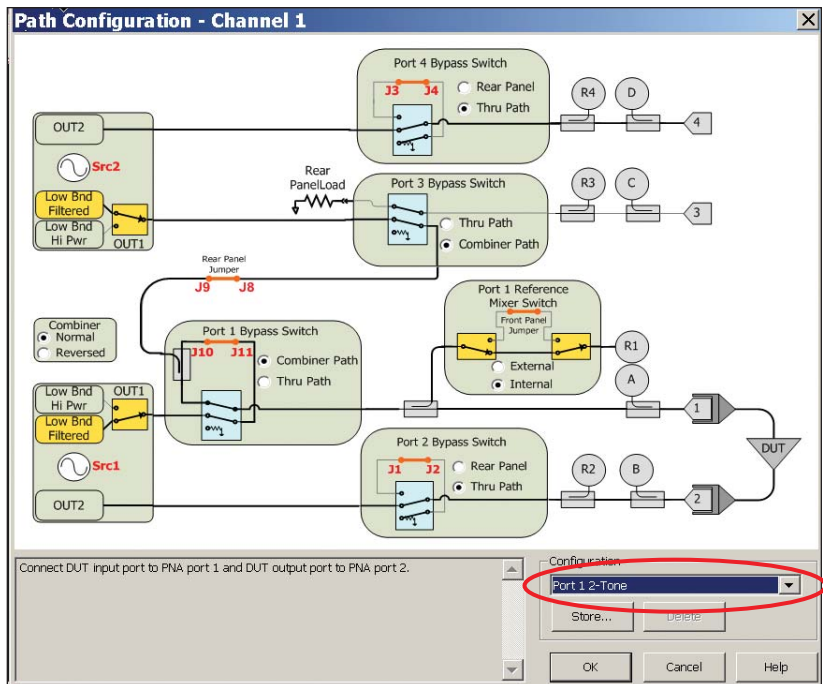

Figure 8. Path configurator setting set to two-tone measurements.

Frequency Offset: Channel 1

Frequency Offset (ON/OFF)

	Mode	Sweep Type	Settings
Primary		Linear Frequency	4.9998100000 GHz - 5.0003100000 GHz, 11
Source	Un-Coupled	Linear Frequency	5.0000100000 GHz - 5.0000100000 GHz
Receivers	Coupled	Linear Frequency	4.9998100000 GHz - 5.0003100000 GHz
Source2	Un-Coupled	Linear Frequency	5.0001100000 GHz - 5.0001100000 GHz

X-Axis Display
 Annotation: Receivers X-Axis Point Spacing

OK Cancel Help

Figure 9. Frequency-offset menu configured so that Source is set to f_1 , 5.00001 GHz, Source2 to f_2 , 5.00011 GHz, and the receiver to sweep a wide enough range to cover all four tones.

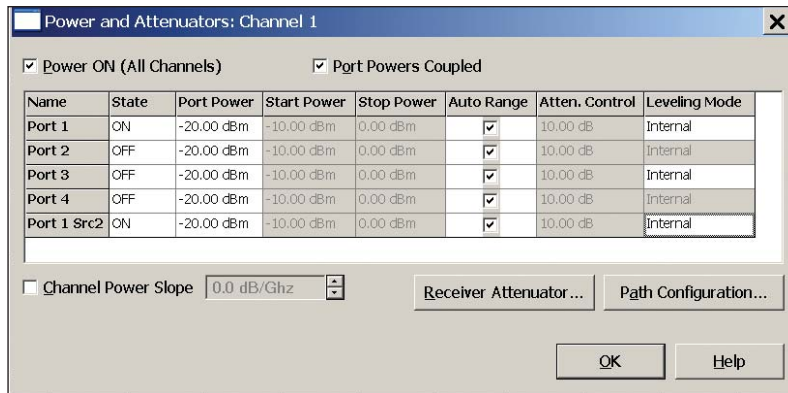

Figure 10. Power dialog settings. Both sources are on during the IMD measurement.

Measurement of low-level noise

Following a receiver calibration, the low-level noise, high-level noise, and IP3 of the receiver are measured. With both sources off and the receiver set to measure the low-side tone, we measure the low-level noise (see Figures 11, 12, and 13).

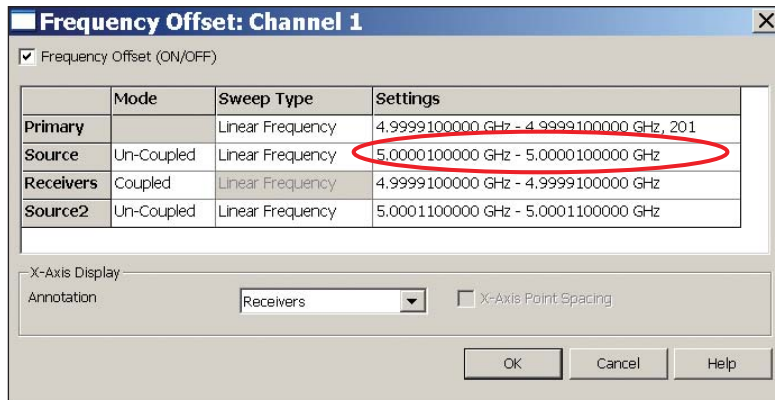

Figure 11. Frequency-offset menu configured so that the receiver measures the low-side intermod product. The frequency setting for the two sources is not relevant, as the sources are turned off (see Figure 12, power dialog settings).

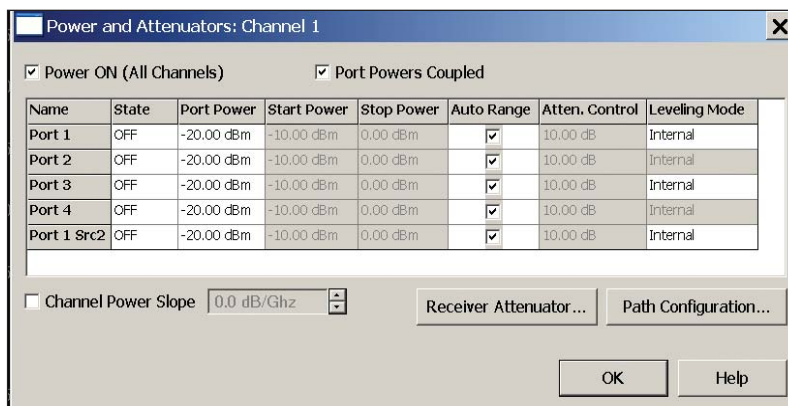

Figure 12. Power dialog settings. Both sources are turned off during the low-level noise characterization.

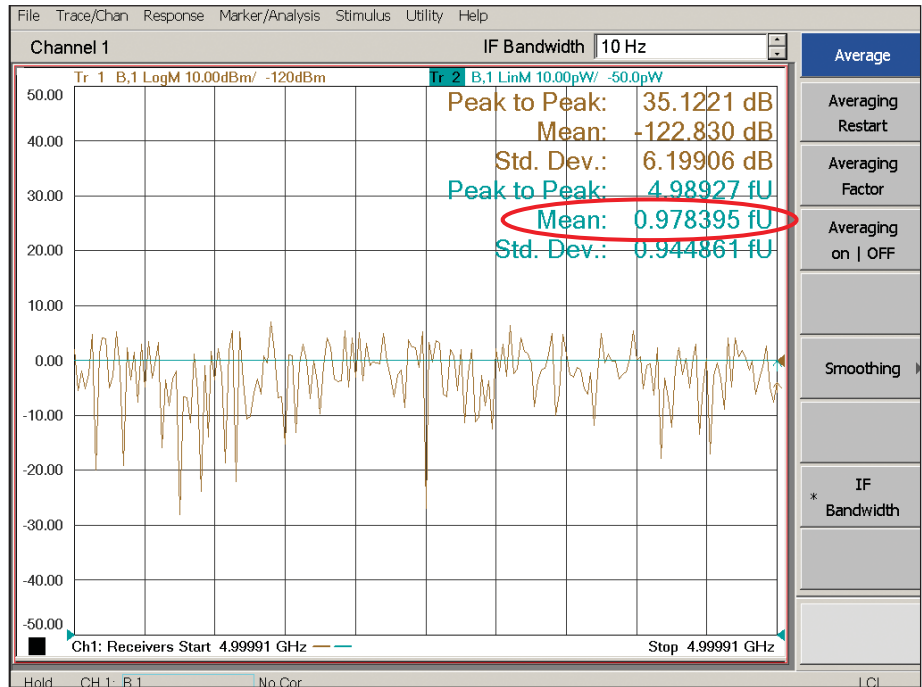

Figure 13. Low-level noise measurement results.

Low-level noise = 0.97 fW

$$N_L \text{ (dBm/Hz)} = 10 * \log (N_L \text{ (mW)}) - 10 * \log (\text{measurement bandwidth (Hz)})$$

$$N_L = 10 * \log (0.97 \times 10^{-12}) - 10 = -120.1 - 10 = -130 \text{ dBm/Hz}$$

Note: In order to measure the noise, we use the mean value of the trace. The correct way to measure the mean is to use linear math. If you use the log format mean, you will find that the logarithmic mean is approximately 2 dB more than the linear mean. In this example, 0.97 fW corresponds to -120 dBm, which is approximately 2 dB more than the log mag mean of -122 dBm. The correct measurement is the one in Lin Mag format (shown as Trace 2 in Figure 13).

You can also find the low-level noise value from the data sheet, in the test port noise floor section. The typical value for a PNA-X is -117 dBm in a 10 Hz bandwidth, or -127 dBm/Hz. This is close to our measured value of -130 dBm/Hz.

Measurement of high-level noise

The high-level noise at the low intermod frequency is measured by turning off the high tone and setting the receiver frequency to the low intermod frequency, with zero span, 201 points, and an IF Bandwidth of 10 Hz. Wider bandwidths and higher power levels can be used, as they are normalized in the equation. The high-level noise is described in dBc/Hz. To measure the noise power, the mean value displayed by the trace statistics feature can be used with the linear magnitude display format. The connection is a through connection between the source and receiver (port 1 to 2), with no DUT (See Figures 14, 15 and 16).

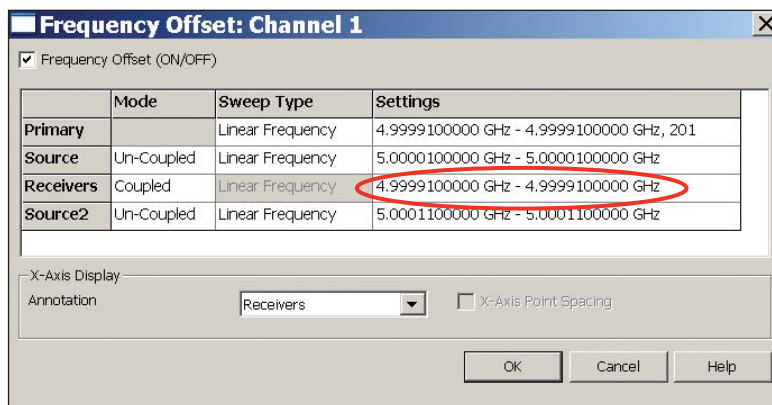

Figure 14. Frequency-offset menu configured so that Source is set to the low-side tone f_1 , while the receiver is set to sweep the low-side mixing product $2f_1 - f_2$.

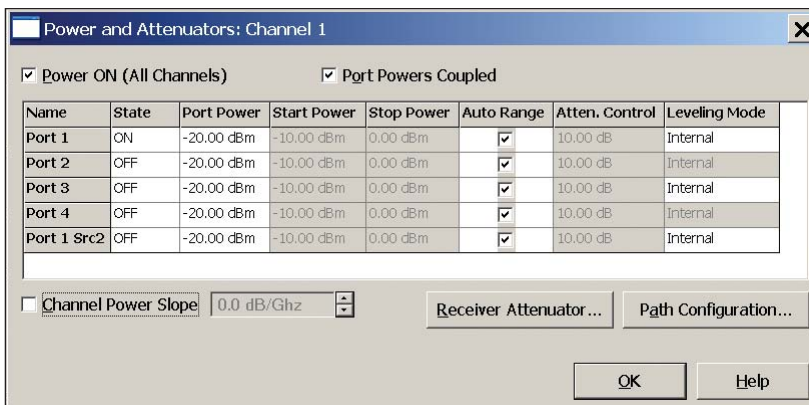

Figure 15. Power dialog settings. The high-side tone is turned off during the high-level noise characterization.

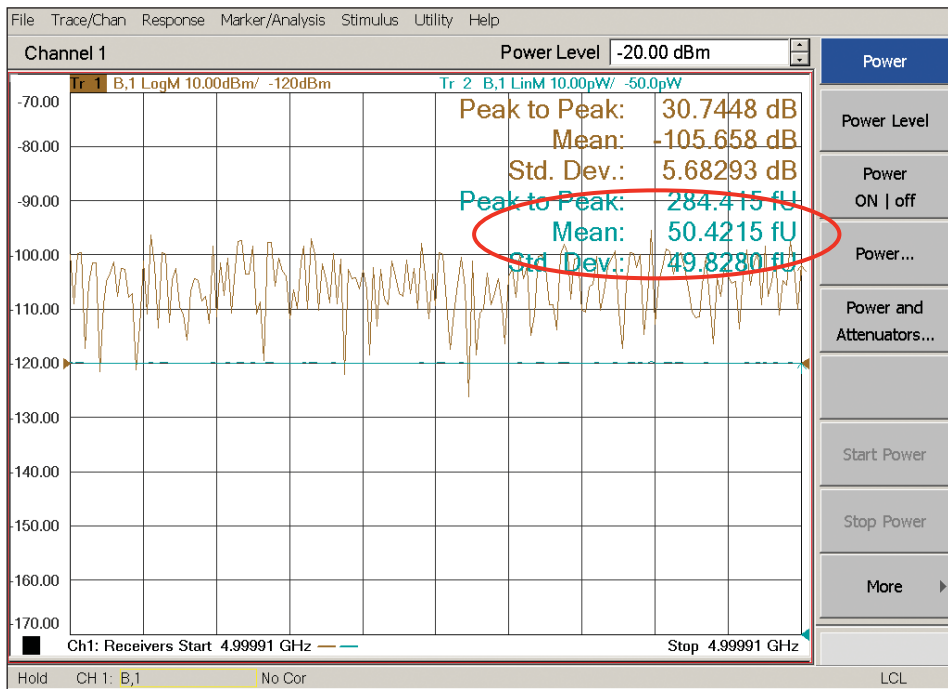

Figure 16. High-level noise measurement results.

Apparent high-level noise = 50.4 fW

$$N_H = N_H \text{ measured (mW)} - N_L \text{ measured (mW)}$$

$$N_H = 50.4 \text{ fW} - 0.97 \text{ fW} = 49.4 \text{ fW} = 49.4 \times 10^{-12} \text{ mW}$$

$$N_H \text{ (dBc/Hz)} = 10 * \log (N_H \text{ (mW)}) - 10 * \log (\text{measurement bandwidth}) - T_L \text{ (dBm)}$$

$$N_H \text{ (dBc/Hz)} = -103 - 10 - (-20) = -93 \text{ dBc/Hz}$$

You can also find the high-level noise value from the data sheet, in the phase noise section. The typical value for a PNA-X is -94 dBc/Hz. Again, this is close to our measured value of -93 dBc/Hz.

Measurement of receiver distortion

Next we measure the distortion of the PNA-X receiver. The connection for this measurement is a through connection between the source and receiver, and the analyzer stimulus is configured the same way we set up the DUT measurement, except the DUT is not connected. In this example, we had to increase the power from -20 to 0 dBm, so we could measure the distortion products. With -20 dBm of input power (the desired power incident upon the DUT), the receiver distortion products were near the noise and difficult to measure. So we increased the power to 0 dBm.

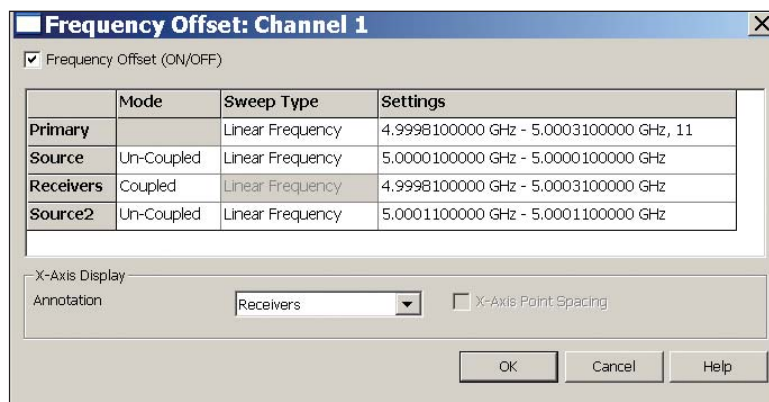

Figure 17. Frequency-offset setup for receiver distortion measurement.

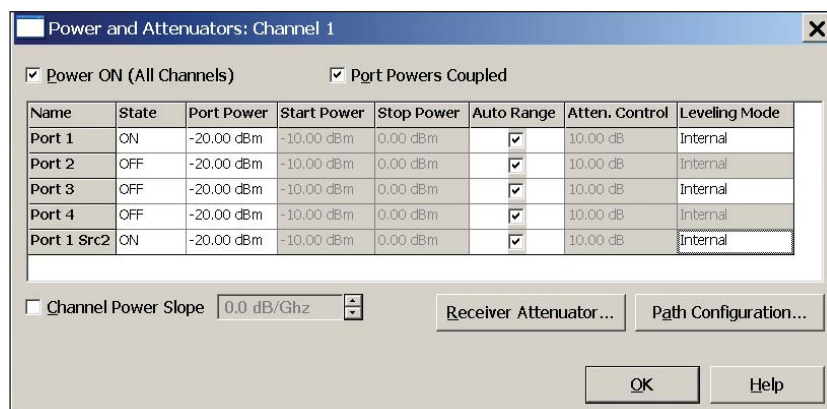

Figure 18. Power setup for receiver distortion measurement. Both sources are on, as they would be during a standard IMD measurement.

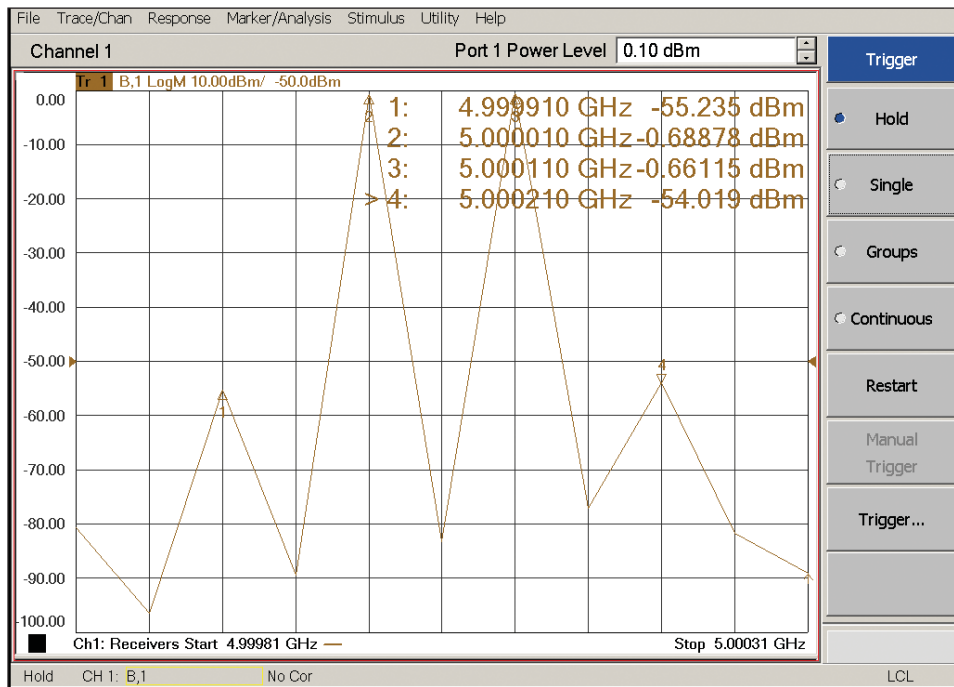

Figure 19. Receiver distortion measurement results.

$$\begin{aligned}
 P(2f_1 - f_2) &= -55.2 \text{ dBm} \\
 P(f_1) &= -0.6 \text{ dBm} \\
 P(f_2) &= -0.6 \text{ dBm} \\
 P(2f_2 - f_1) &= -54.0 \text{ dBm}
 \end{aligned}$$

Using $P(2f_2 - f_1)$, the receiver IP3 is:

$$\begin{aligned}
 \text{PNA-X's receiver IP3 (dBm)} &= P(f_2) + (P(f_1) - P(2f_2 - f_1)) / 2 \\
 &= -0.6 + (-0.6 - (-54.0)) / 2 \\
 &= \mathbf{26 \text{ dBm}} \text{ (referenced at port 2)}
 \end{aligned}$$

At the time of the publication of this application note, the PNA-X data sheet does not supply IP3 values.

Noise contributions during the measurement

If the measurement is made with a 10 Hz IFBW, with input power of -20 dBm for the fundamental tones (-10 dBm output power for the fundamental tones), the errors can be calculated as follows:

$$N_L \text{ (dBm)} = N_L \text{ (dBm/Hz)} + 10 * \log (\text{measurement bandwidth (Hz)})$$

$$N_L \text{ (dBm)} = -130 + 10 * \log (10) = \mathbf{-120 \text{ dBm}}$$

$$N_H \text{ (dBm)} = N_H \text{ (dBc/Hz)} + \text{Tone Power of the nearest tone (in dBm)} + 10 * \log (\text{measurement bandwidth (Hz)})$$

$$N_H \text{ (dBm)} = -93 + -10 + 10 \log (10) = \mathbf{-93 \text{ dBm}}$$

$$\text{Total noise power (dBm)} = 10 * \log (10^{\text{low-level noise (dBm)/10}} + 10^{\text{high-level noise (dBm)/10}})$$

$$\mathbf{\text{Total noise power (dBm)} = 10 * \log (10^{-120/10} + 10^{-93/10}) = -93 \text{ dBm}}$$
 (Phase noise or high-level noise is the main source of noise in this measurement)

Determining EVM:

Once the IP3 and the total noise power have been obtained, we can calculate the EVM for a particular set of tone powers in a measurement, and in turn use the EVM to predict the measurement error.

$$\text{EVM (dBm)} = 20 * \log (10^{\text{receiver IP3} / 20} + 10^{(\text{Total noise power} + 6) / 20})$$

$$P (f_1) \text{ (DUT)} = P (f_2) \text{ (DUT)} = -10 \text{ dBm}$$

$$\mathbf{\text{PNA-X receiver IP3} = +26.0 \text{ dBm}}$$

$$\text{Recall that high-side receiver intermod (dBm)} = P (2f_2 - f_1) = P (f_1) - 2 * (\text{PNA-X Receiver IP3} - P (f_2))$$

$$P (2f_2 - f_1) = -10 - 2 * (26 - (-10)) = -82 \text{ dBm}$$

So the EVM will be:

$$\mathbf{\text{EVM (dBm)} = 20 * \log (10^{(-82 / 20)} + 10^{(-93 + 6) / 20}) = -78 \text{ dBm, or } -68 \text{ dBc relative to the } -10 \text{ dBm tone power.}}$$

EVM variation with tone power and IF Bandwidth

From the equations, it is clear that the EVM will be dominated by the receiver IMD at high tone powers, and by the low-level noise at low tone powers.

Figure 20 shows the EVM in dBc as a function of tone power for several IF bandwidths, for the 5 GHz DUT that we measured, with a 100 kHz tone spacing. Figure 21 shows a similar plot for a 900 MHz DUT, with 1 MHz tone spacing.

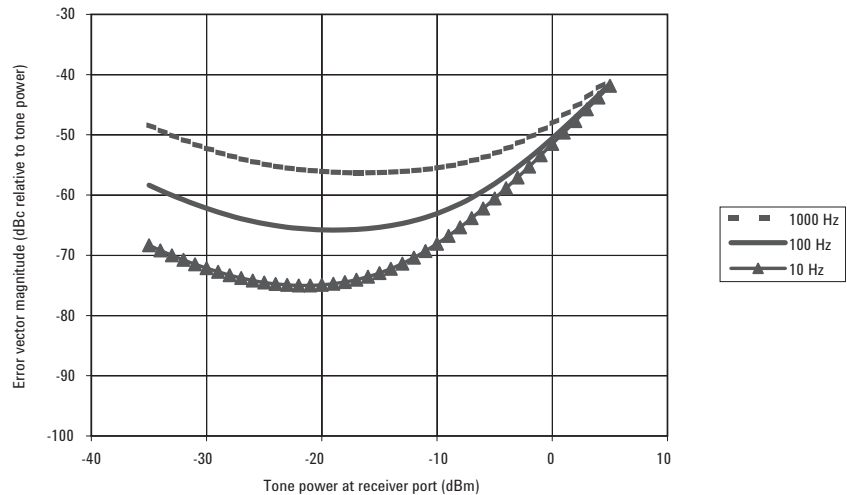

Figure 20. Error Vector Magnitude as a function of tone power and IF bandwidth, 5 GHz DUT.

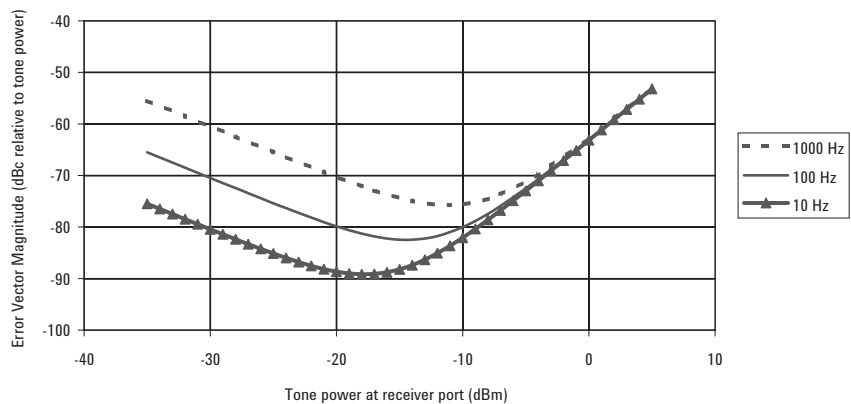

Figure 21. Error Vector Magnitude as a function of tone power and IF bandwidth, 900 MHz DUT.

From the graph, we can see that for each IF bandwidth, there is an optimum power for the tones.

Setting the receiver attenuator

For two-tone measurements, we want to measure the distortion produced by the DUT under specific conditions of tone power and frequency, with the greatest possible speed and accuracy. As we have seen, the receiver errors are a function of the power of the two tones. While we cannot, in general, alter the signal power levels present at the DUT in order to improve the measurement accuracy, we can adjust the power present at the receiver by changing the receiver attenuator settings.

The goal of receiver optimization is to select the receiver attenuator setting that provides the best possible accuracy for an IMD measurement, for a given IF bandwidth, tone spacing, and frequency. This optimization can be achieved by calculating the EVM in dBc for each of the receiver attenuator settings, and selecting the setting which gives the lowest EVM value (lowest dBc).

For example, we can optimize the measurement of our 5 GHz DUT by using Figure 20. In this example, we want to make the measurement with a 10 Hz IF bandwidth. The DUT output tone power was -10 dBm. From the graph, we see that the optimum tone power for a 10 Hz IF bandwidth is approximately -20 dBm (for -75 dBc of relative error). We would therefore set the receiver attenuator to 10 dB to optimize this measurement¹. This reduces the tone level seen by the active components of the PNA-X receiver, thereby reducing the receiver intermodulation. The numerical model is as follows:

Tone incident upon the receiver = $P(f_1)$ (DUT) = $P(f_2)$ (DUT) = -20 dBm

Therefore the intermod level is:

$$P(2f_2 - f_1) = -20 - 2*(26 - (-20)) = -112 \text{ dBm}$$

High-level noise power also is reduced

$$\text{High-level noise} = N_H \text{ (dBm)} = -93 - 20 + 10 = -103 \text{ dBm}$$

Total noise power becomes

$$\text{Total noise power (dBm)} = 10 * \log(10^{-120/10} + 10^{-103/10}) = -103 \text{ dBm}$$

The EVM calculation becomes

$$\text{EVM (dBm)} = 20 * \log(10^{-112/20} + 10^{(-103+6)/20}) = -95 \text{ dBm, or } -75 \text{ dBc relative to the } -20 \text{ dBm tone power.}$$

This agrees with the graph value and represents an improvement in the EVM over the original setting.

Appendix A contains a series of tables showing optimum input power and EVM for a variety of measurement frequencies and tone spacing values.

1. The PNA-X receiver attenuators offer a total of 35 dB of attenuation, in 5 dB steps.

A Shortcut:

The previous discussion provides a means for determining the EVM of the receiver with a high degree of confidence for a particular measurement configuration. However, examination of Figure 20 and Figure 21, as well as experience with the PNA-X, show that in most cases, good results will be obtained if the receiver attenuator setting is equal to the signal level into the test port +20 dB for a 10 Hz IFBW, as shown below.

Signal level into test port (fundamental tone output power)	IFBW	Receiver attenuator recommended setting (column 1 + 20 dB)
-20 dBm	10 Hz	0 dB (no attenuation)
-10 dBm	10 Hz	10 dB
0 dBm	10 Hz	20 dB
+10 dBm	10 Hz	30 dB
+20 dBm	10 Hz	40 dB (but PNA-X only has 35 dB of internal receiver attenuation, so insert a 3 or 6 dB external attenuator and 35 dB of internal attenuation)

In addition, the table in appendix A can be used to determine the optimum port power for most situations.

Source Considerations

The dual internal source and internal combiner of the PNA-X provide the means for accurate and efficient IMD measurements. In order to understand the contribution of the source to accurate IMD measurements, we will examine the following source specifications and settings: port power, source harmonics, and source cross-modulation.

Port power available from combined sources

The port power in combined mode is available on the data sheet, reproduced here for convenience:

Table 5. Typical maximum leveled power (dBm), N5242A PNA-X Option 224 or 423

Frequency range	Source 1, Port 1 Combine Mode Filtered Mode ¹	Source 1, Port 1 Combine Mode Hi Pwr Mode ¹	Source 2, Port 1 Combine Mode Filtered Mode ¹	Source 2, Port 1 Combine Mode Hi Pwr Mode ¹
10 to 50 MHz	7	17	-7	3
50 to 500 MHz	9	17	-5	4
0.5 to 3.2 GHz	9	10	-5	-4
3.2 to 10 GHz		15		2
10 to 16 GHz		11		-2
16 to 20 GHz		8		-4
20 to 24 GHz		6		-6
24 to 26.5 GHz		2		-11

Based on your test requirements, you will have to decide the necessary power levels. If the frequencies of the two tones are less than 3.2 GHz, you need to determine if you want to use PNA-X's "Filtered Mode" or "Hi Pwr Mode". As the names imply, the difference in the modes is in output power and harmonic performance. In "Filtered Mode", you are guaranteed at least 60 dBc harmonics at the maximum specified output power. In "Hi Pwr Mode", that harmonic level is reduced to 23 dBc, but that maximum guaranteed output power is increased by anywhere from 1 to 10 dB. For frequencies above 3.2 GHz, there is only one mode. For IMD measurements, it is generally preferable to use "Filtered Mode". The benefit of having low harmonics is explained in the next section.

1. In Filtered Mode, the signal path goes through filters to optimize harmonics below 3.2 GHz. In Hi Pwr Mode, the signal bypasses the filters to maximize output power.

Impact of source harmonics

Source harmonics degrade multitone measurement accuracy when they mix with other tones in the DUT to produce signals that interfere with the distortion signals being measured. For two-tone third-order measurements, this occurs when the second harmonic of one source ($2f_1$) is mixed in the DUT with the tone from the other source (f_2), producing a signal at the same frequency as the third-order intermodulation distortion signal ($2f_1 - f_2$). In other words, the third-order distortion signal generated by the DUT from the two incident tones occurs at the frequencies ($2f_1 - f_2, 2f_2 - f_1$) which are also the difference products that result from mixing one tone and the second harmonic of the other tone.

Therefore if the second harmonic of one of the tones is incident upon the DUT, the DUT will generate a signal at the intermodulation frequency that will add to the signal we are trying to measure, thus causing an error in the measurement. The magnitude of this error depends upon the level of the incident harmonic signal and the efficiency of the mixing process in the DUT. For this reason, considerable effort has gone into optimizing the second harmonic performance of the synthesizers in the PNA-X. The specified harmonic performance of the PNA-X is available from the PNA-X data sheet and is reproduced here for your convenience.

Table 6. Typical second harmonics at maximum specified power (dBc), N5242A PNA-X

	Port 1 or 3, Source2 Out1	Port 2 or 4 Source2 Out2
10 MHz to 50 MHz	-51	-13
50 MHz to 500 MHz	-51	-13
500 MHz to 3.2 GHz	-60	-21
3.2 GHz to 10 GHz	-60	-21
10 GHz to 16 GHz	-60	-21
16 GHz to 20 GHz	-60	-21
20 GHz to 24 GHz	-60	-21
24 GHz to 26.5 GHz	-60	-21

In any specific measurement, the level of the source harmonic can also be measured directly by using the receiver measurement capability of the PNA-X to measure the signal at the second harmonic of the source. Note that the receiver attenuator must be set to a high enough level to ensure that the receiver itself is not generating significant second harmonics. Once the level of the source harmonic (from the analyzer) incident on the DUT is established, either by measurement or from the specification table, the magnitude of the unwanted signal generated by the source second harmonic can be determined accurately by the following method:

1. Configure the network analyzer and DUT for the desired IMD measurement.
2. Set one of the two sources to the power level to be used in the IMD measurement (example: Source at f_1 , at -20 dBm).
3. Set the other source to two times the frequency of the second tone to be used in the IMD measurement (example: Source2 at $2f_2$).
4. Set the power of the second source (Source2 in this example) to the pre-determined second harmonic power of the second tone (set the power of $2f_2$ to approximately 60 dBc less, or -80 dBm). This may require an external attenuator be inserted into one of the external links to reduce the power to the desired level, if the internal attenuation is not enough.
5. Measure the power of the resulting mixed signal at the output of the DUT ($2f_2 - f_1$).
6. If the signal is too small to measure, the power of the signal at the second harmonic frequency may be increased. Since the mixing process is linear with power for small signal levels, the level of the undesired mixing signal present in the IMD measurement will be lower than the signal measured by this technique by the same amount as the increase in power.

The signal power measured in this manner is the magnitude of an error term that will add as a vector to the distortion signal produced when both tones are present.

Another way to assess the impact of the source harmonics on an IMD measurement is to add filtering to the input of the amplifier to reduce the level of the source harmonics. If no change is observed in the two-tone product, then one can assume that source harmonics were not contributing to the measurement. However it is possible for small signal changes to occur due to changes in power or source impedance introduced by the filter, so care must be exercised in interpreting the results. Filtering the source harmonics in narrowband cases is fairly simple. A low pass filter with a cut-off frequency higher than the second tone can be added to the source loop of the PNA-X. For broadband devices, similarly a filter can be used, however finding the appropriate filter is more challenging, as you need a filter that lets the main tones through, while filtering the second harmonic.

For single connection multiple measurement tests, it is possible to use filters during the IMD measurement only by inserting filters on each combiner input, and simply bypassing the combiner for measurements where filtering is not desired. This technique can also be used to insert isolators and amplifiers specifically for IMD measurements.

Source cross-modulation

Source cross-modulation is another error that can degrade IMD measurements. Source cross-modulation is generation of signals at the IMD frequencies, in the source and combining network, not the DUT. This occurs due to the action of the leveling loop (if the detector reacts to both tone frequencies) or because of the intermodulation distortion of active devices inside the network analyzer exposed to both tone frequencies. The internal combining network of the PNA-X reduces the level of source cross-modulation to essentially insignificant levels for specified port powers.

In order to get an approximate measurement of the internal source sensitivity to cross-modulation, we inject a signal from one source into the output of the other, bypassing the combining network. By measuring the cross-modulation at the ports of the analyzer, we can compare this behavior for the PNA-X internal sources with other signal sources.

The source IP3 can also be measured with a spectrum analyzer or PNA-X's own receivers. You just have to make sure you are not measuring the receivers' IP3, usually by applying enough receiver attenuation. You can configure the PNA-X as you would for your desired IMD measurement. Instead of connecting port 1 to the DUT, you would connect it to the receiver (either the PNA-X or a spectrum analyzer). Then you can look at the signal present at the intermod frequency to determine the level of source-cross modulation.

Figure 22 shows the source IP3 for different tone power levels, for two different frequencies (750 MHz and 23.5 GHz). Sources with lower IP3 levels require greater isolation between the sources to achieve the same level of source distortion.

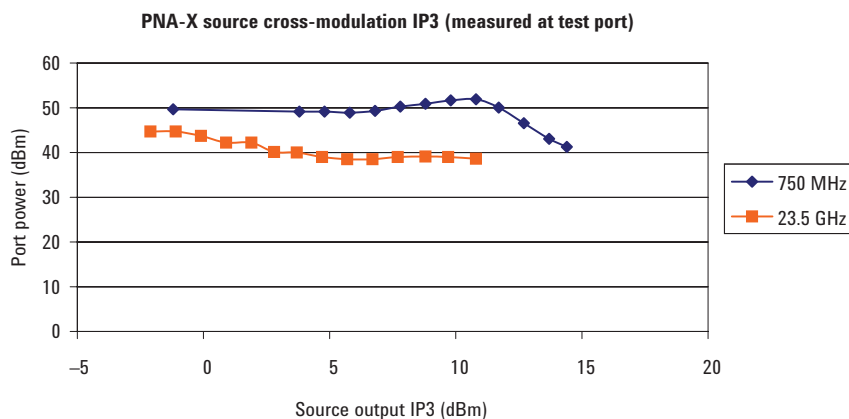

Figure 22. Source IP3 (due to source cross-modulation) for the PNA-X.

Avoiding spurious signals in IMD measurements

Almost inevitably, synthesizers generate low-level spurious signals at some frequencies. These are normally not a problem for network analyzer measurements, as most traditional network analyzer measurements are linear measurements performed at a single frequency, on both the input and output. However, these spurs can cause errors in intermodulation measurements, if the spurious responses occur at or near the intermodulation frequencies being measured. Fortunately, the presence of spurious signals in the measurement can be detected, and thus avoided. In addition, we can use our knowledge about the spurious generation in the source to design measurements that are less likely to be impacted by these unwanted spurs.

In this section, we describe a method to determine whether a signal that appears as a spur is a product of the test equipment (the network analyzer in this case) or a spur created within the DUT. For best results, the procedure described here is performed at a single frequency at a time. This allows for a more sensitive check for the presence of spurious than a “swept” measurement. In order to check for the presence of a spurious signal in an intermodulation measurement, the user should begin by setting up the offset frequencies and source powers as they would be for the measurement of the DUT.

The receiver step attenuators and the source attenuators on the receiver port should also be set to the optimum level, as explained in the source and receiver considerations section. Also, the receiver IF bandwidth should be the same as or less than that used in the measurement. Using these settings, four conditions are checked to determine whether a spurious signal is present or not.

These four conditions are the low and high intermod frequencies with only the low-tone present, and the low and high intermod frequencies with only the high-tone present. In each of these conditions, a CW sweep of the received power is taken. Since only one tone is present at an offset from the measurement frequency, any signal other than random noise that is present in the measurement will be a spurious response. Let us examine the first case: the low intermod frequency with the low-tone present.

Configure the network analyzer so that the output of port 1 is a signal at the low-tone frequency or f_1 . With a PNA-X, the simplest way to turn the second source off is to use the power/attenuator dialog box. In the FOM dialog box, set the receiver to measure the desired tone, with the center frequency set to the desired tone, which is the low intermod frequency ($2f_1 - f_2$), and the span set to zero. Theoretically, there should be no $2f_1 - f_2$ signal present, as the f_2 source has been turned off. So in this case, any signal at the $2f_1 - f_2$ frequency is a spurious signal. Two methods of analysis are particularly useful in determining the presence and the level of spurious signals.

The first method for detecting the presence of a spurious signal in a measurement signal is a quantitative approach, in which trace statistics are used in the “Linear Magnitude” format of the network analyzer. This approach takes advantage of the fact that for normally distributed random noise, the mean and standard deviation of the linear magnitude are equal. Any spurious signal contained in the noise will increase the ratio of the mean to the standard deviation.

To use this method, we make B receiver measurements and observe the data in liner magnitude format. Since the mean and standard deviation uncertainty depend on the number of samples, the ability to detect spurious signals using this approach improves as the number of points in the trace increases. If we use 201 points, a mean to standard deviation ratio of 1.25 or greater indicates the presence of a spurious signal with a high degree of confidence. Trace one (upper traces) in Figures 23 and 24 shows the data in linear format. The ratios of the mean to the standard deviations are shown for each trace, indicating the presence of a spur in Figure 24, but not Figure 23.

The second method is a qualitative approach, in which the B receiver measurement trace is observed on a polar plot. On a plot of this sort, noise is randomly distributed, in both magnitude and phase. The resulting trace is a “fuzz ball” centered at the origin, which has a slight increase in density towards the center, and random spikes at the edges. This is shown in Figure 23, Trace 2 (lower trace).

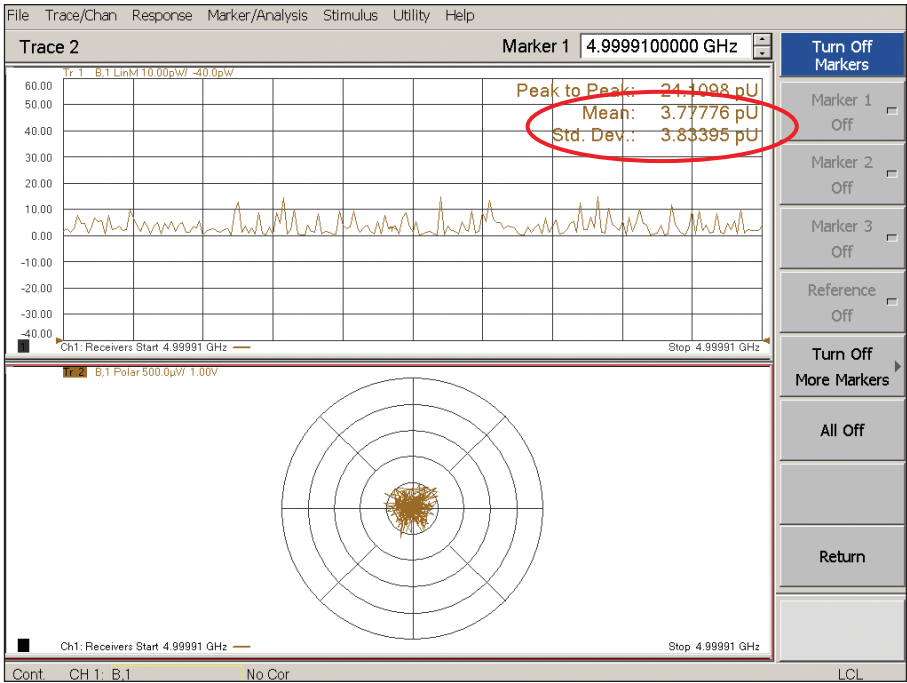

Figure 23. Noise with no spurious signal. In Trace 1 (the upper trace), the ratio of the mean to standard deviation is less than 1.25, indicating a noise with no spurious signal. Similarly, in the lower trace, a “fuzz ball” centered around the origin indicates the lack of spurs.

A spurious response at exactly the frequency of measurement that is close in power to the noise will cause the fuzz ball to be offset from the origin.

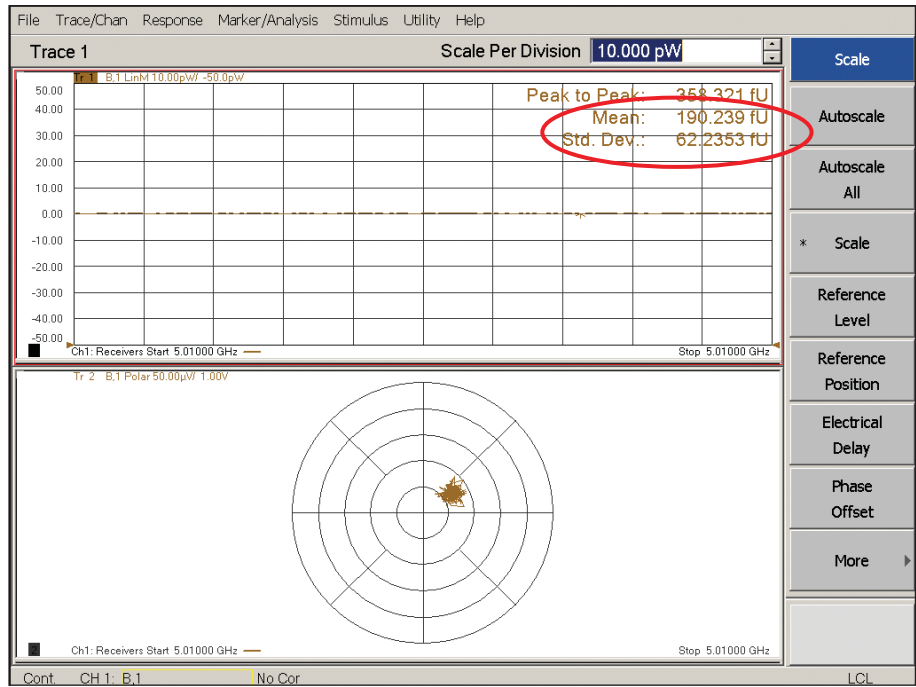

Figure 24. Noise in the presence of a spurious signal. In Trace 1 (the upper trace), the ratio of the mean to standard deviation is 3.4, which is more than 1.25, indicating the presence of a spurious signal. Similarly, in the lower trace, a “fuzz ball” offset to the side indicates the presence of a spurious signal.

If the spurious signal power is close to the noise power, but the spurious signal is at a slightly different frequency from the measurement frequency, the result may resemble the following plot. This plot differs from the polar plot of random noise in that the density of the data decreases near the origin.

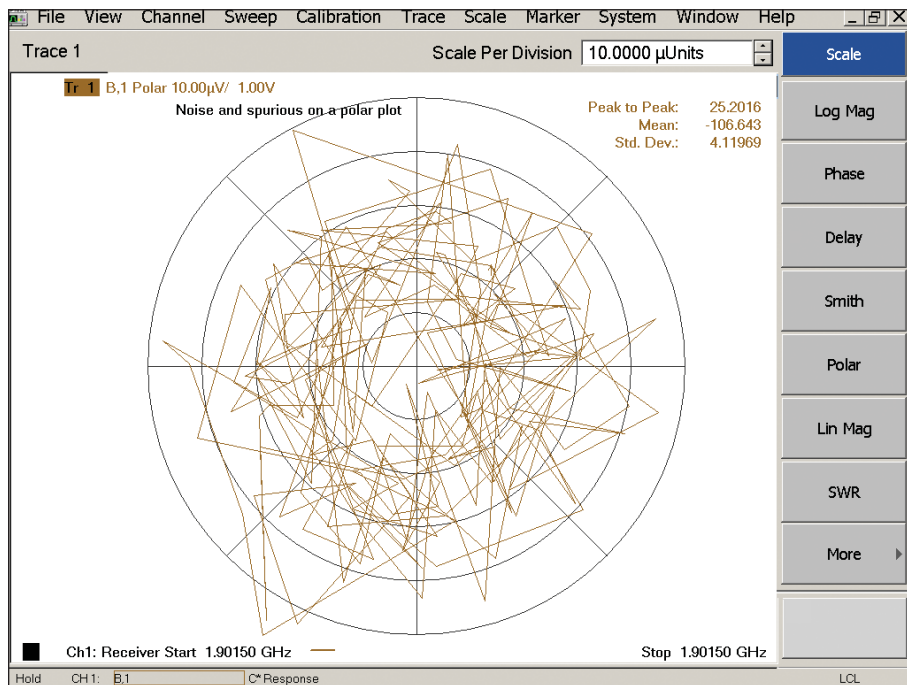

Figure 25. Off-frequency spurious signal.

If a spurious response is detected in a particular measurement, the source and/or receiver frequencies should be changed so that the spurious signal does not effect the measurement. This can be done by moving tone frequencies while keeping the tone spacing constant (therefore changing all of the tone and the intermod frequencies by the same amount), or by changing the tone spacing (thereby changing the high-tone and intermodulation frequencies in the opposite direction from the low-tone and intermodulation frequencies). In specific cases, one of these techniques may work better than the other, depending upon the mechanism of spur generation in the sources. In either case, it is generally only necessary to move the frequencies by several times the IF Bandwidth.

In the PNA-X, the frequency synthesizers are known to produce low-level spurious signals at easily predictable frequencies at source frequencies above 500 MHz. These spurious signals are proportional to the difference in frequency between the synthesizer frequency and the nearest even multiple of 10 MHz. For IMD measurements, spurious signals of this type can be avoided by using one of the following frequency selection protocols:

1. Center frequency protocol

Choose the center frequency of the two tones to be offset from an even multiple of 10 MHz by more than 10 times the IF bandwidth to be used. Example:

Planned center frequency: 1.9 GHz
Planned tone spacing: 1 MHz
Planned IF bandwidth: 100 Hz

Selected center frequency = 1.900001 GHz
Selected tone spacing = 1 MHz

2. Tone frequency protocol

Choose one tone to be offset from an even multiple of 10 MHz by 10 times the IF bandwidth. Example:

Planned tone 1 frequency: 1.9 GHz
Planned tone 2 frequency: 1.901 GHz
Planned IF bandwidth: 100 Hz

Selected tone 1 frequency: 1.900001 GHz
Selected tone 2 frequency: 1.901001 GHz

Spurious signals detected at the intermodulation frequency will degrade the measurement accuracy. Spurious signals can be determined based on knowledge of the source, or detected using the vector measurement capability of the PNA-X. This information can be used to allow selection of source frequencies that eliminate the spurious response from the measurement.

Appendix A: IMD Optimization tables for the PNA-X

The following tables were generated for a specific PNA-X of typical performance, using the methods described in this application note. In the tables, the optimum power is shown as a 5 dB range, corresponding to the 5 dB resolution of the receiver attenuators. The EVM value shown is the worst case within each 5 dB power window. The tables list the error vector magnitude (combined effects of receiver intermod, low-level noise, and high-level noise) for the optimum port power range (receiver attenuator = 0 dB), for different IFBW's, tone spacings, and frequencies.

Error vector magnitude values shown in dBc, for the conditions listed

RF frequency	IF bandwidth (Hz)	Tone spacing			
		50 kHz	200 kHz	500 kHz	1 – 10 MHz
900 MHz	3	-90 dBc (-15 to -20 dBm)			-91 dBc (-15 to -20 dBm)
	10	-88 dBc (-14 to -19 dBm)			-89 dBc (-14 to -19 dBm)
	100	-80 dBc (-11 to -16 dBm)			-82 dBc (-11 to -16 dBm)
	1000	-73 dBc (-8 to -13 dBm)			-75 dBc (-7 to -12 dBm)
1.75 GHz	3	-89 dBc (-18 to -23 dBm)	-92 dBc (-18 to -23 dBm)	-93 dBc (-18 to -23 dBm)	-93 dBc (-18 to -23 dBm)
	10	-86 dBc (-16 to -21 dBm)	-90 dBc (-16 to -21 dBm)	-91 dBc (-16 to -21 dBm)	-91 dBc (-16 to -21 dBm)
	100	-77 dBc (-14 to -19 dBm)	-82 dBc (-13 to -18 dBm)	-84 dBc (-13 to -18 dBm)	-84 dBc (-13 to -18 dBm)
	1000	-68 dBc (-12 to -17 dBm)	-74 dBc (-10 to -15 dBm)	-77 dBc (-9 to -14 dBm)	-77 dBc (-9 to -14 dBm)
7.5 GHz	3	-79 dBc (-23 to -28 dBm)	-83 dBc (-22 to -27 dBm)	-84 dBc (-21 to -26 dBm)	-85 dBc (-21 to -26 dBm)
	10	-76 dBc (-22 to -27 dBm)	-81 dBc (-21 to -26 dBm)	-82 dBc (-20 to -25 dBm)	-83 dBc (-20 to -25 dBm)
	100	-67 dBc (-20 to -25 dBm)	-72 dBc (-18 to -23 dBm)	-75 dBc (-17 to -22 dBm)	-76 dBc (-17 to -22 dBm)
	1000	-55 dBc (-15 to -25 dBm)	-64 dBc (-15 to -20 dBm)	-68 dBc (-14 to -19 dBm)	-69 dBc (-14 to -19 dBm)
12.5 GHz	3	-73 dBc (-21 to -26 dBm)	-78 dBc (-21 to -26 dBm)	-83 dBc (-21 to -26 dBm)	-84 dBc (-21 to -26 dBm)
	10	-71 dBc (-23 to -28 dBm)	-76 dBc (-21 to -26 dBm)	-81 dBc (-20 to -25 dBm)	-82 dBc (-20 to -25 dBm)
	100	-61 dBc (-23 to -28 dBm)	-66 dBc (-20 to -25 dBm)	-73 dBc (-17 to -22 dBm)	-75 dBc (-17 to -22 dBm)
	1000	-51 dBc (-17 to -22 dBm)	-57 dBc (-17 to -22 dBm)	-65 dBc (-14 to -19 dBm)	-68 dBc (-14 to -19 dBm)
26 GHz	3	-68 dBc (-21 to -26 dBm)	-71 dBc (-21 to -26 dBm)	-74 dBc (-19 to -24 dBm)	-74 dBc (-19 to -24 dBm)
	10	-65 dBc (-20 to -25 dBm)	-68 dBc (-20 to -25 dBm)	-71 dBc (-18 to -23 dBm)	-72 dBc (-18 to -23 dBm)
	100	-55 dBc (-18 to -23 dBm)	-59 dBc (-17 to -22 dBm)	-64 dBc (-15 to -20 dBm)	-65 dBc (-15 to -20 dBm)
	1000	-46 dBc (-16 to -21 dBm)	-50 dBc (-14 to -19 dBm)	-56 dBc (-12 to -17 dBm)	-58 dBc (-12 to -17 dBm)

Appendix B: The amplifier I want to test has an IP3 of +38 dBm. Can the PNA-X make this measurement?

A question often asked is can the PNA-X satisfy certain IP3 requirements. To answer that question, we need to know a few factors – the input or output fundamental tone power, the output IP3, gain of the DUT, frequency range, and tone spacing. In this example, we follow through the procedure to determine the feasibility of this measurement.

Input tone power: -10 dBm
 DUT gain: 20 dB
 Specification for DUT output IP3 (OIP3): $+38$ dBm
 Frequency of interest: 4 GHz
 Tone spacing: 10 MHz
 IFBW: 10 Hz

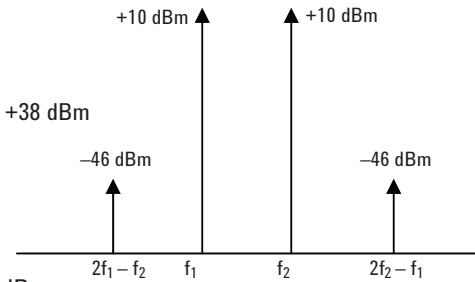

Based on the above:
 Output tone power: $-10 + 20 = +10$ dBm

If the output tone power is $+10$ dBm, and the OIP3 spec is $+38$ dBm, then the dBc level of the intermod signal will be at -46 dBm, or -56 dBc relative to the fundamental tone.

10 dBc between DUT intermod and EVM \rightarrow 2.4 dB error
 20 dBc between DUT intermod and EVM \rightarrow 0.8 dB error
 30 dBc between DUT intermod and EVM \rightarrow 0.3 dB error
 40 dBc between DUT intermod and EVM \rightarrow 0.1 dB error

From a dynamic range perspective, the measurement accuracy will depend on how this value (-56 dBc) compares to the error vector magnitude (EVM) value. For 99.7% confidence of intermod signal accuracy < 0.3 dB, the receiver EVM needs to be 30 dB below the DUT intermod, or -86 dBc.

Next, we see what the receiver can do at this frequency and tone spacing. From the table in appendix A of this application note, we see that the EVM for tone separations > 1 MHz for 10 Hz IFBW is -91 dBc for 1.7 GHz, and -83 dBc for 7.5 GHz (no data available for 4 GHz in the table). Ideally we would want a -86 dBc EVM for 0.3 dB of error. But our EVM may be closer to -83 dBc, if the performance of 4 GHz is close to 7.5 GHz. But if it is more like 1.7 GHz, we will have much better accuracy. Even with -83 dBc EVM, we will have 0.4 dB of error, so if 0.4 dB of error is acceptable, this measurement is possible with the PNA-X.

In both cases, the power range for optimum EVM includes -20 dBm, which is the tone power into the receiver port with no attenuation. In this case, the tone power is $+10$ dBm, so we should set the receiver attenuator to 30 dB, so there is -20 dBm incident upon the receivers.

A few more considerations for an accurate measurement:

In order to ensure an accurate measurement, we need to determine the tone spacing to avoid spurs. We have a nominal center frequency of 4 GHz, and a tone separation of 10 MHz. Using the center frequency protocol, we choose the center frequency of the two tones to be offset from an even multiple of 10 MHz by more than 10 times the IF bandwidth to be used. In this case, the offset from the nominal 4 GHz center frequency is greater than $10 \text{ Hz} * 10$, or 100 Hz. So we can use a center frequency of 4.000000100, and retain the tone separation of ± 10 MHz.

Also, we need to consider the source attenuator on port 2. We want to guarantee that the intermod generation of the test set transfer switch is less than -90 dBm, so that it will have no appreciable effect on the error. With the input power at $+10$ dBm, this requires an IMD of 60 dBm $(10 + (10 - (-90))/2)$. The non-attenuated IP3 of the test port is >30 dBm. Since each 1 dB of source attenuation adds 2 dB to the reflection IP3, we should set the source attenuator on port 2 to 15 dB.

Appendix C: Quick checklist for two-tone CW IMD measurements using a PNA-X with dual internal sources

1. Set the trace to measure the B receiver (Trace, meas menu).
2. Set up the path configurator for two-tone measurements (power/attenuator dialog box).
3. Turn on Source and Source2 (power/attenuator dialog box), and set the appropriate power levels.
4. Set up frequency offset mode for two fundamental tones (Source and Source2), and the receiver to measure all four tones (two fundamental, two intermod products).
5. Avoid using round numbers or multiple of 10 MHz. Instead of 2 GHz, use 2.00011 GHz.
6. Make sure you select a combination of points and frequency span such that all the four desired tones (f_1 , f_2 , $2f_1 - f_2$, $2f_2 - f_1$) are measured exactly. You can verify that you in fact are measuring those points by using discrete markers. Easy way to do this:
 - **Primary:** covers the range of $2f_1 - f_2$ to $2f_2 - f_1$. **Use 11 points.** Set center frequency to the average of f_1 and f_2 . **Set the span to 5*tone spacing**
 - **Source:** uncoupled: f_1 , center frequency, span zero
 - **Source2:** uncoupled: f_2 , center frequency, span zero
 - **Receivers:** coupled (same as primary)
7. Set the IFBW to 10 Hz, 100 Hz, or 1 kHz.
8. Set the narrowband crystal filter from the System > Configure > SICL/GPIB > SCPI menu (DOS looking menu): **sens:path:conf:elem "ifsigpathall","nbf"**
9. Apply receiver attenuation. Check the measurement for any changes. If the values change with receiver attenuation, you are probably compressing the receivers or causing distortion, so apply the attenuation.
10. Put four discrete markers on the trace, one for each frequency (f_1 , f_2 , $2f_1 - f_2$, $2f_2 - f_1$).
11. Calculate the IP3 (manually) $IP3 \text{ (dBm)} = P(f_1) + (P(f_2) - P(2f_1 - f_2)) / 2$

To get higher accuracy, you will need to perform various calibrations.



Agilent Email Updates

www.agilent.com/find/emailupdates
Get the latest information on the products and applications you select.



Agilent Direct

www.agilent.com/find/agilentdirect
Quickly choose and use your test equipment solutions with confidence.



www.agilent.com/find/open
Agilent Open simplifies the process of connecting and programming test systems to help engineers design, validate and manufacture electronic products. Agilent offers open connectivity for a broad range of system-ready instruments, open industry software, PC-standard I/O and global support, which are combined to more easily integrate test system development.



www.lxistandard.org
LXI is the LAN-based successor to GPIB, providing faster, more efficient connectivity. Agilent is a founding member of the LXI consortium.

Remove all doubt

Our repair and calibration services will get your equipment back to you, performing like new, when promised. You will get full value out of your Agilent equipment throughout its lifetime. Your equipment will be serviced by Agilent-trained technicians using the latest factory calibration procedures, automated repair diagnostics and genuine parts. You will always have the utmost confidence in your measurements.

Agilent offers a wide range of additional expert test and measurement services for your equipment, including initial start-up assistance onsite education and training, as well as design, system integration, and project management.

For more information on repair and calibration services, go to:

www.agilent.com/find/removealldoubt

www.agilent.com

For more information on Agilent Technologies' products, applications or services, please contact your local Agilent office. The complete list is available at:

www.agilent.com/find/contactus

Americas

Canada	(877) 894-4414
Latin America	305 269 7500
United States	(800) 829-4444

Asia Pacific

Australia	1 800 629 485
China	800 810 0189
Hong Kong	800 938 693
India	1 800 112 929
Japan	81 426 56 7832
Korea	080 769 0800
Malaysia	1 800 888 848
Singapore	1 800 375 8100
Taiwan	0800 047 866
Thailand	1 800 226 008

Europe

Austria	0820 87 44 11
Belgium	32 (0) 2 404 93 40
Denmark	45 70 13 15 15
Finland	358 (0) 10 855 2100
France	0825 010 700
Germany	01805 24 6333*
	*0.14€/minute
Ireland	1890 924 204
Italy	39 02 92 60 8484
Netherlands	31 (0) 20 547 2111
Spain	34 (91) 631 3300
Sweden	0200-88 22 55
Switzerland (French)	41 (21) 8113811(Opt 2)
Switzerland (German)	0800 80 53 53 (Opt 1)
United Kingdom	44 (0) 118 9276201

Other European Countries:

www.agilent.com/find/contactus

Revised: May 7, 2007

Product specifications and descriptions in this document subject to change without notice.

© Agilent Technologies, Inc. 2007
Printed in USA, September 12, 2007
5989-7265EN



Agilent Technologies