

Safety Instructions



0,1,2,3,4,7,8,10,11,12,
15,16,17,19,20,21,22,
23,25,26,27,28



Info Hotline

+49 (0) 5041 998 389

Mon.-Do. 7⁰⁰-20⁰⁰

Fr. 7⁰⁰-17⁰⁰

Paulmann Licht GmbH
31832 Springe / Germany
www.paulmann.com

Art.-Nr.:

994.59

994.60





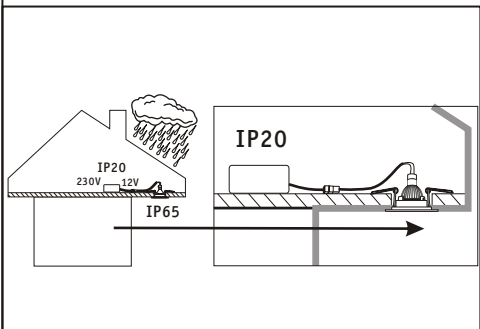
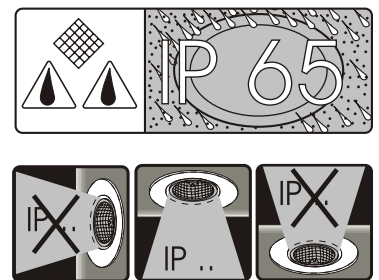
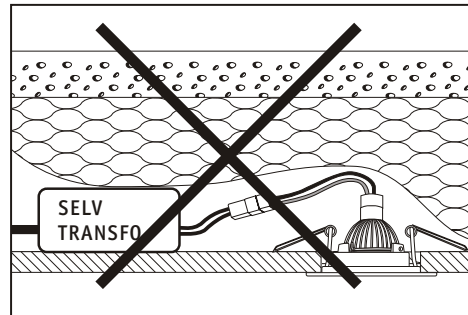
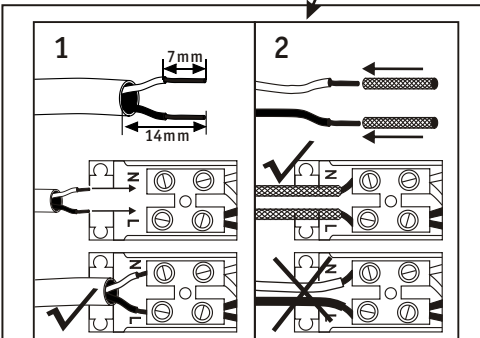
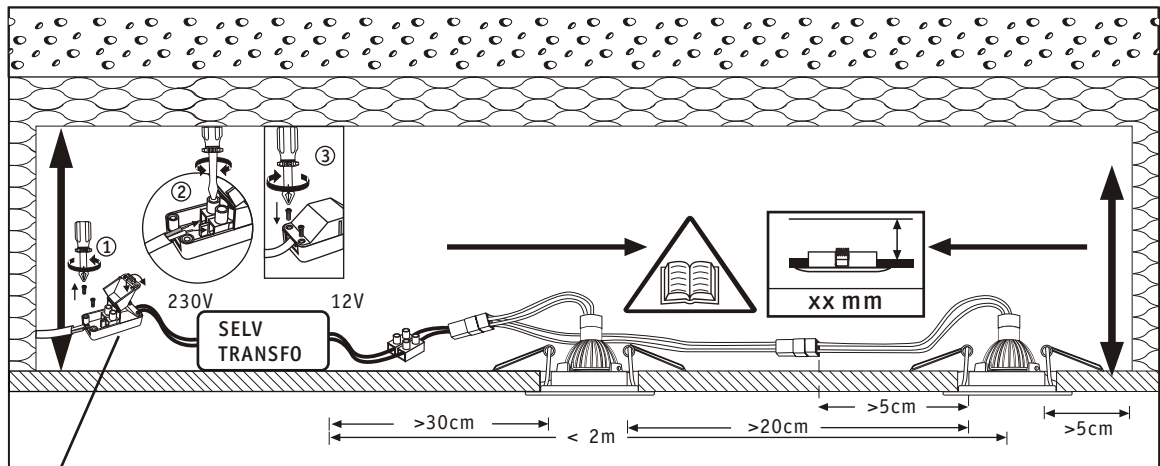
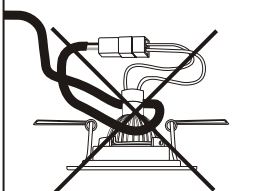
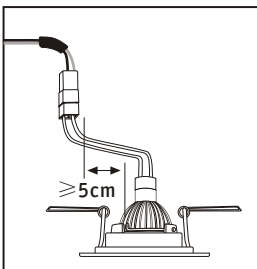
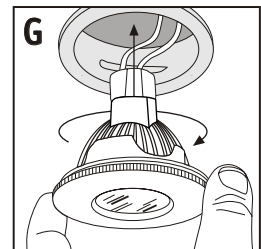
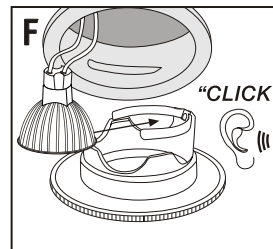
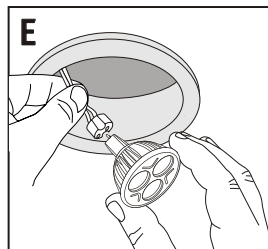
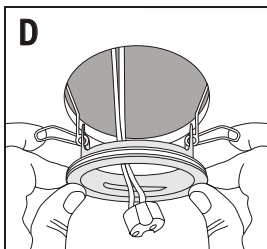
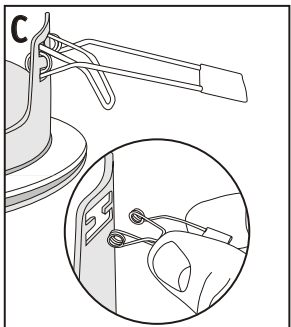
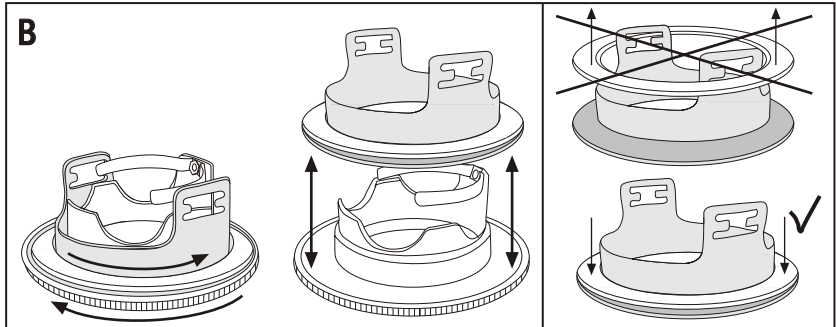
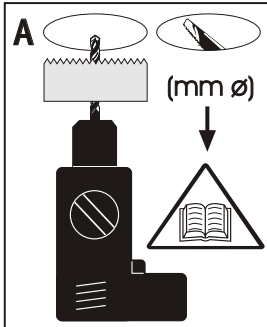
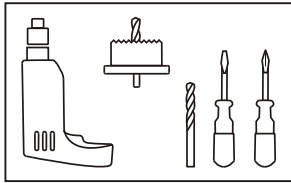

994.61

995.33

(+MA 173)

PBO 10 / 09



						
	Coolbeam	[mm]	[mm]	[mm]	[cm]	[mm]
		51	0.5	75	80	≥20
						5-20