

**NEW !**

# Infrared MEMS Thermal Sensor

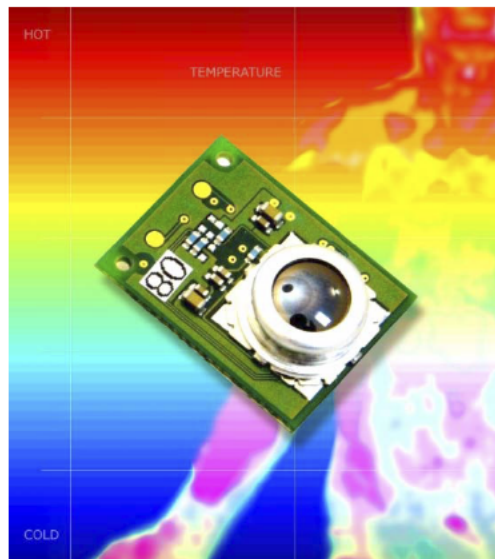



# D6T Product Series: Infrared MEMS Thermal Sensor

## D6T positioning on thermal market:

- thermal sensor market is highly competitive and temperature is one of most measured parameters across many industries (if not all of them)
- non contact thermal measurement has benefits as response speed, no inter-reaction on measured object or long lasting measurement. Generally only the surface temperature can be measured.
- IR detecting systems include pyroelectric and thermopile technologies





# D6T Product Series: Infrared MEMS Thermal Sensor



## Product positioning in Omron MEMS:

### Parameter

- FLOW: -----
- PRESSURE: -----
- RF -----
- **THERMAL** -----

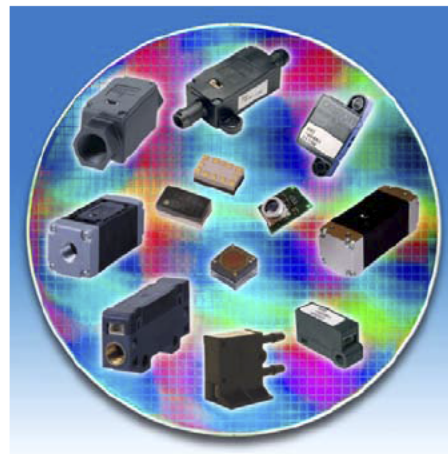

### Product series

- D6F
- 2SMPP, D8M
- 2SMES
- **D6T**

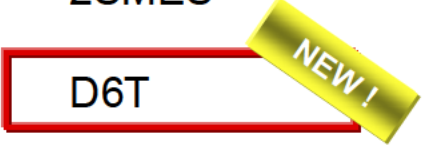

# Market development expectations

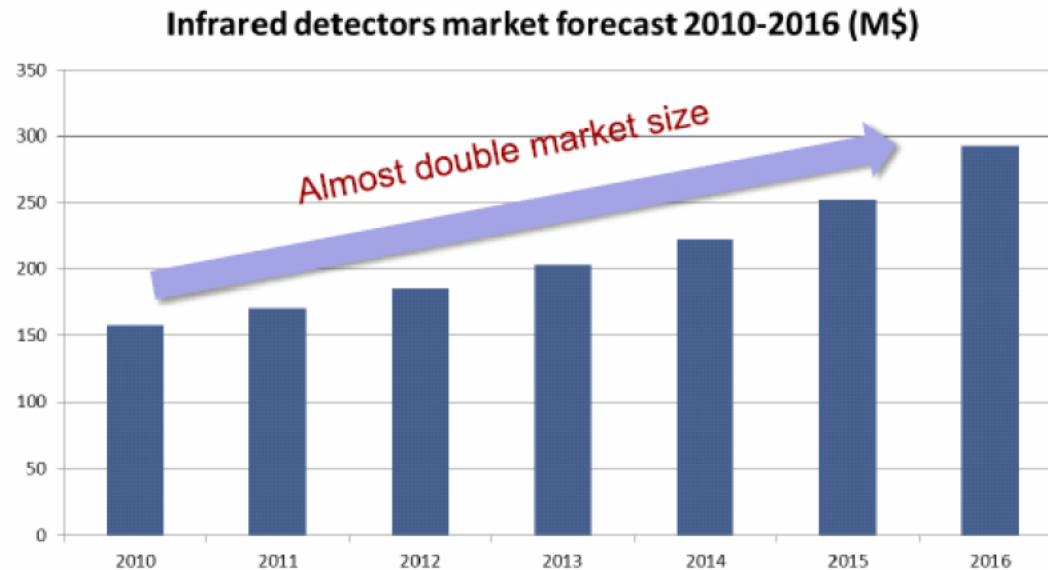

Source: Yole Developpement

- It is predicted significant growth in IR Thermal sensor market : **CAGR 2010-2016 : +11%**
- Main areas to contribute to growth are: People motion detection in Building Automation and Home Appliances, low end temperature sensors and people counting or advanced people detection
- Research & development efforts already started, D6T is product in interest

# D6T : Product Features

## Function

To measure the surface temperature of the material by detecting intensity of the infrared radiation.  
Best fit for human detection and non-contact temperature measurement.

## Technology

Incorporate state-of-the-art MEMS thermopile, custom designed sensor ASIC and signal processing micro processor and algorithm into tiny package.



- Unique MEMS, ASIC, and other application-specific parts to ensure high sensitivity
- Low visual field crosstalk characteristics enable high-precision area temperature detection
- Digital output with superior noise immunity
- High Signal to noise ratio (SNR) expressed as Noise-Equivalent Temperature Difference at 0.14 degrees Celsius
- Compact size with dimensions of 18x14x6.3mm

# D6T Product Structure

Thermopile array

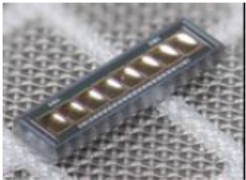

1 x 8 element

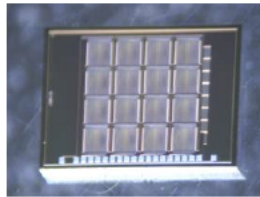

4x4 element

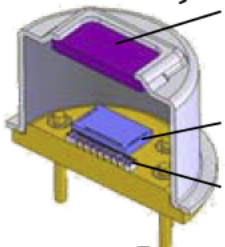

Silicon Lens

ASIC

MEMS

Thermopile

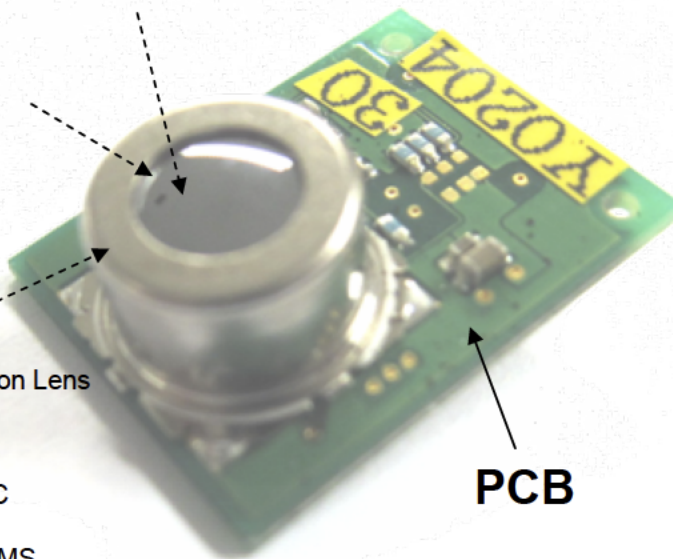

PCB

Microcontroller

Connector

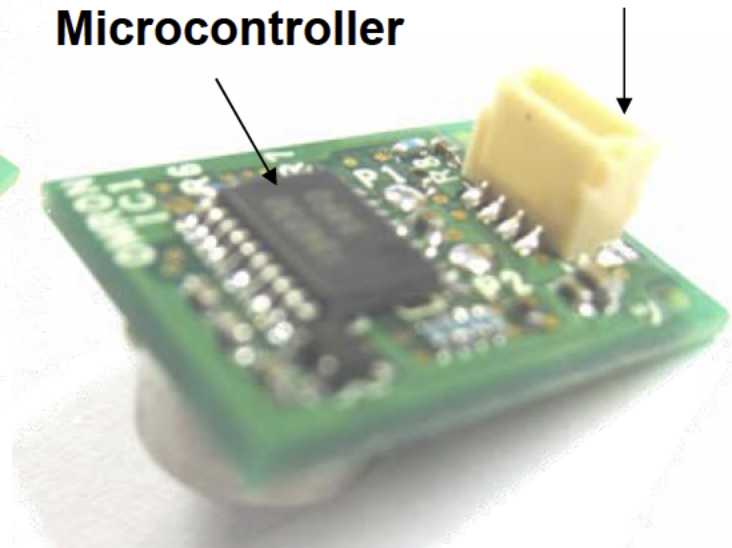

# D6T Operation principle

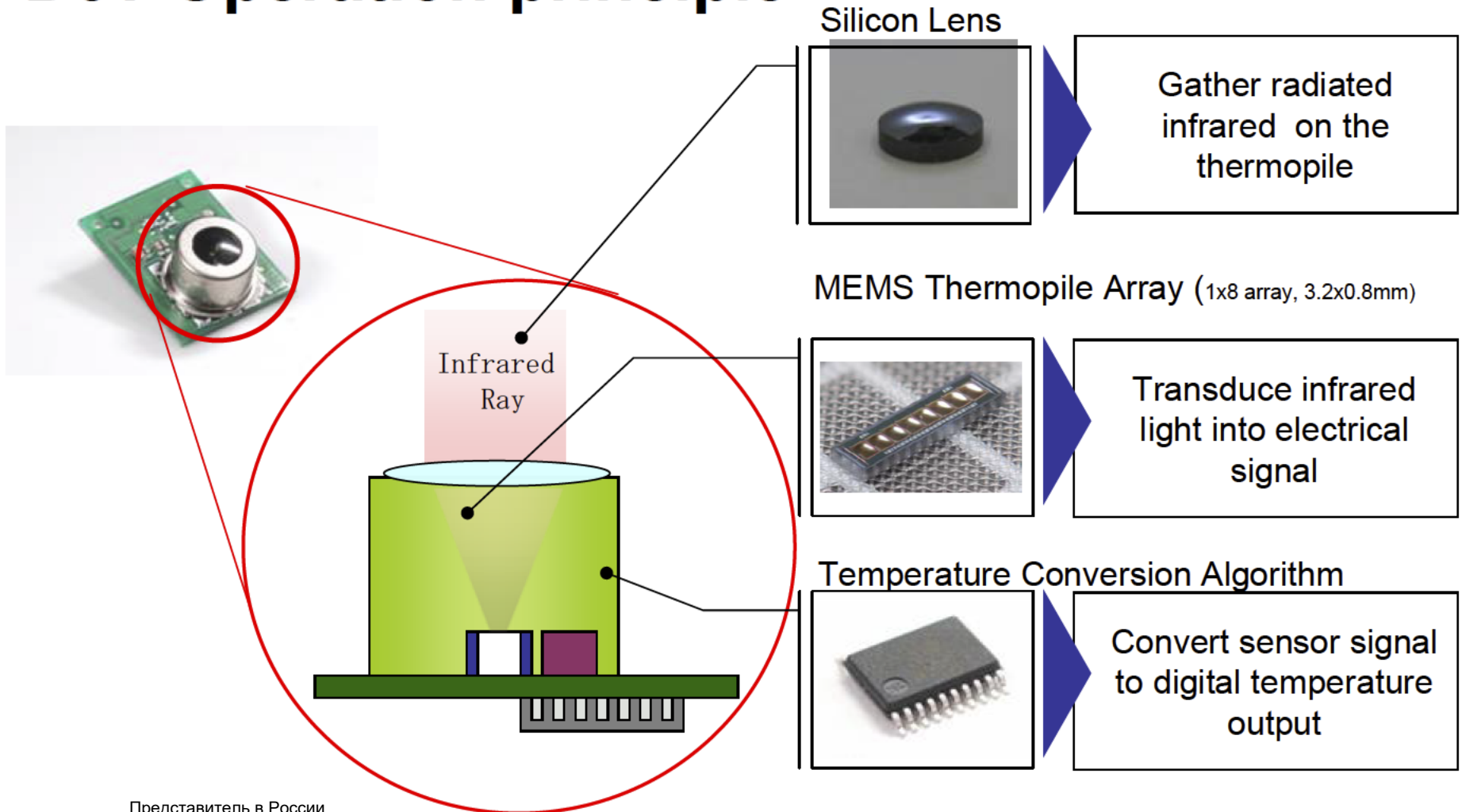

Chip	1x8 array	4x4 array	16x16 array
Product	D6T-8L-06	D6T-44L-06	TBD
Status	<ul style="list-style-type: none"> <li>• Sample Available</li> <li>• Mass production</li> </ul>	<ul style="list-style-type: none"> <li>• Sample Available</li> <li>• Mass production</li> </ul>	<ul style="list-style-type: none"> <li>• Under development</li> </ul>
Field of view	<p>X:62.8° Y : 6.0°</p> <p>(Direction X)</p>	<p>X:44.2° Y : 45.7°</p> <p>(Direction Y)</p>	<p>—</p>
Photo			



# D6T Product Specifications

Item	Specification
Storage temperature range [°C]	-10 to 60° C (with no ice or no dew condensation)
Operating temperature range [°C]	0 to 50° C (with no ice or no dew condensation) * Guaranteed accuracy, see the figure on the next page.
Storage humidity range [%RH]	85%RH or less (with no dew condensation)
Operating humidity range [%RH]	20 to 85%RH (with no dew condensation)
Supply voltage [V]	4.5 to 5.5
Maximum output voltage [V]	0.8V <sub>cc</sub> to V <sub>cc</sub>
Minimum output voltage [V]	0 to 0.2V <sub>cc</sub>
Current consumption [mA]	Typ.5
Output	Temperature values
Object temperature accuracy [°C]	±1.5
Digital interface	I2C (Synchronous serial communication)
Data update rate	Max.250ms

# Temperature detecting range of the object

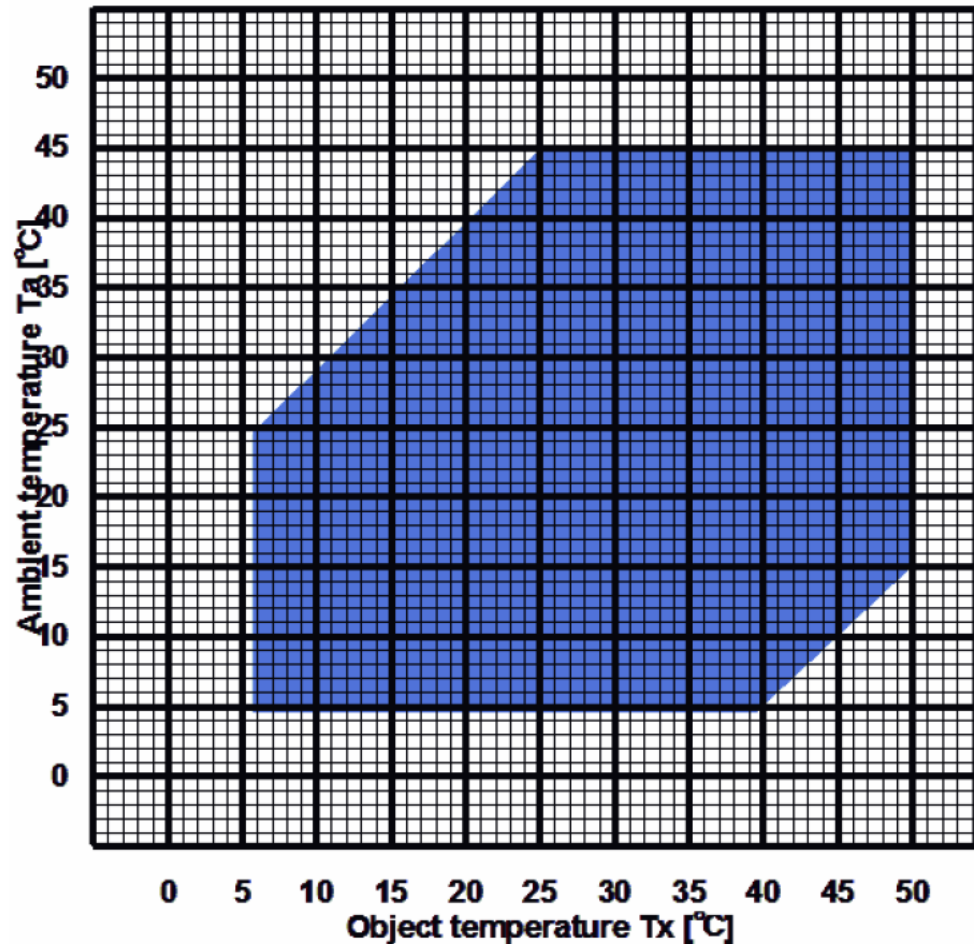

## Dimensions of D6T

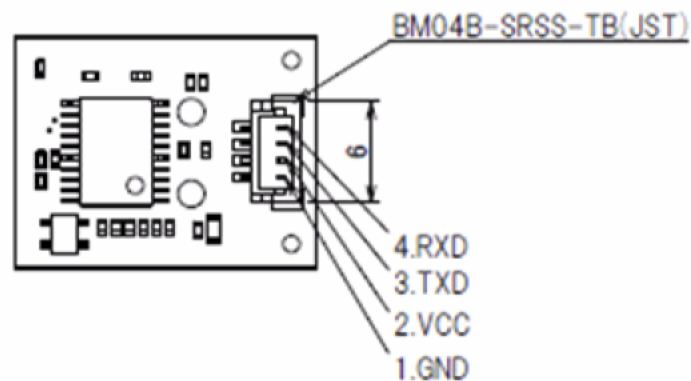
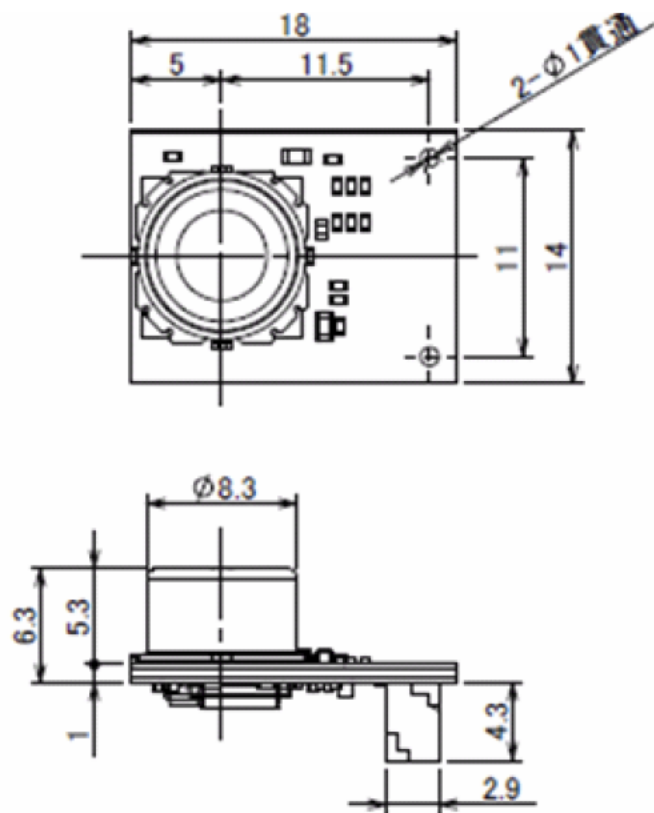

### Other:

Weight: approx. 3.5g

ROHS / REACH compliant

Package: plastic tray 50pcs, box 4 trays

# Field of view (1x8 type)

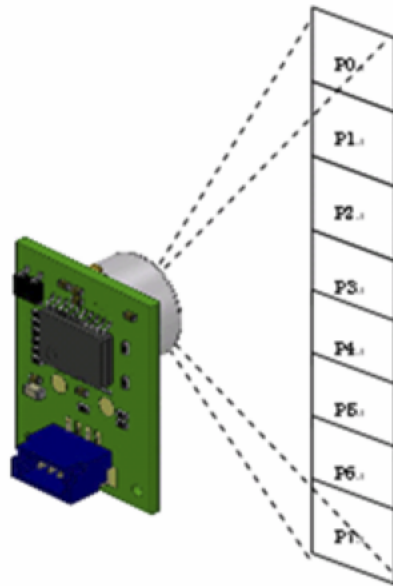

Detection area of each pixel

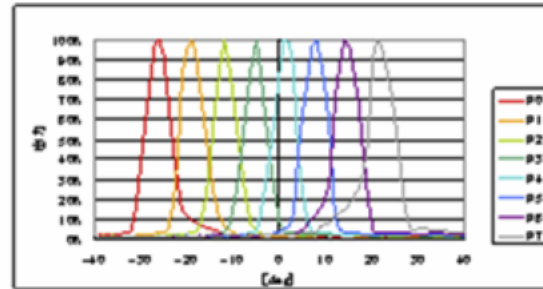
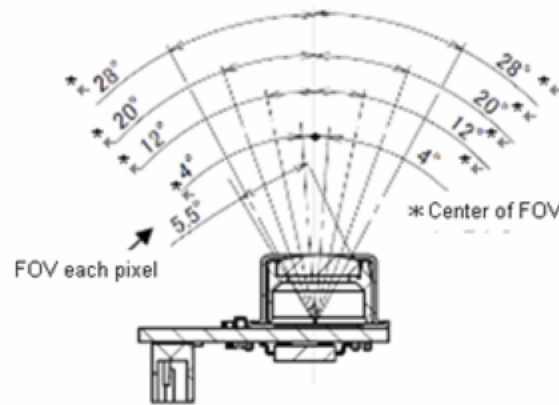
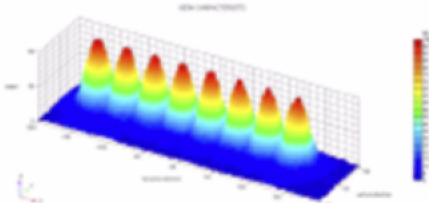

FOV (Direction X)

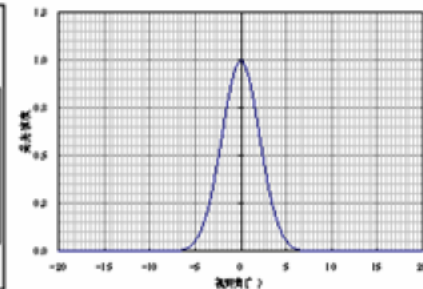

FOV (Direction Y)

# Field of view (1x8 type) - example

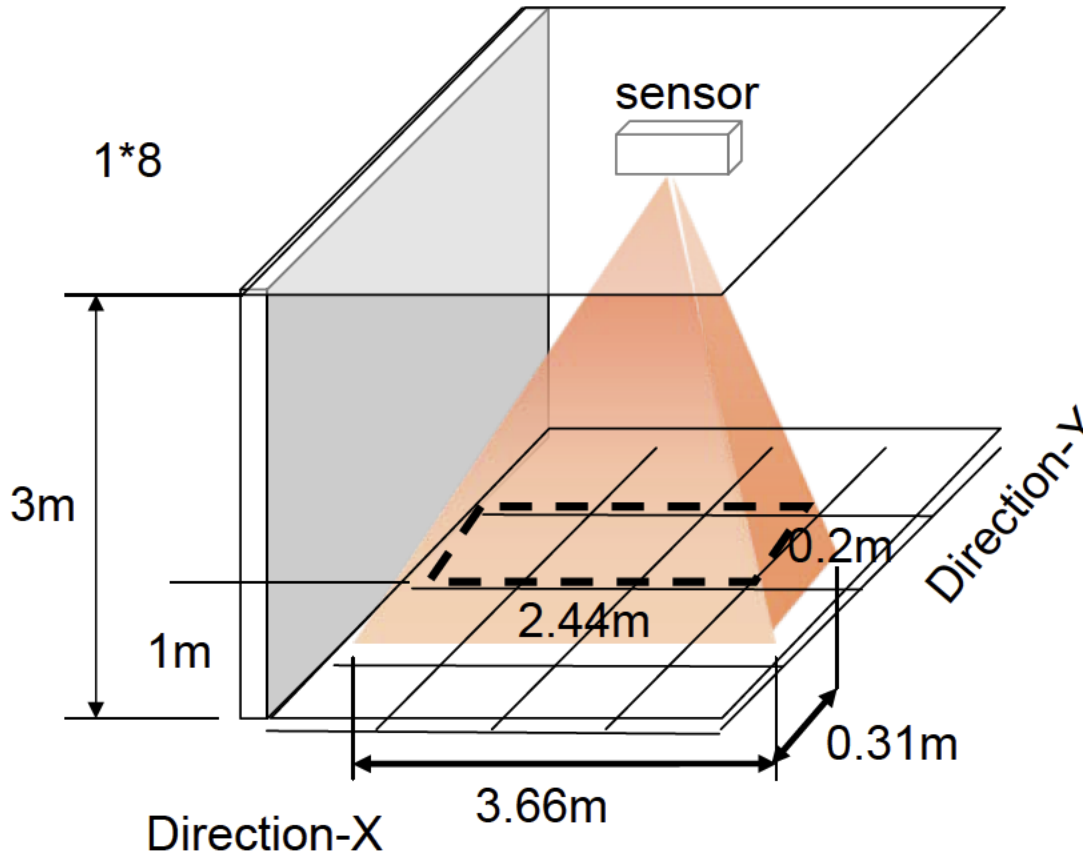

# Field of view (4x4Type)

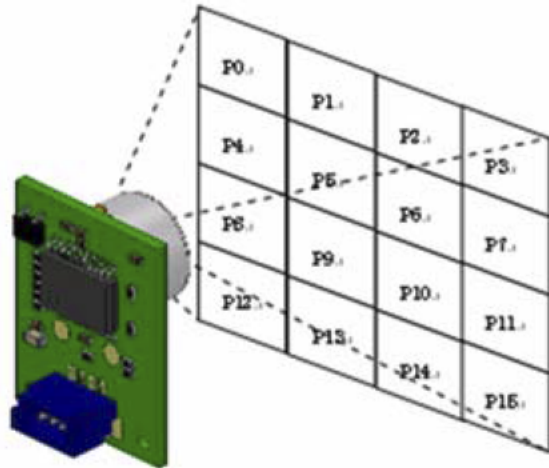

Detection area of each pixel

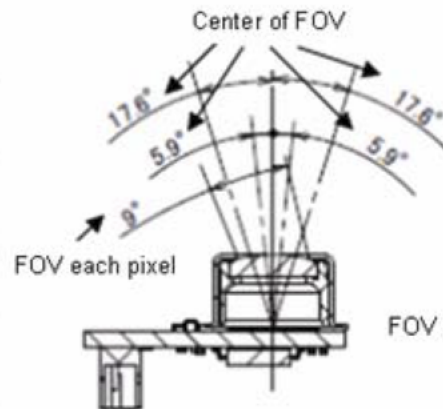

FOV each pixel

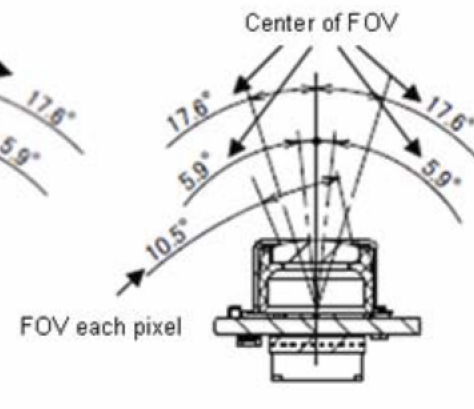

FOV each pixel

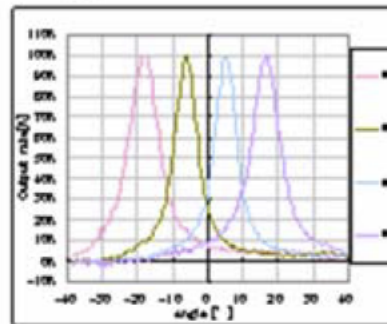

Ex.P1/P5/P9/P15  
FOV (Direction X)

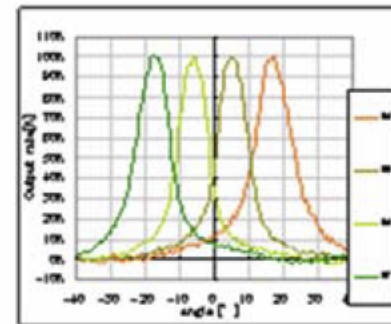

Ex.P4/P5/P6/P7  
FOV (Direction Y)

# Field of view (4x4Type)- example

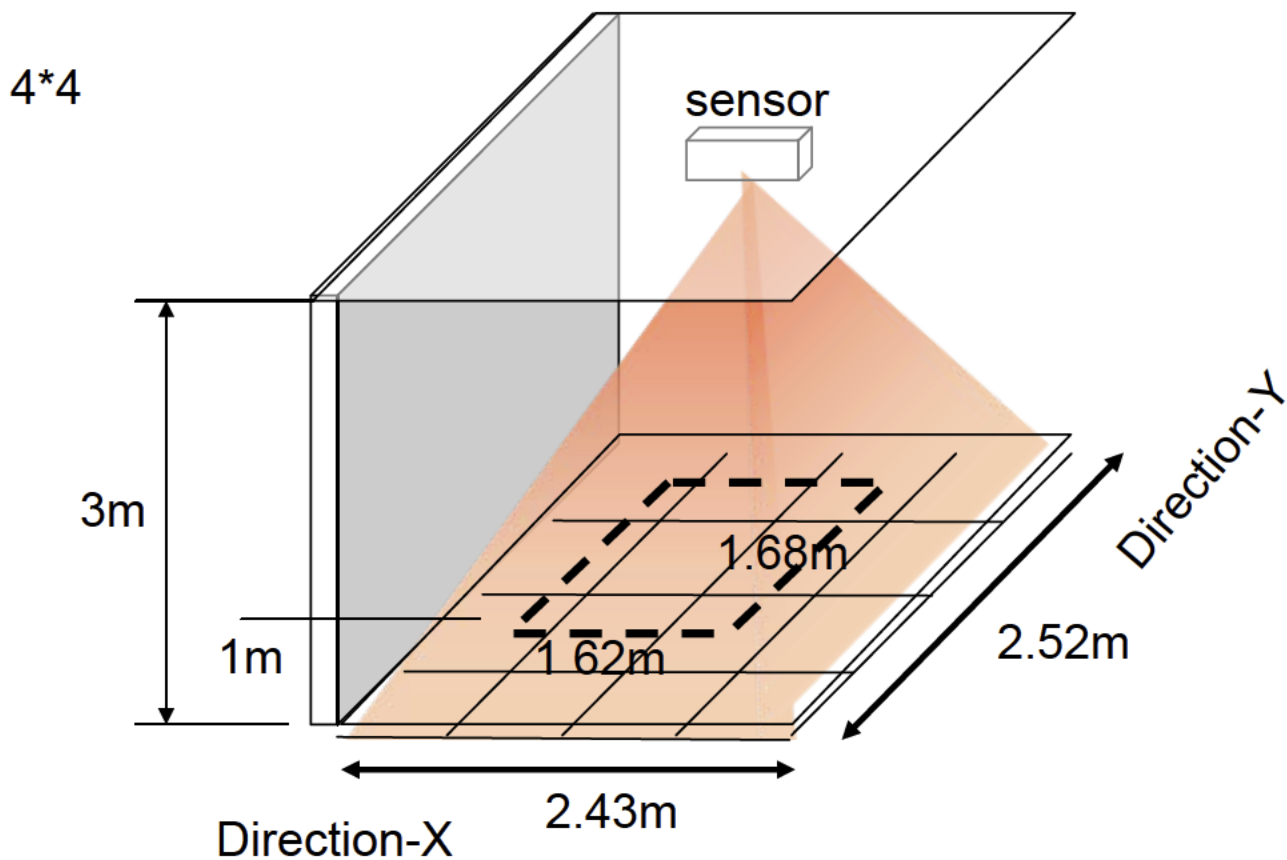

# Benefit of Omron MEMS IR Sensor I.

## Human detection - Energy management, people safety/security

Sensor structure is very suitable for human detection, even for objects in **stationary position**. PIR structure finds limits in static detection. Therefore easy to capable monitor area for people (energy saving, people safety, security)

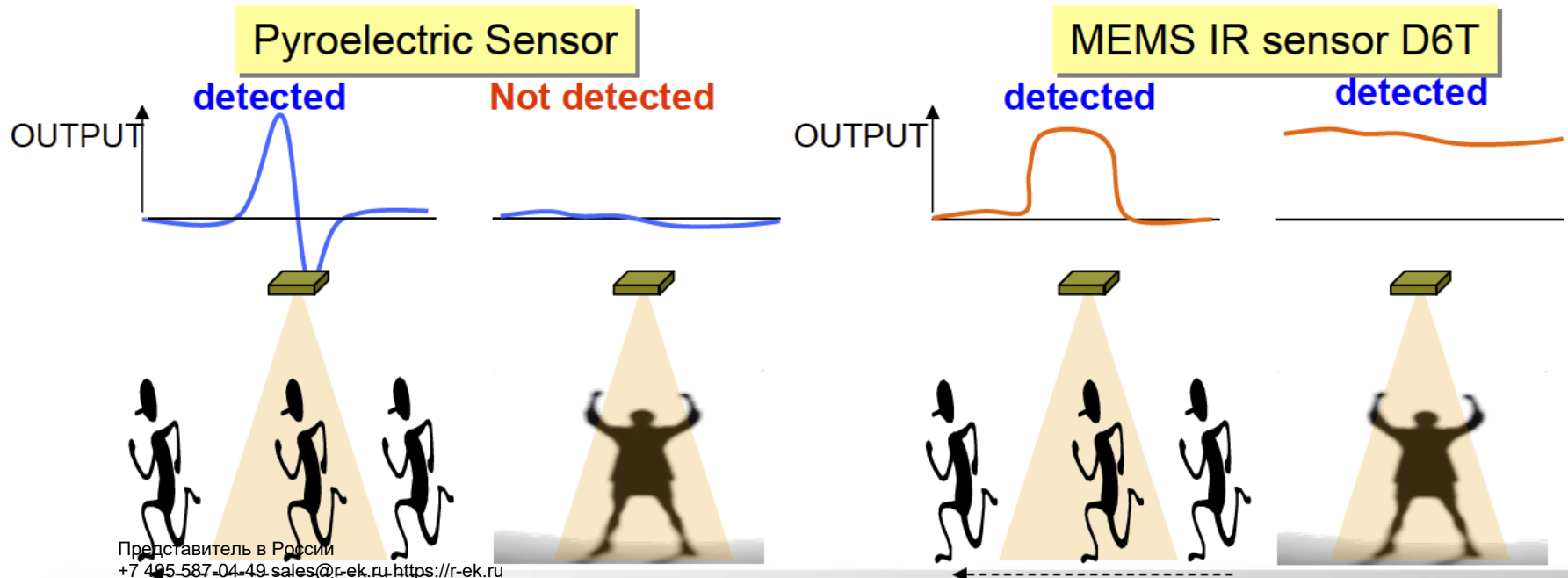



# Benefit of Omron MEMS IR Sensor I.

	Competitor (Pyro electric)	OMRON (Thermopile)
Temperature measure	×	○
Moving human	○	○
Static human	×	○
Output I/F	Analog , On/Off	Digital value
Field of View (Total)	Wide (Lens)	63 deg 45 deg
Sensor Array	1	1x8 4x4

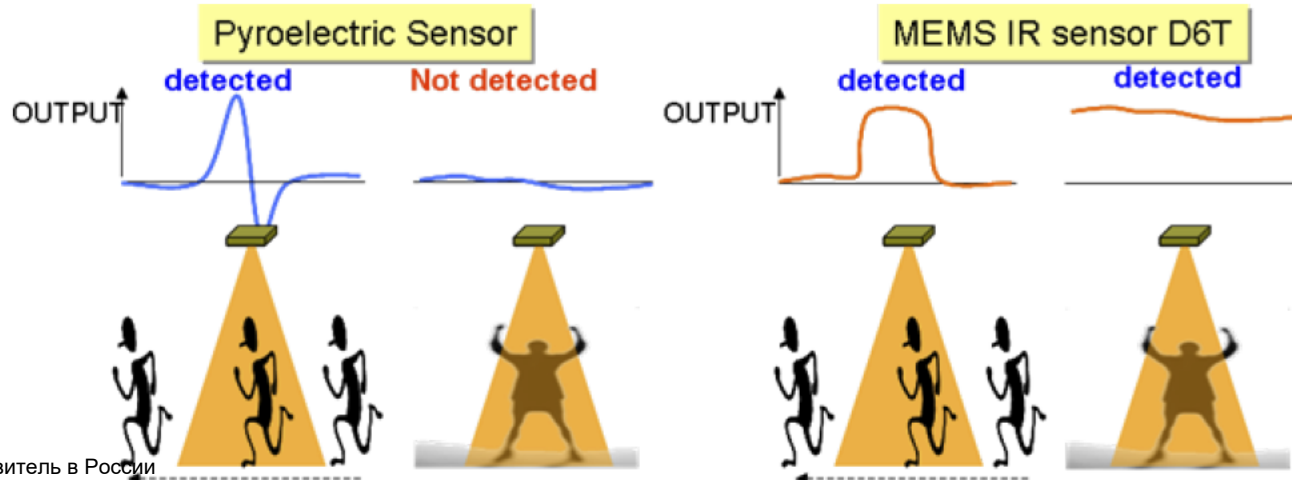

# Benefit of Omron MEMS IR Sensor II.

## Temperature output – information for system adjustments or emergency actions

Sensor is capable to provide temperature information ie. to monitor the temperature level in of room resp. sensed area. It can easily *maintain optimal room temperature levels, instantly detect unusual changes in temperature (detecting factory line stoppages, or discover areas of overheating for early prevention of machine damage or even fire outbreaks, etc.)*

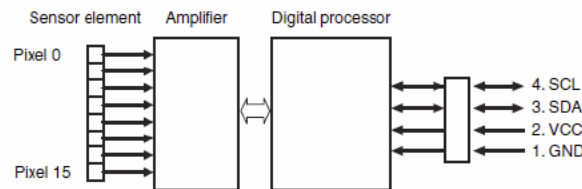
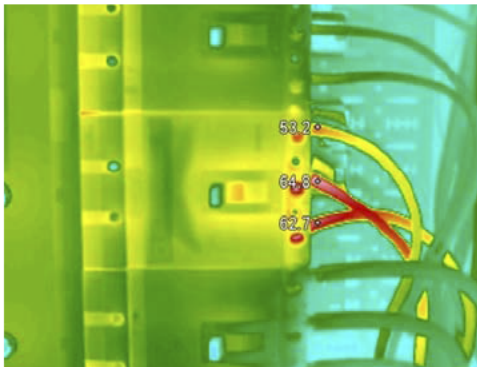

23.4	23.4	23.4	23.4
23.4	25.1	26.8	24.9
23.4	25.8	31.1	27.8
23.4	23.8	24.1	23.7

# Benefit of Omron MEMS IR Sensor III.

## Full Sensing area coverage – entire overview with positioning function

Sensor can measure the temperature of an entire area contactlessly.

Signals generated by sensor output allows assign temperature information to particular cell (1x8=8 resp. 4x4=16 pixels) and to determine position of sensed object. Thus sensor can monitor the changes and trigger to make corrections with high efficiency in case of need.

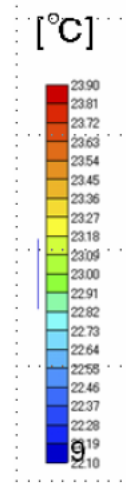
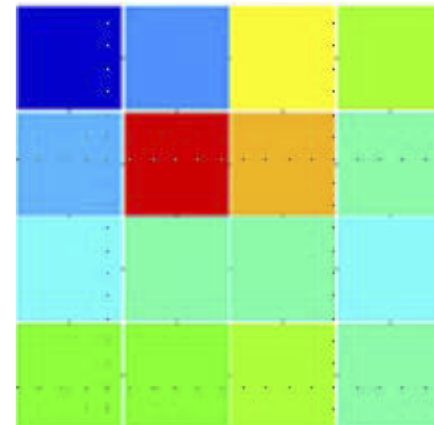

# Application note (D6T 44L-06)

## High sensitivity and Low Noise

- 4x4 array sensor outputs in total 16 temperature values for each element.
- higher temperature is observed where human is present

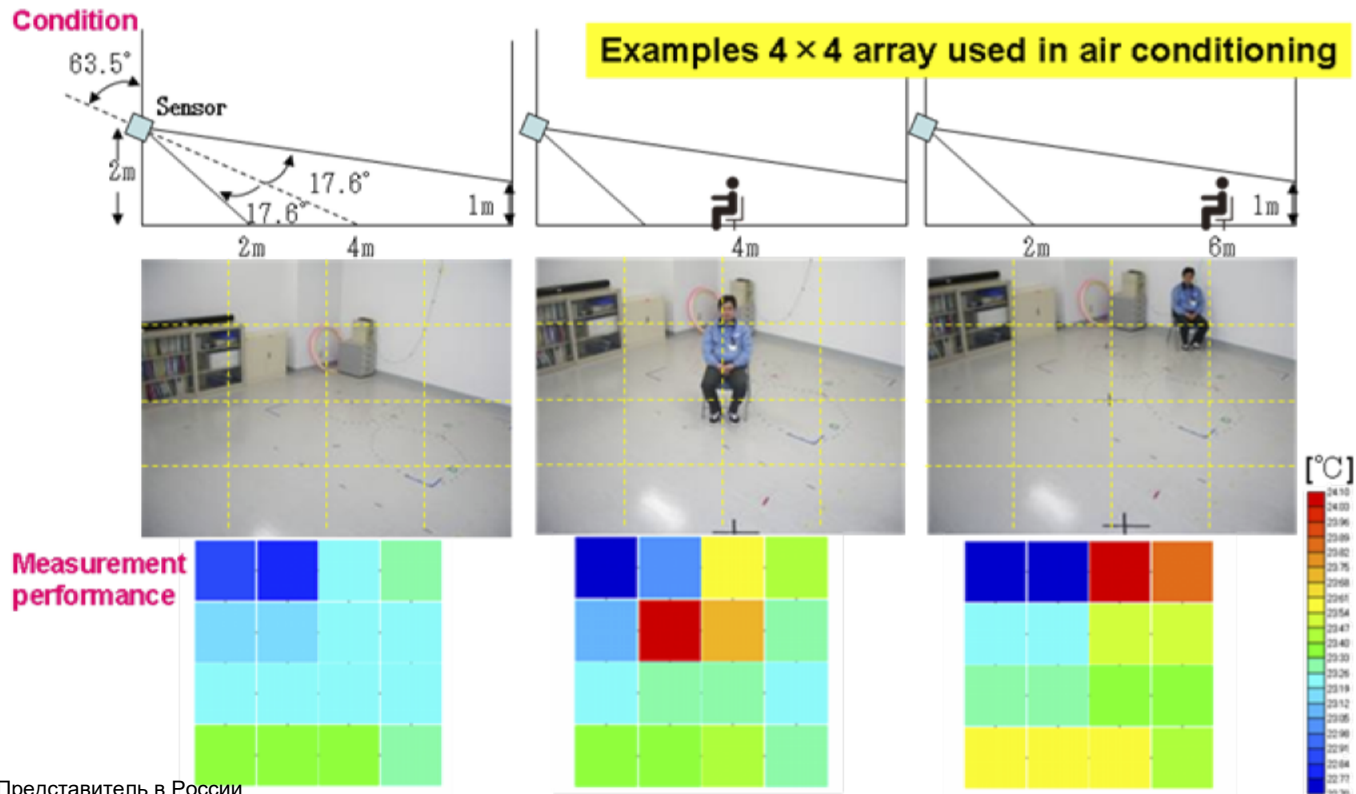

# Application note (D6T 44L-06)

## Human Thermal Image from D6T

Thermal image may be used for more accurate human detection.

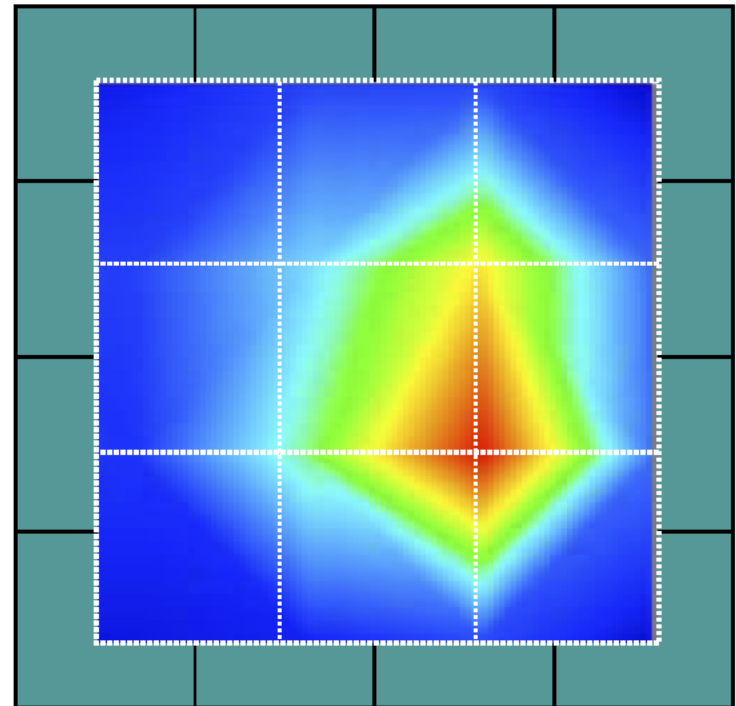
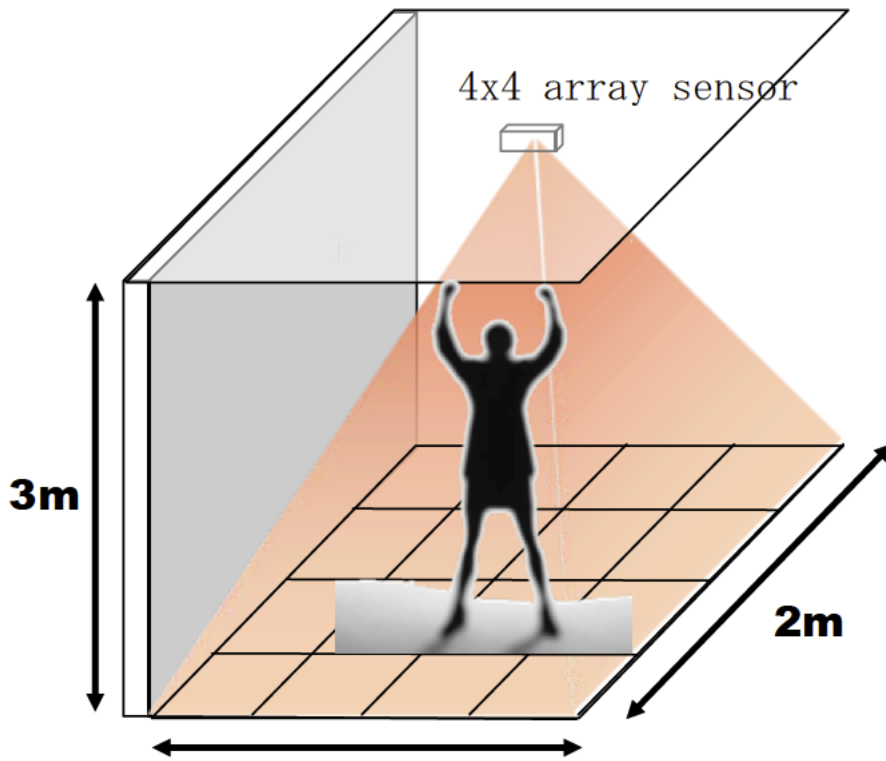

# Application note (D6T 44L-06)

- sensing area: 5m x 5m divided on 8 x 8 elements
- used 4 sensors with 4 x 4 elements IR sensor.

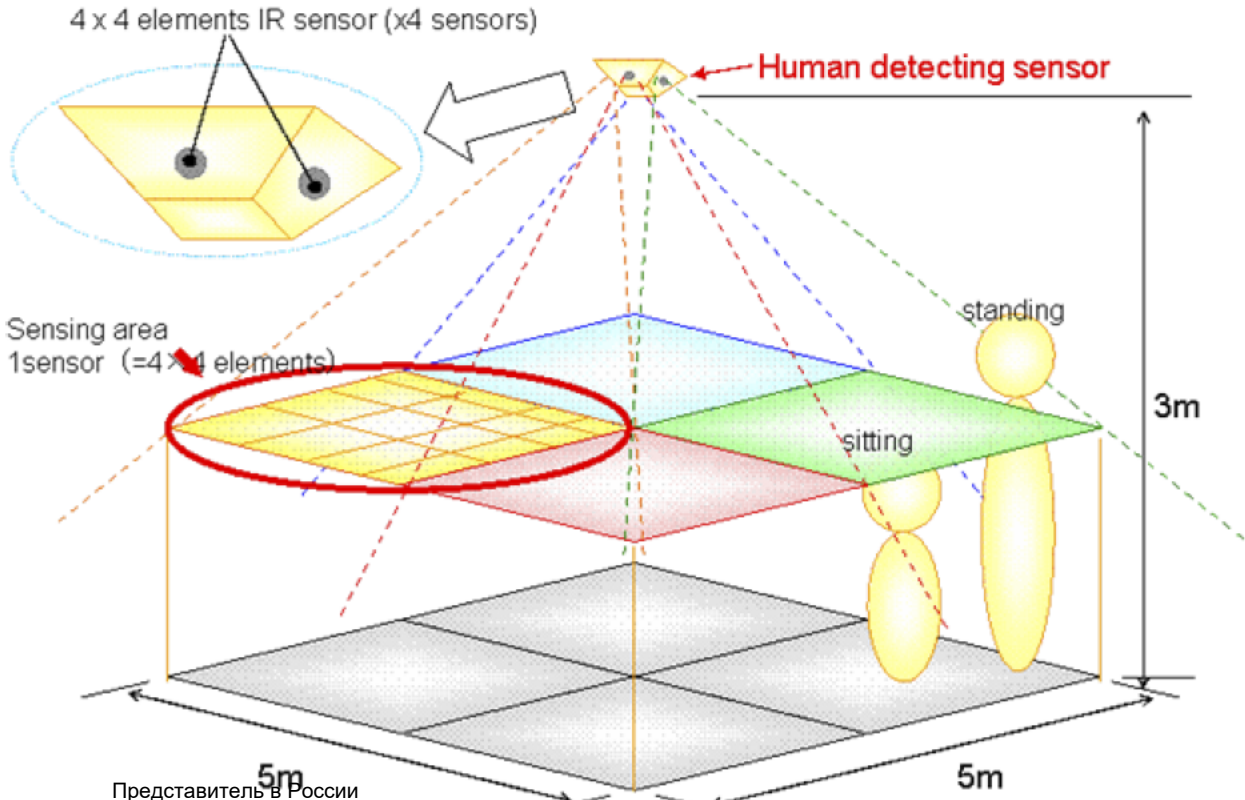

Infrared radiation

4 x 4 IR sensor x 4 pcs

Temperature data

20	20	21	21	20	21	22	19
19	20	21	25	22	21	20	22
20	21	25	23	23	25	24	22
20	21	20	22	22	23	22	21
21	20	19	19	22	21	20	19
20	23	24	21	22	21	20	21
21	23	25	20	20	21	28	20
22	21	19	20	21	23	21	27

algorithm

	No-person		No-person		
	No-person		Human detect		

communication

Lighting / Air Conditioning control

# Application note (D6T 44L-06)

- Build a quad 4x4 array sensor module on ceiling to get higher resolution and/or wider space coverage (left photo)
- Output example (right photo).

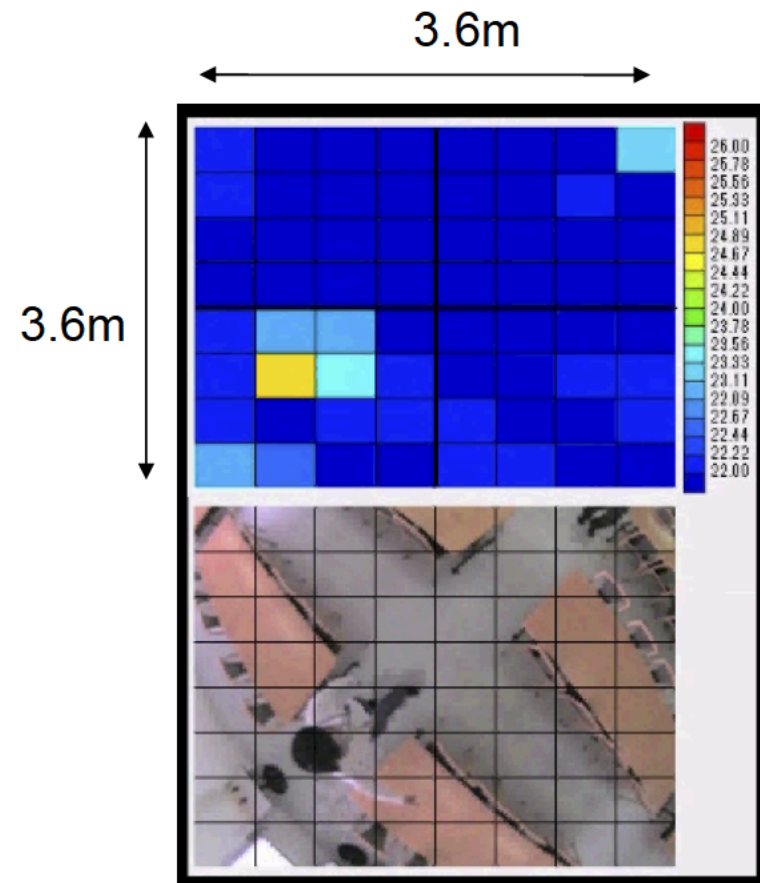

# Application note (D6T 8L-06)

## Floor heating: High sensitivity and Low Noise

Accurate Floor temperature measures regardless Human presence.

Condition

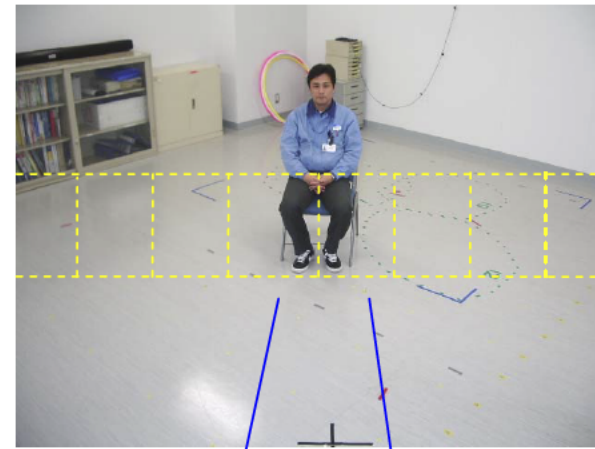
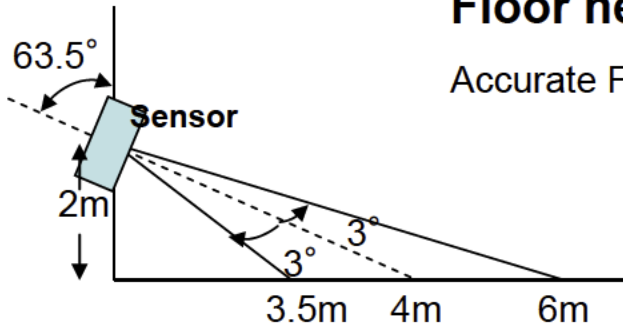

Measurement performance

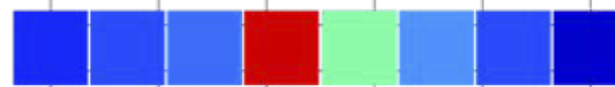

[°C]





# Application areas

**Comfortable**



**Safety/Security**

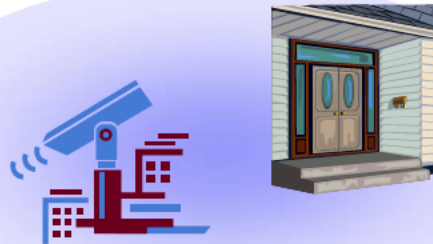

Sensing Temperature

**Ecology**



Movement in dark areas

**Saving Energy**

# D6T Application fields



Energy management in Home appliances

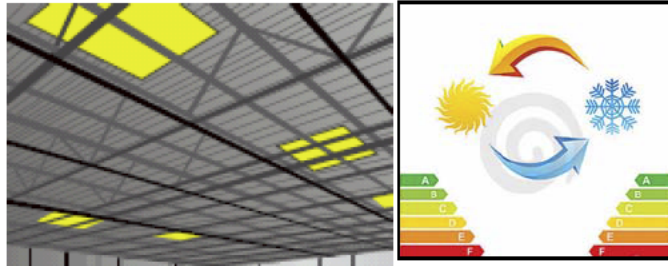

Light / AC control



BEMS/OEMS/HEMS

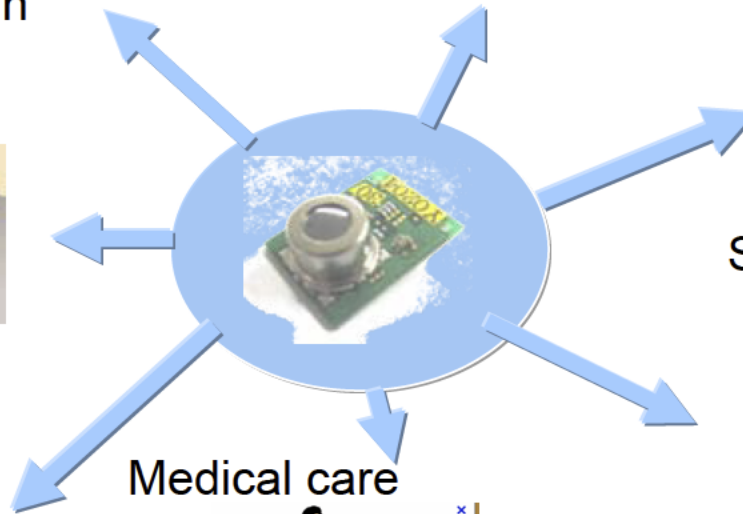

Security systems



Safety function

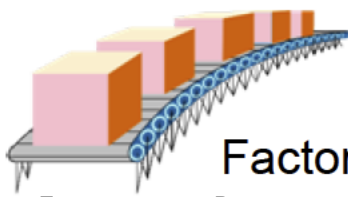

Factory automation



Medical care

Представитель в России  
+7 495 587-04-49 sales@r-ek.ru https://r-ek.ru

...People counting, Digital signage, ...

# D6T: Promotion tools for distribution

- **Samples available against project data**
- **Demonstration kit available on request**
- **Technical documentation available**
  - **datasheet, application note, algorithm document**
- **Marcom Materials available:**
  - **leaflet, advertisement, photos, etc**
- **Thermal MEMS Sensor video:**  
<http://www.youtube.com/watch?v=4UT1GBTdmzQ>



# D6T Application Note

- Application Note: description how to use D6T
- Contents:
  - Electrical connection
  - SW data examples
  - FOV definitions
  - Distance and temperature factors
  - Human detection
- Recommended to send AN with datasheet
- Software algorithm document to be provided soon

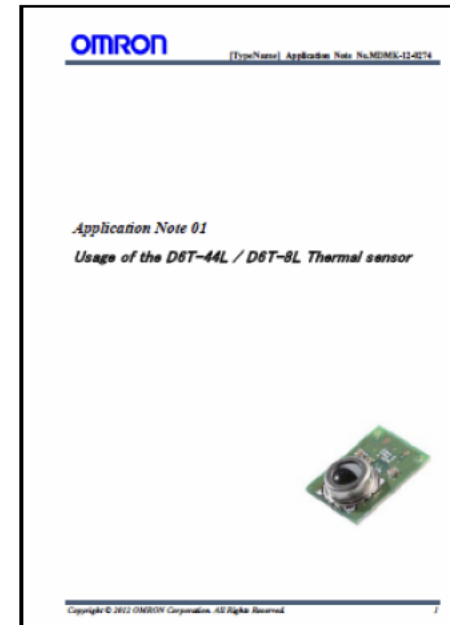
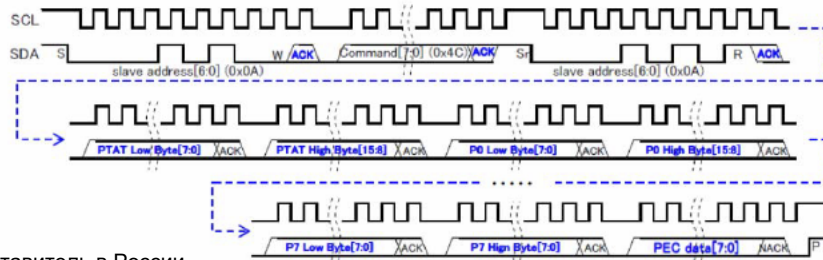

# Wishing you success with D6T !

**OMRON**  
Sensing tomorrow

**Omron Electronic Components BV**  
European Headquarter  
Wegalaan 57  
2132 JD Hoofddorp  
The Netherlands

Tel. +31 23 568 1200  
Fax. +31 23 568 1212  
info-components@eu.omron.com