

1. Report No. FHWA/TX-89/1191-1		2. Government Accession No.		3. Recipient's Catalog No.	
4. Title and Subtitle Survey of States Relative to Use of Highway Rights-of-Way for Business Purposes				5. Report Date September 1988	
				6. Performing Organization Code	
7. Author(s) Charles Viktorin and Jack T. Lamkin, Jr.				8. Performing Organization Report No. Research Report 1191-1	
9. Performing Organization Name and Address Texas Transportation Institute The Texas A&M University System College Station, Texas 77843-3135				10. Work Unit No.	
				11. Contract or Grant No. Study No. 2-15-88-1191	
12. Sponsoring Agency Name and Address Texas State Department of Highways and Public Transportation; Transportation Planning Division P. O. Box 5051 Austin, Texas 78763				13. Type of Report and Period Covered Interim - September 1987 September 1988	
				14. Sponsoring Agency Code	
15. Supplementary Notes Research performed in cooperation with DOT, FHWA. Research Study Title: Use of Highway Rights-of-Way by the Roadside Businesses and Itinerent Merchants					
16. Abstract This report examines the results of a survye mailed to all continental U. S. states concerning unauthorized use of highway rights-of-way by roadside vendors and itinerent merchants. Three basic areas are discussed: (1) extent and severity of unauthorized use, (2) methods used to regulate ROW use, and (3) current states' legislation.					
17. Key Words Roadside Vendors, Itinerent Merchants, Use of Highway Rights-of-Way, Right-of-Way Legislation			18. Distribution Statement No restrictions. This document is available to the public through the National Technical Information Service 5285 Port Royal Road Springfield, Virginia 22161		
19. Security Classif. (of this report) Unclassified		20. Security Classif. (of this page) Unclassified		21. No. of Pages 349	22. Price



**SURVEY OF STATES RELATIVE TO USE OF HIGHWAY
RIGHTS-OF-WAY FOR BUSINESS PURPOSES**

by

Charles Viktorin

and

Jack T. Lamkin

Research Report 1191-1
Research Study Number 2-15-88-1191
Use of Highway Right-of-Way by Roadside Businesses
and Itinerant Merchants

sponsored by

Texas State Department of Highways
and Public Transportation
Transportation Planning Division

Texas Transportation Institute
The Texas A&M University System
College Station, TX 77843

September, 1988

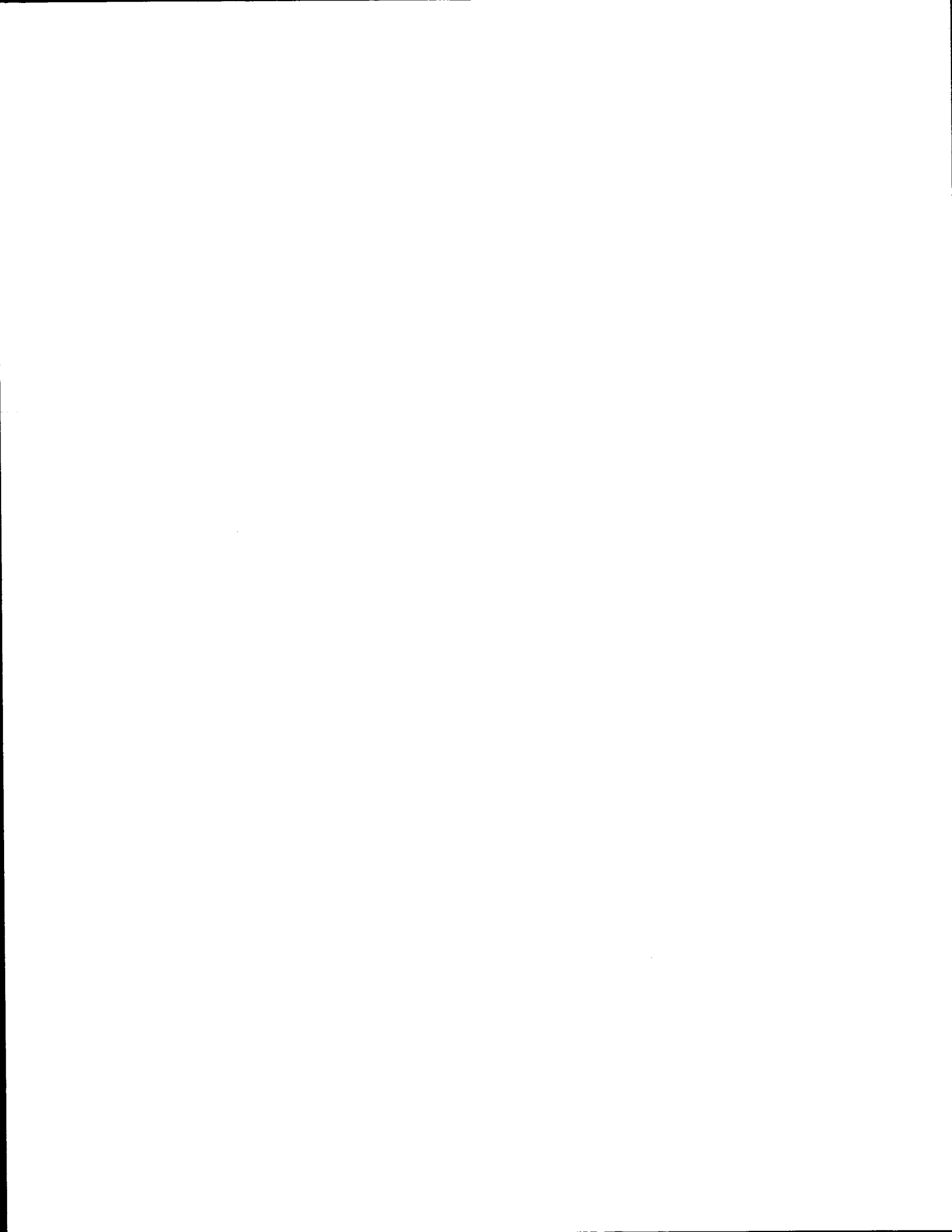

METRIC (SI*) CONVERSION FACTORS

APPROXIMATE CONVERSIONS TO SI UNITS

Symbol	When You Know	Multiply By	To Find	Symbol
LENGTH				
in	inches	2.54	millimetres	mm
ft	feet	0.3048	metres	m
yd	yards	0.914	metres	m
mi	miles	1.61	kilometres	km

AREA				
in ²	square inches	645.2	millimetres squared	mm ²
ft ²	square feet	0.0929	metres squared	m ²
yd ²	square yards	0.836	metres squared	m ²
mi ²	square miles	2.59	kilometres squared	km ²
ac	acres	0.395	hectares	ha

MASS (weight)				
oz	ounces	28.35	grams	g
lb	pounds	0.454	kilograms	kg
T	short tons (2000 lb)	0.907	megagrams	Mg

VOLUME				
fl oz	fluid ounces	29.57	millilitres	mL
gal	gallons	3.785	litres	L
ft ³	cubic feet	0.0328	metres cubed	m ³
yd ³	cubic yards	0.0765	metres cubed	m ³

NOTE: Volumes greater than 1000 L shall be shown in m³.

TEMPERATURE (exact)

°F	Fahrenheit temperature	5/9 (after subtracting 32)	Celsius temperature	°C
----	------------------------	----------------------------	---------------------	----

APPROXIMATE CONVERSIONS TO SI UNITS

Symbol	When You Know	Multiply By	To Find	Symbol
LENGTH				
mm	millimetres	0.039	inches	in
m	metres	3.28	feet	ft
m	metres	1.09	yards	yd
km	kilometres	0.621	miles	mi

AREA				
mm ²	millimetres squared	0.0016	square inches	in ²
m ²	metres squared	10.764	square feet	ft ²
km ²	kilometres squared	0.39	square miles	mi ²
ha	hectares (10 000 m ²)	2.53	acres	ac

MASS (weight)				
g	grams	0.0353	ounces	oz
kg	kilograms	2.205	pounds	lb
Mg	megagrams (1 000 kg)	1.103	short tons	T

VOLUME				
mL	millilitres	0.034	fluid ounces	fl oz
L	litres	0.264	gallons	gal
m ³	metres cubed	35.315	cubic feet	ft ³
m ³	metres cubed	1.308	cubic yards	yd ³

TEMPERATURE (exact)

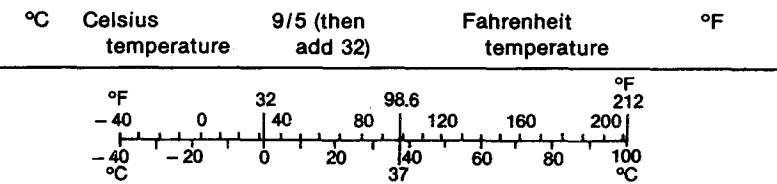

These factors conform to the requirement of FHWA Order 5190.1A.

* SI is the symbol for the International System of Measurements

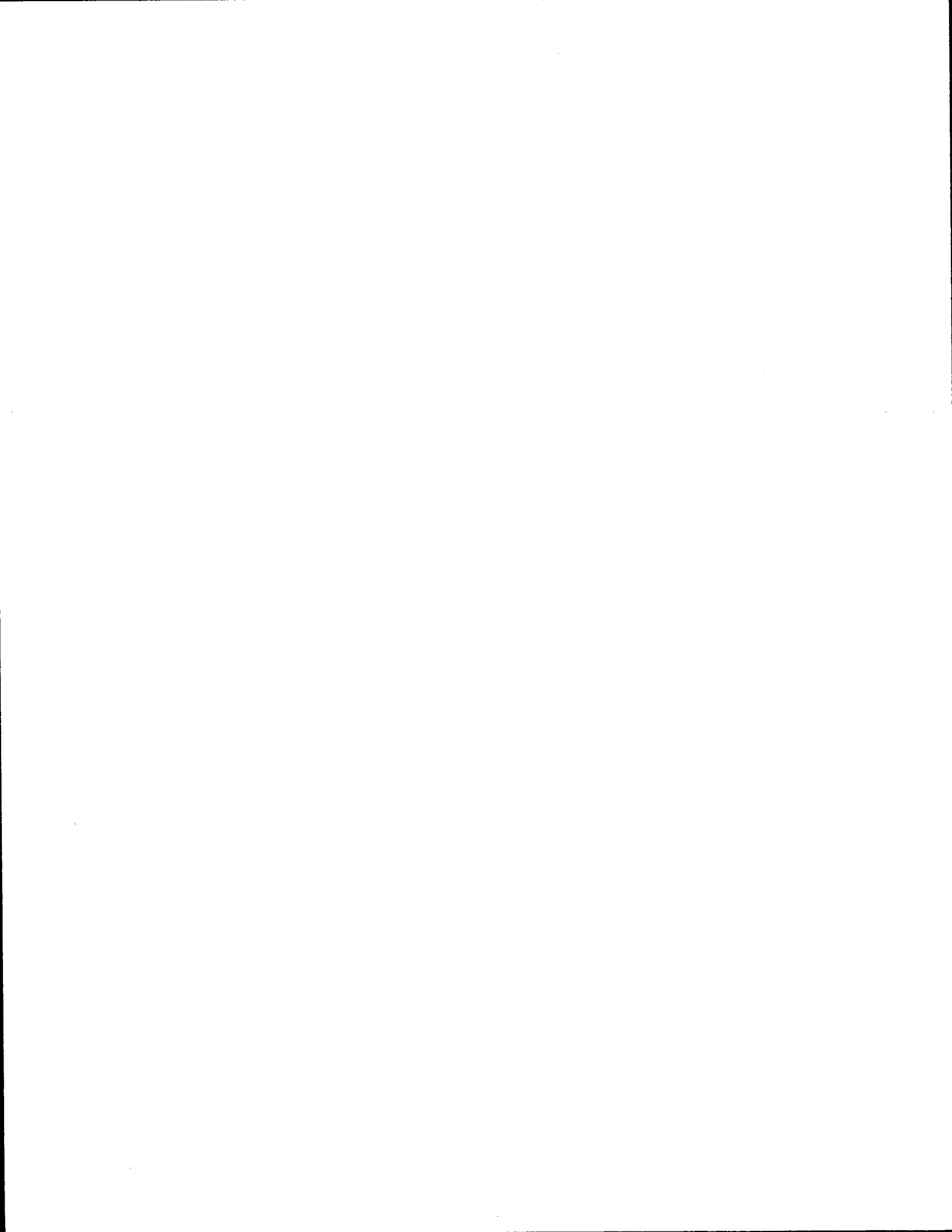

ABSTRACT

This report examines the results of a survey mailed to all continental U.S. states concerning unauthorized use of highway rights-of-way by roadside vendors and itinerant merchants. Three basic areas are discussed: (1) extent and severity of unauthorized use, (2) methods used to regulate ROW use, and (3) current states' legislation.

IMPLEMENTATION STATEMENT

This report is intended to serve as a resource document for SDHPT personnel in dealing with the issue of highway rights-of-way use by vendors and itinerant merchants.

DISCLAIMER

The contents of this report reflect the views of the author who is responsible for the accuracy of the data and facts presented herein. The contents do not necessarily reflect the official view or policies of the Federal Highway Administration or the Texas State Department of Highways and Public Transportation.

This report does not constitute a standard, specification, or regulation.

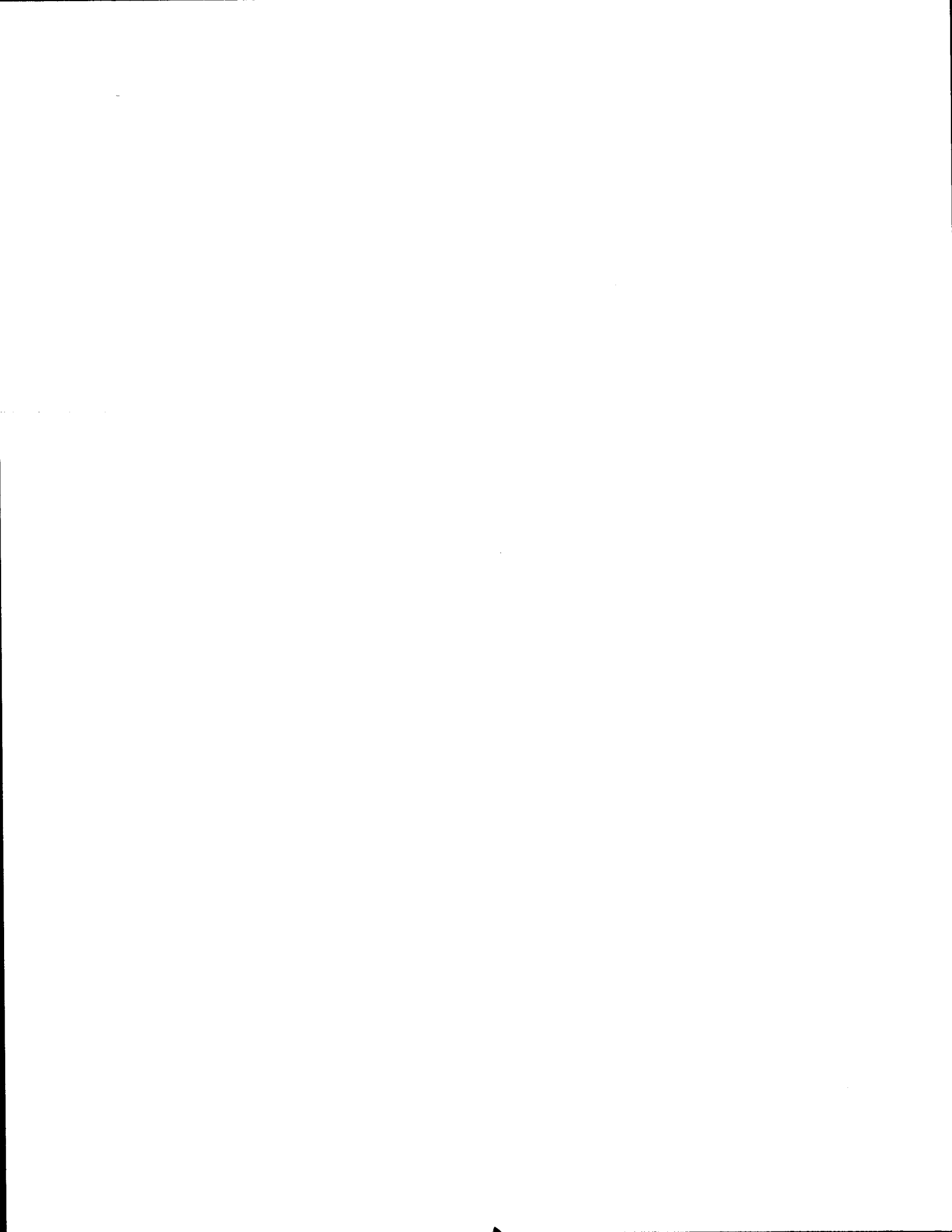

TABLE OF CONTENTS

	<u>Page</u>
ABSTRACT.....	iv
IMPLEMENTATION STATEMENT.....	iv
DISCLAIMER.....	iv
TABLE OF CONTENTS.....	v
LIST OF TABLES.....	vi
LIST OF FIGURES.....	vi
1.0 INTRODUCTION.....	1
2.0 EXTENT AND SEVERITY OF ROW USE.....	1
3.0 METHODS USED TO REGULATE ROW USE.....	2
4.0 CURRENT STATES' LEGISLATION.....	3
5.0 SUMMARY.....	4
APPENDIX A ROW LEGISLATION, DEPARTMENTAL POLICIES AND EXAMPLES OF LEASES, CITATIONS AND FORMS IN DIFFERENT STATES.....	A-1

LIST OF TABLES

	<u>Page</u>
1. Summary of ROW Use Survey.....	5

LIST OF FIGURES

	<u>Page</u>
1. States Responding to Questionnaire.....	8
2. States Contacted for Verification and Clarification.....	9

1.0 INTRODUCTION

This report presents the findings of a survey of state highway agencies regarding their authority and procedures in dealing with use of highway rights-of-way (ROW) by roadside vendors and itinerant merchants. The survey was undertaken in order to develop information for Task 1 of Research Study Number 2-15-88-1191, "Use of Highway Right-of-Way by Roadside Businesses and Itinerant Merchants."

A questionnaire was mailed to each state requesting information on unauthorized use of the highway right-of-way. Forty-five states responded (see Figure 1) to questions which were asked in four subject areas: (1) the extent, if any, of unauthorized use in right-of-way; (2) authorized use of right-of-way; (3) different methods used to deal with this problem; and (4) what type of offense (civil or criminal) is a violation and what agency(ies) is responsible for enforcement.

State laws, departmental rules, and regulations and related documents pertaining to the use of highway rights-of-way which were furnished to the study staff by the different states are presented in the appendix to this report. In addition, a brief summary of the information presented in tabular form is also included.

This report is primarily intended to serve as a resource document for State Department of Highways and Public Transportation (SDHPT) personnel. It presents the framework used by other states in dealing with the issue of highway right-of-way use by vendors and itinerant merchants.

The report is basically a compendium of state laws, rules and regulations, and related documents regarding use of highway rights-of-way by vendors. A brief summary of the questionnaire responses and a categorization of the various states' laws is contained in the following sections 2.0 through 4.0 of the report.

2.0 EXTENT AND SEVERITY OF ROW USE

To determine the extent and severity of unauthorized use by roadside vendors, the following questions were asked:

Do vendors use highway ROW in your state for business purposes?

- a. yes with authorization**
- b. yes without authorization**
- c. no**

Thirty-seven (82%) of the states acknowledged some form of vendor right-of-way use. Out of the thirty-six, 25 were without authorization and 12 were with some form of lease or permit legislation. Eight states indicated that no unauthorized ROW use occurred (Table 1.0).

Do vendors on ROW cause problems for you in these categories?

- a. operational problems**
- b. maintenance problems**
- c. safety problems**

Operational problems were named in twenty (44%) of the responses. Twenty states responded that vendors caused maintenance problems, and 25 (56%) stated that safety problems were caused by roadside vending. Fifty-eight percent of the state responses indicated some type of problem experienced with roadside vendors. (Table 1.0).

The extent of the responses of the two previous questions indicates that this problem is not limited to a few states. In fact, this vendor activity appears to be more wide spread and hazardous than expected.

3.0 METHODS USED TO REGULATE ROW USE

To learn existing methods of dealing with this problem, the following question was asked:

Is vendor use of ROW sanctioned?

- a. yes by state law**
- b. yes by departmental policy**
- c. no**

State law allows some form of vending in 17 states. Nine of these states allow ROW use only for blind service organizations of blind persons as specified in the Randolph-Sheppard Act. The eight other states have different forms of legislation for

ROW use (Table 1.0). The eight different forms of authorized ROW use are listed below by their respective states:

- CALIFORNIA - California uses a joint venture system between the state and private industries for vending along certain portions of the state ROW.
- FLORIDA - Although ROW vending is discouraged, Florida permits the temporary commercial leasing of rights-of-way that are not presently needed for road or highway purposes.
- ILLINOIS - Illinois leases the ROW in areas where it is not required for the safe and proper operation and maintenance of the highway facility. Any individual, company, organization, or public or quasi-public agency may submit a lease application to the District Engineer having supervision over State highways in the county where the site is located.
- KENTUCKY - Kentucky law allows permitting for the use of the ROW; however, the state is currently experiencing an enforcement problem with existing regulations.
- MARYLAND - Maryland allows "mobile seafood vendors" to use the ROW for business purposes.
- MINNESOTA - Minnesota leases unneeded ROW space to anyone approved by the Commissioner of Transportation.
- NEVADA - Nevada will lease ROW space to any individual or group, provided the location is not a safety hazard.
- NEW MEXICO - New Mexico issues permits for vendors to use the ROW.

4.0 CURRENT STATES' LEGISLATION

The following question was asked to determine what type of penalties were legislated in the states:

Is unauthorized use of ROW subject to:

- a. civil penalty
- b. criminal penalty

Unauthorized ROW use is subject to civil penalty in 31 states. In 21 states it is a criminal penalty. Twelve states have both civil and criminal statutes addressing violators. (It is possible for a state to have both civil and criminal statutes dealing with violations.)

Designated enforcement agencies are listed by state in Table 1.0 chart located at the end of this report.

5.0 SUMMARY

- Some form of vendor right-of-way use occurs in 83% of the states responding to the questionnaire.
- Vendors and transient merchants do cause operational, maintenance, and safety problems in 26 states.
- In 21 states, unauthorized use of ROW is a criminal offense. In 31 states, it is subject to civil penalty.
- The agencies responsible for enforcing legislation vary greatly from state to state. Some states use only their highway agency, while others rely on local law agencies.

Table 1. Summary of ROW Use Survey

STATE	NOT AUTHORIZED	AUTHORIZED		TYPE OF OFFENSE		Highway Agency	ENFORCED BY State/Local Police Agency	State/Local Attorney General
		Use by Blind Service Organizations	Private Use	Civil	Criminal			
Alabama	X			X			X	
Alaska	X			X			X	X
Arizona		X		X	X			X
Arkansas		X		X	X			X
California			X joint venture	X	X		X	X
Colorado	X				X		X	X
Connecticut	X			X			X	
Delaware	X			X			X	X
Florida			X issues permits		X		X	
Georgia	X				X	X	X	
Idaho		X		X		X		
Illinois			X leases ROW	X	X	X	X	X
Indiana	X			X			X	
Iowa	X			X	X	X		
Kansas	X			X			X	

Table 1. Summary of ROW Use Survey (cont.)

STATE	NOT AUTHORIZED	AUTHORIZED		TYPE OF OFFENSE		Highway Agency	ENFORCED BY	
		Use by Blind Service Organizations	Private Use	Civil	Criminal		State/Local Police Agency	State/Local Attorney General
Kentucky	X		X issues	X		X		
Louisiana	X			X		X		
Maine	X			X				X
Maryland			X seafood vendors		X		X	
Massachusetts	X				X	X	X	X
Michigan	X			X			X	
Minnesota			X leases ROW		X			X
Mississippi	X				X	X	X	
Missouri		X			X		X	
Montana	X			X	X	X		X
Nebraska	X			X		X		
Nevada			X leases ROW	X		X		
New Hampshire		X		X	X			X
New Jersey	X			X			X	
New Mexico			X leases		X		X	

Table 1. Summary of ROW Use Survey (cont.)

STATE	NOT AUTHORIZED	AUTHORIZED		TYPE OF OFFENSE		Highway Agency	ENFORCED BY State/Local Police Agency	State/Local Attorney General
		Use by Blind Service Organizations	Private Use	Civil	Criminal			
New York	X			X			X	
North Carolina		X		X	X		X	
North Dakota	X				X		X	
Oklahoma		X		X			X	
Oregon	X			X	X		X	
Pennsylvania	X			X	X	X		X
South Carolina	X				X		X	
South Dakota	X			X	X			X
Texas		X		X		X		X
Utah	X				X		X	
Vermont	X			X				X
Virginia	X			X	X		X	
Washington		X		X		X		
West Virginia	X			X	X	X	X	
Wyoming	X			X			X	

FIGURE 1

STATES RESPONDING TO QUESTIONNAIRE

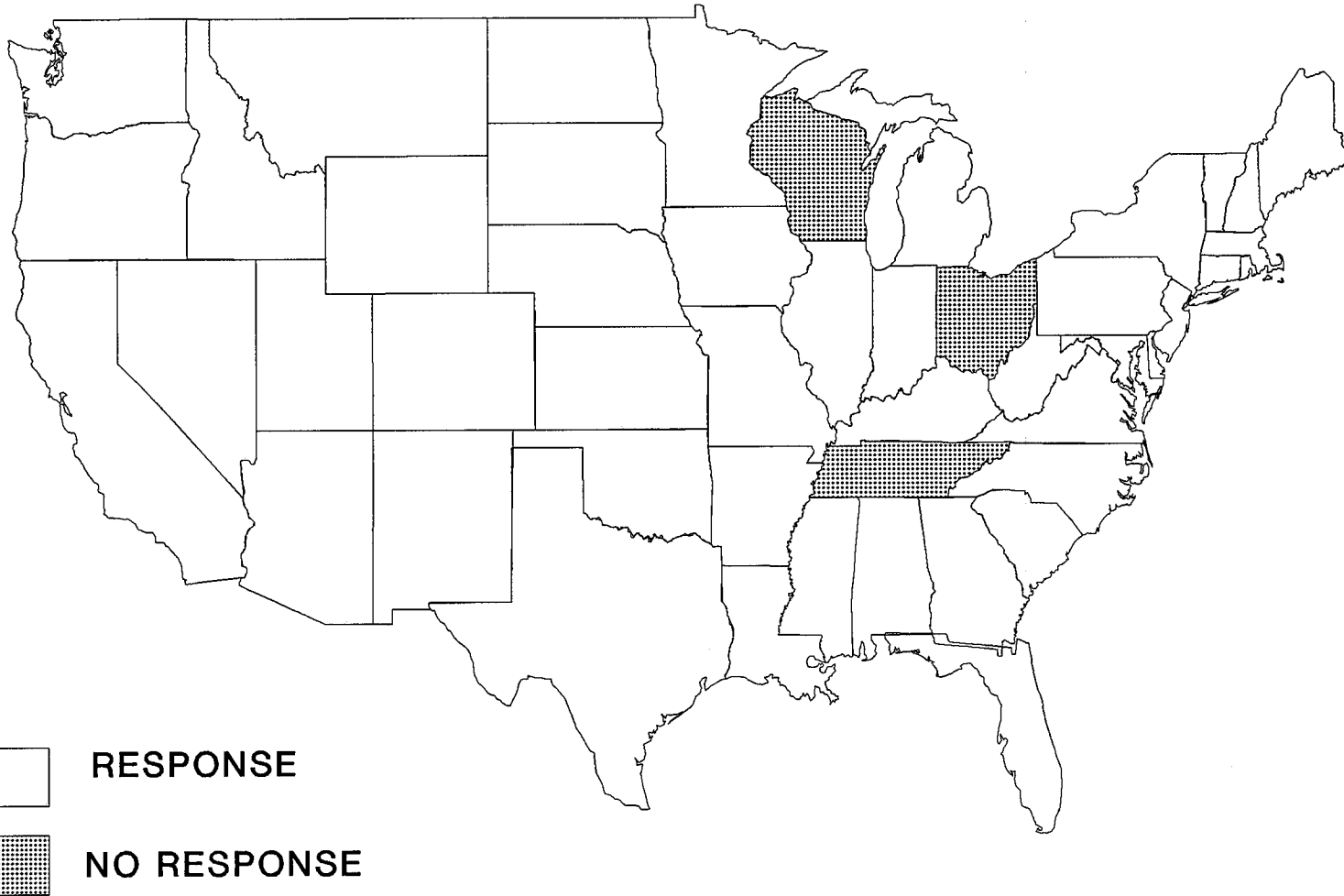
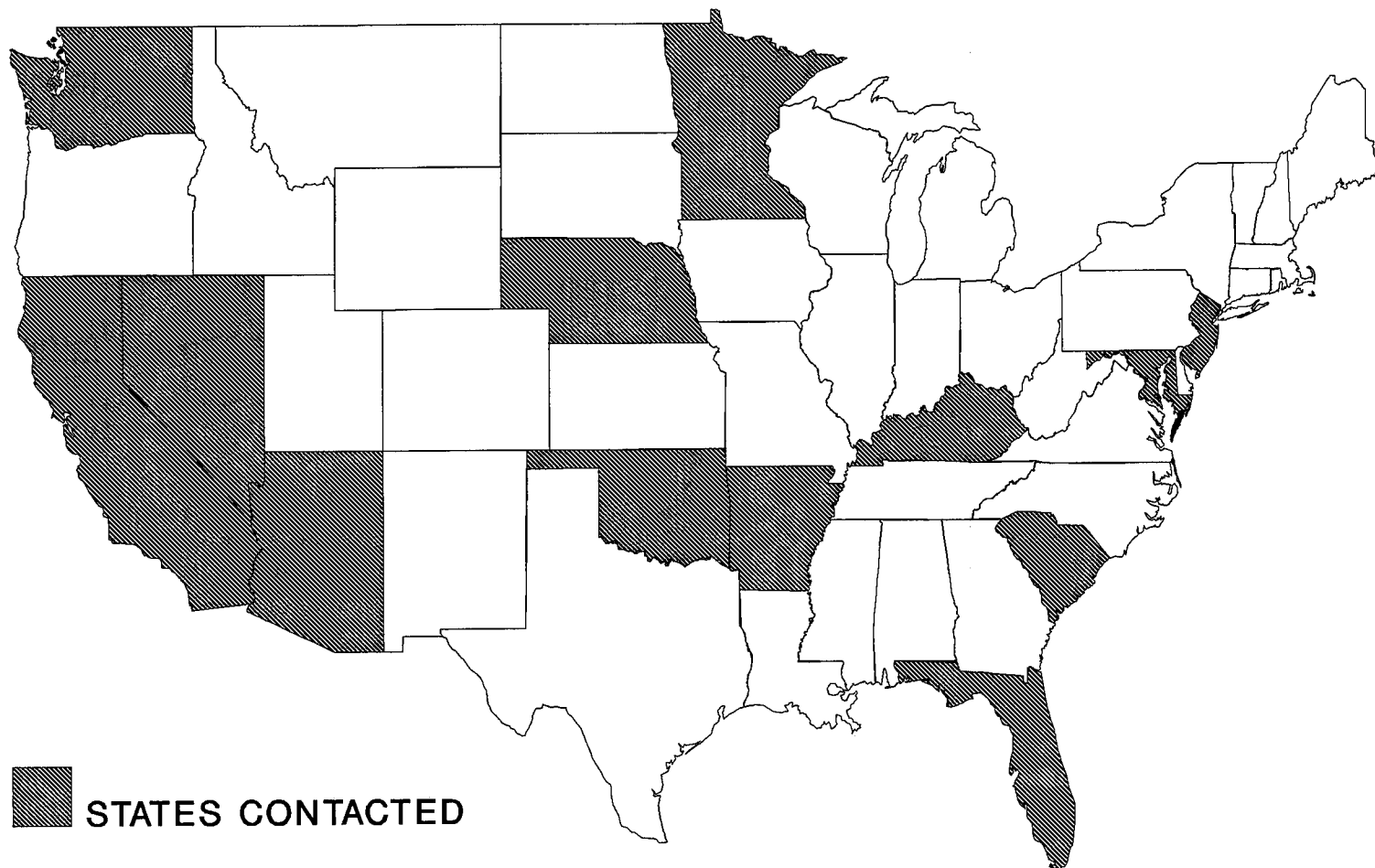

FIGURE 2

STATES CONTACTED FOR VERIFICATION AND CLARIFICATION





APPENDIX

<u>STATE</u>	<u>PAGE</u>
Alaska	A-1
Arizona	A-4
Arkansas	A-35
California	A-40
Connecticut	A-46
Delaware	A-54
Florida	A-57
Georgia	A-60
Idaho	A-63
Illinois	A-66
Indiana	A-96
Iowa	A-101
Kansas	A-108
Maine	A-116
Maryland	A-119
Massachusetts	A-132
Michigan	A-141
Minnesota	A-144
Mississippi	A-155
Missouri	A-160
Nevada	A-168
New Hampshire	A-205
New Jersey	A-211
New Mexico	A-227
New York	A-236
North Carolina	A-238
North Dakota	A-288
Pennsylvania	A-291
Utah	A-298
Vermont	A-300
Virginia	A-305
Washington	A-311
West Virginia	A-323
Wyoming	A-325



ALASKA

- Legislation



Sec. 19.25.180. Interpretation. Nothing in AS 19.25.080 — 19.25.180 shall be construed to abrogate or affect any law, ordinance, regulation or resolution which is more restrictive than the provisions of AS 19.25.080 — 19.25.180. (§ 5 ch 233 SLA 1968)

Article 4. Encroachments In Highways.

Section	Section
200. Encroachment permits	230. Notice of removal
210. Relocation or removal of encroachment	240. Summary removal
220. Unauthorized encroachments	250. Removal after noncompliance; removal expense

Sec. 19.25.200. Encroachment permits. An encroachment may be constructed, placed, changed or maintained across or along a highway but only in accordance with regulations adopted by the department. No encroachment may be constructed, placed, maintained or changed until it is duly authorized by a written permit issued by the department. (§ 2 ch 64 SLA 1971)

Collateral references. — 3 Am. Jur. 2d, Highways, Streets and Bridges, § 288. Advertising, §§ 5, 13, 14. 40 Am. Jur. 2d, 40 C.J.S., Highways, §§ 217-231.

Sec. 19.25.210. Relocation or removal of encroachment. If, incidental to the construction or maintenance of a state highway, the department determines and orders that an encroachment previously authorized by written permit must be changed, relocated, or removed, the owner of the encroachment shall change, relocate or remove it at no expense to the state (except as provided in AS 19.25.020), within a reasonable time set by the department. If the owner does not change, relocate or remove an encroachment within the time set by the department, the encroachment shall be considered an unauthorized encroachment and subject to the provisions of AS 19.25.220 — 19.25.250. (§ 2 ch 64 SLA 1971)

Sec. 19.25.220. Unauthorized encroachments. If an unauthorized encroachment exists in, on, under or over a state highway, the department may require the removal of the encroachment in the manner provided in AS 19.25.230 — 19.25.250. (§ 2 ch 64 SLA 1971)

Sec. 19.25.230. Notice of removal. Except as otherwise provided in AS 19.25.200, 19.25.210 and 19.25.240, notice shall be given the owner, occupant or person in possession of the encroachment, or to any other person causing or permitting the encroachment to exist, by serving upon any of them a notice demanding the removal of the encroachment. The notice shall describe the encroachment complained of with reasonable certainty as to its character and location. Service of the notice may be made by certified mail. (§ 2 ch 64 SLA 1971)

Sec. 19.25.240. Summary removal. The department may at any time remove from a state highway or road an encroachment which obstructs or prevents the use of the highway or road by the public. (§ 2 ch 64 SLA 1971)

Sec. 19.25.250. Removal after noncompliance; removal expense. After a failure of the owner of an encroachment to comply with a notice or demand of the department under the provisions of AS 19.25.200, 19.25.210 and 19.25.230, the department may remove, or cause to be removed, the encroachment, and the owner of the encroachment shall pay to the department:

- (1) the expenses of the removal of the encroachment;
- (2) all costs and expenses paid by the state as a result of a claim or claims filed against the state by third parties for damages due to delays because the encroachment was not changed, removed, or relocated according to the order of the department; and
- (3) costs and expenses of suit. (§ 2 ch 64 SLA 1971)

Chapter 27. Junk Yards.

Section	Section
10. Purpose	70. [Repealed]
20. Limitations of junk yards	80. Injunction
30. Junk yards lawfully in existence	90. Interpretation
35. Screening by department; lien	100. Agreements with the United States
40. Requirements as to screening	110. Definitions
50. Authority to acquire property interests for removal or screening of junk yards	120. Penalty for violation
60. Violating junk yard a nuisance	130. Additional requirements
	140. Short title

Sec. 19.27.010. Purpose. For the purpose of promoting the public safety, health, welfare, convenience and enjoyment of public travel, to protect the public investment in public highways and other roads maintained by the state, and to preserve and enhance the scenic beauty of lands bordering public highways and other roads maintained by the state, it is declared to be in the public interest to regulate and restrict junk yards in areas adjacent to the interstate, primary and secondary systems within this state and other roads maintained by the state. The legislature finds and declares that junk yards which do not conform to the requirements of this chapter are public nuisances. (§ 1 ch 233 SLA 1968; am § 7 ch 155 SLA 1970; am § 1 ch 179 SLA 1976)

Legislative history reports. — For report on ch. 233, SLA 1968 (HCSCSB 144 am FCC), see 1968 House Journal, p. 815.

Collateral references. — 58 Am. Jur. 2d, Occupations, Trades and Professions, §§ 1, 4, 5, 15.

Sec. 19.27.020. Limitations of junk yards. No person may establish, operate, or maintain a junk yard, any portion of which is within

ARIZONA

- Legislation
- Rules

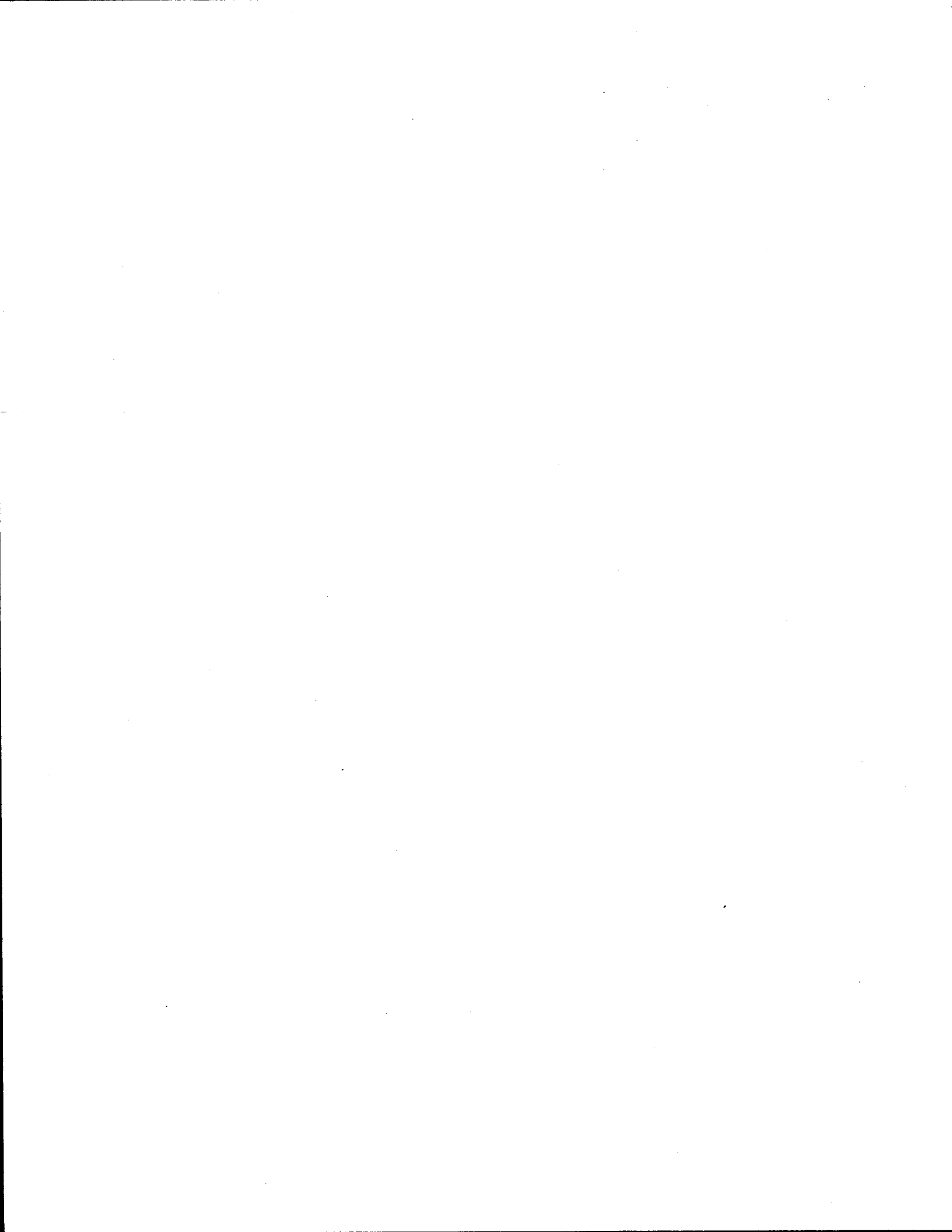

ARIZONA

28-1867. Designation of state and county federal aid secondary highways

A. Upon petition of the board of supervisors of a county, the board shall, if it decides that the public convenience is served and the designation will not interfere with the completion and upkeep of the present county highway system, submit to the federal highway administration a request that the road be placed on the county federal aid secondary system.

B. Federal aid secondary county highways shall be ordered constructed, improved, repaired and maintained by the county with the department acting as agent for the counties for the receipt of federal aid funds.

C. The costs of construction, improvement, repair and maintenance of federal aid secondary state highways shall be borne by the department.

D. Matching funds for any county federal aid secondary project shall be the responsibility of the county and matching funds for state federal aid secondary projects shall be the responsibility of the department.

E. Any rural road in the state may be designated a federal aid secondary road by approval of board with the concurrence of federal highway administration.

F. "Secondary roads" as used in this section means roads having secondary order of significance to primary roads which connect centers of population.

28-1868. Actions against state concerning lands taken or damaged in construction of highway or airport; limitation

An action brought to recover possession of or to clear title to real property claimed by the state, or any legal subdivision thereof, as a public highway or airport, or an action brought to recover compensation or damage for property taken or damaged in or for the construction of a public highway or airport, shall be commenced within two years after the cause of action has accrued and not afterwards.

28-1869. Roadside parks; historical markers

A. The department may construct, maintain and operate on highway property roadside parks for the use and benefit of the public.

B. The department may construct and erect on highway property signs and plaques marking points of historical importance, but such signs and plaques shall not be erected unless they have been certified as reasonably authentic and historically correct by the director of the department of library and archives.

~~28-1870~~ Misuse of public highway or airport defined; abatement; classification

A. A person who commits or causes to be committed any of the following acts is guilty of a petty offense:

1. Places or maintains an encroachment or obstruction upon, or makes any use of, or otherwise occupies a public highway or airport of the state or any of its legal subdivisions for any purpose other than authorized public travel, or for communication, transportation or transmission purposes except as otherwise provided in this section. The term "encroachment" includes any structure or object of any kind or character which is placed in, under or over any portion of the public highway or airport.

2. Places or maintains an encroachment or obstruction upon, uses, occupies, damages or otherwise interferes with a public highway, airport or a public bridge, causeway, viaduct, trestle or dam, unless authorized by the director, or if not a state highway or structure, or airport facility unless authorized by the governing body of the legal subdivision in which such act is committed.

3. Knowingly molests or destroys any part, projection, structure, appurtenant or accessory of a public highway or airport, or destroys or otherwise interferes with a drainage ditch constructed for the protection of a public highway or airport, or a dike, ditch, levee, jetty or an embankment appurtenant thereto.

4. Knowingly destroys or interferes with a ford, dip culvert or crossing of a creek, gulch, river or stream by digging away the banks, or by damming, deepening

ARIZONA

or widening any thereof so as to divert waters upon the public highway or airport or cause injury or damage thereto by flooding or otherwise.

5. Knowingly places or maintains any vehicle, aircraft or structure, parked or placed wholly or partly within any public highway, runway or taxiway specifically for the purpose of selling the vehicle, aircraft or structure or of selling or specifically advertising the sale of, at any location, any article, service or thing.

6. Knowingly stores, services, repairs or otherwise works upon any vehicle wholly or partly within any highway other than upon a vehicle which is temporarily disabled.

7. Knowingly removes, damages or destroys any tree or shrub standing on a highway right-of-way.

8. Knowingly obstructs or injures any public highway, runway or taxiway by causing or permitting flow or seepage of water under his control to escape onto the highway, runway or taxiway.

B. Each day of violation of any provision of subsection A of this section is a separate violation upon failure to remove or to diligently prosecute the removal of any encroachment after notice under section 28-1871. Each encroachment shall be treated as a separate violation.

C. In addition to the penalties prescribed by this section, an act committed contrary to this section is a public nuisance and may be abated by injunction, and a person who commits any such act is subject to an action for damages by the state brought by the attorney general, or the county attorney of the county in which the act is committed upon direction of the attorney general.

D. The provisions of this section do not apply to any department personnel or agents performing normal construction and maintenance functions and do not apply to any person who has prior authorization in writing from the director to perform any of the acts referred to in this section.

28-1871. Additional remedies against particular highway or airport encroachments

A. If an encroachment is a fixed advertising device or a movable object, notice for the removal of the encroachment may be given to the occupant or owner of the reversionary interest of the land or person causing or owning the encroachment by personal service or by registered or certified mail at his place of residence if known, and if unknown notice may be posted upon the encroachment. If a highway encroachment, the notice shall specify the width of the highway, the place and extent of encroachment and require the removal of the encroachment within thirty days thereafter if the encroachment is a fixed advertising device and within fifteen days after notice is given or posted if the encroachment is a movable object. If an airport encroachment, the notice shall specify the location of the runway or taxiway, the place and extent of the encroachment and require the removal of the encroachment within thirty days thereafter if the encroachment is a movable object. If this procedure is used and if the removal is not commenced within the required period or after being commenced is not diligently prosecuted, the department or if not a state highway or airport facility, then the governing body of the appropriate political subdivision, may remove such encroachment without commencing any action. The person responsible for the encroachment shall bear the cost of removal, and an action may be filed in the superior court in and for the county where such encroachment is made or exists, and where such removal is manifested, to secure reimbursement of the necessary cost of removal to the subdivision of the state in which the custody and control of the highway or airport facility is lodged by law.

B. The use of any procedure provided for in this section is not exclusive and shall not prohibit the use of any other remedy provided by law to protect any highway or airport facility or the authority of officers of the department of public safety to cause the immediate removal of obstructions, encroachments, vehicles or aircraft.

Encroachments in Highway Rights - of - Way

RULE NO. R17-3-712

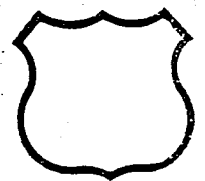
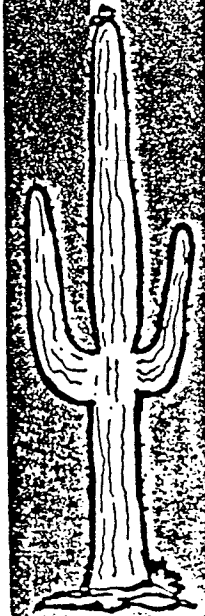
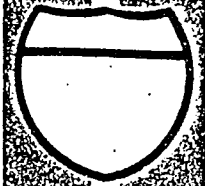
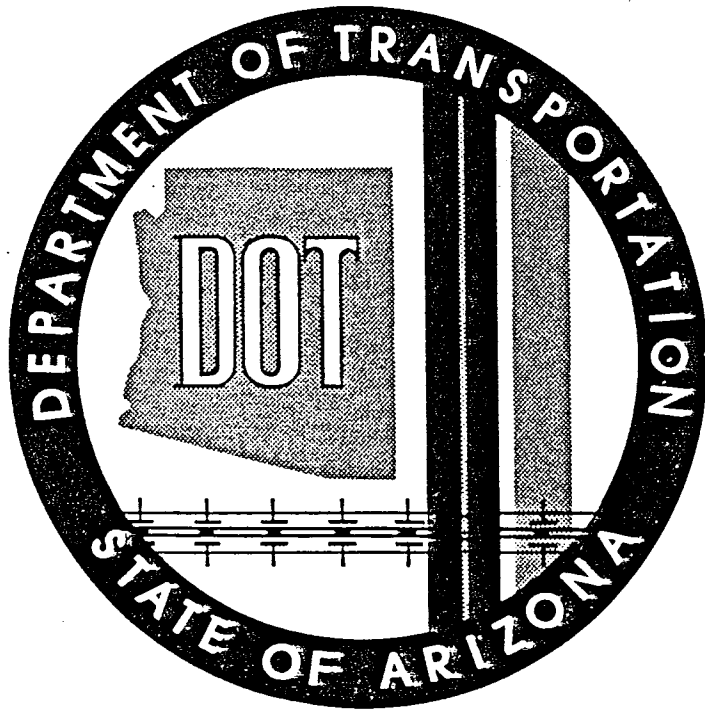

HIGHWAYS DIVISION
MAINTENANCE PERMITS SERVICES
APRIL 14, 1981

ARIZONA DEPARTMENT OF TRANSPORTATION

(Name of Agency, Board, Commission, Department, Officer)

The undersigned hereby certifies that attached hereto is a true and correct copy of the Order of Rule Adoption dated January 6, 1981 which provides as follows:

ADOPTED Arizona Encroachments in Highway Rights-of-Way, Rules No. R17-3-712
A.C.R.R. Rule No.(s)

AMENDED R17-3-712
A.C.R.R. Rule No.(s)

REPEALED _____
A.C.R.R. Rule No.(s)

Dated this 6th day of January, 1981.

ARIZONA DEPARTMENT OF TRANSPORTATION

(Name of Agency, Bd., Commission, Dept., Officer)

E.F. Sandlin

(Signature of Officer) E.F. SANDLIN

Deputy State Engineer

(Title of Officer)

(PLACE STAMP OR SEAL, IF ANY)

Certification, Attorney General's Office

APPROVED & CERTIFIED pursuant to
A.R.S. Section 11-1001 of this
14th April 1981
Bob Coe

Attorney General

NOTE: Three (3) copies of the rule changes shall be filed with an original and two (2) copies of this Certification form following certification by the Attorney General. The rule changes shall be typewritten, double spaced, on standard size paper, 8 1/2" X 11".

ARIZONA DEPARTMENT OF TRANSPORTATION

ENCROACHMENTS IN HIGHWAY RIGHTS-OF-WAY

Rule No. R 17-3-712

This pamphlet presents information regarding Arizona State law concerning encroachments in highway rights-of-way. It also gives definitions, authority, responsibility, and exhibits for encroachment permit application procedures, traffic control and detours, city issued state permits, rest area coffee breaks, maintenance responsibility, unauthorized encroachments and other rules relative to the safe and efficient placement of utility lines within our highway rights-of-way.

PREPARED AND DISTRIBUTED BY:

Maintenance Permits Services
Maintenance Section, Highways Division
Arizona Department of Transportation

ENCROACHMENTS IN HIGHWAY RIGHTS-OF-WAY
Rule No. R17-3-712

TABLE OF CONTENTS

<u>ITEM</u>	<u>SUBJECT</u>	<u>PAGE</u>
A	Purpose and Authority	1
1	Purpose	1
2	Authority ARS 28-108 (19)	1
B	Scope	1
C	Encroachment Permit Application Procedures	1
1	Sending Applications	1
2	Plans Required	1
3	Each Application Reviewed	2
4	Time Limit	2
5	Time Extension	2
6	Transfer of Permits	2
7	Bonding	2
8	Access	3
9	Signs	4
10	Landscaping	4
11	Hydraulics	5
12	Utilities	6
13	Fences, Gates and Cattleguards	6
14	Jack or Bore	6
D	Parades, Motion Pictures	6
E	Temporary Signs or Banners, Including Christmas Decorations	7
F	Traffic Control and Detours	7
G	Minimum Setback	7
H	Rest Area Coffee Breaks	8
I	City-Issued State Permits	10
J	Maintenance Responsibility	10
K	Unauthorized Encroachments	11
L	Traffic Hazards and Permits	11

<u>ITEM</u>	<u>SUBJECT</u>	<u>PAGE</u>
Exhibit 1	List of District Offices	13
Exhibit 2	Curb, Gutter, Sidewalk and Driveway Details	14
Exhibit 3	Turnout and Driveway Layout	15
Exhibit 4	Pavement, Cut & Replacement	16
Exhibit 5	Crossing Under Pavement	17
Exhibit 6	Cattle Guard, Roadway	18
Exhibit 7	Fence & Gates, Line, Steel Posts	19
Exhibit 8	Pipe Culvert Installation	20
Exhibit 9	Minimum Clearances for Utility Lines and Poles as Related to Highways	21
Exhibit 10	Permit Regulations for Signs and Awnings	22

HIGHWAY OPERATIONS GROUP

Order of Rule Adoption

Pursuant to A.R.S. 28-108, the Arizona Department of Transportation hereby adopts the following Rule:

A new Section R 17-3-712, Encroachments in Highway Rights-of-Way is adopted to read as follows:

A. Purpose and Authority

1. Purpose

In order to adequately control highway rights-of-way, prevent their abuse, and unauthorized use, the Director herein wishes to prescribe the above referenced rule.

2. Authority ARS 28-108(19)

"The Director shall: . . . 19. Exercise complete and exclusive operational control and jurisdiction over the use of state highways and routes and prescribe such rules and regulations regarding such use as he deems necessary to prevent the abuse and unauthorized use of such highways and routes."

B. Scope

The rules and regulations herein established include permit application procedures, permit processing procedures, initial placement, adjustment, relocation, reconstruction and replacement for use of State highway rights-of-way.

C. Encroachment Permit Application Procedures

1. Completed ADOT applications shall be sent to the appropriate District Engineer. (See list of District offices in Exhibit 1). The District Engineer is responsible within the District for all phases of implementing the control of encroachment permits from the initial application, review, approval, construction and final inspection.

2. Plans Required

Applicants shall submit a set of plans indicating highway route number, mileposts, highway engineering stations, and physical features such as building, bridges, culverts, poles and other

stationary landmarks necessary to adequately describe the location. Permit applicants are encouraged to employ competent design professionals such as registered professional engineers or architects when preparing plans of a complex nature. Permit applications shall include four sets of plans on primary and secondary highways and five sets on Interstate highways. Commonly used construction standards are included as Exhibit Numbers 2 -10.

3. Each Application Reviewed

All permit applications are initially submitted to respective districts. Only when necessary, will the districts route them to the appropriate department, for comments. The findings will be forwarded to the district office for final evaluation and issuance. A copy of the permit is sent to Maintenance Permits Services for filing as well as for quality control, i.e., review for uniformity and consistency in compliance with ADOT standards, specifications and special requirements in the issuance of permits. No work is to be performed until the permit is approved. All work is to be in accordance with Arizona Department of Transportation standards.

4. Time Limit

Ninety (90) calendar days will be the normal time allowed for completion of construction. Time limits beyond ninety days' time may be granted as determined by the Arizona Department of Transportation.

5. Time Extension

Applicants may apply for a time extension beyond the allotted time indicated on the permit by contacting the District office. If work has changed, a reapplication may be required.

6. Transfer of Permits

Permits are transferable upon sale of ownership provided new owner furnishes the Arizona Department of Transportation with a notification within 30 days after date of sale. It is the obligation of the permittee to notify the new owner of the necessity to apply for a change of ownership.

7. Bonding

- a. Performance bonds or other assurance of construction may be required to insure faithful performance of a permittee's

obligation. The amount shall be equal to one half the amount of the cost of the work or any other possible financial loss to the State (as determined by the District Engineer).

- b. The performance bonds shall be executed by the applicant as principal with a corporation duly authorized to transact surety business in the State of Arizona. The bond shall be in favor of the Arizona Department of Transportation, shall be continuous in form, and shall be limited to the face amount of the bond irrespective of the number of years the bond is in force. The bond shall be released upon satisfactory performance and acceptance of the work or may be cancelled after the applicant has provided other security satisfactory to the Arizona Department of Transportation which will cover obligations that remain.
- c. In instances where an applicant is issued numerous small permits throughout the year, he may post a continuing bond to cover work under more than one permit. The continuing bond shall be of a value sufficient to cover all work under construction by the permittee at any time and shall be satisfactory to the District Engineer.
- d. The bonding requirement may be waived when it can be determined by the District Engineer that adequate protection is provided the Department to ensure satisfactory completion of the construction.

8. Access

- a. No access will be granted where access control rights have been legally established unless waived by the State Engineer in accordance with FHWA standards.
- b. Access to abutting property from within Interstate or other freeway rights-of-way where permitted will be limited to:
 - i. Frontage roads except the merging entrance and exit ramp areas which will be subject to traffic engineering evaluation.
 - ii. Intersecting or nearby public roads and streets within Interstate rights-of-way. At interchanges control for connections to the crossroad is normally effected beyond the ramp terminals by purchasing

of access rights. Such control should extend along the crossroads beyond the ramp terminal 100 feet or more in urban areas and 300 feet or more in rural areas subject to traffic engineering evaluation.

- c. Access from within primary, secondary or other conventional highway rights-of-way will be permitted in accordance with appropriate standards. (See Exhibits 2, 3 and 8).
- d. Median openings may be allowed on divided highways except Interstate or other freeways provided they conform to Arizona Department of Transportation policy regarding the design and spacing of such openings. This policy will be provided applicants upon request.
- e. Permits shall be only for the construction of new turnouts and driveways or changing the location of an existing driveway. They shall not be issued for the purpose of providing a parking area or for servicing of vehicles on highway right-of-way.
- f. Joint driveways may become desirable for landowners of adjacent properties to require a joint driveway to service both properties. If this is the case, only one of the two adjacent landowners need apply for the access permit but a notarized written mutual agreement, signed by all parties involved, must accompany the application form.

9. Signs

On-premise signs, displays, canopy, awning, or devices may be erected on structures occupying highway right-of-way airspace, but shall be limited to those indicating ownership and type of on-premise activities and shall be constructed in accordance with Arizona Department of Transportation Standards (See Exhibit 10). No portion of the structure support is allowed within highway right-of-way.

10. Landscaping

- a. The highway roadside is an integral unit of a total highway facility. The term "roadside" generally refers to the area between the outer edge of the roadway and the right-of-way boundary. These include all unpaved areas within the right-of-way.
- b. All plans and specifications shall be sufficiently complete and detailed for easy

analysis, cost estimating and compliance inspection and shall be submitted in accordance with "Roadside Development Landscaping Permit Guidelines" available to applicants upon request.

- c. Permit applicants or their professional consultants may be required to discuss and coordinate landscape plans with the Roadside Development Services prior to permit approval.
- d. Plans shall be designed to select plant materials appropriate for the intended use and location, to arrange plants for optimum effect, and to insure reasonable maintenance within the capability of the proposed permittee. Permit application will be reviewed for consideration of the factors which can affect the safe and efficient operation of the highway facility. It will be the responsibility of the permit applicant to assure that all landscaping is maintained after construction.
- e. A clear line of sight must be maintained at all highway intersections and entrances; therefore, all plantings in this zone must be limited to an ultimate height of 30 inches or less.
- f. Plants shall not be used where they may encroach upon drainage-ways and impede their functional value or increase maintenance. It shall be the responsibility of the permit applicant to assure that all landscaping is maintained after construction.

11. Hydraulics

At the discretion of the District Engineer the following information shall be submitted by permit applicants when any changes are made in drainage conditions:

- a. A narrative report including a description of the existing drainage conditions, the proposed revisions and the effect of the proposed changes on existing conditions;
- b. Maps and/or drawings sufficient to show all pertinent features of the proposed modifications. This may include site maps, drainage area maps, contour maps, grading plans, structure profiles, channel profiles, etc;

c. Hydrologic and hydraulic calculations when applicable for design discharge, headwater elevations, tailwater elevations, flow depths and flow velocities in channels.

12. Utilities

All use permits will be in accordance with the Arizona Department of Transportation Guide for Accommodating Utilities on Highway Rights-of-Way. If applicant has a utility agreement with Arizona Department of Transportation, this agreement shall be included with the application. Utility plans shall adequately show such features as pavement and right of way lines in relation to their proposed facilities. Plans shall clearly indicate any existing utilities in the area. (See Exhibit 9). If plan symbols are used that are not standard, they shall be defined on the plans submitted.

13. Fences, Gates and Cattleguards

Applicants shall be responsible for assuring that stock do not enter upon the highway modifying or installing fence, gates or cattleguards. Backfences shall be maintained in a stockproof condition. (See Exhibits 6 and 7).

14. Jack or Bore

Pipes, conduit or other utilities shall be jacked or bored through beneath paved area. Pits may be placed in the median for boring, jacking or driving of pipes or conduits under divided roadways. The pit areas shall be completely fenced or barricaded and placed at a minimum distance of thirty feet from the edge of shoulder. Pavement cuts shall be considered only when jacking, boring or other alternatives are proven impractical and then only when approved by the District Engineer. (See Exhibits 4 and 5).

D. Parades, Motion Pictures

Parade and Motion Picture requests shall be made in writing with an accompanying sketch and submitted directly to the appropriate District Engineer as listed in Exhibit 1. The request shall include:

1. Location
2. Purpose
3. Time - - date and hour
4. Length of time

5. Traffic control
 6. Traffic re-route
 7. A statement holding the Arizona Department of Transportation harmless in the event of any damage to persons or property which is caused by the event.
- E. Temporary Signs or Banners, Including Christmas Decorations

No temporary signs, banners or Christmas decorations shall be attached to any traffic control device, nor shall any such signs, banners or decorations interfere with operation of such devices. Requests for temporary signs or banners shall be made in writing and submitted directly to the appropriate District Engineer as listed in Exhibit 1. The request shall include:

1. Location
 2. Height of sign or banner across Highway (18' Minimum)
 3. Size of sign or banner and wording
 4. Inclusive dates sign or banner will hang
 5. A statement holding the Arizona Department of Transportation harmless in the event of any damage to persons or property which is caused by this event.
 6. Legend
- F. Traffic Control and Detours

Traffic shall be protected at all times in accordance with the Arizona Department of Transportation Traffic Control Manual. All signs, placement of signs, barricades, lights, and necessity of flagmen shall be the responsibility of the Permittee.

G. Minimum Setback

1. 50 MPH or greater design speed:
 - a. Minimum setback of a fixed object from the edge of the traffic lane should be 30 feet unless one of the following reasons will allow for a lesser distance:
 - i. Cuts of 3 to 1 or steeper - obstacles are allowed 10 feet behind the point of vertical intersection (P.V.I) at the toe of the slope.

- ii. Where concrete barriers, walls, abutments, or other rigid obstructions are used - fixed objects may be placed 4' behind the obstructions.
 - iii. Where flexible guardrail (Box-Beam, W-Beam, or cable) is used 6 to 20 feet behind the face of the guardrail, depending upon the type.
 - iv. Where there are barrier curbs (5" or more vertical face) near a traveled lane - 6 feet behind the face of the curb; adjacent to a parking lane - no definite setback distance.
- b. Where limited right-of-way or the necessity for planting would result in less clearance, all factors in the particular problem area should be weighed to decide if a special exception is warranted.
2. 50 MPH or Less Design Speed:
- a. Minimum setback of a fixed object from the edge of the traffic lane may be 25 feet unless one of the reasons set forth under (1) will allow for a lesser distance.
 - b. On curves, adequate sight distance for the design speed of the highway must be maintained.

H. Rest Area Coffee Breaks

Free coffee is allowed in rest areas for which donations may be accepted but not required if the following conditions are met:

1. The activity must be conducted for the expressed purpose of improving the safety of highway travel and not as an advertisement of any organization or activity.
2. The applicant must be a nonprofit organization with a concern for automotive, highway or driver safety.
3. The activity must be carried on solely within the rest area apart from any ramp or other surface used for the movement of vehicles. The intent is to assure an absolutely safe operation. Permission will not be granted for such activity at rest areas where the activity could cause a backup along the ramps to the main lanes of the highway.

4. The activity must have the approval of the appropriate ADOT District Engineer and must meet other requirements of State law:

- a. Applicant shall specify the rest area to be utilized on interstate or primary highway including route number and milepost. If on a divided highway with dual rest areas, both shall be utilized. This is to promote highway safety by alleviating the need of vehicles to cross the median illegally.
- b. Specific time and date that a "safety break" is to be in operation shall be stated by the applicant.
- c. In order to provide the least rest area interruption, the District shall designate the location to be utilized for the coffee break facility.
- d. Applicants must submit a sketch indicating the location, legend and size for any proposed signs. The District Engineer shall have authority over type, size up to the maximum as stated in Item 5 below, and location of signs on or off the right-of-way.
- e. A letter for each request must state that the applicant agrees to abide by the following requirements:
 - i. The State accepts no liability for such activities.
 - ii. There shall be no impeding of traffic or normal use of the rest area.
 - iii. Erection and removal of all signs will be at no cost to the State.
 - iv. After the specified time for the activity has terminated, the applicant will be given 24 hours to remove all signs.
 - v. The maximum size of signs shall be limited to a rectangular 4' x 8' or one with an equivalent area.
 - vi. Any connection to rest area power shall be done in full compliance with OSHA safety requirements. The use of electrical cords outside the area of the facility will not be permitted.
 - vii. The connector to the rest area power source shall be so placed that it does not constitute a hazard to the public nor

shall use only the connector furnished by the State. If no power is available, the permittee shall provide his own.

- viii. Applicant shall be responsible for cleaning the site following use. Failure to do so will result in the district billing applicant for costs.
- ix. No tools other than those manufactured for use on water faucets shall be used to secure water from rest area facilities.
- x. Approval for requests will be made on a first come, first served basis; however, requests will not be accepted earlier than 45 days nor later than 7 days before the first date of proposed service. No formal permit will be issued; however, a letter of response will originate from the appropriate District Engineer with copies to the appropriate maintenance highway crew supervisor, DPS office and Maintenance Permit Engineer. The letter may also contain additional specific conditions for use of that particular rest area.

I. City-Issued State Permits

When authorized by maintenance agreements with Arizona Department of Transportation, cities may issue permits to use State highway RIGHT-OF-WAY. A city authorized to issue State highway permits is required to use State Standard Permit forms and follow such general State policies regarding encroachments as may be specified by Arizona Department of Transportation. State design standards may be modified in cases where city standards of design are more restrictive than State requirements, in which case City standards of design will be followed.

J. Maintenance Responsibility

The adjacent property owners having access to a State highway shall be fully responsible for the maintenance of their driveway including the portion from the highway right-of-way line to the outside edge of the highway shoulder or curblin. This maintenance responsibility includes the removal of snow and ice and keeping the portion within the highway right-of-way in a safe condition for the general public. The owner shall be responsible for the maintenance of ditches, pipes, catch basins, grates, poles, gates, aerial wires, buried cables and other structures or installations placed in connection with encroachment permits. The owner will be given ten days notice to

perform the required maintenance. After this period, the Director may then perform the required maintenance, and the owner shall be liable for the costs of such maintenance. If an emergency exists wherein there is an immediate hazard to the highway, the Director may perform the required remedial maintenance, and the owner shall be liable for all such costs incurred. The owner shall be responsible for any revisions or improvements required as a result of changed conditions of use after the permit is issued and/or after construction is completed, upon the direction of the Arizona Department of Transportation.

K. Unauthorized Encroachments

A.R.S. 28-1870 defines misuse of public highways or airports. Use of State highway rights-of-way shall be limited to authorized uses herein described. Any other uses will be permitted only by specific approval by the Director of Transportation. Owners of unauthorized property located in the State highway right-of-way will be notified that they are in violation of State law. If the encroachment has not been removed within the time prescribed, the Director may remove the unauthorized encroachment, and the owner shall be liable for the cost of such removal.

1. The following encroachments or uses of state highway right-of-way will normally not be permitted:
 - a. Advertising signs
 - b. Parking areas
 - c. Sales of any article, service or thing
 - d. Bicycle, walking, equestrian or other activities on Urban Freeways
 - e. Any commercial or industrial activity
2. None of the above uses of state highway right-of-way will be permitted except for applications in special circumstances, and the use in no way conflicts with safe and efficient highway uses nor with highway maintenance or other authorized activities. Permits will always need to be acquired for these encroachments.

L. Traffic Hazards and Permits

No permit shall be issued for any encroachment if it creates traffic hazard. Applicants will adhere to the manual on Uniform Traffic Control Devices, R-17-3-01. (Copy of which is on file with the Secretary of State).

No work shall be allowed without a properly approved permit.

DATED this 6th day of July, 1981.



E. F. SANDLIN
Deputy State Engineer
for Highway Operations

EFS/JEU/bk
Attachments - 10 Exhibits

LIST OF DISTRICT OFFICES

	<u>TELEPHONE</u>	<u>MAILING ADDRESS</u>
<u>DISTRICT I</u>		
Phoenix	255-7381 255-7521	2140 W. Hilton Ave. Phoenix, Arizona 85009
Phoenix	255-7386	206 S. 17th Ave. Room 176A Phoenix, AZ 85007
<u>DISTRICT II</u>		
Tucson	620-5411	1221 S. 2nd Ave. P.O. Box 23706 Tucson, AZ 85726
Globe	255-7871 425-7638	Hwy. 60, Box 2717 Globe, AZ 85502
Safford	255-7661 428-5470	Hwy. 70E. Box 711 Safford, AZ 85548
<u>DISTRICT III</u>		
Prescott	255-7527 445-5391	1210 E. Sheldon St. Box 791 Prescott, AZ 86302
Kingman	255-7340 753-2164	3660 E. Andy Devine Box 3309 Kingman, AZ 86401
Yuma	255-7489 782-1646	225 12th St. Box 1330 Yuma, AZ 85364
<u>DISTRICT IV</u>		
Flagstaff	255-7716 774-1491	1801 S. Milton Rd. Flagstaff, AZ 86001
Page	645-2412	Box J Page, AZ 86040
Holbrook	255-7493 524-6801	2407 E. Navajo Blvd. Box 280 Holbrook, AZ 86025

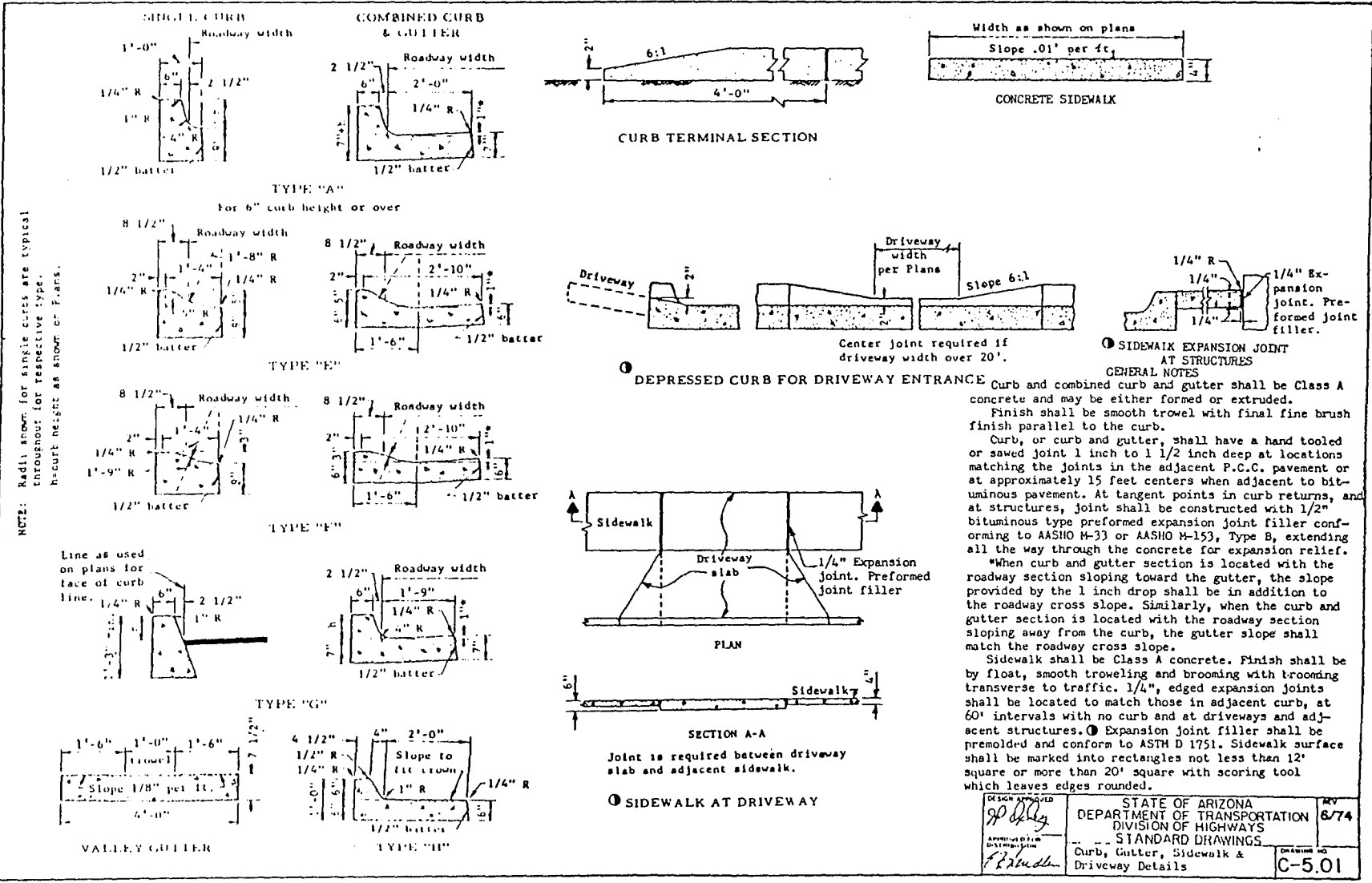

NOTE: Radii shown for single curbs are typical throughout for respective type. In-curb height as shown on Plans.

Line as used on plans for face of curb line.

DESIGN APPROVED <i>[Signature]</i>	STATE OF ARIZONA DEPARTMENT OF TRANSPORTATION DIVISION OF HIGHWAYS	REV 6/74
APPROVED FOR CONSTRUCTION <i>[Signature]</i>	STANDARD DRAWINGS Curb, Gutter, Sidewalk & Driveway Details	DRAWING NO. C-5.01

A-26

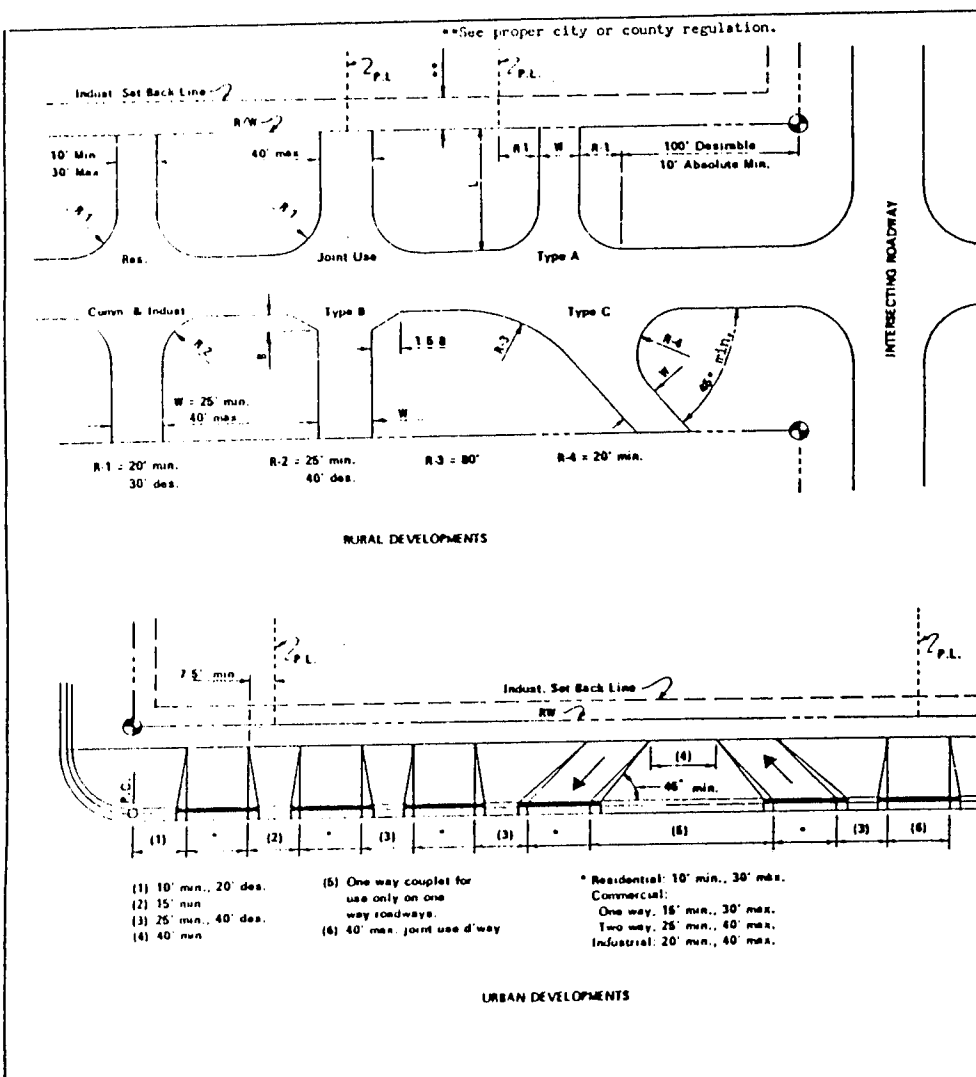

GENERAL NOTES

Paved Turnouts: Plans notation will be WxL, surface material, type and standard.
 Example: 20' X 30' A.C.T.O., Type A, Standard C-6. 01. Show R graphically.
 Base material shall be the same as what shown for main roadway, unless otherwise noted.
 Excavation or embankment for turnouts shall be included in quantities for main roadways.
 Dimensions indicated as minimum shall be avoided whenever possible in favor of those indicated as desirable.

Driveways and depressed curbs shall be located as noted on plans or as directed by the Engineer.

The Type "A" turnout is the preferable turnout design. Type "B" and "C" shall only be used when absolutely necessary.

Driveway Types:
 Residential - one providing access to a single family residence, to a duplex, or to an apartment building containing five or fewer dwelling units.
 Commercial - one providing access to an office, retail or institutional building or to an apartment building having more than five dwelling units.
 Industrial - one directly serving a substantial number of truck movements to and from loading docks of an industrial facility, warehouse or truck terminal.

Driveways for high volume traffic generators shall be approved individually by Traffic Engineering Section.

Driveways with curb returns in urban areas shall be installed only with the approval of Traffic Engineering Section.

Joint Use Driveways - it may become desirable for landowners of adjacent properties to require a joint driveway to service both properties. If this is the case, only one of the two adjacent landowners need apply for the access permit, but a notarized written mutual agreement, signed by all parties involved, must accompany the application form.

Construction of curb, gutter and sidewalk in urban areas by the permittee, along that portion of the highway frontage under permit application, may be a stipulation of the permit approval if there appears to be reasonable need.

Drainage structures shall be provided under driveways where necessary.

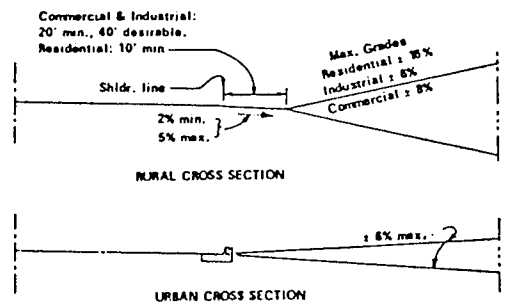

DESIGN APPROVED <i>[Signature]</i>	STATE OF ARIZONA DEPARTMENT OF TRANSPORTATION DIVISION OF HIGHWAYS STANDARD DRAWINGS	REV 6/74 11/74
APPROVED FOR DISTRIBUTION <i>[Signature]</i>	TURNOUT & DRIVEWAY LAYOUT	DRAWING NO C-6.01

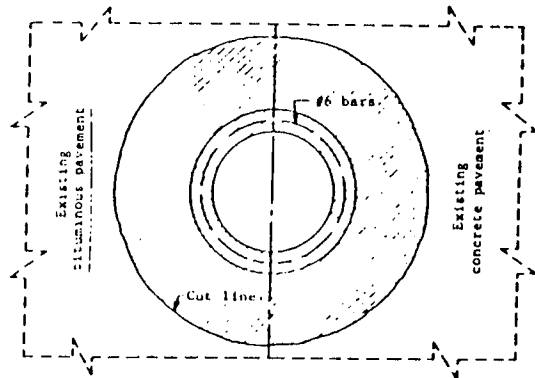

PLAN

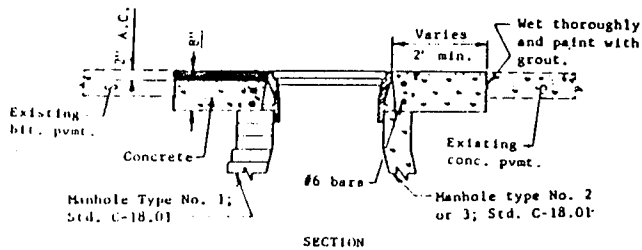

SECTION

PAVEMENT CUT REPLACEMENT FOR MANHOLE

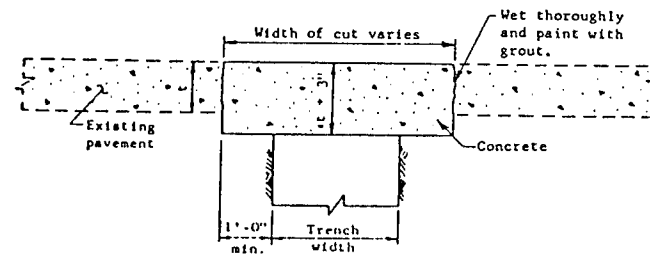

CUT IN CONCRETE PAVEMENT

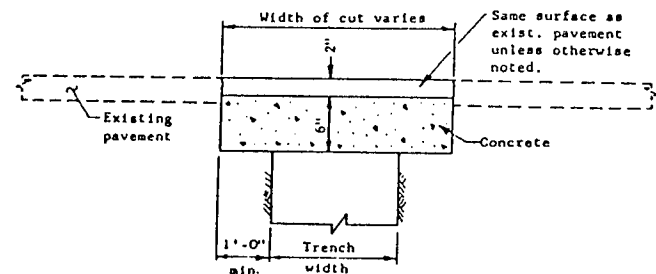

CUT IN BITUMINOUS PAVEMENT

GENERAL NOTES
All concrete shall be Class A.

DESIGN APPROVED <i>Wally</i>	STATE OF ARIZONA DEPARTMENT OF TRANSPORTATION DIVISION OF HIGHWAYS STANDARD DRAWINGS	REV 6/74
APPROVED FOR DISTRIBUTION <i>F. Jones</i>	PAVEMENT, CUT & REPLACEMENT	DRAWING NO. C-7.03

ARIZONA DEPARTMENT OF TRANSPORTATION CROSSING UNDER PAVEMENT

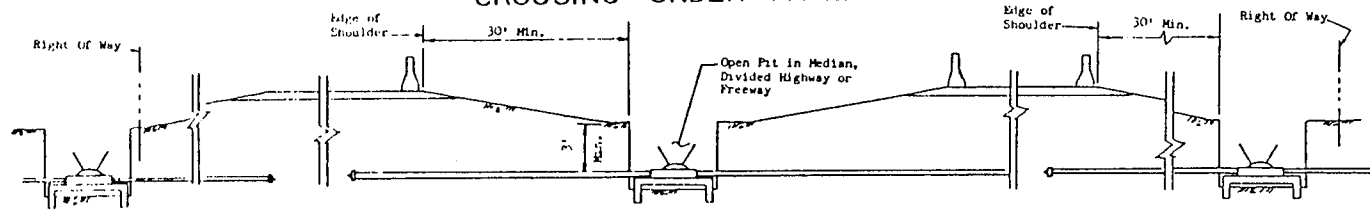

METHOD 1

JACKING ON DORING UNDER ROADWAY

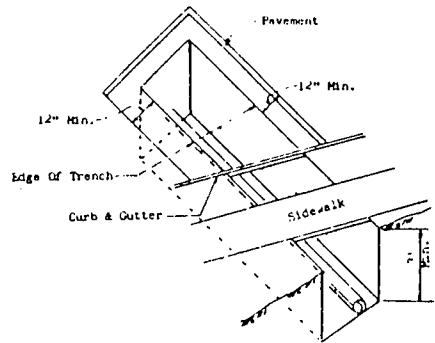

METHOD 2

CUT THROUGH THROUGH ASPHALT PAVEMENT
OR CONCRETE PAVEMENT

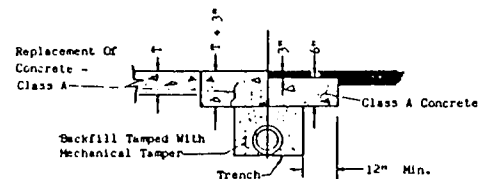

PERMANENT PAVEMENT CUT REPLACEMENT

OPEN TRENCH THROUGH ASPHALTIC CONCRETE OR CONCRETE

All backfill material must be covered immediately with at least 3" of asphaltic concrete mix and maintained to street level until permanent pavement replacement is constructed.

Concrete - Class "A"

- Replacement - Asphaltic concrete
- Finished by - Approved concrete or asphaltic concrete finisher
- Surplus earth - To be disposed of outside R/W

NOTE:
Where communications cable is placed parallel to Centerline and within five (5) feet of the highway right-of-way line, the depth shall not be less than thirty (30) inches.

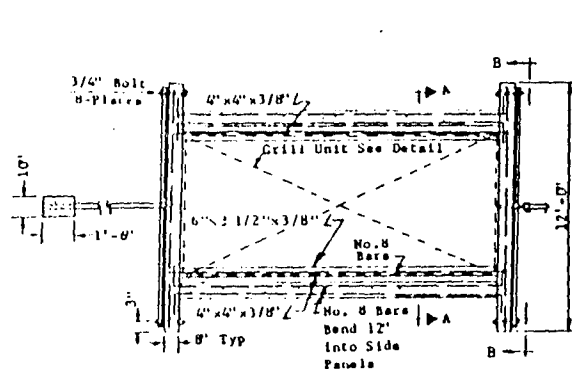

PLAN

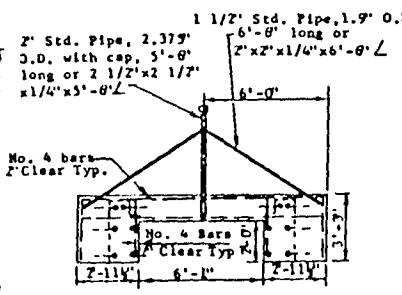

SECTION B-B
Typical Both Ends

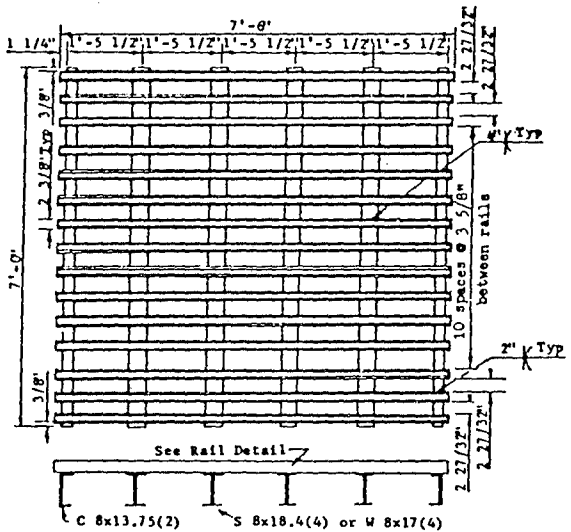

GRILL UNIT DETAIL

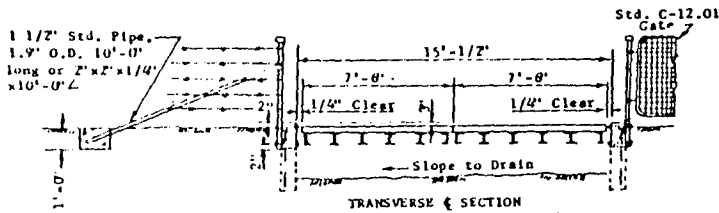

TRANSVERSE SECTION
(2- Unit Installation Shown)

Rdvy. Width	Grill Units Required
20'	4
28'	5
34'	6
36'	6
38'	7
40'	7

WIDTH TABLE

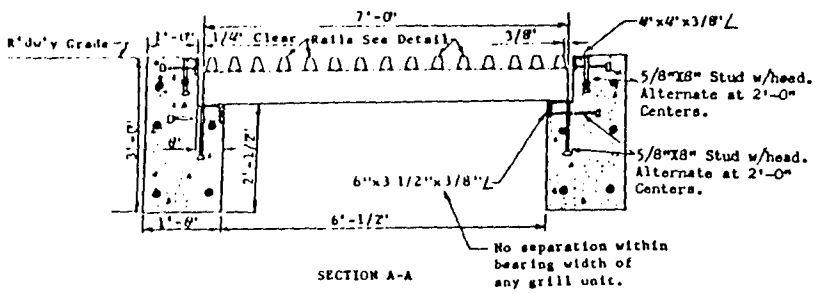

SECTION A-A

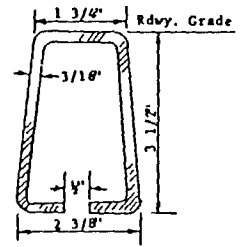

RAIL DETAIL

GENERAL NOTES

All concrete shall be Class A. Round exposed concrete corners of concrete side sections only.

All structural steel, posts, and braces shall be in accordance with the specifications.

All exposed structural steel, posts and braces shall be given one coat of No. 1 paint.

Cattle Guard may be constructed with or without gate. See Plans. Cattle Guard width shall be specified in number of grill units. See table.

DESIGN APPROVED <i>[Signature]</i>	STATE OF ARIZONA	REV 6/74 11/74
	DEPARTMENT OF TRANSPORTATION DIVISION OF HIGHWAYS	
DATE PREPARED 11/74 <i>[Signature]</i>	STANDARD DRAWINGS CATTLE GUARD, ROADWAY	DRAWING NO. C-11.01

A-30

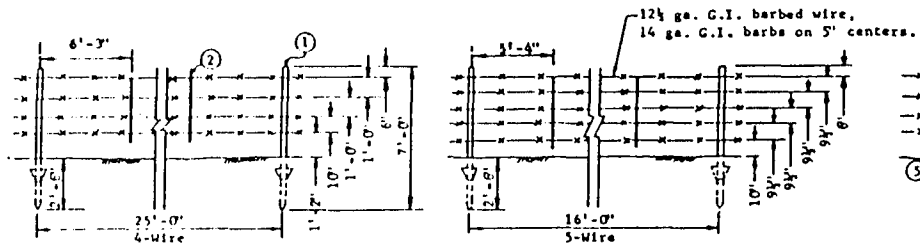

LINE PANELS

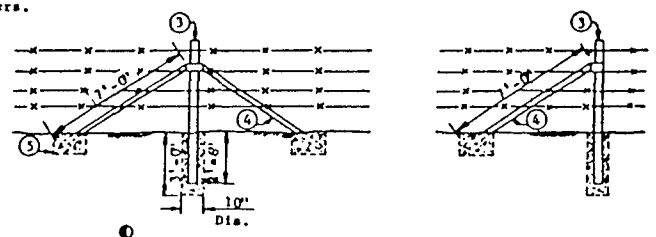

STRAIN POST
To be spaced at 650' max. intervals

BRACE POST

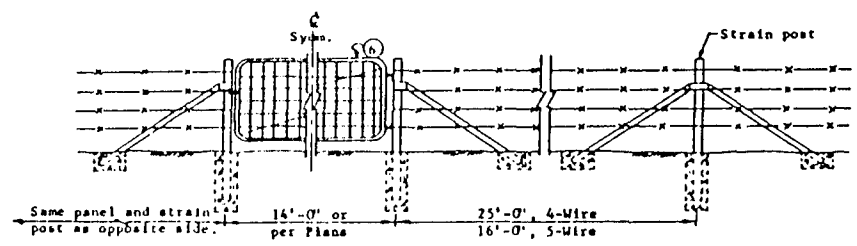

NO. 1 GATE

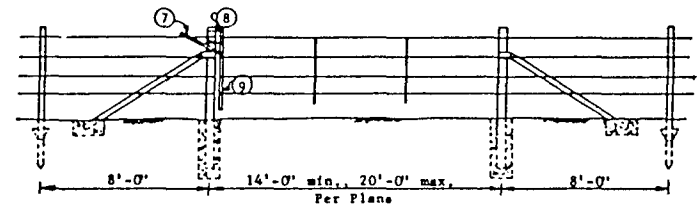

NO. 2 GATE

GENERAL NOTES

Posts and braces shall be green in color. Posts may have white tops. Wood parts of No. 2 gate shall be unpainted.

When line post anchors are omitted or post hole is drilled, posts shall be set in concrete.

On curves, the fence shall be so constructed that the wire tension is against the post and not against the wire ties.

A maximum of two splices is permitted between strain posts but not on the same wire. No splice shall be placed less than 100' from a strain, corner or gate post.

Concrete shall conform to the requirements of the specifications

Tolerance on distance between ground and bottom wire at any point equals ±4"

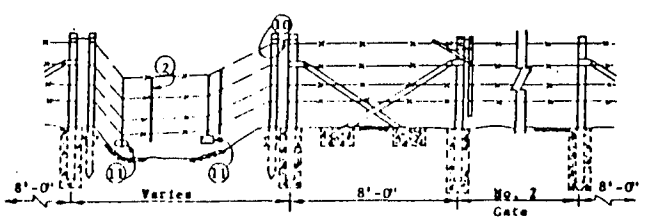

FLOOD GATE

① Strain posts with braces shall be installed at all corners, angles exceeding 15° and fence intersections. There shall be a brace from the post to the ground in each fence panel attached to the strain post. The first line post from each strain post shall be installed at a maximum distance of 8 ft.

- ① Line Post. "T", "U", "Rail", "Hat" or similar production section. Wt., exclusive of anchor, 1.3lb/ft. min. Shall be punched, knobbed or corrugated to hold wire firmly. Wire ties shall be 11 ga. galv. wire min.
- ② 9 1/2 ga., galv., twisted wire stays, 42" long. Space at 5'-4" & 6'-3" int. for 5 & 4 wire fence respectively.
- ③ 2" nom. dia. pipe or 2 1/2" x 2 1/2" x 1/2" L
- ④ 1 1/2" nom. dia. pipe or 2" x 2" x 1/2" L
- ⑤ 1'-0" x 1'-0" x 1'-0" conc. footing.
- ⑥ 1 3/8" Ø tubing, 2-Vertical braces, 1-adjustable diagonal guy. Mesh shape optional with min. 11 ga. line wires and 12 1/2 ga. cross wires. Fully galv.
- ⑦ 2" x 2" x 2' pry stick. D.F. constr. grade.
- ⑧ Double loops of 9 ga. galv. wire. Top & bottom.
- ⑨ 2" x 2" x 4'-0" D.F. constr. grade.
- ⑩ Single loop, 9 ga. galv. wire.
- ⑪ 30-35 lb. stone sag wt. As alternate, use 7 1/2" x 7 1/2" x 7 1/2" conc. cube with cast in doubled and twisted 9 ga. wire loop hanger.

DESIGN APPROVED <i>[Signature]</i>	STATE OF ARIZONA DEPARTMENT OF TRANSPORTATION DIVISION OF HIGHWAYS STANDARD DRAWINGS	REV 6/74 11/74
APPROVED BY THE DISTRICT ENGINEER <i>[Signature]</i>	FENCE & GATES, LINE, STEEL POSTS	DRAWING NO C-12.01

A-31

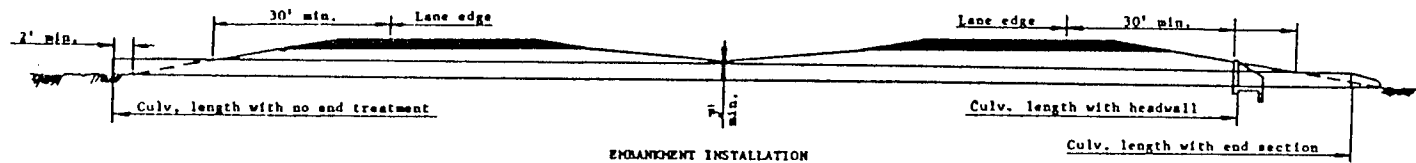

EMBANKMENT INSTALLATION
Divided Hwy. - 2 Way Rdwy. Similar

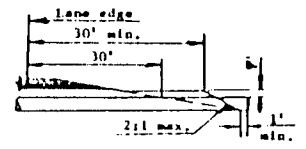

BERM
Not required when pipe projection is protected by guard rail

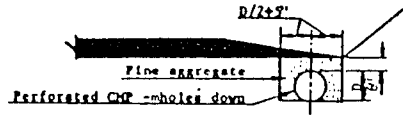
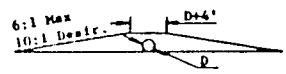

PERFORATED CMP INSTALLATION

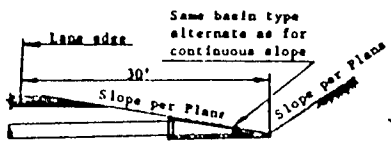

Sag Location



Continuous Slope Location

TRAFFIC - SAFE CUT DITCH INSTALLATION

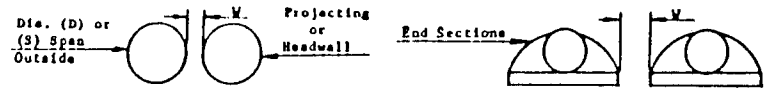

Dia. or Span	W		
	Projecting	Headwall	End Sections
12" - 24"	12"	12"	12"
30" - 60"	(D or S)/2	(D or S)/2	12"
72" & Over	30"	36"	12"

MINIMUM SPACING FOR MULTIPLE INSTALLATIONS

GENERAL NOTES
Any required inlet and/or outlet protection shall be as called for on plans.
See also: C-14.00 and remaining C-13.00 series standards.

DESIGN APPROVED <i>M. A. Key</i>	STATE OF ARIZONA DEPARTMENT OF TRANSPORTATION DIVISION OF HIGHWAYS STANDARD DRAWINGS	NO. 8774
APPROVED FOR CONSTRUCTION <i>E. J. Smith</i>	PIPE CULVERT INSTALLATION	DRAWING NO. C-13.01

EXHIBIT 8

A-32

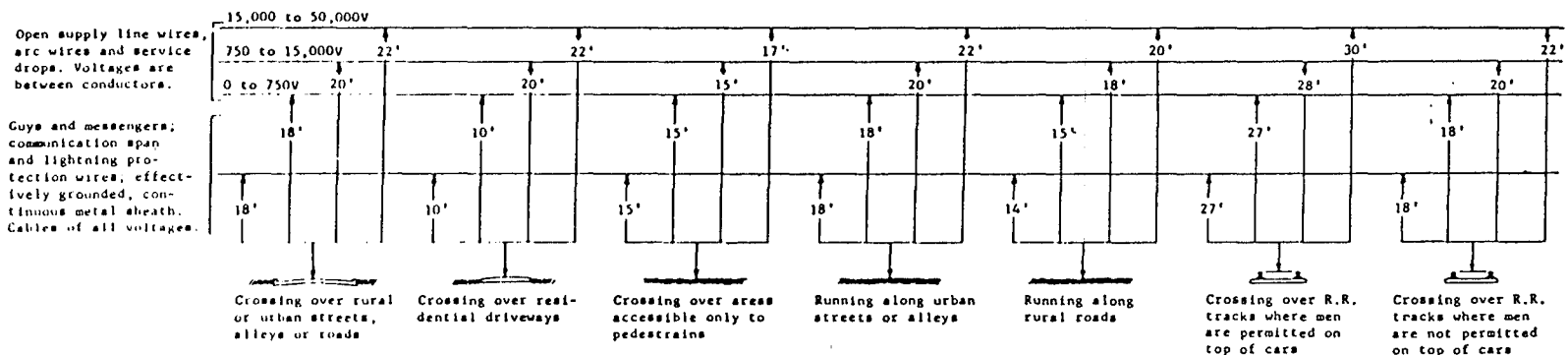

* BASIC MINIMUM GROUND AND RAILROAD RAIL VERTICAL CLEARANCES

- * Increase basic minimums:
 - 1/2" for each 1000 V over 50,000 V
 - 6" over ground for each 50' of span over 350' - light or medium loading
 - 9" over rails for each 50' of span over 350' - light loading
 - 18" over rails for each 50' of span over 350' - medium loading

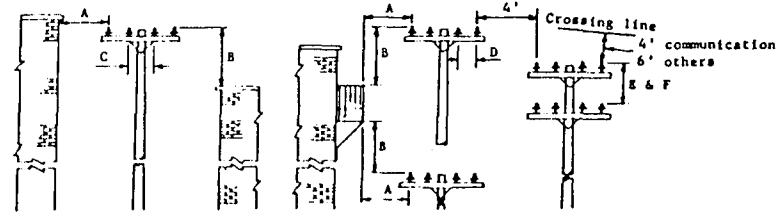

Line Description	A	B	C	D	E	F
Open supply line wires and service drops	3'	8'	18"	12"	2'	4'
Guys and messengers; communication, span and lightning protection wires; effectively grounded, continuous metal sheath. Cables of all voltages.	-	-	2'	6"	2'	4'

- A = Horizontal clearance to buildings and other structures.
- B = Vertical clearance to buildings and other structures.
- C = Climbing space at pole.
- D = Clearance between parallel conductors on same cross arm.
- E = Vertical cross arm separation - same utility.
- F = Vertical cross arm separation - different utilities.

** BASIC MINIMUM STRUCTURE AND LINE CLEARANCES

- ** Increase basic minimums A and B:
 - 6" for each 50' of span over 150' for 8700 V to 50,000 V
 - 1/2" for each 1000 V over 50,000, + 10"
- Increase basic minimum D:
 - 0.4" for each 1000V over 7500V

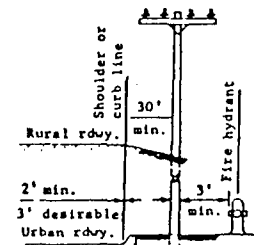

Pole Height	DEPTH OF POLE SETTINGS			
	Soft Ground		Solid Ground	
	Straight Line	Corner	Straight Line	Corner
20'	5'	5'	5'	5'
25'	5 1/2'	6'	5'	5 1/2'
30'	6'	6 1/2'	5 1/2'	6'
35'	6 1/2'	7'	6'	6 1/2'
40'	7'	7 1/2'	6 1/2'	7'
45'	7'	7 1/2'	6 1/2'	7'
50'	7 1/2'	8'	7'	7 1/2'
55'	8'	8 1/2'	7 1/2'	8'
60'	8 1/2'	9'	8'	8 1/2'
65'	9'	9 1/2'	8 1/2'	9'

POLE CLEARANCE AND DEPTH SETTING DATA

GENERAL NOTES

This Standard represents excerpts from "Safety Rules for Installation and Maintenance of Electrical Supply and Communication Lines", Dept. of Commerce, Bureau of Stds. Handbook No. 81, reprint of May 1, 1966 (approved by Ariz. State Industrial Comm.) and is to be considered as a guide only. The applicable standards established by the governing bodies and commissions shall be considered the final control.

ARIZONA DEPARTMENT OF TRANSPORTATION HIGHWAYS DIVISION STANDARD PLANS		Rev
MINIMUM CLEARANCES FOR UTILITY LINES & POLES AS RELATED TO HIGHWAYS		
Drawn	D.C. 2-68	Drawing No.
Traced	D.C. 8-68	
Checked	J.F.O. 9/10 1/72	UR-1.00
Approved Engr. Plans	<i>J.P. Dels</i> 4/72	

from one such tract to the other either at grade or below or above grade at least once within one mile if there is a demand made for such crossing by the landowner, or he must compensate such landowner for any legally compensable damages sustained by any such severance as provided by law, but the compensable damage shall in no case be less than the difference in value caused by the severance. No such connecting roads shall be used for or in connection with the conduct of any roadside business or enterprise. If such tracts at any time cease to be held under one ownership, the chief engineer may terminate and discontinue such access roads.

(3) No commercial enterprise or activity for serving motorists, other than emergency services for disabled vehicles, shall be conducted or authorized on any property designated as or acquired for or in connection with a freeway or highway by the state department of highways, or any other governmental agency. At locations deemed appropriate by the state highway commission, the state department of highways shall construct local service roads, which open into or connect with a freeway, in such manner as to facilitate the establishment and operation of competitive commercial enterprises for serving users of the freeway on private property abutting such local service roads.

43-3-102. Engineer to divide freeway. (1) After such state highway or a portion of a state highway has been designated a freeway under section 43-3-101, the chief engineer is authorized to divide and separate such freeway into separate roadways by the construction of raised curbing, central dividing sections, or other physical separations or by designating such separate roadways by signs, markers, stripes, or other devices and may direct the course of traffic thereon and the proper lane for such traffic by appropriate signs, markers, stripes, or other devices.

(2) No private right of access shall accrue to property abutting any freeway established on a new location except at such points as may be authorized; but nothing in this section shall authorize or permit the acquisition of any existing property rights except upon payment of just compensation as provided by law.

43-3-103. Engineer may close street or road. The chief engineer, with the approval of the governor, is authorized to enter into agreements with the cities or towns having jurisdiction over city or town streets, or with the counties having jurisdiction over county highways, or with other authorities having jurisdiction over other public ways to close any city street or county highway or other public way at or near the point of its intersection with any such freeway or to make provisions for carrying such city street or county highway or other public way over or under or to a connection

ARKANSAS

- Examples



VENDING MACHINE AGREEMENT
WITH
ARKANSAS SERVICES FOR THE BLIND
A DIVISION OF THE DEPARTMENT OF HUMAN SERVICES

THIS AGREEMENT, made this 29th day of October, A.D. 19 86, by and between the Arkansas State Highway and Transportation Department, hereinafter referred to as the "Highway Department", and the Arkansas Services for the Blind, a Division of the Department of Human Services, hereinafter referred to as the "Services for the Blind", shall cover a three year pilot project to determine the feasibility of operating vending machines in highway rest areas.

WITNESSETH

WHEREAS, Section 111 of the Federal Surface Transportation Assistance Act of 1982 provides authority for the State Highway Department to permit the placement of vending machines in rest areas located on Interstate Highway Systems and further provides that priority be given to Services for the Blind for the operation of such vending machines; and

WHEREAS, Services for the Blind desires to implement the provisions of Section 111 and proposes to contract with commercial firms for the installation and operation of vending machines in six rest areas located as follows:

Crittenden County on I-40 at West Memphis

Crawford County on I-40 at Dora

Hot Spring County on I-30 at Social Hill

Miller County on I-30 at Texarkana

Mississippi County on I-55 at Blytheville

Prairie County on I-40 at White River

WHEREAS, having determined that the vending machine operations proposed by Services for the Blind are in the public interest and that such operations will not adversely affect the safety, maintenance or utilization of any highway facility, the Highway Department hereby approves the establishment of these vending machine operations in accordance with the terms and conditions set forth in this Agreement.

AGREEMENT

NOW THEREFORE, in consideration of the premises and of the mutual covenants and agreements of the parties hereto to be by them respectively kept and performed as hereinafter set forth, it is agreed as follows:

1. Services for the Blind shall cause the installation and operation of vending machine facilities on these highway rest areas to be carried out without a direct or indirect cost to the Highway Department.
2. Nothing in this Agreement shall be construed as a relinquishment by the Highway Department of any authority or control over all activities occurring within the rest areas.
3. Services for the Blind shall require any commercial firm or individual engaged to install or operate vending machine facilities in highway rest areas to obtain the minimum insurance coverages as specified below and to keep such coverages in force for the duration of any such engagement by Services for the Blind:

A. Worker's Compensation

Amount - Statutory

B. Comprehensive General Liability Insurance

Amount - Bodily Injury \$500,000 each occurrence
- Property Damage \$100,000 each occurrence
 \$100,000 aggregate

C. Comprehensive Automobile Liability Insurance

Amounts - Bodily Injury \$250,000 each person
 \$500,000 each occurrence
- Property Damage \$100,000 each occurrence

- D. Both Services for the Blind and the Highway Department shall be named as an "Additional Insured" by endorsement to policies issued for coverages listed in B and C above.

- E. Services for the Blind shall require the submission of a Certificate of Insurance to show compliance with the above insurance requirements and shall require the filing of a copy of this certificate with the Highway Department before any installations or operations are begun at a rest area location.
4. In accordance with Section 111 of the Federal Surface Transportation Assistance Act of 1982, the Highway Department shall be the final authority on the appropriateness and desirability of the food, drink or other articles to be dispensed from vending machines in the rest areas. Items proposed to be dispensed shall have the written approval of the Highway Department.
 5. Contracts proposed by Services for the Blind which involve operations in rest areas shall be reviewed and approved in writing by the Highway Department prior to their execution with private business firms. The scope and design of vending machine facilities proposed by Services for the Blind for each rest area shall be reviewed and approved in writing by the Highway Department, including the location of such facilities in each individual rest area. Connecting points for utility services for vending machines and the design and location of utility wiring and piping within each rest area shall be as approved in writing by the Highway Department.
Any future revisions or additions to an initial vending machine facility shall be made after prior written approval of the Highway Department.
 6. This Agreement shall remain in effect for a period of three (3) years after the date appearing hereon, unless cancelled sooner, by serving written notice, by the Highway Department on the Services for the Blind, for unsatisfactory performance.
Within sixty (60) days after the cancellation of this Agreement, Services for the Blind shall cause the rest

Areas to be cleared of all vending machine facilities and the occupied areas to be restored to conditions satisfactory to the Highway Department.

7. Inasmuch as the proposed vending machine operations will occur on the Federal-aid Highway System, the nondiscrimination provisions of the Federal Highway Administration's Federal-aid Highway Program Manual, FHPM 6-2-5-1, paragraph 9c(6), are hereby made a part of this Agreement by reference and shall apply to the installation, operation and maintenance of vending machines located on Interstate Highway rest areas.

IN WITNESS WHEREOF, the parties hereto, acting under authority of their respective governing bodies, have caused this Agreement to be duly executed as to the day and year indicated.

ARKANSAS SERVICES FOR THE BLIND,
A DIVISION OF THE DEPARTMENT OF
HUMAN SERVICES

THE ARKANSAS STATE HIGHWAY AND
TRANSPORTATION DEPARTMENT

Certified as being executed for the purpose and effect of activating and/or carrying out the orders, established policies or work programs heretofore approved and authorized by the Arkansas State Highway and Transportation Department.

BY: _____

Commissioner
James C. Hudson

BY: _____

Director

DATE: _____

October 25, 1996

CALIFORNIA

- Legislation

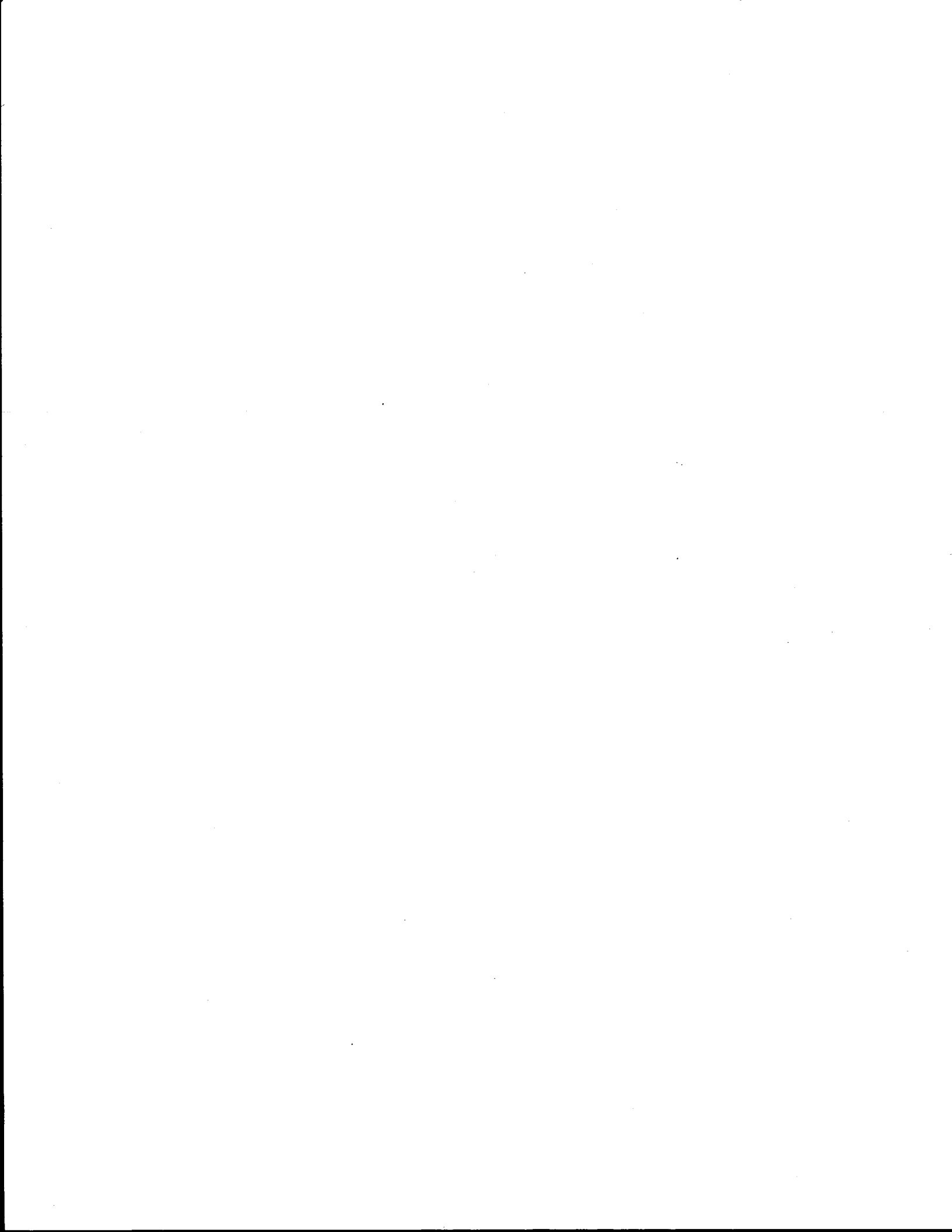

CALIFORNIA

SB 1438

— 2 —

The people of the State of California do enact as follows:

1 SECTION 1. Section 220.5 of the Streets and
2 Highways Code is amended to read:
3 220.5. (a) The department ~~may~~ shall authorize the
4 placement of vending machines in safety roadside rests,
5 unless prohibited by federal laws, rules, or regulations.
6 (b) Subject to Section 19625 of the Welfare and
7 Institutions Code, the department shall authorize the
8 Department of Rehabilitation, through the Business
9 Enterprise Program for the Blind, to establish vending
10 machine service in those safety roadside rests which are
11 authorized to have vending machines under subdivision
12 (a). Ten percent of the gross income from vending
13 machines placed in a safety roadside rest pursuant to this
14 subdivision shall be paid to the department and used for
15 the maintenance, utilities, and cleanup related to the
16 vending machine operations.
17 (c) Any money received by the state for authorizing
18 the placement of ~~such~~, or from the income from, the
19 vending machines shall be transferred by the department
20 to the State Highway Account in the State Transportation
21 Fund.

(3) The bill would declare that it is to take effect immediately as an urgency statute.

The people of the State of California do enact as follows:

SECTION 1. Section 35 is added to the Streets and Highways Code, to read:

35. "Vista point" means any signed roadside area on the state highway system developed and maintained by the department for the purpose of providing the motorist with a place to stop to view the scenic panorama or points of visual interest.

SEC. 2. Section 225.5 is added to the Streets and Highways Code, to read:

225.5. (a) Notwithstanding Section 22520.5 or 22520.6 of the Vehicle Code, and except as specifically authorized by this article, no person shall display, sell, offer for sale, or otherwise vend or attempt to vend any merchandise, foodstuff, or service within any vista point or safety roadside rest area.

(b) When requested by a uniformed member of the Department of the California Highway Patrol, or other peace officer, any person or persons and any property may be relocated to a specified area of a vista point or rest area, or may be required to quit the premises, as directed by that officer, if, in the opinion of the officer, the person's presence or activity or the presence of the property, creates, or may reasonably be expected to create, a safety problem or hazard, either on or near the vista point or safety roadside rest area.

(c) To the extent the provisions of any regulations adopted by the department conflict with this section, those provisions are void, and permission given pursuant to those provisions for a person to engage in activities prohibited by subdivision (a) of this section is revoked.

SEC. 3. No reimbursement is required by this act pursuant to Section 6 of Article XIII B of the California Constitution because the only costs which may be incurred by a local agency or school district will be incurred because this act creates a new crime or infraction, changes the definition of a crime or infraction,

Damage to Trees

730.5. Any person who by any means wilfully or maliciously digs up, cuts down, destroys or otherwise injures any shade or ornamental tree on any state highway shall be liable to a penalty in the sum of one hundred dollars (\$100) for each such tree so damaged; and the department, in the name of the people of the State of California, may recover such penalty in an action at law, in a court of competent jurisdiction, together with the costs and expenses incurred in such action.

Vending Within Highway Right-of-Way

731. Any vehicle or structure parked or placed wholly or partly within any state highway, for the purpose of selling the same or of selling therefrom or therein any article, service or thing, is a public nuisance and the department may immediately remove such vehicle or structure from within any such highway.

Any person parking any such vehicle or placing any such structure wholly or partly within any such highway for the purpose of selling such vehicle or structure, or of selling therefrom or therein, any article or thing, and any person selling, displaying for sale, or offering for sale any article or thing either in or from any such vehicle or structure so parked or placed, and any person storing, servicing, repairing or otherwise working upon any such vehicle, other than upon a vehicle which is temporarily disabled, is guilty of a misdemeanor.

The California Highway Patrol and all peace officers may enforce the provisions of this chapter and shall co-operate with the department to that end. Whenever any member of the California Highway Patrol or any peace officer removes a vehicle from a highway under the provisions of this section, then all of the provisions of Article 3 (commencing with Section 22850), Chapter 10, Division 11 of the Vehicle Code with reference to the removal of a vehicle from a highway shall be applicable.

The provisions of this section shall not prohibit a seller from taking orders or delivering any commodity from a vehicle on that part of any state highway immediately adjacent to the premises of the purchaser; nor shall the provisions of this section prohibit an owner or operator of a vehicle, or a mechanic, from servicing, repairing or otherwise working upon any vehicle which is temporarily disabled in such a manner and to such an extent that it is impossible to avoid stopping such vehicle within such highway.

Boundary and Survey Stakes

732. Any person who wilfully injures, defaces, breaks down or removes any monument or stake placed, erected or used by the department to designate any point in the boundary or survey of any State highway or proposed State highway is guilty of a misdemeanor.

Disposition of Recoveries

733. All money recovered under the provisions of this chapter shall be paid into any fund which is available to the department for highway purposes and is designated by the department to receive such payment.

Procedure Not Exclusive

734. The procedure provided in this article is not exclusive and shall not prohibit the department from exercising any other remedy provided by law to prevent damage to or to protect any State highway.

Article 4. Protection of Beds of Mapped Highways***Definitions***

740. As used in this article:

Vending Machines

220.5. The department may authorize the placement of vending machines in safety roadside rests, unless prohibited by federal laws, rules, or regulations.

Any money received by the state for authorizing the placement of such vending machines shall be transferred by the department to the State Highway Account in the State Transportation Fund.

May Accept Grants

222. The department may accept grants on behalf of the State and may accept financial or other assistance for, or in aid of, safety roadside rests.

May Contract With Others

223. The department may contract with other governmental agencies or private organizations or individuals for the construction and operation of traveler service information facilities and for the maintenance of all or any of such safety roadside rests where it deems it necessary or desirable.

Penalties

224. It shall be unlawful for any person to throw or deposit any substance in a safety roadside rest other than in a receptacle provided for that purpose. It shall be unlawful for any person to deposit in the receptacles provided for refuse in a safety roadside rest any refuse or waste from homes, farms, or commercial establishments, or other material which does not arise out of the use of the safety roadside rest by a member of the traveling public. The violation of this section shall be a misdemeanor punishable as provided in Section 42002 of the Vehicle Code, and all of the provisions of Chapter 2 (commencing at Section 40300) of Division 17 of the Vehicle Code shall apply to an offense committed under this section the same as if such offense were made an offense by the Vehicle Code.

Rules and Regulations

225. (a) The department may enact rules and regulations governing the time and manner of use of safety roadside rests, and all state laws and rules and regulations of the department shall be administered and enforced within the safety roadside rests by all employees of the state authorized by the department to do so and by all peace officers.

(b) No person shall engage in any activity within a safety roadside rest area or vista point prohibited by rules and regulations adopted pursuant to this section.

(c) A violation of subdivision (b) is an infraction. A second or subsequent conviction of a violation of subdivision (b) is a misdemeanor.

Part of Right-of-Way

226. Areas comprising such safety roadside rests shall be deemed a part of the state highway right-of-way for all purposes, including those set forth in Section 731.

Demonstration Joint Economic Development Rest Areas

227. (a) Unless prohibited by federal law or regulation, the department, to promote public safety and convenience, may construct, operate, and maintain a maximum of six new safety roadside rest area units as a joint economic development demonstration project where there is a public need for a rest area, and the joint economic development proposal will result in an economic savings to the state.

(b) All of the following apply to the demonstration project safety roadside rest area units:

1. Contracts for construction, operation, and maintenance of facilities in the demonstration project roadside rest areas shall be awarded on the basis of competitive bidding.

(2) The department may permit commercial operations within the units if the operations are traveler-related activities and no alcoholic beverages are sold within the rest area facility.

(3) Law enforcement responsibilities within the units are the same as are currently provided on the state highway system.

(4) The department shall submit a status report to the Assembly Committee on Transportation and the Senate Committee on Transportation one year following construction of the initial unit and annually thereafter.

(5) The department holds, or affords the opportunity for, a public hearing for each proposed unit so that local community members who may be affected by rest area economic development and other interested parties may comment on the proposed project.

(c) Any money received by the state for the demonstration project shall be deposited by the department in the State Highway Account.

CHAPTER 2. THE STATE HIGHWAY SYSTEM

Article 1. General Provisions

State Highways Described

230. The highways described in this chapter are State highways.

"Route" Defined

231. As used in this chapter, "route" means State highway route and the route numbers are those given the State highway routes or portions thereof by the commission. Each complete route is described in Article 3 of this chapter.

Title Vested in People

233. All title acquired by the public or by any governmental agency to any real property, or interests therein, used for rights of way of any highway heretofore or hereafter constituted a State highway is vested in the name of the people of the State of California.

Article 2. The California Freeway and Expressway System

Statewide System of Freeways and Expressways

250. It is hereby declared to be essential to the future development of the State of California to establish and construct a statewide system of freeways and expressways and connections thereto without regard to present jurisdiction over the highways, roads, and streets that might be included. It is the intent, further, that the California Freeway and Expressway System be completed with provision for control of access to the extent necessary to preserve the value and utility of the facilities to be constructed.

Deficiencies on Highways Not Included to Be Corrected Simultaneously

251. It is further declared to be essential to the future development of the State of California that the deficiencies on the State Highway System not a part of the California Freeway and Expressway System and deficiencies on connections to the State Highway System be corrected simultaneously with the highways in the California Freeway and Expressway System in proportion to the relative deficiencies and the needs of traffic service.

CONNECTICUT

- Legislation
- Rules



affecting transportation in the state; (3) request and receive from any agency or other unit of the government of the state or of any political subdivision thereof, or from any public authority, such assistance and data as may be necessary to enable the commissioner to carry out his responsibilities under this section; (4) to the extent he may deem appropriate, make use of, and incorporate in the plan, any existing long-range transportation plan, survey or report developed by any public or private agency or person; and (5) employ consultants.

(e) Copies of the plan, as revised, shall be kept on file as a public document in the office of the commissioner.

(1969, P.A. 768, S. 17; P.A. 73-451, S. 2, 3; P.A. 79-23; 79-449, S. 5, 7.)

History: P.A. 73-451 revised Subsec. (a) by deleting all four subdivisions and the material containing specific references to a new major airport, the long-range highway plan and material prepared by the Connecticut Transportation Authority and substituting general reference to reports and studies prepared under the Connecticut interregional planning program relating to planning and development and material relating to transportation prepared by any agency of the state and transferred to new Subsec. (c) the reporting requirement, provided for specifics of the plan in new Subsec. (b) and in former Subsec. (b), relettered as Subsec. (d), authorized employment of consultants; P.A. 79-23 added in Subsec. (b)(2) consideration of "federal air quality standards, conservation and cost of energy supplies and further added requirement in new Subdiv. (4) that priorities for next one, two and five-year periods by need and by fiscal capability in the area of public transportation be indicated and provided in Subsec. (c) for submission to the general assembly as well as to the governor on or before January tenth; P.A. 79-449 added "energy impact" in Subsec. (b)(2).

Cited. 35 CS 157, 176.

Sec. 13b-16. Study of existing transportation facilities. (a) On or before September first annually, the commissioner shall conduct and complete an investigation and study of the several modes of transportation in the state, in which he shall evaluate the adequacy of the facilities and services connected with each such mode, and shall determine the needs of the state transportation system. The commissioner shall consult with the Connecticut Public Transportation Commission which shall advise the commissioner in matters pertaining to rail and motor carrier facilities and services. The studies shall be used in the annual revision of the comprehensive long-range master transportation plan.

(b) The commissioner may engage in experimental projects relating to any available or future mode of transportation, including but not limited to, high speed rail service, the development of heliports and any means of improving existing transportation facilities and services. The commissioner may be assisted by the commission referred to in subsection (a) of this section in connection with any such project.

(1969, P.A. 768, S. 18; 1972, P.A. 134, S. 1; 238, S. 1; P.A. 75-572, S. 3, 5; P.A. 83-487, S. 3, 33.)

History: 1972 acts deleted in Subsec. (a) "the Connecticut aeronautics commission", "aeronautics", "the steamship terminals commission" and "harbors and harbor facilities" where they appear; P.A. 75-572 inserted in Subsec. (a) the word "public" in "Connecticut Transportation Authority" before the word "transportation"; P.A. 83-487 amended section to reflect change in structure and name of Connecticut Public Transportation Authority.

Sec. 13b-17. Regulations re conduct of business. Delegation of duties and responsibilities. Regulations re permit fees. (a) The commissioner may issue rules and regulations for the efficient conduct of the business of the department. The commissioner may delegate (1) to the deputy commissioner of transportation any of his duties and responsibilities; (2) to the deputy commissioner for an operating bureau any of his duties and responsibilities which relate to the functions to be performed by that bureau; (3) to the Connecticut Public Transportation Commission any of his duties and responsibilities which relate to the functions to be performed by the commission; and (4) to other officers, employees and agents of the department any of his duties and responsibilities

that the commissioner deems appropriate, to be exercised under his supervision and direction.

(b) The commissioner may adopt regulations in accordance with the provisions of chapter 54 establishing reasonable fees for any application submitted to the department of transportation or the state traffic commission for (1) a state highway right-of-way encroachment permit or (2) a certificate of operation for an open air theater, shopping center or other development generating large volumes of traffic pursuant to sections 14-311 and 14-311a; provided the fees so established shall not exceed one hundred twenty-five per cent of the estimated administrative costs related to such applications. The commissioner may exempt municipalities from any fees imposed pursuant to this subsection.

(1969, P.A. 768, S. 12; 1972, P.A. 134, S. 2; 238, S. 2; P.A. 75-572, S. 4, 5; P.A. 82-341; P.A. 83-487, S. 4, 33; P.A. 84-546, S. 35, 173.)

History: 1972 acts deleted the Connecticut aeronautics commission and the steamship terminals commission from Subdiv. (3); P.A. 75-572 added "public" before "transportation" in Subdiv. (3); P.A. 82-341 added Subsec. (b) allowing the commissioner to adopt regulations establishing certain permit fees; P.A. 83-487 amended section to reflect change in name of Connecticut Public Transportation Authority; P.A. 84-546 made technical change in Subdiv. (3) of Subsec. (a), substituting the words "the commission" for "such agencies".

Cited. 183 C. 76, 82.

Sec. 13b-18. Investigations, inquiries and hearings. The commissioner may hold investigations, inquiries and hearings concerning all matters within the jurisdiction of the department. The commissioner may administer oaths and affirmations, certify to all official acts, issue subpoenas and compel the attendance and testimony of witnesses and the production of papers, records, books and documents. If any person refuses to attend, testify or produce papers, records, books or documents as ordered, a judge of the superior court, upon application of the commissioner, may make such order as may be appropriate to aid in the enforcement of this section.

(1969, P.A. 768, S. 13.)

Sec. 13b-19. Cooperation with agencies and persons. Bonds for rail freight support facilities. The commissioner shall cooperate with agencies and persons, governmental or private, charged with or having a substantial interest in (1) planning and developing a sound state transportation system, (2) regulation of transportation facilities and services and (3) solving problems connected with transportation. The commissioner may use any proceeds from the sale of state bonds allocated by the state bond commission under subsection (e) of section 2 of special act 76-84, as amended by special act 78-64, special act 79-3 and section 2 of public act 80-350, to fund no more than ninety per cent of the cost of the rehabilitation, expansion or construction of rail freight support facilities, including, but not limited to, public loading platforms, docks and sidings, ramps, storage areas and access roads, located on public or private property, provided no such project shall receive more than seventy-five thousand dollars. The commissioner shall develop and maintain liaison with the Tri-State Regional Planning Commission established by chapter 291.

(1969, P.A. 768, S. 19; P.A. 79-631, S. 31, 111; P.A. 80-350, S. 1.)

History: P.A. 79-631 substituted in Tri-State Regional Planning Commission "regional planning" for "transportation"; P.A. 80-350 provided in Subdiv. (3) for use of proceeds from sale of state bonds to fund not more than ninety per cent, and not to exceed seventy-five thousand dollars, for rail freight support facilities.

Sec. 13b-20. Records. The commissioner shall keep a record of all proceedings and orders pertaining to the matters under his direction and copies of all plans, specifications

CONNECTICUT

REGULATIONS GOVERNING HIGHWAY ENCROACHMENT PERMITS

(last revised March 31, 1983)

Sec. 13b-17-1 - Purpose and Applicability

These regulations are intended to provide control of Bureau of Highways' rights of way on the State highway system for use other than movement of vehicles, loads and pedestrians by others than the Department of Transportation; to prevent unsafe and hazardous conditions; annoying interruptions to traffic; interference with future highway needs; and to insure compliance with Federal laws, State statutes and other State policies, procedures and regulations.

Where these regulations do not specify definite requirements, standards or specifications, the following current publications may be used by the Commissioner as guides for approval: DOT Geometric Highway Design Standards; Connecticut State Regulations; DOT Standard Specifications for Roads, Bridges and Incidental Construction; DOT Handbook of Safe Practices; DOT Policy on the Accommodation of Utilities on Highway Rights of Way; Manual on Uniform Traffic Control Devices.

No work shall be performed within the State's right of way until a permit has been issued, except as provided in Section 13b-17-24 - Emergency Permits.

Sec. 13b-17-2 - Definitions

When used in these regulations, the following words and phrases shall have the meaning herein allocated:

Application for Permit - a standard form of application which must be filed with the District Maintenance Manager before a permit is issued.

Bond - a written obligation which binds the signatory to answer for the debt, default, or miscarriage of the terms of a permit.

Bureau - The Bureau of Highways established in the Department of Transportation.

Certificate of Insurance - a Department of Transportation - Bureau of Highways form used to indicate protective liability insurance coverage by the permittee.

surety bond must be filed with the District Maintenance Manager by either or both.

The required number of sets of plans and profiles shall be produced by the applicant for all proposed roads or streets, in sufficient extent and detail to indicate all restrictions to sight distance at the intersection, existing and proposed drainage installations, and existing and proposed right of way lines. This information shall be used by the State in determining stipulations to be inserted in the permit to be issued. All streets constructed to intersect a State highway must be surfaced with bituminous concrete or other material acceptable to the District Maintenance Manager for the entire area graded toward the State highway. The side slopes draining to these streets shall be stabilized to prevent erosion.

The intersection shall be designed and constructed to meet the existing gutter grade of the State highway unless specified otherwise by the District Maintenance Manager. Grades and drainage installations shall conform with the requirements of Department policy. Sight distances shall conform to the Department's Geometric Design Standards. Width of road or street and the radii of intersection flares shall be adequate to permit turning by a Entering or Exiting WB50 design vehicle without encroachment on an opposing directional lane of the State highway or the intersecting road or street.

The town official responsible for public works shall be contacted by the permit applicant to determine the town's requirements for acceptance of public streets or roads, if this is a factor in the applicant's plan.

Sec. 13b-17-15 - Driveways

Approval of an application for a permit for a driveway shall be subject to the following conditions:

(1) The applicant is the owner of the property, or owner jointly with the contractor, and any driveway approach constructed by or for him is for the bona fide purpose of securing access to his property and not for the purpose of parking or servicing vehicles on the highway right of way.

- (c) The width of any entrance or exit shall not exceed 30 feet, measured parallel to the direction of the State highway at the property line, except as may otherwise be designated by the District Maintenance Manager because of municipal ordinances or other valid reason. The area within State property between the entrance and exit shall not be improved to facilitate vehicular traffic or parking. This area shall be considered restricted and may be developed only as hereinafter provided in paragraph (1).
- (d) The grade of entrance and exits shall conform to current Highway Design Standards for typical treatment of drives.
- (e) In rural or suburban regions, no entrance or exit shall be so constructed that any part of such entrance or exit is less than ten feet from the extended common boundary separating adjacent private properties, except for returns, the radius of which shall not exceed 50 feet. In urban areas, or where there is a curb and gutter, the distance from the boundary may be five feet. See paragraph 5 (a) above for limitations on radius termini.
- (f) The construction of parking areas on the highway right of way is prohibited, except as provided for under the regulations governing parking areas under lease within the highway right of way. Places of business requiring parking space for their customers shall provide such facilities on their own premises.
- (g) Drainage discharged from a State highway or flowing within the right of way shall not be altered or impeded and the applicant must provide suitable drainage structures as directed by the District Maintenance Manager.

Sec. 13b-17-17 - Utility Installation Requirements

The requirements for the installation of utilities on any State or interstate highway are contained in the current edition of the Department of Transportation publication, "A Policy on the Accommodation of Utilities on Highway Rights of Way" and the AASHTO publication, "A Policy on the Accommodation of Utilities on Freeway Rights of Way."

The granting of permits to install public utility and other structures does not diminish or waive the jurisdiction of the Transportation Commissioner over State highways. If, in the opinion of the Transportation Commissioner, it becomes necessary at any time to remove or relocate any of the structures or fixtures installed under a permit, the removal or relocation, upon notification by the Commissioner or his authorized agent, shall be made immediately by the owner thereof, in accordance with the General Statutes.

Sec. 13b-17-18 - Parking Areas Within the Highway Right of Way

No highway right of way shall be used as a parking area for the benefit of the permittee except under lease with the State and subject to certain conditions.

A highway area shall be eligible for parking if it conforms to zoning regulations in the area, its presence does not conflict with scenic highway standards or create a traffic hazard, and it is not needed for immediate highway purposes.

For areas fronting on a public street, the priorities for lease shall be to:

- (1) another State agency

such property. Transfers to other state agencies and municipalities for purposes specified by the department shall be exempt from the appraisal requirement. The department shall obtain a second appraisal if such property is valued over one hundred thousand dollars and is not to be sold through public bid or auction. Any appraisals or value reports shall be obtained prior to the determination of a sale price of the excess property. The department shall offer parcels which meet local zoning requirements for residential or commercial use to other state agencies and shall offer parcels which do not meet local zoning requirements for residential or commercial use to all abutting landowners in accordance with department regulations.

(1949 Rev., S. 2226; 1958 Rev., S. 13-105; 1963, P.A. 226, S. 80; P.A. 75-425, S. 48, 57; P.A. 76-253, S. 5, 6; P.A. 77-614, S. 19, 610; P.A. 86-228, S. 2.)

History: 1963 act replaced previous provisions: See title history; P.A. 75-425 required consent of public works commissioner and properties review board in addition to that of commissioner of finance and control for disposal of land or buildings or agreements concerning land or buildings; P.A. 76-253 deleted reference to public works commissioner; P.A. 77-614 substituted secretary of the office of policy and management for commissioner of finance and control; P.A. 86-228 editorially added Subsec. (b) concerning appraisal requirements for sale of certain excess property and requiring department to offer parcels meeting local zoning requirements to other state agencies and to offer parcels which do not meet such requirements to all abutting landowners.

Cited. 150 C. 526, 528.

Sec. 13a-80a. Disposition of interests on, above or below state highway rights-of-way. (a) The commissioner of transportation, with the advice and consent of the secretary of the office of policy and management, may, in the name of the state, sell, lease and convey, or otherwise dispose of, or enter into agreements concerning, any interest the state may have on, above or below any state highway right-of-way. The commissioner of transportation may place such restrictions, conditions and qualifications on the use of any area as he determines to be necessary to provide for the safety and adequacy of highway facilities, and for the protection of abutting or adjacent land users. A committee composed of the commissioner of transportation, the secretary of the office of policy and management and the chief executive officer of the municipality in which the sale, lease or other disposition of any interest in land on, above or below any state highway right-of-way is proposed may also place such restrictions, conditions and qualifications on the use of any area which they determine to be necessary to provide for the efficient, economical and socially beneficial use of the area.

(b) The commissioner of transportation shall have the power to section off levels of space over or under the same location and sell or lease varying levels to different parties.

(c) Revenues from any transaction concerning the sale, lease or use of space or multiple use or joint development of state highway rights-of-way shall be deposited in the special transportation fund.

(1969, P.A. 549, S. 1, 2, 7; P.A. 73-675, S. 11, 44; P.A. 75-568, S. 7, 45; P.A. 77-614, S. 19, 610; P.A. 84-254, S. 18, 62.)

History: P.A. 73-675 substituted transportation fund for state highway fund in Subsec. (c); P.A. 75-568 substituted general fund for transportation fund in Subsec. (c); P.A. 77-614 substituted secretary of the office of policy and management for commissioner of finance and control in Subsec. (a); P.A. 84-254 amended Subsec. (c) to require revenues from transactions to be deposited in special transportation fund instead of general fund.

Sec. 13a-80b. Order of priorities. The commissioner of transportation shall give priority in the following order in the disposition or assignment of space or multiple use or joint development under sections 13a-80a to 13a-80f, inclusive, to the state, the

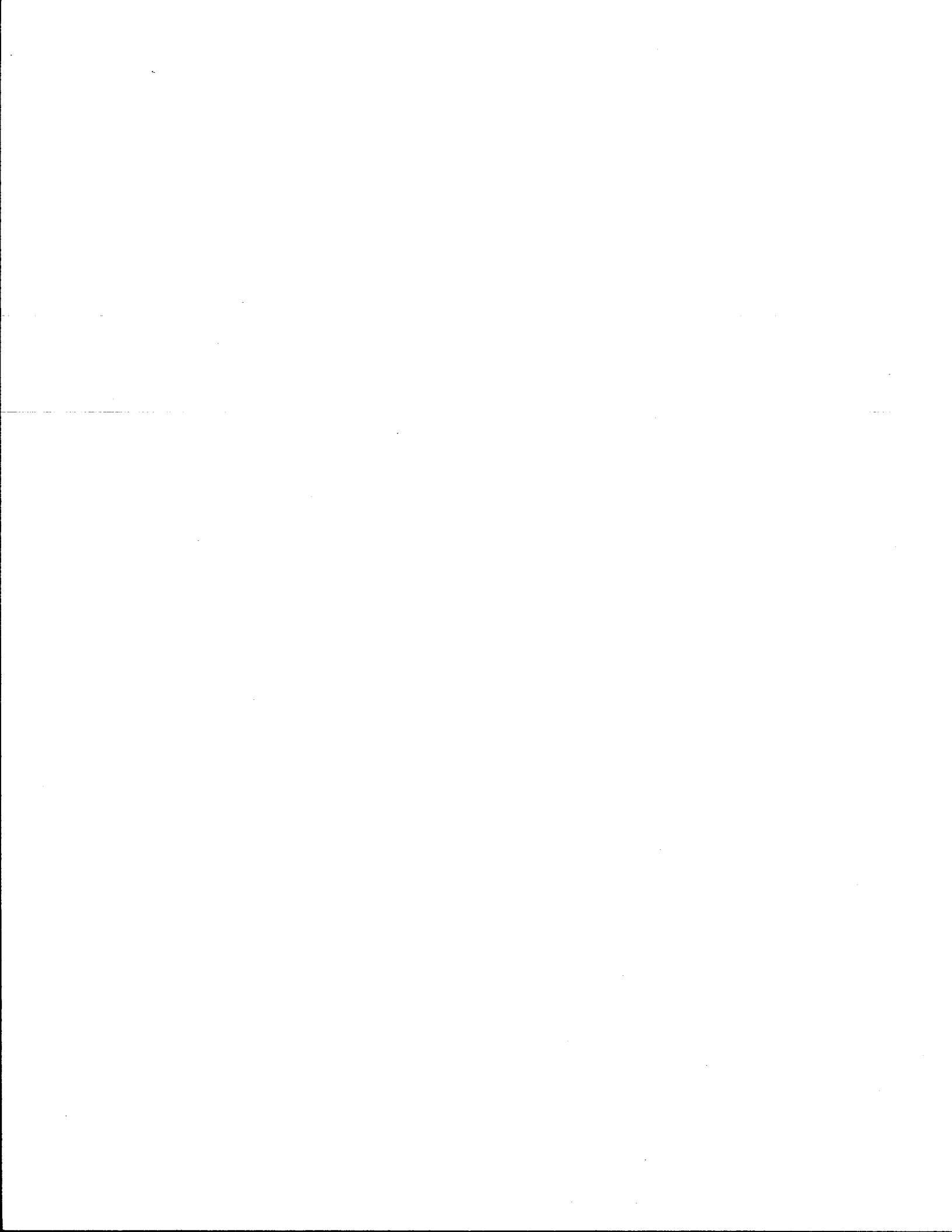

DELAWARE

- Legislation



as to the need of such sidewalk construction, shall consult with the county department of planning, the State Planning Office, the Department of Public Instruction and the local school district in which the proposed new road construction or road widening construction is to take place. The cost of such sidewalk construction shall be included in the total cost of the new road construction or road widening project. This subsection shall apply only to projects funded pursuant to acts authorizing the State to borrow money and issue bonds and notes for capital improvements, enacted after January 1, 1973.

(g) The Department shall have exclusive original supervision and regulation of all public carriers and also over their property, property rights, equipment, facilities, franchises, rates, fares, tariffs, regulations, practices, measurements and services.

(h) Whenever the Department of Transportation widens, constructs or reconstructs any major arterial, interstate connector, minor arterial, collector road or proposed road in an urbanized area of this State, the Department shall incorporate in the plans therefor provision for all costs incurred in replacing, wherever possible, shade trees to be removed in order to execute the plan. Replacement shade trees shall be a minimum height of 16 feet, balled and burlapped nursery-grown stock, and all planting work shall be done in accordance with § 728 of the Delaware Department of Transportation Standard Specifications (January 1, 1974, or latest revised edition). The place of planting trees shall be in compliance with federal law and regulations relating to the distance such trees must be planted from the edge of the roadway. (29 Del. Laws, c. 63, § 5; Code 1935, § 5722; 17 Del. C. 1953, § 132; 49 Del. Laws, c. 262; 51 Del. Laws, c. 141, § 1; 51 Del. Laws, c. 328; 52 Del. Laws, c. 295; 53 Del. Laws, c. 39, §§ 5, 6, 13; 54 Del. Laws, c. 251; 55 Del. Laws, c. 14; 56 Del. Laws, c. 101; 57 Del. Laws, c. 327, § 1; 57 Del. Laws, c. 671, § 1F; 57 Del. Laws, c. 754, § 2; 58 Del. Laws, c. 585; 59 Del. Laws, c. 393, § 4; 60 Del. Laws, c. 386, § 1; 60 Del. Laws, c. 503, § 18; 62 Del. Laws, c. 384, § 1.)

This section constitutes a valid exercise of the police power by the General Assembly, assuming, of course, that the appropriation made therein is for a public purpose. State Hwy. Dep't v. Delaware Power & Light Co., Del. Supr., 167 A.2d 27 (1961).

The construction, reconstruction, maintenance and repair of public highways is an inherently governmental function which belongs primarily to the State and may be exercised by it as a part of its police powers in connection with the general welfare. State Hwy. Dep't v. Delaware Power & Light Co., Del. Supr., 167 A.2d 27 (1961).

Power of eminent domain may be, and usually is, delegated to a public agency. State ex rel. Sharp v. 0.62033 Acres of Land, Del. Supr., 112 A.2d 857 (1955).

When the General Assembly delegates the right of eminent domain to a governmental agency for a public purpose, it may also, if there is no constitutional restriction, delegate to such

agency the power of determining what property and how much property is necessary for the purpose. State ex rel. Sharp v. 0.62033 Acres of Land, Del. Supr., 110 A.2d 1 (1954), aff'd, Del. Supr., 112 A.2d 857 (1955).

But such power is not to be exercised thoughtlessly or arbitrarily. 0.24148, 0.23831 & 0.12277 Acres of Land v. State ex rel. Smith, Del. Supr., 145 A.2d 388 (1958).

This section requires approval by the Department of the decision to condemn a particular portion of land or, in the alternative, the approval by the Department of an overall plan of highway construction, the plans and specifications of which require the acquisition of certain land for highway purposes. 0.24148, 0.23831 & 0.12277 Acres of Land v. State ex rel. Smith, Del. Supr., 145 A.2d 388 (1958).

It is only after overall approval by the Department that the Chief Engineer may exercise the power delegated by statute to him to order the commencement of condemnation pro-

(c) Nothing herein contained shall in any way affect the right of persons using the road or portion thereof so closed for the purpose of necessary ingress, egress or regress to any property located thereon. (29 Del. Laws, c. 108; 40 Del. Laws, c. 107, § 1; Code 1935, § 1666; 17 Del. C. 1953, § 502.)

§ 503. Nuisance; penalty.

Whoever encroaches upon, or obstructs or commits any nuisance in, a public road or willfully obstructs or injures a public bridge shall be fined not less than \$15 nor more than \$50. In case of a continuing nuisance, the judge shall order him to abate the nuisance within a given time, and on failure to do so a writ of execution shall be issued to the sheriff commanding him to abate the same. The sheriff's fee for executing the writ shall be \$3 a day and all expenses, to be paid by the defendant, which payment may be enforced by attachment and imprisonment. (Code 1852, § 1133; Code 1915, § 1575; Code 1935, § 1664; 17 Del. C. 1953, § 503.)

The remedy under this section is not exclusive. *Singewald v. Girden*, Del. Ch., 127 A.2d 607 (1956).

Public nuisance defined. — Any unlawful, tangible obstruction which interferes with a road's use for the purposes of public travel and transportation is a public nuisance. *Murden v. Commissioners of Lewes, Inc.*, Del. Super., 96 A. 506 (1915), *aff'd*, Del. Supr., 108 A. 74 (1919).

Persons lawfully on a highway have a right to use it without molestation or hindrance, with the limitations that such use is subject to reasonable interruption for purposes of construction and repair. *Mills v. Wilmington City Ry.*, Del. Super., 269, 40 A. 1114 (1894).

Interference by an individual with the enjoyment of the easement which the public has over the streets and highways is a public nuisance and subject to abatement. *Miller v. Town of Seaford*, Del. Ch., 194 A. 37 (1937).

The public has a right to the free and unmolested use of the public highways, and abutting landowners may not use their land in such a way that it interferes with the rights of persons lawfully using the highway. *Salevan v. Wilmington Park, Inc.*, Del. Super., 72 A.2d 239 (1950).

The primary purpose of a highway is to

permit the passing and repassing of the public, and the public is entitled to the unobstructed use of its entire width for that purpose. *De Pace v. Mayor of Wilmington*, Del. Supr., 72 A.2d 439 (1950).

No right of prescription or adverse possession can be acquired to maintain a nuisance in a street or highway. *Miller v. Town of Seaford*, Del. Ch., 194 A. 37 (1937).

Information brought by Attorney General. — An information involving the protection of a public right (to enjoin or abate an obstruction of a public highway) is properly brought by the Attorney General. *Reinhardt ex rel. Rogers v. Chalfont*, Del. Ch., 110 A. 663 (1920), *aff'd*, Del. Supr., 113 A. 674 (1921).

A relator with a private interest in the public right is a proper party to an information brought by the Attorney General to enjoin construction of a highway, in order that there be someone responsible for costs of the cause. When the original relator conveys away the land, the grantee, by succeeding to the grantor's private and special interest in enforcing the public right, is properly substituted as relator. *Reinhardt ex rel. Rogers v. Chalfont*, Del. Ch., 110 A. 663 (1920), *aff'd*, Del. Supr., 113 A. 674 (1921).

§ 504. Entry upon contiguous or adjacent lands or streams; assessment of damages; hindering or obstructing work; penalty.

(a) In order to obtain the free passage of water for drainage of any road or causeway under its jurisdiction, the Department or its agents may enter upon any lands contiguous or adjacent to such road or causeway in order to maintain or repair any existing artificial or natural ditch, drain, culvert or sewer.

FLORIDA

- Legislation



idential structures, as long as such structures continue to be used as private residences.

(b) An area of proposed road construction within which development permits, as defined in s. 380.031(4), shall not be issued for a period of 5 years from the date of recording such map. The 5-year period may be extended for an additional 5-year period by the same procedure set forth in subsection (1).

(3) Upon petition by an affected property owner alleging that such property regulation is unreasonable or arbitrary and that its effect is to deny a substantial portion of the beneficial use of such property, the department or expressway authority shall hold an administrative hearing in accordance with the provisions of chapter 120. When such a hearing results in an order finding in favor of the petitioning property owner, the department or expressway authority shall have 180 days from the date of such order to acquire such property or file appropriate proceedings. Appellate review by either party may be resorted to, but such review will not affect the 180-day limitation when such appeal is taken by the department or expressway authority unless execution of such order is stayed by the appellate court having jurisdiction.

(4) Upon the failure by the department or expressway authority to acquire such property or initiate acquisition proceedings, the appropriate local governmental entity may issue any permit in accordance with its established procedures.

History.—s. 140, ch. 84-309; s. 2, ch. 85-149; s. 3, ch. 86-47.

337.401 Use of right-of-way for utilities subject to regulation; permit; fees.—

(1) The department and local governmental entities, referred to in ss. 337.401-337.404 as the "authority," that have jurisdiction and control of public roads are authorized to prescribe and enforce reasonable rules or regulations with reference to the placing and maintaining along, across, or on any road under their respective jurisdictions any electric transmission, telephone, or telegraph lines, pole lines, poles, railways, ditches, sewers, water, heat, or gas mains, pipelines, fences, gasoline tanks and pumps, or other structures hereinafter referred to as the "utility."

(2) The authority may grant to any person who is a resident of this state, or to any corporation which is organized under the laws of this state or licensed to do business within this state, the use of a right-of-way for the utility in accordance with such rules or regulations as the authority may adopt. No utility shall be installed, located, or relocated unless authorized by a written permit issued by the authority. The permit shall require the permit holder to be responsible for any damage resulting from the issuance of such permit.

(3) If any municipal authority requires any telephone company to pay a fee or other consideration as a condition for granting permission to occupy municipal streets and rights-of-way for poles, wires, and other fixtures, such fee or consideration may not exceed 1 percent of the gross receipts on recurring local service revenues for services provided within the corporate limits of the municipality by such telephone company. Included within such 1-percent maximum fee or consideration are all

taxes, licenses, fees, and other impositions except ad valorem taxes and amounts for assessments for special benefits, such as sidewalks, street pavings, and similar improvements, and occupational license taxes levied or imposed by a municipality upon the telephone company. This subsection shall not impair any franchise in existence on July 1, 1985.

(4) A municipality may by ordinance enter into an agreement with any person providing telecommunication services defined in s. 203.012(7) as a condition for granting permission to occupy or use any city street, alley, viaduct, elevated roadway, bridge, or other public way. The agreement shall permit the telecommunication service provider to construct, operate, maintain, repair, rebuild, or replace a telecommunications route within a municipal right-of-way. The agreement shall provide for a fee or other consideration payable annually based on actual linear feet of any cable, fiber optic, or other pathway that makes physical use of the municipal right-of-way. The fee or other consideration imposed pursuant to this subsection shall not apply to any telecommunication service provider who provides telecommunication services as defined in s. 203.012(3).

History.—s. 127, ch. 29965, 1955; s. 1, ch. 63-279; s. 1, ch. 65-52; ss. 23, 35, ch. 69-106; s. 141, ch. 84-309; s. 8, ch. 85-174; s. 8, ch. 86-155.

Note.—Former s. 338.17.
cf.—ch. 362 Utilities along roads.

337.406 Unlawful commercial use of state-maintained road right-of-way; penalties.—

(1) Except when otherwise authorized by law or by the rules of the department, it is unlawful to make any commercial use of the right-of-way of any state-maintained road, including appendages thereto, and also including, but not limited to, rest areas, wayside parks, boat-launching ramps, weigh stations, and scenic easements. Such prohibited uses include, but are not limited to, the sale, or the display for sale, of any merchandise; the servicing or repairing of any vehicle, except the rendering of emergency service; the storage of vehicles being serviced or repaired on abutting property or elsewhere; the solicitation for the sale of goods, property, or services or for charitable purposes; and the display of advertising of any sort, except that any portion of a state-maintained road may be used for an art festival, parade, fair, or other special event if permitted by the appropriate local governmental entity. Before a road on the State Highway System may be temporarily closed for a special event, the local governmental entity which permits the special event to take place must determine that the temporary closure of the road is necessary and must obtain the prior written approval for the temporary road closure from the department. Nothing in this subsection shall be construed to authorize such activities on the Interstate Highway System.

(2) Persons holding valid peddlers' licenses issued by appropriate governmental entities may make sales from vehicles standing on the right-of-way to occupants of abutting property only.

(3) The Department of Highway Safety and Motor Vehicles and other law enforcement agencies are authorized and directed to enforce this statute.

(4) The violation of any provision of this section or any rule promulgated by the department pursuant to

this section constitutes a misdemeanor of the second degree, punishable as provided in s. 775.082 or s. 775.083, and each day a violation continues to exist constitutes a separate offense.

History.—s. 1, ch. 73-188; s. 1, ch. 79-30; s. 206, ch. 81-259; s. 168, ch. 84-309; s. 3, ch. 86-37.

Note.—Former s. 339.301.

CHAPTER 338

LIMITED ACCESS AND TOLL FACILITIES

338.221 Definitions of terms used in ss. 338.22-338.244.

338.223 Proposed turnpike projects; studies.

338.221 Definitions of terms used in ss. 338.22-338.244.—As used in ss. 338.22-338.244, the following words and terms have the following meanings, unless the context indicates another or different meaning or intent:

(1) "Bonds" or "revenue bonds" means bonds of the department authorized under the provisions of ss. 338.22-338.244.

(2) "Cost," as applied to a turnpike project, includes the cost of acquisition of all land, rights-of-way, property, easements, and interests acquired by the department for turnpike project construction, the cost of such construction, the cost of all machinery and equipment, financing charges, interest prior to and during construction; and, for such period after completion of construction as shall be determined by the department, the cost of traffic estimates and of engineering and legal expenses, plans, specifications, surveys, estimates of cost and revenues, other expenses necessary or incident to determining the feasibility or practicability of acquiring or constructing any such turnpike project, administrative expenses, and such other expenses as may be necessary or incident to the acquisition or construction of a turnpike project, the financing of such acquisition or construction, and the placing of the turnpike project in operation.

(3) "Feeder road" means any road which the department determines is necessary to create or facilitate access to a turnpike project.

(4) "Owner" includes any person or any governmental entity that has title to, or an interest in, any property, right, easement, or interest authorized to be acquired pursuant to ss. 338.22-338.244.

(5) "Revenues" means all tolls, charges, rentals, gifts, grants, moneys, and other funds coming into the possession, or under the control, of the department by virtue of the provisions hereof, except the proceeds from the sale of bonds issued under ss. 338.22-338.244.

(6) "Turnpike project" means those limited access highways and associated feeder roads and other structures, appurtenances, or rights previously acquired or constructed pursuant to the Florida Turnpike Law and such other limited access highways and associated feeder roads and other structures, appurtenances, or rights as may be hereafter approved by the Legislature.

(7) "Turnpike improvement" means any betterment to an existing turnpike project necessary for the safe and efficient operation of such project, including, but not limited to, feeder roads, interchanges, widenings, toll plazas, machinery, and equipment, and includes improvements to other public roads of the state.

History.—s. 4, ch. 28128, 1953; s. 1, ch. 59-69; s. 1, ch. 65-469; ss. 5, 9, ch. 67-359; ss. 23, 35, ch. 69-106; s. 99, ch. 71-355; s. 116, ch. 71-377; s. 99, ch. 73-333; s. 188, ch. 84-309; s. 73, ch. 85-180; s. 34, ch. 86-243.

Note.—Former ss. 340.04, 340.011.

338.223 Proposed turnpike projects; studies.—

(1)(a) The department may authorize engineering studies, traffic studies, and other expert studies of the location, costs, feasibility, and practicality of turnpike projects throughout the state. If it is found economically feasible, the department, with the approval of the Legislature, shall construct, maintain, and operate such turnpike projects; provided, however, that each such project and turnpike improvement shall be included in the department's legislative budget request.

(b)1. Any proposed turnpike project to be located wholly within one county is subject to the approval of the commissioners of such county.

2. Any proposed turnpike project or turnpike improvement shall be developed in accordance with the Florida Transportation Plan and the 5-year transportation plan pursuant to s. 339.135. Turnpike projects or turnpike improvements that add capacity, alter access, affect feeder roads, or affect the operation of the local transportation system must be included in the transportation improvement plan of the affected metropolitan planning organization. If such turnpike project or turnpike improvement does not fall within the jurisdiction of a metropolitan planning organization, it shall require the approval of the board of county commissioners of the affected county.

(2) The department is authorized to expend, out of any funds available for the purpose, such moneys as may be necessary for the study of any turnpike project and to use its engineering and other resources for the purpose of effecting such study.

(3) All obligations and expenses incurred by the department under this section shall be paid by the department and charged to the appropriate turnpike project. The department shall keep proper records and accounts showing each amount that is so charged. All obligations and expenses so incurred shall be treated as part of the cost of such project and shall be reimbursed to the department out of the bonds authorized under ss. 338.22-338.244.

History.—s. 3, ch. 28128, 1953; s. 1, ch. 29634, 1955; s. 2, ch. 57-359; ss. 23, 35, ch. 69-106; s. 117, ch. 71-377; s. 190, ch. 84-309; s. 74, ch. 85-180; s. 35, ch. 86-243.

Note.—Former s. 340.03.

CHAPTER 339

TRANSPORTATION FINANCE AND PLANNING

339.135 Budgets: preparation, adoption, execution, and amendment.

idential structures, as long as such structures continue to be used as private residences.

(b) An area of proposed road construction within which development permits, as defined in s. 380.031(4), shall not be issued for a period of 5 years from the date of recording such map. The 5-year period may be extended for an additional 5-year period by the same procedure set forth in subsection (1).

(3) Upon petition by an affected property owner alleging that such property regulation is unreasonable or arbitrary and that its effect is to deny a substantial portion of the beneficial use of such property, the department or expressway authority shall hold an administrative hearing in accordance with the provisions of chapter 120. When such a hearing results in an order finding in favor of the petitioning property owner, the department or expressway authority shall have 180 days from the date of such order to acquire such property or file appropriate proceedings. Appellate review by either party may be resorted to, but such review will not affect the 180-day limitation when such appeal is taken by the department or expressway authority unless execution of such order is stayed by the appellate court having jurisdiction.

(4) Upon the failure by the department or expressway authority to acquire such property or initiate acquisition proceedings, the appropriate local governmental entity may issue any permit in accordance with its established procedures.

History.—s. 140, ch. 84-309; s. 2, ch. 85-149; s. 3, ch. 86-47.

337.401 Use of right-of-way for utilities subject to regulation; permit; fees.—

(1) The department and local governmental entities, referred to in ss. 337.401-337.404 as the "authority," that have jurisdiction and control of public roads are authorized to prescribe and enforce reasonable rules or regulations with reference to the placing and maintaining along, across, or on any road under their respective jurisdictions any electric transmission, telephone, or telegraph lines, pole lines, poles, railways, ditches, sewers, water, heat, or gas mains, pipelines, fences, gasoline tanks and pumps, or other structures hereinafter referred to as the "utility."

(2) The authority may grant to any person who is a resident of this state, or to any corporation which is organized under the laws of this state or licensed to do business within this state, the use of a right-of-way for the utility in accordance with such rules or regulations as the authority may adopt. No utility shall be installed, located, or relocated unless authorized by a written permit issued by the authority. The permit shall require the permit holder to be responsible for any damage resulting from the issuance of such permit.

(3) If any municipal authority requires any telephone company to pay a fee or other consideration as a condition for granting permission to occupy municipal streets and rights-of-way for poles, wires, and other fixtures, such fee or consideration may not exceed 1 percent of the gross receipts on recurring local service revenues for services provided within the corporate limits of the municipality by such telephone company. Included within such 1-percent maximum fee or consideration are all

taxes, licenses, fees, and other impositions except ad valorem taxes and amounts for assessments for special benefits, such as sidewalks, street pavings, and similar improvements, and occupational license taxes levied or imposed by a municipality upon the telephone company. This subsection shall not impair any franchise in existence on July 1, 1985.

(4) A municipality may by ordinance enter into an agreement with any person providing telecommunication services defined in s. 203.012(7) as a condition for granting permission to occupy or use any city street, alley, viaduct, elevated roadway, bridge, or other public way. The agreement shall permit the telecommunication service provider to construct, operate, maintain, repair, rebuild, or replace a telecommunications route within a municipal right-of-way. The agreement shall provide for a fee or other consideration payable annually based on actual linear feet of any cable, fiber optic, or other pathway that makes physical use of the municipal right-of-way. The fee or other consideration imposed pursuant to this subsection shall not apply to any telecommunication service provider who provides telecommunication services as defined in s. 203.012(3).

History.—s. 127, ch. 29965, 1955; s. 1, ch. 63-279; s. 1, ch. 65-52; ss. 23, 35, ch. 69-106; s. 141, ch. 84-309; s. 8, ch. 85-174; s. 8, ch. 86-155.

*Note.—Former s. 338.17.
cf.—ch. 362 Utilities along roads.*

337.406 Unlawful commercial use of state-maintained road right-of-way; penalties.—

(1) Except when otherwise authorized by law or by the rules of the department, it is unlawful to make any commercial use of the right-of-way of any state-maintained road, including appendages thereto, and also including, but not limited to, rest areas, wayside parks, boat-launching ramps, weigh stations, and scenic easements. Such prohibited uses include, but are not limited to, the sale, or the display for sale, of any merchandise; the servicing or repairing of any vehicle, except the rendering of emergency service; the storage of vehicles being serviced or repaired on abutting property or elsewhere; the solicitation for the sale of goods, property, or services or for charitable purposes; and the display of advertising of any sort, except that any portion of a state-maintained road may be used for an art festival, parade, fair, or other special event if permitted by the appropriate local governmental entity. Before a road on the State Highway System may be temporarily closed for a special event, the local governmental entity which permits the special event to take place must determine that the temporary closure of the road is necessary and must obtain the prior written approval for the temporary road closure from the department. Nothing in this subsection shall be construed to authorize such activities on the Interstate Highway System.

(2) Persons holding valid peddlers' licenses issued by appropriate governmental entities may make sales from vehicles standing on the right-of-way to occupants of abutting property only.

(3) The Department of Highway Safety and Motor Vehicles and other law enforcement agencies are authorized and directed to enforce this statute.

(4) The violation of any provision of this section or any rule promulgated by the department pursuant to

this section constitutes a misdemeanor of the second degree, punishable as provided in s. 775.082 or s. 775.083, and each day a violation continues to exist constitutes a separate offense.

History.—s. 1, ch. 73-188; s. 1, ch. 79-30; s. 206, ch. 81-259; s. 168, ch. 84-309; s. 3, ch. 86-37.

Note.—Former s. 339.301.

CHAPTER 338

LIMITED ACCESS AND TOLL FACILITIES

338.221 Definitions of terms used in ss. 338.22-338.244.

338.223 Proposed turnpike projects; studies.

338.221 Definitions of terms used in ss. 338.22-338.244.—As used in ss. 338.22-338.244, the following words and terms have the following meanings, unless the context indicates another or different meaning or intent:

(1) "Bonds" or "revenue bonds" means bonds of the department authorized under the provisions of ss. 338.22-338.244.

(2) "Cost," as applied to a turnpike project, includes the cost of acquisition of all land, rights-of-way, property, easements, and interests acquired by the department for turnpike project construction, the cost of such construction, the cost of all machinery and equipment, financing charges, interest prior to and during construction; and, for such period after completion of construction as shall be determined by the department, the cost of traffic estimates and of engineering and legal expenses, plans, specifications, surveys, estimates of cost and revenues, other expenses necessary or incident to determining the feasibility or practicability of acquiring or constructing any such turnpike project, administrative expenses, and such other expenses as may be necessary or incident to the acquisition or construction of a turnpike project, the financing of such acquisition or construction, and the placing of the turnpike project in operation.

(3) "Feeder road" means any road which the department determines is necessary to create or facilitate access to a turnpike project.

(4) "Owner" includes any person or any governmental entity that has title to, or an interest in, any property, right, easement, or interest authorized to be acquired pursuant to ss. 338.22-338.244.

(5) "Revenues" means all tolls, charges, rentals, gifts, grants, moneys, and other funds coming into the possession, or under the control, of the department by virtue of the provisions hereof, except the proceeds from the sale of bonds issued under ss. 338.22-338.244.

(6) "Turnpike project" means those limited access highways and associated feeder roads and other structures, appurtenances, or rights previously acquired or constructed pursuant to the Florida Turnpike Law and such other limited access highways and associated feeder roads and other structures, appurtenances, or rights as may be hereafter approved by the Legislature.

(7) "Turnpike improvement" means any betterment to an existing turnpike project necessary for the safe and efficient operation of such project, including, but not limited to, feeder roads, interchanges, widenings, toll plazas, machinery, and equipment, and includes improvements to other public roads of the state.

History.—s. 4, ch. 28128, 1953; s. 1, ch. 59-69; s. 1, ch. 65-469; ss. 5, 9, ch. 67-359; ss. 23, 35, ch. 69-106; s. 99, ch. 71-355; s. 116, ch. 71-377; s. 99, ch. 73-333; s. 188, ch. 84-309; s. 73, ch. 85-180; s. 34, ch. 86-243.

Note.—Former ss. 340.04, 340.011.

338.223 Proposed turnpike projects; studies.—

(1)(a) The department may authorize engineering studies, traffic studies, and other expert studies of the location, costs, feasibility, and practicality of turnpike projects throughout the state. If it is found economically feasible, the department, with the approval of the Legislature, shall construct, maintain, and operate such turnpike projects; provided, however, that each such project and turnpike improvement shall be included in the department's legislative budget request.

(b)1. Any proposed turnpike project to be located wholly within one county is subject to the approval of the commissioners of such county.

2. Any proposed turnpike project or turnpike improvement shall be developed in accordance with the Florida Transportation Plan and the 5-year transportation plan pursuant to s. 339.135. Turnpike projects or turnpike improvements that add capacity, alter access, affect feeder roads, or affect the operation of the local transportation system must be included in the transportation improvement plan of the affected metropolitan planning organization. If such turnpike project or turnpike improvement does not fall within the jurisdiction of a metropolitan planning organization, it shall require the approval of the board of county commissioners of the affected county.

(2) The department is authorized to expend, out of any funds available for the purpose, such moneys as may be necessary for the study of any turnpike project and to use its engineering and other resources for the purpose of effecting such study.

(3) All obligations and expenses incurred by the department under this section shall be paid by the department and charged to the appropriate turnpike project. The department shall keep proper records and accounts showing each amount that is so charged. All obligations and expenses so incurred shall be treated as part of the cost of such project and shall be reimbursed to the department out of the bonds authorized under ss. 338.22-338.244.

History.—s. 3, ch. 28128, 1953; s. 1, ch. 29534, 1955; s. 2, ch. 67-359; ss. 23, 35, ch. 69-106; s. 117, ch. 71-377; s. 190, ch. 84-309; s. 74, ch. 85-180; s. 35, ch. 86-243.

Note.—Former s. 340.03.

CHAPTER 339

TRANSPORTATION FINANCE AND PLANNING

339.135 Budgets: preparation, adoption, execution, and amendment.

GEORGIA

- Legislation

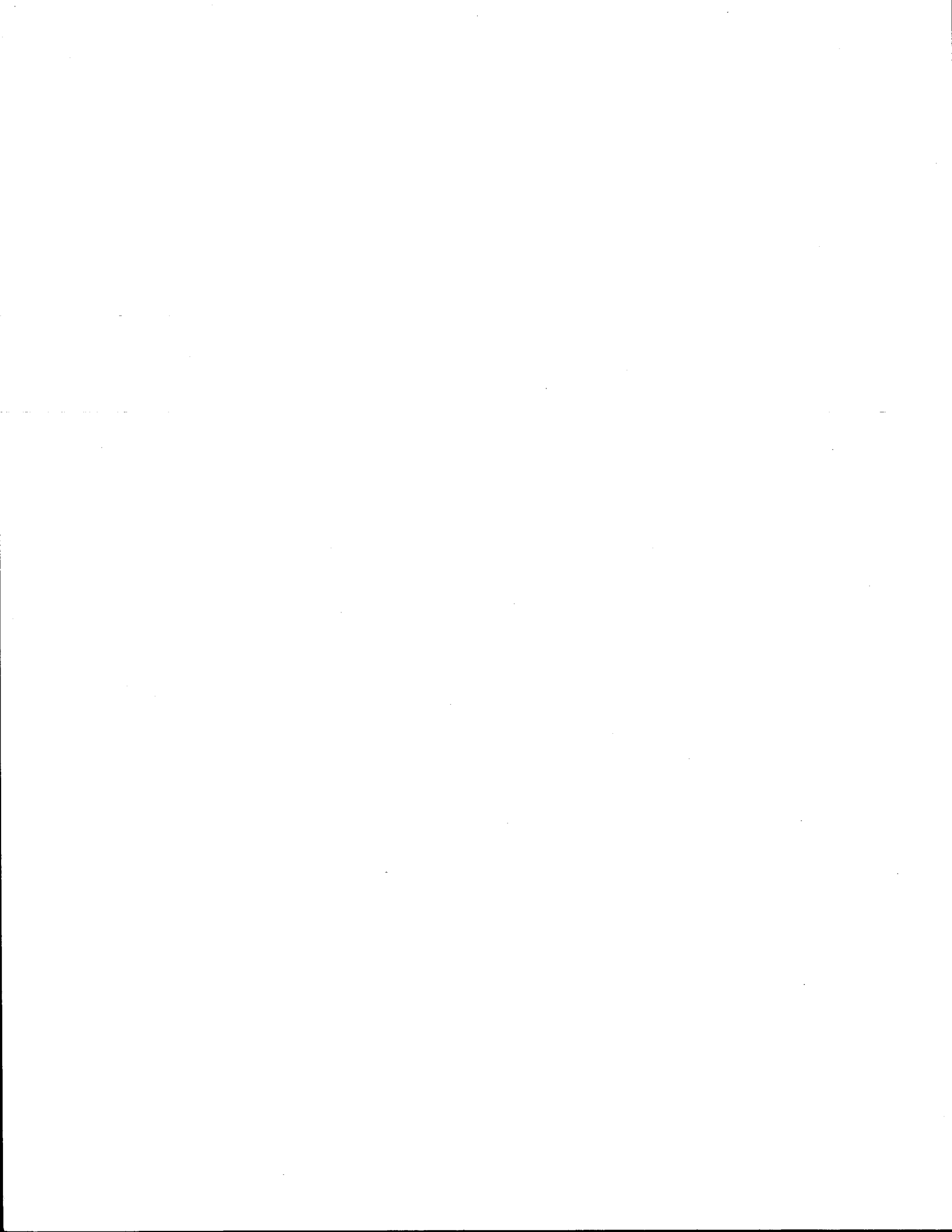

GENERAL PROVISIONS

Cross references. — Georgia Highway Authority, § 32-10-60 et seq. Conflicts of Authority, § 32-10-1 et seq. State Tollway interest, § 45-10-20 et seq.

OPINIONS OF THE ATTORNEY GENERAL

Even for payment, a county may not lawfully scrape privately-owned driveways; the county's collection of a fee for providing this service would not, given the plain language of the statute, make the transaction lawful. 1976 Op. Att'y Gen. No. U76-24.

32-1-9. Enforcement of title by law enforcement officers.

It shall be the duty of all state and local law enforcement officers to enforce any provision of this title which states that any act or omission is unlawful. (Code 1933, § 95A-1103, enacted by Ga. L. 1973, p. 947, § 1.)

32-1-10. Penalty. *

(a) Any person who violates any of the provisions of this title for which no specific penalty is provided, whether or not such act or omission is expressly declared elsewhere in this title to be unlawful, or who violates any of the rules and regulations issued under authority of and in accord with the provisions of this title shall be guilty of a misdemeanor; provided, however, that a violation of Code Sections 32-6-26 and 32-6-27 shall not be considered a crime.

(b) In addition to the penalty provided for in subsection (a) of this Code section, the department shall have the right to enjoin any act or omission so punishable as a misdemeanor or punished otherwise as provided elsewhere in this title. (Code 1933, § 95A-1101, enacted by Ga. L. 1973, p. 947, § 1; Ga. L. 1978, p. 1989, § 4.)

OPINIONS OF THE ATTORNEY GENERAL

Promotion of safety and protection of public investment. — This section and §§ 32-6-23, 32-6-24, 46-7-61 and 46-7-78 are intended to promote safety of traveling public and protect public's investment in its roads and highways. 1981 Op. Att'y Gen. No. U81-17.

ARTICLE 1
GENERAL PROVISIONS

32-6-1. Obstructing, encroaching on, or injuring public roads.

It shall be unlawful for any person to obstruct, encroach upon, solicit the sale of any merchandise on, or injure materially any part of any public road. However, nothing in this Code section shall abridge or limit any authority provided by law for the installation and operation of vending machines at welcome centers, tourist centers, and safety rest areas. (Code 1933, § 95A-903, enacted by Ga. L. 1973, p. 947, § 1; Ga. L. 1979, p. 132, § 4.)

Cross references. — Further provisions regarding obstruction of public roads, § 16-11-43. Installation of vending machines in safety rest areas, § 32-6-116. Prohibition against interference with public roads, streets, etc., by mass picketing near site of labor dispute, § 34-6-5.

Law reviews. — For article, "Recommendations Regarding Control of Outdoor Advertising Along the Interstate Highway System in Georgia," see 14 Mercer L. Rev. 308 (1963).

JUDICIAL DECISIONS

Section does not apply to structures which are on private property adjacent to public roads. *Smith v. Hiawassee Hdwe. Co.*, 167 Ga. App. 70, 305 S.E.2d 805 (1983).

Department can require removal of obstructions. — The management and

control of the right of way of the state's system of roads is vested in the Department of Transportation, and the department can require the removal of any obstruction placed thereon without express permission. *Crider v. Kelley*, 232 Ga. 616, 208 S.E.2d 444 (1974).

RESEARCH REFERENCES

Am. Jur. 2d. — 39 Am. Jur. 2d. Highways, Streets, and Bridges, § 32.

C.J.S. — 40 C.J.S., Highways, §§ 218, 221, 222.

ALR. — Constitutionality of statute or ordinance imposing upon abutting owners or occupants duty in respect of care or condition of street or highway, 58 ALR 215.

Municipality's power to permit private owner to construct building or structure overhanging or crossing the air space above public street or sidewalk, 76 ALR2d 896.

Relative rights and liabilities of abutting owners and public authorities in parkways in center of street, 81 ALR2d 1436.

40-319. Good faith of state pledged to appropriation. — For the construction and maintenance of highways as may be eligible for federal aid funds, excepting turnpike projects, the good faith of the state is pledged to make available funds which combined with funds made available by counties, highway districts and cities sufficient to match funds made available to the state of Idaho by the United States government for highway purposes and for the purpose of evidencing good faith, the board in the name of the state, is authorized to enter into any and all agreements with the United States government under rules and regulations approved by the United States government or any of its agencies. [I.C., § 40-319, as added by 1985, ch. 253, § 2, p. 586.]

40-320. State highway construction and right-of-way costs borne by state — Exceptions. — All costs of constructing, reconstructing and acquiring rights-of-way for highways in the state highway system shall be borne by the state. However, when a county or incorporated city in which a state highway is located, or is to be located, desires a higher standard of construction or reconstruction than is planned, the county or city may, with the approval of the board, pay the additional cost. [I.C., § 40-320, as added by 1985, ch. 253, § 2, p. 586.]

DECISIONS UNDER PRIOR LAW

Power to Contract.

Highway district could enter into joint contract with state and United States for

construction of road and apportionment of cost. Grangeville Hwy. Dist. v. Ailshie, 49 Idaho 603, 290 P. 717 (1930).

40-321. Commercial enterprises on prohibited access highways prohibited — Exception — Connecting service highways. — No commercial enterprise or activity for serving motor vehicle users, other than emergency services for disabled vehicles and vending machines permitted under the provisions of federal law or federal rule and section 67-5411, Idaho Code, and board right-of-way use permit shall be conducted within or on any property designated as, or acquired for, or in connection with a prohibited access highway, as designated by the Idaho transportation board. However, the board may construct on that property, at locations it deems appropriate, connecting service highways parallel to the prohibited access highways in such manner as to facilitate the establishment and operation of commercial enterprises for serving motor vehicle users on private property abutting those service highways. [I.C., § 40-321, as added by 1985, ch. 253, § 2, p. 586.]

Compiler's notes. For words "this act," see compiler's notes, § 67-5401.

67-5411. Commission as sole licensing agency under the provisions of the Randolph-Sheppard vending stand act. — The commission is hereby designated as the sole licensing agency under the provisions of the Randolph-Sheppard vending stand act (P.L. 732, 74th Congress, 49 stat. 1559, as amended by section 4 of P.L. 565, 83rd Congress, 68 stat. 663; 20 U.S.C. 107, Chapter 6A). [1967, ch. 373, § 11, p. 1071.]

Compiler's notes. The material in parentheses so appeared in the law as enacted.

67-5412. Executive director to prepare a state plan for vocational rehabilitation of the blind. — The executive director of the commission shall prepare a state plan for vocational rehabilitation of the blind and after approved by the commission shall submit the same to the United States office of vocational rehabilitation for approval. [1967, ch. 373, § 12, p. 1071.]

Compiler's notes. Section 13 of S.L. 1967, ch. 373 is compiled as § 56-201.

Section 16 of S.L. 1967, ch. 373 read: "The provisions of this act are hereby declared to be separable and if any provision of this act or the application of such provision to any person or circumstance is declared invalid for any reason, such declaration shall not affect the validity of remaining portions of this act."

Section 17 of S.L. 1967, ch. 373, as amended by S.L. 1967 (1st E.S.), ch. 17, § 2, provided that subsections (1) and (3) of § 67-5403 should become effective July 1, 1967 and the remainder of the act should become effective October 1, 1967.

Section 4 of S.L. 1967 (1st E.S.), ch. 17 declared an emergency. Approved July 1, 1967.

67-5413. Food service facilities in public buildings to be operated by commission — Exceptions. — Any governmental agency which proposes to operate or continue a food service facility in a public building shall first attempt in good faith to make an agreement with the commission to operate the food service facility without payment of rent. The governmental agency shall not offer or grant any other party a contract or concession to operate such food service facility unless the governmental agency determines in good faith that the commission is not willing or cannot satisfactorily provide such food service. This section shall not impair any valid contract existing on the effective date of this section and shall not preclude renegotiation of such contract on the same terms and with the same parties.

With respect to all state, county and city buildings not defined in section 67-5402, Idaho Code, as a public building, the governmental agency in charge of the building shall consider allowing the commission to operate any existing or proposed food service facility in the building, and shall discuss such operation with the commission upon its request. [I.C., § 67-5413, as added by 1973, ch. 103, § 2, p. 176.]

GENERAL PROVISIONS

Cross references. — Georgia Highway Authority, § 32-10-60 et seq. Conflicts of Authority, § 32-10-1 et seq. State Tollway interest, § 45-10-20 et seq.

OPINIONS OF THE ATTORNEY GENERAL

Even for payment, a county may not lawfully scrape privately-owned driveways; the county's collection of a fee for providing this service would not, given the plain language of the statute, make the transaction lawful. 1976 Op. Att'y Gen. No. U76-24.

32-1-9. Enforcement of title by law enforcement officers.

It shall be the duty of all state and local law enforcement officers to enforce any provision of this title which states that any act or omission is unlawful. (Code 1933, § 95A-1103, enacted by Ga. L. 1973, p. 947, § 1.)

32-1-10. Penalty. †

(a) Any person who violates any of the provisions of this title for which no specific penalty is provided, whether or not such act or omission is expressly declared elsewhere in this title to be unlawful, or who violates any of the rules and regulations issued under authority of and in accord with the provisions of this title shall be guilty of a misdemeanor; provided, however, that a violation of Code Sections 32-6-26 and 32-6-27 shall not be considered a crime.

(b) In addition to the penalty provided for in subsection (a) of this Code section, the department shall have the right to enjoin any act or omission so punishable as a misdemeanor or punished otherwise as provided elsewhere in this title. (Code 1933, § 95A-1101, enacted by Ga. L. 1973, p. 947, § 1; Ga. L. 1978, p. 1989, § 4.)

OPINIONS OF THE ATTORNEY GENERAL

Promotion of safety and protection of public investment. — This section and §§ 32-6-23, 32-6-24, 46-7-61 and 46-7-78 are intended to promote safety of traveling public and protect public's investment in its roads and highways. 1981 Op. Att'y Gen. No. U81-17.

ARTICLE I
GENERAL PROVISIONS

32-6-1. Obstructing, encroaching on, or injuring public roads.

It shall be unlawful for any person to obstruct, encroach upon, solicit the sale of any merchandise on, or injure materially any part of any public road. However, nothing in this Code section shall abridge or limit any authority provided by law for the installation and operation of vending machines at welcome centers, tourist centers, and safety rest areas. (Code 1933, § 95A-903, enacted by Ga. L. 1973, p. 947, § 1; Ga L. 1979, p. 132, § 4.)

Cross references. — Further provisions regarding obstruction of public roads, § 16-11-43. Installation of vending machines in safety rest areas, § 32-6-116. Prohibition against interference with public roads, streets, etc., by mass picketing near site of labor dispute, § 34-6-5.

Law reviews. — For article, "Recommendations Regarding Control of Outdoor Advertising Along the Interstate Highway System in Georgia," see 14 Mercer L. Rev. 308 (1963).

JUDICIAL DECISIONS

Section does not apply to structures which are on private property adjacent to public roads. *Smith v. Hiawassee Hdwe. Co.*, 167 Ga. App. 70, 305 S.E.2d 805 (1983).

Department can require removal of obstructions. — The management and

control of the right of way of the state's system of roads is vested in the Department of Transportation, and the department can require the removal of any obstruction placed thereon without express permission. *Crider v. Kelley*, 232 Ga. 616, 208 S.E.2d 444 (1974).

RESEARCH REFERENCES

Am. Jur. 2d. — 39 Am. Jur. 2d. Highways, Streets, and Bridges, § 32.

C.J.S. — 40 C.J.S., Highways, §§ 218, 221, 222.

ALR. — Constitutionality of statute or ordinance imposing upon abutting owners or occupants duty in respect of care or condition of street or highway, 58 ALR 215.

Municipality's power to permit private owner to construct building or structure overhanging or crossing the air space above public street or sidewalk, 76 ALR2d 896.

Relative rights and liabilities of abutting owners and public authorities in parkways in center of street, 81 ALR2d 1436.

IDAHO

- Legislation

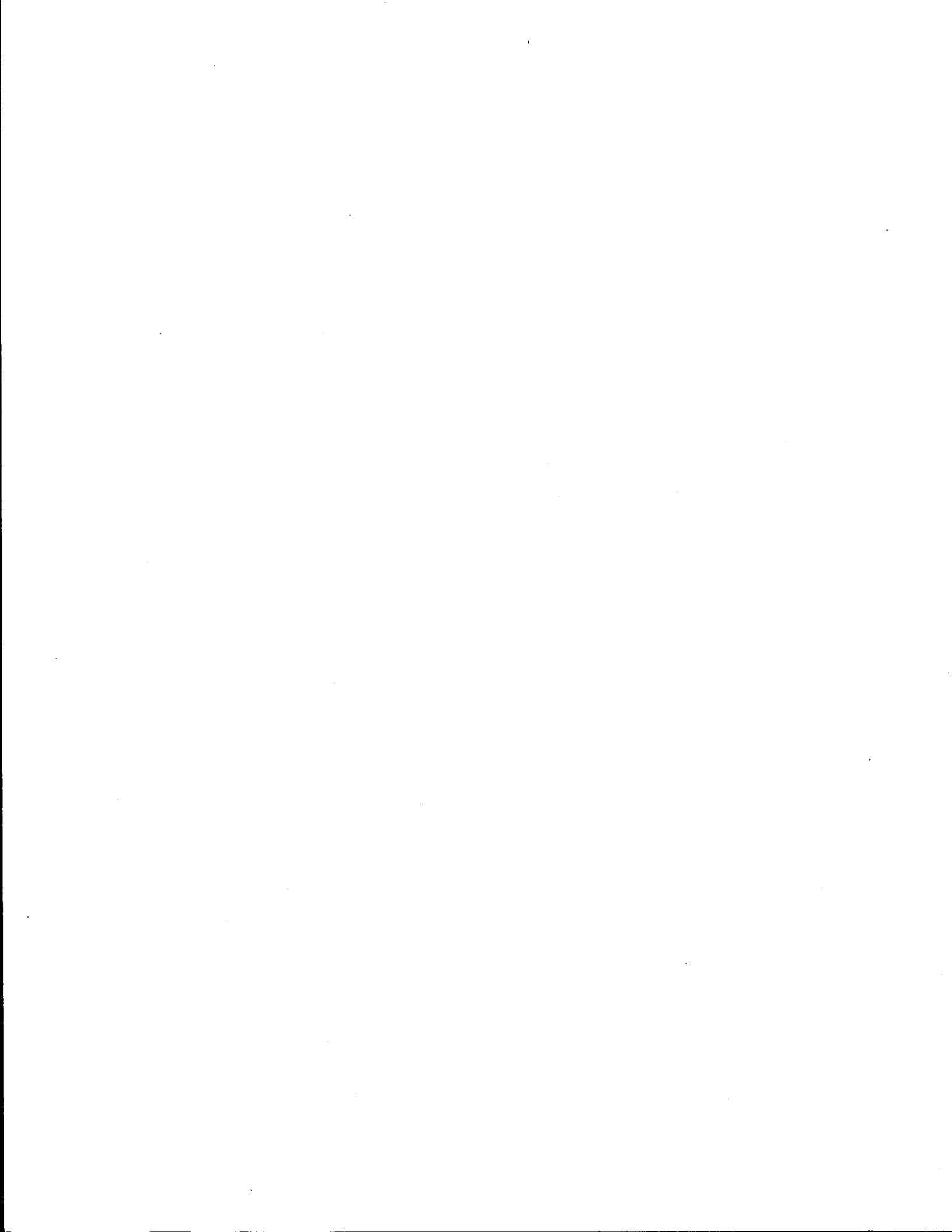

40-319. Good faith of state pledged to appropriation. — For the construction and maintenance of highways as may be eligible for federal aid funds, excepting turnpike projects, the good faith of the state is pledged to make available funds which combined with funds made available by counties, highway districts and cities sufficient to match funds made available to the state of Idaho by the United States government for highway purposes and for the purpose of evidencing good faith, the board in the name of the state, is authorized to enter into any and all agreements with the United States government under rules and regulations approved by the United States government or any of its agencies. [I.C., § 40-319, as added by 1985, ch. 253, § 2, p. 586.]

40-320. State highway construction and right-of-way costs borne by state — Exceptions. — All costs of constructing, reconstructing and acquiring rights-of-way for highways in the state highway system shall be borne by the state. However, when a county or incorporated city in which a state highway is located, or is to be located, desires a higher standard of construction or reconstruction than is planned, the county or city may, with the approval of the board, pay the additional cost. [I.C., § 40-320, as added by 1985, ch. 253, § 2, p. 586.]

DECISIONS UNDER PRIOR LAW

Power to Contract.

Highway district could enter into joint contract with state and United States for

construction of road and apportionment of cost. Grangeville Hwy. Dist. v. Ailshie, 49 Idaho 603, 290 P. 717 (1930).

40-321. Commercial enterprises on prohibited access highways prohibited — Exception — Connecting service highways. — No commercial enterprise or activity for serving motor vehicle users, other than emergency services for disabled vehicles and vending machines permitted under the provisions of federal law or federal rule and section 67-5411, Idaho Code, and board right-of-way use permit shall be conducted within or on any property designated as, or acquired for, or in connection with a prohibited access highway, as designated by the Idaho transportation board. However, the board may construct on that property, at locations it deems appropriate, connecting service highways parallel to the prohibited access highways in such manner as to facilitate the establishment and operation of commercial enterprises for serving motor vehicle users on private property abutting those service highways. [I.C., § 40-321, as added by 1985, ch. 253, § 2, p. 586.]

Compiler's notes. For words "this act," see compiler's notes, § 67-5401.

67-5411. Commission as sole licensing agency under the provisions of the Randolph-Sheppard vending stand act. — The commission is hereby designated as the sole licensing agency under the provisions of the Randolph-Sheppard vending stand act (P.L. 732, 74th Congress, 49 stat. 1559, as amended by section 4 of P.L. 565, 83rd Congress, 68 stat. 663; 20 U.S.C. 107, Chapter 6A). [1967, ch. 373, § 11, p. 1071.]

Compiler's notes. The material in parentheses so appeared in the law as enacted.

67-5412. Executive director to prepare a state plan for vocational rehabilitation of the blind. — The executive director of the commission shall prepare a state plan for vocational rehabilitation of the blind and after approved by the commission shall submit the same to the United States office of vocational rehabilitation for approval. [1967, ch. 373, § 12, p. 1071.]

Compiler's notes. Section 13 of S.L. 1967, ch. 373 is compiled as § 50-201.

Section 16 of S.L. 1967, ch. 373 read: "The provisions of this act are hereby declared to be separable and if any provision of this act or the application of such provision to any person or circumstance is declared invalid for any reason, such declaration shall not affect the validity of remaining portions of this act."

Section 17 of S.L. 1967, ch. 373, as amended by S.L. 1967 (1st E.S.), ch. 17, § 2, provided that subsections (1) and (3) of § 67-5403 should become effective July 1, 1967 and the remainder of the act should become effective October 1, 1967.

Section 4 of S.L. 1967 (1st E.S.), ch. 17 declared an emergency. Approved July 1, 1967.

67-5413. Food service facilities in public buildings to be operated by commission — Exceptions. — Any governmental agency which proposes to operate or continue a food service facility in a public building shall first attempt in good faith to make an agreement with the commission to operate the food service facility without payment of rent. The governmental agency shall not offer or grant any other party a contract or concession to operate such food service facility unless the governmental agency determines in good faith that the commission is not willing or cannot satisfactorily provide such food service. This section shall not impair any valid contract existing on the effective date of this section and shall not preclude renegotiation of such contract on the same terms and with the same parties.

With respect to all state, county and city buildings not defined in section 67-5402, Idaho Code, as a public building, the governmental agency in charge of the building shall consider allowing the commission to operate any existing or proposed food service facility in the building, and shall discuss such operation with the commission upon its request. [I.C., § 67-5413, as added by 1973, ch. 103, § 2, p. 176.]

ILLINOIS

- Legislation
- Exam

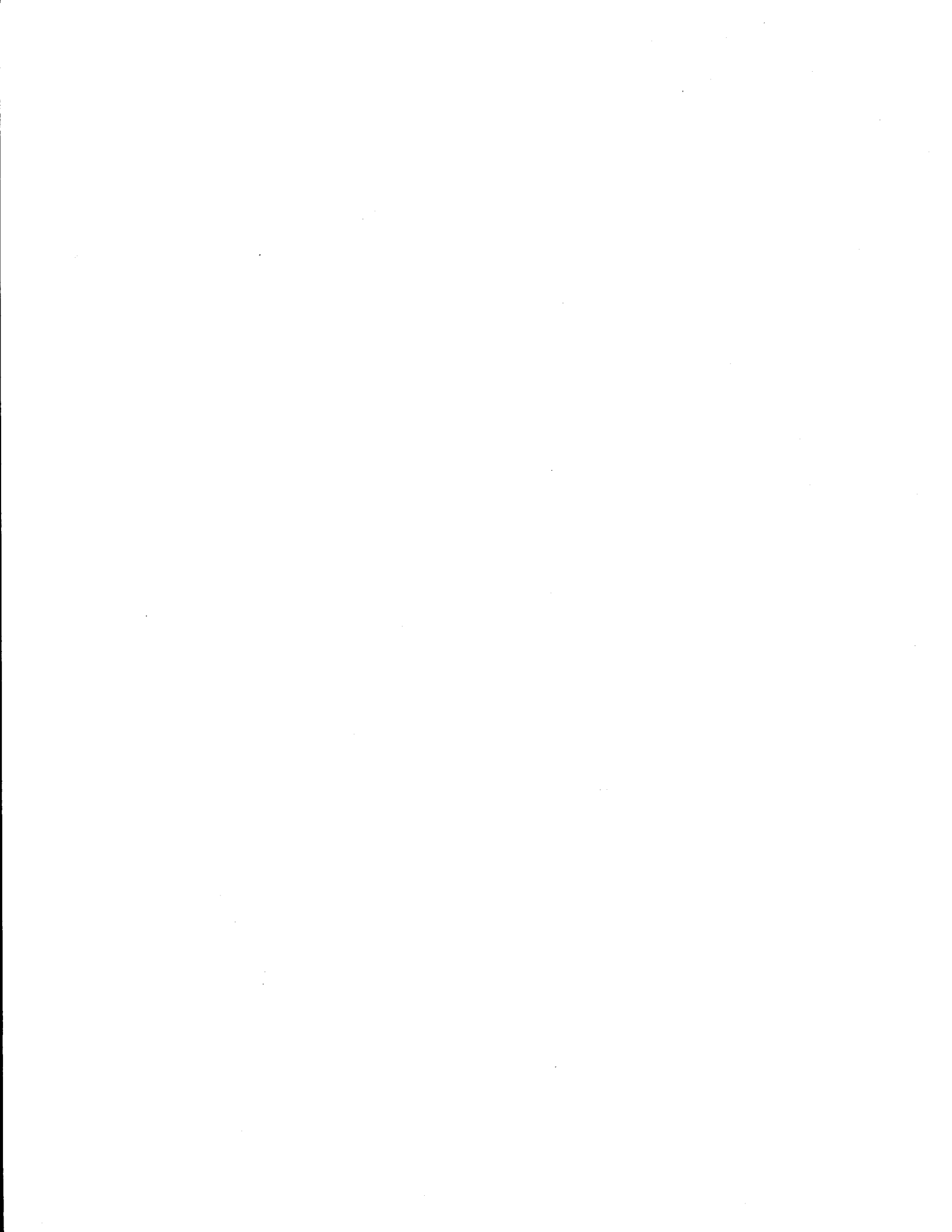

ILLINOIS

121 ¶ 8 - 106
Highway Code § 8 - 106

ROADS AND BRIDGES

176

ration of final construction plans, but only after reasonable notice has been given, and shall be conducted in accordance with rules and regulations prescribed by the Department. No crossings shall be eliminated which shall unduly discommode or interfere with local traffic, or will destroy reasonable access to schools, churches, markets, trade or community centers, and all crossings not eliminated shall be grade separated with the through traffic lanes of the interstate highway or the highway where the authority to control access has been exercised to permit access only at certain selected public roads. If the closing of a public way, as herein provided, makes it necessary to construct a new or additional highway connection to serve the public need, the Department and county board shall construct such connection. When property is damaged by the closing of any public way, the damage shall be ascertained and paid as provided by law.

Amended by P.A. 76-181, § 1, eff. July 1, 1969.

8-107. New highway intersections or crossings—Consent

§ 8-107. No new highway or other public way shall be opened into or connect with or be carried over or under any freeway until and unless the Department, the county board, or the corporate authorities of any municipality, as the case may be, consents thereto in writing, and the Department, county board, or the corporate authorities of any municipality, as the case may be, may give or withhold their respective consent or fix such terms and conditions as will best subserve the public interest.

8-107.1. Telephone service within rights-of-way of fully controlled access highways

§ 8-107.1. Subject to regulations prescribed by the Department, county board, or the corporate authorities of any municipality, as the case may be, such highway authority may issue permits to a telephone company for the establishment of telephone service within the rights-of-way of fully controlled access highways at points where proper access to and from the main traveled lanes has been established, and where such facilities are necessary to the safety and welfare of the highway users.

Added by Laws 1959, p. 1799, eff. July 21, 1959.

8-108. Continuation of existing freeways

§ 8-108. Any highway which prior to the effective date of this Code was a freeway shall continue to be a freeway under the provisions of this Article.

8-109. Cumulative powers

§ 8-109. The provisions of this Article are cumulative and shall be considered as conferring additional powers on the Department, the county board of any county, or the corporate authorities of any municipality and not as limitations upon powers now exercised by the Department, county board, or corporate authorities of any municipality with respect to highways under their respective jurisdiction and control.

ARTICLE 9. GENERAL HIGHWAY PROVISIONS

Par.

9-101. Cooperative agreements among governmental agencies.

9-101.1. Consultation with local agencies—Drainage.

Par.

9-102. Keeping vehicles off highways during construction or repairs—Erection of signs.

9-103. Removal of control devices or signs.

9-104. Corner stones.

9-105. Entrance culverts.

9-106. Oiling of roadways—Protection of intersecting all-weather highways.

9-107. Tile drains—Contract with owners or occupants of adjoining lands.

9-108. Willow hedges—Public nuisance.

9-109. Capacity of bridges or culverts—Violations.

9-110. Patented articles—Use for constructing or maintaining public highways, etc.

9-111. Weed control—Penalty.

9-111.1. Streams and culverts—Removal of driftwood and other accumulations.

9-112. Obstructions at grade crossings—Signs or signals.

9-112.1. Billboards or advertising.

9-112.2. Signs, billboards and advertising similar to traffic control signs or devices prohibited—Oscillating, rotating or flashing lights prohibited.

9-112.3. Shelters for public transportation passengers.

9-113. Use by public utilities company—Consent—Rules, regulations and specifications—Nontoll federal-aid fully access-controlled state highways.

9-113.01. Repair of damage caused by utilities—Local government.

9-113.1. Commercial establishments within right-of-way, etc.—Solicitation of donations at courtesy rest stop—Vending machines in safety rest areas.

9-114. Right of owner to make crossing—Costs.

9-115. Excavation or removal of lateral support—Deposit of spoil from excavations—Violations.

9-116. Hedge fences—Trimming—Violations.

9-117. Injuring or obstructing highways.

9-118. Planting along highway.

9-119. Penalty for destroying plants on highway—Trimming—Removing.

9-121. Depositing in highway of weeds, garbage, etc.—Penalty.

9-122. Injuring sidewalk, bridge, etc.—Penalty.

9-123. Discharge of sewage into open ditches along street or highway.

9-124. Camping on public highway prohibited—Violations—Duty of highway authorities.

9-124.1. Feeding stock, cows, etc. on public highway—Punishment.

9-125. Suits for recovery of fines or penalties.

9-126. Disposition of fines and penalties.

9-127. Title to vacated highways.

9-128. Damaging signs or traffic control devices.

9-129. Agricultural aircraft—Use of county highways or township roads—Liability for personal injuries.

9-130. Deposit of snow or ice upon public highway—Prohibition.

9-101. Cooperative agreements among governmental agencies

§ 9-101. Nothing in this Code shall prevent the execution of cooperative agreements among governmental agencies.

Any municipality may negotiate an agreement with the Department whereby the municipality may use such funds as are available to it for that purpose for the construction or maintenance of a State highway within its boundaries or with the corporate authority of a county or road district for the construction or maintenance of a highway on the county highway system or township or district road system outside of its municipal boundaries.

The county board may negotiate an agreement with the Department whereby the county may use such funds as are available to it for that purpose for the construction or maintenance of a highway on the State highway system or with a municipality for the construction or maintenance of streets on the municipal street system of such municipality.

9-101.1. Consultation with local agencies—Drainage

§ 9-101.1. Whenever the proper highway authority is about to construct or improve the drainage structures of a State highway, county highways, or county unit district road, the highway authority shall meet and consult with the authorities of any municipality adjacent to or through which such highway or road runs. The purpose of such meetings is to work out an agreement with such municipality and all other interested agencies and units of local government as to the extent of such drainage construction or improvement.

Added by P.A. 77-718, § 1, eff. Aug. 12, 1971.

9-102. Keeping vehicles off highways during construction or repairs—Erection of signs

§ 9-102. The proper highway authorities are authorized to keep vehicles of every kind off the public highways where necessary to properly construct or repair the same.

Whenever any public highway including any bridge or culvert thereon is being constructed or repaired, the highway authorities having such work in charge shall, when they deem it necessary, erect or cause to be erected at such points as they deem desirable, suitable barriers, with signs thereon, stating that such highway is closed, and by whose order.

Such authorities shall also erect or cause to be erected at such places as they deem best, detour signs directing travel around such construction or repair work.

Such signs and barricades shall conform to the Manual of Uniform Traffic Control Devices adopted by the Department.

Amended by Laws 1961, p. 3509, eff. Aug. 18, 1961.

9-103. Removal of control devices or signs

§ 9-103. Whenever a highway has been closed as provided in Section 9-102 or wherever traffic control devices or signs have been erected on any public highway as provided under this Code it is unlawful for any person to remove any such barrier, traffic control device or sign, or to deface or injure the same, or to walk, ride or drive upon any part of such highway so closed, except such persons as are duly authorized to do so.

Whoever knowingly violates the provisions of this Section shall be guilty of a Class B misdemeanor, punishable by a fine of at least \$250, as well as any other penalty which may be imposed. In addition thereto, such person convicted shall be held liable for any and all damages caused to such highway, including, but not limited to, any

bridge or culvert work, traffic control device or sign, by reason of such violation.

The highway authorities or their duly authorized agents in direct charge of the work, are authorized to exercise in their respective jurisdictions, all the common law and statutory powers conferred upon sheriffs, and such highway authorities, or their duly authorized agents in direct charge of the work aforesaid, shall arrest without process any person who violates the provisions of this Section, and in so doing they shall be held to be acting for the State.

Any person or persons so arrested shall be delivered by the person making the arrest to some judge, sheriff, or police officer at some station or place within the county in which the offense was committed, for trial, according to law.

Amended by P.A. 83-672, § 2, eff. Jan. 1, 1984.

9-104. Corner stones

§ 9-104. In grading highways corner stones marking sectional or other corners shall not be disturbed, except to lower such stones so that they will not rise above the surface of the highway. If a corner stone is covered to a depth greater than 12 inches or is covered with a highway surfacing material other than road oil, the location of the corner stone shall be preserved by setting a suitable monument over the stone which shall be level with the highway surface or by setting at least 3 offset monuments in locations where they will not be disturbed. When any corner stone is lowered or when a monument is set over a stone or when offset monuments are set it shall be done in the presence of and under the supervision of a Registered Illinois Land Surveyor who shall record the type and location of the reference monuments with respect to the corner stone in the office of the recorder in the county in which such stone is located.

9-105. Entrance culverts

§ 9-105. In constructing a public highway, if a ditch is made at the junction of highways, or at the entrance of gates or other openings of adjoining premises, the highway authorities shall construct good and sufficient culverts or other convenient crossings. New entrance culverts or crossings or additions to existing entrance culverts or crossings along an existing public highway or street where there is a ditch may be made with the consent of the highway authorities, provided the applicant for such entrance culvert or crossing constructs at the applicant's expense a good and sufficient culvert or other convenient crossing of the type and size specified by the highway authorities, which structure shall then become the property of the public.

9-106. Oiling of roadways—Protection of intersecting all-weather highways

§ 9-106. Wherever a highway, driveway, parking lot or other area open to traffic that has been freshly treated with road oil, liquid asphalt or similar material intersects with or is otherwise located or partially located within 300 feet of a durable all-weather highway of any type except gravel or crushed stone, the highway authorities or any person responsible for applying such material shall cause such freshly treated highway, driveway, parking lot or other such area to be barricaded or covered with crushed aggregate or other suitable cover material so that traffic will not carry the fresh road oil, liquid asphalt or similar

material onto the travel ways of the durable all-weather highway.

Amended by P.A. 80-528, § 1, eff. Oct. 1, 1977.

9-107. Tile drains—Contract with owners or occupants of adjoining lands

§ 9-107. Whenever the highway authorities are about to lay a tile drain along any public highway the highway authorities may contract with the owners or occupants of adjoining lands to lay larger tile than would be necessary to drain the highway, and permit connection therewith by such contracting parties to drain their lands.

However, all such contracts on township or district roads for a sum in excess of \$1,000.00 shall be made on behalf of any road district by the highway commissioner thereof, with the consent of the county superintendent of highways.

Amended by Laws 1961, p. 2815, eff. Aug. 4, 1961.

9-108. Willow hedges—Public nuisance

§ 9-108. Where willow hedges, or a line of willow trees have been planted along the margin of a highway, so as to render tiling impracticable, the highway authority having jurisdiction of such highway may contract with the owner for their destruction; and they shall be destroyed before tiling. The planting of such hedges or trees hereafter on the margin of highways is declared to be a public nuisance.

9-109. Capacity of bridges or culverts—Violations

§ 9-109. It is unlawful to construct any bridge or culvert upon any ravine, creek, drainage ditch or river upon a public highway in this State unless such bridge or culvert shall have the capacity of sustaining highway traffic with safety.

Any person who violates the provisions of this Section shall be guilty of a petty offense.

The fact that any such bridge or culvert does not conform with the specifications of the Department in effect at the time when the contract for such bridge or culvert is let, is prima facie evidence that the bridge or culvert does not have the capacity of sustaining highway traffic with safety.

Amended by P.A. 77-2238, § 1, eff. Jan. 1, 1973.

9-110. Patented articles—Use for constructing or maintaining public highways, etc.

§ 9-110. Any article, material or process covered by a patent granted by the United States government may be specified and used for constructing or maintaining any public highway if such specifications are drawn so as to provide for an alternative method or methods of construction or maintenance so that competition may be had between different types of materials answering the same general purpose.

9-111. Weed control—Penalty

§ 9-111. The highway authorities shall annually, at the proper season, to prevent the spread of noxious weeds as defined in the "Illinois Noxious Weed Law", approved August 17, 1971, as amended,¹ destroy or cause to be destroyed, all such noxious weeds growing upon public highways under their respective jurisdictions. The Highway authorities shall seasonably mow or manage all weeds

and other vegetation growing along the highways under their respective jurisdictions.

Any highway officer failing to comply with the provisions of this Section shall be guilty of a petty offense and shall be liable to a fine of not less than \$10 nor more than \$25 for each season in which he neglects such requirements.

Amended by P.A. 83-333, § 69, eff. Sept. 14, 1983.

¹ Chapter 5, § 951 et seq.

9-111.1. Streams and culverts—Removal of driftwood and other accumulations

§ 9-111.1. The highway authorities shall from time to time inspect the bridges and culverts on the public highways and streets under their respective jurisdictions which span streams and watercourses and shall remove driftwood and other materials accumulated within the right of way at such structures which obstruct the free flow of either low or high water. Any general funds, and any forces and equipment available for maintenance of the public highways or streets may be used for the removal of such accumulated material.

Added by Laws 1961, p. 2627, eff. Aug. 2, 1961.

9-112. Obstructions at grade crossings—Signs or signals

§ 9-112. At all grade crossings of public highways with railroads outside the corporate limits of any municipality, the highway authority having jurisdiction of such highways shall remove, or cause to be removed from the highway all removable obstructions to view at such grade crossings, such as unauthorized signs and billboards, brush and shrubbery, and shall trim, or cause to be trimmed, all hedges and trees upon the highway for a distance of not less than 300 feet from each side of such crossings.

No person shall place, or cause to be placed, any sign or signal on a public highway within a distance of 300 feet of any grade crossing, except official traffic control devices authorized in an Act in relation to the regulation of traffic, approved July 9, 1935, as now or hereafter amended.¹ Any signs or signals required by law or the Illinois Commerce Commission for the protection of such crossings.

Any person who violates any of the provisions of this Section shall be guilty of a petty offense and fined not less than \$10 nor more than \$100 for each offense.

Amended by P.A. 77-2238, § 1, eff. Jan. 1, 1973.

¹ Chapter 95½, § 114(a) (repealed).

9-112.1. Billboards or advertising

§ 9-112.1. No person shall place or cause to be placed any sign or billboard or any advertising of any kind or description upon any State highway or on any other highway outside the corporate limits of any municipality except as may be required by this Code or "The Illinois Vehicle Code", as now or hereafter amended.¹ This provision also shall apply to signs, billboards, or any other advertising upon any bridge, other structure, wire, cable, or other device, over or above such highway, whether constructed by the Department or others except signs designating the name of the railroad and the clearance provided. This Section does not prohibit or prevent any public utility from placing upon, above, below or near any of its facilities any signs or markers giving notice of the existence, identification or location of such facilities located

ed upon or adjacent to any such highway. Such signs or markers shall be limited in size and shape to the minimum necessary consistent with the safety of the public in accordance with rules and regulations as promulgated by the Department.

Any person who violates any of the provisions of this Section shall be guilty of a petty offense and fined not less than \$10 nor more than \$100 for each offense.

Amended by P.A. 81-840, § 49, eff. Sept. 19, 1979.

¹ Chapter 95½, ¶ 1-100 et seq.

9-112.2. Signs, billboards and advertising similar to traffic control signs or devices prohibited—Oscillating, rotating or flashing lights prohibited

§ 9-112.2. No person shall place, or cause to be placed upon or in view of any public highway any sign or billboard or any advertising of any kind or description which in wording, color or shape is similar to official traffic control signs or other official traffic control devices erected by the proper authority having jurisdiction over such highway in compliance with the Manual of Uniform Traffic Control Devices for Streets and Highways, as now or hereafter adopted by the Department.

No person shall place, or cause to be placed upon any building or other structure, within 200 feet of any public highway, oscillating, rotating or flashing lights which are of such intensity, when illuminated, to be visible at any time from such highway. This prohibition does not apply to a pole-supported business or brand identification sign with constant illumination and color and in which the only movement is a slow rotation of the entire body of the sign so as to be visible from all directions. This prohibition does not apply to airport lights.

Any person who violates any of the provisions of this Section shall be guilty of a petty offense and fined not less than \$10 nor more than \$100 for each offense.

Amended by P.A. 78-255, § 51, eff. Oct. 1, 1973.

9-112.3. Shelters for public transportation passengers

§ 9-112.3. Shelters for the convenience and comfort of persons waiting for buses or other public transportation may be placed and maintained within the right of way of any street or highway, including right of way for streets and highways within municipalities, after a license or permit for the shelter and location is obtained from the highway authority having jurisdiction. Placement and location of shelters on any street or highway within a municipality shall be subject to the approval of the corporate authorities of such municipality. The owners may place advertising on the shelters if authorized by the license or permit, provided, however, that no political advertising shall be placed on any shelter on any street or highway at any time and further provided that advertising on shelters shall be limited to one-third of the vertical surface of the shelter. Shelters shall not be placed or maintained on that portion of the right of way designed and used for vehicle traffic and further shall not be so placed as to impair the street or highway or interfere with the free and safe flow of traffic.

Added by P.A. 81-436, § 1, eff. Jan. 1, 1980.

III Road and Bridge Laws—
1984 Edition

9-113. Use by public utilities company—Consent—Rules, regulations and specifications—Non-toll federal-aid fully access-controlled state highways

§ 9-113. (a) No ditches, drains, track, rails, poles, wires, pipe line or other equipment of any public utility company, municipal corporation or other public or private corporation, association or person shall be located, placed or constructed upon, under or along any highway, or upon any township or district road, other than a highway or road within a municipality without first obtaining the written consent of the appropriate highway authority as hereinafter provided for in this Section.

(b) The State highway authority is authorized to promulgate reasonable and necessary rules, regulations and specifications for State highways for the administration of this Section.

(c) In the case of non-toll federal-aid fully access-controlled State highways, the State highway authority shall not grant consent to the location, placement or construction of ditches, drains, track, rails, poles, wires, pipe line or other equipment upon, under or along any such non-toll federal-aid fully access-controlled State highway, which:

(1) would require cutting the pavement structure portion of such highway for installation or, except in the event of an emergency, would require the use of any part of such highway right-of-way for purposes of maintenance or repair. Where, however, the State highway authority determines prior to installation that there is no other access available for maintenance or repair purposes, use by the entity of such highway right-of-way shall be permitted for such purposes in strict accordance with the rules, regulations and specifications of the State highway authority, provided however, that except in the case of access to bridge structures, in no such case shall an entity be permitted access from the through-travel lanes, shoulders or ramps of the non-toll federal-aid fully access-controlled State highway to maintain or repair its accommodation; or

(2) would in the judgment of the State highway authority, endanger or impair any such ditches, drains, track, rails, poles, wires, pipe lines or other equipment already in place; or

(3) would, if installed longitudinally within the access control lines of such highway, be above ground after installation except that the State highway authority may consent to any above ground installation upon, under or along any bridge, interchange or grade separation within the right-of-way which installation is otherwise in compliance with this Section and any rules, regulations or specifications issued hereunder; or

(4) would be inconsistent with Federal law or with rules, regulations or directives of appropriate Federal agencies.

(d) In the case of accommodations upon, under or along non-toll federal-aid fully access-controlled State highways the State highway authority may charge an entity reasonable compensation for the right of that entity to longitudinally locate, place or construct ditches, drains, track, rails, poles, wires, pipe line or other equipment upon, under or along such highway. Such compensation may include in-kind compensation.

Where the entity applying for use of a non-toll federal-aid fully access-controlled State highway right-of-way is a public utility company, municipal corporation or other public or private corporation, association or person, such com-

pensation shall be based upon but shall not exceed a reasonable estimate by the State highway authority of the fair market value of an easement or leasehold for such use of the highway right-of-way. Where the State highway authority determines that the applied-for use of such highway right-of-way is for private land uses by an individual and not for commercial purposes, the State highway authority may charge a lesser fee than would be charged a public utility company, municipal corporation or other public or private corporation or association as compensation for the use of the non-toll federal-aid fully access-controlled State highway right-of-way. In no case shall the written consent of the State highway authority give or be construed to give any entity any easement, leasehold or other property interest of any kind in, upon, under, above or along the non-toll federal-aid fully access-controlled State highway right-of-way.

Where the compensation from any entity is in whole or in part a fee, such fee may be reasonably set, at the election of the State highway authority, in the form of a single lump sum payment or a schedule of payments. All such fees charged as compensation may be reviewed and adjusted upward by the State highway authority once every 5 years provided that any such adjustment shall be based on changes in the fair market value of an easement or leasehold for such use of the non-toll federal-aid fully access-controlled State highway right-of-way. All such fees received as compensation by the State highway authority shall be deposited in the Road Fund.

(e) Any entity applying for consent shall submit such information in such form and detail to the appropriate highway authority as to allow the authority to evaluate the entity's application. In the case of accommodations upon, under or along non-toll federal-aid fully access-controlled State highways the entity applying for such consent shall reimburse the State highway authority for all of the authority's reasonable expenses in evaluating that entity's application, including but not limited to engineering and legal fees.

(f) Any ditches, drains, track, rails, poles, wires, pipe line or other equipment located, placed or constructed upon, under or along a State highway with the consent of the State highway authority under this Section shall, upon written notice by the State highway authority be subject to removal, relocation or modification at no expense to the State highway authority when and as deemed necessary by the State highway authority for highway or highway safety purposes. If, within 60 days after receipt of such written notice, arrangements are not made satisfactory to the State highway authority for such removal, relocation or modification, the State highway authority may remove, relocate or modify such ditches, drains, track, rails, poles, wires, pipe line or other equipment and bill the owner thereof for the total cost of such removal, relocation or modification. The State highway authority shall determine the terms of payment of those costs provided that all costs billed by the State highway authority shall not be made payable over more than a 5 year period from the date of billing. This paragraph shall not be construed to prohibit the State highway authority from paying any part of the cost of removal, relocation or modification where such payment is otherwise provided for by State or federal statute or regulation.

(g) It shall be the sole responsibility of the entity, without expense to the State highway authority, to maintain and repair its ditches, drains, track, rails, poles, wires, pipe

line or other equipment after it is located, placed or constructed upon, under or along any State highway and in no case shall the State highway authority thereafter be liable or responsible to the entity for any damages or liability of any kind whatsoever incurred by the entity or to the entity's ditches, drains, track, rails, poles, wires, pipe line or other equipment.

(h) Upon receipt of an application therefor, consent to so use a highway may be granted subject to such terms and conditions not inconsistent with this Code as the highway authority deems for the best interest of the public. The petitioner shall pay to the owners of property abutting upon the affected highways established as though by common law plat all damages the owners may sustain by reason of such use of the highway, such damages to be ascertained and paid in the manner provided by law for the exercise of the right of eminent domain.

(i) Such consent shall be granted by the Department in the case of a State highway; by the county board or its designated county superintendent of highways in the case of a county highway; by either the highway commissioner or the county superintendent of highways in the case of a township or district road, provided that if consent is granted by the highway commissioner, the petition shall be filed with the commissioner at least 30 days prior to the proposed date of the beginning of construction, and that if written consent is not given by the commissioner within 30 days after receipt of the petition, the applicant may make written application to the county superintendent of highways for consent to the construction. This Section does not vitiate, extend or otherwise affect any consent granted in accordance with law prior to the effective date of this Code to so use any highway.

(j) Nothing in this Section shall limit the right of a highway authority to permit the location, placement or construction or any ditches, drains, track, rails, poles, wires, pipe line or other equipment upon, under or along any highway or road as a part of its highway or road facilities or which the highway authority determines is necessary to service facilities required for operating the highway or road, including rest areas and weigh stations.

(k) Paragraphs (c) and (d) of this Section shall not apply to any accommodation located, placed or constructed with the consent of the State highway authority upon, under or along any non-toll federal-aid fully access-controlled State highway prior to July 1, 1984, provided that accommodation was otherwise in compliance with the rules, regulations and specifications of the State highway authority.

(l) The consent to be granted pursuant to this Section by the appropriate highway authority shall be effective only to the extent of the property interest of the State or government unit served by that highway authority. Such consent shall not be binding on any owner of the fee over or under which the highway or road is located and shall not otherwise relieve the entity granted that consent from obtaining by purchase, condemnation or otherwise the necessary approval of any owner of the fee over or under which the highway or road is located. This paragraph shall not be construed as a limitation on the use for highway or road purposes of the land or other property interests acquired by the public for highway or road purposes, including the space under or above such right-of-way.

Amended by P.A. S3-1363, § 1, eff. Sept. 11, 1984.

9-113.01. Repair of damage caused by utilities—Local government

§ 9-113.01. Except when otherwise provided for by contract, permit or ordinance, a unit of local government having jurisdiction over streets or roads may repair damage to any such streets or roads caused by a public or private utility and bill the utility for the cost thereof if the utility fails to complete such repairs within 30 days after receipt of written notice from the unit of local government that such repairs must be made. Primary responsibility for such repairs shall remain with the utility.

As used in this Section, "unit of local government" means a county, municipality, township or other unit designated as a unit of local government by law.

Added by P.A. 81-1377, § 1, eff. Aug. 9, 1980.

9-113.1. Commercial establishments within right-of-way, etc.—Solicitation of donations at courtesy rest stop—Vending machines in safety rest areas

§ 9-113.1. (a) Except as otherwise provided in Sections 4-201.19 and 8-107.1 of this Code and in subsection (b) of this Section, and except to the extent authorized in "An Act in relation to the construction, operation, regulation and maintenance of a system of toll highways and to create The Illinois State Toll Highway Authority, and to define its powers and duties, to make an appropriation in conjunction therewith", approved August 7, 1967, as amended,¹ no commercial establishment for serving motorists or highway users shall be constructed or located within the right-of-way of, or on publicly-owned or publicly-leased land acquired or used for or in connection with a highway. Nothing in this Act shall affect or impair the application of Sections 4-210 and 4-211 of the Illinois Highway Code, as now or hereafter amended to that portion of any highway where the rights of direct private access thereto generally from abutting property have not been extinguished by due process.

Nothing in this Code shall prohibit the solicitation of donations or contributions by a local nonprofit organization at a courtesy rest stop which has been established by that organization. A courtesy rest stop is a temporary facility, locally sponsored, to encourage safety only on nationally recognized holidays by promoting a "refreshment break" for motorists. The courtesy rest stop must be conducted for the express purpose of improving the safety of highway travel and not primarily as an advertisement for any organization or other activity.

All courtesy rest stop activity shall be conducted completely within existing safety rest areas located on free-ways or other State highways and only on those days recognized as national holidays. Before granting authorization to establish a courtesy rest area, the Department shall determine that sufficient parking in the safety rest area or stop is available without requiring vehicles to stop or park on any ramp or other surface used for the movement of vehicles. The refreshments and any other service offered must be free of charge to the motorists. However, solicitation of free-will donations or contributions shall be permitted. The Department shall cooperate with the sponsoring organizations in the establishment of courtesy rest stops.

(b) The Department may permit the placement and operation of vending machines in safety rest areas constructed or located on rights-of-way of non-toll fully access con-

trolled State highways. The Department shall adopt rules and regulations governing the type of services provided, location and operation of machines, and all other aspects necessary to provide the best public service consistent with federal and State statutes. The Department, when allowing for the installation of vending machines, shall provide for the operation of such facilities through the Department of Rehabilitation Services, which is the State licensing agency designated pursuant to Section 2(a)(5) of the federal Randolph-Sheppard Vending Stand Act of June 20, 1936 (49 Stat. 1559, Title 20, Sections 107-107F).² The Department of Rehabilitation Services shall assign licensed blind vendors to operate these vending facilities. However, if, after notification to all licensed blind vendors of the availability of a particular site, none is interested in operating that site, the Department of Rehabilitation Services may contract for the operation of that site by a private contractor. Any income, after deduction for cost of items, labor and a negotiated percentage of profit, shall accrue to the Department of Rehabilitation Services for the exclusive benefit of the vending facilities for the blind program or other programs of rehabilitation and training for the blind administered by the Department of Rehabilitation Services. The Department of Rehabilitation Services shall periodically notify licensed blind vendors of the availability of such contractually operated sites and make them available to interested licensed blind vendors.

(c) The Department of Transportation may not charge the operators of vending facilities for any portion of the cost of rest area maintenance or oversight services provided by its employees prior to the effective date of this amendatory Act of 1985. The Department shall not require the vending machine operators to perform any services other than those related to servicing and operating the approved vending machines.

Amended by P.A. 84-1308, Art. II, § 166, eff. Aug. 25, 1986.

¹ Paragraph 100-1 et seq. of this chapter.

² 20 U.S.C.A. § 107 et seq.

Article II of P.A. 84-1308, the First 34th General Assembly Combining Revisory Act, resolved multiple actions in the 84th General Assembly and made certain technical corrections.

9-114. Right of owner to make crossing—Costs

§ 9-114. Any person owning, using, or occupying lands on both sides of any public highway has the privilege of making a crossing under the highway for the purpose of letting his cattle and other domestic animals across such highway. However, such person shall erect at his own expense, a good and substantial bridge, with good railings on each side thereof, and build an embankment of easy grade, on either side of the bridge. The bridge shall be not less than 16 feet wide, and be approved by the appropriate highway authorities having jurisdiction of such public highway. The bridge shall be kept constantly in good repair by the owner or occupant of the land, the construction subject always to the consent and approval of such appropriate highway authorities.

In case such crossing is made on any waterway or natural channel for water and where a culvert or bridge is maintained as required for highway purposes, the owners or occupants shall not be required to pay for or construct any more of the crossings than the additional cost of such crossing over and above the necessary cost of a suitable culvert or bridge for highway purposes at such place.

9-115. Excavation or removal of lateral support—Deposit of spoil from excavations—Violations

§ 9-115. It is unlawful for any person to excavate or remove or cause the excavation or removal of the lateral support within a distance of 10 feet plus one and one-half times the depth of any excavation adjacent to the established right-of-way of any public highway located outside the corporate limits of any municipality, except that if any of the excavated materials be of solid rock, the depth of such solid rock shall not be considered in computing the limit of excavation from such right-of-way line of such public highway.

It is unlawful for any person to deposit spoil or cause the spoil from any excavation to be deposited in such a manner that the toe of such spoil will be nearer than 20 feet to any established right-of-way of any public highway located outside the corporate limits of any municipality.

Whenever any person violates or causes the foregoing provisions of this Section to be violated, he shall be guilty of a petty offense for each day such violation occurs and until such unlawful excavation is backfilled or unlawful spoil banks are removed, either by the offenders or by the public authorities as provided hereinafter in this Section.

Where any such violation occurs along any public highway the proper highway authority having jurisdiction of that particular highway is authorized to take the necessary steps as required by law to enter upon the property where such violation occurs and backfill or cause to be backfilled the unlawful excavation or remove or cause to be removed the unlawful spoil banks, whichever case it may be, or both, in such a manner as will conform with the foregoing provisions of this Section, and the costs of such work, together with court costs, may be recovered from such violators in the circuit court in the county where such violation occurred.

Nothing in this Section shall prohibit the construction and maintenance of grade separation crossings of any public utility, private corporation or individuals, or in any way conflict with any other laws governing such grade separations; nor shall the provisions of this Section in any way apply to pipe line construction or maintenance where such work is done to the satisfaction of the highway authorities having jurisdiction over such public highway; nor to the excavation of earth necessary for the construction of foundations or basement walls.

Amended by P.A. 33-345, § 82, eff. Sept. 14, 1983.

9-116. Hedge fences—Trimming—Violations

§ 9-116. The owner of any hedge fence growing along the right-of-way line of any public highway shall during the year next after such hedge has obtained the age of 7 years and during each year thereafter, trim such hedge fence to a height not exceeding 5 feet, except for Osage hedge which shall be trimmed annually after the second year from the first trimming to a height not exceeding 4 feet, and the owner shall trim all such hedges on the road side so that foliage will not extend over the right-of-way line for a distance in excess of 4 feet. All such trimming so required shall be done prior to October first.

The highway authority having jurisdiction over the highway, upon application of the owner of a farm, may permit such owner to grow a hedge fence to any desired height for a distance not to exceed one-fourth the total length of the hedge fence along the highway to serve as a wind-break for livestock. Such permit is revocable at any time.

The provisions of this Section do not apply to any hedge protecting either an orchard or a building.

Any failure or refusal to comply with the provisions of this Section is a petty offense and is punishable by a fine of not less than \$10 nor more than \$50 for each year of such failure or refusal.

Amended by P.A. 77-2238, § 1, eff. Jan. 1, 1973.

9-117. Injuring or obstructing highways

§ 9-117. If any person injures or obstructs a public highway by felling a tree or trees in, upon or across the same, or by placing or leaving any other obstruction thereon, or encroaching upon the same with any fence, or by plowing or digging any ditch or other opening thereon, or by turning a current of water so as to saturate, wash or damage the same, or by plowing in or across or on the slopes of the side gutters or ditches, or by placing any material in such ditches, or in any way interfering with the free flow of water therein, or leaves the cuttings of any hedge thereon for more than 10 days, without the permission of the highway authority having jurisdiction over such highway, he shall be guilty of a petty offense and fined for every such offense not less than \$10 nor more than \$100; and in case of placing any obstruction on the highway, an additional sum of not exceeding \$10 per day for every day he allows such obstruction to remain after he has been ordered to remove it by the highway authority having jurisdiction over such highway. Any person feeling himself aggrieved or any such highway authority may make a complaint under this Section.

The highway authority having jurisdiction over such highway, after having given 10 days' notice to the owners of the obstruction or person so obstructing, or plowing, or digging ditches upon such highway or interfering with the free flow of water in the side gutters or ditches, of the obstruction, plowing or digging of ditches, interfering with drainage, or of the encroachment of any fence, may remove any such fence or other obstruction, fill up any ditch or excavation except ditches necessary to the drainage of an adjoining farm emptying into a ditch upon the highway, or regrade such side gutters or ditches, and recover the necessary cost of such removal or filling of any such ditch or excavation, or regrading of such side gutters or ditches from such owner or other person obstructing or damaging such highway aforesaid, to be collected by the highway authority having jurisdiction of the highway whereon such offense was committed. Any such cost recovered shall be deposited in the road fund of the political division having jurisdiction over the highway adjudged to have been obstructed or injured, and shall be used only for maintenance or construction of public highways under the jurisdiction of that division.

However, this section shall not apply to any person who shall lawfully fell any tree for use and shall immediately remove the same out of the highway, nor to any person through or along whose land a public highway may pass, who shall desire to drain his land, and who shall give due notice to the proper highway authority of such intention, and who shall first secure from such highway authority written permission for any work, ditching or excavating he proposes to do within the limits of the highway.

Amended by P.A. 77-2238, § 1, eff. Jan. 1, 1973.

9-118. Planting along highway

§ 9-118. Any association, society, person or persons may, upon obtaining a permit from the highway authority

ties having jurisdiction over the particular highway, and the consent in writing of the owners of adjacent property, plant or set out trees, shrubs, plants or flowers in or upon the right-of-way of any highway within this State, provided that no such tree, shrub, or flower shall be permitted to obstruct the vision of persons traveling upon or across such highways.

9-119. Penalty for destroying plants on highway—Trimming—Removing

§ 9-119. Whoever wilfully drives upon, picks, removes, destroys, cuts down, or in any manner injures any tree, shrub, plant or flower planted or growing within the right-of-way of any public highway, shall be guilty of a petty offense and fined not more than \$100. However, the provisions of this section shall not preclude the highway authority having jurisdiction over the highway from trimming, transplanting, or removing such trees, shrubs, plants or flowers when necessary, in the discretion of such authority, to facilitate the use of such highways for public travel.

Amended by P.A. 77-2238, § 1, eff. Jan. 1, 1973.

9-121. Depositing in highway of weeds, garbage, etc.—Penalty

§ 9-121. It is unlawful for any person to deposit in a public highway or rest area weeds, trash, garbage or other offensive matter or any broken bottles, glass, boards containing projecting nails or any other thing likely to cause punctures in the tires of motor vehicles; and any person so offending shall be guilty of a petty offense. However, this Section shall not apply to proper deposits of harmless materials made in good faith and in a proper manner to repair the roads or to the proper disposal of travel and picnic trash in the waste containers provided for such purpose at rest areas.

Amended by P.A. 81-551, § 1, eff. Jan. 1, 1980.

9-122. Injuring sidewalk, bridge, etc.—Penalty

§ 9-122. If any person purposely destroys or injures any sidewalk, public bridge, culvert, or causeway, or removes any of the timber or plank thereof, or obstructs the same, he shall be guilty of a petty offense, fined not more than \$100, and shall be liable for all damages occasioned thereby and all necessary costs for rebuilding or repairing the same.

Amended by P.A. 77-2238, § 1, eff. Jan. 1, 1973.

9-123. Discharge of sewage into open ditches along street or highway

§ 9-123. No person, firm, corporation, or institution, public or private, shall discharge or empty any type of sewage, including the effluent from septic tanks or other sewage treatment devices, or any other domestic, commercial or industrial waste, or any putrescible liquids, or cause the same to be discharged or emptied in any manner into open ditches along any public street or highway, or into any drain or drainage structure installed solely for street or highway drainage purposes.

Any person, firm, corporation, or institution, public or private, in violation of this Section, shall be guilty of a petty offense and in addition shall be fined \$25 per day for each day such violation exists.

The highway authority having jurisdiction over the public street or highway affected by such violation shall enter

a complaint in the proper court against any violator of this Section. Upon the failure of any such highway authority to do so act, any other person, may in the name of the political division or municipality, enter such complaint. Amended by P.A. 77-2238, § 1, eff. Jan. 1, 1973.

9-124. Camping on public highway prohibited—Violations—Duty of highway authorities

§ 9-124. It is unlawful for any person to camp on any public highway in this State or to make, other than in an emergency, a rest stop except at areas designated for such rest stops.

Any resident of this State may enter complaint before the circuit court against any person or persons found violating this Section and the court shall issue a warrant for the arrest of such violators and have them brought forthwith before such court for examination. Any such violator shall be guilty of a Class C misdemeanor.

Amended by P.A. 78-628, § 1, eff. Oct. 1, 1973.

9-124.1. Feeding stock, cows, etc. on public highway—Punishment

§ 9-124.1. It is unlawful for any person to tether or turn loose any stock, cows, horses or other animals on any public highway in this State for the purpose of feeding the same.

Any resident of this State may enter complaint before the circuit court against any person or persons found violating this Section and the court shall issue a warrant for the arrest of such violators and have them brought forthwith before such court for examination. Any such violator shall be guilty of a Class C misdemeanor.

Added by P.A. 78-628, § 1, eff. Oct. 1, 1973.

9-125. Suits for recovery of fines or penalties

§ 9-125. The appropriate highway authorities shall reasonably prosecute for all fines and penalties provided for in this Code for violations committed on highways under their respective jurisdictions.

Whenever any person complains of a violation of this Code to the highway authority that has jurisdiction over the particular highway where the violation of this Code is alleged to have been committed, such highway authority shall proceed to investigate as to the reason for such complaint and, if the complaint is found to be just, shall at once proceed to prosecution of the offender.

In case the highway authority fails to prosecute, complaint may be made by any person before any court of proper jurisdiction.

9-126. Disposition of fines and penalties

§ 9-126. Fines and penalties recovered under the provisions of this Code shall be paid over to the treasurer of the highway authority responsible for the maintenance and upkeep of the public street or highway upon or along which the violation or offense occurred, and all such monies shall be used only for the construction or maintenance of such streets or highways.

9-127. Title to vacated highways

§ 9-127. Except in cases where the deed, or other instrument, dedicating a highway or part thereof, has expressly provided for a specific devolution of the title thereto upon the abandonment or vacation thereof, whenever any highway or any part thereof is vacated under or

by virtue of any Act of this State or by the highway authority authorized to vacate the highway, the title to the land included within the highway or part thereof so vacated, vests in the then owners of the land abutting thereon, in the same proportions and to the same extent, as though the highway had been dedicated by a common law plat (as distinguished from a statutory plat) and as though the fee of the highway had been acquired by the owners as a part of the land abutting on the highway.

9-128. Damaging signs or traffic control devices

§ 9-128. Any person who intentionally damages or removes an official sign or other traffic control device erected by the proper authority having jurisdiction over such highway authorized by Chapter 11, Article III of The Illinois Vehicle Code, as now or hereafter amended,¹ or any other sign authorized and approved by this Code shall be guilty of a Class C misdemeanor, punishable by a fine of at least \$250 in addition to any other penalties which may be imposed. This Section does not apply to persons properly authorized to repair or remove such signs or other traffic control device.

Amended by P.A. 83-672, § 2, eff. Jan. 1, 1984.

¹ Chapter 95½, ¶ 11-301 et seq.

9-129. Agricultural aircraft—Use of county highways or township roads—Liability for personal injuries

§ 9-129. Agricultural aircraft used for crop dusting or other activities in aid of agriculture as authorized by the Division of Aeronautics of the Department of Transportation may use any county highway or township road as defined under Sections 2-204 and 2-205 of this Code, if granted permission by the County Superintendent of Highways or the Highway Commissioner, whoever shall have proper jurisdiction over such road. Permission to use county highways or township roads shall only be granted by the County Superintendent of Highways or the Highway Commissioner if the average daily traffic count is less than 200. Roads used by agricultural aircraft shall be blocked by barricades conforming to the Manual of Uniform Traffic Control Devices adopted by the Department and shall be accompanied at all times, while in place upon such road, by a flagman. All barricades and flagmen shall be furnished by any individual applying for permission to use any such roads for agricultural aircraft. Traffic shall not be delayed by the use of a county highway or township road by agricultural aircraft by more than 15 minutes in each 30 minute period, and no emergency vehicle shall be delayed at any time unless the safety of either the plane or emergency vehicle would be seriously threatened if the emergency vehicle were allowed to proceed.

A county, county superintendent of highways, township or township commissioner shall not be liable for any personal injuries caused as a result of the operation of agricultural aircraft on such highways.

Added by P.A. 83-92, § 1, eff. Jan. 1, 1984.

Another § 9-129 was renumbered as § 9-130.

9-130. Deposit of snow or ice upon public highway—Prohibition

§ 9-130. No person, firm, corporation or institution, public or private, shall plow or remove or cause to be plowed or removed ice or snow from any shopping center, parking lot, commercial or institutional service area or driveway or any other public or private service area or

driveway and deposit such ice or snow upon a public highway or along the shoulder or edge of a public highway. Such prohibition shall not pertain to a residential driveway or sidewalk.

Any person, firm, corporation or institution, public or private, who violates this Section is guilty of a petty offense.

Formerly § 9-129. Renumbered § 9-130 and amended by P.A. 83-1362, Art. II, § 148, eff. Sept. 11, 1984.

Article II of P.A. 83-1362, the First 83rd General Assembly Combining Revisory Act, resolved multiple actions in the 83rd General Assembly.

ARTICLE 10. SPECIAL PROVISIONS CONCERNING BRIDGES, FERRIES, TERMINALS AND OTHER HIGHWAY STRUCTURES

DIVISION 1. DEPARTMENT ACQUISITION BY GIFT OF BRIDGES AND APPROACHES ACROSS STREAMS FORMING STATE BOUNDARY AND MAINTENANCE THEREOF

Par.

10-101. Gift to Department.

10-102. Conditions precedent.

10-103. Maintenance of bridge.

DIVISION 2. COUNTY CONSTRUCTION AND MAINTENANCE OF FREE BRIDGES ON STATE BOUNDARIES

10-201. Construction and repair—County proportion of expenses.

10-202. Appropriations by county boards—Petition—Bonds—Election.

10-203. Form of proposition.

10-204. Bonds—Issuance—Rate—Register by county clerk—Tax levy.

10-205. Contracts—Approval—Bond of contractor.

10-206. Payments of contractor—Prerequisites—Partial payment.

DIVISION 3. COUNTY TOLL BRIDGES

10-301. Bridges over streams within county or forming boundary line—Authority of county—Bridge commission.

10-302. Operation of bridge and approaches—Rules and regulations—Toll charges.

10-303. Issuance of revenue bonds.

10-304. Sinking fund to pay principal and interest.

10-305. County treasurer—Duties relative to funds.

10-306. Accounts—Audit.

10-307. Compelling performance of duties.

10-308. Bonds payable only from revenues—Letting contracts.

10-309. Title to property.

10-310. Budget for fiscal year.

10-311. Bridge commission.

10-312. Cumulative powers.

DIVISION 4. DONATION OF HIGHWAYS OUTSIDE CORPORATE LIMITS TO COUNTIES BY MUNICIPALITY

10-401. Resolution—Certificate—Ownership.

DIVISION 5. MUNICIPAL BRIDGES AND APPROACHES

10-501. Building, acquisition and maintenance.

10-502. Collection of toll.

Par.

- 10-503. Municipal control—County aid.
10-504. Bonds—Submission—Limitations.

**DIVISION 6. MUNICIPAL BRIDGES, FERRIES
AND TERMINALS**

- 10-601. Acquisition and regulation of ferries and bridges.
10-602. Acquisition and maintenance of ferries and bridges—River forming state boundary—Aid road districts—Issuance of bonds—Tolls.
10-603. Bridges, ferries, and approaches—Municipal control.
10-604. Bridges and terminal facilities—Ownership and operation.
10-605. Special tax—Referendum.
10-606. Issuance of bonds.

DIVISION 7. MUNICIPAL TOLL BRIDGES—ADDITIONAL AUTHORIZATION TO ACQUIRE, CONSTRUCT, MAINTAIN, ETC.

- 10-701. Definitions.
10-702. Powers of municipalities.
10-703. Issuance of revenue bonds.
10-704. Ordinance—Publication.
10-705. Toll charges—Record—Free bridge.
10-706. Refunding revenue bonds payable from income—Issuance—Registration—Interest.
10-707. Bond ordinance—Terms.
10-708. Bond ordinance—Publication.
10-709. Refunding revenue bonds—Sale or exchange.
10-710. Sinking fund publicity—Refunding agreements—Expenditures without prior appropriation.
10-711. Compelling performance of duties—Receivership.
10-712. Revenue bonds—Issuance without referendum.
10-713. Bridge Commission.
10-714. Projects involving two or more municipalities.
10-715. Bonds as legal investments.

DIVISION 8. MUNICIPAL BRIDGES OVER RIVER FORMING STATE BOUNDARY

- 10-801. Definitions.
10-802. Powers of municipalities.
10-803. Issuance of revenue bonds.
10-804. Ordinance—Publication.
10-805. Rates of toll—Records—Surplus revenues.
10-806. Refunding revenue bonds.
10-807. Compelling performance of duties—Receivership.
10-808. Revenue bonds—Issuance without referendum.
10-809. Validation of proceedings and bond issues.

DIVISION 9. DEPARTMENT ACQUISITION AND OPERATION OF CERTAIN FERRIES

- 10-901. Authority to acquire.
10-902. Maintenance and operation.
10-903. Use of funds.

DIVISION 10. DEPARTMENT MAINTENANCE AND CONTROL OF COVERED BRIDGES

- 10-1001. Duty of Department.

DIVISION 1. DEPARTMENT ACQUISITION BY GIFT OF BRIDGES AND APPROACHES ACROSS STREAMS FORMING STATE BOUNDARY AND MAINTENANCE THEREOF

10-101. Gift to Department

§ 10-101. The Department may acquire, by gift, any bridge or part of a bridge and its approaches located in

Illinois which cross any stream forming a boundary line between this State and any adjoining state whenever the bridge and its approaches constitute a direct continuation of a State highway and of an improved highway in the adjoining state.

10-102. Conditions precedent

§ 10-102. Before acquiring any bridge or part of a bridge and its approaches as provided in this Division of this Article, the Department shall ascertain that the bridge and its approaches are structurally sound and in a good state of repair, that all bonds or other obligations issued to finance the cost of constructing or acquiring the bridge and its approaches have been fully retired and that all interest charges in connection therewith have been fully paid and that there are no mortgages, liens or encumbrances of any nature outstanding against the bridge and its approaches or the real property acquired in connection therewith, and, in case the bridge is across a navigable stream, that authority to construct, maintain and operate the bridge and approaches was granted by Act of Congress and that the Act, or a subsequent Act or Acts of Congress in connection therewith, granted full authority to sell, assign or transfer all rights, powers and privileges conferred by the Act of Congress. The conveyance shall be by warranty deed and run to the State of Illinois. The conveyance shall include any interest in real property acquired in connection with the bridge, and shall assign and transfer to the State all rights, powers and privileges conferred by any Act or Acts of Congress in connection with the bridge and approaches.

10-103. Maintenance of bridge

§ 10-103. (a) When the Department has acquired title to any bridge or part of a bridge and its approaches as provided in this Division, it is authorized to assume jointly with the adjoining state, or a political subdivision of the adjoining state, responsibility for the future maintenance, operation and control of such bridge. However, the Department shall not pay more than one-half of the cost of the future maintenance, operation and control of the entire bridge and its approaches, except that the Department's share may be proportionate to the length of the bridge within Illinois where required for compatibility with the adjoining state's statutes. The Department may contract with the adjoining state or with a political subdivision of the adjoining state for the maintenance, operation and control of the entire bridge and its approaches by the adjoining state or its political subdivision and for the reimbursement by the Department for the share of the cost properly chargeable to the State of Illinois. In such cases, the Department may also contract to maintain, operate and control the entire bridge itself if the contract also provides for reimbursement of the Department by the adjoining state or its political subdivision of the share of the cost properly chargeable to such adjoining state or its political subdivision.

(b) Any such contract between the Department and the adjoining state or a political subdivision of the adjoining state entered into under paragraph (a) of this Section shall be for a period not to exceed 50 years and shall be

1. renewable annually in the discretion of the Department, and

2. subject to an adequate annual appropriation by the General Assembly to fund the proportionate share of the costs of the maintenance, operation and control of the

ILLINOIS

121 ¶ 8-106
Highway Code § 8-106

ROADS AND BRIDGES

176

ration of final construction plans, but only after reasonable notice has been given, and shall be conducted in accordance with rules and regulations prescribed by the Department. No crossings shall be eliminated which shall unduly discommode or interfere with local traffic, or will destroy reasonable access to schools, churches, markets, trade or community centers, and all crossings not eliminated shall be grade separated with the through traffic lanes of the interstate highway or the highway where the authority to control access has been exercised to permit access only at certain selected public roads. If the closing of a public way, as herein provided, makes it necessary to construct a new or additional highway connection to serve the public need, the Department and county board shall construct such connection. When property is damaged by the closing of any public way, the damage shall be ascertained and paid as provided by law.

Amended by P.A. 76-181, § 1, eff. July 1, 1969.

8-107. New highway intersections or crossings—Consent

§ 8-107. No new highway or other public way shall be opened into or connect with or be carried over or under any freeway until and unless the Department, the county board, or the corporate authorities of any municipality, as the case may be, consents thereto in writing, and the Department, county board, or the corporate authorities of any municipality, as the case may be, may give or withhold their respective consent or fix such terms and conditions as will best subserve the public interest.

8-107.1. Telephone service within rights-of-way of fully controlled access highways

§ 8-107.1. Subject to regulations prescribed by the Department, county board, or the corporate authorities of any municipality, as the case may be, such highway authority may issue permits to a telephone company for the establishment of telephone service within the rights-of-way of fully controlled access highways at points where proper access to and from the main traveled lanes has been established, and where such facilities are necessary to the safety and welfare of the highway users.

Added by Laws 1959, p. 1799, eff. July 21, 1959.

8-108. Continuation of existing freeways

§ 8-108. Any highway which prior to the effective date of this Code was a freeway shall continue to be a freeway under the provisions of this Article.

8-109. Cumulative powers

§ 8-109. The provisions of this Article are cumulative and shall be considered as conferring additional powers on the Department, the county board of any county, or the corporate authorities of any municipality and not as limitations upon powers now exercised by the Department, county board, or corporate authorities of any municipality with respect to highways under their respective jurisdiction and control.

ARTICLE 9. GENERAL HIGHWAY PROVISIONS

Par.

- 9-101. Cooperative agreements among governmental agencies.
9-101.1. Consultation with local agencies—Drainage.

Par.

- 9-102. Keeping vehicles off highways during construction or repairs—Erection of signs.
9-103. Removal of control devices or signs.
9-104. Corner stones.
9-105. Entrance culverts.
9-106. Oiling of roadways—Protection of intersecting all-weather highways.
9-107. Tile drains—Contract with owners or occupants of adjoining lands.
9-108. Willow hedges—Public nuisance.
9-109. Capacity of bridges or culverts—Violations.
9-110. Patented articles—Use for constructing or maintaining public highways, etc.
9-111. Weed control—Penalty.
9-111.1. Streams and culverts—Removal of driftwood and other accumulations.
9-112. Obstructions at grade crossings—Signs or signals.
9-112.1. Billboards or advertising.
9-112.2. Signs, billboards and advertising similar to traffic control signs or devices prohibited—Oscillating, rotating or flashing lights prohibited.
9-112.3. Shelters for public transportation passengers.
9-113. Use by public utilities company—Consent—Rules, regulations and specifications—Non-toll federal-aid fully access-controlled state highways.
9-113.01. Repair of damage caused by utilities—Local government.
9-113.1. Commercial establishments within right-of-way, etc.—Solicitation of donations at courtesy rest stop—Vending machines in safety rest areas.
9-114. Right of owner to make crossing—Costs.
9-115. Excavation or removal of lateral support—Deposit of spoil from excavations—Violations.
9-116. Hedge fences—Trimming—Violations.
9-117. Injuring or obstructing highways.
9-118. Planting along highway.
9-119. Penalty for destroying plants on highway—Trimming—Removing.
9-121. Depositing in highway of weeds, garbage, etc.—Penalty.
9-122. Injuring sidewalk, bridge, etc.—Penalty.
9-123. Discharge of sewage into open ditches along street or highway.
9-124. Camping on public highway prohibited—Violations—Duty of highway authorities.
9-124.1. Feeding stock, cows, etc. on public highway—Punishment.
9-125. Suits for recovery of fines or penalties.
9-126. Disposition of fines and penalties.
9-127. Title to vacated highways.
9-128. Damaging signs or traffic control devices.
9-129. Agricultural aircraft—Use of county highways or township roads—Liability for personal injuries.
9-130. Deposit of snow or ice upon public highway—Prohibition.

9-101. Cooperative agreements among governmental agencies

§ 9-101. Nothing in this Code shall prevent the execution of cooperative agreements among governmental agencies.

Any municipality may negotiate an agreement with the Department whereby the municipality may use such funds as are available to it for that purpose for the construction or maintenance of a State highway within its boundaries or with the corporate authority of a county or road district for the construction or maintenance of a highway on the county highway system or township or district road system outside of its municipal boundaries.

The county board may negotiate an agreement with the Department whereby the county may use such funds as are available to it for that purpose for the construction or maintenance of a highway on the State highway system or with a municipality for the construction or maintenance of streets on the municipal street system of such municipality.

9-101.1. Consultation with local agencies—Drainage

§ 9-101.1. Whenever the proper highway authority is about to construct or improve the drainage structures of a State highway, county highways, or county unit district road, the highway authority shall meet and consult with the authorities of any municipality adjacent to or through which such highway or road runs. The purpose of such meetings is to work out an agreement with such municipality and all other interested agencies and units of local government as to the extent of such drainage construction or improvement.

Added by P.A. 77-718, § 1, eff. Aug. 12, 1971.

9-102. Keeping vehicles off highways during construction or repairs—Erection of signs

§ 9-102. The proper highway authorities are authorized to keep vehicles of every kind off the public highways where necessary to properly construct or repair the same.

Whenever any public highway including any bridge or culvert thereon is being constructed or repaired, the highway authorities having such work in charge shall, when they deem it necessary, erect or cause to be erected at such points as they deem desirable, suitable barriers, with signs thereon, stating that such highway is closed, and by whose order.

Such authorities shall also erect or cause to be erected at such places as they deem best, detour signs directing travel around such construction or repair work.

Such signs and barricades shall conform to the Manual of Uniform Traffic Control Devices adopted by the Department.

Amended by Laws 1961, p. 3509, eff. Aug. 13, 1961.

9-103. Removal of control devices or signs

§ 9-103. Whenever a highway has been closed as provided in Section 9-102 or wherever traffic control devices or signs have been erected on any public highway as provided under this Code it is unlawful for any person to remove any such barrier, traffic control device or sign, or to deface or injure the same, or to walk, ride or drive upon any part of such highway so closed, except such persons as are duly authorized to do so.

Whoever knowingly violates the provisions of this Section shall be guilty of a Class B misdemeanor, punishable by a fine of at least \$250, as well as any other penalty which may be imposed. In addition thereto, such person convicted shall be held liable for any and all damages caused to such highway, including, but not limited to, any

bridge or culvert work, traffic control device or sign, by reason of such violation.

The highway authorities or their duly authorized agents in direct charge of the work, are authorized to exercise in their respective jurisdictions, all the common law and statutory powers conferred upon sheriffs, and such highway authorities, or their duly authorized agents in direct charge of the work aforesaid, shall arrest without process any person who violates the provisions of this Section, and in so doing they shall be held to be acting for the State.

Any person or persons so arrested shall be delivered by the person making the arrest to some judge, sheriff, or police officer at some station or place within the county in which the offense was committed, for trial, according to law.

Amended by P.A. 83-672, § 2, eff. Jan. 1, 1984.

9-104. Corner stones

§ 9-104. In grading highways corner stones marking sectional or other corners shall not be disturbed, except to lower such stones so that they will not rise above the surface of the highway. If a corner stone is covered to a depth greater than 12 inches or is covered with a highway surfacing material other than road oil, the location of the corner stone shall be preserved by setting a suitable monument over the stone which shall be level with the highway surface or by setting at least 3 offset monuments in locations where they will not be disturbed. When any corner stone is lowered or when a monument is set over a stone or when offset monuments are set it shall be done in the presence of and under the supervision of a Registered Illinois Land Surveyor who shall record the type and location of the reference monuments with respect to the corner stone in the office of the recorder in the county in which such stone is located.

9-105. Entrance culverts

§ 9-105. In constructing a public highway, if a ditch is made at the junction of highways, or at the entrance of gates or other openings of adjoining premises, the highway authorities shall construct good and sufficient culverts or other convenient crossings. New entrance culverts or crossings or additions to existing entrance culverts or crossings along an existing public highway or street where there is a ditch may be made with the consent of the highway authorities, provided the applicant for such entrance culvert or crossing constructs at the applicant's expense a good and sufficient culvert or other convenient crossing of the type and size specified by the highway authorities, which structure shall then become the property of the public.

9-106. Oiling of roadways—Protection of intersecting all-weather highways

§ 9-106. Wherever a highway, driveway, parking lot or other area open to traffic that has been freshly treated with road oil, liquid asphalt or similar material intersects with or is otherwise located or partially located within 300 feet of a durable all-weather highway of any type except gravel or crushed stone, the highway authorities or any person responsible for applying such material shall cause such freshly treated highway, driveway, parking lot or other such area to be barricaded or covered with crushed aggregate or other suitable cover material so that traffic will not carry the fresh road oil, liquid asphalt or similar

material onto the travel ways of the durable all-weather highway.

Amended by P.A. 80-528, § 1, eff. Oct. 1, 1977.

9-107. Tile drains—Contract with owners or occupants of adjoining lands

§ 9-107. Whenever the highway authorities are about to lay a tile drain along any public highway the highway authorities may contract with the owners or occupants of adjoining lands to lay larger tile than would be necessary to drain the highway, and permit connection therewith by such contracting parties to drain their lands.

However, all such contracts on township or district roads for a sum in excess of \$1,000.00 shall be made on behalf of any road district by the highway commissioner thereof, with the consent of the county superintendent of highways.

Amended by Laws 1961, p. 2815, eff. Aug. 4, 1961.

9-108. Willow hedges—Public nuisance

§ 9-108. Where willow hedges, or a line of willow trees have been planted along the margin of a highway, so as to render tiling impracticable, the highway authority having jurisdiction of such highway may contract with the owner for their destruction; and they shall be destroyed before tiling. The planting of such hedges or trees hereafter on the margin of highways is declared to be a public nuisance.

9-109. Capacity of bridges or culverts—Violations

§ 9-109. It is unlawful to construct any bridge or culvert upon any ravine, creek, drainage ditch or river upon a public highway in this State unless such bridge or culvert shall have the capacity of sustaining highway traffic with safety.

Any person who violates the provisions of this Section shall be guilty of a petty offense.

The fact that any such bridge or culvert does not conform with the specifications of the Department in effect at the time when the contract for such bridge or culvert is let, is prima facie evidence that the bridge or culvert does not have the capacity of sustaining highway traffic with safety.

Amended by P.A. 77-2238, § 1, eff. Jan. 1, 1973.

9-110. Patented articles—Use for constructing or maintaining public highways, etc.

§ 9-110. Any article, material or process covered by a patent granted by the United States government may be specified and used for constructing or maintaining any public highway if such specifications are drawn so as to provide for an alternative method or methods of construction or maintenance so that competition may be had between different types of materials answering the same general purpose.

9-111. Weed control—Penalty

§ 9-111. The highway authorities shall annually, at the proper season, to prevent the spread of noxious weeds as defined in the "Illinois Noxious Weed Law", approved August 17, 1971, as amended,¹ destroy or cause to be destroyed, all such noxious weeds growing upon public highways under their respective jurisdictions. The Highway authorities shall seasonably mow or manage all weeds

and other vegetation growing along the highways under their respective jurisdictions.

Any highway officer failing to comply with the provisions of this Section shall be guilty of a petty offense and shall be liable to a fine of not less than \$10 nor more than \$25 for each season in which he neglects such requirements.

Amended by P.A. 83-333, § 69, eff. Sept. 14, 1983.

¹ Chapter 5, § 1951 et seq.

9-111.1. Streams and culverts—Removal of driftwood and other accumulations

§ 9-111.1. The highway authorities shall from time to time inspect the bridges and culverts on the public highways and streets under their respective jurisdictions which span streams and watercourses and shall remove driftwood and other materials accumulated within the right of way at such structures which obstruct the free flow of either low or high water. Any general funds, and any forces and equipment available for maintenance of the public highways or streets may be used for the removal of such accumulated material.

Added by Laws 1961, p. 2627, eff. Aug. 2, 1961.

9-112. Obstructions at grade crossings—Signs or signals

§ 9-112. At all grade crossings of public highways with railroads outside the corporate limits of any municipality, the highway authority having jurisdiction of such highways shall remove, or cause to be removed from the highway all removable obstructions to view at such grade crossings, such as unauthorized signs and billboards, brush and shrubbery, and shall trim, or cause to be trimmed, all hedges and trees upon the highway for a distance of not less than 300 feet from each side of such crossings.

No person shall place, or cause to be placed, any sign or signal on a public highway within a distance of 300 feet of any grade crossing, except official traffic control devices authorized in an Act in relation to the regulation of traffic, approved July 9, 1935, as now or hereafter amended,¹ any signs or signals required by law or the Illinois Commerce Commission for the protection of such crossings.

Any person who violates any of the provisions of this Section shall be guilty of a petty offense and fined not less than \$10 nor more than \$100 for each offense.

Amended by P.A. 77-2238, § 1, eff. Jan. 1, 1973.

¹ Chapter 95½, § 114(a) (repealed).

9-112.1. Billboards or advertising

§ 9-112.1. No person shall place or cause to be placed any sign or billboard or any advertising of any kind or description upon any State highway or on any other highway outside the corporate limits of any municipality except as may be required by this Code or "The Illinois Vehicle Code", as now or hereafter amended.¹ This provision also shall apply to signs, billboards, or any other advertising upon any bridge, other structure, wire, cable, or other device, over or above such highway, whether constructed by the Department or others except signs designating the name of the railroad and the clearance provided. This Section does not prohibit or prevent any public utility from placing upon, above, below or near any of its facilities any signs or markers giving notice of the existence, identification or location of such facilities located

ed upon or adjacent to any such highway. Such signs or markers shall be limited in size and shape to the minimum necessary consistent with the safety of the public in accordance with rules and regulations as promulgated by the Department.

Any person who violates any of the provisions of this Section shall be guilty of a petty offense and fined not less than \$10 nor more than \$100 for each offense.

Amended by P.A. 81-840, § 49, eff. Sept. 19, 1979.

¹ Chapter 95½, 11-100 et seq.

9-112.2. Signs, billboards and advertising similar to traffic control signs or devices prohibited—Oscillating, rotating or flashing lights prohibited

§ 9-112.2. No person shall place, or cause to be placed upon or in view of any public highway any sign or billboard or any advertising of any kind or description which in wording, color or shape is similar to official traffic control signs or other official traffic control devices erected by the proper authority having jurisdiction over such highway in compliance with the Manual of Uniform Traffic Control Devices for Streets and Highways, as now or hereafter adopted by the Department.

No person shall place, or cause to be placed upon any building or other structure, within 200 feet of any public highway, oscillating, rotating or flashing lights which are of such intensity, when illuminated, to be visible at any time from such highway. This prohibition does not apply to a pole-supported business or brand identification sign with constant illumination and color and in which the only movement is a slow rotation of the entire body of the sign so as to be visible from all directions. This prohibition does not apply to airport lights.

Any person who violates any of the provisions of this Section shall be guilty of a petty offense and fined not less than \$10 nor more than \$100 for each offense.

Amended by P.A. 78-255, § 51, eff. Oct. 1, 1973.

9-112.3. Shelters for public transportation passengers

§ 9-112.3. Shelters for the convenience and comfort of persons waiting for buses or other public transportation may be placed and maintained within the right of way of any street or highway, including right of way for streets and highways within municipalities, after a license or permit for the shelter and location is obtained from the highway authority having jurisdiction. Placement and location of shelters on any street or highway within a municipality shall be subject to the approval of the corporate authorities of such municipality. The owners may place advertising on the shelters if authorized by the license or permit, provided, however, that no political advertising shall be placed on any shelter on any street or highway at any time and further provided that advertising on shelters shall be limited to one-third of the vertical surface of the shelter. Shelters shall not be placed or maintained on that portion of the right of way designed and used for vehicle traffic and further shall not be so placed as to impair the street or highway or interfere with the free and safe flow of traffic.

Added by P.A. 81-426, § 1, eff. Jan. 1, 1980.

III Road and Bridge Laws—
1984 Edition

9-113. Use by public utilities company—Consent—Rules, regulations and specifications—Non-toll federal-aid fully access-controlled state highways

§ 9-113. (a) No ditches, drains, track, rails, poles, wires, pipe line or other equipment of any public utility company, municipal corporation or other public or private corporation, association or person shall be located, placed or constructed upon, under or along any highway, or upon any township or district road, other than a highway or road within a municipality without first obtaining the written consent of the appropriate highway authority as hereinafter provided for in this Section.

(b) The State highway authority is authorized to promulgate reasonable and necessary rules, regulations and specifications for State highways for the administration of this Section.

(c) In the case of non-toll federal-aid fully access-controlled State highways, the State highway authority shall not grant consent to the location, placement or construction of ditches, drains, track, rails, poles, wires, pipe line or other equipment upon, under or along any such non-toll federal-aid fully access-controlled State highway, which:

(1) would require cutting the pavement structure portion of such highway for installation or, except in the event of an emergency, would require the use of any part of such highway right-of-way for purposes of maintenance or repair. Where, however, the State highway authority determines prior to installation that there is no other access available for maintenance or repair purposes, use by the entity of such highway right-of-way shall be permitted for such purposes in strict accordance with the rules, regulations and specifications of the State highway authority, provided however, that except in the case of access to bridge structures, in no such case shall an entity be permitted access from the through-travel lanes, shoulders or ramps of the non-toll federal-aid fully access-controlled State highway to maintain or repair its accommodation; or

(2) would in the judgment of the State highway authority, endanger or impair any such ditches, drains, track, rails, poles, wires, pipe lines or other equipment already in place; or

(3) would, if installed longitudinally within the access control lines of such highway, be above ground after installation except that the State highway authority may consent to any above ground installation upon, under or along any bridge, interchange or grade separation within the right-of-way which installation is otherwise in compliance with this Section and any rules, regulations or specifications issued hereunder; or

(4) would be inconsistent with Federal law or with rules, regulations or directives of appropriate Federal agencies.

(d) In the case of accommodations upon, under or along non-toll federal-aid fully access-controlled State highways the State highway authority may charge an entity reasonable compensation for the right of that entity to longitudinally locate, place or construct ditches, drains, track, rails, poles, wires, pipe line or other equipment upon, under or along such highway. Such compensation may include in-kind compensation.

Where the entity applying for use of a non-toll federal-aid fully access-controlled State highway right-of-way is a public utility company, municipal corporation or other public or private corporation, association or person, such com-

pensation shall be based upon but shall not exceed a reasonable estimate by the State highway authority of the fair market value of an easement or leasehold for such use of the highway right-of-way. Where the State highway authority determines that the applied-for use of such highway right-of-way is for private land uses by an individual and not for commercial purposes, the State highway authority may charge a lesser fee than would be charged a public utility company, municipal corporation or other public or private corporation or association as compensation for the use of the non-toll federal-aid fully access-controlled State highway right-of-way. In no case shall the written consent of the State highway authority give or be construed to give any entity any easement, leasehold or other property interest of any kind in, upon, under, above or along the non-toll federal-aid fully access-controlled State highway right-of-way.

Where the compensation from any entity is in whole or in part a fee, such fee may be reasonably set, at the election of the State highway authority, in the form of a single lump sum payment or a schedule of payments. All such fees charged as compensation may be reviewed and adjusted upward by the State highway authority once every 5 years provided that any such adjustment shall be based on changes in the fair market value of an easement or leasehold for such use of the non-toll federal-aid fully access-controlled State highway right-of-way. All such fees received as compensation by the State highway authority shall be deposited in the Road Fund.

(e) Any entity applying for consent shall submit such information in such form and detail to the appropriate highway authority as to allow the authority to evaluate the entity's application. In the case of accommodations upon, under or along non-toll federal-aid fully access-controlled State highways the entity applying for such consent shall reimburse the State highway authority for all of the authority's reasonable expenses in evaluating that entity's application, including but not limited to engineering and legal fees.

(f) Any ditches, drains, track, rails, poles, wires, pipe line or other equipment located, placed or constructed upon, under or along a State highway with the consent of the State highway authority under this Section shall, upon written notice by the State highway authority be subject to removal, relocation or modification at no expense to the State highway authority when and as deemed necessary by the State highway authority for highway or highway safety purposes. If, within 60 days after receipt of such written notice, arrangements are not made satisfactory to the State highway authority for such removal, relocation or modification, the State highway authority may remove, relocate or modify such ditches, drains, track, rails, poles, wires, pipe line or other equipment and bill the owner thereof for the total cost of such removal, relocation or modification. The State highway authority shall determine the terms of payment of those costs provided that all costs billed by the State highway authority shall not be made payable over more than a 5 year period from the date of billing. This paragraph shall not be construed to prohibit the State highway authority from paying any part of the cost of removal, relocation or modification where such payment is otherwise provided for by State or federal statute or regulation.

(g) It shall be the sole responsibility of the entity, without expense to the State highway authority, to maintain and repair its ditches, drains, track, rails, poles, wires, pipe

line or other equipment after it is located, placed or constructed upon, under or along any State highway and in no case shall the State highway authority thereafter be liable or responsible to the entity for any damages or liability of any kind whatsoever incurred by the entity or to the entity's ditches, drains, track, rails, poles, wires, pipe line or other equipment.

(h) Upon receipt of an application therefor, consent to so use a highway may be granted subject to such terms and conditions not inconsistent with this Code as the highway authority deems for the best interest of the public. The petitioner shall pay to the owners of property abutting upon the affected highways established as though by common law plat all damages the owners may sustain by reason of such use of the highway, such damages to be ascertained and paid in the manner provided by law for the exercise of the right of eminent domain.

(i) Such consent shall be granted by the Department in the case of a State highway; by the county board or its designated county superintendent of highways in the case of a county highway; by either the highway commissioner or the county superintendent of highways in the case of a township or district road, provided that if consent is granted by the highway commissioner, the petition shall be filed with the commissioner at least 30 days prior to the proposed date of the beginning of construction, and that if written consent is not given by the commissioner within 30 days after receipt of the petition, the applicant may make written application to the county superintendent of highways for consent to the construction. This Section does not vitiate, extend or otherwise affect any consent granted in accordance with law prior to the effective date of this Code to so use any highway.

(j) Nothing in this Section shall limit the right of a highway authority to permit the location, placement or construction or any ditches, drains, track, rails, poles, wires, pipe line or other equipment upon, under or along any highway or road as a part of its highway or road facilities or which the highway authority determines is necessary to service facilities required for operating the highway or road, including rest areas and weigh stations.

(k) Paragraphs (c) and (d) of this Section shall not apply to any accommodation located, placed or constructed with the consent of the State highway authority upon, under or along any non-toll federal-aid fully access-controlled State highway prior to July 1, 1984, provided that accommodation was otherwise in compliance with the rules, regulations and specifications of the State highway authority.

(l) The consent to be granted pursuant to this Section by the appropriate highway authority shall be effective only to the extent of the property interest of the State or government unit served by that highway authority. Such consent shall not be binding on any owner of the fee over or under which the highway or road is located and shall not otherwise relieve the entity granted that consent from obtaining by purchase, condemnation or otherwise the necessary approval of any owner of the fee over or under which the highway or road is located. This paragraph shall not be construed as a limitation on the use for highway or road purposes of the land or other property interests acquired by the public for highway or road purposes, including the space under or above such right-of-way.

Amended by P.A. 83-1363, § 1, eff. Sept. 11, 1984.

9-113.01. Repair of damage caused by utilities—Local government

§ 9-113.01. Except when otherwise provided for by contract, permit or ordinance, a unit of local government having jurisdiction over streets or roads may repair damage to any such streets or roads caused by a public or private utility and bill the utility for the cost thereof if the utility fails to complete such repairs within 30 days after receipt of written notice from the unit of local government that such repairs must be made. Primary responsibility for such repairs shall remain with the utility.

As used in this Section, "unit of local government" means a county, municipality, township or other unit designated as a unit of local government by law.

Added by P.A. 81-1377, § 1, eff. Aug. 9, 1980.

9-113.1. Commercial establishments within right-of-way, etc.—Solicitation of donations at courtesy rest stop—Vending machines in safety rest areas

§ 9-113.1. (a) Except as otherwise provided in Sections 4-201.19 and 8-107.1 of this Code and in subsection (b) of this Section, and except to the extent authorized in "An Act in relation to the construction, operation, regulation and maintenance of a system of toll highways and to create The Illinois State Toll Highway Authority, and to define its powers and duties, to make an appropriation in conjunction therewith", approved August 7, 1967, as amended,¹ no commercial establishment for serving motorists or highway users shall be constructed or located within the right-of-way of, or on publicly-owned or publicly-leased land acquired or used for or in connection with a highway. Nothing in this Act shall affect or impair the application of Sections 4-210 and 4-211 of the Illinois Highway Code, as now or hereafter amended to that portion of any highway where the rights of direct private access thereto generally from abutting property have not been extinguished by due process.

Nothing in this Code shall prohibit the solicitation of donations or contributions by a local nonprofit organization at a courtesy rest stop which has been established by that organization. A courtesy rest stop is a temporary facility, locally sponsored, to encourage safety only on nationally recognized holidays by promoting a "refreshment break" for motorists. The courtesy rest stop must be conducted for the express purpose of improving the safety of highway travel and not primarily as an advertisement for any organization or other activity.

All courtesy rest stop activity shall be conducted completely within existing safety rest areas located on freeways or other State highways and only on those days recognized as national holidays. Before granting authorization to establish a courtesy rest area, the Department shall determine that sufficient parking in the safety rest area or stop is available without requiring vehicles to stop or park on any ramp or other surface used for the movement of vehicles. The refreshments and any other service offered must be free of charge to the motorists. However, solicitation of free-will donations or contributions shall be permitted. The Department shall cooperate with the sponsoring organizations in the establishment of courtesy rest stops.

(b) The Department may permit the placement and operation of vending machines in safety rest areas constructed or located on rights-of-way of non-toll fully access con-

trolled State highways. The Department shall adopt rules and regulations governing the type of services provided, location and operation of machines, and all other aspects necessary to provide the best public service consistent with federal and State statutes. The Department, when allowing for the installation of vending machines, shall provide for the operation of such facilities through the Department of Rehabilitation Services, which is the State licensing agency designated pursuant to Section 2(a)(5) of the federal Randolph-Sheppard Vending Stand Act of June 20, 1936 (49 Stat. 1559, Title 20, Sections 107-107F).² The Department of Rehabilitation Services shall assign licensed blind vendors to operate these vending facilities. However, if, after notification to all licensed blind vendors of the availability of a particular site, none is interested in operating that site, the Department of Rehabilitation Services may contract for the operation of that site by a private contractor. Any income, after deduction for cost of items, labor and a negotiated percentage of profit, shall accrue to the Department of Rehabilitation Services for the exclusive benefit of the vending facilities for the blind program or other programs of rehabilitation and training for the blind administered by the Department of Rehabilitation Services. The Department of Rehabilitation Services shall periodically notify licensed blind vendors of the availability of such contractually operated sites and make them available to interested licensed blind vendors.

(c) The Department of Transportation may not charge the operators of vending facilities for any portion of the cost of rest area maintenance or oversight services provided by its employees prior to the effective date of this amendatory Act of 1985. The Department shall not require the vending machine operators to perform any services other than those related to servicing and operating the approved vending machines.

Amended by P.A. 84-1308, Art. II, § 166, eff. Aug. 25, 1986.

¹ Paragraph 100-1 et seq. of this chapter.

² 20 U.S.C.A. § 107 et seq.

Article II of P.A. 84-1308, the First 84th General Assembly Combinatory Revisory Act, resolved multiple actions in the 84th General Assembly and made certain technical corrections.

9-114. Right of owner to make crossing—Costs

§ 9-114. Any person owning, using, or occupying lands on both sides of any public highway has the privilege of making a crossing under the highway for the purpose of letting his cattle and other domestic animals across such highway. However, such person shall erect at his own expense, a good and substantial bridge, with good railings on each side thereof, and build an embankment, of easy grade, on either side of the bridge. The bridge shall be not less than 16 feet wide, and be approved by the appropriate highway authorities having jurisdiction of such public highway. The bridge shall be kept constantly in good repair by the owner or occupant of the land, the construction subject always to the consent and approval of such appropriate highway authorities.

In case such crossing is made on any waterway or natural channel for water and where a culvert or bridge is maintained as required for highway purposes, the owners or occupants shall not be required to pay for or construct any more of the crossings than the additional cost of such crossing over and above the necessary cost of a suitable culvert or bridge for highway purposes at such place.

9-115. Excavation or removal of lateral support—Deposit of spoil from excavations—Violations

§ 9-115. It is unlawful for any person to excavate or remove or cause the excavation or removal of the lateral support within a distance of 10 feet plus one and one-half times the depth of any excavation adjacent to the established right-of-way of any public highway located outside the corporate limits of any municipality, except that if any of the excavated materials be of solid rock, the depth of such solid rock shall not be considered in computing the limit of excavation from such right-of-way line of such public highway.

It is unlawful for any person to deposit spoil or cause the spoil from any excavation to be deposited in such a manner that the toe of such spoil will be nearer than 20 feet to any established right-of-way of any public highway located outside the corporate limits of any municipality.

Whenever any person violates or causes the foregoing provisions of this Section to be violated, he shall be guilty of a petty offense for each day such violation occurs and until such unlawful excavation is backfilled or unlawful spoil banks are removed, either by the offenders or by the public authorities as provided hereinafter in this Section.

Where any such violation occurs along any public highway the proper highway authority having jurisdiction of that particular highway is authorized to take the necessary steps as required by law to enter upon the property where such violation occurs and backfill or cause to be backfilled the unlawful excavation or remove or cause to be removed the unlawful spoil banks, whichever case it may be, or both, in such a manner as will conform with the foregoing provisions of this Section, and the costs of such work, together with court costs, may be recovered from such violators in the circuit court in the county where such violation occurred.

Nothing in this Section shall prohibit the construction and maintenance of grade separation crossings of any public utility, private corporation or individuals, or in any way conflict with any other laws governing such grade separations; nor shall the provisions of this Section in any way apply to pipe line construction or maintenance where such work is done to the satisfaction of the highway authorities having jurisdiction over such public highway; nor to the excavation of earth necessary for the construction of foundations or basement walls.

Amended by P.A. 83-345, § 82, eff. Sept. 14, 1983.

9-116. Hedge fences—Trimming—Violations

§ 9-116. The owner of any hedge fence growing along the right-of-way line of any public highway shall during the year next after such hedge has obtained the age of 7 years and during each year thereafter, trim such hedge fence to a height not exceeding 5 feet, except for Osage hedge which shall be trimmed annually after the second year from the first trimming to a height not exceeding 4 feet, and the owner shall trim all such hedges on the road side so that foliage will not extend over the right-of-way line for a distance in excess of 4 feet. All such trimming so required shall be done prior to October first.

The highway authority having jurisdiction over the highway, upon application of the owner of a farm, may permit such owner to grow a hedge fence to any desired height for a distance not to exceed one-fourth the total length of the hedge fence along the highway to serve as a wind-break for livestock. Such permit is revocable at any time.

The provisions of this Section do not apply to any hedge protecting either an orchard or a building.

Any failure or refusal to comply with the provisions of this Section is a petty offense and is punishable by a fine of not less than \$10 nor more than \$50 for each year of such failure or refusal.

Amended by P.A. 77-2238, § 1, eff. Jan. 1, 1973.

9-117. Injuring or obstructing highways

§ 9-117. If any person injures or obstructs a public highway by felling a tree or trees in, upon or across the same, or by placing or leaving any other obstruction thereon, or encroaching upon the same with any fence, or by plowing or digging any ditch or other opening thereon, or by turning a current of water so as to saturate, wash or damage the same, or by plowing in or across or on the slopes of the side gutters or ditches, or by placing any material in such ditches, or in any way interfering with the free flow of water therein, or leaves the cuttings of any hedge thereon for more than 10 days, without the permission of the highway authority having jurisdiction over such highway, he shall be guilty of a petty offense and fined for every such offense not less than \$10 nor more than \$100; and in case of placing any obstruction on the highway, an additional sum of not exceeding \$10 per day for every day he allows such obstruction to remain after he has been ordered to remove it by the highway authority having jurisdiction over such highway. Any person feeling himself aggrieved or any such highway authority may make a complaint under this Section.

The highway authority having jurisdiction over such highway, after having given 10 days' notice to the owners of the obstruction or person so obstructing, or plowing, or digging ditches upon such highway or interfering with the free flow of water in the side gutters or ditches, of the obstruction, plowing or digging of ditches, interfering with drainage, or of the encroachment of any fence, may remove any such fence or other obstruction, fill up any ditch or excavation except ditches necessary to the drainage of an adjoining farm emptying into a ditch upon the highway, or regrade such side gutters or ditches, and recover the necessary cost of such removal or filling of any such ditch or excavation, or regrading of such side gutters or ditches from such owner or other person obstructing or damaging such highway aforesaid, to be collected by the highway authority having jurisdiction of the highway whereon such offense was committed. Any such cost recovered shall be deposited in the road fund of the political division having jurisdiction over the highway adjudged to have been obstructed or injured, and shall be used only for maintenance or construction of public highways under the jurisdiction of that division.

However, this section shall not apply to any person who shall lawfully fell any tree for use and shall immediately remove the same out of the highway, nor to any person through or along whose land a public highway may pass, who shall desire to drain his land, and who shall give due notice to the proper highway authority of such intention, and who shall first secure from such highway authority written permission for any work, ditching or excavating he proposes to do within the limits of the highway.

Amended by P.A. 77-2238, § 1, eff. Jan. 1, 1973.

9-118. Planting along highway

§ 9-118. Any association, society, person or persons may, upon obtaining a permit from the highway authority

ties having jurisdiction over the particular highway, and the consent in writing of the owners of adjacent property, plant or set out trees, shrubs, plants or flowers in or upon the right-of-way of any highway within this State, provided that no such tree, shrub, or flower shall be permitted to obstruct the vision of persons traveling upon or across such highways.

**9-119. Penalty for destroying plants on highway—
Trimming—Removing**

§ 9-119. Whoever wilfully drives upon, picks, removes, destroys, cuts down, or in any manner injures any tree, shrub, plant or flower planted or growing within the right-of-way of any public highway, shall be guilty of a petty offense and fined not more than \$100. However, the provisions of this section shall not preclude the highway authority having jurisdiction over the highway from trimming, transplanting, or removing such trees, shrubs, plants or flowers when necessary, in the discretion of such authority, to facilitate the use of such highways for public travel.

Amended by P.A. 77-2238, § 1, eff. Jan. 1, 1973.

**9-121. Depositing in highway of weeds, garbage, etc.—
Penalty**

§ 9-121. It is unlawful for any person to deposit in a public highway or rest area weeds, trash, garbage or other offensive matter or any broken bottles, glass, boards containing projecting nails or any other thing likely to cause punctures in the tires of motor vehicles; and any person so offending shall be guilty of a petty offense. However, this Section shall not apply to proper deposits of harmless materials made in good faith and in a proper manner to repair the roads or to the proper disposal of travel and picnic trash in the waste containers provided for such purpose at rest areas.

Amended by P.A. 81-551, § 1, eff. Jan. 1, 1980.

9-122. Injuring sidewalk, bridge, etc.—Penalty

§ 9-122. If any person purposely destroys or injures any sidewalk, public bridge, culvert, or causeway, or removes any of the timber or plank thereof, or obstructs the same, he shall be guilty of a petty offense, fined not more than \$100, and shall be liable for all damages occasioned thereby and all necessary costs for rebuilding or repairing the same.

Amended by P.A. 77-2238, § 1, eff. Jan. 1, 1973.

**9-123. Discharge of sewage into open ditches along
street or highway**

§ 9-123. No person, firm, corporation, or institution, public or private, shall discharge or empty any type of sewage, including the effluent from septic tanks or other sewage treatment devices, or any other domestic, commercial or industrial waste, or any putrescible liquids, or cause the same to be discharged or emptied in any manner into open ditches along any public street or highway, or into any drain or drainage structure installed solely for street or highway drainage purposes.

Any person, firm, corporation, or institution, public or private, in violation of this Section, shall be guilty of a petty offense and in addition shall be fined \$25 per day for each day such violation exists.

The highway authority having jurisdiction over the public street or highway affected by such violation shall enter

complaint in the proper court against any violator of this Section. Upon the failure of any such highway authority to so act, any other person, may in the name of the political division or municipality, enter such complaint. Amended by P.A. 77-2238, § 1, eff. Jan. 1, 1973.

9-124. Camping on public highway prohibited—Violations—Duty of highway authorities

§ 9-124. It is unlawful for any person to camp on any public highway in this State or to make, other than in an emergency, a rest stop except at areas designated for such rest stops.

Any resident of this State may enter complaint before the circuit court against any person or persons found violating this Section and the court shall issue a warrant for the arrest of such violators and have them brought forthwith before such court for examination. Any such violator shall be guilty of a Class C misdemeanor.

Amended by P.A. 78-628, § 1, eff. Oct. 1, 1973.

**9-124.1. Feeding stock, cows, etc. on public highway—
Punishment**

§ 9-124.1. It is unlawful for any person to tether or turn loose any stock, cows, horses or other animals on any public highway in this State for the purpose of feeding the same.

Any resident of this State may enter complaint before the circuit court against any person or persons found violating this Section and the court shall issue a warrant for the arrest of such violators and have them brought forthwith before such court for examination. Any such violator shall be guilty of a Class C misdemeanor.

Added by P.A. 78-628, § 1, eff. Oct. 1, 1973.

9-125. Suits for recovery of fines or penalties

§ 9-125. The appropriate highway authorities shall seasonably prosecute for all fines and penalties provided for in this Code for violations committed on highways under their respective jurisdictions.

Whenever any person complains of a violation of this Code to the highway authority that has jurisdiction over the particular highway where the violation of this Code is alleged to have been committed, such highway authority shall proceed to investigate as to the reason for such complaint and, if the complaint is found to be just, shall at once proceed to prosecution of the offender.

In case the highway authority fails to prosecute, complaint may be made by any person before any court of proper jurisdiction.

9-126. Disposition of fines and penalties

§ 9-126. Fines and penalties recovered under the provisions of this Code shall be paid over to the treasurer of the highway authority responsible for the maintenance and upkeep of the public street or highway upon or along which the violation or offense occurred, and all such monies shall be used only for the construction or maintenance of such streets or highways.

9-127. Title to vacated highways

§ 9-127. Except in cases where the deed, or other instrument, dedicating a highway or part thereof, has expressly provided for a specific devolution of the title thereto upon the abandonment or vacation thereof, whenever any highway or any part thereof is vacated under or

by virtue of any Act of this State or by the highway authority authorized to vacate the highway, the title to the land included within the highway or part thereof so vacated, vests in the then owners of the land abutting thereon, in the same proportions and to the same extent, as though the highway had been dedicated by a common law plat (as distinguished from a statutory plat) and as though the fee of the highway had been acquired by the owners as a part of the land abutting on the highway.

9-128. Damaging signs or traffic control devices

§ 9-128. Any person who intentionally damages or removes an official sign or other traffic control device erected by the proper authority having jurisdiction over such highway authorized by Chapter 11, Article III of The Illinois Vehicle Code, as now or hereafter amended, or any other sign authorized and approved by this Code shall be guilty of a Class C misdemeanor, punishable by a fine of at least \$250 in addition to any other penalties which may be imposed. This Section does not apply to persons properly authorized to repair or remove such signs or other traffic control device.

Amended by P.A. 83-672, § 2, eff. Jan. 1, 1984.

1 Chapter 95½, § 11-301 et seq.

9-129. Agricultural aircraft—Use of county highways or township roads—Liability for personal injuries

§ 9-129. Agricultural aircraft used for crop dusting or other activities in aid of agriculture as authorized by the Division of Aeronautics of the Department of Transportation may use any county highway or township road as defined under Sections 2-204 and 2-205 of this Code, if granted permission by the County Superintendent of Highways or the Highway Commissioner, whoever shall have proper jurisdiction over such road. Permission to use county highways or township roads shall only be granted by the County Superintendent of Highways or the Highway Commissioner if the average daily traffic count is less than 200. Roads used by agricultural aircraft shall be blocked by barricades conforming to the Manual of Uniform Traffic Control Devices adopted by the Department and shall be accompanied at all times, while in place upon such road, by a flagman. All barricades and flagmen shall be furnished by any individual applying for permission to use any such roads for agricultural aircraft. Traffic shall not be delayed by the use of a county highway or township road by agricultural aircraft by more than 15 minutes in each 30 minute period, and no emergency vehicle shall be delayed at any time unless the safety of either the plane or emergency vehicle would be seriously threatened if the emergency vehicle were allowed to proceed.

A county, county superintendent of highways, township or township commissioner shall not be liable for any personal injuries caused as a result of the operation of agricultural aircraft on such highways.

Added by P.A. 83-92, § 1, eff. Jan. 1, 1984.

Another § 9-129 was renumbered as § 9-130.

9-130. Deposit of snow or ice upon public highway—Prohibition

§ 9-130. No person, firm, corporation or institution, public or private, shall plow or remove or cause to be plowed or removed ice or snow from any shopping center, parking lot, commercial or institutional service area or driveway or any other public or private service area or

driveway and deposit such ice or snow upon a public highway or along the shoulder or edge of a public highway. Such prohibition shall not pertain to a residential driveway or sidewalk.

Any person, firm, corporation or institution, public or private, who violates this Section is guilty of a petty offense.

Formerly § 9-129. Renumbered § 9-130 and amended by P.A. 83-1362, Art. II, § 148, eff. Sept. 11, 1984.

Article II of P.A. 83-1362, the First 83rd General Assembly Combining Revisory Act, resolved multiple actions in the 83rd General Assembly.

ARTICLE 10. SPECIAL PROVISIONS CONCERNING BRIDGES, FERRIES, TERMINALS AND OTHER HIGHWAY STRUCTURES

DIVISION 1. DEPARTMENT ACQUISITION BY GIFT OF BRIDGES AND APPROACHES ACROSS STREAMS FORMING STATE BOUNDARY AND MAINTENANCE THEREOF

Par.

10-101. Gift to Department.

10-102. Conditions precedent.

10-103. Maintenance of bridge.

DIVISION 2. COUNTY CONSTRUCTION AND MAINTENANCE OF FREE BRIDGES ON STATE BOUNDARIES

10-201. Construction and repair—County proportion of expenses.

10-202. Appropriations by county boards—Petition—Bonds—Election.

10-203. Form of proposition.

10-204. Bonds—Issuance—Rate—Register by county clerk—Tax levy.

10-205. Contracts—Approval—Bond of contractor.

10-206. Payments of contractor—Prerequisites—Partial payment.

DIVISION 3. COUNTY TOLL BRIDGES

10-301. Bridges over streams within county or forming boundary line—Authority of county—Bridge commission.

10-302. Operation of bridge and approaches—Rules and regulations—Toll charges.

10-303. Issuance of revenue bonds.

10-304. Sinking fund to pay principal and interest.

10-305. County treasurer—Duties relative to funds.

10-306. Accounts—Audit.

10-307. Compelling performance of duties.

10-308. Bonds payable only from revenues—Letting contracts.

10-309. Title to property.

10-310. Budget for fiscal year.

10-311. Bridge commission.

10-312. Cumulative powers.

DIVISION 4. DONATION OF HIGHWAYS OUTSIDE CORPORATE LIMITS TO COUNTIES BY MUNICIPALITY

10-401. Resolution—Certificate—Ownership.

DIVISION 5. MUNICIPAL BRIDGES AND APPROACHES

10-501. Building, acquisition and maintenance.

10-502. Collection of toll.

Par.

- 10-503. Municipal control—County aid.
10-504. Bonds—Submission—Limitations.

DIVISION 6. MUNICIPAL BRIDGES, FERRIES
AND TERMINALS

- 10-601. Acquisition and regulation of ferries and bridges.
10-602. Acquisition and maintenance of ferries and bridges—River forming state boundary—Aid road districts—Issuance of bonds—Tolls.
10-603. Bridges, ferries, and approaches—Municipal control.
10-604. Bridges and terminal facilities—Ownership and operation.
10-605. Special tax—Referendum.
10-606. Issuance of bonds.

DIVISION 7. MUNICIPAL TOLL BRIDGES—ADDITIONAL AUTHORIZATION TO ACQUIRE, CONSTRUCT, MAINTAIN, ETC.

- 10-701. Definitions.
10-702. Powers of municipalities.
10-703. Issuance of revenue bonds.
10-704. Ordinance—Publication.
10-705. Toll charges—Record—Free bridge.
10-706. Refunding revenue bonds payable from income—Issuance—Registration—Interest.
10-707. Bond ordinance—Terms.
10-708. Bond ordinance—Publication.
10-709. Refunding revenue bonds—Sale or exchange.
10-710. Sinking fund publicity—Refunding agreements—Expenditures without prior appropriation.
10-711. Compelling performance of duties—Receivership.
10-712. Revenue bonds—Issuance without referendum.
10-713. Bridge Commission.
10-714. Projects involving two or more municipalities.
10-715. Bonds as legal investments.

DIVISION 8. MUNICIPAL BRIDGES OVER RIVER FORMING STATE BOUNDARY

- 10-801. Definitions.
10-802. Powers of municipalities.
10-803. Issuance of revenue bonds.
10-804. Ordinance—Publication.
10-805. Rates of toll—Records—Surplus revenues.
10-806. Refunding revenue bonds.
10-807. Compelling performance of duties—Receivership.
10-808. Revenue bonds—Issuance without referendum.
10-809. Validation of proceedings and bond issues.

DIVISION 9. DEPARTMENT ACQUISITION AND OPERATION OF CERTAIN FERRIES

- 10-901. Authority to acquire.
10-902. Maintenance and operation.
10-903. Use of funds.

DIVISION 10. DEPARTMENT MAINTENANCE AND CONTROL OF COVERED BRIDGES

- 10-1001. Duty of Department.

DIVISION 1. DEPARTMENT ACQUISITION BY GIFT OF BRIDGES AND APPROACHES ACROSS STREAMS FORMING STATE BOUNDARY AND MAINTENANCE THEREOF

10-101. Gift to Department

§ 10-101. The Department may acquire, by gift, any bridge or part of a bridge and its approaches located in

Illinois which cross any stream forming a boundary line between this State and any adjoining state whenever the bridge and its approaches constitute a direct continuation of a State highway and of an improved highway in the adjoining state.

10-102. Conditions precedent

§ 10-102. Before acquiring any bridge or part of a bridge and its approaches as provided in this Division of this Article, the Department shall ascertain that the bridge and its approaches are structurally sound and in a good state of repair, that all bonds or other obligations issued to finance the cost of constructing or acquiring the bridge and its approaches have been fully retired and that all interest charges in connection therewith have been fully paid and that there are no mortgages, liens or encumbrances of any nature outstanding against the bridge and its approaches or the real property acquired in connection therewith, and, in case the bridge is across a navigable stream, that authority to construct, maintain and operate the bridge and approaches was granted by Act of Congress and that the Act, or a subsequent Act or Acts of Congress in connection therewith, granted full authority to sell, assign or transfer all rights, powers and privileges conferred by the Act of Congress. The conveyance shall be by warranty deed and run to the State of Illinois. The conveyance shall include any interest in real property acquired in connection with the bridge, and shall assign and transfer to the State all rights, powers and privileges conferred by any Act or Acts of Congress in connection with the bridge and approaches.

10-103. Maintenance of bridge

§ 10-103. (a) When the Department has acquired title to any bridge or part of a bridge and its approaches as provided in this Division, it is authorized to assume jointly with the adjoining state, or a political subdivision of the adjoining state, responsibility for the future maintenance, operation and control of such bridge. However, the Department shall not pay more than one-half of the cost of the future maintenance, operation and control of the entire bridge and its approaches, except that the Department's share may be proportionate to the length of the bridge within Illinois where required for compatibility with the adjoining state's statutes. The Department may contract with the adjoining state or with a political subdivision of the adjoining state for the maintenance, operation and control of the entire bridge and its approaches by the adjoining state or its political subdivision and for the reimbursement by the Department for the share of the cost properly chargeable to the State of Illinois. In such cases, the Department may also contract to maintain, operate and control the entire bridge itself if the contract also provides for reimbursement of the Department by the adjoining state or its political subdivision of the share of the cost properly chargeable to such adjoining state or its political subdivision.

(b) Any such contract between the Department and the adjoining state or a political subdivision of the adjoining state entered into under paragraph (a) of this Section shall be for a period not to exceed 50 years and shall be

1. renewable annually in the discretion of the Department, and
2. subject to an adequate annual appropriation by the General Assembly to fund the proportionate share of the costs of the maintenance, operation and control of the

Route _____
Job No. _____
County _____
Parcel No. _____

STATE OF ILLINOIS
DEPARTMENT OF TRANSPORTATION
DIVISION OF HIGHWAYS
LEASE AGREEMENT

This agreement made and entered into this _____ day of _____, 19____ by and between the State of Illinois, Department of Transportation, hereinafter referred to as LESSOR and _____ whose address is _____ of the city of _____ and the State of _____ hereinafter referred to as LESSEE.

Witnesseth that said LESSOR currently owns property located at _____ and LESSEE desires to lease (said property)(a portion of said property) for the sole purpose of _____ and not otherwise.

NOW THEREFORE, in consideration of the premises and of the mutual covenants and agreements hereinafter contained, LESSOR and LESSEE mutually agree that:

LESSOR, for and in consideration of the sum of _____ Dollars (\$ _____), which amount shall be divided into equal monthly payments of \$ _____ over the term of the lease, with the first payment being on the effective date of the lease agreement and each month thereafter on the _____ day, and the covenants and agreements hereinafter set forth leases to LESSEE for a period of _____ not exceeding five (5) years from the _____ day of _____, 19____, to and including the _____ day of _____, 19____. The LESSOR acknowledges receipt of the sum of _____ Dollars (\$ _____), from the LESSEE, as advanced payment for the first month of said term and as payment of the sum of \$ _____ as a security deposit.

The security deposit as provided herein may be used to defray the cost of repairs due to damages caused by the LESSEE except as herein excluded, or retained by the State as liquidated damage due to damages by the Tenant and/or for inconvenience caused to the State by the LESSEE's action or failure to act.

The premises being more particularly described as follows and shown on Exhibit A attached hereto and made a part hereof:

The above described property, as delineated on said Exhibit A, constitutes the entire property leased and shall be referred to herein as the premises.

LESSEE; further understands, covenants and agrees with the LESSOR as follows:

1. No representations as to the condition, repair or suitability of premises have been made by LESSOR, its agents or employees, to LESSEE prior to or at the execution of this Lease Agreement that are not herein expressed or endorsed hereon.
2. LESSEE intends to develop, occupy and use said premises as follows:

_____ according to a plan of operation specifically detailing the intended development, occupation and use of said premises, including the installation and location of any improvements to be situated thereon. Said plan of operation or any subsequent revised plans of operation shall be prepared by and at the sole cost and expense of LESSEE and must be approved by the District Engineer of District _____ of the Department of Transportation at _____ Illinois, who is hereby designated as the duly authorized representative of LESSOR. Such approval shall be subject to concurrence of the Federal Highway Administration. Any and all approved development and/or

Route _____
Job No. _____
Parcel No. _____
County _____

improvements shall be made at the sole cost and expense of LESSEE. LESSOR will not approve the construction of any permanent structures in, on or over said premises except as may hereinafter be provided.

The premises shall not be occupied or used by LESSEE for other than the purposes specified in the approved plan of operation without further written approval of LESSOR and concurred in by the Federal Highway Administration.

3. Payment set forth above shall be by certified check, bank draft or U.S. Postal money order payable to the Treasurer, State of Illinois, at such place as will be designated by the Lessor.
4. Signs, displays or devices shall be subject to regulation by the LESSOR, shall be restricted in size, location and design to those necessary as required for the occupation and use of the leased premises and shall not be visible from the travel lanes of the highway facility.
5. LESSEE shall obtain at its own expense any permits, licenses and/or certificates of either a temporary or a permanent nature as may be required for the use, occupancy, control of, or the conduct of business on the premises and shall give all notices and comply with all laws, ordinances, rules and regulations bearing on the use, occupation, control of, or conduct of business on said premises.
6. The leased premises shall not be used for the manufacture or storage of flammable material, nor for the conduct of any business or occupation causing the emission of fumes, vapors, odors, or discharges which may be deemed by the LESSOR to adversely affect the highway facility or the use thereof.
7. LESSEE shall keep said premises and appurtenances in a neat, clean and orderly condition at all times, and not cause, permit or suffer rubbish, junk cars, tin cans, garbage, or any other refuse to accumulate thereon; or permit or allow the sale or dispensing of spirituous, brewed or vinous beverages on said premises; or to make or suffer any unlawful, improper or offensive use of the premises contrary to any law of the United States of America or the State of Illinois or any ordinance of the City of _____ or County of _____ now or hereinafter made, or which shall be injurious and/or offensive to any person or property.
8. LESSEE assumes liability for all losses, expenses, costs, actions, cause of action, demands, damages and claims in connection with or arising out of any injuries, or claimed or alleged (including, but not being limited to, death) to any person, or any damage or claimed or alleged damage, to any property of any person (including, but not being limited to, LESSOR) sustained, or claimed, or alleged to have been sustained in connection with, or to have arisen out of or to have resulted from, whether directly or indirectly, the occupation and use of the premises by LESSEE, or by any one or more of its contractors, agents, servants or employees, and even though caused, occasioned or contributed to by the negligence, sole or concurrent, of LESSOR, its agents, servants or employees including, but not being limited to, losses, costs, expenses or damages sustained by LESSOR itself; and LESSEE agrees to indemnify and hold harmless LESSOR, its agents, servants and employees, from any and all such losses, expenses, costs, actions, causes of action, demands, damages and claims and agrees to defend any suit or action brought against any one or more of them based on any such alleged injury or damage, and to pay all damages, costs, losses and expenses incurred, including but not limited to, attorney's fees, in connection therewith or resulting therefrom.
9. LESSEE shall not assign this lease and shall not sublet the whole or any portion of the leased premises without the prior written consent of the LESSOR, subject to concurrence of the Federal Highway Administration.
10. LESSOR reserves to itself and its employees the right to enter, inspect and view the premises at all times and when required for the protection and maintenance of highway facilities, and LESSOR further reserves the right of immediate entry on leased premises and the right to take possession thereof in case of national or other emergency.

Route _____
Job No. _____
Parcel No. _____
County _____

11. LESSEE hereby irrevocably constitutes any attorney of any court of record of this State, attorney for LESSEE in LESSEE'S name, on default by LESSEE of any of the covenants herein, and upon complaint made by LESSOR and filed in any such court to enter LESSEE'S appearance in any such court of record, waive process, service thereof, and trial by jury and to confess judgment against LESSEE in favor of said LESSOR for forcible detainer of said premises with cost of said suit, and also to enter LESSEE'S appearance in such court, waive process and service thereof, and confess judgment from time to time for any payments which may be due said LESSOR by the terms of this lease with costs and a reasonable sum for attorney's fees, and to waive all errors and all right of appeal from said judgment and judgments and to file a consent in writing that a writ of restitution or other proper writ of execution may be issued immediately.
12. The LESSEE, at LESSEE'S own cost and expense, shall maintain said premises, including all driveways, fences and guardrails heretofore, or hereafter erected, provided that the LESSEE may at its expense install and maintain such additional entrances as may be required by its use of said premises, subject to permit requirements of, and the approval by the LESSOR and concurrence by the Federal Highway Administration. The LESSEE shall take all steps necessary to effectively protect and maintain fences and guardrails, and the piers and columns of the viaducts from damage incident to the LESSEE'S use of such premises, all without expense to the LESSOR. The LESSEE shall be liable to and shall reimburse the LESSOR for any damage to STATE-owned fences, guardrails, piers, or columns resulting from or attributable to the use and occupancy of said premises by the LESSEE or any person entering upon the same with the expressed or implied consent of the LESSEE. LESSOR, by the terms of this agreement, or otherwise, shall not be bound to do or cause to be done any maintenance, repair, replacements or improving of said premises or appurtenances thereto.
13. Under no circumstances shall direct ingress or egress be allowed from, to or over the premises described herein from or to any Freeway Highway facility.
14. The LESSEE shall, at its own expense, take out and keep in force during its tenancy (a) public liability insurance, in a company or companies to be approved by the LESSOR, to protect against any liability to the public incident to the use of, or resulting from injury to, or death of, any person occurring in or about the premises, in the amount of not less than _____ to indemnify against claim of one person, and in the amount of not less than _____, against the claims of two or more persons resulting from any one accident, and (b) property damage or other insurance, in a company or companies to be approved by the LESSOR, to protect LESSEE and any and every cause occurring in, or about, the premises, including any and all liability of the LESSEE and LESSOR for damage to vehicles parked on the premises, and to any damage caused to the highway facility by the LESSEE or anyone using the leased area as a permittee or licensee, by fire, or any item insurable under extended coverage insurance in the amount of not less than _____. Said policies shall inure to the contingent liabilities, if any, of the LESSEE and LESSOR and shall obligate the insurance carriers to notify LESSEE and LESSOR, in writing, not less than fifteen (15) days prior to the cancellation thereof, or any other change affecting the coverage of the policies. If said policies contain any exclusion concerning property in the care, custody or control of the insured, an endorsement shall be attached thereto stating that such exclusion shall not apply with regard to any liability of the LESSOR. In the event use of these premises should ever be approved for subleasing to private persons or firms, sublessee shall be obligated to obtain the aforesaid insurance. LESSEE shall furnish to the LESSOR a certified copy of each and every such policy within not more than ten (10) days prior to the effective date of the lease. LESSEE agrees that, if any approved SUBLESSEE does not keep such insurance in full force and effect, the LESSEE shall take out insurance and pay the premiums thereon.

In the event the LESSEE or an approved SUBLESSEE is unable to obtain the insurance required herein, this lease shall become null and void.

Route _____
Job No. _____
Parcel No. _____
County _____

15. This Lease may be cancelled and terminated by either party thereto giving ninety (90) days advance notice in writing to the other and may also be cancelled and terminated by LESSOR without notice, for any default by LESSEE in any of the covenants and agreements herein contained and upon any such termination and cancellation LESSOR may enter and repossess the premises at any time. Furthermore, upon such cancellation and termination or upon expiration of this Lease, LESSEE agrees to immediately yield possession of said premises to LESSOR and, at its sole cost and expense, to restore said premises to a condition satisfactory to LESSOR and to remove from the abovedescribed premises, all improvements, and appurtenances thereto, or any other property of any name or nature, utilized, owned or controlled by said LESSEE or anyone claiming under it, except the surfacing and column guards. Any such property not removed from premises within thirty (30) days after cancellation and/or termination of said Lease, may be removed and disposed of by the State of Illinois, its agents, employees, or contractors, in any manner it sees fit, at the sole cost and expense of the LESSEE, or the LESSOR, in its absolute discretion, may elect to declare the same the property of the LESSOR whereupon all rights, title and interest of the LESSEE therein shall terminate immediately.
16. No holding over by LESSEE shall operate to renew this agreement without the written consent of the LESSOR endorsed thereon. Should the LESSEE hold over after the expiration of the term of this lease, with the consent of the LESSOR, expressed or implied, said tenancy shall be deemed to be a tenancy only from month to month, subject otherwise to all the terms and conditions of this Agreement so far as applicable.
17. LESSEE agrees to abide by such other rules and regulations as may be initiated by the District Engineer for the Department of Transportation.
18. The LESSEE, for himself his personal representative, successors in interest, and assigns, as a part of the consideration hereof, does hereby covenant and agree as a covenant running with land, that 1) no person, on the ground of race, color, sex, or national origin shall be excluded from participation in, be denied the benefits of, or be otherwise subjected to discrimination in the use of said facilities, 2) that in connection with the construction of any improvements thereon, no discrimination shall be practiced in the selection of employees and contractors, by contractors in the selection and retention of first-tier subcontractors, and by first-tier subcontractors in the selection and retention of second-tier subcontractors, 3) that such discrimination shall not be practiced against the public in the proper access to and use of the facilities over, or under the premises, and 4) that the LESSEE shall use the premises in compliance with all other requirements imposed pursuant to title 49, code of Federal Regulations, Department of Transportation, subtitle A, Office of The Secretary, Part 21 Nondiscrimination in Federally assisted programs of the Department of Transportation. Effectuation of Title VI of the Civil Rights Act of 1964, and as said regulations may be amended.

That in the event of breach of any of the above nondiscrimination covenants, the LESSOR shall have the right to terminate the lease and to reenter and repossess said land and the facilities thereon, and hold the same as if said lease had never been made or issued.
19. The terms and provisions of this Agreement shall extend to and be binding upon and inure to the benefit of any approved successor of the LESSEE.

Route _____
Job No. _____
Parcel No. _____
County _____

IN WITNESS WHEREOF, the parties hereto have executed this Lease Agreement as of the day, month and year first above written in two counterparts, each of which shall be deemed to be an original, and such counterpart shall constitute one and the same instrument;

ATTEST:

LESSEE

ATTEST:

STATE OF ILLINOIS
DEPARTMENT OF TRANSPORTATION

Director, Division of Highways

By: _____
Secretary

STATE OF ILLINOIS
DEPARTMENT OF TRANSPORTATION
DIVISION OF HIGHWAYS

Route _____
Section _____
Project _____
County _____
Job No. _____
Parcel No. _____

NOTICE TO BIDDERS AND BIDDER'S PROPOSAL
FOR LEASING OPERATING HIGHWAY RIGHT OF WAY-
(NON-HIGHWAY RELATED USE) BY SEALED BIDS OR AT AUCTION

1. TIME, DATE, AND PLACE FOR RECEIVING BIDS: (Sealed)(auction) bids for the leasing of State owned property as hereinafter described will be received by the DEPARTMENT OF TRANSPORTATION, Division of Highways (at)(until no later than) _____ (AM)(PM) on _____, _____, 19____, at _____, Illinois successful bidder to be announced publicly immediately following the bidding.

Property may be inspected on _____, 19____, from _____ to _____.
2. PROPERTY TO BE LEASED:

A description of the property and form of the Lease Agreement attached.

No bid will be accepted in an amount less than the current appraised rental rate as discussed herein.
3. The Department of Transportation reserves the right to reject any and all bids for the lease of property and to waive technicalities at its discretion.
4. Each bid must be accompanied by a performance deposit in the form of a cashier's check, bank draft, certified check or money order (or personal check if previously approved by the District Engineer) for one months rent at the minimum appraised rate, made payable to Treasurer-State of Illinois. The deposits of unsuccessful bidders will be returned after the sale is closed, and announcement of the highest acceptable bid.
5. The performance deposits of the successful bidders shall be retained in the District Office until notification is given to the Department's District Engineer that the lease has been executed and payment therefore made in accordance with the terms of the agreement.
6. The State of Illinois, Department of Transportation, in accordance with the provisions of Title VI of the Civil Rights Act of 1964 (78 Stat. 252) and the regulations of the Department of Commerce 15 C.F.R. (Part 8) issued pursuant to such Act will affirmatively insure that acceptance of any bid pursuant of this notice or advertisement will be without discrimination on the ground of race, color, sex, or national origin.

7. It is the responsibility of the bidder to examine applicable zoning ordinances and the Department expressly disclaims any responsibility for any bids predicated on a use forbidden by the applicable zoning. Also the responsibility for determination of whether public utilities and services are available rests solely on the bidder and the State expressly excludes any warranties, expressed or implied, as to availability of public utilities or services.
8. Additional information concerning the property or lease agreement may be obtained from the Office of the District Engineer, Division of Highways, _____, _____.

DEPARTMENT OF TRANSPORTATION

District Engineer

BIDDER'S PROPOSAL

1. The undersigned hereby submits the following bid for the subject property offered for Lease:

Parcel _____ . Amount of Bid _____ .
2. In submitting the above Bid, the undersigned declares that the only person or parties interested in the Bid as principal(s) are those named herein and that such Bid is made without collusion with any other parties, firm or corporation.
3. The undersigned further declares that he has carefully inspected in detail the described property, and have familiarized himself with all of the conditions affecting the leasing and use thereof and understands that, in making the above Bid, he waives all rights to plead any misunderstanding regarding the same.
4. In the event this proposal is accepted it shall constitute a contract between the parties hereto but such contract shall not be assigned or transferred by the undersigned without the express written consent of the Department in accordance with the provisions of the Lease Agreement, which consent may be granted or denied at the discretion of Department for any reason whatsoever.
5. The undersigned understands and agrees to assume all liability for the property upon acceptance of this proposal by the State, that the State will not be responsible for any loss or damage whatsoever, and that no work shall be started until a properly executed Lease Agreement is delivered to Lessee.

6. The undersigned understands that failure to specifically perform in accordance with the terms and conditions of this contract and/or within the time limit specified herein, without written consent to the contrary from the STATE, shall constitute a forfeiture and the entire amounts paid and the performance deposit shall become the property of the State as liquidated damages due to delay and inconvenience suffered by the State by such action and the STATE, or any of its agents, officials or employees are authorized to enter upon and take full and complete possession of said property and any improvements that may have been placed on leased property may be removed by the State; and the undersigned understands and agrees to pay all charges and other expenses arising therefrom or incurred in connection therewith.

In the event this proposal is accepted the party to be contacted during the term of the lease is:

Name _____

Address _____

Telephone _____

(If an individual)

Signature of Bidder _____ (SEAL)

Business Address _____

(If a Co-partnership)

Firm Name _____

By _____ (SEAL)

By _____ (SEAL)

Business Address _____

Name & Addresses
of All Members of
the Firm

(If a Corporation)

Corporate Name _____ (SEAL)

By _____ (SEAL)

Business Address _____

Names of Officers { (President _____
(Secretary _____
(Treasurer _____

Attest: _____
Secretary

Proposal recommended for acceptance by the Department of Transportation,
State of Illinois.

Dated this _____ day of _____, A.D., 19____.

By _____
District Engineer

LOCATION - ADDRESS	Illinois Department of Transportation Bureau of Land Acquisition Inventory and Management of Leased Space - Operating Right of Way (Non-Highway Related Use)	Parcel No. _____ Route _____ Section _____ Job No. _____ County _____ Project _____
--------------------	--	--

TITLE VESTED	RENTAL RATE	PROPOSED USE	F.H.W.A. APPROVAL	EFFECTIVE DATE	EXPIRATION DATE
State _____ County _____ City _____	Mo. _____ Ann. _____				

Area - Shape	Appraiser-Mkt.Rate	Permitted Improvements	Dates Advertised	Date Lease Auction	Total Rent Rcvd.

COMMENTS:

INSPECTIONS: Include - Condition as found, Recommendation or Action Taken. Sign each Entry.

Date:	Date:	Date:	Date:	Date:
By:	By:	By:	By:	By:
Date:	Date:	Date:	Date:	Date:
By:	By:	By:	By:	By:

A-86

Lessee	Contact Person	Address	Telephone #
1)			
2)			
3)			
Comments			

19	Jan.	Feb.	March	April	May	June	July	Aug.	Sept.	Oct.	Nov.	Dec.	TOTAL
Inv. No.													
Remit. No.													
Amount													
19													
Inv. No.													
Remit No.													
Amount													
19													
Inv. No.													
Remit No.													
Amount													
19													
Inv. No.													
Remit No.													
Amount													
19													
Inv. No.													
Remit No.													
Amount													
19													
Inv. No.													
Remit No.													
Amount													
TOTAL RENT COLLECTED													

GENERAL INSTRUCTIONS FOR COMPLETING
INVENTORY AND MANAGEMENT OF LEASED SPACE -
OPERATING RIGHT OF WAY (NON-HIGHWAY RELATED USE)
(EXHIBIT 5.10-10A)

This form shall be maintained as a current record of all operational Right of Way, non-highway related use lease agreements. This inventory shall reflect current status at any given time.

1. Location-Address - Should be sufficient for a person unfamiliar with the property to locate it without difficulty.
2. Title Vested - To be used for expressway property when title is vested in other than, or in conjunction with, the State.
3. Rental Rate - Insert the rate of payment which was bid and accepted by the Department on either a monthly or annual basis.
4. Proposed Use - i.e., automobile parking.
5. FHWA Approval - A copy of this approval will be sent to the District with the executed documents and the date should be inserted to facilitate future reference and audits.
6. Effective Date - The date the first rental payment is due or date of execution in order to establish the 5-year term.
7. Expiration Date - Self-explanatory; however, required to be kept for all leases.
8. Area - Shape - Either by square footage or acreage.
9. Appraiser - Market Rate - The appraiser's name and the rate established as the fair market value monthly or annually.
10. Permitted Improvements - List all improvements the Department has agreed to allow.
11. Dates Advertised, Date Lease Auctioned, Total Rents Received - Self explanatory.
12. Inspections - Each leased parcel should be inspected by the Department a minimum of twice a year. The purpose of inspection would be better served if conducted on an as needed basis rather than on a prearranged time schedule. All findings and necessary follow up action should be noted.
13. The reverse side of the form is proposed to be used as indicated including rental tabulations and should be used in place of the BRW 761 for recording rental payments for non-highway use leases only. A copy of the form for each lease should be submitted to the Central Office at the time of initiation and upon termination, and otherwise semi-annually - January 1 and July 1 for each lease in effect.
14. The form also provides for 3 separate lessees during the five year term of a lease, in the event the Department approves a transfer of the leased parcel to another tenant.

5.10 MANAGEMENT OF LEASED AREAS-OPERATING RIGHT OF WAY FOR
NON-HIGHWAY RELATED USE - GENERAL

Where the Department has acquired sufficient legal right, title and interest in the highway right of way to permit the use of certain space for non-highway related purposes, and where such space is not required presently or in the foreseeable future for the safe and proper operation and maintenance of the highway facility, the right to temporary occupancy or use of such space may be granted by the Department subject to Federal Highway Administration (FHWA) approval, where applicable.

Paragraph 49.13 of Chapter 127, Illinois Revised Statutes, authorizes the leasing of any land or property under the jurisdiction of the Department provided that no such lease be for a longer period of time than five years.

5.10-1 DEFINITION

The terms "space", "airspace" or "area" are used synonymously within this Section and are defined as that which is located above, at or below the highway's established grade line and lying within the established operating right of way limits of the highway facility.

5.10-2 PROCEDURE TO USE SPACE - GENERAL

Any individual, company, organization, public or quasi-public agency, desiring to use space as defined herein must submit an application to the District Engineer (DE) having supervision over State highways in the county where the desired site is located.

The application shall be submitted in writing and shall contain the names of the parties involved and a general statement of the proposed use together with any preliminary maps, sketches, photographs and plans which are necessary to describe the pertinent features in relation to the highway facility.

Upon receipt of an application for leasing space as set out in this paragraph, the District will have prepared or cause to be prepared a lease agreement setting out the standard provisions and such other specific and/or unique conditions as to the use of the property to be leased. A form of Lease Agreement which may be used is shown as Exhibit 5.10-3A.

It is necessary that a complete evaluation be made within the Department in order to determine (1) whether or not the proposed use will adversely affect the existing operating facilities of the Department, (2) whether or not the land will be needed during the proposed period for operation, maintenance, improvement or construction of the highway facility, and (3) any adverse effects the proposed use of the area would have on the maintenance or operation of the highway facility.

The District Bureau of Land Acquisition shall forward a copy of the application and supporting documentation to the District Bureau of Maintenance with a proposed form of lease agreement for their review, comments, and approval. After approval by the District Bureau of Maintenance the Bureau of Land Acquisition will then forward four (4) copies of the application and supporting documents including the proposed form of lease together with the District's comments and recommendations to the Central Bureau of Land Acquisition. The Bureau of Land Acquisition will in

turn review and obtain comments and approvals of the proposed use from the other Central Bureaus as may be appropriate and necessary. If the proposal to lease such space is found to be satisfactory, the Central Bureau of Land Acquisition will obtain approval from the FHWA, if applicable. After all approvals are received the District will be authorized to proceed with leasing the desired space in accordance with procedures set forth in the following paragraph.

5.10-3

LEASE AGREEMENT

Occupancy and use of operating highway right of way for a non-highway use shall only be permitted by a properly executed Lease Agreement. A form of such Agreement is shown as Lease Agreement (Exhibit 5.10-3A) should be prepared in duplicate. Although the Agreement may vary somewhat depending upon the type of use proposed, it shall contain the following provisions:

- (1) The party responsible for developing and operating the space.
- (2) A general statement of the proposed use.
- (3) The general design for the use of the space, including any facilities to be constructed, and such maps, plans or sketches as are necessary to set out pertinent features in relation to the highway facility.
- (4) A detailed description (three-dimensional, if applicable) of the space to be occupied and used.
- (5) Provision that the design and construction of any improvements or structures to be built within the approved space shall be subject to the prior approval of the Department. If the space is located on the Federal-aid highway system, the design and construction shall also be subject to the approval of FHWA in accordance with the specifications set forth in Volume 7, Chapter 4, Section 3, of the Federal-aid Highway Program Manual.
- (6) Provision that any change in the authorized use of space shall receive prior approval by the Department subject to concurrence by the FHWA (where applicable).
- (7) Provision that such space shall not be transferred, assigned or conveyed to another party without prior approval by the Department subject to concurrence by the FHWA (where applicable).
- (8) Provision that the Agreement will be revocable in the event that the space facility ceases to be used or is abandoned.
- (9) Provision for the Agreement to be revoked if the Agreement is violated and such violation is not corrected within a reasonable length of time after written notice of noncompliance has been given. Further, that in the event the Agreement is revoked and the Department deems it necessary to request the removal of the facility occupying the space, the removal shall be accomplished at the sole expense of the individual, organization or agency granted the use of the space in a manner prescribed by the Department. An exception to this provision may be permitted when the improvements revert to the State upon termination of the Agreement.

- (10) When deemed necessary by the Department or the FHWA (where applicable) provision for adequate insurance by the responsible party for the payment of any damages which may occur during or after construction of the space facilities and saving the State harmless. Exception to this requirement may be made where the proposal is for the use by a public or quasi-public agency, when such agency is assigned the specific responsibility for payment of any related damages occurring to the highway facility and to the public for personal injury, loss of life and property damage.
- (11) Provision for the Department and authorized FHWA representative (where applicable) to enter the space facility for the purpose of inspection, maintenance or reconstruction of the highway facility when necessary.
- (12) Provision that the facility to occupy the space will be maintained so as to assure that the structures and the area within the highway right of way boundaries will be kept in good condition, both as to safety and appearance, and that such maintenance will be accomplished in a manner so as to cause no unreasonable interference with highway use. In the event the responsible party fails in its maintenance obligations, there will be provision for the Department to enter the premises to perform such work; and charge the costs incurred in connection therewith to the responsible party.
- (13) Appropriate provision of Appendices "A" and "B" of the State's Civil Rights Assurances with respect to Title VI of the Civil Rights Act of 1964 and 49 CFR 21.
- (14) Provision that any significant revision in the design or construction of a facility shall receive prior approval by the Department subject to concurrence by the FHWA (where applicable).

5.10-4

PROCESSING THE LEASING OF SPACE

After authorization to proceed with the proposed leasing of space is received by the District an appraisal must be obtained to establish the current market rental rate. One or more appraisals must be prepared in accordance with current appraisal policy and procedure of the Bureau of Land Acquisition. In the majority of situations one appraisal should suffice. The appraisal reports are to be reviewed by the District Reviewing Appraiser and then submitted to the Central Bureau of Land Acquisition with a statement that the accepted or documented appraisal indicates the current rental rate of the premises in question. Each operating right of way parcel or rental unit shall be leased through the public solicitation of bids for not less than the minimum rental rate established by an appraisal. An exception to this would be where the property to be leased is inaccessible to other than the owner of only one abutting parcel, or other unique circumstances prevail, in which case the District should request a waiver of the requirement to advertise for the solicitation of bids at the same time the application to lease is submitted for approval. Recommendation for approval of such waiver should be in writing setting out the circumstances and conditions whereby the waiver may be justified.

5.10-5

ADVERTISING & NOTICE TO BIDDERS

To insure that the solicitation for bids is public, the proposal must be advertised by placing a notice in a local newspaper of general circulation. This notice shall be published at least once each week for two consecutive weeks with the lease bidding to be held within a reasonable time after the date of the last publication of the notice.

As a minimum newspaper advertisements shall contain the following information:

- (1) General description and location of the property to be leased.
- (2) The dates and times the property will be open for inspection.
- (3) The date and time when sealed bids will be opened or oral bidding will commence.
- (4) The location where sealed bids will be received and opened or the public auction will be conducted.
- (5) Telephone number of person(s) to be contacted for information concerning the lease.

The "Notice to Bidders and Bidders Proposal" form attached as Exhibit 5.10-6A should also be prepared showing the required information for distribution to prospective bidders.

The District shall also by memorandum advise the Central Bureau of Land Acquisition of the date, time and location for bids to be received for the proposed leasing of space.

5.10-6 BIDDERS PROPOSALS AND PERFORMANCE DEPOSITS

In the case of written sealed bids, each bid, in order to be qualified, must be (1) for not less than the current minimum rental rate as shown on the appraisal review certification, and (2) submitted on the "Notice to Bidders and Bidders Proposal" form (See Exhibit 5.10-6A), accompanied by a bank draft, cashier's check, certified check, or money order as a performance deposit made payable to the Treasurer of the State of Illinois in an amount equal to at least the current minimum established rental rate (monthly) as shown on the appraisal review certification. This amount is subject to increase or decrease at the discretion of the District Engineer.

In the case of auction bids, it is advisable to obtain a register of the names and addresses of all prospective bidders before commencing the auction. The names and addresses should be verified by also registering the bidders drivers license or social security number. The successful bid must not be for less than the current minimum established rental rate (monthly) as shown on the appraisal review certification. At the conclusion of bidding the prospective lessee shall execute the completed "Notice to Bidders and Bidders Proposal" form. A cash deposit in the form of a certified check, cashier's check, money order or bank draft must also be obtained from the high bidder immediately after completion of bidding, which shall be retained by the District pending approval of and execution of the space lease agreement.

All bidders must be fully informed of the required deposit and that the Department reserves the right to retain such deposit as liquidated damages in the event the successful bidder refuses to complete the transaction. The deposit should be in an amount equal to at least the current minimum rental rate (monthly) as shown on the appraisal review certification and is subject to increase or decrease at the discretion of the District Engineer.

The deposit checks of successful bidders are retained by the District until the transaction is fully consummated. The deposit checks of the unsuccessful bidders under the sealed bid procedure shall be returned to such respective unsuccessful bidders as soon as the leasing to the successful bidder has been finalized by execution of the Lease Agreement.

AFTER THE BIDDING

After the conclusion of bidding, the approved space lease agreement which will have been prepared by the District in duplicate shall be filled in with the named lessee and the amount of rent to be paid and properly executed by the successful bidder. The duplicate original copies shall be submitted with attached premise plat, drawings and other documentation required to be attached to the lease. Also send a report of bidding if by auction, or a list of bids, if by sealed bids, a copy of the "Notice to Bidders and Bidder's Proposal" completed by the successful bidder, together with a recommendation for the acceptance of the bid, to the Central Bureau of Land Acquisition for review and to obtain execution of the lease agreement by the Department. Two (2) extra copies of the plat, plans and/or premise plans or other documents which are required to be attached to the lease should also be submitted at this time. In order to avoid any future misunderstanding concerning the transaction, the named lessee should be exactly the same on the agreement as that shown on the bidders proposal. Also, if the lease agreement is to be executed by a Trust, an affidavit of disclosure of the beneficial interests of such Trust must be obtained and submitted at this time to the Central Bureau of Land Acquisition. After execution by the Secretary of the Department of Transportation and attestation by the Director of Highways, the duplicate originals of the lease agreement will be forwarded to the District Office for delivery and completion of the transaction. The Central Office will also forward a copy of the fully executed lease to the Federal Highway Administration. The District will furnish a copy of the fully executed lease to the District Bureau of Maintenance.

Immediately following delivery of the agreement and receipt of the required payment the District will prepare an "Accounts Receivable - Invoice" and an "Accounts Receivable Remittance Statement" in accordance with the procedures outlined in 7.04 of this Manual.

SOLICITING NEW TENANTS OR RENEWAL OF LEASES

As soon as it is determined that the incumbent tenant occupants intend to vacate the leased space every effort should be made to solicit for prospective tenants. Whether or not there is an existing waiting list of prospective tenants will determine the extent of solicitation required. It may be necessary and is permissible to advertise locally for prospective tenants.

Where the use of the premises will be unchanged from the previous approved use it will not be necessary to submit a formal application, however all of the material and documents otherwise required by this Section will be available and the solicitation for bids and award to successful bidder would be on the same basis as set out herein. The District Bureau of Maintenance must also approve continuation of such use. Where a waiver of public bidding has been previously authorized it would not be necessary to solicit bids provided the same conditions exist whereby such waiver was first approved. In most cases an updated appraisal will be required.

EFFECTIVE DATE FOR LEASE AGREEMENTS

The effective date of the lease agreement with any tenant should be no later than the date the prospective tenant occupies the property. The deposit for payment of the last month's rent and the first month's rent shall be due no later than the effective date of the agreement.

As a suggestion it would seem to be desirable for leases to become effective on the first day of the month so that preparation of invoices and other similar management activities involving the leased premises can be conducted more effectively.

5.10-10 INVENTORY AND MANAGEMENT OF LEASED OPERATING RIGHT OF WAY

The District Bureau of Land Acquisition shall maintain a record on each parcel. The form to be used for this purpose is identified as "Inventory and Management of Space" (Exhibit 5.10-10A) which includes required information on each space under lease, or available for lease and certain required information to assure the proper management of each leased area. A rental tabulation schedule is also included in this form and covers the entire term (5 years) of the lease. This form should be initiated by the District as soon as information becomes available that the space is considered for leasing. Line item instructions for this form are found in Exhibit 5.10-10B. All appurtenances and improvements located on the leased premises should be identified in the inventory. A form of Index of leased areas is also shown as Index Exhibit 5.10-10C.

A parcel file shall also be maintained on each leased space containing the following information:

- (1) Location of leased parcel, survey highway station or other appropriate identification including a photograph if available.
- (2) Identification including copy of application and plans showing the authorized use of the space.
- (3) A detailed description.
- (4) As-built construction plans of the highway facility at the location where the use of space was authorized or such plans should be available within the District.
- (5) Plans of the facility, if any, authorized to occupy the space.
- (6) A copy of the prior and current executed Lease Agreement.
- (7) Other pertinent information and records such as affidavits of disclosure of beneficiaries of a Trust, etc. . .
- (8) Copy of prior and current appraisal including Appraisal Reviewer's certification.

During the time management of leased space is the responsibility of the Bureau of Land Acquisition, certain expenditures of funds may be required and the following procedures will prevail where it is necessary to purchase services and/or materials in connection therewith:

- (1) Authorized expenditures from the ensuing fiscal year program of the Bureau of Land Acquisition will be limited to the costs and expenses incurred for appraisals obtained to establish the current rental rate for the premises to be leased and advertising costs for the solicitation of tenants to use and occupy such space.
- (2) All costs and expenses necessary for the repair and/or maintenance of leased areas including appurtenances thereto, shall be authorized and approved by the District Bureau of Maintenance and where required the Central Bureau of Maintenance, and any work performed and/or materials used and furnished in connection therewith shall be approved by and under the direct supervision of the District Bureau of Maintenance.

In addition to the specific policy and procedure set forth in this Section (5.10) all activities, operations and management of the leased space will be conducted in accordance with pertinent provisions and requirements of applicable sections, paragraphs and chapters of this Manual.

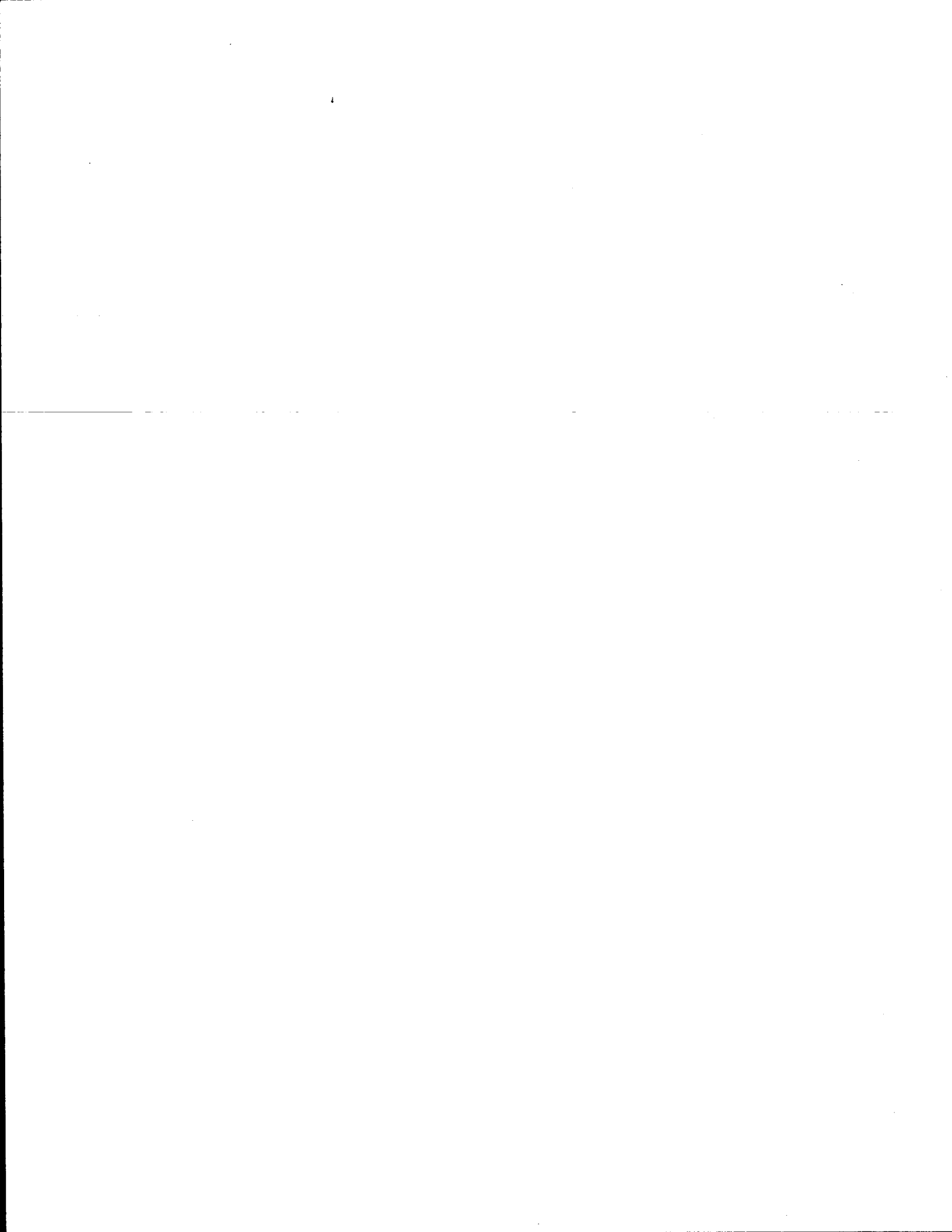

INDIANA

- Legislation



injured, the question whether defendant's view of the decedent was obstructed at the time of the injury was a question of fact for the jury. *American Carloading Corp. v. Gary Trust & Sav. Bank*, 216 Ind. 649, 25 N.E.2d 777 (1940).

Negligence.

Acts 1925, ch. 213, § 36, p. 570 made it the duty of the driver to regularly and continuously pay attention to the highway. *Pfisterer v. Key*, 218 Ind. 521, 33 N.E.2d 330 (1941).

The warning which, by statute, the driver of an automobile was required to give when

approaching a pedestrian was for the purpose of giving the pedestrian an opportunity to protect himself, and it might also have been construed as a notice to the pedestrian that the driver intended to use that part of the highway on which the pedestrian was walking, and the duty to slow down was enjoined upon drivers of automobiles, perhaps to the end that the driver might change the course of his automobile in time to avoid a collision, if the pedestrian did not heed the warning. *Pfisterer v. Key*, 218 Ind. 521, 33 N.E.2d 330 (1941).

9-4-1-90. Pedestrians' use of crosswalks — Walking on roadway.

— (a) Pedestrians shall move, whenever practicable, upon the right half of crosswalks.

(b) Where a sidewalk is provided and its use is practicable, it shall be unlawful for any pedestrian to walk along and upon an adjacent roadway.

(c) Where a sidewalk is not available, any pedestrian walking along and upon a highway shall walk only on a shoulder, as far as practicable from the edge of the roadway.

(d) Where neither a sidewalk nor a shoulder is available, any pedestrian walking along and upon a highway shall walk as near as practicable to an outside edge of the roadway, and, if on a two-way roadway, shall walk only on the left side of the roadway.

(e) Except as otherwise provided in this chapter, any pedestrian upon a roadway shall yield the right-of-way to all vehicles upon the roadway. [Acts 1939, ch. 48, § 86, p. 289; 1947, ch. 338, § 15, p. 1336; 1978, P.L. 63, § 5.]

Cross References. Violation of this section a Class C infraction, 9-4-1-127.1.

NOTES TO DECISIONS

ANALYSIS

Effect of violation.
Instructions.

Effect of Violation.

There were no cases holding a violation of this statute to constitute negligence per se and the rule appeared to be that a violation of this section would be actionable negligence only if the violation were the proximate cause of the resulting injury. *Goff v. Sears, Roebuck & Co.*, 257 F.2d 418 (7th Cir. 1958), cert. denied, 358 U.S. 931, 79 S. Ct. 318, 3 L. Ed. 2d 303 (1959).

Instructions.

An instruction should not have been given that if the defendant truck driver carelessly and negligently failed to slow down and give timely signal when approaching the plaintiff, a pedestrian on the highway while plaintiff was walking and standing on a traveled

portion of the highway thereby plaintiff being injured as a direct and proximate result of such defendant's negligence while the plaintiff was in the exercise of ordinary care for his own safety then the defendant should be found guilty, since the testimony of plaintiff himself showed he was fully aware of the position of approaching truck a short distance from him and that he was clad in dark clothing walking with his back to the traffic in the nighttime because such instruction in effect shielded plaintiff against defendant's sole contention that plaintiff was at fault in negligently walking on a highway by emphasizing the duty of the defendant driver to all pedestrians standing or walking on the highway while minimizing the duty of plaintiff to exercise due care for his safety. *Goff v. Sears, Roebuck & Co.*, 257 F.2d 418 (7th Cir. 1958), cert. denied, 358 U.S. 931, 79 S. Ct. 318, 3 L. Ed. 2d 303 (1959).

9-4-1-91. Pedestrians soliciting rides. — (a) No person shall stand in a roadway for the purpose of soliciting a ride from the driver of any vehicle unless the person is faced with an emergency on the roadway, in which case the person may secure a ride in order to obtain assistance.

(b) No person shall stand on a highway for the purpose of soliciting employment or business from the occupant of any vehicle.

(c) No person shall stand on or in proximity to a street or highway for the purpose of soliciting the watching or guarding of any vehicle while parked or about to be parked on a street or highway. [Acts 1939, ch. 48, § 87, p. 289; 1978, P.L. 63, § 6; 1981, P.L. 122, § 3.]

Cross References. Violation of this section a Class C infraction, 9-4-1-127.1.

9-4-1-91.1. Driving vehicle through safety zone prohibited — Right-of-way when vehicle crossing sidewalk. — (a) No vehicle shall at any time be driven through or within a safety zone.

(b) The driver of a vehicle crossing a sidewalk shall yield the right-of-way to any pedestrian and all other traffic on the sidewalk. [IC 9-4-1-91.1, as added by Acts 1978, P.L. 63, § 7.]

Cross References. Driving through safety zone prohibited, 9-4-1-105.

Safety zone defined, 9-4-1-17.

9-4-1-91.2. Pedestrian duty to yield to authorized emergency vehicles. — (a) Upon the immediate approach of an authorized emergency vehicle making use of an audible signal and visual signals, or of a police vehicle properly and lawfully making use of an audible signal only, every pedestrian shall yield the right-of-way to the authorized emergency vehicle.

(b) This section does not relieve the driver of an authorized emergency vehicle from the duty to drive with due regard for the safety of all persons using the highway nor from the duty to exercise due care to avoid colliding with any pedestrian. [IC 9-4-1-91.2, as added by Acts 1978, P.L. 63, § 8.]

Cross References. Authorized emergency vehicles defined, 9-4-1-2.

Cited: City of Indianapolis v. Clint's

Wrecker Serv., Inc., 440 N.E.2d 737 (Ind. App. 1992).

9-4-1-91.3. Driver's duty to yield to blind pedestrian. — The driver of a vehicle shall yield the right-of-way to any blind pedestrian carrying a clearly visible white cane or accompanied by a guide dog. [IC 9-4-1-91.3, as added by Acts 1978, P.L. 63, § 9.]

9-4-1-91.4. Pedestrian use or passage of bridge or railroad crossing — When prohibited. — (a) No pedestrian shall enter or remain upon any bridge or approach thereto beyond the bridge signal, gate, or barrier after a bridge operation signal indication has been given.

Cross References. Violation of this section a Class C misdemeanor, 9-4-1-127.1.

Cited: Rader v. Collins, 130 Ind. App. 227, 161 N.E.2d 381 (1959); Stapinski v. Walsh Constr. Co., 272 Ind. 6, 74 Ind. Dec. 55, 395 N.E.2d 1251 (1979).

Collateral References. Comment note on effect of violation of safety equipment statute as establishing negligence in automobile accident litigation. 38 A.L.R.3d 530.

Driving motor vehicle without lights or with improper lights as affecting liability for collision. 21 A.L.R.2d 7; 62 A.L.R.3d 554; 62 A.L.R.3d 768; 62 A.L.R.3d 840.

Duty to provide motor vehicle with adequate rearview mirror. 27 A.L.R.2d 1040.

Liability of motor vehicle owner or operator for accident occasioned by blowout or other failure of tire. 24 A.L.R.2d 161.

Liability of motor vehicle owner or operator for personal injury or death of passenger or guest occasioned by inhalation of gases or fumes from exhaust. 56 A.L.R.2d 1099.

Liability of owner or operator of motor vehicle for accident resulting from alleged breaking of or defect in steering mechanism. 23 A.L.R.2d 539.

Liability of owner or operator of motor vehicle for injury, death, or property damage resulting from defective brakes. 40 A.L.R.3d 9.

Defective vehicular windows. 3 A.L.R.4th 489.

Personal injury or death allegedly caused by defect in electrical system in motor vehicle. 5 A.L.R.4th 882.

Liability for delay in making repair of motor vehicle. 44 A.L.R.4th 1174.

[PENALTIES]

9-4-1-127. [Repealed.]

Compiler's Notes. This section, concerning driver improvement courses and miscellaneous penalties, was repealed by Acts 1981, P.L. 108, § 41. For new law see 9-4-1-127.1.

9-4-1-127.1. Violations — Penalties. — (a) A person who violates section 41 or 45(a) [9-4-1-41 or 9-4-1-45(a)] of this chapter commits a class C misdemeanor.

(b) A person who violates section 24, 33, 34, 35, 36, 37(a)(1), 37.1, 38, 50, 57, 59, 60, 61.1, 63, 65, 66, 67, 68, 69, 70, 71, 72, 73, 74, 75, 76, 77, 78, 79, 81, 82, 83, 84, 85, 87, 88, 89, 90, 91, 91.1, 91.2, 91.3, 91.4, 95, 96, 97, 98, 99, 100, 102, 103, 104, 105, 106, 107, 108, 109, 110, 111, 112, 114, 115, 117, 118, 120, 121, 122.1, 123, or 126 [9-4-1-24, 9-4-1-33, 9-4-1-34, 9-4-1-35, 9-4-1-36, 9-4-1-37(a)(1), 9-4-1-37.1, 9-4-1-38, 9-4-1-50, 9-4-1-57, 9-4-1-59, 9-4-1-60, 9-4-1-61.1, 9-4-1-63, 9-4-1-65, 9-4-1-66, 9-4-1-67, 9-4-1-68, 9-4-1-69, 9-4-1-70, 9-4-1-71, 9-4-1-72, 9-4-1-73, 9-4-1-74, 9-4-1-75, 9-4-1-76, 9-4-1-77, 9-4-1-78, 9-4-1-79, 9-4-1-81, 9-4-1-82, 9-4-1-83, 9-4-1-84, 9-4-1-85, 9-4-1-87, 9-4-1-88, 9-4-1-89, 9-4-1-90, 9-4-1-91, 9-4-1-91.1, 9-4-1-91.2, 9-4-1-91.3, 9-4-1-91.4, 9-4-1-95, 9-4-1-96, 9-4-1-97, 9-4-1-98, 9-4-1-99, 9-4-1-100, 9-4-1-102 (repealed), 9-4-1-103 (repealed), 9-4-1-104 (repealed), 9-4-1-105, 9-4-1-106, 9-4-1-107, 9-4-1-108, 9-4-1-109, 9-4-1-110, 9-4-1-111, 9-4-1-112, 9-4-1-114, 9-4-1-115, 9-4-1-117, 9-4-1-118, 9-4-1-120, 9-4-1-121, 9-4-1-122.1, 9-4-1-123, or 9-4-1-126] of this chapter commits a class C infraction.

(c) If a person has been found to have committed any traffic offense as defined in IC 9-4-7-2, the court may:

- (1) Require the person to attend and satisfactorily complete a driver improvement course which has been approved by the court and the bureau of motor vehicles, or by the bureau of motor vehicles;
- (2) Place the person on probation for up to one (1) year; and
- (3) Suspend the person's driver's license for up to thirty (30) days.

(d) A driver improvement course required under subsection (c) may be financed by assessing a charge which will cover the direct cost of the course, but not to exceed twenty-five dollars (\$25). [IC 9-4-1-127.1, as added by 1981, P.L. 108, § 11; P.L.114-1985, § 1.]

Compiler's Notes. Sections 102, 103, and 104 of this chapter, listed in subsection (b), were repealed by P.L.108-1985, § 1.

Cross References. Infraction and ordinance violation enforcement proceedings, 34-4-32-1 — 34-4-32-5.

Penalties for misdemeanors, 35-50-1-1 — 35-50-1-3, 35-50-3-1 — 35-50-3-4, 35-50-5-2.

Cited: Johnson v. State, 450 N.E.2d 123 (Ind. App. 1983); Hamilton v. DuBois, 491 N.E.2d 213 (Ind. App. 1986).

Opinions of Attorney General. Cities and towns have no authority to enact a traffic ordinance which sets forth the same speed

regulations as the state code, and all violations of the speed regulations must be prosecuted as a violation of the state law rather than a city or town ordinance. 1953, No. 60, p. 304 (rendered under prior law).

The board of county commissioners may lower or raise the prima facie reasonable speed limits on the roads in the county system and may post signs giving notice thereof on the roads. Any speed violation on the county roads is an offense against the state and is a misdemeanor. 1959, No. 56, p. 272 (rendered under prior law).

[PARTIES, PROCEDURE UPON ARREST, AND REPORTS IN CRIMINAL CASES]

9-4-1-128. [Repealed.]

Compiler's Notes. This section, concerning parties to crimes under this chapter, was repealed by Acts 1978, P.L. 2, § 970. For present law on aiding, inducing, or causing

an offense, see 35-41-2-4. For present provisions on attempt and conspiracy, see 35-41-5-1, 35-41-5-2.

9-4-1-129. [Repealed.]

Compiler's Notes. This section, prohibiting persons owning or controlling vehicles from directing or permitting drivers to operate their vehicles in a manner contrary to

law, was repealed by Acts 1978, P.L. 2, § 970. For provisions on aiding, inducing, or causing an offense, see 35-41-2-4.

9-4-1-130. [Repealed.]

Compiler's Notes. This section, concerning when person arrested must be taken immediately before a magistrate, was re-

pealed by Acts 1982, P.L. 6, § 11. For law on when person arrested must be taken immediately before the court, see 9-4-1-130.1.

9-4-1-130.1. When person arrested must be taken immediately before court. — Whenever a person is arrested for a misdemeanor under this title, the arrested person shall be immediately taken before a court within the county in which the offense charged is alleged to have been committed and that has jurisdiction of the offense and is nearest or most accessible to the place where the arrest is made, in any of the following cases:

- (1) When the person demands an immediate appearance before a court.
- (2) When the person is charged with an offense causing or contributing to an accident resulting in injury or death to any person.
- (3) When the person is charged with violating IC 9-11-2.

IOWA

- Legislation

Iowa

CHAPTER 318

HEDGES ALONG HIGHWAYS

Repealed by 67GA, ch 1108, §24

CHAPTER 319

OBSTRUCTIONS IN HIGHWAYS

- | | | | |
|-------|---|--------|---|
| 319.1 | Removal. | 319.9 | Injunction to restrain obstructions. |
| 319.2 | Fences and electric transmission poles. | 319.10 | Billboards and signs. |
| 319.3 | Notice. | 319.11 | Enforcement. |
| 319.4 | Refusal to remove. | 319.12 | Billboards, reflectors, and signs prohibited. |
| 319.5 | New lines. | 319.13 | Right and duty to remove. |
| 319.6 | Cost of removal — liability. | 319.14 | Permit required. |
| 319.7 | Duty of road officers. | 319.15 | Definition. |
| 319.8 | Nuisance. | | |

319.1 Removal.

The department and the board of supervisors shall cause all obstructions in highways, under their respective jurisdictions, to be removed.

[C51, §594; R60, §905; C73, §993; C97, §1560; S13, §1527-s17, 1560; C24, 27, 31, 35, 39, §4834; C46, 50, 54, 58, 62, 66, 71, 73, 75, 77, 79, 81, §319.1]

319.2 Fences and electric transmission poles.

Poles used for telephone, telegraph, or other transmission purposes, shall not be removed until notice, in writing, of not less than thirty days, has been given to the owner or company operating such lines, or in the event the owner or company has been unable to remove such poles within such thirty-day period due to storm or other act of God, then such poles shall not be removed until the owner or company shall have had a reasonable time thereafter to remove such poles, and in case of fences, notice in writing of not less than

thirty days has been given to the owner, occupant, or agent of the land enclosed by said fence, unless such poles or fences constitute an immediate and dangerous hazard to persons or property lawfully using the right of way.

[C51, §594; R60, §905; C73, §993; C97, §1560; S13, §1527-s17, 1560; C24, 27, 31, 35, 39, §4835; C46, 50, 54, 58, 62, 66, 71, 73, 75, 77, 79, 81, §319.2]

319.3 Notice.

Said notice shall, with reasonable certainty, specify the line to which such fences or poles shall be removed, and shall be served in the same manner that original notices are required to be served.

[S13, §1527-s17; C24, 27, 31, 35, 39, §4836; C46, 50, 54, 58, 62, 66, 71, 73, 75, 77, 79, 81, §319.3]

Manner of service, R.C.P. 45-56

319.4 Refusal to remove.

All such fences and poles shall, within the time named, be removed to such line on the highway as the state highway engineer or county engineer may designate, as the case may be. If there be no county engineer, the board of supervisors, in case of secondary roads, shall designate said line. If not so removed, the public authorities may forthwith remove them.

[S13, §1527; C24, 27, 31, 35, 39, §4837; C46, 50, 54, 58, 62, 66, 71, 73, 75, 77, 79, 81, §319.4]

319.5 New lines.

New lines, or parts of lines hereafter constructed, shall, in case of secondary roads, be located by the county engineer upon written application filed with the county auditor, and in case of primary roads, by the state highway engineer upon written application filed with the department, and shall thereafter be removable according to the provisions of this chapter. If there be no county engineer, the board of supervisors, in case of secondary roads, shall designate said location.

[S13, §1527-s17; C24, 27, 31, 35, 39, §4838; C46, 50, 54, 58, 62, 66, 71, 73, 75, 77, 79, 81, §319.5]

319.6 Cost of removal — liability.

Any removal made in compliance with the foregoing sections shall be at the expense of the owners of said fences or poles. All removals shall be without liability on the part of any officer ordering or effecting such removal.

[S13, §1527-s17; C24, 27, 31, 35, 39, §4839; C46, 50, 54, 58, 62, 66, 71, 73, 75, 77, 79, 81, §319.6]

319.7 Duty of road officers.

It shall be the duty of all officers responsible for the care of public highways, outside cities, to remove from the traveled portion and shoulders of the highways within their several jurisdictions, all open ditches, water breaks, and like obstructions, and to employ labor for this purpose in the same manner as for the repair of highways.

[S13, §1560-b, -e; C24, 27, 31, 35, 39, §4840; C46, 50, 54, 58, 62, 66, 71, 73, 75, 77, 79, 81, §319.7]

319.8 Nuisance.

Any person, partnership or corporation who makes, or causes to be made, any obstruction mentioned in section 319.7, in such traveled way, and any officer responsible for the care of such highway who knowingly fails to remove said obstructions, shall be deemed to have created a public nuisance and be punished accordingly.

[S13, §1560-a, -c; C24, 27, 31, 35, 39, §4841; C46, 50, 54, 58, 62, 66, 71, 73, 75, 77, 79, 81, §319.8]

Nuisances in general, ch 657

319.9 Injunction to restrain obstructions.

The department, and the board of supervisors may, as to roads under their respective jurisdictions, maintain suits in equity aided by injunction to restrain obstruction in such highways, and, in such actions, may cause the legal boundary lines of such highway to be adjudicated provided all interested parties are impleaded.

[C24, 27, 31, 35, 39, §4842; C46, 50, 54, 58, 62, 66, 71, 73, 75, 77, 79, 81, §319.9]

319.10 Billboards and signs.

Billboards and advertising signs, whether on public or private property, which so obstruct the view of any portion of a public highway or of a railway track as to render dangerous the use of a public highway are public nuisances and may be abated, and the person or persons responsible for the erection and maintenance may be punished, as provided in the chapter on nuisances.

[C24, 27, 31, 35, 39, §4844; C46, 50, 54, 58, 62, 66, 71, 73, 75, 77, 79, 81, §319.10]

Nuisances in general, ch 657

319.11 Enforcement.

Boards of supervisors and county attorneys as to secondary roads, and the department and the department general counsel as to primary roads, shall enforce section 319.10 by appropriate civil or criminal proceeding or by both such proceedings.

[C24, 27, 31, 35, 39, §4845; C46, 50, 54, 58, 62, 66, 71, 73, 75, 77, 79, 81, §319.11]

319.12 Billboards, reflectors, and signs prohibited.

No billboard, advertising sign or device, fence other than right of way boundary fence, or other obstruction except signs or devices authorized by law or approved by the highway authorities shall be placed or erected upon the right of way of any public highway, nor shall any vehicle be abandoned upon the right of way of any public highway.

Except for official traffic-control devices as defined by section 321.1, subsection 62, no person shall place, erect, or attach any red reflector, or any object or other device which shall cause a red reflectorized effect, within the boundary lines of the public highways so as to be visible to passing motorists.

[C24, 27, 31, 35, 39, §4846; C46, 50, 54, 58, 62, 66, 71, 73, 75, 77, 79, 81, §319.12]

319.13 Right and duty to remove.

If the following constitute an immediate and dangerous hazard, all billboards, advertising signs or devices, fences other than right of way boundary fences, or any temporary obstruction, including abandoned vehicles except signs or devices authorized by law or approved by the highway authorities, placed or erected upon the right of way of any public highway shall without notice or liability in damages be removable and the costs thereof assessed against:

1. The owner of any billboard, advertising sign or device so removed.
2. The vehicle owner in the case of abandoned vehicles.
3. The abutting property in the case of fences other than right of way line fences and other temporary obstructions placed by the owner of or tenant on said property.
4. The owner or person responsible for placement of all other obstructions.

Any such obstruction not constituting an immediate and dangerous hazard shall be removed without liability after forty-eight hour notice served in the same manner in which an original notice is served, or in writing by certified mail, or in any other manner reasonably calculated to apprise the person responsible for the obstruction that the obstruction will be removed at the expense of such person after the notice is given.

Such removal and assessment of cost in the case of primary roads shall be by the department and in the case of secondary roads by the board of supervisors.

Upon removal of the obstruction, the highway authority may immediately send a statement of the cost of removal to the person responsible for the obstruction. If within ten days after sending the statement the cost is not paid, the highway authority may institute proceeding in the district court system to collect the cost of removal.

[C24, 27, 31, 35, 39, §4847; C46, 50, 54, 58, 62, 66, 71, 73, 75, 77, 79, 81, §319.13]

319.14 Permit required.

A person shall not excavate, fill or make any physical change within the right of way of a public road or highway without obtaining a permit from the highway authority having jurisdiction of such public road or highway. Any work performed under the permit shall be performed in conformity with the specifications prescribed by the highway authority. If the excavation,

fill or physical change within the right of way of a public road or highway does not conform to the specifications that accompany the permit the person shall be notified to make such conforming changes. If after twenty days the changes have not been made, the public road or highway authority may make the necessary changes and immediately send a statement of the cost to the person responsible for the work done not in conformance to the specifications. If within ten days after sending the statement the cost is not paid, the highway authority may institute proceedings in the district court system to collect the cost of correction. Utility companies are exempt from the provisions of this section.

[C75, 77, 79, 81, §319.14]

319.15 Definition.

As used in this chapter, unless the context otherwise requires, "department" means the state department of transportation.

[C75, 77, 79, 81, §319.15]

321.356 Officers authorized to remove.

Whenever any peace officer finds a vehicle standing upon a highway in violation of any of the foregoing provisions of sections 321.354 and 321.355 such officer is hereby authorized to move such vehicle, or require the driver or other person in charge of the vehicle to move the same, to a position off the paved or improved or main traveled part of such highway.

[C39, §5030.03; C46, 50, 54, 58, 62, 66, 71, 73, 75, 77, 79, 81, §321.356]

321.357 Removed from bridge.

Whenever any peace officer finds a vehicle unattended upon any bridge or causeway or in any tunnel where such vehicle constitutes an obstruction to traffic, such officer is hereby authorized to provide for the removal of such vehicle to the nearest garage or other place of safety.

[C39, §5030.04; C46, 50, 54, 58, 62, 66, 71, 73, 75, 77, 79, 81, §321.357]

321.358 Stopping, standing or parking

No person shall stop, stand, or park a vehicle, except when necessary to avoid conflict with other traffic or in compliance with the directions of a police officer or traffic-control device, in any of the following places:

1. On a sidewalk, except a bicycle may stop, stand, or park on a sidewalk if not prohibited by a local jurisdiction.
2. In front of a public or private driveway.
3. Within an intersection.
4. Within five feet of a fire hydrant.
5. On a crosswalk.
6. Within ten feet upon the approach to any flashing beacon, stop sign, or traffic-control signal located at the side of a roadway.
7. Between a safety zone and the adjacent curb or within ten feet of points on the curb immediately opposite the ends of a safety zone, unless any city indicates a different length by signs or markings.
8. Within fifty feet of the nearest rail of a railroad crossing, except when parked parallel with such rail and not exhibiting a red light.
9. Within twenty feet of the driveway entrance to any fire station and on the side of a street opposite the entrance to any fire station within seventy-five feet of said entrance when properly signposted.
10. Alongside or opposite any street excavation or obstruction when such stopping, standing, or parking would obstruct traffic.
11. On the roadway side of any vehicle stopped or parked at the edge or curb of a street.
12. Upon any bridge or other elevated structure upon a highway outside of cities or within a highway tunnel.
13. At any place where official signs prohibit stopping or parking.
14. Upon any street within the corporate limits of a city when the same is prohibited by a general ordinance of uniform application relating to removal of snow or ice from the streets.

[S13, §1571-m18; C24, 27, 31, 35, §5057, 5058, 5060; C39, §5030.05; C46, 50, 54, 58, 62, 66, 71, 73, 75, 77, 79, 81, §321.358]

85 Acts, ch 40, §4

321.359 Moving other vehicle.

No person shall move a vehicle not owned by such person into any such prohibited area or away from a curb such distance as is unlawful.

[C39, §5030.06; C46, 50, 54, 58, 62, 66, 71, 73, 75, 77, 79, 81, §321.359]

321.360 Theaters, hotels and auditoriums.

A space of not to exceed fifty feet is hereby reserved at the side of the street in front of any theater, auditorium, hotel having more than twenty-five sleeping rooms, or other buildings where large assemblages of people are being held, within which space, when clearly marked as such, no motor vehicle shall be left standing, parked, or stopped except in taking on or discharging passengers or freight, and then only for such length of time as is necessary for such purpose.

[S13, §1571-m18; C24, 27, 31, 35, §5059; C39, §5030.07; C46, 50, 54, 58, 62, 66, 71, 73, 75, 77, 79, 81, §321.360]

321.361 Additional parking regulations.

Except as otherwise provided in this section every vehicle stopped or parked upon a roadway where there are adjacent curbs shall be so stopped or parked with the right-hand wheels of such vehicle parallel to and within eighteen inches of the right-hand curb.

Local authorities may by ordinance permit parking of vehicles with the left-hand wheels adjacent to and within eighteen inches of the left-hand curb of a one-way roadway.

Local authorities may by ordinance permit angle or center parking on any roadway under their jurisdiction.

[S13, §1571-m18; C24, 27, 31, 35, §4997, 5056; C39, §5030.08; C46, 50, 54, 58, 62, 66, 71, 73, 75, 77, 79, 81, §321.361]

MISCELLANEOUS RULES**321.362 Unattended motor vehicle.**

No person driving or in charge of a motor vehicle shall permit it to stand unattended without first stopping the engine, or when standing upon any perceptible grade without effectively setting the brake thereon and turning the front wheels to the curb or side of the highway.

[S13, §1571-m18; C24, 27, 31, 35, §5038; C39, §5031.01; C46, 50, 54, 58, 62, 66, 71, 73, 75, 77, 79, 81, §321.362]

321.363 Obstruction to driver's view.

No person shall drive a vehicle when it is so loaded, or when there are in the front seat such number of persons, exceeding three, as to obstruct the view of the driver to the front or sides of the vehicle or as to interfere with the driver's control over the driving mechanism of the vehicle.

No passenger in a vehicle shall ride in such position as to interfere with the driver's view ahead or to the sides, or to interfere with the driver's control over the driving mechanism of the vehicle.

[C39, §5031.02; C46, 50, 54, 58, 62, 66, 71, 73, 75, 77, 79, 81, §321.363]

321.364 Control of vehicle — signals.

The driver of a motor vehicle traveling through defiles or on approaching the crest of a hill or grade shall have such motor vehicle under control and on the right-hand side of the roadway and, upon approaching any curve where the view is obstructed within a distance of two hundred feet along the highway, shall give audible warning with the horn of such motor vehicle.

[S13, §1571-m18; C24, 27, 31, 35, §5031, 5043; C39, §5031.03; C46, 50, 54, 58, 62, 66, 71, 73, 75, 77, 79, 81, §321.364]

321.365 Coasting prohibited.

1. The driver of any motor vehicle when traveling upon a downgrade shall not coast with the gears of such vehicle in neutral.

2. The driver of a commercial motor vehicle when traveling upon a downgrade shall not coast with the clutch disengaged.

[C39, §5031.04, 5031.05; C46, 50, 54, 58, 62, §321.365, 321.366; C66, 71, 73, 75, 77, 79, 81, §321.365]

321.366 Acts prohibited on fully controlled-access facilities.

It is unlawful for a person, except a person operating highway maintenance equipment or an authorized emergency vehicle, to do any of the following on a fully controlled-access facility:

1. Drive a vehicle over, upon, or across a curb, central dividing section, or other separation or dividing line.

2. Make a left turn or a semicircular or U-turn at a maintenance cross-over where an official sign prohibits the turn.

3. Drive a vehicle except in the proper lane provided for that purpose and in the proper direction and to the right of the central dividing curb, separation, section, or line.

4. Drive a vehicle into the facility from a local service road.

5. Stop, park, or leave standing a vehicle, whether attended or unattended, upon the paved portion.

6. Stop, park, or leave standing a vehicle, whether attended or unattended, upon the shoulders, or the right of way except at designated rest areas or in case of an emergency or other dire necessity.

For the purpose of this section, fully controlled-access facility is a highway which gives preference to through traffic by providing access connections at interchanges with selected public roads only and by prohibiting crossings at grade or direct access at driveway connections.

Violations of this section are punishable as provided in section 321.482.

[C58, 62, §306A.9; C66, 71, 73, 75, 77, 79, 81, §321.366]

84 Acts, ch 1022, §8; 84 Acts, ch 1219, §27

321.367 Following fire apparatus.

The driver of any vehicle other than one on official business shall not follow any fire apparatus traveling in response to a fire alarm closer than five hundred feet or drive into or park such vehicle within the block where fire apparatus has stopped in answer to a fire alarm.

[C39, §5031.06; C46, 50, 54, 58, 62, 66, 71, 73, 75, 77, 79, 81, §321.367]

321.368 Crossing fire hose.

No vehicle shall be driven over any unprotected hose of a fire department when laid down on any street, private driveway, or streetcar track, to be used at any fire or alarm of fire, without the consent of the fire department official in command.

[C39, §5031.07; C46, 50, 54, 58, 62, 66, 71, 73, 75, 77, 79, 81, §321.368]

321.369 Putting debris on highway.

No person shall throw or deposit upon any highway any glass bottle, glass, nails, tacks, wire, cans, trash, garbage, rubbish, litter, offal, or any other debris. No substance likely to injure any person, animal or vehicle upon such highway shall be thrown or deposited by any person upon any highway. Any person who violates any provision of this section or section 321.370 shall be guilty of a misdemeanor and upon arrest and conviction therefor shall be punished as provided in section 321.482.

[S13, §4808-a, -b; C24, 27, 31, 35, §13118; C39, §5031.08; C46, 50, 54, 58, 62, 66, 71, 73, 75, 77, 79, 81, §321.369]

See §455B.363

321.370 Removing injurious material.

Any person who drops, or permits to be dropped or thrown, upon any highway any destructive or injurious material and other material as defined in section 321.369 shall immediately remove the same or cause it to be removed.

[C39, §5031.09; C46, 50, 54, 58, 62, 66, 71, 73, 75, 77, 79, 81, §321.370]

321.371 Clearing up wrecks.

Any person removing a wrecked or damaged vehicle from a highway shall remove any glass or other injurious substance dropped upon the highway from such vehicle.

[C39, §5031.10; C46, 50, 54, 58, 62, 66, 71, 73, 75, 77, 79, 81, §321.371]

SCHOOL BUSES**321.372 Discharging pupils — regulations.**

1. The driver of a school bus used to transport children to and from a public or private school shall, when stopping to receive or discharge pupils, turn on flashing warning lamps at a distance of not less than three hundred feet nor more than five hundred feet from the point where the pupils are to be received or discharged from the bus. At the point of receiving or discharging pupils the driver of the bus shall bring the bus to a stop, turn off the amber flashing warning lamps, turn on the red flashing warning lamps, and extend the stop arm. After receiving or discharging pupils, the bus driver shall turn off all flashing warning lamps, retract the stop arm and proceed on the route. Except to the extent that reduced visibility is caused by fog, snow or other weather conditions, a school bus shall not stop to receive or discharge pupils unless there is at least three hundred feet of unobstructed vision in each direction. However, the driver of a school bus is not required to use flashing warning lamps and the stop arm when receiving or discharging

or moving of such vehicle, object, or contrivance, or as a result of operation, driving, or moving any vehicle, object, or contrivance weighing in excess of the maximum weight in this chapter but authorized by a special permit issued as provided in this chapter.

Whenever such driver is not the owner of such vehicle, object, or contrivance, but is so operating, driving, or moving the same with the express or implied permission of said owner, then said owner and driver shall be jointly and severally liable for any such damage. Such damage may be recovered in a civil action brought by the authorities in control of such highway or highway structure.

[C39, §5035.24; C46, 50, 54, 58, 62, 66, 71, 73, 75, 77, 79, 81, §321.475]

321.476 Weighing vehicles by department.

Authority is hereby given to the department to stop any motor vehicle or trailer on the highways for the purposes of weighing and inspection, to weigh and inspect the same and to enforce the provisions of the motor vehicle laws relating to the registration, size, weight, and load of motor vehicles and trailers.

Authority is also hereby granted to subject to weighing and inspection, vehicles which have moved from a highway onto private property under circumstances which indicate that the load of the vehicle, if any, is substantially the same as the load which the vehicle carried before moving onto the private property.

Any person who prevents or in any manner obstructs an officer attempting to carry out the provisions of this section is guilty of a simple misdemeanor.

[C46, 50, 54, 58, 62, 66, 71, 73, 75, 77, 79, 81, §321.476]

321.477 Employees as peace officers.

The department may designate by resolution certain of its employees upon each of whom there is hereby conferred the authority of a peace officer to control and direct traffic and weigh vehicles, and to make arrests for violations of the motor vehicle laws relating to the operating authority, registration, size, weight, and load of motor vehicles and trailers and registration of a motor carrier's interstate transportation service with the department.

[C46, 50, 54, 58, 62, 66, 71, 73, 75, 77, 79, 81, §321.477]

321.478 Bond.

Prior to entering upon the discharge of the employee's duties as such peace officer, each of said designated employees shall furnish to the department a surety bond to the state in the sum of five hundred dollars, conditioned upon the faithful discharge of the peace officer's duties.

[C46, 50, 54, 58, 62, 66, 71, 73, 75, 77, 79, 81, §321.478]

321.479 Badge of authority.

The department shall supply each of said employees so designated with a badge of authority, bearing a serial number, which shall be conspicuously displayed by the employee while in the performance of the employee's duties as such peace officer.

[C46, 50, 54, 58, 62, 66, 71, 73, 75, 77, 79, 81, §321.479]

321.480 Limitation on expense.

For the purposes of sections 321.476 to 321.481 and the enforcement of the provisions of the motor vehicle laws relating to the size, weight, and load of motor vehicles and trailers the department is hereby authorized to expend from the primary road fund only the amount appropriated for each biennium.

[C46, 50, 54, 58, 62, 66, 71, 73, 75, 77, 79, 81, §321.480]

321.481 No impairment of other authority.

Nothing in sections 321.476 to 321.480 shall be so construed as to limit or impair the authority or duties of other peace officers in the enforcement of the motor vehicle laws or any portion thereof.

[C46, 50, 54, 58, 62, 66, 71, 73, 75, 77, 79, 81, §321.481]

CRIMINAL RESPONSIBILITY

321.482 Violations — simple misdemeanors unless otherwise provided.

It is a simple misdemeanor for a person to do an act forbidden or to fail to perform an act required by this chapter unless the violation is by this chapter or other law of this state declared to be a serious or aggravated misdemeanor or a felony. Chapter 232 has no application in the prosecution of offenses committed in violation of this chapter which are simple misdemeanors.

[S13, §1569, 1571-2a, -m21, -m22, -m26, -m27, -m29, 4808-b; SS15, §1571-m12a; C24, §4903, 5081, 5089, 13119; C27, §4903, 5055-b4, 5081, 5089, 13119; C31, §4686-c2, 4903, 5055-b4, 5079-d6, 5081, 5089, 13119; C35, §4686-c2, 4903, 4991-f5, 5024-e3, 5055-b4, 5067-e2, 5079-d6, 5081, 5089, 13119; C39, §5036.01; C46, 50, 54, 58, 62, 66, 71, 73, 75, 77, 79, 81, §321.482]

84 Acts, ch 1067, §33

321.483 Penalty for class "D" felony.

Any person who is convicted of a violation of any of the provisions of this chapter herein declared to constitute a felony, and for which another punishment is not otherwise provided, shall be guilty of a class "D" felony.

[C24, 27, 31, 35, §5081; C39, §5036.02; C46, 50, 54, 58, 62, 66, 71, 73, 75, 77, 79, 81, §321.483]

321.484 Offenses by owners.

It is unlawful for the owner, or any other person, employing or otherwise directing the driver of any vehicle to require or knowingly to permit the operation of such vehicle upon a highway in any manner contrary to law.

The owner of a vehicle shall not be held responsible for a violation of a provision regulating the stopping, standing or parking of a vehicle, whether the provision is contained in this chapter, or chapter 601E, or an ordinance or other regulation or rule, if the owner establishes that at the time of the violation the vehicle was in the custody of an identified person other than the owner pursuant to a lease as defined in chapter 321F. The furnishing to the clerk of court where the charge is pending of a copy of the certificate of responsibility prescribed by section 321F.6 that was in effect for the vehicle at the time of the alleged violation shall

KANSAS

- Legislation
- Exam



KANSAS

ACT REGULATING TRAFFIC; RULES OF THE ROAD

8-1542

Pedestrians shall move, whenever practicable, upon the right half of crosswalks.

History: L. 1974, ch. 33, § 8-1536; July 1.

Source or prior law:
8-558.

Research and Practice Aids:
Uniform Vehicle Code, § 11-505.
Automobiles ~~160~~(4).
C.J.S. Motor Vehicles § 382 et seq.

8-1537. Same; use of roadways. (a) Where a sidewalk is provided and its use is practicable, it shall be unlawful for any pedestrian to walk along and upon an adjacent roadway.

(b) Where a sidewalk is not available, any pedestrian walking along and upon a highway shall walk only on a shoulder, as far as practicable from the edge of the roadway.

(c) Where neither a sidewalk nor a shoulder is available, any pedestrian walking along and upon a highway shall walk as near as practicable to an outside edge of the roadway, and, if on a two-way roadway, shall walk only on the left side of the roadway.

(d) Except as otherwise provided in this article, any pedestrian upon a roadway shall yield the right-of-way to all vehicles upon the roadway.

History: L. 1974, ch. 33, § 8-1537; July 1.

Source or prior law:
8-557a (a), (b).

Research and Practice Aids:
Uniform Vehicle Code, § 11-506.
Automobiles ~~160~~(5).
C.J.S. Motor Vehicles § 382 et seq.

CASE ANNOTATIONS

1. Statute not in effect on date of accident and no comparable statute then in effect; damage award affirmed. *Chance v. Scroggins*, 3 K.A.2d 11, 13, 588 P.2d 479.

8-1538. Same; soliciting rides or business. (a) No person shall stand in a roadway for the purpose of soliciting a ride.

(b) No person shall stand on a highway for the purpose of soliciting employment, business or contributions from the occupant of any vehicle.

(c) No person shall stand on or in proximity to a street or highway for the purpose of soliciting the watching or guarding of any vehicle while parked or about to be parked on a street or highway.

History: L. 1974, ch. 33, § 8-1538; July 1.

Source or prior law:
8-557b.

Research and Practice Aids:
Uniform Vehicle Code, § 11-507.
Automobiles ~~160~~(1).
C.J.S. Motor Vehicles § 382 et seq.

8-1539. Driving through safety zone prohibited. No vehicle shall at any time be driven through or within a safety zone.

History: L. 1974, ch. 33, § 8-1539; July 1.

Source or prior law:
8-563.

Research and Practice Aids:
Uniform Vehicle Code, § 11-508.
Automobiles ~~160~~(1).
C.J.S. Motor Vehicles § 382 et seq.

8-1540. Pedestrians' right-of-way on sidewalks. The driver of a vehicle shall yield the right-of-way to any pedestrian on a sidewalk.

History: L. 1974, ch. 33, § 8-1540; July 1.

Research and Practice Aids:
Uniform Vehicle Code, § 11-509.
Automobiles ~~160~~(6).
C.J.S. Motor Vehicles § 389.

8-1541. Pedestrians must yield right-of-way to authorized emergency vehicle. (a) Upon the immediate approach of an authorized emergency vehicle making use of an audible signal meeting the requirements of subsection (d) of K.S.A. 8-1738 and visual signals meeting the requirements of K.S.A. 8-1720, or of a police vehicle properly and lawfully making use of an audible signal only, every pedestrian shall yield the right-of-way to the authorized emergency vehicle.

(b) This section shall not relieve the driver of an authorized emergency vehicle from the duty to drive with due regard for the safety of all persons using the highway nor from the duty to exercise due care to avoid colliding with any pedestrian.

History: L. 1974, ch. 33, § 8-1541; July 1.

Research and Practice Aids:
Uniform Vehicle Code, § 11-510.
Automobiles ~~175~~.
C.J.S. Motor Vehicles § 371 et seq.

8-1542. Blind pedestrian's right-of-way. The driver of a vehicle shall yield the right-of-way to any blind pedestrian carry-

AUTOMOBILES AND OTHER VEHICLES

the license is suspended, the division of vehicles shall issue an appropriate license to the person whose license had been suspended, upon successful completion of the examination required by K.S.A. 8-241 and amendments thereto and upon proper application and payment of the required fee unless the child's driving privileges have been revoked, suspended or cancelled for another cause and the revocation, suspension or cancellation has not expired.

(b) Instead of suspending a driver's license pursuant to this section, the court may place restrictions on the child's driver's privileges pursuant to K.S.A. 1985 Supp. 8-292 and amendments thereto.

(c) As used in this section, "traffic offense" means a violation of the uniform act regulating traffic on highways or a violation of a city ordinance or county resolution which relates to the regulation of traffic on the roads, highways or streets or the operation of self-propelled or nonself-propelled vehicles of any kind.

History: L. 1978, ch. 158, § 34; L. 1981, ch. 183, § 1; L. 1982, ch. 182, § 118; L. 1983, ch. 140, § 1; L. 1986, ch. 161, § 7; July 1.

Cross References to Related Sections:

Traffic offenders under 10, see 38-1501 *et seq.*
 Traffic offenders 10 through 13, see 38-1601 *et seq.*

Law Review and Bar Journal References:

"Survey of Kansas Law: Juvenile Law," Sheila Reynolds, 32 K.L.R. 371, 392 (1984).

8-2113. Uniform fine schedule for traffic infraction violations; payment by mail with plea, when; full payment required; ordinance traffic infractions. (a) A person charged with a traffic infraction shall, except as provided in subsection (b), appear at the place and time specified in the notice to appear. If the person enters an appearance, waives right to trial, pleads guilty or no contest, the fine shall be no greater than that specified in the uniform fine schedule in subsection (c) and court costs shall be taxed as provided by law.

(b) Prior to the time specified in the notice to appear, a person charged with a traffic infraction may enter a written appearance, waive right to trial, plead guilty or no contest and pay the fine for the violation as specified in the uniform fine schedule in subsection (c) and court costs provided by law. Payment may be made by mail or in person and may be by personal check. The

traffic citation shall not have been complied with if a check is not honored for any reason, or if the fine and court costs are not paid in full. When a person charged with a traffic infraction makes payment without executing a written waiver of right to trial and plea of guilty or no contest, the payment shall be deemed such an appearance, waiver of right to trial and plea of no contest.

(c) The following uniform fine schedule shall apply uniformly throughout the state but shall not limit the fine which may be imposed following a court appearance, except an appearance made for the purpose of pleading and payment as permitted by subsection (a). The description of offense contained in the following uniform fine schedule is for reference only and is not a legal definition.

Description of Offense	Statute	Fine
Refusal to submit to a preliminary breath test	8-1012	\$30
Unsafe speed for prevailing conditions	8-1335 or 8-1557	\$20
Exceeding maximum speed limit; or speeding in zone posted by the state department of transportation; or speeding in locally posted zone	8-1336 to 8-1338 or 8-1558 to 8-1560	1-10 mph over the limit, \$10; 11-20 mph over the limit, \$10 plus \$2 per mph over 10 mph over the limit; 21-30 mph over the limit, \$30 plus \$3 per mph over 20 mph over the limit; 31 and more mph over the limit, \$60 plus \$5 per mph over 30 mph over the limit;
Disobeying traffic control device	8-1507	\$20
Violating traffic control signal	8-1508	\$20
Violating pedestrian control signal	8-1509	\$10
Violating flashing traffic signals	8-1510	\$20
Violating lane-control signal	8-1511	\$20
Unauthorized sign, signal, marking or device	8-1512	\$10
Driving on left side of roadway	8-1514	\$20
Failure to keep right to pass oncoming vehicle	8-1515	\$20
Improper passing; increasing speed when passed	8-1516	\$20
Improper passing on right	8-1517	\$20

ACT REGULATING TRAFFIC; ARRESTS, CITATIONS, PENALTIES

8-2118

Passing on left with insufficient clearance	8-1518	\$20	Failure to yield to blind pedestrian	8-1542	\$10
Driving on left side where curve, grade, intersection railroad crossing, or obstructed view	8-1519	\$20	Pedestrian disobeying bridge or railroad signal	8-1544	\$10
Driving on left in no-passing zone	8-1520	\$20	Improper turn or approach	8-1545	\$20
Driving wrong direction on one-way road	8-1521	\$20	Improper "U" turn	8-1546	\$20
Improper driving on laned roadway	8-1522	\$20	Unsafe starting of stopped vehicle	8-1547	\$10
Following too close	8-1523	\$20	Unsafe turning or stopping, failure to give proper signal; using turn signal unlawfully	8-1548	\$20
Improper crossover on divided highway	8-1524	\$10	Improper method of giving notice of intention to turn	8-1549	\$10
Failure to yield right-of-way at uncontrolled intersection	8-1526	\$20	Improper hand signal	8-1550	\$10
Failure to yield to approaching vehicle when turning left	8-1527	\$20	Failure to stop or obey railroad crossing signal	8-1551	\$30
Failure to yield at stop or yield sign	8-1528	\$20	Failure to stop at railroad crossing stop sign	8-1552	\$20
Failure to yield from private road or driveway	8-1529	\$20	Certain hazardous vehicles failure to stop at railroad crossing	8-1553	\$30
Failure to yield to emergency vehicle	8-1530	\$30	Improper moving of heavy equipment at railroad crossing	8-1554	\$10
Failure to yield to pedestrian or vehicle working on roadway	8-1531	\$10	Vehicle emerging from alley, private roadway, building or driveway	8-1555	\$20
Disobeying pedestrian traffic control device	8-1532	\$10	Improper passing of school bus; improper use of school bus signals	8-1556	\$30
Failure to yield to pedestrian in crosswalk; pedestrian suddenly entering roadway; passing vehicle stopped for pedestrian at crosswalk	8-1533	\$20	Improper passing of church or day-care bus; improper use of signals	8-1556a	\$30
Improper pedestrian crossing	8-1534	\$10	Impeding normal traffic by slow speed	8-1561	\$10
Failure to exercise due care in regard to pedestrian	8-1535	\$10	Speeding on motor-driven cycle	8-1562	\$20
Improper pedestrian movement in crosswalk	8-1536	\$10	Speeding in certain vehicles or on posted bridge	8-1563	\$10
Improper use of roadway by pedestrian	8-1537	\$10	Improper stopping, standing or parking on roadway	8-1569	\$10
Soliciting ride or business on roadway	8-1538	\$10	Parking, standing or stopping in prohibited area	8-1571	\$10
Driving through safety zone	8-1539	\$10	Improper parking	8-1572	\$10
Failure to yield to pedestrian on sidewalk	8-1540	\$10	Unattended vehicle	8-1573	\$10
Failure of pedestrian to yield to emergency vehicle	8-1541	\$10	Improper backing	8-1574	\$10
			Driving on sidewalk	8-1575	\$10
			Driving with view or driving mechanism obstructed	8-1576	\$10
			Unsafe opening of vehicle door	8-1577	\$10
			Riding in house trailer	8-1578	\$10

owned property to special assessments. *State Highway Commission v. City of Topeka*, 193 K. 335, 336, 393 P.2d 1008.

28. Subsection (a) merely designates various interests which highway commission may acquire by purchase, dedication or eminent domain, but does not prescribe procedure for exercising right of eminent domain. *State Highway Commission v. Moore*, 204 K. 502, 503, 504, 464 P.2d 188.

29. Extensive review of condemnation law; school district may acquire fee title to property by condemnation (dissenting opinion). Board of Education of U.S.D. 512 v. *Vic Regnier Builders, Inc.*, 231 K. 731, 750, 648 P.2d 1143 (1982).

68-413a. Same; conveyance of title to oil and gas in place to present landowners; exceptions. The state of Kansas does herewith and hereby convey all right, title and interest in and to all oil and gas in place, in and under any and all right-of-way, heretofore obtained in the name of the state highway commission of the state of Kansas, by purchase, dedication or condemnation for state highway purposes as authorized by K.S.A. 68-413, and acquired pursuant to article 1, chapter 26 of the Kansas Statutes Annotated, which have not otherwise been disposed of as provided by law, to the present owners of the land of which it was originally a part, save and except a right-of-way easement for highway purposes for all such lands, and an easement right to water, gravel, stone, sand or other material, or to spoil banks or borrow pits, or any bed, pit, quarry or other places where gravel, stone, water or other material may be located, which is now in possession of or has been acquired by the state of Kansas for construction, improvement, reconstruction, maintenance, or drainage of the state highway: *Provided, however*, That where the state of Kansas or the state highway commission has heretofore acquired title to real estate by warranty deed for any highway purpose or by purchase, dedication or condemnation for sites for the construction of buildings or any improvement thereon necessarily incident to the operation, maintenance and supervision of a system of state highways, the fee simple title, from and after the effective date of this act, shall be and remain vested in the state of Kansas.

History: L. 1951, ch. 382, § 1; L. 1975, ch. 426, § 55; Aug. 15.

Research and Practice Aids:

Highways—95(1).

C.J.S. Highways § 157 et seq.

CASE ANNOTATIONS

1. Mentioned in determining title ordinarily ac-

quired by condemnation. *Sutton v. Frazier*, 183 K. 33, 42, 43, 325 P.2d 338.

2. State acquires only an easement; landowner retains all other interests in lands. *Riddle v. State Highway Commission*, 184 K. 603, 629, 339 P.2d 301.

3. Existing highway; right of access, taking, measure of damages, regulation, etc.; statutes construed. *Smith v. State Highway Commission*, 185 K. 445, 456, 346 P.2d 259.

4. Extensive review of condemnation law; school district may acquire fee title to property by condemnation (dissenting opinion). Board of Education of U.S.D. 512 v. *Vic Regnier Builders, Inc.*, 231 K. 731, 750, 648 P.2d 1143 (1982).

68-413b. Rights-of-way of state highways to be used exclusively for public highway purposes, exception; removal of unauthorized structures or objects; public utility and other legal rights not affected. All rights-of-way of state highways shall be used exclusively for public highway purposes: *Provided*, The secretary of transportation may authorize such other uses of such rights-of-way as will not interfere with public travel thereon and which are in conformity with applicable state and federal laws, rules and regulations relating to highways. The secretary of transportation is authorized to remove unauthorized structures, objects and facilities which are located upon the rights-of-way of state highways. Nothing herein shall be construed to affect the rights of public utilities and persons or associations maintaining facilities on state highway rights-of-way pursuant to law.

History: L. 1963, ch. 332, § 1; L. 1975, ch. 427, § 98; Aug. 15.

Research and Practice Aids:

Highways—165.

C.J.S. Highways § 232; Motor Vehicles § 571.

68-414. Improvement of railroad crossings on state highway system; division of cost; safety devices or signals. The secretary of transportation, in the construction, improvement, reconstruction or maintenance of the state highway system, shall have the power and authority to compel all railroad companies operating steam or electric railroads in this state to construct, improve, reconstruct or maintain in a manner to be approved by the secretary of transportation, viaducts, tunnels, underpasses, bridges or grade crossings where the lines of said railroad companies intersect state highways, when in the judgment of the secretary such viaducts, tunnels, underpasses, bridges or grade crossings are necessary for the proper construction of the state highway

laws of this state, the contractor shall not be liable for damages arising out of design defects involving the construction of such highway or turnpike resulting in injury to persons or damage to property, occurring after completion of the contract, and acceptance thereof by such public officer, if the contractor has complied with all contractual provisions and specifications imposed by state and federal agencies with respect to such highway or turnpike. Nothing contained in this section shall be construed as abrogating, limiting or otherwise affecting any cause of action accruing to the state or any agency or instrumentality thereof which was a party to such contract.

History: L. 1974, ch. 269, § 1; July 1.

Cross References to Related Sections:

Turnpike projects, see 68-2002, 68-2030, 68-2052, 68-2071, 68-2094.

68-420. Validity of act. If any section, clause, sentence, paragraph, part or provision of this act shall be found invalid by any court, it shall be conclusively presumed that this act would have been passed by the legislature without such invalid section, clause, sentence, paragraph, part or provision, and the act as a whole shall not be declared invalid by reason of the fact that one or more sections, clauses, sentences, paragraphs, parts or provisions may be found invalid by any court.

History: L. 1927, ch. 255, § 13; L. 1929, ch. 225, § 20; April 1.

Source or prior law:

L. 1925, ch. 214, § 8.

Research and Practice Aids:

Statutes=64(5).

C.J.S. Statutes § 102.

68-421. Construction of act. In administering and carrying out the provisions of this act, the secretary of transportation shall be governed by the highway laws of the state so far as possible, and for the purpose of administration of this act all Kansas statutes referring to roads not in conflict with the act shall also apply to state highways.

History: L. 1927, ch. 255, § 12; L. 1929, ch. 225, § 21; L. 1975, ch. 427, § 105; Aug. 15.

Source or prior law:

68-610; L. 1925, ch. 214, § 7.

CASE ANNOTATIONS

1. Act of 1927 applies only to funds distributed under it. State, *ex rel.*, v. State Highway Comm., 138 K. 294, 26 P.2d 606.

2. Use of county tax funds on highways under 1925 and 1927 acts held not unlawful diversion. State, *ex rel.*, v. State Highway Comm., 139 K. 858, 33 P.2d 324.

68-421a.

History: L. 1929, ch. 229, § 1; Repealed, L. 1935, ch. 248, § 1; March 19.

CASE ANNOTATIONS

1. Act is unconstitutional and void. State, *ex rel.*, v. Saline County Comm'rs, 128 K. 437, 278 P. 54.

2. Cited in upholding 68-417. State, *ex rel.*, v. State Highway Comm., 130 K. 456, 462, 286 P. 244.

3. Cited in holding county reimbursement act for funds in closed banks unconstitutional. State, *ex rel.*, v. Crawford Township, 139 K. 553, 558, 32 P.2d 809.

4. Cited in discussing statutory evolution of state highway system. State, *ex rel.*, v. State Highway Comm., 139 K. 858, 862, 33 P.2d 324.

68-422. Erection of signs and markers.

The secretary of transportation is authorized to adopt and erect uniform marking guides and warning signs for identifying various routes on the state highway system. The secretary is authorized to remove any and all billboards or signs located within the limits of the right-of-way of state highways which bear advertising of any kind or character.

History: L. 1927, ch. 257, § 1; L. 1975, ch. 427, § 106; Aug. 15.

Cross References to Related Sections:

Naming and marking of highways, see ch. 68, art. 10.

68-422a. Erection of signs; unlawful acts. The secretary of transportation, the board of county commissioners of each county and the governing body of each incorporated city shall cause signs to be erected at suitable intervals on public highways in their respective areas of authority, including public parks, informing the public that littering, as defined by K.S.A. 21-3722, is unlawful.

History: L. 1967, ch. 195, § 3; L. 1975, ch. 427, § 107; Aug. 15.

68-422b. Designation of metric system on certain highway signs and markers. Whenever the secretary of transportation or Kansas turnpike authority shall cause to be manufactured any sign or marker which indicates mileage or distance to destination points, such sign or marker shall be manufactured so that, in addition to the requirements imposed by K.S.A. 8-2003, such mileage or distance also shall be designated in accordance with the metric system. The provisions of this section shall apply only in the event a demonstration project concern-

68-544. Tunnels under roads by landowners; approval; costs. Any person owning land on both sides of the public road may at his own expense tunnel under such road from one side to the other, but he shall construct such tunnel so as not to endanger the public in the use of said road. Before constructing the said tunnel the landowner shall obtain from the officials in charge of such road and county engineer their approval of the place, the kind of tunnel, and the manner of constructing the same. The officials in charge of such road shall cause the necessary repairs to be made on said bridge or tunnel at the expense of the owner: *Provided*, That if a bridge or culvert is a necessary structure at the place where the owner desires such tunnel, the owner shall pay only the difference between the necessary cost of such structure and the cost of making it suitable for the passage of livestock under the roadway, such difference in cost to be ascertained and fixed by the county engineer. The actual cost of such repairs if not promptly paid by the owner of such land shall be certified by the county engineer to the county clerk, who shall enter the same upon the tax roll in a separate column as a tax charge against such land and the same shall be collected as other taxes are collected, and when collected shall be credited to the county road fund if a county road and to the proper township road fund if a township road.

History: L. 1917, ch. 264, § 51; March 7; R.S. 1923, 68-544.

68-545. Unlawful obstructions, excavations, removal of materials, dumping trash or other materials or plowing of roads; penalty; payment of cost to restore. It shall be unlawful for any person or persons to obstruct any portion of a public highway, including any portion of the entire right-of-way, in any manner with intent to prevent the free use thereof, or to make any holes therein, or to remove any earth, gravel or rock therefrom or any part thereof, or in any manner to obstruct any ditch on the side of any such highway and thereby damage the same, to dump trash, debris, sewage, or any other material, on any highway or any ditch on the side of any highway, or to plow any public highway for the purpose of scouring plows, or for any other purpose except for the improvement of such highway and as directed in writing by the county engineer

and the township board of highway commissioners acting jointly. Any person or persons violating the provisions of this section shall be guilty of a misdemeanor, and upon conviction before any court having competent jurisdiction shall be fined for each and every offense under this act in the sum of not more than \$200, and shall pay costs of the action and the cost of cleaning the public highway and restoring it to its prior condition.

History: L. 1917, ch. 264, § 52; R.S. 1923, 68-545; L. 1951, ch. 386, § 1; L. 1961, ch. 305, § 1; L. 1984, ch. 254, § 1; July 1.

Source or prior law:

L. 1883, ch. 150, § 2.

Cross References to Related Sections:

Littering, see 21-3722.

Research and Practice Aids:

Highways—153.

C.J.S. Highways § 217 et seq.

CASE ANNOTATIONS

1. Locality and legality immaterial in criminal prosecution for obstruction. *State v. Hayes*, 125 K. 375, 379, 263 P. 782.

68-546.

History: L. 1917, ch. 264, § 53; R.S. 1923, 68-546; Repealed, L. 1969, ch. 180, § 21-4701; July 1, 1970.

Source or prior law:

L. 1883, ch. 150, § 1.

Revisor's Note:

New act, see 21-3722.

CASE ANNOTATIONS

1. County may lawfully improve road at township expense when township refuses. *Stock Farm Co. v. Pottawatomie County*, 116 K. 315, 316, 226 P. 781.

2. Cited in holding defendant oil company liable for destruction of bridge. *State Highway Comm. v. Empire Oil & Gas Co.*, 141 K. 161, 167, 40 P.2d 355.

68-547. Highways subject to act[*].

The provisions of this act[*] shall not apply to the construction and maintenance of streets and highways within the corporate limits of cities, but shall apply to all other roads and highways in this state, except as provided in K.S.A. 68-506.

History: L. 1917, ch. 264, § 54; L. 1921, ch. 219, § 2; March 23; R.S. 1923, 68-547.

* For location of sections of L. 1917, ch. 264, see Comparative Table of Sections in Constitutions Volume.

CASE ANNOTATIONS

1. State highway commission not liable for cost of improvement within city. *State, ex rel., v. State Highway Comm.*, 137 K. 800, 801, 22 P.2d 969.

White—Recipient
Yellow—Maintenance Hdqtrs.
Pink—District
Blue—Area
Green—Right-of-Way (Illegal signs only)

KANSAS DEPARTMENT OF TRANSPORTATION

NOTICE TO ABATE ENCROACHMENT
OR UNAUTHORIZED FACILITY OR PRACTICE

TO:

Notice is hereby given you that the following encroachment or unauthorized facility or practice, believed to be yours, located within the limits of or adjacent to the right-of-way of Highway No. _____, a State Highway, at a point about _____ at Mile Post _____, _____ County, Kansas, is to be discontinued and/or removed or brought into compliance with the provisions of K. S. A. 68-2231 et seq. on or before the _____ day of _____, 19____.
(Month)

- Destruction of sod, plants or shrubs thereon by farming practices.
- Pasturing of livestock.
- Erection of electric fence.
- Burning of right-of-way.
- Excavation on right-of-way without authority from Kansas Department of Transportation.
- Erection of billboard or sign advertising _____.
- Other (Describe) _____

This notice is given pursuant to K. S. A. 68-413b, 68-422, 68-545 and 68-2231 et seq., Laws of the State of Kansas and the rules and regulations of The Department of Transportation, and all amendments thereto, this _____ day of _____, 19____.

THE KANSAS DEPARTMENT OF TRANSPORTATION

By _____

Title _____

Address _____



MAINE

- Legislation



L A W S F O R M A I N E

TITLE 23

appropriation made for the pertinent biennium. Any appropriation so made which shall be expended under the direction of the Department of Transportation shall apply to projects in said interstate system for which contracts are signed prior to June 30th of the 2nd year of said biennium and to the extent of such contracts shall be carried forward and not lapse.

CHAPTER 7

CONTROLLED ACCESS HIGHWAYS

Sec.

301. Definition.

302. Use.

303. Easements of access.

304. Commercial enterprises prohibited.

305. Signs showing service facilities.

306. Application of provisions.

307. Powers as supplementary and additional.

§ 301. Definition

A controlled access highway is a highway on which, in the interest of safety and efficiency of operation, abutting property owners have no right of direct access and on which the type and location of all access connections are determined and controlled by the Department of Transportation.

§ 302. Use

The Department of Transportation shall have full power and authority to lay out, establish, acquire, open, construct, improve, maintain, discontinue and regulate the use of controlled access highways within this State in the same manner or manners in which said Department of Transportation may now lay out, establish, acquire, open, construct, improve, maintain, discontinue and regulate the use of highways within the State. The Department of Transportation shall have any and all other additional authority and power relative to such controlled access highways as they now respectively possess relative to highways, including the authority and power to acquire or accept title to the lands or rights of way needed for the same.

In connection with the laying out and establishment of a controlled access highway the Department of Transportation may take in fee or lesser estate, by purchase, gift, devise or by eminent domain under chapters 1 to 19, part or all of any part of land adjoining the highway location which, by reason of such laying out and establishment of a controlled access highway, has been severed from legal access to any public highway.

§ 303. Easements of access

Where an existing highway has been designated as, or included within, a controlled access highway by said Department of Transportation, existing easements of access may be so extinguished by purchase or by taking under eminent domain, in accordance with any existing method now exercised by said

TITLE 23

Department of Transportation in purchasing or taking land for highway purposes. Access to such controlled access highway from any existing highway, road or street may be regulated and restricted by the Department of Transportation. Access to any such controlled access highway from any new highway, road or street shall be subject to the consent and approval of the Department of Transportation.

§ 304. Commercial enterprises prohibited

No commercial enterprise or activity shall be authorized or conducted by the Department of Transportation or any agency or officer of the State within or on the property or right-of-way acquired for any controlled access highway under this chapter, except that the Department of Transportation may permit the erection or installation of electric power, telegraph, telephone or pipeline facilities within the controlled area.

§ 305. Signs showing service facilities

The location of service, fuel and recreational facilities may be indicated to the users of any controlled access highway by appropriate signs erected within the right-of-way, at or near the junction of such access roads as may be provided. The size, style, specifications and location of such signs shall be determined by the Department of Transportation.

§ 306. Application of provisions

This chapter shall not apply to highways other than those in the state highway system as designated by the Department of Transportation nor to those in the compact or built up areas of any city or town as defined in Title 29, section 1252, except with the approval of the municipal officers of the city or town wherein such compact or built up area is situated.

§ 307. Powers as supplementary and additional

This chapter shall be considered supplementary and in addition to any and all other powers now exercised by the Department of Transportation.

CHAPTER 9

BRIDGES

Subch.		Sec.
I.	General Provisions	351
II.	State Highway Bridges	401
III.	State Aid and 3rd Class Road Bridges	451
IV.	International and Interstate Bridges	501
V.	Covered Bridges	601

SUBCHAPTER 1

GENERAL PROVISIONS

Sec.	
351.	Definition of state highway.

MARYLAND

- Legislation
- Rules



(2) The vehicle has two or more occupants; and

(3) It cannot be determined which occupant is the violator.

(f) *Violation of section considered moving violation.* — A violation of this section is considered a moving violation for purposes of § 16-402 of this article. (An. Code 1957, art. 66½, § 11-1111; 1977, ch. 14, § 2.)

§ 21-1112. Turning off lights to avoid identification prohibited.

A person may not turn off any vehicle lights to avoid identification. (An. Code 1957, art. 66½, § 11-1112; 1977, ch. 14, § 2.)

§ 21-1113. Placing traffic hazard along highway prohibited.

(a) *Placing structures, buildings, etc., on highway.* — A person may not place any structure, building, or vehicle on a highway to sell or display any produce or merchandise if it constitutes a traffic hazard.

(b) *Removal of prohibited structure, building, etc.* — On the order of any police officer, the person shall remove the structure, building, or vehicle described under subsection (a) of this section. (An. Code 1957, art. 66½, § 11-1113; 1977, ch. 14, § 2; 1986, ch. 472, § 1.)

Effect of amendment. — The 1986 amendment, effective July 1, 1986, designated the first sentence as subsection (a), and designated the second sentence as subsection (b), and added "described under subsection (a) of this section" at the end therein.

§ 21-1114. Using roadway before opened; walking on new or newly repaired roadways; damaging highway or construction materials.

(a) *Using roadway before opened to traffic prohibited.* — A person may not drive on any new roadway or newly repaired roadway before it is opened to traffic.

(b) *Walking on new or newly repaired roadways.* — A person may not walk on any new roadway or newly repaired roadway before the roadway is opened to traffic.

(c) *Damaging highway prohibited.* — A person may not willfully injure or damage any highway, including a highway under construction.

(d) *Injury or damage to highway construction materials.* — A person may not willfully injure or damage any work, material, or structure used in connection with the construction of a highway. (An. Code 1957, art. 66½, § 11-1114; 1977, ch. 14, § 2; 1986, ch. 472, § 1.)

Effect of amendment. — The 1986 amendment, effective July 1, 1986, deleted "or walk" following "drive" in subsection (a), inserted present subsection (b), redesignated former subsection (b) to be present subsection (c), deleted the colon following "damage" and the paragraph (1) designation, and substituted a period for "; or" therein, and redesignated former paragraph (2) of former subsection (b) to be present subsection (d) and added "A person may not willfully injure or damage" therein.

§ 21-1115. Moving or removing lights or guards on highways prohibited.

(a) *Moving lights or guards.* — A person may not move any light or guard placed for the purpose of closing any part of a highway to traffic.

(b) *Removing lights or guards.* — A person may not remove any light or guard placed for the purpose of closing any part of a highway to traffic.

(c) *Altering position of lights or guards.* — A person may not alter the position of any light or guard placed for the purpose of closing any part of a highway to traffic. (An. Code 1957, art. 66½, § 11-1115; 1977, ch. 14, § 2; 1986, ch. 472, § 1.)

Effect of amendment. — The 1986 amendment, effective July 1, 1986, designated the provisions of the section to be subsection (a), deleted "remove, or alter the position of" following "move" therein, and added subsections (b) and (c).

§ 21-1116. Race or speed contest prohibited.

(a) *In general.* — Except as provided in § 21-1211 of this article, on any highway or on any private property that is used by the public in general, a person may not drive a vehicle in a race or speed contest, whether or not on a wager or for a prize or reward.

(b) *Timekeeper or flagman.* — Except as provided in § 21-1211 of this article, a person may not participate as a timekeeper or flagman in any race or speed contest specified in subsection (a) of this

TRANSPORTATION

restrictions on the use of the State highway by trucks, the Administration may establish routes, speed limits, time restrictions, weight restrictions, or other measures with respect to truck traffic on the State highway, which will minimize the adverse effects of that traffic on the residential area or cause that traffic to avoid the residential area entirely.

(c) *Requiring use of alternate route.* — Under this section, truck traffic may be prohibited entirely on any State highway or part of a State highway, if an adequately functional alternate route is available to carry the truck traffic, taking into consideration the amount of additional fuel that would be required over the alternate route and the economic impact on the citizens of this State caused by the alternate route.

(d) *Application of section.* — The provisions of this section

(1) Do not apply to any Class "E" (truck) vehicles of 10,000 pounds or less gross vehicle weight; and

(2) Do not preclude the making of local deliveries of supplies or services in any residential communities. (1978, ch. 431.)

Subtitle 3. Mobile Seafood Vendors.

§ 24-301. Definitions.

(a) *In general.* — In this subtitle the following words have the meanings indicated.

(b) *Established place of business.* — (1) "Established place of business" means any permanent building or structure from which a permanent business is conducted during normal business hours throughout the year.

(2) An established place of business does not include a tent, temporary stand or other temporary quarters, or permanent quarters occupied under a temporary arrangement.

(c) *Mobile seafood vendor.* — "Mobile seafood vendor" means a person who sells or offers for sale any seafood:

(1) While outdoors on foot;

(2) From any vehicle or conveyance, whether or not the vehicle or conveyance is in operating condition; or

(3) From any tent, temporary stand, roadside stand, roadside market, or other quarters that is not an established place of business.

(d) *Seafood.* — "Seafood" means any finfish, crustacean, or mollusk, live or dead, or any part, egg, offspring, or body of

any finfish, crustacean, or mollusk, that is intended for human consumption.

(e) *Right-of-way.* — "Right-of-way" includes any highway area or highway structure and any property adjacent to a highway acquired for the operation or use of the highway.

(f) *Shopping center.* — "Shopping center" means any 5 or more contiguous established places of business which share common parking facilities of 25 parking spaces or more.

(g) *State highway.* — "State highway" means any public highway owned by this State. (1985, ch. 756; 1986, ch. 276.)

Effect of amendment. — The 1986 amendment, effective July 1, 1986, reenacted the section without change.

§ 24-302. Applicability of subtitle.

This subtitle does not:

(1) Diminish any authority of a municipal corporation to license and regulate mobile seafood vendors;

(2) Apply to charitable or nonprofit vendors who sell seafood at short-term festivals or other short-term events; or

(3) Apply in Calvert County and in St. Mary's County for those persons selling their own catch. (1985, ch. 756; 1986, ch. 276.)

Effect of amendment. — The 1986 amendment, effective July 1, 1986, added paragraph (3).

§ 24-303. Prohibited locations.

(a) *Lease for operation on State right-of-way.* — When located on the right-of-way of any State highway, a mobile seafood vendor may not sell, or offer for sale, any seafood, unless the mobile seafood vendor has a lease from the State that permits the mobile seafood vendor to sell or offer for sale seafood.

(b) *Schools; places of worship; parking lots; privately-owned property adjoining State highways.* — A mobile seafood vendor may not sell, or offer for sale, any seafood, when located:

(1) Within 50 yards of any vehicular entrance to or exit from a school or place of worship, unless the mobile seafood dealer has written permission of the applicable school board or person who is responsible for the buildings and grounds of the place of worship;

(2) Within 100 yards of any vehicular entrance to or exit from any shopping center;

(3) In the parking lot of any shopping center, unless the mobile seafood vendor has written permission of the owner of the shopping center and conforms to applicable local laws and ordinances;

(4) Within an unsafe distance, as determined by the local authorities, from the edge of any roadway;

(5) On any roadway; or

(6) On privately-owned property adjoining a State highway, unless the mobile seafood vendor owns, leases, or has written permission of the owner of the privately-owned property. (1985, ch. 756; 1986, ch. 276.)

Effect of amendment. — The 1986 amendment, effective July 1, 1986, reenacted the section without change.

Bill review letter. — Chapter 756, Acts 1985 (House Bill 407), was approved for constitutionality and legal sufficiency, although it was determined that the provision conferring upon a place of worship a veto power over the location of a mobile seafood dealer was invalid but severable from the remaining portions of the bill. (Letter of Attorney General dated May 24, 1985).

§ 24-304. Violations.

(a) *Misdemeanor; penalty.* — A violation of this subtitle is a misdemeanor punishable by the penalty specified in § 27-101 (b) of this article.

(b) *Traffic citations.* — The charging of a person with a violation of this subtitle shall be by means of a traffic citation in the form determined under § 3-835 (b) of the Courts Article.

(c) *State or local police officers.* — The charging of a person with a violation of this section may be performed by any State or local police officer. (1985, ch. 756; 1986, ch. 276; 1987, ch. 11, § 1)

Effect of amendments. — The 1986 amendment, effective July 1, 1986, reenacted the section without change.

The 1987 amendment, approved Apr. 2, 1987, and effective from date of passage, in subsection (b), substituted "§ 3-835 (b) of the Courts Article" for "§ 26-406 of this article."

1985 Enacted Bills

REPORT ON HB 407/SB 360

Mobile Seafood Vendors -- Health Standards and Location

I. SUMMARY OF MAJOR PROVISIONS (Under the Transportation Article)

Requires mobile seafood vendor to "lease" State right-of-way if he sells from it.

Cannot be within 50 yards of a vehicular entrance or exit to school or church unless they have written permission

Cannot be within 100 yards of entrance or exit to any shopping center; or in the parking lot unless they have written permission and conform to local laws and ordinances.

Cannot be within an unsafe distance from the edge of any roadway, as determined by local authorities.

On privately-owned property adjoining a State highway with the written permission of owner.

II. SUMMARY OF ANTICIPATED EFFECTS ON SHA

Effective July 1, 1985, the State Highway Administration is to "lease" the right-of-way of any public highway owned by this State to mobile seafood vendors statewide.

Fiscal Impact--difficult to establish a "lease" value of right-of-way; demand--unknown.

III. ACTIONS RECOMMENDED FOR IMPLEMENTATION

Review requests for leasing right-of-way using procedures similar to those for permits for access from private property--Bureau of Access Permits--July 1, 1985.

Develop "lease agreement" which safeguards SHA and develop criteria for establishing the rental fees --Office of Real Estate and Office of Legal Counsel--as soon as possible to apply to "leases" requested for locations approved.

Develop criteria, application form and procedures for processing applications from mobile vendors--Bureau of Access Permits--August 30, 1985.

POLICY STATEMENT 2

As authorized by Transportation Article Sub-Title 3. Mobile Seafood Vendors. Sections 24-301 through 24-304 (1985, Ch. 756 - HB407); the Maryland State Highway Administration upon request will grant unto Mobile Seafood Vendors, a lease to utilize a portion of the State's Right of Way for the purpose of selling seafood on State Highways (excluding expressways and all "denied access highways"), subject to the following conditions:

1. Site shall be provided with adequate and safe ingress and egress by the leasee under permit from the Bureau of Engineering Access Permits.
2. Site shall be of adequate size located and used in such a fashion as not to impede the normal movement of traffic on the State Highways.
3. Site shall be of adequate size, located and used in such a fashion as not to endanger the vendor, the vendor's customers, and the general public.
4. Lease shall not eliminate or restrict the adjacent owner's rights and privileges.
5. Signs advertising off-premise items will not be permitted. Signs advertising on-site items are subject to the approval of the Maryland State Highway Administration.
6. Physical characteristics; drainage ditches, landscaping, contours, etc., cannot be changed to the detriment of the highway and its surrounding areas.
7. The mobile unit and its use must be in harmony with the neighborhood, (compatible zoning, and land usage).
8. The Leasee shall be required to submit a \$2,000.00 Surety Bond or a \$2,000.00 Security Deposit to ensure that the site is maintained properly and at the termination of the lease that the site be restored to its original condition or better.
9. The Leasee shall be required to pay a reasonable rent (as determined by the Office of Real Estate) for the use of the State's Right of Way.

RESPONSIBILITY

Initial Contact

District Office
Office of Real Estate

Provide the Bureau of Engineering Access Permits with information concerning the vendors's interest in selling seafood from a State Right of Way location.

Bureau of Engineering
Access Permits

Forward policy statement, application and requirements to the vendor.

Bureau of Engineering
Access Permits

Upon receipt of the completed application, will proceed with the processing of an entrance permit. This permit will be submitted to the Office of Real Estate for preparation of a lease.

Will review all complaints concerning the illegal use of S.H.A. Right of Way and notify the Vendors of our Laws and Regulations. If in order, prepare an entrance permit.

Office of Real Estate

Upon receipt of entrance permit, will prepare a lease agreement.

This Agreement will be forwarded to the Lessee.

Upon receipt of signed lease, submit it to the Department of General Services for approval.

Upon receipt of approved Lease, forward it to the Lessee and the procedure is completed.

MARYLAND

RULES

and

REGULATIONS

for

- ACCESS ONTO STATE HIGHWAYS
- FROM STATE LAND
- LEASED BY MOBILE SEAFOOD VENDORS

FORWARD

The objective of these regulations is to regulate and control the location along the State Highway where Seafood Vendors can operate and to provide maximum protection of the public through the orderly control of traffic to and from these locations.

The site locations at which vendors will be permitted to occupy must have sufficient dimensions to permit safe and proper movement of vehicles. With well defined and properly engineered points of access, these vehicles can enter and leave the State Highway with minimum interference with other traffic.

To obtain uniformity and maximum safety, the design of these access points shall be in accordance to State Highway Administration, American Association of State Highway Officials standards, and the Highway Research Board-Highway Capacity Manual. The controlling, safeguarding, or expediting of traffic in and out of the entrance shall be accomplished in accordance to the Manual on Uniform Traffic Control Devices for Streets and Highways.

INTRODUCTORY INFORMATION

A. AUTHORITY

House Bill No. 407, Section 24-303

- (A) When located on the Right of Way of any State Highway, a mobile seafood vendor may not sell or offer for sale any seafood, unless the mobile seafood vendor has a lease from the State that permits the mobile seafood vendors to sell or offer for sale seafood.

Transportation Article 8, Section 625 and Section 646 of the Annotated Code of Maryland (1957 Edition, as amended to date) grants to the State Highway Administration certain regulatory authority, including the right to limit the width and location of existing access points, the requirements that no entrance from any commercial or industrial property shall be made into any highway except in accordance with a permit issued by the S.H.A., and the requirement that permits must be acquired from the S.H.A. before working within and across a State Highway is initiated.

An application for a permit to lease a site on the State Right of Way, and to construct a commercial entrance shall be filed with plans, engineering fee, performance bond, and any other items which may be required by the responsible parties or their authorized representative.

B. WHO MUST APPLY FOR A LEASE AGREEMENT AND AN ENTRANCE PERMIT

All Mobile Seafood Vendors that desires to use State Right of Way for the purpose of selling seafood.

The location to the seafood vendor's site may not be; within 50 yards to an access for a school or place of worship, unless the vendor has written permission of the applicable school board or person who is responsible for the buildings and grounds of the place of worship, may not be within 100 yards of any vehicular access to a Shopping Center.

PROCEDURE FOR OBTAINING A LEASE AGREEMENT AND AN ENTRANCE PERMIT

- A. Any party desiring to lease a site on the State Right of Way and to construct a commercial entrance to and from a State Highway shall make written application in two parts; (1) Application to rent S.H.A. property (2) Application for an access permit. (see Page for application specimen) to the appropriate office listed below. Application must be accompanied by the required engineering fee, performance bond, and eight (8) copies of the detailed plan and a completed

COUNTIES

Anne Arundel
Baltimore
Calvert
Carroll
Charles
Frederick
Harford
Howard
Montgomery
Prince Georges
St. Mary's

Maryland State Highway Administration
Bureau of Engineering Access Permits
707 N. Calvert Street Room 609
Baltimore Maryland 21201

Dorchester
Wicomico
Worcester
Somerset

Maryland State Highway Administration
District Engineer
Box 751
Salisbury, Maryland 21801
or
Baltimore Office

Cecil
Caroline
Kent
Queen Annes
Talbot

Maryland State Highway Administration
District Engineer
P.O. Box 299 (Morgnec Road)
Chesterstown, Maryland 21621
or
Baltimore Office

Allegany
Garrett
Washington

Maryland State Highway Administration
District Engineer
P.O. Box 3347
1221 Braddock Road
La Vale, Maryland 21502
or
Baltimore Office

- B. Work may not be undertaken on the State right of way until the permittee has received his copy of the permit and a 48-hour advance notice has been given the maintenance engineer specified in it.

A. CHANNELIZATION

- Alt. 1 - Long Term Lease
Over One (1) Year
- All entrances permitted under these regulations shall be channelized with Type "A" concrete curb and/or curb and gutter and paved with bituminous concrete (see sample plan on Page)
- Alt. 2 - Short term lease
Less than one (1) Year
- All entrances permitted under these regulations shall be paved with bituminous concrete.

B. PAVING

Paving from the edge of existing pavement back to the Right of Way line shall consist of one of the following:

- (a) Rigid: 8 inches plain reinforced portland cement concrete in entrance proper and 9 inches reinforced portland cement concrete in the widening area.
- (b) Flexible: 9 inches compacted bituminous concrete (6 inches base - 3 inches surface).
- (c) Flexible: 3 inches (nominal) bituminous concrete surface plus 5 inches (nominal) bituminous concrete base or sand asphalt base on one of the following:
- 1) 4 inches CR-6, or
 - 2) 4 inches dense graded aggregate base, or
 - 3) 6 inches compacted gravel, or
 - 4) 12 inches select borrow or equivalent material.
- (d) Flexible: (This option may be used in rural areas only. This option and the selection of crusher run or bank run gravel for base, must have the concurrence of the District Engineer.)
- 1) 4 inches nominal bituminous concrete (2 inches surface course plus 2 inches base course) on 12 inches CR-6 or 12 inches bank run gravel.

CHAPTER 756

RECEIVED

(House Bill 407)

FEB 05 1986

AN ACT concerning

Mobile Seafood Vendors - Health Standards ^{Bur. of Envir.} ~~and Location~~

FOR the purpose of providing that cleanliness standards enforced by the Department of Health and Mental Hygiene that are required of vehicles used to transport food apply to vehicles from which any food is sold; providing for the scope of this Act concerning the authority of a municipal corporation; exempting charitable or nonprofit seafood vendors at short-term festivals and events from certain requirements of this Act; requiring that any vehicle from which shellfish or processed crabs are sold for certain purposes be capable of maintaining certain food temperatures and that the shellfish and processed crabs being transported or sold for certain purposes be maintained at a certain temperature; exempting a harvester of shellfish who delivers the shellfish to certain persons by certain methods from certain requirements of this Act; prohibiting mobile seafood vendors from operating in certain locations on, adjacent to, or within the right-of-way of certain public thoroughfares; providing certain exceptions; permitting mobile seafood vendors to operate on privately owned property adjacent to State highways only under certain conditions; providing certain exceptions; providing certain criminal penalties for violations of the transportation safety provisions of this Act; providing for the severability of the provisions of this Act under certain circumstances; and generally relating to the licensing and regulation of mobile seafood vendors.

BY repealing and reenacting, with amendments,

Article - Health - Environmental
Section 4-110
Annotated Code of Maryland
(1982 Volume and 1984 Supplement)

BY adding to

Article - Health - Environmental
Section 4-110.1
Annotated Code of Maryland
(1982 Volume and 1984 Supplement)

BY adding to

Article - Transportation
Section 24-301 through 24-304, inclusive, to be under the new subtitle "Subtitle 3. Mobile Seafood Vendors"

MASSACHUSETTS

- Legislation



MASSACHUSETTS

PUBLIC WAYS AND WORKS

81 § 7E

3. Damages—Generally

Under Massachusetts law, even when incidental damages to land adjoining the property actually taken are within statutory purview of damages to lands not included in actual taking, statute comprehends only those damages which are a necessary incident and this principle presupposes that the public work thus authorized will be executed in a reasonably proper and skillful manner with just regard to rights of private owners, and if done otherwise damages are not a necessary incident to accomplishment of public object, but are due to improper and unskillful manner of doing it, and such damage to private property is not warranted by authority under color of which it is done and is not justifiable by it. *Boston Edison Co. v. Campanella & Cardi Const. Co.* (C.A.1960) 272 F.2d 430.

If recovery can be had under statute authorizing a taking in case of damages to adjoining land caused by construction work on land actually taken, contractor may be protected from liability for such damages unless he is found to have departed from specifications or to have carried out work called for in a careless manner. *Id.*

In proceeding on petition for assessment of damages allegedly caused to petitioners' land by highway construction, if no part of petitioners' land was taken, damages could be awarded only for such injury as

was special and peculiar to the particular parcel. *Parrotta v. Com.* (1959) 159 N.E.2d 342, 339 Mass. 403.

4. — Actions to recover

If damage to adjacent property resulting from demolition of concrete ramp in connection with construction of limited access state highway was necessary result of contract with Commonwealth, contractor would not be liable in tort, and statutory recovery against Commonwealth would be allowed, but if damage was caused by contractor's negligence plaintiffs' remedy would be to proceed in tort against contractor. *Murray Realty, Inc. v. Berke Moore Co.* (1961) 175 N.E.2d 366, 342 Mass. 689.

In determining whether damage caused to adjacent properties as result of contractor's carrying out Commonwealth's plans was inevitable, test was not whether method employed was absolutely necessary but whether in choosing another method to avoid damage expense would be so disproportionate as to make other method impracticable. *Id.*

Petition for assessment of damages allegedly caused to petitioners' land by highway construction sufficiently stated cause of action under which petitioners might recover compensation, irrespective of whether there was a partial taking of their land. *Parrotta v. Com.* (1959) 159 N.E.2d 342, 339 Mass. 403.

§ 7D. Public utility easements and cattle passes

Law Review Commentaries

Eminent domain and land use planning. Julian J. D'Agostine and Richard G. Huber. 12 Annual Survey of Mass.Law. Boston College, p. 199 (1965).

Supplementary Index to Notes

Relocation 3

1. In general

Authorization to make use of part of highway for utility facilities has never been considered to create a property right or any estate or interest in land occupied. *Op. Atty.Gen.* May 3, 1963, p. 138.

3. Relocation

1956 Accelerated Highway Program Act grants discretionary authority to reimburse an owner for cost of an ordered necessary relocation of utility facilities, and such grant of authority is a constitutional exercise of legislative power. *Op. Atty.Gen.* May 3, 1963, p. 138.

Under commonlaw of Massachusetts there is no question but that public utilities must bear cost of removing or altering any facilities which they may have installed by license under, on, or over public highways and roads. *Id.*

§ 7E. Sale, transfer, lease or rental of excess lands

The department may sell at public or private sale any land, or rights in land, the title to which has been acquired by the department for highway purposes, upon determination by the board of commissioners of said department that such land or rights in land are no longer necessary for state highway purposes. In the event of such public or private sale the department shall execute a deed thereof, with or without covenants of title and warranty, in the name and behalf of the commonwealth, to the purchaser, his heirs and assigns, and deposit said deed with the

state treasurer, together with a certificate of the terms of the sale and the price paid or agreed to be paid at said sale. Upon receipt of said price, and upon the terms agreed to in said deed, the treasurer shall deliver the deed to said purchaser. The state treasurer may, by the attorney general, sue for and collect the price and otherwise enforce the terms of any such sale.

The department may, with the approval of the governor, transfer to another department, or to a city, town, or public authority or agency, any land the title to which has been acquired by it and which said board of commissioners determines is no longer necessary for state highway purposes.

The department may also, with the approval of the governor, lease or rent any land, or rights in land, the title to which has been acquired by it, and which land, or rights therein, said board of commissioners determines are not presently needed for state highway purposes.

The foregoing provisions of law with reference to the sale, leasing or renting of land acquired by the department, shall also apply to land, or rights in land, acquired by the department for maintenance sites; provided, however, that nothing contained in this section shall be construed as affecting in any way the powers, rights and duties set forth in section seven H.

In addition to the foregoing, the department may also transfer to another state department, land acquired from said state department for highway construction or reconstruction, which is no longer needed for said purposes. Said land shall be subject to such restrictions as may be imposed by the department for the use thereof.

Amended by St.1962, c. 610; St.1965, c. 755; St.1971, c. 606.

1962 Amendment. Approved June 29, 1962, towards the beginning of first sentence, deleted words "and paid for by it." As so amended the section read: "The department may sell at public or private sale or, with the approval of the governor and council, transfer to another department, or to a city, town, or public authority or agency, lease or rent any portion of the lands or rights in land the title to which has been taken or received or acquired for the purposes set forth in section seven C, and may sell in the same manner, or, with the approval of the governor and council, so transfer, lease or rent any land the title to which has been taken or received or acquired by it which the department determines is no longer necessary for state highway purposes, and may, with the approval of the governor and council, execute a deed thereof, with or without covenants of title and warranty, all in the name and behalf of the commonwealth, to the purchaser, his heirs and assigns, and deposit said deed with the state treasurer, together with a certificate of the terms of sale and price paid or agreed to be paid at said sale, and, upon receipt of said price and upon the terms agreed to in said deed, he shall deliver the deed to said purchaser. The state treasurer may, by the attorney general, sue for and collect the price and enforce the terms of any such sale."

1965 Amendment. Approved Nov. 9, 1965. Rewrote the section.

1971 Amendment. St.1971, c. 606, approved Aug. 5, 1971, added the fifth paragraph.

Law Review Commentaries

Highways and motor vehicles. Richard G. Huber, 9 Annual Survey of Mass.Law, Boston College, p. 255 (1962).

Library references

Eminent Domain ⇨322.

States ⇨89.

C.J.S. Eminent Domain §§ 454, 455.

C.J.S. States § 107.

Supplementary Index to Notes

Evidence 4

Rescission or cancellation 3

Restrictions 2

1. In general

Treasurer's participation in closing of conveyance of land from the Commonwealth to high bidders was limited to purely ministerial acts, and he did not have any right or discretion to refuse to deliver deed to high bidders if the deed was in accordance with the agreement previously made by the parties. *Whiting v. Com.* (1976) 351 N.E.2d 493, 370 Mass. 664.

St.1972, c. 765 confers authority on Public Works Department to transfer to third persons title of property taken outside project area for purpose of relocating families and businesses displaced by highway project,

notwithstanding fact that land is to be taken for purposes which may not be strictly construed as "highway purposes". Op. Atty.Gen. May 21, 1973, p. 133.

Department of Public Works may grant an assignable option to purchase lands deemed to be no longer required for highway purposes. Op. Atty.Gen. June 10, 1963, p. 165.

Department of Public Works should obtain clarifying legislation before engaging in rental program of real estate acquired for state highway purposes during period after taking and until property is needed for construction. Op. Atty.Gen. March 6, 1962, p. 154.

Where Department of Public Works determines that land is no longer necessary for state highway purposes, it has broad power to dispose of such land by sale, lease or otherwise. Op. Atty.Gen. June 23, 1960, p. 89.

In most instances, including situation where lease is contemplated of lands no longer necessary for highway purposes, approval of Governor and Council is required in order to complete transaction. Id.

2. Restrictions

Where plaintiffs made an offer to purchase land on terms set forth by the Commonwealth in its public invitation for bids, Commonwealth approved and accepted offer by formal vote of the commissioners of the department of public works, unconditional notice of the approval and acceptance was given to plaintiffs in writing, and plaintiffs paid in full the balance of agreed

purchase price, an enforceable agreement for the purchase and sale of the land came into existence no later than the time when plaintiffs, at the department's request, paid the full balance of the amount bid, and it was then too late for the department to try to impose on plaintiffs a new restriction, not referred to in invitation for bids, against using the land for purposes other than the parking of vehicles. *Whiting v. Com.* (1976) 351 N.E.2d 493, 370 Mass. 664.

3. Rescission or cancellation

Commonwealth, which had not reserved any right to rescind or cancel real estate deal in any documents of the case, did not have right, after entry into contract of sale and up to the time of delivery of deed, to change its mind, rescind vote of the commissioners of the department of public works, and call off the deal. *Whiting v. Com.* (1976) 351 N.E.2d 493, 370 Mass. 664.

4. Evidence

With respect to issue of whether contract for sale of land by the Commonwealth or any memorandum or note thereof was in writing and signed by the party to be charged therewith or by some lawfully authorized person, evidence was sufficient to permit inference that chief right-of-way agent for the department of public works was authorized to send to high bidders on the behalf of the department letter informing them that the commissioners of the department had voted to approve and accept the bid. *Whiting v. Com.* (1976) 351 N.E.2d 493, 370 Mass. 664.

§ 7F. Entry on private land for purpose of surveys, soundings and drillings

Whenever the department deems it necessary to make surveys, soundings, drillings or examinations to obtain information for or to expedite the construction of state highways or other projects under its jurisdiction, the department, its authorized agents or employees may, after due notice by registered or certified mail, enter upon any lands, waters and premises, not including buildings, in the Commonwealth for the purpose of making surveys, soundings, drillings and examinations as they may deem necessary or convenient for the purposes of this act, and such entry shall not be deemed a trespass nor shall an entry for such purposes be deemed an entry under any condemnation proceedings which may be then pending. The department shall make reimbursement for any injury or actual damage resulting to such lands, waters and premises caused by any act of its authorized agents or employees and shall so far as possible restore such lands to the same condition as prior to the making of such surveys, soundings, drillings or examinations.

Added by St.1958, c. 582. Amended by St.1979, c. 30.

Emergency. Approved September 26, 1958.

1979 Amendment. St.1979, c. 30, approved March 20, 1979, inserted "or certified" in the first sentence.

Law Review Commentaries

Inverse condemnation liability for unintended physical damage: privileged entry upon private property. Arvo Van Alstyne (1969) 20 *Hastings L.J.* 483.

approximately fifty-six hundredths of an ounce dropped from a height of fifty inches. Raised ledge multifocal lenses shall be capable of withstanding said impact test but need not be tested beyond initial design testing. All prescription glass lenses shall withstand said impact test. To demonstrate that all nonprescription glass lenses, plastic lenses and laminated lenses are capable of withstanding said impact test, the manufacturer of such lenses shall subject to said impact test a statistically significant sampling of lenses from each production batch, and the lenses so tested shall be representative of the finished forms as worn by the wearer. Plastic prescription and plastic nonprescription lenses, tested on the basis of statistical significance, may be tested in uncut finished or semifinished form at the point of original manufacture.

No person shall distribute, sell, exchange or deliver or have in his possession with intent to distribute, sell, exchange or deliver any eyeglass or sunglass frame containing any form of cellulose nitrate or other highly flammable material.

Whoever violates any provision of this section shall be punished by a fine of not more than five hundred dollars for each violation.

Amended by St.1973, c. 598; St.1979, c. 381.

1973 Amendment. St.1973, c. 598, rewrote the first paragraph.

St.1973, c. 598, was approved Aug. 9, 1973. Emergency declaration by the Governor was filed Aug. 10, 1973.

1979 Amendment. St.1979, c. 381, approved July 5, 1979, in the first paragraph, in the third

sentence deleted “, except plastic lenses, laminated lenses, and raised ledge multifocal lenses,” following “sunglass lenses”; substituted “be capable of withstanding” for “withstand”, inserted the fifth sentence, and in the sixth sentence, inserted “nonprescription glass lenses,”.

§ 6. Selling or giving tobacco to minors

Whoever sells a cigarette, chewing tobacco, snuff or any tobacco in any of its forms to any person under the age of eighteen or, not being his parent or guardian, gives a cigarette, chewing tobacco, snuff or tobacco in any of its forms to any person under the age of eighteen shall be punished by a fine of not less than one hundred dollars for the first offense, not less than two hundred dollars for a second offense and not less than three hundred dollars for any third or subsequent offense.

Amended by St.1985, c. 345.

1985 Amendment. St.1985, c. 345, approved Oct. 4, 1985, rewrote this section.

§ 8A. Foods containing foreign injury causing substances; distribution or sale

Whoever sells, gives, or distributes to anyone candy or other food or foodstuffs containing a foreign substance, which is intended or may reasonably be expected to cause injury to a person eating the same, shall be punished by imprisonment in the state prison for not more than five years.

Added by St.1977, c. 861.

1977 Enactment. St.1977, c. 861, an emergency act, was approved Dec. 27, 1977.

C.J.S. Food § 25.

Library References

Food ⇐14.

§ 16. Disposal of rubbish, etc. on or near highways and coastal or inland waters; penalties; applicability to dumping grounds; enforcement

Whoever places, throws, deposits, discharges, or causes to be placed, thrown, deposited or discharged, any trash, bottles or cans, refuse, rubbish, garbage, debris, scrap, waste or

any other material of any kind on a public highway or within twenty yards thereof, or on any other public land, or in or upon coastal or inland waters, as defined in section one of chapter one hundred and thirty-one, respectively, or within twenty yards of any such water, or on property of another, shall be punished by a fine of not more than one thousand dollars for the first offense and not more than ten thousand dollars for each subsequent offense, and the court may require, in addition thereto, that such person remove, at his own expense, such trash, refuse, rubbish, debris or materials. The permission of the owner of land to place, throw, deposit or discharge such trash, refuse, rubbish, garbage, debris, scrap, waste or any other material of any kind on such owner's land shall constitute a defense in any trial for such offense.

If a motor vehicle is used in committing such an offense, a conviction under this section shall forthwith be reported by the court to the registrar of motor vehicles, and the registrar may suspend the license of the operator of such vehicle for not more than thirty days, and if it appears from the records of the registrar of motor vehicles that the person so convicted is the owner of the motor vehicle so used, the registrar may suspend the certificate of registration of said vehicle for thirty days.

The provisions of this section shall not be applicable to any dumping ground approved under section one hundred and fifty A of chapter one hundred and eleven or by other appropriate public authority.

This section shall be enforced by natural resources officers, by the director of the division of motorboats or his authorized agents, by harbor masters and assistant harbor masters, by members of the state police and inspectors of the registry of motor vehicles and by city, town and metropolitan district commission police officers. A city by majority vote of the city council, with the approval of the mayor, or in a town by a vote of its town meeting may enforce this section by designating its public health agents, health officers and health directors as enforcing officers. In the city of Boston this section shall also be enforced by the commissioner of health and hospitals, by the commissioner of housing inspection, and by the commissioner of public works, and their respective authorized agents, and in section sixteen A, the commissioner of health and hospitals, the commissioner of housing inspection, and the commissioner of public works shall be deemed to be the commanding officers of their respective authorized agents; provided, however, that any person observing a violation of this section may file a petition for issuance of a complaint pursuant to this section with the clerk of the district court having jurisdiction or, in the city of Boston, with the clerk of the Boston municipal court department, and upon determining that probable cause exists therefor, such clerk shall issue such complaint.

Amended by St.1971, c. 79; St.1972, c. 191; St.1973, c. 835, § 1; St.1974, c. 39; St.1979, c. 103; St.1979, c. 105; St.1982, c. 130, §§ 1, 2; St.1985, c. 197.

1971 Amendment. St.1971, c. 79, approved March 8, 1971, increased the maximum fine from \$100 to \$200.

1972 Amendment. St.1972, c. 191, approved April 20, 1972, in the first sentence of the first paragraph, inserted ", and the court may require, in addition thereto, that such person remove, at his own expense, such trash, refuse, rubbish or debris".

1973 Amendment. St.1973, c. 835, § 1, approved Sept. 26, 1973, added the second sentence of the third paragraph.

1974 Amendment. St.1974, c. 39, approved March 15, 1974, inserted "any other materials of any kind" and "materials" in the first paragraph; and reconstructed the former second sentence of the first paragraph as the second para-

graph, and substituted "an offense" for "nuisance" therein.

1979 Amendments. St.1979, c. 103, approved April 19, 1979, inserted the second sentence of the fourth paragraph.

St.1979, c. 105, approved April 19, 1979, in the first paragraph, inserted "garbage," and "scrap, waste", deleted "without permission of the owner thereof" following "property of another", and inserted "one thousand dollars and not less than" in the first sentence, and added the second sentence.

1982 Amendment. St.1982, c. 130, § 1, approved June 3, 1982, in the first paragraph, in the first sentence, inserted "bottles or cans," and substituted "two hundred dollars for the first offense and not more than one thousand dollars for each subsequent offense" for "one

thousand dollars and not less than two hundred dollars", and in the second sentence, substituted "such owner's" for "his".

Section 2 of St.1982, c. 130, in the fourth paragraph, in the last sentence, added the proviso.

1985 Amendment. St.1985, c. 197, approved July 24, 1985, in the first paragraph, in the first sentence, substituted "one thousand" for "two hundred", and substituted "ten thousand" for "one thousand".

Law Review Commentaries

Coastal wetlands in New England. (1972) 52 Boston U.L.Rev. 724.

Parking; streets; litter. Herbert P. Gleason, William H. Kerr and Thomas H. Martin, 18 Annual Survey of Mass. Law, Boston College, p. 389 (1971).

Proposed national control of redeemable solid waste. (1971) 5 Suffolk U.L.Rev. 962.

§ 16A. Alternative noncriminal disposition of violations of section 16; notice to appear before clerk of district court; payment of fine

If any officer empowered to enforce section sixteen takes cognizance of a violation thereof, he may request the offender to state his name and address. Whoever, upon such request, refuses to state his name and address, may be arrested without a warrant, or if he states a false name and address or a name and address which is not his name and address in ordinary use, he shall be punished by a fine of not less than twenty nor more than fifty dollars. Such officer may, as an alternative to instituting criminal proceedings, forthwith give to the offender a written notice to appear before the clerk of the district court having jurisdiction at any time during office hours, not later than twenty-one days after the date of such violation. Such notice shall be made in triplicate, and shall contain the name and address of the offender and, if served with notice in hand at the time of such violation, the number of his license, if any, to operate motor vehicles; the registration number of the vehicle or motor boat involved, if any; the time and place of the violation; the specific offense charged; and the time and place for his required appearance. Such notice shall be signed by the officer, and shall be signed by the offender whenever practicable in acknowledgement that the notice has been received. The officer shall if possible deliver to the offender at the time and place of the violation a copy of said notice. Whenever it is not possible to deliver a copy of said notice to the offender at the time and place of the violation, said copy shall be mailed or delivered by the officer, or by his commanding officer or any person authorized by said commanding officer, to the offender's last known address, or in the case of a violation involving a motor vehicle or motor boat registered under the laws of this commonwealth, within five days of the offense, or in the case of any motor vehicle or motor boat registered under the laws of another state or country, within ten days thereof, exclusive, in either case, of Sundays and holidays, to the address of the registrant of the motor vehicle or motor boat involved, as appearing, in the case of a motor vehicle registered under the laws of this commonwealth, in the records of the registry of motor vehicles or the division of motor boats or, in the case of a motor vehicle or motor boat registered under the laws of another state or country in the records of the official in such state or country having charge of the registration of such motor vehicle or motor boat. Such notice mailed, by the officer, his commanding officer, or the person so authorized to the last address of said registrant as appearing as aforesaid, shall be deemed a sufficient notice, and a certificate of the officer or person so mailing such notice that it has been mailed in accordance with this section shall be deemed prima facie evidence thereof and shall be admissible in any court of the commonwealth as to the facts contained therein. At or before the completion of each tour of duty the officer shall give to his commanding officer those copies of each notice of such a violation he has taken cognizance of during such tour which have not already been delivered or mailed by him as aforesaid. Said commanding officer shall retain and safely preserve one of such copies and shall, at a time not later than the next court day after said delivery or mailing, deliver another of such copies to the clerk of the court before whom the offender has been notified to appear. The clerk of each district court shall maintain a separate docket of all such notices to appear.

Any person notified to appear before the clerk of a district court as hereinbefore provided may appear before such clerk and confess the offense charged, either personally

PUBLIC WAYS AND WORKS

81 § 24

Note 1

1963 Amendment. Approved May 6, 1963. Added fifth and seventh sentences.

1971 Amendment. St.1971, c. 541, approved July 21, 1971, increased the minimum and maximum amounts of the bond, in the fourth sentence, from \$500 and \$10,000 to \$2,000 and \$50,000, respectively.

1975 Amendment. St.1975, c. 227, approved May 19, 1975, inserted the second sentence.

1980 Amendment. St.1980, c. 477, approved July 11, 1980, inserted the sixth sentence.

Code of Massachusetts Regulations

Executive office of environmental affairs, MEPA regulations, appendix D, see 301 CMR 10.33.

not provide for fees. Op.Atty.Gen., Aug. 6, 1963, p. 79.

Department of Public Works could issue permit for removal of, and sell materials comprising high ridge within state highway layout, however, sale must comply with rules under statute, as to disposal of certain property of commonwealth. Op.Atty.Gen., April 5, 1962, p. 168.

Construction of underpass under state highway connecting two parts of a private shopping center, may be done with funds supplied by the shopping center or, in alternative, the construction may be carried out under a permit issued in accordance with this section. Op.Atty.Gen., June 3, 1957, p. 90.

Notes of Decisions

1. In general

Department of public works may not charge fees for permits issued under statutes which did

§ 22. Prescriptive rights of adjoining owners

No length of possession, or occupancy of land within the limits of a state highway by an owner or occupant of adjoining land shall give him any title thereto, and any fences, buildings or other objects encroaching upon a state highway shall, upon written notice by the department, be removed within fourteen days by the owner or occupant of adjoining land, and if not so removed, the department may either remove the same to such adjoining land or such encroaching objects, other than a building used for residential purposes, may be removed by the department forces and shall be placed in the nearest maintenance area of the department. Notice by certified mail, return receipt requested shall be given to the owner stating where such encroaching object is located and further stating that if not claimed within three weeks said object may be destroyed.

Amended by St.1985, c. 44.

1985 Amendment. St.1985, c. 44, approved May 6, 1985, in the first sentence substituted "objects" for "obstructions" and "within fourteen days" for "forthwith", inserted "either" and added "or such encroaching objects, other

than a building used for residential purposes, may be removed by the department forces and shall be placed in the nearest maintenance area of the department", and added the second sentence.

IMPROVEMENT OF WAYS NOT STATE HIGHWAYS

§ 24. Authorization

Notes of Decisions

1. In general

Board of Project Review could under St.1963, c. 822, § 9, approve a portion of a route and make recommendations consistent with state and federal requirements, or it may register disapproval of the entire route and may make recom-

mendations subject to such requirement. Op. Atty.Gen., Sept. 28, 1964, p. 96.

Final approval of decision of Board of Project review under St.1963, c. 822, § 9, terminates any further changes in the project except that any approval could include provision for minor essential, unforeseen engineering changes. Id.

§ 123. Land of state and county institutions; institutions of higher education; trespass

Whoever willfully trespasses upon land or premises belonging to the commonwealth, or to any authority established by the general court for purposes incidental to higher education, appurtenant to a public institution of higher education, the state prison, state prison colony, Massachusetts reformatory, reformatory for women, state farm, Tewksbury hospital, Soldiers' Home in Massachusetts, Soldiers' Home in Holyoke, any public institution for the care of insane, feeble minded or epileptic persons, any Massachusetts training school or state charitable institution, or upon land or premises belonging to any county and appurtenant to a jail, house of correction or courthouse, or whoever, after notice from an officer of any of said institutions to leave said land, remains thereon, shall be punished by a fine of not more than fifty dollars or by imprisonment for not more than three months.

Amended by St.1941, c. 344, § 27; St.1958, c. 613, § 8E; St.1959, c. 213; St.1960, c. 315; St.1969, c. 362.

Historical Note

St.1885 c. 303.	St.1911 c. 181.	St.1918 c. 257 § 307.
R.L.1902 c. 208 § 112.	St.1911 c. 194.	St.1919 c. 5.
St.1905 c. 434.	St.1913 c. 404.	St.1920 c. 2.
St.1906 c. 243.	St.1914 c. 358.	St.1931 c. 426 § 308.
St.1911 c. 104.		

St.1941, c. 344, deleted references to "the prison camp and hospital" and the "state infirmary", and added a reference to the "Tewksbury state hospital and infirmary".

St.1958, c. 613, approved October 3, 1958, substituted the word "hospital" for "state hospital and infirmary".

St.1959, c. 213, approved April 21, 1959, extended application of the section to Soldiers' Home in Massachusetts and to Soldiers' Home in Holyoke.

St.1960, c. 315, approved April 12, 1960, extended application of the section to land appurtenant to county courthouse.

St.1969, c. 362, approved June 2, 1969, modified the section by inserting ", or to any authority established by the general court for purposes incidental to higher education," and by inserting "a public institution of higher education,".

Library References

Trespass ⇨76 et seq.

C.J.S. Trespass § 140 et seq.

§ 124. Legal notice; penalty for malicious injury

Whoever wilfully and maliciously, or wantonly and without cause, tears down, removes or defaces a warrant for a town meeting, list of jurors or other notice or paper which has been posted in compliance with law shall, except as otherwise provided, be punished by a fine of not more than ten dollars.

MICHIGAN

- Legislation



257.674a-675

(h) Between a safety zone and the adjacent curb or within 30 feet of a point on the curb immediately opposite the end of a safety zone, unless a different length is indicated by an official sign or marking.

(i) Within 50 feet of the nearest rail of a railroad crossing.

(j) Within 20 feet of the driveway entrance to a fire station and on the side of a street opposite the entrance to a fire station within 75 feet of the entrance if properly marked by an official sign.

(k) Alongside or opposite a street excavation or obstruction, if the stopping, standing, or parking would obstruct traffic.

(l) On the roadway side of a vehicle stopped or parked at the edge or curb of a street.

(m) Upon a bridge or other elevated highway structure or within a highway tunnel.

(n) At a place where an official sign prohibits stopping or parking.

(o) Within 500 feet of an accident at which a police officer is in attendance, if the scene of the accident is outside of a city or village.

(p) In front of a theater.

(q) In a place or in a manner which blocks immediate egress from an emergency exit conspicuously marked as an emergency exit of a building.

(r) In a place or in a manner which blocks or hampers the immediate use of an immediate egress from a fire escape conspicuously marked as a fire escape providing an emergency means of egress from a building.

(s) In a parking space clearly identified by an official sign as being reserved for use by handicappers which is on public property or private property available for public use, unless the person is a handicapper as described in section 19a or unless the person is parking the vehicle for the benefit of a handicapper. In order for the vehicle to be parked in the parking space the vehicle shall display 1 of the following:

(i) A certificate of identification issued under section 675(5) to a handicapper on the lower left corner of the front windshield.

(ii) A special registration plate issued under section 803d to a handicapper.

(iii) A similar certificate of identification issued by another state to a handicapper.

(iv) A similar special registration plate issued by another state to a handicapper.

(t) Within 500 feet of a fire at which fire apparatus is in attendance, if the scene of the fire is outside a city or village. However, volunteer fire fighters responding to the fire may park within 500 feet of the fire in a manner not to interfere with fire apparatus at the scene. A vehicle parked legally previous to the fire is exempt from this subdivision.

(u) In violation of an official sign restricting the period of time for or manner of parking.

(v) In a space controlled or regulated by a meter on a public highway or in a publicly owned parking area or structure, if the allowable time for parking indicated on the meter has expired.

(w) On a street or highway in such a way as to obstruct the delivery of mail to a rural mailbox by a carrier of the United States postal service.

(2) A person shall not move a vehicle not owned by the person into a prohibited area or away from a curb a distance which makes the parking unlawful.

(3) A bus, for the purpose of taking on or discharging passengers, may be stopped at a place described in subsection (1) (b), (d), or (f) or on the roadway side of a vehicle illegally parked in a legally designated bus loading zone. A bus, for the purpose of taking on or discharging a passenger, may be stopped at a place described in subsection (1) (n) if the place is posted by an appropriate bus stop sign, except that a bus shall not stop at such a place if the stopping is specifically prohibited by the responsible local authority, the state transportation department, or the director of the department of state police.

(4) A person who violates this section is responsible for a civil infraction.

Am. 1985, Act 69.

CI 257.674a Clear vision area. [MSA 9.2374(1)]

Sec. 674a. (1) A vehicle shall not be parked in an area purchased, acquired, or used as a clear vision area adjacent to or on a highway right of way. A person shall not conduct vending or other commercial enterprises in a clear vision area.

(2) A person who violates this section is responsible for a civil infraction.

Am. 1980, Act 518.

257.675 Parking regulation; handicapped persons' permits. [MSA 9.2375]

CI Sec. 675. (1) Except as otherwise provided in this section and this chapter, a vehicle stopped or parked upon a highway or street shall be stopped or parked with the wheels of the vehicle parallel to the roadway and within 12 inches of any existing right-hand curb.

CI (2) Local authorities may by ordinance permit parking of vehicles with the left-hand wheels adjacent to and within 12 inches of the left-hand curb of a 1-way roadway.

CI (3) Local authorities may by ordinance permit angle parking on a roadway, except that angle parking shall not be permitted on a state trunk line highway.

CI (4) The state transportation commission with respect to state trunk line highways and the board of county road commissioners with respect to county roads, acting jointly with the director of the department of state police, may place signs prohibiting or restricting the stopping, standing, or parking of vehicles on a highway where in the opinion of the officials as determined by an engineering survey, the stopping, standing, or parking is dangerous to those using the highway or where the stopping, standing, or parking of vehicles would unduly interfere with the free movement of traffic on the highway or street. The signs shall be official signs and a person shall not stop, stand, or park a vehicle in

257.675c-677a

257.675c Prima facie responsibility for parking violation. [MSA 9.2375(3)]

Sec. 675c. (1) If a vehicle is stopped, standing, or parked in violation of sections 672, 674, 674a, 675, 676, or other state statute, or a local ordinance prohibiting or restricting the stopping, standing, or parking of a vehicle and the violation is a civil infraction, the person in whose name that vehicle is registered in this state or another state at the time of the violation is prima facie responsible for that violation and subject to section 907.

(2) The owner of a vehicle cited for a stopping, standing, or parking violation pursuant to subsection (1) may assert as an affirmative defense that the vehicle in question, at the time of the violation, was in the possession of a person whom the owner had not knowingly permitted to operate the vehicle.

(3) The registered owner of a vehicle who is found to be responsible for a civil infraction as the result of subsection (1) has the right to recover in a civil action against the person who parked, stopped, or left standing the vehicle in question damages in the amount of any civil fine or costs, or both, imposed pursuant to section 907. The registered owner of a vehicle may provide in a written agreement that the person who parked, stopped, or left standing the vehicle in violation of a state statute or local ordinance, when the violation is a civil infraction, shall indemnify the registered owner for any civil fine and costs imposed upon the registered owner for that civil infraction.

(4) A police officer who issues a citation for a vehicle that is stopped, standing or parked in violation of a state statute or a local ordinance prohibiting or restricting the stopping, standing, or parking of a vehicle may issue the citation for the violation to the operator of the vehicle if the operator is present at the time of the violation.

Add. 1980, Act 518.

MISCELLANEOUS RULES

CI 257.676 Unattended motor vehicle, brakes, grade. [MSA 9.2376]

Sec. 676. (1) A vehicle shall not be allowed to stand on a highway unattended without the brakes being set and the motor of the vehicle being stopped. If the vehicle is standing upon a grade, the front wheels of the vehicle shall be turned to the curb or side of the highway.

(2) A person who violates this section is responsible for a civil infraction.

Add. 1980, Act 518.

CI 257.676a Highways outside of cities and villages; display of goods, produce, merchandise within right of way, penalty. [MSA 9.2376(1)]

Sec. 676a. A person, firm, or corporation who sells or offers for sale, or displays or attempts to display for sale, goods, wares, produce, fruit, vegetables, or merchandise within the right of way of a highway outside of the corporate limits of a city or

village, or within the right of way of a state trunk line highway, is responsible for a civil infraction. This section shall not interfere with a permanently established business presently located on or partially on private property, nor does this section grant to the owner additional rights or authority that the owner may not now possess, nor diminish the legal rights or duties of the authority having jurisdiction of the right of way.

Am. 1978, Act 510.

CI 257.676b Impede traffic. [MSA 9.2376(2)]

Sec. 676b. (1) A person, without authority, shall not block, obstruct, impede, or otherwise interfere with the normal flow of vehicular or pedestrian traffic upon a public street or highway in this state, by means of a barricade, object, or device, or with his or her person. This section shall not apply to persons maintaining, rearranging, or constructing public utility facilities in or adjacent to a street or highway.

(2) A person who violates this section is responsible for a civil infraction.

Am. 1978, Act 510.

CI 257.677 Interference with driver's view or control. [MSA 9.2377]

Sec. 677. (1) A person shall not drive a vehicle when it is loaded, or when there are in the front seat a number of persons, as to obstruct the view of the driver to the front or sides of the vehicle or as to interfere with the driver's control over the driving mechanism of the vehicle.

(2) A passenger in a vehicle or streetcar shall not ride in a position as to interfere with the driver's or operator's view ahead or to the sides, or to interfere with the driver's or operator's control over the driving mechanism of the vehicle or streetcar.

(3) A person who violates this section is responsible for a civil infraction.

Am. 1978, Act 510.

257.677a Snow, ice, slush on roadway. [MSA 9.2377(1)]

Sec. 677a. (1) As used in this section:

(a) "Person" shall not include the state or a political subdivision of the state or an employee of the state or a political subdivision of the state operating within the scope of his duties.

(b) "Safety vision" means an unobstructed line of sight enabling a driver to travel upon, enter, or exit a roadway in a safe manner.

(2) A person shall not remove, or cause to be removed, snow, ice, or slush onto or across a roadway or the shoulder of the roadway in a manner which obstructs the safety vision of the driver of a motor vehicle other than off-road vehicles.

(3) A person shall not deposit, or cause to be deposited, snow, ice, or slush onto or across a roadway or the shoulder of the roadway in a manner which obstructs the safety vision of the driver of a motor vehicle.

(4) A person shall not deposit, or cause to be deposited, snow, ice or slush on any roadway or

Add. 1978, Act 82.

MINNESOTA

- Legislation
- Rules



161.23 DEPARTMENT OF TRANSPORTATION AND TRUNK HIGHWAY SYSTEM

deed may contain restrictive clauses limiting the use of such real estate in the interests of safety and convenient public travel when the commissioner finds that the restrictions are reasonably necessary.

Subd. 2a. Services of a licensed real estate broker. If the lands remain unsold after being offered for sale to the highest bidder, the commissioner may retain the services of a licensed real estate broker to find a buyer. The sale price may be negotiated by the broker, but must not be less than 90 percent of the appraised market value as determined by the commissioner. The broker's fee must be established by prior agreement between the commissioner and the broker, and must not exceed ten percent of the sale price for sales of \$10,000 or more. The broker's fee must be paid to the broker from the proceeds of the sale.

Subd. 3. Leasing. The commissioner may lease for the term between the acquisition and sale thereof and for a fair rental rate and upon such terms and conditions as the commissioner deems proper, any excess real estate acquired under the provisions of this section, and any real estate acquired in fee for trunk highway purposes and not presently needed therefor. All rents received from the leases shall be paid into the state treasury. Seventy percent of the rents shall be credited to the trunk highway fund. The remaining 30 percent shall be paid to the county treasurer where the real estate is located, and shall be distributed in the same manner as real estate taxes. **This subdivision does not apply to real estate leased for the purpose of providing commercial and public service advertising pursuant to franchise agreements as provided in sections 160.276 to 160.278.**

Subd. 4. Limitation on construction of section. Nothing contained in this section shall be construed to prevent the commissioner from acquiring lands, real estate, or interests in lands or real estate necessary for trunk highway purposes, without the consent of the owner or owners thereof.

Subd. 5. Receipts paid into trunk highway fund. Money received from the sale of such lands and properties less any fee paid under subdivision 2a must be paid into the trunk highway fund.

History: 1959 c 500 art 2 s 23; 1973 c 544 s 1; 1976 c 166 s 7; 1980 c 494 s 6; 1980 c 533 s 7; 1985 c 108 s 1-3; 1986 c 444

NOTE: See section 16.02, subdivision 14.

See section 272.68.

161.231 APPROPRIATION; PROCEEDS FROM LEASED PROPERTY.

There is appropriated annually from the fund or account in the state treasury to which the rental money from state leased property is credited a sufficient amount of money to carry out the state's obligations under the provisions of sections 161.23, subdivision 3, and 272.68, subdivision 3.

History: Ex1971 c 3 s 75

161.24 MS 1957 [Repealed, 1959 c 500 art 6 s 13]

161.24 CHANGES REQUIRED BY CONSTRUCTION OF TRUNK HIGHWAY.

Subdivision 1. Grade at intersections. When the construction or reconstruction of a trunk highway results in a change of grade which necessitates a change of grade in intersecting or connecting highways or streets, including city streets, the cost of making the grade changes and any damages occasioned thereby shall be paid out of the trunk highway fund.

Subd. 2. Relocation of highway. When in the judgment of the commissioner, the establishment, construction, or reconstruction of a trunk highway requires, in the interest of safety or convenient public travel, a change in the location of any highway or street, including a city street, the commissioner may make the needed change in location after obtaining the approval of the road authority having jurisdiction over such highway or street. The cost of the change in location and any damages occasioned

161.42 DEPARTMENT OF TRANSPORTATION AND TRUNK HIGHWAY SYSTEM

not less than the cost to the department. All money received from the sale or leasing of the equipment shall be paid into the trunk highway fund.

History: 1959 c 500 art 2 s 42; 1976 c 166 s 7

161.43 RELINQUISHMENT OF HIGHWAY EASEMENTS.

The commissioner of transportation may relinquish and quitclaim to the fee owner an easement or portion of an easement owned but no longer needed by the transportation department for trunk highway purposes, upon payment to the transportation department of an amount of money equal to the appraised current market value of the easement. If the fee owner refuses to pay the required amount, or if after diligent search the fee owner cannot be found, the commissioner may convey the easement to an agency or to a political subdivision of the state upon terms and conditions agreed upon, or the commissioner may acquire the fee title to the land underlying the easement in the manner provided in section 161.20, subdivision 2. After acquisition of the fee title, the lands may be sold to the highest responsible bidder upon three weeks published notice of the sale in a newspaper or other periodical of general circulation in the county where the land is located. All bids may be rejected and new bids received upon like publication. If the lands remain unsold after being offered for sale to the highest bidder, the commissioner may retain the services of a licensed real estate broker to find a buyer. The sale price may be negotiated by the broker, but must not be less than 90 percent of the appraised market value as determined by the commissioner. The broker's fee must be established by prior agreement between the commissioner and the broker, and must not exceed ten percent of the sale price for sales of \$10,000 or more. The broker's fee must be paid to the broker from the proceeds of the sale.

History: 1959 c 500 art 2 s 43; 1971 c 276 s 1; 1976 c 166 s 7; 1980 c 533 s 8; 1983 c 143 s 6; 1984 c 654 art 3 s 57

161.431 LEASING OF HIGHWAY EASEMENTS.

The commissioner may lease to the fee owner for a fair rental rate and upon terms and conditions that the commissioner deems proper, an easement in real estate acquired for trunk highway purposes and not then needed for trunk highway purposes. If the fee owner refuses to lease or if after diligent search the fee owner cannot be found, the commissioner may lease the easement to an agency or to a political subdivision of the state on terms and conditions agreed upon, or the commissioner may lease the easement to the highest responsible bidder upon three weeks published notice of the lease offering in a newspaper or other periodical of general circulation in the county where the easement is located. All bids may be rejected and new bids received upon like publication. All rents received from the lease must be paid into the state treasury. Seventy percent of any rent received is to be credited to the trunk highway fund. The remaining 30 percent is to be paid to the county treasurer of the county where the easement is located for distribution in the same manner as real estate taxes.

History: 1983 c 143 s 7

161.433 USE OF AIRSPACE ABOVE AND SUBSURFACE BELOW TRUNK HIGHWAYS.

Subdivision 1. **Lease or permit, conditions and restrictions.** The commissioner of transportation may lease or otherwise permit the use of the airspace above and subsurface area below the surface of the right-of-way of any trunk highway, including the surface of the right-of-way above and below the airspace or subsurface areas, where the land is owned in fee by the state for trunk highway purposes when the use will not impair or interfere with the use and safety of the highway. The lease, permit, or other agreement may contain such restrictive clauses as the commissioner deems necessary in the interest of safety and convenience of public travel and other highway purposes. No lease, permit, or other agreement shall be for a period in excess of 99 years. Vehicular access to such airspace, subsurface, or surface areas shall not be allowed directly from the highway where such access would violate the provisions of United

States Code, title 23, or would interfere in any way with the free flow of traffic on the highway. Any lease, permit, or other agreement shall have the approval of the appropriate federal agency when required.

Subd. 2. **Consideration for use.** The consideration paid for the use of airspace or subsurface areas shall be determined by the commissioner, but in no event shall it be less than a fair rental rate, and shall include costs for the erection and maintenance of any facilities or other costs occasioned by that use. All moneys received shall be paid into the trunk highway fund. This subdivision does not apply to real estate leased for the purpose of providing commercial and public service advertising pursuant to franchise agreements as provided in sections 160.276 to 160.278.

Subd. 3. **Application to certain provisions.** Laws 1967, chapter 214 shall not apply to or affect the rights and privileges referred to in sections 161.45, 222.37, and 300.03.

History: 1967 c 214 s 1,2,5; 1976 c 166 s 7; 1980 c 494 s 7; 1980 c 533 s 9

161.434 RIGHT-OF-WAYS OF INTERSTATE AND TRUNK HIGHWAYS; LIMITED LAND USE.

The commissioner may also make such arrangements and agreements as the commissioner deems necessary in the public interest for the limited use of land owned as interstate or trunk highway right-of-way, which use shall be for highway purposes, including aesthetic purposes, but not including the erection of permanent buildings, except buildings or structures erected for the purpose of providing information to travelers through commercial and public service advertising pursuant to franchise agreements as provided in sections 160.276 to 160.278. The commissioner shall secure the approval of the appropriate federal agency where such approval is required.

History: 1967 c 659 s 1; 1969 c 482 s 1; 1980 c 494 s 8; 1986 c 444

161.435 [Repealed, 1967 c 214 s 6]

161.44 RELINQUISHMENT OF LANDS OWNED IN FEE.

Subdivision 1. **Conveyance.** The commissioner may convey and quitclaim any lands, including any improvements thereon, owned in fee by the state for trunk highway purposes but no longer needed therefor. Notwithstanding any provisions in this section or in section 161.23 to the contrary, fee title to or an easement in all or part of the lands and lands previously acquired in fee for trunk highways or acquired pursuant to section 161.23, in excess of what is needed for highway purposes may be conveyed and quitclaimed for public purposes to any political subdivision or agency of the state upon the terms and conditions as may be agreed upon between the commissioner and the political subdivision or agency.

Subd. 2. **Reconveyance when remainder of tract owned by vendor or surviving spouse.** If the lands were part of a larger tract and the remainder of the tract is still owned by the person or the person's surviving spouse from whom the lands were acquired, or if the lands constituted an entire tract, the lands must first be offered for reconveyance to the previous owner or the owner's surviving spouse. When lands are offered for reconveyance, the amount of money to be repaid for those lands must be the appraised current market value of the lands to be reconveyed. The offer must be made by certified mail addressed to the person at the person's last known address. The person or the person's surviving spouse shall have 60 days from the date of mailing the offer to accept and to tender to the commissioner the required sum of money.

Subd. 3. **Conveyance when remainder of tract no longer owned by vendor or surviving spouse.** If the lands were part of a larger tract and the remainder of the tract is no longer owned by the person or the person's surviving spouse from whom the lands were acquired, the lands shall be offered for conveyance to the person owning the remaining tract in the same manner and on the same terms as provided in subdivision 2.

Subd. 4. **Conveyance when remainder of tract has been divided into smaller tracts.**

or buses may be placed and maintained within the limits of any street or highway, including streets and highways within cities, when a license, permit or franchise therefor is first obtained from the road authority. The owners may place advertising on the benches and shelters if authorized by the license, permit or franchise, provided that advertising on shelters shall be limited to one-third of the vertical surface of the shelter. The benches shall not be placed or maintained on the portion of the highway or street prepared and maintained for vehicle traffic.

The council of any city may, by public negotiation or bid, grant franchises for the construction, operation or maintenance of bus shelters and benches on streets and highways within the city. The franchises shall be granted subject to terms and conditions as the city may prescribe, including the payment of compensation to the city. This provision does not preclude the requirement for obtaining permits from the appropriate road authority having jurisdiction for construction within the limits of any trunk highway, county highway, or county state-aid highway.

On streets and highways outside of cities, the road authority may, by public negotiation or bid, grant franchises for the construction, operation or maintenance of bus shelters and benches on streets and highways within the road authority's jurisdiction. The franchises shall be granted subject to terms and conditions as the road authority may prescribe, including the payment of compensation to the road authority.

Subd. 3. Outdoor telephone booths. (a) Outdoor telephone booths may be placed and maintained within the limits of any public highway, including city streets, when authorized by a written permit issued by the proper road authority.

(b) The governing body of a city or town may grant permission by license, permit, contract, or franchise to the owner of an outdoor telephone booth located within the right-of-way of a public highway or street to place advertising on the booth. This permission is subject to terms and conditions prescribed by the city or town. This paragraph does not preclude requirements for obtaining permits from the appropriate road authority having jurisdiction over a trunk highway, county highway, or state-aid highway.

Subd. 4. Customs inspection facilities. United States customs inspection facilities may be placed and maintained within the limits of any public highway, including city streets, when a written permit is issued for such facilities by the proper road authority.

Subd. 5. Misdemeanors. Except for the actions of the road authorities, their agents, employees, contractors, and utilities in carrying out their duties imposed by law or contract, and except as herein provided, it shall be unlawful to:

- (1) Obstruct any highway or deposit snow or ice thereon;
- (2) Plow or perform any other detrimental operation within the road right-of-way except in the preparation of the land for planting permanent vegetative cover;
- (3) Erect a fence on the right-of-way of a trunk highway, county state-aid highway, county highway or town road, except to erect a lane fence to the ends of a livestock pass;
- (4) Dig any holes in any highway; except to locate markers placed to identify sectional corner positions and private boundary corners;
- (5) Remove any earth, gravel or rock from any highway;
- (6) Obstruct any ditch draining any highway or drain any noisome materials into any ditch;
- (7) Place or maintain any building or structure within the limits of any highway;
- (8) Place or maintain any advertisement within the limits of any highway;
- (9) Paint, print, place, or affix any advertisement or any object within the limits of any highway;
- (10) Deface, mar, damage, or tamper with any structure, work, material, equipment, tools, signs, markers, signals, paving, guardrails, drains, or any other highway appurtenance on or along any highway;
- (11) Remove, injure, displace, or destroy right-of-way markers, or reference or witness monuments, or markers placed to preserve section or quarter section corners;

(12) Improperly place or fail to place warning signs and detour signs as provided by law;

(13) Drive over, through, or around any barricade, fence, or obstruction erected for the purpose of preventing traffic from passing over a portion of a highway closed to public travel or to remove, deface, or damage any such barricade, fence, or obstruction.

Any violation of this subdivision is a misdemeanor.

Subd. 6. Removal of unauthorized advertisements, buildings, or structures in or on a public highway. The road authorities may take down, remove, or destroy any advertisement, building or structure in or upon any highway in violation of this section.

History: 1959 c 500 art 1 s 27; 1973 c 123 art 5 s 7; 1977 c 334 s 1; 1979 c 275 s 1; 1980 c 435 s 1; 1980 c 533 s 2; 1986 c 387 s 1; 1986 c 398 art 27 s 2; 1986 c 435 s 1

160.271 MS 1957 [Repealed, 1959 c 500 art 6 s 13]

160.275 MS 1953 [Repealed, 1957 c 943 s 72]

160.276 TRAVEL INFORMATION FRANCHISE PROGRAM.

Subdivision 1. The commissioner of transportation shall establish a franchise program to lease space within tourist information centers and safety rest areas for the purpose of providing information to travelers through travel-related commercial and public service advertising.

Subd. 2. The program may, in its initial phase, utilize space within existing publicly owned buildings and shelters in safety rest areas and tourist information centers. This phase shall be operational by May 1, 1981. Franchises for this phase shall be ready to let by January 1, 1981.

Subd. 3. The program may also include franchises for the construction, operation and maintenance of additional information structures by and at the expense of the franchisee on state owned lands within safety rest or tourist information center areas. All structures constructed by the franchisee shall meet or exceed specifications prescribed by the commissioner of transportation and shall satisfy the requirements of the state building code for accessibility by the physically handicapped. All structures shall be designed to enhance their site and shall be aesthetically compatible with the natural environment.

Subd. 4. The commissioner shall determine the sites to be included in this program and shall also determine if the advertising display at each site is to be inside or outside of any buildings or shelters.

History: 1980 c 494 s 2; 1986 c 444

160.277 COMMISSIONER OF TRANSPORTATION TO GRANT FRANCHISES.

Subdivision 1. The commissioner of transportation, by public negotiation or bid, shall grant franchises for the purposes of section 160.276. Each franchise agreement shall include the safety rest areas and tourist information centers in a geographical area comprising approximately one-quarter of the land area of the state. The franchise agreement shall insure that the franchisee provide services throughout the area in as many tourist information centers and safety rest areas as are reasonably necessary for the convenience of travelers.

Subd. 2. The commissioner of transportation shall require the franchisee to obtain liability insurance in an amount prescribed by the commissioner jointly insuring the state and the franchisee against any and all liability for claims for damage occurring wholly or partly because of the existence of the franchise.

Subd. 3. The franchise agreement may provide that a percentage of the gross revenues derived from advertising shall be paid to the state for deposit in the trunk highway fund.

History: 1980 c 494 s 3

501.7 NON-COLLUSION AFFIDAVIT

Each bidder must submit a signed copy of the non-collusion affidavit (Form 25132) and a completed bid form (Form 2570). Each bidder must also submit along with his bid, a bid security deposit in the form of a certified check, cashier's check, or money order in the following amounts:

- A. Full amount of all bids of less than \$50.00
- B. In the amount of \$50 on all bids from \$50.00 to \$1,000.00.
- C. In the amount of five percent of the bid on all bids of \$1,000.00 or more.

501.8 PERFORMANCE BY SUCCESSFUL BIDDER

As required by the specifications governing the sale and removal of the property, which specifications are attached to and made a part of each bid form, the successful bidder must furnish all labor, material, and equipment, and perform all work required in the removal of the sold property from state-owned land. The successful bidder must also comply with all local ordinances pertaining to the removal and moving of buildings and other structures.

501.9 SALE OF PROPERTY TO PUBLIC EMPLOYEES

As provided by Minn. Stat. 15.054, public employees may submit bids for any surplus property, except real property, offered for sale by Property Management, provided the employee is not directly involved in the auction or sealed bid process.

501.10 SALE BY AUCTION

Sec. 16.07, Minnesota Statutes 1971, authorizes the sale of buildings by auction in lieu of sale by competitive bid. Structures shall be sold by auction when recommended by the Director, Office of Right of Way and by the Director, Real Estate Management Division, Department of Administration.

PROPERTY MANAGEMENT (5-491.500)**REAL ESTATE LEASING (5-491.502)****502.1 AUTHORITY**

Minn. Stat. 161.23, authorizes the Commissioner of Transportation to lease, for the term between the acquisition and subsequent sale thereof, for a rental rate and upon such terms and conditions as he deems proper, any excess real estate acquired in fee under Minn. Stat. 161.23; and, any real estate acquired in fee for trunk highway purposes, and not presently needed therefor.

502.2 NEGOTIATION OF LEASE

Leases are negotiated on one of three bases:

1. In the first instance, upon a written request from either the former owner, the former contract for deed purchaser, or the former tenant, the real estate may be leased back to the requesting party without advertising for bids.
2. In the second instance, if the real estate that was acquired was part of a larger tract, and if the remainder portion of the larger tract is no longer owned by the party from whom the State-owned real estate was acquired, the State-owned real estate may, without being advertised for bids, be leased to the party who is the successor in interest to the party from whom the State-owned real estate was acquired.
3. In the third instance, the real estate shall be lease only pursuant to sealed bidding procedures, with the lease being awarded to the responsible party submitting the highest sealed bid, correctly filled out on standard bid form, in response to an advertisement placed in a newspaper or trade journal having circulation in the area in which the property is located.

All advertising for bids, the preparation of bid forms, the opening of sealed bids and the awarding of the lease to the successful bidder, will be done under the supervision of the Acquisition Engineer, Right of Way Operations, in the Office of Right of Way in the Transportation Building, St. Paul. The sealed bids will be opened and read aloud in public view by the Property Management Supervisor or his designee.

The Director, Office of Right of Way, may enter into a lease directly, with a responsible entity, without first offering a lease in accordance with paragraphs 1, 2 and 3 above, upon his determination that, due to a special circumstance and a public benefit, the best interests of the Department of Transportation and the public would be served by such a lease. A statement, in writing, from the District Engineer, attesting to the circumstance and the benefit shall be attached to the Department's file copy of every lease executed according to this condition. The attachment shall be signed by the District Engineer. This procedure shall be used only when the circumstances clearly warrant.

502.3 PERIOD OF LEASE

The period of lease is determined by the Acquisition Engineer, Office of Right of Way, in concurrence with the respective District Engineer, in conformance with programmed contract letting dates. Leasing will be in accordance with Minn. Stat. 16.02, Subd. 14.

502.4 LEASING AMOUNT

The amount charged shall be comparable to the amount that a similar property, including agricultural land, in a similar location, could command in the open real estate rental market.

As a guide in establishing the amount of rent to be charged the tenant, annual rent may be set at eight percent of the amount which the State paid for the premises. Similarly, when the lease is advertised for sealed bids, consideration should be given to specifying a minimum bid for rent equal to eight percent of the amount which the State paid for the premises.

If the prospective tenant was a tenant at the time of the acquisition of the real estate by the State, the amount of rent that was being paid by the tenant to the former owner or contract for deed purchaser, may be used as a guide, in lieu of the percentage, in establishing the amount of rent to be paid to the State under the terms of a new lease.

If a lease is renewed to the same tenant for another term, the new rent shall be increased to reflect any general increase which has occurred in rental values. The consumer price index - residential rent may be used as a guide in determining the amount of rent increase.

If a former owner, contract for deed purchaser, or tenant at the time of the acquisition of the real estate by the State, is permitted to occupy the real estate on a rental basis for a short term or for a period subject to termination on a notice of less than 60 days, the amount of rent shall not exceed the fair rental value of the property to a short term occupier.

502.5 LEASE TO POLITICAL SUBDIVISION OR AGENCY OF THE STATE

Notwithstanding the above provisions of Section 502.2, Negotiation of Lease, and Section 502.4, Leasing Amount, to the contrary, real estate may be leased, for public purposes, to any political subdivision or agency of the State without advertising for bids. In such a case, the rental amount may be established by the Acquisition Engineer, Right of Way Operations, taking into consideration any benefit to the trunk highway system related to the proposed use of the real estate.

The State may lease to a non-profit corporation engaged in public service activities, without advertising for bids, if the lease is requested in writing by not only the non-profit corporation, but also an appropriate representative of the political subdivision in which the real estate is located. The rental amount may be established by the Acquisition Engineer in the same manner as provided in this section for a lease to a political subdivision.

502.6 CONDITIONS OF LEASE

The terms of the lease must provide for agreement by the lessee to:

- A. Use the property for certain stated purposes and in compliance with any and all laws, regulations and ordinances.
- B. Pay the rent and all utility bills in connection with the property when due during the term of the lease.
- C. Permit agents and employees of the State to enter leased premises during reasonable business hours for inspection purposes, surveying, or soil testing.
- D. Allow prospective bidders to view the property during reasonable business hours when property is offered for sale.
- E. The lessee shall not sublet the lease nor make any alteration of the property without written consent of the lessor.
- F. Pay the State all costs and expenses incurred in legal action to recover unpaid rent or possession of the property, or expenses due to any breach of agreement contained in the lease.
- G. Permit the State to take possession of the property on default in rental payments or agreements of the lease on part of the lessor.
- H. Surrender the property in as good order and condition as when lease began upon termination of the lease.
- I. Insure the property against fire, windstorm, comprehensive public liability, and other insurable risks as stated on the lease and maintain the insurance protection for the entire term of the lease. Provide proof of the required insurance protection to the State.
- J. Pay taxes, if any, assessed against the property during the terms of the lease.

502.7 TERMINATION OR EXTENSION OF LEASE

- A. The lease shall be subject to cancellation and termination by either party at any time during the term by giving the other party notice in writing at least sixty (60) days before the date when such termination shall become effective. In the event of such termination any unearned rental previously paid to the lessor shall be returned to the lessee. The rent shall be prorated as of the actual termination or vacation, whichever is later.
- B. The lessee indemnifies, saves, and holds harmless the State of Minnesota and any agents or employees thereof from all claims, demands, actions or causes of whatsoever nature or character, including but not limited to negligence on the part of the State of Minnesota, its agents or employees, arising out of or by reason of the lease of the property by the State to lessee.
- C. When tenancy is extended beyond the expiration date of the lease with consent of the state, it shall be considered a tenancy only from month-to-month, subject to all terms and conditions of the lease.
- D. The lease shall cancel and terminate any prior lease or agreement as of its effective date.

502.8 COLLECTION OF DELINQUENT RENT

- A. Upon notification by the Office of Finance that a tenant has become two or more months delinquent in the payment of his rent, Property Management shall send a letter to the tenant specifying the date by which all of the delinquent rent must be paid. Verbal contact with the tenant shall be made at this time by Property Management personnel, depending upon the tenant's history of making timely rent payments. The purpose of this verbal contact is to determine the tenant's reason for nonpayment and to attempt to bring him current without resorting to termination of the lease.
- B. If the tenant shows sufficient cause why he cannot make a lump-sum payment by the specified date, a rent pay-schedule shall be sent to the tenant providing for the payment of the delinquent rent in installments of sufficient amounts to reduce the arrearage within a reasonable period of time.
- C. If the tenant does not comply with the payment schedule, a notice of the termination of the lease shall be mailed to the tenant. An affidavit of mailing shall be made at this time and placed in the lease file.
- D. If the tenant fails to vacate the premises by the specified lease termination date, the matter shall be referred to the Office of the Attorney General, requesting that appropriate legal action be taken to secure the eviction of the tenant and to collect the delinquent rent.
- E. Property Management personnel shall assist the Office of the Attorney General as needed. Property Management personnel shall take steps to determine the tenant's ability to pay the delinquent rent and to ascertain whether the tenant has any assets which may be attached in the event a judgment is secured by the Office of the Attorney General.
- F. All mail correspondence with the tenant shall be sent by Certified Mail as required by the terms of the lease.

502.9 PAYMENT FOR REPAIRS TO RESIDENTIAL PROPERTIES

The State will pay for basic repairs which become necessary to keep a leased residence in a habitable condition. For example, payment will be made for repairs to (or replacement of) furnaces, water heaters, plumbing, etc.

Payment will not be made for painting or any repairs which are not necessary for maintaining the health or safety conditions of the premises.

This subsection applies only to leased residential properties and does not apply to commercial leases.

If the repair work does not present an emergency situation, the tenant will be required to get at least two estimates for any repair work over \$400.00 (excluding the cost of any fixture to be installed which has a readily verifiable or somewhat standardized cost, such as a water heater). One estimate is required for repair work under \$400.00. After reviewing the estimates, the Property Management Unit will notify the tenant to have the work done and that the approved amount will be paid by the State.

The tenant must make all arrangements for getting estimates and having work done.

A representative of the Property Management Unit will verify that the work is actually needed, and after being billed, that the work was actually done. The extent of such verification will take into account the nature and cost of the repair work. Documentation will be kept with the lease file.

Where the tenant has paid the contractor directly for work done, the Property Management Unit will send a request to the Office of Financial Management to credit the tenant's rent payment account in the amount paid by the tenant.

Where the tenant has not yet paid for the work done, the Property Management Unit will forward the invoice to the Office of Financial Management for payment.

PROPERTY MANAGEMENT (5-491.500)

PROTECTIVE PATROL AND GUARD SERVICE (5-491.503)

503.1 PURPOSE

The services of guards driving radio-equipped patrol cars and the services of on-site security guards may be procured by the Property Management Unit when needed to prevent vandalism and theft in state-owned vacant buildings located on land which has been purchased for highway purposes.

503.2 PROCUREMENT OF SERVICE

The Property Management Unit is responsible for preparing the necessary contract documents, securing bids, determining whether the protective services are to be by patrol car surveillance, by one or more on-site guards, or by a combination of these.

503.3 TERM OF SERVICE

Minnesota Statutes 1971, Section 16.07, Subd. 1, provides that standard requirement price contracts, for services to be purchased by the State when required or needed, shall not exceed two years but may include an option on the part of the State to renew for an additional two years.

503.4 DETERMINATION OF NEED

The Property Management Unit initially must determine in which area of the state the protective services will probably be required. It must then secure competitive bids from qualified guard and protective patrol organizations for work to be performed in a designated area. (Usually these services will be procured for protecting buildings in the Twin Cities Metropolitan area only.)

MISSISSIPPI

- Rules



MISSISSIPPI

MISSISSIPPI STATE HIGHWAY DEPARTMENT STANDARD OPERATING PROCEDURES			S.O.P. NO. MND-09-00-00-000 Page 5 of 8	
SUBJECT: RULES, REGULATIONS AND ORDINANCES GOVERNING USE OF STATE HIGHWAYS OF MISSISSIPPI				DISTRIBUTION A
EFFECTIVE May 15, 1968	ISSUED May 15, 1968	SUPERSEDES S.O.P. NO. EFFECTIVE	Page of Initial Distribution	APPROVED <i>J. C. K. [Signature]</i>

RULES, REGULATIONS AND ORDINANCES

1. No person, persons, firm, association, or corporation shall have, construct, reconstruct, erect, build, or have constructed, reconstructed, erected, or built any obstruction, building, improvement, fence, garage, filling station, barn, restaurant, or other structure on any part of any state highway or alter any part of the right of way of any state highway or the drainage thereat without permission from the Commission.

2. No person, persons, company or corporation shall have, construct, or have constructed a pipe line, telephone line, telegraph line, electric power line, street light or lighting device of any nature whether for public or private use on, over or under any part of a state highway before the following requirements have been complied with:

(a) The State Highway Department's standard application must be signed by the applicant.

(b) After the application has been properly signed and filed with the State Highway Department, plans of the proposed construction must be submitted for approval by the Engineer of Maintenance or the Chief Engineer of said Department.

(c) When the plans have been approved, a copy of the approved plan will be mailed the applicant as his authority to proceed with the construction. However, written notice should be given the State Highway Department twenty-four (24) hours in advance of the time actual work is begun.

3. No person, persons, firm, association or corporation shall have, construct, reconstruct, erect, build, place, or have constructed, reconstructed, erected, built or placed any portable, temporary or permanent billboard, advertising sign, advertising displays or junked vehicle bearing advertising matter or vehicles parked for the primary purpose of displaying advertising signs, upon the highways and rights of way thereof of this state which are under the jurisdiction of the State Highway Commission.

4. No person, persons, firm, association or corporation shall have, construct, reconstruct, erect, build, place or have constructed, reconstructed, erected, built or placed any temporary or permanent billboard, advertising sign or advertising display which is supported off the State Highway but extends from said support into and overhanging the right of way of any state highway.

22

MISSISSIPPI STATE HIGHWAY DEPARTMENT STANDARD OPERATING PROCEDURES			S.O.P. NO. MND-09-00-00-000 Page 6 of 8	
SUBJECT: RULES, REGULATIONS AND ORDINANCES GOVERNING USE OF STATE HIGHWAYS OF MISSISSIPPI			DISTRIBUTION A	
EFFECTIVE Apr. 1, 1987	ISSUED Apr. 1, 1987	SUPERSEDES S.O.P. NO. MND-09-00-00-000 EFFECTIVE May 1, 1970	Page 6 of 8 APPROVED <i>John R. Jabb</i>	

5. No person, persons, firm, association, or corporation shall have, place or have placed any vehicle, machinery, equipment or commercial wares, for sale or resale, upon the highways or right of way thereof of the State which are under the jurisdiction of the State Highway Commission.

6. Private or public roads or driveways will not be permitted to intersect with any portion of a state highway unless permission is secured in accordance with Section 2 above, and the construction is done in strict accordance with the plans approved by the State Highway Department.

7. No house-trailer shall be parked and no tent or other temporary residence erected on any portion of a state highway.

8. Plowing in or using any part of a state highway as a turnrow or diverting water into the road ditches in such a manner as to interfere with the drainage of or to cause damage to a state highway is prohibited.

9. No person, firm, corporation or association shall cut any trees, shrubs, or other vegetation or shall use chemicals to kill such growing on state highway right of way unless permission is first secured.

10. No motor vehicle shall be driven into or across the median of any state highway.

11. No vehicles shall be stopped or parked on the through lanes or on the shoulders adjacent to the through lanes of a controlled access facility; nor shall vehicles be stopped or parked on the lanes and adjacent shoulders or interchange connections between controlled access facilities and crossroads or cross streets; provided, however, that this shall not apply in cases of emergencies caused by mechanical failure, accident or disability of the driver.

12. The use of any controlled access facility by pedestrians, bicycles, hitchhikers, ridden or herded animals and animal drawn vehicles is prohibited. The use of any such controlled access facility by motor bicycles, non-motorized vehicles or any other vehicle unable to comply with the posted minimum speed limit is also prohibited.

13. No person, firm, corporation or association, shall remove, construct, rearrange or alter any curb, median, bridge, culvert or other appurtenance on any state highway unless permission is secured in accordance with Section 2 above.

14. It shall be unlawful for any person to throw or deposit or cause to be deposited on any state highway any dead animal, dirt, garbage, or rubbish as defined below:

SUBJECT: RULES, REGULATIONS AND ORDINANCES, GOVERNING USE
USE OF STATE HIGHWAYS OF MISSISSIPPI

DISTRIBUTION
A

EFFECTIVE

ISSUED

SUPERSEDES

Page 7 of 8

APPROVED

Apr. 1, 1987

Apr. 1, 1987

S.O.P. NO. MND-09-00-00-000

EFFECTIVE May 1, 1970

John R. Jallo

Dead Animals is defined as all dead animals or parts thereof, (including condemned meats) and not intended to be used as food.

Dirt is defined to include loose earth, ashes, manure from stables, corrals and pens, offal from butcher shops and slaughter houses, and all foul and filthy substances.

Garbage is defined to include solid or semi-solid kitchen refuse subject to decay, and market waste of animal and vegetable matter which has been or was intended to be used as food for man or animal.

Rubbish is defined as old tin and iron cans and containers, old automobiles, trucks or other vehicles, old wood and paper boxes, old metals, wire, rope, cordage, bottles, bags, bagging, rubber and rubber tires, paper and all used or cast-off articles or material, including old plaster, brick, cement, glass and all old building materials.

57

15. No part of any state highway shall be used by any person, firm or corporation for the purpose of servicing automobiles, trucks, tractors or other motor-driven vehicles with fuel, oil, grease, air for tires, water for batteries, water for radiators, wiping of windshields and other parts of such vehicle, changing of tires for doing repair work thereon, or rendering any other such services as are usually rendered at service stations nor shall any portion of any state highway be used for any other commercial purpose and all persons, firms and corporations are hereby prohibited from rendering any of the services enumerated to any such vehicle while the same is parked or standing on any part of any state highway, or using any part of any such state highway for any commercial purposes, and all persons, firms and corporations are hereby prohibited from parking or placing, or causing to be parked or placed any such vehicle on any part of any state highway for the purpose of receiving any of the services hereinabove enumerated; provided, however, that this shall not apply in cases of emergency where any such vehicle has run out of fuel, oil grease, or water, or suffered by other accident or casualty so as to make it necessary that such service be rendered on such state highway in order for said vehicle to reach a garage or service station.

16. No person, firm or corporation shall remove, change, damage or otherwise interfere with any signs, markers, posts, curbs, gutters or other structures or things, including any sign, marker, curb, post or other structure or thing placed therein for the purpose of confining traffic and use of said highway to that portion thereof set apart for that purpose, which have been placed on or in any state highway by the Commission or its agents.

SUBJECT: RULES, REGULATIONS AND ORDINANCES, GOVERNING USE
OF STATE HIGHWAYS OF MISSISSIPPI

DISTRIBUTION

A

EFFECTIVE

ISSUED

SUPERSEDES

Page 8 of 8

APPROVED

Apr. 1, 1987

Apr. 1, 1987

S.O.P. NO. MND-09-00-00-000

EFFECTIVE May 1, 1970

John R. Jabb

17. No person shall operate a vehicle at excessive speeds while passing highway maintenance crews, survey crews or construction crews which are engaged in maintenance survey or construction work upon the state highways and roadways thereof. When approaching said crews all drivers of motor vehicles shall slow to a reasonable and prudent speed in accordance with existing conditions at the work site. All drivers of vehicles shall obey the flagmen and signs directing traffic at each such work site.

Violations of the foregoing Rules, Regulations and Ordinances shall constitute a misdemeanor as set out in paragraph (d) and (f), Section 65-1-8, Mississippi Code of 1972.

58

MISSOURI

- Legislation



FIRST REGULAR SESSION

[TRULY AGREED TO AND FINALLY PASSED]

SENATE BILL NO. 397

83RD GENERAL ASSEMBLY

AN ACT

To repeal section 8.705, RSMo Supp. 1984, relating to blind persons having priority for operation of vending facilities on state property, and to enact in lieu thereof one new section relating to the same subject.

Be it enacted by the General Assembly of the State of Missouri, as follows:

Section 1. Section 8.705, RSMo Supp. 1984, is repealed
2 and one new section enacted in lieu thereof, to be known as
3 section 8.705, to read as follows:

8.705. 1. Blind persons shall be authorized to operate
2 vending facilities on any state property within this state in
3 a fair and uniform manner.

4 2. With respect to vending facilities on state property,
5 priority shall be given to blind persons. As used in sections
6 8.700 to 8.745, "state property" means all real property, or
7 part thereof, owned, leased, rented, or otherwise controlled
8 or occupied by any department, agency or body of this state
9 including roadside rest areas, except the department of
10 mental health, but does not include any of the following:

11 (1) A building in which less than one hundred state

12 employees are, or will be, located during normal working
13 hours;

14 (2) A building in which less than fifteen thousand
15 square feet of interior floor space is to be used for state
16 government purposes or in which services are to be pro-
17 vided to the public;

18 (3) A building to be occupied by state government
19 employees for less than three years.

✓

may be classified as advertising signs or unauthorized signs on or extending over on State right of way, vending, cultivation and fencing of the right of way, unauthorized construction of entrances on sections prohibiting access, and excavation or construction on right of way without an approved permit. The enforcement of this policy requires close supervision and good public relations on the part of all field personnel. Prevention or prompt removal of encroachments is required and all violations should be handled equally. No discrimination should be shown in the removal of political posters or any encroachment. Signs and other encroachments are private property and should not be unnecessarily damaged. They should be released to the owner upon proper request. In order to assist and to secure uniformity on the handling of most encroachments, "Encroachment Notice" forms have been approved.

ADVERTISING SIGNS

The most prevalent types of right of way encroachment are advertising signs and display materials of an advertising nature. These types of encroachment are prohibited by State law and no advertising signs or display material is permitted on or to extend over on State Highway right of way. This restriction is covered by Section 227.220 RSMo 1949, and has been interpreted to exclude all signs or display material other than standard Highway Department signs and markers. Streamers and banners are also considered as advertising display material. Maintenance Area Supervisors are responsible for the removal or reporting of violations within their area. Christmas decorations and Christmas lights are exempt from the above law and policy by Commission ruling.

BILLBOARD ERECTION FROM HIGHWAYS

Statutes authorize the erection of signs to prevent parking, except in emergency, on the shoulders of certain State Highways and where these no parking signs have been erected, advertising sign companies may be prohibited from parking vehicles on right of way when erecting signs back of the right of way line. Furthermore, these companies may be advised that all right of access, on freeway and interstate sections where obtained; has been granted by the property owners to the State Highway Commission and the owners are in no position to permit these companies or individuals, erecting signs, to cross our right of way lines.

VENDING ON HIGHWAY RIGHT OF WAY

Vending or the selling of merchandise on State Highway right of way is prohibited. Individuals vending on the right of way should be contacted and advised that such vending is prohibited. If requested, the State Highway Patrol will usually assist in the enforcement of this policy.

At areas where repeated violations exist, a "No Vending" sign, R11-7 should be erected to advise that vending is not allowed.

Sales stands for the sale of seasonal commodities such as fireworks, fruits, etc., during certain periods of the year must be kept off the right of way. If such stands, even though they may be off of State right of way, create a traffic hazard due to parking on the shoulder or on the right of way, "No Parking" signs may be erected. However, the "No Parking" restrictions cannot be enforced, outside municipal limits, on routes other than Freeway or Interstate routes without Commission action. Particularly troublesome areas can be restricted by Commission Resolution and are then enforceable by the Highway Patrol. Such action should be initiated by the District with a letter to the Division outlining the reasons for the requested action and the limits for which the restriction should apply. The Highway Patrol should be consulted concerning the proposed restriction and their concurrence should accompany the Districts request. Restrictions inside municipal limits must be covered by city ordinance to be enforceable.

REMOVAL OF ABANDONED VEHICLES

The removal of abandoned cars or other vehicles from State Highway right of way is by State law, a function of the State Highway Patrol or local law enforcement agencies. These

AGREEMENT

THIS AGREEMENT, made and entered into by and between the Missouri Highway and Transportation Commission, hereinafter called "Commission," and the Division of Family Services, Bureau for the Blind, hereinafter called "Bureau,"

WITNESSETH:

The General Assembly authorized the operation of vending facilities at roadside rest areas by blind persons in Senate Bill No. 397, approved July 16, 1985. The Bureau for the Blind proposes to arrange for the construction and operation of the vending facilities.

In consideration of the mutual covenants and promises contained herein, to be faithfully kept and performed by the parties hereto and each of them, it is agreed as follows:

1. Vending facility buildings may be constructed at Interstate Rest Areas in the counties of Holt, Davies, Lawrence, Franklin, Cape Girardeau, Montgomery, Platte, Clinton, Webster-Laclede, Pemiscot, Ste. Genevieve, Cooper, Atchison, Newton, Phelps, New Madrid, Warren and Lafayette. A vending facility building may also be constructed at the Tourist Information Center in Marion County.

2. The vending facility building shall be designed and constructed at no cost or expense to Commission.

3. The design of the vending facility building shall be compatible with existing rest area buildings in color and roof type. The Bureau shall submit the design to the Commission for approval prior to advertising for bids.

4. The Commission reserves the right to specify the location of the vending facility building at each rest area.

5. Bureau shall indemnify and save harmless Commission from damages or claims for damages arising as a proximate result of the negligence of Bureau, its agents or employees in connection with the construction or operation of the vending facilities.

6. Each vending facility shall contain two (2) canned soda machines, one (1) coffee machine and one (1) multi-snack machine. The vending of intoxicating beverages is prohibited.

7. Vending facilities must be operated in accordance with the Division of Health Rule Governing Food Service Sanitation, 13 CSR 50-61.010 and any revisions thereto.

8. All vending machines shall be serviced at least once per day and more often, as needed, during periods of high-usage. Commission and its employees will not assist in any operation or maintenance of the vending facilities including, but not limited to, coin changing, refunding money or opening and closing security gates.

9. Commission will not provide any security for or be liable for vandalism, accidents, electrical shortages or any other act or occurrence that causes damage to any vending facility, vending machine or vending machine product.

10. All vending facilities and vending machines shall be posted with a notice stating the facility is operated and maintained by the Bureau for the Blind and all claims and

complaints should be directed to the Bureau for the Blind, 619 East Capitol, Jefferson City, Missouri 65101, telephone number 314-751-3369. The notice shall further state the Missouri Highway and Transportation Department is not operating the facility and is not responsible for any loss or injury.

11. The Bureau shall reimburse Commission for the additional cost of electricity in the amount of Thirty and no/100 Dollars (\$30.00) per month per vending facility based on four vending machines per facility. This amount is subject to adjustment by Commission upon 30 days written notice if electrical rates increase. All checks should be made payable to the Director of Revenue - Credit State Road Fund. The Bureau shall make arrangements to pay the cost of utilities for the vending facility at the Tourist Information Center in Marion County to the Missouri Division of Tourism.

12. Commission reserves the right to remove vending facilities at Bureau's cost and expense if the facilities cease to be operated or are not operated in accordance with the provisions of this agreement or if necessary for rehabilitation of the facility or rest area.

13. After a period of two years if the presence of the vending equipment installed pursuant to this agreement, or the litter and refuse pick-up necessitated by the discard of containers from the vending equipment should substantially increase the cost of maintenance of the rest area or adjacent highway facilities by Commission, then Commission shall have the right to terminate this agreement.

IN WITNESS WHEREOF, the parties hereto have caused this agreement to be executed by their respective proper officials.

Executed by Bureau the 31st day of July,
1986

Executed by Commission the 1st day of August,
1986.

MISSOURI HIGHWAY AND
TRANSPORTATION COMMISSION

ATTEST: (SEAL)

By Wayne Muir
Chief Engineer

Mari Ann Winters
Secretary

APPROVED AS TO FORM:

Jana K. VanHorn
Counsel

By W. A. Sinyoff
Director
Division of Family Services



NEVADA

- Legislation
- Examples



NEVADA

408.210 Powers of director: Closing and construction of highways; removal of encroachments.

1. The director may restrict the use of, or close, any highway whenever he considers the closing or restriction of use necessary:

(a) For the protection of the public.

(b) For the protection of such highway from damage during storms or during construction, reconstruction, improvement or maintenance operations thereon.

(c) To promote economic development or tourism in the best interest of the state or upon the written request of the executive director of the commission on economic development or the commission on tourism.

2. The director may:

(a) Divide or separate any highway into separate roadways, wherever there is particular danger to the traveling public of collisions between vehicles proceeding in opposite directions or from vehicular turning movements or cross-traffic, by constructing curbs, central dividing sections or other physical dividing lines, or by signs, marks or other devices in or on the highway appropriate to designate the dividing line.

(b) Lay out and construct frontage roads on and along any highway or freeway and divide and separate any such frontage road from the main highway or freeway by means of curbs, physical barriers or by other appropriate devices.

3. The director may remove from the highways any unlicensed encroachment which is not removed, or the removal of which is not commenced and thereafter diligently prosecuted, within 5 days after personal service of notice and demand upon the owner of the encroachment or his agent. In lieu of personal service upon that person or his agent, service of the notice may also be made by registered or certified mail and by posting, for a period of 5 days, a copy of the notice on the encroachment described in the notice. Removal by the department of the encroachment on the failure of the owner to comply with the notice and demand gives the department a right of action to recover the expense of the removal, cost and expenses of suit, and in addition thereto the sum of \$100 for each day the encroachment remains beyond 5 days after the service of the notice and demand.

4. If the director determines that the interests of the department are not compromised by a proposed or existing encroachment, he may issue a license to the owner or his agent permitting an encroachment on the highway. Such a license is revocable and must provide for relocation or removal of the encroachment in the following manner. Upon notice from the director to the owner of the encroachment or his agent, the owner or agent may propose a time within which he will relocate or remove the encroachment as required. If the director and the owner or his agent agree upon such a time, the director shall not himself remove the encroachment unless the owner or his agent has failed to do so within the time agreed. If the director and the owner or his agent do not agree upon such a time, the director may remove the encroachment at any time later than 30 days after the service of the original notice upon the owner or his agent. Service of notice may be made in the manner provided by subsection 3. Removal of the encroachment by the director gives the department the right of action provided by subsection 3, but the penalty must be computed from the expiration of the agreed period or 30-day period, as the case may be.

(Added to NRS by 1957, 669; A 1967, 824; 1969, 95; 1979, 1766; 1985, 619)

408.507 Lease or rental of property.

1. Real property held in fee or improvements on the property acquired by the department in advance of the actual construction, reconstruction or improvement of highways or in order to avoid the payment of excessive damages, or held by the department pending a determination in the future on its use or disposal may be leased or rented by the department for fair market value in such manner and for such periods as are determined by the director to be in the best interests of the state.

2. The director may lease for fair market value space above and below the established grade line of the highway to state and public agencies and private persons in such manner and for such periods as he determines are in the best interest of the state, if:

(a) The full use and safety of the highway will not be impaired;

(b) Vehicular or pedestrian access to that space will not be required or permitted from the established grade line; and

(c) The free flow of traffic on the highway is not interfered with in any way.

3. All leases of an interests in real property entered into by the department before April 1, 1985, are hereby ratified. All other leases entered into pursuant to subsection 2 must be approved by the board subject to the provisions of subsection 4.

4. If the department receives a proposal to negotiate a lease pursuant to subsection 2, it shall publish a notice in a newspaper of general circulation at least once a week for 2 weeks, stating that it has received the proposal and that it will receive other proposals for use of the space for 60 days after the completion of the publication. A copy of the notice must be mailed to each local governmental unit in the affected area. If the property is leased, it must be to the highest bidder for the space. The requirements for publication and notice do not apply if the proposal was received from an owner who controls the property on both sides of the highway.

5. All money received for leases and rentals must be deposited with the state treasurer to be credited to the state highway fund.

(Added to NRS by 1957, 692; A 1971, 1330; 1979, 1780; 1983, 416; 1985, 706)

408.513 Acquisition of property by towns and cities; costs; transfer of interest to state.

1. When highways are constructed, reconstructed or improved in accordance with this chapter through towns and through cities, the department may require such towns and cities to acquire, through their governing bodies, and such towns and cities shall acquire in the name of the state, such real property, interests therein or improvements thereon for such highways as are determined to be necessary by the department in the same manner as if the property were being acquired by the state.

2. The cost of acquisition may be shared by such town or city and the department or may be paid for wholly by such town or city in accordance with agreements which shall first be entered into between the governing body of such city or town and the department.

3. With respect to real property, interests therein or improvements thereon held in the name of towns and cities, the local governing body may, by conveyance in the nature of quitclaim, transfer such interest to the state in accordance with the agreements which shall first be entered into between such governing bodies and the department.

(Added to NRS by 1957, 692; A 1975, 665)—(Substituted in revision for NRS 408.990)

**TERMS AND CONDITIONS
RELATING TO
RIGHT-OF-WAY OCCUPANCY
PERMITS**



**STATE OF NEVADA
DEPARTMENT OF TRANSPORTATION**

1986

A-171

INDEX

	PAGE
I Definitions.....	5
II General Requirements Regarding Preparation and Submission.....	6
III General Provisions.....	9
IV Underground Utilities.....	15
V Overhead Utilities.....	18
VI Driveways, Approaches and Street Intersections.....	20
VII Pavement Widening for Left Storage Lane.....	21
VIII Concrete Curbs, Gutters, Sidewalks and Wheelchair Ramps.....	22
IX Mailboxes.....	23
X Landscaping.....	25

I DEFINITIONS

All Right-of-Way Occupancy Permits issued by the Department of Transportation to private or publicly-owned facilities, relating to approaches, intersections, poles, wires, cables, overhead structures, pipes, conduits, manholes, miscellaneous facilities, railroad crossings, and minor work are subject to all of the terms and conditions, except as otherwise specifically provided on page 2 of the permit.

For the purposes of this permit, the following definitions shall apply:

1. **Department:** The State of Nevada, acting by and through its Department of Transportation.

2. **District Engineer:** The senior officer of an engineering district of the Department or his authorized representative in whose district the activities contemplated by the permit occur.

3. **Permittee:** The corporation(s), person(s), entity(ies), or their agents to whom this permit may be issued.

4. **Permit:** Right-of-Way Occupancy Permit issued pursuant to the provisions of NRS 408.423 and NRS 408.210.

5. **Terms and Conditions:** Standards for permit work.

II GENERAL REQUIREMENTS REGARDING PREPARATION AND SUBMISSION

I. Fees

Fees will be charged for the processing of Right-of-Way Occupancy Permit applications as specified in NRS 408.423. The fees are nonrefundable once processing of the Right-of-Way Occupancy Permit application has commenced, even if the permit application is denied, or if issued, subsequently revoked. In the event a permit is issued but the encroachment is not constructed within the prescribed period, the permit will be revoked and a new processing fee required for reapplication.

<i>Category</i>	<i>Description</i>	<i>Minimum Fee</i>
I.....	Underground installations, including but not limited to telephone, gas, sewer, electric lines, water lines, storm drains, traffic signal appurtenances, television cables, street light circuits.....	\$200.00
II.....	Aerial installations, including but not limited to electrical and telephone lines, television cables, fire alarm cables.....	\$100.00
III.....	Highway access approach or driveway for family residence or rural, low-density use (less than 100 ADT).....	\$ 50.00
IV.....	Highway access approach or driveway for commercial traffic, includes two openings.....	\$100.00
V.....	Permits related to subdivision or large commercial developments including but not limited to roadway widening, turning lanes, acceleration-deceleration lanes, curb, gutter, sidewalk, drainage structures, approaches, street lights, traffic signals, adjustment of roadway safety features.....	\$400.00
VI.....	Miscellaneous, including but not limited to chain installers, bike paths, awnings, fences.....	\$ 50.00

Any permit, regardless of category, requiring an abnormally great amount of engineering or inspection will be charged actual cost based on the Department's direct and related indirect costs.

Local governmental entities and other state agencies, when working on their own systems, and not performing work necessitated by or on behalf of a new development, are exempt from the fees.

Completed permits shall be submitted with fees to the appropriate district engineer.

2. Plans

The PERMITTEE must attach four complete sets of detailed plans, drawings or maps. No permit will be processed without detailed plans which must, at a minimum, show:

A. The highway alignment, including centerline, and right-of-way lines, including mileposts and or highway engineering stationing, in relation to the proposed work.

B. Color coding (with legend) showing the facilities to be installed, removed, abandoned and or adjusted.

C. Directional orientation, i.e., north arrows, tangent bearings, etc., drawn to engineering or architectural scale.

D. Highway right-of-way widths, boundaries, relevant property lines, and significant topographic features.

E. Profile or cross section drawings showing an elevation view of proposed overhead utility or underground utility or drainage installations in relation to the highway.

F. Location of existing facilities, if changes, extensions or additions to the existing facilities are proposed.

3. Traffic Control Plan

A traffic control plan showing the location of signs, barricades, flagmen and other devices to protect the motoring and pedestrian traffic during construction, is required when applicable or when required by the Department.

4. Traffic Impact Report

A traffic impact report is required for all driveway and/or street permits which serve major traffic generators. These reports will be prepared by competent professional engineering staffs, which possess the expertise in planning and traffic engineering functions.

The traffic impact report for major traffic (100 or more vehicles per hour generated during the peak hours) shall contain the following:

A. Identify all points of access, existing and proposed, and tie to existing highway stationing. This shall include all accesses on both sides of the highway for the length of the proposed development.

B. State the type and extent of the proposed development including planned future expansion.

C. Provide a site plan including building location, driveways, internal traffic network and parking areas.

D. An analysis of existing traffic conditions including information or abutting access routes with respect to number of lanes and available right-of-way. Traffic counts at critical intersections during peak hours shall be included. Data on queues from nearby controlled intersections shall be included.

E. Anticipated traffic to be generated by the proposed development shall be developed and analyzed. This shall include directional distribution, and critical hour turning volumes for site traffic at each approach and surrounding critical intersections. Identify how projected site traffic volumes were developed.

F. The report shall provide a traffic impact and capacity analysis of the development's traffic on the existing traffic network. The report shall demonstrate that adequate means are provided under the proposed permit to accommodate all site traffic within the roadway systems.

G. Only approved design capacity analysis methods will be used. Planning techniques for capacity analysis will not be acceptable. In most cases, total build out site peak hour traffic volumes will be combined with existing roadway traffic in determining traffic impact. Future roadway traffic combined with site traffic may be required in special cases.

H. In summary, the report shall provide levels of service at all critical existing intersections and existing driveways using present peak hour volumes. A second capacity analysis shall be made at all critical intersections and driveways, including site driveways and/or streets using existing peak hour volumes. Any additional lanes, traffic control devices or channelization required shall be identified and a third capacity analysis shall be made to determine the effects of those measures. The

summary of the report shall develop the detailed recommendations with respect to improvements by location and type to handle the impact of the development traffic.

5. *Drainage Plan*

A drainage plan and run-off calculations shall be submitted for any development or construction impacting the highway right-of-way. These calculations shall include peak run-off for existing and proposed development conditions should the land usage be appreciably altered. Existing flow patterns at the highway shall be perpetuated and any proposed changes to a highway drainage system by the PERMITTEE must be supported by drainage calculations. Provisions shall be made for the attenuation of peak flows which may have been increased due to the effects of the development.

6. *Cultural Resources Survey*

Those encroachments requiring cultural resources actions will be noted under the additional terms and conditions section of the Right-of-Way Occupancy Permit and more detailed requirements shall be appended to the permit. If a cultural resources survey is required, a report must be prepared and appropriate mitigating processes conducted for all encroachments to be placed longitudinally within previously undisturbed portions of Department of Transportation right-of-way and for lateral crossings or approaches requiring significant disruption of previously undisturbed portions of Department of Transportation right-of-way.

7. *Approval From Local Agencies*

The PERMITTEE, in addition to obtaining the Right-of-Way Occupancy Permit, must also obtain any and all other permits required by State law or local ordinances.

III GENERAL PROVISIONS

1. *Permittee Shall Be Liable for Damages*

The PERMITTEE agrees to indemnify and save harmless the State of Nevada and its officers, agents, and employees against any and all liability, loss, damage, cost, and expense which it or they may incur, suffer, or be required to pay by reason of death, disease, or bodily injury to any person or persons, or injury to, destruction of, or loss of use of any property, including property belonging to the State of Nevada, arising out of or incident to activities contemplated by this permit, and proximately caused, in whole or in part, by any act or omission of the PERMITTEE, or its contractors, agents, or the employees of any one or all of them, **OR BY THE OFFICERS, AGENTS, OR EMPLOYEES OF THE STATE OF NEVADA**, unless it is established by the PERMITTEE that the proximate cause was the willful misconduct or gross negligence of the officers, agents, or employees of the State of Nevada.

2. *Subject to Prior Permits*

This permit is issued subject to all prior valid and existing permits, agreements, contracts, leases, liens, reservations, conditions, encumbrances, or claims of title which may affect the property covered by this permit and PERMITTEE is responsible for obtaining consent from any underlying fee owner in the event the Department does not own the full fee simple interest in the right-of-way.

3. *Revocation*

The terms, conditions, and general provisions of this Right-of-Way Occupancy Permit are **revocable**, or subject to modification or abrogation by the State of Nevada, **at any time**, without prejudice to prior rights, including those evidenced by any joint use agreements, franchise rights, or reserved rights for operating purposes in a grant of a highway easement. In the event of revocation, the PERMITTEE shall, at the direction of the district engineer, remove any or all encroachments installed or constructed pursuant to this Right-of-Way Occupancy Permit, and shall restore the right-of-way to its pre-existing condition.

4. *Acceptance of Provisions*

The performance of **ANY** work contemplated by this permit shall constitute an acceptance by the PERMITTEE of **ALL** the provisions and terms of this permit and **ALL** work shall be prosecuted diligently until completion. **ALL** work authorized by this permit shall be completed within one year from the date of issuance hereof, or this permit will be revoked; except upon written request, if warranted, the PERMITTEE may be given an extension not to exceed 90 days beyond the one year of the approved submitted schedule of completion.

5. *Future Moving of Installation*

Facilities erected or installed in the exercise of the privilege granted remains subject to relocation or removal under the encroachment provisions of paragraphs 3 and 4 of Nevada Revised Statute 408.210.

6. Plan Changes

The PERMITTEE must obtain prior written approval from the district engineer before making any changes from the approved plans and/or method. Should any change in the plans be approved, the PERMITTEE shall submit "as built" drawings delineating the change within 30 days after the date of completion in triplicate.

7. Permit Transfer

PERMITTEE may not transfer, convey, or assign this permit, or any privilege or responsibility contained herein pertaining to actual work to be accomplished within the right-of-way without prior written approval of the Department. PERMITTEE will insure, however, that his continuing responsibility for the upkeep and repair of any facility erected or installed in connection with this permit will be transferred to his successors in interest or assigns, should this permit be approved. PERMITTEE is solely responsible for performance of the work authorized herein.

8. No Precedent Established

Right-of-Way Occupancy Permits are issued with the understanding that any particular action is not to be considered as establishing any precedent on the question of the expediency of permitting any kind of right-of-way occupancy to be erected within right-of-way of state highways, or as to any utility, of the acceptability of any such permits as to any other or future situation.

9. Notice Prior to Starting Work

The PERMITTEE shall notify the district engineer 48 hours prior to commencing work, and shall immediately notify the district engineer upon completion of work.

10. Location of Utilities

PERMITTEE shall arrange for having any and all utilities located within the construction area by contacting the "one-call" location service at 1-800-227-2600, at least 48 hours prior to commencing work hereunder.

11. Working Days

No work shall be performed by the PERMITTEE on Saturdays, Sundays, or holidays or during hours of darkness without the prior written approval of the district engineer.

12. Posting Permit

The Right-of-Way Occupancy Permit, or a conformed copy, shall be kept at the site of the work and must be shown to any representative of the Department of Transportation or any law enforcement officer on demand. WORK SHALL BE SUSPENDED IF THE PERMIT IS NOT AT JOB SITE AS PROVIDED.

13. Inspection and Approval by Department

A final inspection of the work accomplished by the PERMITTEE shall be performed by the district engineer to insure that the PERMITTEE has complied with the terms of this permit. Periodic inspections by the district engineer during the progress of work may be made to insure conformance to the Department's standards and those specified by this permit.

14. Expense of Inspection

For complex or extensive work under this permit, the Department may require a full-time inspector to observe the progress of work in its entirety. In such case, the PERMITTEE agrees to compensate the Department for the direct and indirect costs of inspection, such as but not limited to, wages, mileage, per diem and overhead costs incurred by said inspector in connection with such inspection.

15. Standards of Construction

All work performed under this permit shall be in accordance with the current editions of the State of Nevada Standard Specifications for Road and Bridge Construction, the Standard Plans for Road and Bridge Construction, National Electrical Safety Code and the State of Nevada Department of Transportation Manual on the Accommodation of Utilities, and shall be accomplished to the satisfaction of the district engineer. All construction shall be in conformance with the requirements, rules, and regulations of the Nevada Public Service Commission, the State Industrial Insurance System and the State Labor Commission. Copies of all applicable standard plans and specifications are available upon request from the district engineer.

16. Open Trenches, Pits, and Vertical Pavement Dropoffs

The PERMITTEE shall not allow trenching or excavations within the limits of the right-of-way to remain open on any instance during the hours of darkness or on Saturdays, Sundays, or holidays. During such periods, trenching or excavations shall be either backfilled to surrounding grade or completely covered with steel plating or other suitable material. With the prior concurrence of the district engineer that such measures are impracticable, the PERMITTEE may instead erect sound and substantial fencing or barricades completely around the periphery of such trenching or excavations. The district engineer may at any time direct the PERMITTEE to take more stringent measures as circumstances warrant.

17. Protection of Traffic

During the construction operation, the PERMITTEE shall cause to have installed and maintained as a protection to the public, proper barricades, warning and directional signs, flags, fusee, or other protective devices. Flagmen on each side of the work area shall be provided as required during construction operations to slow and direct traffic around work. Such safety measures shall conform with the provisions of The Manual of Uniform Traffic Control Devices for Streets and Highways (U.S. Department of Transportation, Washington, D.C.). All flagmen must have a valid flagman's certification card in their possession when flagging.

18. Minimum Interference With Traffic

Any work incidental to the scope of this permit, but not specifically provided for herein, and which may affect public safety, shall be performed in such a manner as to insure a minimum of danger, delay, or inconvenience to the public, or as may be directed by the district engineer.

19. Storage of Material

The PERMITTEE shall not allow excavated material, equipment, and materials to remain upon the traveled way or roadway prism during the hours of darkness or on

Saturdays, Sundays, and holidays. The PERMITTEE shall be responsible to insure that all such equipment and materials are situated, after each work shift, no less than 30 feet from the outside edge of the traveled way and no less than 15 feet outside the back face of the curb, whichever the case may be.

20. Care of Drainage

Construction grading shall be performed by the PERMITTEE in such a manner that the roadway drainage ditch or any natural water course which feeds existing drainage facilities will not be blocked or the free flow hindered at any time. Should the necessity arise to accommodate drainage water, culvert pipe of the size and length and at the location prescribed by the district engineer shall be installed by the PERMITTEE.

21. Permittee Shall Patch Pavement and Maintain Patches

PERMITTEE shall replace all removed paving **daily** with premix, and shall place the final paving course within 7 days after completion of work, and **SHALL BE RESPONSIBLE FOR MAINTAINING THE RESTORED PAVED AREAS UNTIL SUCH TIME AS THEY ARE OVERLAID OR RECONSTRUCTED BY THE STATE OF NEVADA.** In the event of settlement in the area of the patched surface, the district engineer may require the PERMITTEE to **repatch** the disturbed area to correct the problem. Failure by the PERMITTEE to do so may result in necessary replacement and repairs by the State of Nevada, in which case, the PERMITTEE shall pay the State of Nevada for the actual direct and related indirect costs incurred by the State of Nevada in performing the replacement or repairs.

The PERMITTEE shall assure that any pavement to be displaced is cut and removed in neat and straight lines. Trenching shall be performed in such a manner as to prevent breaking of the pavement edge adjacent to the trench. Paving shall be replaced by the PERMITTEE true to line and grade, and shall extend at least 18 inches on either side of the trench. The paving mix and thickness of PERMITTEE's mix shall be approved by the district engineer and in no instance shall the depth be less than 3 inches, or less than that of the existing asphaltic pavement, whichever is greater.

22. Removal or Trimming of Trees

The PERMITTEE shall not cut, trim, mutilate, remove, or disturb in any manner, brush, shrubs, trees, or other flora now located within the highway right-of-way, and/or highway planting easement, or which hereafter may be planted or grown therein, except as approved or directed by the district engineer.

23. Damage to Tree Roots

No tree roots over 2 inches in diameter shall be cut when trenching or other underground work is necessary adjacent to roadside trees. The roots that are 2 inches or more in diameter shall be carefully tunneled under and wrapped in burlap and kept moist until the trench is refilled. Trenching machines may not be used under trees if the trunk or limbs will be damaged by their use. If the trees involved are close together and of such size that it is impractical to protect all roots over 2 inches in diameter, special arrangements may be made whereby pruning of the tree tops to balance the root loss can be done by the PERMITTEE under the close supervision of the district engineer. Manholes shall not be installed within 20 feet of any tree trunk.

24. *Damage to Highway Property*

Any highway appurtenances, including fences, disturbed or destroyed by reason of this permit shall be restored to equal or better condition by PERMITTEE. Cattle guards or other devices to restrain livestock shall be installed by the PERMITTEE as directed by the Department and so noted in the additional terms and conditions section of the permit. The entire work area within the right-of-way shall be cleared of construction debris and restored to its original condition prior to acceptance of the work by the district engineer.

25. *Survey Markers*

Any permanent survey or right-of-way marker or monument disturbed or obliterated in construction of the right-of-way occupancy must be permanently reestablished by a registered land surveyor and a record made thereof.

26. *Permittee Shall Be Responsible for Maintenance*

The PERMITTEE agrees, by accepting this permit, to properly maintain and repair any structure, sidewalk, driveway, utility, or other encroachment constructed or placed within the right-of-way of any state highway, and to inspect the area included by the permit at reasonable intervals to determine that necessary maintenance is performed in a timely manner. PERMITTEE understands and agrees that this maintenance responsibility shall continue until this permit is revoked, or until the PERMITTEE removes the encroachment, and restores the right-of-way to its pre-existing condition.

PERMITTEE understands and agrees that the district engineer may require the PERMITTEE to make needed repairs or properly maintain the encroachment. Failure by the PERMITTEE to do so may result in necessary repairs or maintenance by the State of Nevada, in which case, the PERMITTEE shall pay the State of Nevada for the actual direct and related indirect costs incurred by the State of Nevada in performing the repairs or maintenance.

27. *Emergencies*

Any PERMITTEE who lawfully maintains a right-of-way occupancy in, under, or over any state highway may enter in or upon any state highway right-of-way to perform emergency repairs on PERMITTEE's facilities. PERMITTEE shall notify the district engineer of any emergency repairs as soon as possible, and shall immediately address a confirming letter to the district engineer stating the work to be done.

28. *Control of Access Highways*

Maintenance shall not be allowed within the control of access of a controlled access highway without providing at least 48 hours notice to the district engineer.

In the case of emergency maintenance involving control of access highways the utility shall immediately correct the problem and notify the district engineer of its action as soon as practicable.

29. *Standards of Construction*

All work performed under the routine or emergency maintenance provisions of this permit shall conform to the Standard Specifications for Road and Bridge Construction and the Standard Plans for Road and Bridge Construction.

30. *Permittee Shall Be Responsible for Costs of Enforcement*

PERMITTEE agrees to pay all necessary expenses, including reasonable attorney's fees, incurred by the State of Nevada to enforce any provisions of this permit.

IV UNDERGROUND UTILITIES

1. Crossing Roadway

Pipes shall normally be jacked or otherwise forced underneath pavement without disturbing same. Pavement or roadway shall not be cut unless specifically allowed by the permit. Service pipes will not be permitted inside culverts used as drainage structures. No hydraulic or wet boring is allowed.

2. Limit of Excavation

No excavation is to be made closer than 6 feet from the edge of the pavement except as may be specified in the permit.

3. Depth of Pipes

There shall be a minimum of 36 inches of cover over all pipes or conduits, except as may be specified by the permit.

4. Backfilling

Trenches shall be backfilled by the PERMITTEE with granular backfill or other acceptable material to the elevation of the bottom of the existing base and surfacing (subgrade) as prescribed by the Nevada Department of Transportation Standard Specifications. Backfilling of the base area shall be made with type 2 gravel or equivalent material. PERMITTEE shall remove and dispose of all excess material immediately after backfilling. All backfill shall be placed in uniform layers not exceeding 8 inches in loose thickness before compaction and shall be compacted to 90 percent of maximum material density.

5. Pipes Along Roadway

Except as hereinafter provided in paragraph (C) of this subsection, all installations of underground pipes and conduits in the highway right-of-way shall be marked and designated as follows:

A. All new installations of underground crossovers, except service laterals: where no curbs exist, a 4-inch by 4-inch timber or standard utility company marker shall be installed and maintained by PERMITTEE outside the ditch line at locations satisfactory to the district engineer. Such timber or marker shall extend 30 inches above the ground and have stenciled thereon the nature of the underground obstruction and the name or identifying symbol of the PERMITTEE. Where curbs exist, the cross over shall be identified by description and name of owner stenciled on curb in black letters on white background in a compact and legible manner.

B. All new longitudinal installations: where no curbs exist, 4-inch by 4-inch timbers or standard utility markers shall be placed adjacent to the conduit or offset to such a distance as may be specified and at intervals not to exceed 1,000 feet, at each angle point, or where nonconcentric with the highway, at least every 300 feet. Where the encroachment is located in the traveled way, timber or other suitable markers shall be placed at an offset outside the ditch line at locations satisfactory to the district engineer with an offset distance given. Where curbs exist, the information shall be visible and permanently marked or monumented on the curb near each intersection.

C. Exceptions. In incorporated cities where the installation is in accordance with ordinances, other regulations, or established practices, it will not be necessary to mark or designate said facilities as required above unless dictated by federal directive. All installations covered under this section shall be placed or constructed in such a manner as not to constitute a hazard to the traveling public.

6. Casings

Casings shall be designed to support the load of the highway and superimposed loads thereon and, as a minimum should equal the structural requirements for highway drainage facilities. Casings shall be composed of materials of satisfactory durability under conditions to which they may be exposed.

7. Jacking or Boring

Bore holes or pits may be placed within 35 feet of the edge of shoulder under the following conditions:

A. Bore holes or pit areas shall be completely fenced.

B. PERMITTEES and/or their contractors will not be permitted to use any portion of the rights-of-way for their operations, except in the fenced areas, or as permitted by the district engineer.

C. Access to bore holes or pit areas will not be permitted from the traveled portion of the highway.

D. Bore holes or pits will not be permitted within the median area of a highway except as authorized by the district engineer. Extreme care must be taken during this operation to guard against the impairment of the earth structure under the pavement and shoulders.

E. Any voids created by the boring operation outside the casing shall be pressure grouted.

8. Trenching

Trenching may be allowed if deemed necessary in the opinion of the district engineer. Trenched areas of pavement shall be patched in accordance with the Standard Plans for Road and Bridge Construction. See details for method of patching attached to permit. Trenching will generally not be allowed unless at least one of the following conditions is evident:

A. The roadway is scheduled for overlay or reconstruction within the forthcoming two years.

B. The roadway surface is in such poor condition that a permanent pavement patch will not detract from the existing roadway surface quality.

C. The PERMITTEE has attempted to bore the crossing and found it impractical due to subterranean conditions.

9. Routine Inspection and Maintenance of Underground Utilities

PERMITTEE may inspect and repair underground utilities, including manholes, conduits, cables and pipelines. PERMITTEE may open existing manholes to repair underground utilities and uncover not more than 50 feet of cables or lines buried in earth portions of highway right-of-way. Where existing manholes lie within the improved surfaces of the highway, the PERMITTEE will provide adequate protection of traffic in accordance with the permit or as directed by the district engineer. No excavation shall be

made in improved surfaces, landscaped areas or closer than 6 feet to the edge of pavement without a special permit, except in emergencies.

10. *Emergency Repairs*

PERMITTEE may make emergency repairs by excavating through improved surfaces only when breaks in the lines, conduits or cables under the pavement present a hazard to traffic or a serious interruption of essential service. In such cases the district engineer shall be notified immediately. Backfill and pavement replacement shall be performed in accordance with the Standard Specifications for Road and Bridge Construction. Landscaped areas which are disturbed shall be relandscaped at PERMITTEE's expense.

11. *Service Connections*

These terms and conditions do not authorize the continuous installation of gas or water service connections within state highway right-of-way, regardless of location of main. All new pipe services, main extensions, or excavation to abandon services must be covered by individual permits.

V OVERHEAD UTILITIES

1. *Conformance With Code*

The PERMITTEE shall insure that when installing aerial and underground electrical or communication lines, the clearances and method of construction shall be in accordance with the safety rules for the installation and maintenance of electrical supply and communication lines as set forth in the National Electrical Safety Code and the Nevada Department of Transportation Manual on the Accommodation and Installation of Utilities.

2. *Permission From Property Owners*

The PERMITTEE must secure permission, if needed, from abutting property owners prior to starting work.

3. *Guy Wires*

No guy wires are to be attached to trees except as may be specified in the permit and in no event shall they be so attached as to girdle the tree or interfere with its growth. Guy wires shall be kept at a minimum elevation above ground as directed by the district engineer.

4. *Remove Old Poles, Guys, and Stubs*

The entire length of old timbers shall be removed from the ground and the holes backfilled and thoroughly tamped.

5. *Vertical Clearance Over Roadway*

Aerial crossings shall conform to the requirements of the National Electrical Safety Code (per American National Standards Institute, ANSI).

The minimum vertical clearance for highway crossings shall be 18 feet for communications lines, 22 feet for electrical lines and 17 feet 6 inches for walkways. This measurement shall be from the highest point of the roadway prism to the lowest point of the installation crossing.

6. *Crossings*

Crossings shall be made at or as near to 90 degrees as possible across the roadway. Poles supporting crossings shall be, as a minimum, located outside the "clear zone" as prescribed by the AASHTO Guide to Selecting, Locating and Designing Traffic Barriers, 1977, and addendums thereto, and whenever possible will be located at the right-of-way line. In the case of divided highways, poles are not to be placed within the median strip unless the median strip is at least 80 feet in width and the median pole is absolutely necessary to support the crossing.

7. *Longitudinal Installations*

Poles shall be placed at or as near the right-of-way as possible. New utilities will not be permitted to be installed longitudinally within the control of access lines of any freeway, except that in special cases such installations may be permitted under strictly controlled conditions. However, in each such case the utility owner must show that:

- A. The accommodation will not adversely affect the safety, design, construction, operation, maintenance or stability of the freeway;
- B. The accommodation will not be constructed and/or serviced by direct access from the through traffic roadways or connecting ramps;
- C. The accommodation will not interfere with or impair the present use or future expansion of the freeway; and
- D. Any alternative location would be contrary to the public interest. This determination would include an evaluation of the direct and indirect environmental and economic effects which would result from the disapproval of the use of such right-of-way for the accommodation of such utility.

8. *Routine Inspection and Maintenance of Pole Lines*

PERMITTEE is authorized to stub, anchor, or reset existing poles, provided no change in location is made. Stubs and anchors must not be placed between existing pole and traveled way. PERMITTEE may replace poles, guy poles, and crossarms in exact location on no more than two consecutive poles. No additional poles or guy poles are authorized under this routine maintenance provision. PERMITTEE may replace broken pins and insulators, repair broken wires, pull slack wires and replace or pull broken or slack guys and repair and complete transfer work on existing aerial cables. PERMITTEE may string aerial wire and place additional crossarms on existing poles. Existing transformers may be replaced and new transformers may be installed on existing poles. PERMITTEE may install new and replace present service drop wires from facilities existing within the highway right-of-way except where new or replacement wire crosses the highway. Service wires over highways are subject to Public Service Commission regulations and must cross as near right angles as practicable. A new permit shall be obtained for each installation or replacement or addition of wire, drop wire, cable, or other encroachment which crosses the highway or which encroaches upon the highway right-of-way even though not attached to or in contact with existing facilities within the right-of-way.

VI DRIVEWAYS, APPROACHES AND STREET INTERSECTIONS

1. *Paving*

When constructing asphalt approaches, the paving shall be placed by the PERMITTEE a distance of at least 25 feet from the edge of the existing pavement, or to the edge of the right-of-way if less than 25 feet, and shall be of a type approved by the district engineer, unless indicated otherwise in the additional terms and conditions section.

2. *Standards*

Driveways, approaches and street intersections shall be constructed in accordance with the Standard Plans for Road and Bridge Construction, the Standard Specifications for Road and Bridge Construction and/or as directed by the district engineer.

3. *Sawcut*

Where approaches adjoin existing roadway paving, the roadway paving shall be sawcut in a neat straight line the full length of the approach including any required taper lengths. The width of the sawcut shall be a minimum of 1 foot or as directed by the district engineer.

VII PAVEMENT WIDENING FOR LEFT STORAGE LANE

1. Sawcut

One foot of the pavement edge shall be sawcut and removed within the limits of pavement widening.

2. Compaction Tests

Compaction tests shall be taken by the PERMITTEE representative as directed by the district engineer.

3. Gravel and Pavement Improvement

Gravel and pavement improvement section shall be as approved in the plans or specified on the additional terms and conditions of the permit.

4. Prime Coat

Prime coat shall be applied on the finished gravel section.

5. Striping Tape

Reflectorized pavement striping tape (4-inch by 12-inch strips) shall be placed on 25-foot intervals with the appropriate color by a licensed engineering firm immediately upon completion of the open-grade overlay. The striping tape shall be applied on the roadway in accordance with an approved striping detail plan.

6. Signing

Permanent traffic signing and delineation shall be installed as specified in the additional terms and conditions of the permit or as directed by the district engineer.

VIII CONCRETE CURBS, GUTTERS, SIDEWALKS AND WHEELCHAIR RAMPS

1. *Curbs and Gutters*

Curbs and gutters shall be constructed in accordance with Standard Plans for Road and Bridge Construction. See details attached to permit.

2. *Sidewalks*

Sidewalks shall be a minimum of 4 inches in depth unless otherwise authorized by the district engineer, and shall be constructed in accordance with the requirements of local governing agencies, the Standard Plans for Road and Bridge Construction, the Standard Specifications for Road and Bridge Construction and/or as directed by the district engineer.

3. *Wheelchair Ramps*

Wheelchair ramps shall be constructed on all curb and gutter radii on streets and approaches, and shall be constructed in accordance with the requirements of local governing agencies, the Standard Plans for Road and Bridge Construction, the Standard Specifications for Road and Bridge Construction and/or as directed by the district engineer.

IX MAILBOXES

1. Individual Mailboxes Erected and Maintained by Postal Patrons

Any and all individual mailboxes erected and maintained by postal patrons that meet the criteria set forth herein need not be issued a Right-of-Way Occupancy Permit by the Department. No mailbox or newspaper delivery box (hereafter referred to as mailbox) will be allowed to exist on the Department's rights-of-way if it interferes with the safety of the traveling public or the function, maintenance, or operation of the highway system. A mailbox installation that does not conform to the provisions of this regulation is an unauthorized encroachment. The location and construction of mailboxes shall conform to the rules and regulations of the U.S. Postal Service as well as to standards established by the Department.

2. Location

A mailbox installation that conforms to the following criteria will be considered acceptable unless in the judgment of the district engineer the installation interferes with the safety of the traveling public or the function, maintenance, or operation of the highway system.

No mailbox will be permitted where access is obtained from the lanes of a freeway or where access is otherwise prohibited by law or regulation.

Mailboxes shall be located on the right-hand side of the roadway in the direction of the delivery route except on one-way streets where they may be placed on the left-hand side. The bottom of the box shall be set at an elevation established by the U.S. Postal Service, usually between 3 feet 6 inches and 4 feet above the roadway surface. The roadside face of the box shall be offset from the edge of the traveled way a minimum distance of the greater of the following: 8 feet (where no paved shoulder exists), the width of the all-weather shoulder present plus 8 to 12 inches, or the width of an all-weather turnout specified by the Department plus 8 to 12 inches.

Exceptions to the lateral placement criteria above will exist on residential streets and certain designated rural roads where the Department deems it in the public interest to permit lesser clearances or to require greater clearances. On curbed streets, the roadside face of the mailbox shall be set back from the face of curb a distance between 6 and 12 inches. On residential streets without curbs or all-weather shoulders and that carry low-traffic volumes operating at low speeds, the roadside face of a mailbox shall be offset between 8 and 12 inches behind the edge of pavement. On very low-volume rural roads with low-operating speeds the Department may find it acceptable to offset mailboxes a minimum of 6 feet 8 inches from the traveled ways and under some low-volume, low-speed conditions may find clearances as low as 2 feet 8 inches acceptable.

Where a mailbox is located at a driveway entrance, it shall be placed on the far side of the driveway in the direction of the delivery route.

Where a mailbox is located at an intersecting road, it shall be located a minimum of 100 feet beyond the center of the intersecting road in the direction of the delivery route. This distance shall be increased to 200 feet when the average daily traffic on the intersecting road exceeds 400 vehicles per day.

3. Structure

Mailboxes shall be of light sheet metal or plastic construction conforming to the

requirements of the U.S. Postal Service. Newspaper delivery boxes shall be of light sheet metal or plastic construction of minimum dimensions suitable for holding a newspaper.

No more than two mailboxes may be mounted on a support structure unless the support structure and mailbox arrangement have been shown to be safe by crash testing. However, lightweight newspaper boxes may be mounted below the mailbox on the side of the mailbox support.

Mailbox supports shall not be set in concrete unless the support design has been shown to be safe by crash tests when so installed.

A single 4-inch by 4-inch or 4½-inch diameter wooden post or a metal post with a strength no greater than a 2-inch diameter standard strength steel pipe and embedded no more than 24 inches into the ground will be acceptable as a mailbox support. A metal post shall not be fitted with an anchor plate, but it may have an anti-twist device that extends no more than 10 inches below the ground surface.

The post-to-box attachment details should be of sufficient strength to prevent the box from separating from the post top if the installation is struck by a vehicle.

The minimum spacing between the centers of support posts shall be three-fourths the height of the posts above the groundline.

Mailbox support designs not described in this regulation will be acceptable if approved by the district engineer.

4. *Shoulder and Parking Area Construction*

It will be the responsibility of the postal patron to inform the Department of any new or existing mailbox installation where shoulder construction is inadequate to permit all-weather vehicular access to the mailbox. In the event shoulder widening is required, the postal patron shall apply for a permit for such widening. The permit will be for the widening only and not for the mailbox.

5. *Removal of Nonconforming or Unsafe Mailboxes*

Any mailbox that is found to violate the intent of this regulation shall be removed by the postal patron upon written notification by the Department. At the discretion of the Department, based on an assessment of hazard to the public, the patron will be granted not less than 5 days to remove an unacceptable mailbox. After the specified removal period has expired, the unacceptable mailbox will be removed by the Department at the postal patron's expense.

6. *Neighborhood Delivery Mailboxes*

Neighborhood delivery and collection box units erected by the U.S. Postal Service will be authorized within State highway rights-of-way under right-of-way occupancy permits so long as they comply with the criteria contained in the AASHTO Guide For Erecting Mailboxes on Highways dated May 24, 1984. There will be no fee for the permit.

X LANDSCAPING

1. Landscaping Allowed Under Permit

Landscaping may be allowed under the provisions of this permit when the permit is submitted only for landscaping or when the landscaping is requested in conjunction with required site development such as approaches, curbs and gutters, or sidewalks.

2. Landscaping Not Allowed Under Permit

Landscaping shall not be allowed under the provisions of this permit when the landscaping is requested in conjunction with any parking or other commercial use or right-of-way which is incorporated into a multi-use license or commercial lease development to accommodate the proposed use of the right-of-way.

3. Plans

Specific plans for landscaping must be attached to the permit and must show, at a minimum: plants, planters, irrigation systems, landscape grading.

4. Botanical Names

Landscaping requests shall include the botanical names for each of the species of plants proposed.

5. Plant Height

All plants proposed for use in landscaping shall be low profile in nature, and shall not be over 2 feet in height. No solid objects will be allowed.

6. Approval From Local Agencies

Any permit submitted with pertinent landscaping must be approved by the applicable local governmental entity. Approval must be obtained by the PERMITTEE prior to submission of the permit to the Department, and such approval shall be submitted with the permit. Any allowed appurtenance, including plants, must not impede or infringe upon the highway clear roadside area and must not constitute a hazard to the traveling public.

III GENERAL PROVISIONS

1. *Permittee Shall Be Liable for Damages*

The PERMITTEE agrees to indemnify and save harmless the State of Nevada and its officers, agents, and employees against any and all liability, loss, damage, cost, and expense which it or they may incur, suffer, or be required to pay by reason of death, disease, or bodily injury to any person or persons, or injury to, destruction of, or loss of use of any property, including property belonging to the State of Nevada, arising out of or incident to activities contemplated by this permit, and proximately caused, in whole or in part, by any act or omission of the PERMITTEE, or its contractors, agents, or the employees of any one or all of them, **OR BY THE OFFICERS, AGENTS, OR EMPLOYEES OF THE STATE OF NEVADA**, unless it is established by the PERMITTEE that the proximate cause was the willful misconduct or gross negligence of the officers, agents, or employees of the State of Nevada.

2. *Subject to Prior Permits*

This permit is issued subject to all prior valid and existing permits, agreements, contracts, leases, liens, reservations, conditions, encumbrances, or claims of title which may affect the property covered by this permit and PERMITTEE is responsible for obtaining consent from any underlying fee owner in the event the Department does not own the full fee simple interest in the right-of-way.

3. *Revocation*

The terms, conditions, and general provisions of this Right-of-Way Occupancy Permit are **revocable**, or subject to modification or abrogation by the State of Nevada, **at any time**, without prejudice to prior rights, including those evidenced by any joint use agreements, franchise rights, or reserved rights for operating purposes in a grant of a highway easement. In the event of revocation, the PERMITTEE shall, at the direction of the district engineer, remove any or all encroachments installed or constructed pursuant to this Right-of-Way Occupancy Permit, and shall restore the right-of-way to its pre-existing condition.

4. *Acceptance of Provisions*

The performance of **ANY** work contemplated by this permit shall constitute an acceptance by the PERMITTEE of **ALL** the provisions and terms of this permit and **ALL** work shall be prosecuted diligently until completion. **ALL** work authorized by this permit shall be completed within one year from the date of issuance hereof, or this permit will be revoked; except upon written request, if warranted, the PERMITTEE may be given an extension not to exceed 90 days beyond the one year of the approved submitted schedule of completion.

5. *Future Moving of Installation*

Facilities erected or installed in the exercise of the privilege granted remains subject to relocation or removal under the encroachment provisions of paragraphs 3 and 4 of Nevada Revised Statute 408.210.

6. Plan Changes

The PERMITTEE must obtain prior written approval from the district engineer before making any changes from the approved plans and/or method. Should any change in the plans be approved, the PERMITTEE shall submit "as built" drawings delineating the change within 30 days after the date of completion in triplicate.

7. Permit Transfer

PERMITTEE may not transfer, convey, or assign this permit, or any privilege or responsibility contained herein pertaining to actual work to be accomplished within the right-of-way without prior written approval of the Department. PERMITTEE will insure, however, that his continuing responsibility for the upkeep and repair of any facility erected or installed in connection with this permit will be transferred to his successors in interest or assigns, should this permit be approved. PERMITTEE is solely responsible for performance of the work authorized herein.

8. No Precedent Established

Right-of-Way Occupancy Permits are issued with the understanding that any particular action is not to be considered as establishing any precedent on the question of the expediency of permitting any kind of right-of-way occupancy to be erected within right-of-way of state highways, or as to any utility, of the acceptability of any such permits as to any other or future situation.

9. Notice Prior to Starting Work

The PERMITTEE shall notify the district engineer 48 hours prior to commencing work, and shall immediately notify the district engineer upon completion of work.

10. Location of Utilities

PERMITTEE shall arrange for having any and all utilities located within the construction area by contacting the "one-call" location service at 1-800-227-2600, at least 48 hours prior to commencing work hereunder.

11. Working Days

No work shall be performed by the PERMITTEE on Saturdays, Sundays, or holidays or during hours of darkness without the prior written approval of the district engineer.

12. Posting Permit

The Right-of-Way Occupancy Permit, or a conformed copy, shall be kept at the site of the work and must be shown to any representative of the Department of Transportation or any law enforcement officer on demand. WORK SHALL BE SUSPENDED IF THE PERMIT IS NOT AT JOB SITE AS PROVIDED.

13. Inspection and Approval by Department

A final inspection of the work accomplished by the PERMITTEE shall be performed by the district engineer to insure that the PERMITTEE has complied with the terms of this permit. Periodic inspections by the district engineer during the progress of work may be made to insure conformance to the Department's standards and those specified by this permit.

14. Expense of Inspection

For complex or extensive work under this permit, the Department may require a full-time inspector to observe the progress of work in its entirety. In such case, the PERMITTEE agrees to compensate the Department for the direct and indirect costs of inspection, such as but not limited to, wages, mileage, per diem and overhead costs incurred by said inspector in connection with such inspection.

15. Standards of Construction

All work performed under this permit shall be in accordance with the current editions of the State of Nevada Standard Specifications for Road and Bridge Construction, the Standard Plans for Road and Bridge Construction, National Electrical Safety Code and the State of Nevada Department of Transportation Manual on the Accommodation of Utilities, and shall be accomplished to the satisfaction of the district engineer. All construction shall be in conformance with the requirements, rules, and regulations of the Nevada Public Service Commission, the State Industrial Insurance System and the State Labor Commission. Copies of all applicable standard plans and specifications are available upon request from the district engineer.

16. Open Trenches, Pits, and Vertical Pavement Dropoffs

The PERMITTEE shall not allow trenching or excavations within the limits of the right-of-way to remain open on any instance during the hours of darkness or on Saturdays, Sundays, or holidays. During such periods, trenching or excavations shall be either backfilled to surrounding grade or completely covered with steel plating or other suitable material. With the prior concurrence of the district engineer that such measures are impracticable, the PERMITTEE may instead erect sound and substantial fencing or barricades completely around the periphery of such trenching or excavations. The district engineer may at any time direct the PERMITTEE to take more stringent measures as circumstances warrant.

17. Protection of Traffic

During the construction operation, the PERMITTEE shall cause to have installed and maintained as a protection to the public, proper barricades, warning and directional signs, flags, fusee, or other protective devices. Flagmen on each side of the work area shall be provided as required during construction operations to slow and direct traffic around work. Such safety measures shall conform with the provisions of The Manual of Uniform Traffic Control Devices for Streets and Highways (U.S. Department of Transportation, Washington, D.C.). All flagmen must have a valid flagman's certification card in their possession when flagging.

18. Minimum Interference With Traffic

Any work incidental to the scope of this permit, but not specifically provided for herein, and which may affect public safety, shall be performed in such a manner as to insure a minimum of danger, delay, or inconvenience to the public, or as may be directed by the district engineer.

19. Storage of Material

The PERMITTEE shall not allow excavated material, equipment, and materials to remain upon the traveled way or roadway prism during the hours of darkness or on

Saturdays, Sundays, and holidays. The PERMITTEE shall be responsible to insure that all such equipment and materials are situated, after each work shift, no less than 30 feet from the outside edge of the traveled way and no less than 15 feet outside the back face of the curb, whichever the case may be.

20. Care of Drainage

Construction grading shall be performed by the PERMITTEE in such a manner that the roadway drainage ditch or any natural water course which feeds existing drainage facilities will not be blocked or the free flow hindered at any time. Should the necessity arise to accommodate drainage water, culvert pipe of the size and length and at the location prescribed by the district engineer shall be installed by the PERMITTEE.

21. Permittee Shall Patch Pavement and Maintain Patches

PERMITTEE shall replace all removed paving **daily** with premix, and shall place the final paving course within 7 days after completion of work, and **SHALL BE RESPONSIBLE FOR MAINTAINING THE RESTORED PAVED AREAS UNTIL SUCH TIME AS THEY ARE OVERLAID OR RECONSTRUCTED BY THE STATE OF NEVADA.** In the event of settlement in the area of the patched surface, the district engineer may require the PERMITTEE to **repatch** the disturbed area to correct the problem. Failure by the PERMITTEE to do so may result in necessary replacement and repairs by the State of Nevada, in which case, the PERMITTEE shall pay the State of Nevada for the actual direct and related indirect costs incurred by the State of Nevada in performing the replacement or repairs.

The PERMITTEE shall assure that any pavement to be displaced is cut and removed in neat and straight lines. Trenching shall be performed in such a manner as to prevent breaking of the pavement edge adjacent to the trench. Paving shall be replaced by the PERMITTEE true to line and grade, and shall extend at least 18 inches on either side of the trench. The paving mix and thickness of PERMITTEE's mix shall be approved by the district engineer and in no instance shall the depth be less than 3 inches, or less than that of the existing asphaltic pavement, whichever is greater.

22. Removal or Trimming of Trees

The PERMITTEE shall not cut, trim, mutilate, remove, or disturb in any manner, brush, shrubs, trees, or other flora now located within the highway right-of-way, and/or highway planting easement, or which hereafter may be planted or grown therein, except as approved or directed by the district engineer.

23. Damage to Tree Roots

No tree roots over 2 inches in diameter shall be cut when trenching or other underground work is necessary adjacent to roadside trees. The roots that are 2 inches or more in diameter shall be carefully tunneled under and wrapped in burlap and kept moist until the trench is refilled. Trenching machines may not be used under trees if the trunk or limbs will be damaged by their use. If the trees involved are close together and of such size that it is impractical to protect all roots over 2 inches in diameter, special arrangements may be made whereby pruning of the tree tops to balance the root loss can be done by the PERMITTEE under the close supervision of the district engineer. Manholes shall not be installed within 20 feet of any tree trunk.

24. *Damage to Highway Property*

Any highway appurtenances, including fences, disturbed or destroyed by reason of this permit shall be restored to equal or better condition by PERMITTEE. Cattle guards or other devices to restrain livestock shall be installed by the PERMITTEE as directed by the Department and so noted in the additional terms and conditions section of the permit. The entire work area within the right-of-way shall be cleared of construction debris and restored to its original condition prior to acceptance of the work by the district engineer.

25. *Survey Markers*

Any permanent survey or right-of-way marker or monument disturbed or obliterated in construction of the right-of-way occupancy must be permanently reestablished by a registered land surveyor and a record made thereof.

26. *Permittee Shall Be Responsible for Maintenance*

The PERMITTEE agrees, by accepting this permit, to properly maintain and repair any structure, sidewalk, driveway, utility, or other encroachment constructed or placed within the right-of-way of any state highway, and to inspect the area included by the permit at reasonable intervals to determine that necessary maintenance is performed in a timely manner. PERMITTEE understands and agrees that this maintenance responsibility shall continue until this permit is revoked, or until the PERMITTEE removes the encroachment, and restores the right-of-way to its pre-existing condition.

PERMITTEE understands and agrees that the district engineer may require the PERMITTEE to make needed repairs or properly maintain the encroachment. Failure by the PERMITTEE to do so may result in necessary repairs or maintenance by the State of Nevada, in which case, the PERMITTEE shall pay the State of Nevada for the actual direct and related indirect costs incurred by the State of Nevada in performing the repairs or maintenance.

27. *Emergencies*

Any PERMITTEE who lawfully maintains a right-of-way occupancy in, under, or over any state highway may enter in or upon any state highway right-of-way to perform emergency repairs on PERMITTEE's facilities. PERMITTEE shall notify the district engineer of any emergency repairs as soon as possible, and shall immediately address a confirming letter to the district engineer stating the work to be done.

28. *Control of Access Highways*

Maintenance shall not be allowed within the control of access of a controlled access highway without providing at least 48 hours notice to the district engineer.

In the case of emergency maintenance involving control of access highways the utility shall immediately correct the problem and notify the district engineer of its action as soon as practicable.

29. *Standards of Construction*

All work performed under the routine or emergency maintenance provisions of this permit shall conform to the Standard Specifications for Road and Bridge Construction and the Standard Plans for Road and Bridge Construction.

30. *Permittee Shall Be Responsible for Costs of Enforcement*

PERMITTEE agrees to pay all necessary expenses, including reasonable attorney's fees, incurred by the State of Nevada to enforce any provisions of this permit.

IV UNDERGROUND UTILITIES

1. *Crossing Roadway*

Pipes shall normally be jacked or otherwise forced underneath pavement without disturbing same. Pavement or roadway shall not be cut unless specifically allowed by the permit. Service pipes will not be permitted inside culverts used as drainage structures. No hydraulic or wet boring is allowed.

2. *Limit of Excavation*

No excavation is to be made closer than 6 feet from the edge of the pavement except as may be specified in the permit.

3. *Depth of Pipes*

There shall be a minimum of 36 inches of cover over all pipes or conduits, except as may be specified by the permit.

4. *Backfilling*

Trenches shall be backfilled by the PERMITTEE with granular backfill or other acceptable material to the elevation of the bottom of the existing base and surfacing (subgrade) as prescribed by the Nevada Department of Transportation Standard Specifications. Backfilling of the base area shall be made with type 2 gravel or equivalent material. PERMITTEE shall remove and dispose of all excess material immediately after backfilling. All backfill shall be placed in uniform layers not exceeding 8 inches in loose thickness before compaction and shall be compacted to 90 percent of maximum material density.

5. *Pipes Along Roadway*

Except as hereinafter provided in paragraph (C) of this subsection, all installations of underground pipes and conduits in the highway right-of-way shall be marked and designated as follows:

A. All new installations of underground crossovers, except service laterals: where no curbs exist, a 4-inch by 4-inch timber or standard utility company marker shall be installed and maintained by PERMITTEE outside the ditch line at locations satisfactory to the district engineer. Such timber or marker shall extend 30 inches above the ground and have stenciled thereon the nature of the underground obstruction and the name or identifying symbol of the PERMITTEE. Where curbs exist, the cross over shall be identified by description and name of owner stenciled on curb in black letters on white background in a compact and legible manner.

B. All new longitudinal installations: where no curbs exist, 4-inch by 4-inch timbers or standard utility markers shall be placed adjacent to the conduit or offset to such a distance as may be specified and at intervals not to exceed 1,000 feet, at each angle point, or where nonconcentric with the highway, at least every 300 feet. Where the encroachment is located in the traveled way, timber or other suitable markers shall be placed at an offset outside the ditch line at locations satisfactory to the district engineer with an offset distance given. Where curbs exist, the information shall be visible and permanently marked or monumented on the curb near each intersection.

C. Exceptions. In incorporated cities where the installation is in accordance with ordinances, other regulations, or established practices, it will not be necessary to mark or designate said facilities as required above unless dictated by federal directive. All installations covered under this section shall be placed or constructed in such a manner as not to constitute a hazard to the traveling public.

6. Casings

Casings shall be designed to support the load of the highway and superimposed loads thereon and, as a minimum should equal the structural requirements for highway drainage facilities. Casings shall be composed of materials of satisfactory durability under conditions to which they may be exposed.

7. Jacking or Boring

Bore holes or pits may be placed within 35 feet of the edge of shoulder under the following conditions:

- A. Bore holes or pit areas shall be completely fenced.
- B. PERMITTEES and/or their contractors will not be permitted to use any portion of the rights-of-way for their operations, except in the fenced areas, or as permitted by the district engineer.
- C. Access to bore holes or pit areas will not be permitted from the traveled portion of the highway.
- D. Bore holes or pits will not be permitted within the median area of a highway except as authorized by the district engineer. Extreme care must be taken during this operation to guard against the impairment of the earth structure under the pavement and shoulders.
- E. Any voids created by the boring operation outside the casing shall be pressure grouted.

8. Trenching

Trenching may be allowed if deemed necessary in the opinion of the district engineer. Trenched areas of pavement shall be patched in accordance with the Standard Plans for Road and Bridge Construction. See details for method of patching attached to permit. Trenching will generally not be allowed unless at least one of the following conditions is evident:

- A. The roadway is scheduled for overlay or reconstruction within the forthcoming two years.
- B. The roadway surface is in such poor condition that a permanent pavement patch will not detract from the existing roadway surface quality.
- C. The PERMITTEE has attempted to bore the crossing and found it impractical due to subterranean conditions.

9. Routine Inspection and Maintenance of Underground Utilities

PERMITTEE may inspect and repair underground utilities, including manholes, conduits, cables and pipelines. PERMITTEE may open existing manholes to repair underground utilities and uncover not more than 50 feet of cables or lines buried in earth portions of highway right-of-way. Where existing manholes lie within the improved surfaces of the highway, the PERMITTEE will provide adequate protection of traffic in accordance with the permit or as directed by the district engineer. No excavation shall be

made in improved surfaces, landscaped areas or closer than 6 feet to the edge of pavement without a special permit, except in emergencies.

10. *Emergency Repairs*

PERMITTEE may make emergency repairs by excavating through improved surfaces only when breaks in the lines, conduits or cables under the pavement present a hazard to traffic or a serious interruption of essential service. In such cases the district engineer shall be notified immediately. Backfill and pavement replacement shall be performed in accordance with the Standard Specifications for Road and Bridge Construction. Landscaped areas which are disturbed shall be relandscaped at PERMITTEE's expense.

11. *Service Connections*

These terms and conditions do not authorize the continuous installation of gas or water service connections within state highway right-of-way, regardless of location of main. All new pipe services, main extensions, or excavation to abandon services must be covered by individual permits.

V OVERHEAD UTILITIES

1. Conformance With Code

The PERMITTEE shall insure that when installing aerial and underground electrical or communication lines, the clearances and method of construction shall be in accordance with the safety rules for the installation and maintenance of electrical supply and communication lines as set forth in the National Electrical Safety Code and the Nevada Department of Transportation Manual on the Accommodation and Installation of Utilities.

2. Permission From Property Owners

The PERMITTEE must secure permission, if needed, from abutting property owners prior to starting work.

3. Guy Wires

No guy wires are to be attached to trees except as may be specified in the permit and in no event shall they be so attached as to girdle the tree or interfere with its growth. Guy wires shall be kept at a minimum elevation above ground as directed by the district engineer.

4. Remove Old Poles, Guys, and Stubs

The entire length of old timbers shall be removed from the ground and the holes backfilled and thoroughly tamped.

5. Vertical Clearance Over Roadway

Aerial crossings shall conform to the requirements of the National Electrical Safety Code (per American National Standards Institute, ANSI).

The minimum vertical clearance for highway crossings shall be 18 feet for communications lines, 22 feet for electrical lines and 17 feet 6 inches for walkways. This measurement shall be from the highest point of the roadway prism to the lowest point of the installation crossing.

6. Crossings

Crossings shall be made at or as near to 90 degrees as possible across the roadway. Poles supporting crossings shall be, as a minimum, located outside the "clear zone" as prescribed by the AASHTO Guide to Selecting, Locating and Designing Traffic Barriers, 1977, and addendums thereto, and whenever possible will be located at the right-of-way line. In the case of divided highways, poles are not to be placed within the median strip unless the median strip is at least 80 feet in width and the median pole is absolutely necessary to support the crossing.

7. Longitudinal Installations

Poles shall be placed at or as near the right-of-way as possible. New utilities will not be permitted to be installed longitudinally within the control of access lines of any freeway, except that in special cases such installations may be permitted under strictly controlled conditions. However, in each such case the utility owner must show that:

A. The accommodation will not adversely affect the safety, design, construction, operation, maintenance or stability of the freeway;

B. The accommodation will not be constructed and/or serviced by direct access from the through traffic roadways or connecting ramps;

C. The accommodation will not interfere with or impair the present use or future expansion of the freeway; and

D. Any alternative location would be contrary to the public interest. This determination would include an evaluation of the direct and indirect environmental and economic effects which would result from the disapproval of the use of such right-of-way for the accommodation of such utility.

8. *Routine Inspection and Maintenance of Pole Lines*

PERMITTEE is authorized to stub, anchor, or reset existing poles, provided no change in location is made. Stubs and anchors must not be placed between existing pole and traveled way. PERMITTEE may replace poles, guy poles, and crossarms in exact location on no more than two consecutive poles. No additional poles or guy poles are authorized under this routine maintenance provision. PERMITTEE may replace broken pins and insulators, repair broken wires, pull slack wires and replace or pull broken or slack guys and repair and complete transfer work on existing aerial cables. PERMITTEE may string aerial wire and place additional crossarms on existing poles. Existing transformers may be replaced and new transformers may be installed on existing poles. PERMITTEE may install new and replace present service drop wires from facilities existing within the highway right-of-way except where new or replacement wire crosses the highway. Service wires over highways are subject to Public Service Commission regulations and must cross as near right angles as practicable. A new permit shall be obtained for each installation or replacement or addition of wire, drop wire, cable, or other encroachment which crosses the highway or which encroaches upon the highway right-of-way even though not attached to or in contact with existing facilities within the right-of-way.

VI DRIVEWAYS, APPROACHES AND STREET INTERSECTIONS

1. *Paving*

When constructing asphalt approaches, the paving shall be placed by the PERMITTEE a distance of at least 25 feet from the edge of the existing pavement, or to the edge of the right-of-way if less than 25 feet, and shall be of a type approved by the district engineer, unless indicated otherwise in the additional terms and conditions section.

2. *Standards*

Driveways, approaches and street intersections shall be constructed in accordance with the Standard Plans for Road and Bridge Construction, the Standard Specifications for Road and Bridge Construction and/or as directed by the district engineer.

3. *Sawcut*

Where approaches adjoin existing roadway paving, the roadway paving shall be sawcut in a neat straight line the full length of the approach including any required taper lengths. The width of the sawcut shall be a minimum of 1 foot or as directed by the district engineer.

VII PAVEMENT WIDENING FOR LEFT STORAGE LANE

1. Sawcut

One foot of the pavement edge shall be sawcut and removed within the limits of pavement widening.

2. Compaction Tests

Compaction tests shall be taken by the PERMITTEE representative as directed by the district engineer.

3. Gravel and Pavement Improvement

Gravel and pavement improvement section shall be as approved in the plans or specified on the additional terms and conditions of the permit.

4. Prime Coat

Prime coat shall be applied on the finished gravel section.

5. Striping Tape

Reflectorized pavement striping tape (4-inch by 12-inch strips) shall be placed on 25-foot intervals with the appropriate color by a licensed engineering firm immediately upon completion of the open-grade overlay. The striping tape shall be applied on the roadway in accordance with an approved striping detail plan.

6. Signing

Permanent traffic signing and delineation shall be installed as specified in the additional terms and conditions of the permit or as directed by the district engineer.

VIII CONCRETE CURBS, GUTTERS, SIDEWALKS AND WHEELCHAIR RAMPS

1. *Curbs and Gutters*

Curbs and gutters shall be constructed in accordance with Standard Plans for Road and Bridge Construction. See details attached to permit.

2. *Sidewalks*

Sidewalks shall be a minimum of 4 inches in depth unless otherwise authorized by the district engineer, and shall be constructed in accordance with the requirements of local governing agencies, the Standard Plans for Road and Bridge Construction, the Standard Specifications for Road and Bridge Construction and/or as directed by the district engineer.

3. *Wheelchair Ramps*

Wheelchair ramps shall be constructed on all curb and gutter radii on streets and approaches, and shall be constructed in accordance with the requirements of local governing agencies, the Standard Plans for Road and Bridge Construction, the Standard Specifications for Road and Bridge Construction and/or as directed by the district engineer.

IX MAILBOXES

1. Individual Mailboxes Erected and Maintained by Postal Patrons

Any and all individual mailboxes erected and maintained by postal patrons that meet the criteria set forth herein need not be issued a Right-of-Way Occupancy Permit by the Department. No mailbox or newspaper delivery box (hereafter referred to as mailbox) will be allowed to exist on the Department's rights-of-way if it interferes with the safety of the traveling public or the function, maintenance, or operation of the highway system. A mailbox installation that does not conform to the provisions of this regulation is an unauthorized encroachment. The location and construction of mailboxes shall conform to the rules and regulations of the U.S. Postal Service as well as to standards established by the Department.

2. Location

A mailbox installation that conforms to the following criteria will be considered acceptable unless in the judgment of the district engineer the installation interferes with the safety of the traveling public or the function, maintenance, or operation of the highway system.

No mailbox will be permitted where access is obtained from the lanes of a freeway or where access is otherwise prohibited by law or regulation.

Mailboxes shall be located on the right-hand side of the roadway in the direction of the delivery route except on one-way streets where they may be placed on the left-hand side. The bottom of the box shall be set at an elevation established by the U.S. Postal Service, usually between 3 feet 6 inches and 4 feet above the roadway surface. The roadside face of the box shall be offset from the edge of the traveled way a minimum distance of the greater of the following: 8 feet (where no paved shoulder exists), the width of the all-weather shoulder present plus 8 to 12 inches, or the width of an all-weather turnout specified by the Department plus 8 to 12 inches.

Exceptions to the lateral placement criteria above will exist on residential streets and certain designated rural roads where the Department deems it in the public interest to permit lesser clearances or to require greater clearances. On curbed streets, the roadside face of the mailbox shall be set back from the face of curb a distance between 6 and 12 inches. On residential streets without curbs or all-weather shoulders and that carry low-traffic volumes operating at low speeds, the roadside face of a mailbox shall be offset between 8 and 12 inches behind the edge of pavement. On very low-volume rural roads with low-operating speeds the Department may find it acceptable to offset mailboxes a minimum of 6 feet 8 inches from the traveled ways and under some low-volume, low-speed conditions may find clearances as low as 2 feet 8 inches acceptable.

Where a mailbox is located at a driveway entrance, it shall be placed on the far side of the driveway in the direction of the delivery route.

Where a mailbox is located at an intersecting road, it shall be located a minimum of 100 feet beyond the center of the intersecting road in the direction of the delivery route. This distance shall be increased to 200 feet when the average daily traffic on the intersecting road exceeds 400 vehicles per day.

3. Structure

Mailboxes shall be of light sheet metal or plastic construction conforming to the

requirements of the U.S. Postal Service. Newspaper delivery boxes shall be of light sheet metal or plastic construction of minimum dimensions suitable for holding a newspaper.

No more than two mailboxes may be mounted on a support structure unless the support structure and mailbox arrangement have been shown to be safe by crash testing. However, lightweight newspaper boxes may be mounted below the mailbox on the side of the mailbox support.

Mailbox supports shall not be set in concrete unless the support design has been shown to be safe by crash tests when so installed.

A single 4-inch by 4-inch or 4½-inch diameter wooden post or a metal post with a strength no greater than a 2-inch diameter standard strength steel pipe and embedded no more than 24 inches into the ground will be acceptable as a mailbox support. A metal post shall not be fitted with an anchor plate, but it may have an anti-twist device that extends no more than 10 inches below the ground surface.

The post-to-box attachment details should be of sufficient strength to prevent the box from separating from the post top if the installation is struck by a vehicle.

The minimum spacing between the centers of support posts shall be three-fourths the height of the posts above the groundline.

Mailbox support designs not described in this regulation will be acceptable if approved by the district engineer.

4. *Shoulder and Parking Area Construction*

It will be the responsibility of the postal patron to inform the Department of any new or existing mailbox installation where shoulder construction is inadequate to permit all-weather vehicular access to the mailbox. In the event shoulder widening is required, the postal patron shall apply for a permit for such widening. The permit will be for the widening only and not for the mailbox.

5. *Removal of Nonconforming or Unsafe Mailboxes*

Any mailbox that is found to violate the intent of this regulation shall be removed by the postal patron upon written notification by the Department. At the discretion of the Department, based on an assessment of hazard to the public, the patron will be granted not less than 5 days to remove an unacceptable mailbox. After the specified removal period has expired, the unacceptable mailbox will be removed by the Department at the postal patron's expense.

6. *Neighborhood Delivery Mailboxes*

Neighborhood delivery and collection box units erected by the U.S. Postal Service will be authorized within State highway rights-of-way under right-of-way occupancy permits so long as they comply with the criteria contained in the AASHTO Guide For Erecting Mailboxes on Highways dated May 24, 1984. There will be no fee for the permit.

X LANDSCAPING

1. Landscaping Allowed Under Permit

Landscaping may be allowed under the provisions of this permit when the permit is submitted only for landscaping or when the landscaping is requested in conjunction with required site development such as approaches, curbs and gutters, or sidewalks.

2. Landscaping Not Allowed Under Permit

Landscaping shall not be allowed under the provisions of this permit when the landscaping is requested in conjunction with any parking or other commercial use or right-of-way which is incorporated into a multi-use license or commercial lease development to accommodate the proposed use of the right-of-way.

3. Plans

Specific plans for landscaping must be attached to the permit and must show, at a minimum: plants, planters, irrigation systems, landscape grading.

4. Botanical Names

Landscaping requests shall include the botanical names for each of the species of plants proposed.

5. Plant Height

All plants proposed for use in landscaping shall be low profile in nature, and shall not be over 2 feet in height. No solid objects will be allowed.

6. Approval From Local Agencies

Any permit submitted with pertinent landscaping must be approved by the applicable local governmental entity. Approval must be obtained by the PERMITTEE prior to submission of the permit to the Department, and such approval shall be submitted with the permit. Any allowed appurtenance, including plants, must not impede or infringe upon the highway clear roadside area and must not constitute a hazard to the traveling public.

COMMERCIAL LEASE
(Nevada State Department of Transportation)

THIS LEASE, made this ____ day of _____, 19____, between

hereinafter called the LESSEE, and the STATE OF NEVADA, acting by and through its Department of Transportation, hereinafter called the LESSOR,

WITNESSETH:

The LESSOR, for and in consideration of the agreements, conditions, covenants and stipulations of the LESSEE as hereinafter provided as follows:

(a) To lease, demise and let to the LESSEE those certain premises situate in the County of _____, State of Nevada, sometimes designated as _____

said leased area being more particularly described as follows:

The parties hereto covenant and agree as follows:

1. TERM

(a) The term of this lease shall be for a primary term of _____ () _____ beginning _____ and ending _____, plus the option to renew for _____ extended terms of _____ each, the first of such extended terms to begin on the expiration of the initial term and each successive extended term to begin on the expiration of the term immediately preceding.

(b) The LESSEE'S option of renewing this lease shall be exercised in writing by means of certified or registered mail notice to the LESSOR at least thirty (30) days prior to the commencement of the renewal period.

(c) That the LESSEE, keeping and performing the covenants and agreements herein contained on the part of the LESSEE to be kept and performed, shall at all times during the said tenancy peaceably and quietly have, hold and enjoy the leased premises without suit, trouble or hindrance from the LESSOR; provided, however, and it is further agreed, that LESSEE has performed and fulfilled each and every condition and covenant herein contained to be performed by said LESSEE.

(d) That in the event of the termination of the within lease by the expiration thereof, or for any other reason, LESSEE will peaceably and quietly leave, surrender and yield up to the LESSOR all and singular the leased premises in good order, condition and repair, reasonable use and wear thereof, and damage by earthquake, fire and public calamity, by the elements or by act of God, excepted.

(e) That this lease may be terminated at any time for any reason by the LESSEE or the LESSOR upon _____ prior notice, in writing, serving same upon LESSOR or LESSEE, as the case may be.

(f) That it is further mutually covenanted and agreed that upon the expiration or termination of the term hereof, LESSEE shall remove or cause to be removed at his own expense, any and all improvements erected or emplaced by LESSEE on said leasehold, leaving and surrendering said premises in as good order and condition as the premises were in when delivered to LESSEE or said improvements shall upon said expiration or termination of the term hereof become property of LESSOR upon his option and without compensation by him to the LESSEE.

2. RENTAL

(a) The LESSEE agrees to pay LESSOR as rent for the leased premises the sum of _____ (\$ _____) per _____ payable in advance _____ to the LESSOR at 1263 South Stewart Street, Carson City, Nevada 89712, commencing on the _____ day of _____, 19____, and thereafter payable on or before the _____ day of _____ for which due. In the event of termination, any unearned rental for the remainder of that period wherein termination occurs shall be returned to LESSEE.

(b) It is understood and agreed by and between LESSOR and LESSEE that the rental herein reserved and provided for shall be automatically reviewed and reevaluated by LESSOR and, if necessary, renegotiated within at least (30) days of the expiration of each _____ () year increment of the term hereof.

(c) That if any rent shall be due and unpaid after the same shall become payable as aforesaid; or if LESSEE shall not perform and fulfill each and every one of the conditions and covenants herein contained to be performed by LESSEE, or if a petition in bankruptcy be filed by or against LESSEE; or if LESSEE becomes insolvent; or if any proceeding is filed to subject this lease or the interest of LESSEE herein to garnishment or sale under execution; or if LESSEE makes an assignment for the benefit of creditors; or if LESSEE discontinues business in the lease premises for more than a continuous sixty (60) day period; or if LESSEE attempts to sell or assign this lease; said act or acts of omission or commission may, at the option of LESSOR, constitute a forfeiture of all rights under the lease and a voiding of the lease and an ending of the term of this lease, and the further occupancy of said leased premises after such forfeiture by said LESSEE shall be deemed held and taken as a forcible detainer thereof by said LESSEE; and said LESSOR may without notice reenter and take possession thereof with or without force, and with or without legal process, evict and dispossess said LESSEE from said above leased premises; and if any suit be brought by the LESSOR against the LESSEE to recover any rent, or for the breach of any condition or covenant herein contained by said LESSEE, or any summary action be brought by said LESSOR for forfeiture of this lease, or to recover possession of said leased premises, said LESSEE agrees to pay, in addition to any damages recovered by LESSOR, interest at twelve percent (12%) per year on damages from the date same first became due, plus all of LESSOR'S costs, including but not limited to attorney's fees.

3. SUBLEASES, ASSIGNMENTS AND ASSIGNMENTS BY OPERATION OF LAW

(a) That LESSEE not assign this lease, nor sublet the leased premises in any event.

(b) That no holding over by LESSEE shall operate to renew this lease without the written consent of LESSOR endorsed thereon.

4. WAIVER

The waiver by LESSOR of any breach of any term, covenant or condition herein contained shall not be deemed to be a waiver of such term, covenant or condition or any subsequent breach of the same, or any other term, covenant or condition herein contained. The subsequent acceptance of rent hereunder by LESSOR shall not be deemed to be a waiver of any preceding breach by LESSEE of any term, covenant or condition of this lease other than the failure of LESSEE to pay the particular rental so accepted, regardless of LESSOR'S knowledge of preceding breach at the time of acceptance of such rental.

5. NOTICES

Any and all notices or demands by or from LESSOR to LESSEE, or LESSEE to LESSOR, shall be in writing. They shall be served either personally or by mail, service shall be conclusively deemed made at the time of service. If served by certified mail, service shall be conclusively deemed made forty-eight (48) hours after the deposit thereof in the United States mail, postage prepaid, addressed to the party to whom such notice or demand is to be given and the issuance of receipt therefor. If served by telegraph, service shall be conclusively deemed made at the time the telegraph agency confirms to the sender delivery thereof to the addressee. Any notice or demand to LESSOR may be given to LESSOR at 1263 South Stewart Street, Carson City, Nevada or at such other place or places as shall be designated by LESSOR from time to time. Any notice or demand to LESSEE shall be given to LESSEE at _____.

6. IMPROVEMENTS, REPAIRS, MAINTENANCE AND USE OF THE PROPERTY

(a) That LESSEE place no improvements in, on or upon the leased premises except those approved as part of this lease in accordance with paragraph 6(k). No additional construction or alterations shall be made in, on or upon said premises without the prior consent and approval of LESSOR, and the Federal Highway Administration.

(b) That LESSEE shall be responsible for the reestablishment by a registered land surveyor of any permanent survey markers or highway right of way monuments disturbed or obliterated during the term of this lease, at LESSEE'S expense.

(c) That LESSEE place no advertising signs, signboards, or other advertising material on the leased premises during the term of this lease, without prior approval of LESSOR first had and obtained in writing.

(d) That LESSEE pay all taxes and assessments imposed by any source which may be legally assessed on LESSEE'S possessory interest, or on any improvements or equipment placed by LESSEE on said premises, and LESSEE recognizes that such payment shall not reduce any rent due the LESSOR.

(e) That LESSEE pay all charges for water, gas, electricity, sewage and trash disposal furnished and supplied to or upon any part of the herein described premises contracted for by the LESSEE.

(f) That LESSEE secure all necessary permits required in connection with operations on the leased premises and shall comply with all Federal, State and local statutes, ordinances or regulations which may affect in any respect LESSEE'S use of the leased premises.

(g) That LESSEE keep and maintain at his sole expense, the leased premises free of all weeds, noxious plants, debris and inflammable or explosive materials of every description, and at all times keep the premises in an orderly, clean, safe and sanitary condition.

(h) That all work performed by LESSEE under this lease shall be in accordance with the current editions of the State of Nevada Standard Specifications for Road and Bridge Construction and the Standard Plans for Road and Bridge Construction, and shall be accomplished to the satisfaction of the district engineer. Copies of applicable plans and specifications are available upon request from the district engineer.

(i) That LESSEE'S violation of any provision of this lease, and not correcting said violation within a reasonable time after receipt of notice from LESSOR in accordance with the provisions of Paragraph 5 of this lease, shall constitute a forfeiture of all LESSEE'S rights hereunder and shall constitute a voiding and termination of the lease as provided herein.

(j) That the leasing of the premises by LESSEE was after examination of their present condition and without any representation or warranties on the part of LESSOR or its agents.

(k) That LESSEE shall use said premises for _____

7. RIGHT OF ENTRY

That LESSOR specifically reserves the right of entry by any authorized officer, engineer, employee, agent or contractor of the LESSOR for the purpose of inspecting said premises, or the doing of any and all acts necessary or proper on said premises in connection with the protection, maintenance, repair, reconstruction, and operation of said premises.

8. INSURANCE

(a) That this lease is made upon the express condition that the State of Nevada, its officers, agents, and employees are to be free from all liability and claim for damage by reason of any person or persons, including LESSEE, or damage to property of any kind whatsoever and to whomsoever belonging, including LESSEE, from any cause whatsoever, while in, upon or in any way connected with the said leased premises or any occupancy hereunder during the term of this lease or any extension hereof.

(b) That LESSEE take out and keep in force during the within tenancy, and at LESSEE'S own expense, public liability insurance with coverage not less than the statutory limits: as of the date of this agreement - Bodily Injury - \$50,000. each person/\$200,000. each occurrence, Property Damage - \$50,000. LESSOR will notify LESSEE of any statutory amendments affecting LESSEE'S obligation under this paragraph and request proof of coverage within thirty (30) days of said notice.

(c) That the policy of insurance name the LESSOR, its officers, employees, and agents as an additional insured against any liability to the public, resulting from the use of or occurring in or about the leased premises - said additional insured to be designated as follows: Nevada State Department of Transportation, 1263 South Stewart Street, Carson City, Nevada 89712.

(d) That LESSEE, upon signing this lease, will provide the LESSOR with a copy of the insurance binder, and within not more than fifteen (15) days after the effective date of policy furnish to LESSOR a certificate of insurance relative to said policy.

(e) That if the LESSEE does not keep insurance described in Paragraph 8 (b) and (c) above in full force and effect, LESSOR may, in accordance with Paragraph 1 (e) of this lease, void and terminate the within tenancy.

9. GENERAL COVENANTS

(a) This lease shall constitute the entire contract between the parties hereto, and no modification hereof shall be binding unless endorsed hereon in writing.

(b) All covenants and agreements herein contained shall extend to and be obligatory upon the heirs, executors, administrators, successors and assigns, as the case may be of the respective parties.

(c) As used herein the terms LESSOR and LESSEE shall include the plural as well as the singular, and the feminine as well as the masculine, and the neuter.

(d) That the provisions of this lease may be altered, changed or amended by mutual consent of the parties hereto, in accordance with the provisions and procedures herein contained.

(e) That time is of the essence of each and all of the terms and provisions of this lease.

(f) This lease shall be recorded at LESSEE'S expense. The provisions herein shall be null and void unless recorded by the LESSEE and a conformed copy delivered to the LESSOR.

IN WITNESS WHEREOF the parties hereto have executed this agreement the day and year first above written.

REVIEWED AND RECOMMENDED BY:

District Engineer

REVIEWED AND RECOMMENDED BY:

Chief Right-of-Way Agent

APPROVED FOR LEGALITY AND FORM:

Deputy Attorney General

S
E
A
L

STATE OF NEVADA acting by and through its
Department of Transportation:

Director

STATE OF _____

On this _____ day of _____, 19 ____, personally appeared before me,
the undersigned, a Notary Public in and for the _____, State of _____,

known to me to be the person described in and who executed the foregoing instrument who
acknowledged to me that he executed the same freely and voluntarily and for the uses
and purposes thereby mentioned.

S
E
A
L

IN WITNESS WHEREOF I have hereunto set
my hand and affixed my official seal the day
and year in this certificate first above
written.

STATE OF NEVADA
CARSON CITY

On this _____ day of _____, 19 ____, personally appeared before me,
the undersigned, a Notary Public in and for Carson City, State of Nevada,
known to me to be the _____ Director of the
Department of Transportation of the State of Nevada who executed the foregoing instrument
for the Nevada Department of Transportation under authorization of Nevada Revised Statutes,
Chapter 408.205; that he affirms that the seal affixed to said instrument is the seal of
said Department; and that said instrument was executed for the Nevada Department of
Transportation freely and voluntarily and for the uses and purposes therein mentioned.

S
E
A
L

IN WITNESS WHEREOF I have hereunto set
my hand and affixed my official seal the day
and year in this certificate first above
written.

DOT
030-057
rev. 9/86

MULTI-USE LICENSE
(NEVADA STATE DEPARTMENT OF TRANSPORTATION)

THIS MULTI-USE LICENSE, made this _____ day of _____, 19____, between _____

hereinafter called LICENSEE, and the STATE OF NEVADA, acting by and through its Department of Transportation, hereinafter called LICENSOR,

WITNESSETH:

WHEREAS, LICENSOR has an easement for public highway purposes and is responsible for the construction and maintenance of certain highways in the State of Nevada among which is _____, located in the County of _____ and;

WHEREAS, LICENSEE is the owner of certain property abutting the aforesaid highway; and

WHEREAS, LICENSEE has requested LICENSOR, for aesthetic and other reasons, for permission to temporarily use a portion of the right-of-way of said highway for the purpose of _____ and;

WHEREAS, the requested temporary use will be of benefit to LICENSOR, LICENSEE, and the traveling public and will not interfere with the maintenance and operation of the aforesaid highway,

WHEREAS, LICENSOR, for any reason, may revoke this license,

NOW, THEREFORE, in consideration of the premises and of the mutual covenants herein contained, it is agreed as follows:

SECTION ONE

GRANT OF LICENSE: DESCRIPTION OF PREMISES

LICENSOR hereby grants to LICENSEE a license to occupy and use, subject to all of the terms and conditions hereof, the following described premises:

SECTION TWO

LIMITATION TO DESCRIBED PURPOSE

The premises may be occupied and used by LICENSEE solely for _____
and for incidental purposes related thereto during the period beginning _____,
19____, and continuing until this Multi-Use License is terminated as herein provided.

SECTION THREE

PAYMENTS

LICENSEE shall pay LICENSOR for this license the sum of FIVE HUNDRED AND NO/100 DOLLARS (\$500.00) payable in advance, for the purpose of defraying the cost to LICENSOR of processing the license application.

SECTION FOUR

TERMINATION - REMOVAL OF IMPROVEMENTS

Either party may terminate this Multi-Use License at any time, for any reason, by giving written notice to the other, specifying the date of termination, such notice to be given no less than thirty (30) days prior to the date therein specified. If LICENSEE shall make an assignment for the benefit of creditors, or be placed in receivership or adjudicated a bankrupt, or take advantage of any bankruptcy or insolvency law, LICENSOR may terminate this Multi-Use License by giving written notice to the LICENSEE, specifying the date of termination, such notice to be given not less than thirty (30) days prior to the date therein specified.

It is further mutually agreed that upon revocation or termination of this Multi-Use License, LICENSEE shall remove, or cause to be removed, at its own expense, any and all improvements placed thereon and if LICENSEE shall fail to do so, LICENSOR shall have the right to make such removal at LICENSEE'S expense, the amount of which expense LICENSEE shall pay to LICENSOR on demand, and, if LICENSOR shall so elect, it shall have the right to take possession of and appropriate to itself without payment therefor any property of LICENSEE, or anyone claiming under it, then remaining on the premises.

SECTION FIVE

ASSIGNMENTS PROHIBITED - WAIVER

It is expressly agreed that LICENSEE shall not have the right to assign its rights, in whole or in part, under this Multi-Use License except on the express prior written consent of LICENSOR.

The waiver by LICENSOR of a breach of any covenant or condition herein shall not extend to any future breaches nor prejudice any rights or remedies whatever in regard thereto.

SECTION SIX

NOTICES

Any and all notices or demands by or from LICENSOR to LICENSEE, or LICENSEE to LICENSOR, shall be in writing. They shall be served either personally or by mail and service shall be conclusively deemed made at the time of service. If served by certified mail, service shall be conclusively deemed made forty-eight (48) hours after the deposit thereof in the United States mail, postage prepaid, addressed to the party to whom such notice or demand is to be given and the issuance of receipt therefor. If served by telegraph, service shall be conclusively deemed made at the time the telegraph agency shall confirm to the sender delivery thereof to the addressee. Any notice or demand to LICENSOR may be given to LICENSOR at 1263 South Stewart Street, Carson City, Nevada 89712, or at such other place or places as shall be designated by LICENSOR from time to time. Any notice or demand to LICENSEE shall be given to LICENSEE at _____

SECTION SEVEN

IMPROVEMENTS, REPAIRS, TAXES, MAINTENANCE AND USE OF THE PROPERTY

LICENSEE agrees that it will place no improvements in, on or upon the said premises nor make any use of it except in accordance with the plans and specifications approved by LICENSOR and for the purpose of _____

LICENSEE shall secure all necessary permits required in connection with operations on the said premises and shall comply with all Federal, State and local statutes, ordinances or regulations which may affect, in any respect, LICENSEE'S use of said premises, including zoning, if applicable.

LICENSEE shall keep and maintain, at its own expense, the said premises free of all weeds, noxious plants, debris and inflammable or explosive materials of every description, and at all times shall keep the premises in an orderly, clean, safe and sanitary condition, and in accordance with LICENSEE'S plans therefore.

LICENSEE shall pay all taxes and assessments imposed by any source which may be legally assessed on LICENSEE'S possession, or any improvements or equipment placed by LICENSEE on said premises.

LICENSEE shall pay all charges for water, gas, electricity or any other utility supplied to or upon any part of the herein described premises which is contracted for by the LICENSEE.

It is mutually agreed that if LICENSEE violates any provision of this Multi-Use License and does not correct said violation within a reasonable time after receipt of notice from LICENSOR in accord with the provisions of Section 6 of this Multi-Use License, it shall constitute a voiding and termination of this Multi-Use License as provided herein.

SECTION EIGHT

RIGHT OF ENTRY

LICENSOR specifically reserves the right of entry by any authorized officer, engineer, employee, agent or contractor of LICENSOR for the purpose of inspecting said premises and performing activities related to the maintenance and operation of the aforesaid highway.

LICENSEE is specifically advised that this Multi-Use License does not convey the right to construct approach roads, or in any other manner to encroach on the highway right-of-way. Permission to do so must be requested by LICENSEE pursuant to Nevada Department of Transportation Occupancy Permit regulations.

SECTION NINE

INSURANCE

It is mutually agreed that this Multi-Use License is made upon the express condition that the LICENSOR, its officers, agents and employees are to be free, and held harmless, from all liability and claims for damage by reason of personal injury or death, including those wrongful in nature, of any person or persons, including LICENSEE, or damage to property of any kind whatsoever and to whomsoever belonging, including LICENSEE, or from any cause whatsoever while in, upon or in any way connected with the said premises or any occupancy hereunder under this Multi-Use License.

LICENSEE shall take out and keep in force during the life of this Multi-Use License, and at LICENSEE'S own expense, public liability insurance with coverage of not less than the statutory limits as of the date of this Multi-Use License: Bodily Injury - \$50,000, each person/\$200,000 each occurrence, Property Damage - \$50,000. LICENSOR will notify LICENSEE of any statutory amendments affecting LICENSOR'S obligation under this paragraph and request proof of coverage within thirty (30) days of said notice.

The policy of insurance shall name the LICENSOR, its officers, employees and agents as an additional insured against any liability resulting from the use or occurring in or about the premises, said additional insured to be designated as follows: Nevada State Department of Transportation, 1263 South Stewart Street, Carson City, Nevada 89712.

LICENSEE, shall, upon signing this Multi-Use License, provide the LICENSOR with a copy of the insurance binder, and within not more than fifteen (15) days after the effective date of the policy, furnish to LICENSOR a certificate of insurance relative to said policy.

If LICENSEE does not procure, keep or maintain insurance as described above in full force and effect, LICENSOR may terminate and void this Multi-Use License.

SECTION TEN

NUISANCE

LICENSEE shall not perform or permit any of its guests or invitees to perform any disorderly conduct or commit any nuisance on the premises or to use the premises in any way which will interfere with or endanger the traveling public. Lighting, if any, placed by LICENSEE shall not produce any objectionable glare to the traveling public. No signs of any type, on-premise or otherwise, will be permitted to be erected on the premises.

SECTION ELEVEN

GENERAL COVENANTS

This Multi-Use License shall constitute the entire contract between the parties hereto and no modification hereof shall be binding unless endorsed hereon in writing.

As used herein, the terms LICENSOR and LICENSEE shall include the plural as well as the singular and the feminine as well as the masculine and the neuter.

The provisions of this Multi-Use License may be altered, changed or amended by mutual consent of the parties hereto and in accordance with the provisions and procedures herein contained.

Time is of the essence of each and all of the terms and provisions of this Multi-Use License.

LICENSEE agrees that it does not and shall not claim, at any time, any interest or estate of any kind or extent whatsoever in the premises by virtue of this Multi-Use License or its occupancy or use hereunder.

If any action is needed to enforce the provisions of this contract, LICENSEE shall pay all expenses of the LICENSOR incurred thereby, including but not limited to, attorney's fees and interest.

This Multi-Use License shall be recorded.

IN WITNESS WHEREOF the parties hereto have executed this agreement the day and year first above written.

REVIEWED AND RECOMMENDED BY:

District Engineer

REVIEWED AND RECOMMENDED BY:

Chief Right-of-Way Agent

APPROVED FOR LEGALITY AND FORM:

Deputy Attorney General

S
E
A
L

STATE OF NEVADA acting by and through its Department of Transportation:

Director

STATE OF _____

On this _____ day of _____, 19 _____, personally appeared before me, the undersigned, a Notary Public in and for the _____, State of _____,

known to me to be the person described in and who executed the foregoing instrument who acknowledged to me that he executed the same freely and voluntarily and for the uses and purposes thereby mentioned.

S
E
A
L

IN WITNESS WHEREOF I have hereunto set my hand and affixed my official seal the day and year in this certificate first above written.

STATE OF NEVADA
CARSON CITY

On this _____ day of _____, 19 _____, personally appeared before me, the undersigned, a Notary Public in and for Carson City, State of Nevada, _____ known to me to be the _____ Director of the Department of Transportation of the State of Nevada who executed the foregoing instrument for the Nevada Department of Transportation under authorization of Nevada Revised Statute Chapter 408.205; that he affirms that the seal affixed to said instrument is the seal of said Department; and that said instrument was executed for the Nevada Department of Transportation freely and voluntarily and for the uses and purposes therein mentioned.

S
E
A
L

IN WITNESS WHEREOF I have hereunto set my hand and affixed my official seal the day and year in this certificate first above written.

DOT
030-057
rev. 9/86

NEW HAMPSHIRE

- Legislation

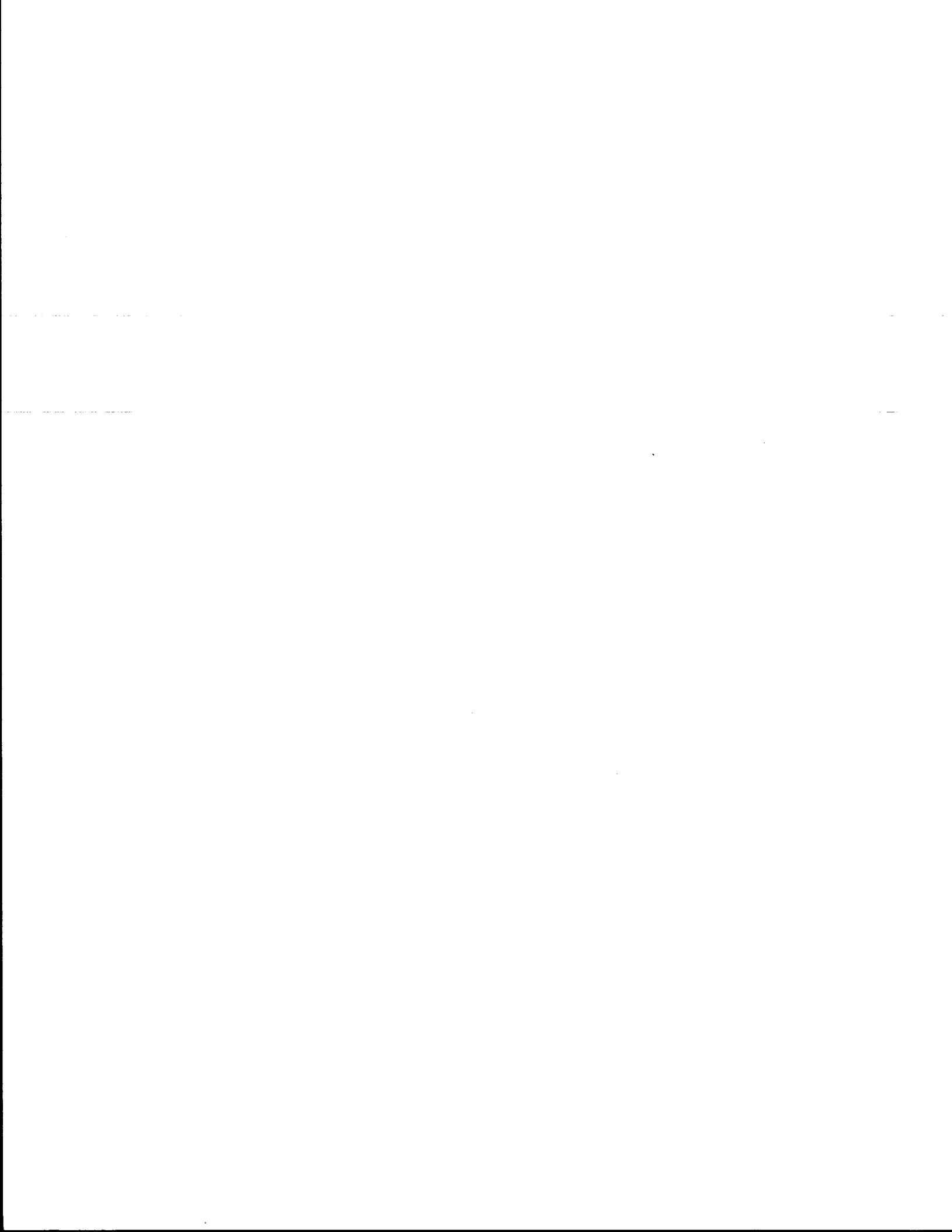

effect on the date the department of transportation established by the act becomes operational on the date set according to 1983, 372: 5, II. 1983, 372: 5, II, is set out in a note following the analysis for RSA 21-G.

Pursuant to 1983, 372: 5, II, the joint committee on implementation of reorgani-

zation approved the plan implementing the department of transportation at a meeting held on Jan. 13, 1986. The joint committee on implementation of reorganization and the governor determined the effective date upon which the department became fully operational to be Feb. 28, 1986.

230: 49-a Replacement or New Signs. Whenever the commissioner of transportation authorizes the replacement of an existing highway sign or the installation of a new highway sign which designates that a city or town lies ahead, that sign shall also state the distance in miles from the sign to the city or town limits that the motorist will first approach.

Source. 1985, 415: 3, eff. July 3, 1985.

Revision note. At the beginning of the section, substituted "commissioner of transportation" for "commissioner of public works and highways" pursuant to 1985, 402: 6, II. 1985, 402: 2, I, provided for the abolition of the department of public works and highways and the transfer of the functions, powers, duties and officials of that department to the department of transportation as established by 1985, 402: 1. 1985, 402: 2, VII, provided that the abolition of the department of public works and highways and the transfers

authorized by 1985, 402: 2, I, were to take effect on the date the department of transportation becomes operational on the date set according to 1983, 372: 5, II. 1983, 372: 5, II, is set out in a note following the analysis for RSA 21-G.

Pursuant to 1983, 372: 5, II, the joint committee on implementation of reorganization approved the plan implementing the department of transportation at a meeting held on Jan. 13, 1986. The joint committee on implementation of reorganization and the governor determined the effective date upon which the department became fully operational to be Feb. 28, 1986.

230: 51 Auxiliary Roads. Any service roads constructed by the state in conjunction with but not a part of a limited access facility shall be classified by the commissioner of transportation as a class IV, V or VI highway. After any such classification the provisions of RSA 230: 52 and 53 shall not apply and thereafter the towns or cities shall maintain any road classified as class IV or V and the highway user shall maintain any road classified as class VI.

Source. RSA 236: 7-a. 1961, 6: 1. 1971, 29: 1. 1981, 87: 1. 1985, 402: 6, I(b)(2).

Amendments—1985. Substituted "commissioner of transportation" for "commissioner of public works and highways" in the first sentence.

Effective date of 1985 amendment. 1985, 402: 41, II, provided that the provision of the act amending this section was to take effect on the date the department of transportation established by the act becomes operational on the date set according to

1983, 372: 5, II. 1983, 372: 5, II, is set out in a note following the analysis for RSA 21-G.

Pursuant to 1983, 372: 5, II, the joint committee on implementation of reorganization approved the plan implementing the department of transportation at a meeting held on Jan. 13, 1986. The joint committee on implementation of reorganization and the governor determined the effective date upon which the department became fully operational to be Feb. 28, 1986.

230: 52 Exclusion of Commercial Enterprises.

I. No commercial enterprise or activities shall be authorized or conducted by the commissioner of transportation or any other agency of the state within or on the property acquired for or designated as a limited access facility.

II. Notwithstanding the provisions of RSA 230: 52, I, advertising space and other traveler information services may be rented for a fee established

effect on the date the department of transportation established by the act becomes operational on the date set according to 1983, 372: 5, II. 1983, 372: 5, II, is set out in a note following the analysis for RSA 21-G.

Pursuant to 1983, 372: 5, II, the joint committee on implementation of reorgani-

zation approved the plan implementing the department of transportation at a meeting held on Jan. 13, 1986. The joint committee on implementation of reorganization and the governor determined the effective date upon which the department became fully operational to be Feb. 28, 1986.

230: 49-a Replacement or New Signs. Whenever the commissioner of transportation authorizes the replacement of an existing highway sign or the installation of a new highway sign which designates that a city or town lies ahead, that sign shall also state the distance in miles from the sign to the city or town limits that the motorist will first approach.

Source. 1985, 415: 3, eff. July 3, 1985.

Revision note. At the beginning of the section, substituted "commissioner of transportation" for "commissioner of public works and highways" pursuant to 1985, 402: 6, II. 1985, 402: 2, I, provided for the abolition of the department of public works and highways and the transfer of the functions, powers, duties and officials of that department to the department of transportation as established by 1985, 402: 1. 1985, 402: 2, VII, provided that the abolition of the department of public works and highways and the transfers

authorized by 1985, 402: 2, I, were to take effect on the date the department of transportation becomes operational on the date set according to 1983, 372: 5, II. 1983, 372: 5, II, is set out in a note following the analysis for RSA 21-G.

Pursuant to 1983, 372: 5, II, the joint committee on implementation of reorganization approved the plan implementing the department of transportation at a meeting held on Jan. 13, 1986. The joint committee on implementation of reorganization and the governor determined the effective date upon which the department became fully operational to be Feb. 28, 1986.

230: 51 Auxiliary Roads. Any service roads constructed by the state in conjunction with but not a part of a limited access facility shall be classified by the commissioner of transportation as a class IV, V or VI highway. After any such classification the provisions of RSA 230: 52 and 53 shall not apply and thereafter the towns or cities shall maintain any road classified as class IV or V and the highway user shall maintain any road classified as class VI.

Source. RSA 236: 7-a. 1961, 6: 1. 1971, 29: 1. 1981, 87: 1. 1985, 402: 6, I(b)(2).

Amendments—1985. Substituted "commissioner of transportation" for "commissioner of public works and highways" in the first sentence.

Effective date of 1985 amendment. 1985, 402: 41, II, provided that the provision of the act amending this section was to take effect on the date the department of transportation established by the act becomes operational on the date set according to

1983, 372: 5, II. 1983, 372: 5, II, is set out in a note following the analysis for RSA 21-G.

Pursuant to 1983, 372: 5, II, the joint committee on implementation of reorganization approved the plan implementing the department of transportation at a meeting held on Jan. 13, 1986. The joint committee on implementation of reorganization and the governor determined the effective date upon which the department became fully operational to be Feb. 28, 1986.

230: 52 Exclusion of Commercial Enterprises.

I. No commercial enterprise or activities shall be authorized or conducted by the commissioner of transportation or any other agency of the state within or on the property acquired for or designated as a limited access facility.

II. Notwithstanding the provisions of RSA 230: 52, I, advertising space and other traveler information services may be rented for a fee established

by the commissioner of transportation, with the advice and cooperation of the office of vacation travel, by rules adopted under RSA 541-A. The amount of the fee shall not exceed a fair portion of the cost of maintaining the service. Fees collected under this paragraph shall be deposited as provided in RSA 236:86, III.

Source. 1945, 188:1, part 7:8. 1950, 5:1, part 9:1, par. 2. RSA 236:8. 1981, 87:1. 1985, 402:6, I(b)(2). 1987, 209:1, eff. July 14, 1987.

Amendments—1985. Substituted “commissioner of transportation” for “state commissioner of public works and highways”.

—1987. Designated the existing provisions of the section as par. I and added par. II.

Effective date of 1985 amendment. 1985, 402:41, II, provided that the provision of the act amending this section was to take

effect on the date the department of transportation established by the act becomes operational on the date set according to 1983, 372:5, II. 1983, 372:5, II, is set out in a note following the analysis for RSA 21-G.

Pursuant to 1983, 372:5, II, the joint committee on implementation of reorganization approved the plan implementing the department of transportation at a meeting held on Jan. 13, 1986. The joint committee on implementation of reorganization and the governor determined the effective date upon which the department became fully operational to be Feb. 28, 1986.

CROSS REFERENCES

Adoption of rules by commissioner of transportation generally, see RSA 21-L:12, 12-a.

Authorization for installation of vending machines in state highway rest area facilities, see RSA 230:30-a.

230:53 Regulations; Posting. The commissioner of transportation may regulate, restrict, or prohibit the use of such limited access facilities by trucks, buses and other commercial vehicles, may regulate or prohibit the use of such facilities by all other types of vehicles, and may regulate or prohibit other use of such facilities. Such regulations shall be posted on every such highway and a return thereof shall be filed with the department of transportation to be kept in a special book which shall be open to public inspection.

Source. 1943, 79:1, par. 6. 1945, 188:1, part 7:9. 1950, 5:1, part 9:1, par. 2. RSA 236:9. 1961, 2:1. 1981, 87:1. 1985, 402:6, I(a)(2), (b)(2).

Amendments—1985. Substituted “commissioner of transportation” for “commissioner of public works and highways” in the first sentence and “department of transportation” for “state department of public works and highways” in the second sentence.

Effective date of 1985 amendment. 1985, 402:41, II, provided that the provision of the act amending this section was to take

effect on the date the department of transportation established by the act becomes operational on the date set according to 1983, 372:5, II. 1983, 372:5, II, is set out in a note following the analysis for RSA 21-G.

Pursuant to 1983, 372:5, II, the joint committee on implementation of reorganization approved the plan implementing the department of transportation at a meeting held on Jan. 13, 1986. The joint committee on implementation of reorganization and the governor determined the effective date upon which the department became fully operational to be Feb. 28, 1986.

Discontinuance of Relocated Portions of Class I and Class II Highways

230:55 Notice of Finding. Whenever the commissioner of transportation shall alter or relocate any portion of any class I or class II highway, and finds that there is no further occasion to use such portion for class I or class II highway purposes, he shall post notice of such finding in 2

which the water in a stream, pond or ditch is turned upon the highway and injures or renders it unsuitable for public travel, shall be guilty of a violation if a natural person, or guilty of a misdemeanor if any other person. If such highway is maintained by the town, the fine shall be for the use of the town and if such highway is maintained by the state, the fine shall be for the use of the department of transportation. Nothing in this section shall be construed as prohibiting the placing of snow within the limits of a highway for the purpose of crossing or recrossing by sleds, logging or farming equipment.

Source. 1881, 50:1. PS 77:12. PL 92:13. 1941, 41:1. RL 108:13. 1945, 188:1, part 19:17. RSA 249:22. 1973, 530:27. 1981, 87:1. 1985, 402:6, I(a)(7).

Amendments—1985. Substituted “department of transportation” for “department of public works and highways” at the end of the second sentence.

Effective date of 1985 amendment. 1985, 402:41, II, provided that the provision of the act amending this section was to take effect on the date the department of transportation established by the act becomes

operational on the date set according to 1983, 372:5, II. 1983, 372:5, II, is set out in a note following the analysis for RSA 21-G.

Pursuant to 1983, 372:5, II, the joint committee on implementation of reorganization approved the plan implementing the department of transportation at a meeting held on Jan. 13, 1986. The joint committee on implementation of reorganization and the governor determined the effective date upon which the department became fully operational to be Feb. 28, 1986.

236: 22 Removal of Fences Obstructing.

236: 23 —Service of Notice. Such notice may be served by any agent of the department of transportation on such owner or occupant or his agent.

Source. 1945, 188:1, part 19:20. RSA 249:25. 1981, 87:1. 1985, 402:6, I(a)(7).

Amendments—1985. Substituted “department of transportation” for “department of public works and highways”.

Effective date of 1985 amendment. 1985, 402:41, II, provided that the provision of the act amending this section was to take effect on the date the department of transportation established by the act becomes operational on the date set according to

1983, 372:5, II. 1983, 372:5, II, is set out in a note following the analysis for RSA 21-G.

Pursuant to 1983, 372:5, II, the joint committee on implementation of reorganization approved the plan implementing the department of transportation at a meeting held on Jan. 13, 1986. The joint committee on implementation of reorganization and the governor determined the effective date upon which the department became fully operational to be Feb. 28, 1986.

General Provisions

236: 29 Removal of Obstructions. The department of transportation may remove all obstructions in class I, class II or class III highways, and the highway agent of any city or town may remove all obstructions on any other highway and on town maintained portions of class II highways.

Source. 1917, 154:1. PL 91:10. RL 107:13. 1945, 188:1, part 19:24. RSA 249:29. 1981, 87:1. 1985, 402:6, I(a)(7).

Amendments—1985. Substituted “department of transportation” for “state department of public works and highways”.

Effective date of 1985 amendment. 1985, 402:41, II, provided that the provision of the act amending this section was to take effect on the date the department of transportation established by the act becomes operational on the date set according to

1983, 372:5, II. 1983, 372:5, II, is set out in a note following the analysis for RSA 21-G.

Pursuant to 1983, 372:5, II, the joint committee on implementation of reorganization approved the plan implementing the department of transportation at a meeting held on Jan. 13, 1986. The joint committee on implementation of reorganization and the governor determined the effective date upon which the department became fully operational to be Feb. 28, 1986.

ble, in accordance with subsection (i) of section 131, of Title 23, United States Code.

Source. RSA 249-A:17. 1969, 429:1. 1971, 245:1. 1981, 87:1. 1985, 402:6, I(b)(7). 1987, 209:2, eff. July 14, 1987.

Amendments—1985. Substituted “commissioner of transportation” for “commissioner of public works and highways” at the beginning of the first sentence.

—1987. Designated the existing provisions of the section as par. I and added pars. II-V.

Effective date of 1985 amendment. 1985, 402:41, II, provided that the provision of the act amending this section was to take effect on the date the department of trans-

portation established by the act becomes operational on the date set according to 1983, 372:5, II. 1983, 372:5, II, is set out in a note following the analysis for RSA 21-G.

Pursuant to 1983, 372:5, II, the joint committee on implementation of reorganization approved the plan implementing the department of transportation at a meeting held on Jan. 13, 1986. The joint committee on implementation of reorganization and the governor determined the effective date upon which the department became fully operational to be Feb. 23, 1986.

236:88 Advertising Devices Within Highway Rights-of-Way. Any advertising device so located as to be within the right-of-way of any interstate, federal aid primary, federal aid secondary, or turnpike highway shall be deemed to be illegally located. Removal and disposal of said device shall be effected after 10 days' written notice to the owner of said device, provided the identity and mailing address of the owner are displayed on the device, by the department of transportation.

Source. RSA 249-A:19. 1971, 245:1. 1981, 87:1. 1985, 402:6, I(a)(7).

Amendments—1985. Substituted “commissioner of transportation” for “commissioner of public works and highways” at the end of the second sentence.

Effective date of 1985 amendment. 1985, 402:41, II, provided that the provision of the act amending this section was to take effect on the date the department of transportation established by the act becomes operational on the date set according to

1983, 372:5, II. 1983, 372:5, II, is set out in a note following the analysis for RSA 21-G.

Pursuant to 1983, 372:5, II, the joint committee on implementation of reorganization approved the plan implementing the department of transportation at a meeting held on Jan. 13, 1986. The joint committee on implementation of reorganization and the governor determined the effective date upon which the department became fully operational to be Feb. 23, 1986.

Control of Junk Yards

236:90 Policy.

ANNOTATIONS

1. Cited

Cited in *State v. Bryant* (1985) 127 NE 69, 493 A2d 322.

236:91 Definitions.

[No changes in paragraphs I-III.]

IV. “Junk yard” means an establishment or place of business which is maintained, operated, or used for storing, keeping, buying or selling junk, or for the maintenance or operation of an automobile graveyard, and includes garbage dumps and sanitary fills. The word does not include any motor vehicle dealers registered with the director of motor vehicles under RSA 261:104 and controlled under RSA 236:126.

[No changes in paragraphs V-X.]



effect on the date the department of transportation established by the act becomes operational on the date set according to 1983, 372: 5, II. 1983, 372: 5, II, is set out in a note following the analysis for RSA 21-G.

Pursuant to 1983, 372: 5, II, the joint committee on implementation of reorgani-

zation approved the plan implementing the department of transportation at a meeting held on Jan. 13, 1986. The joint committee on implementation of reorganization and the governor determined the effective date upon which the department became fully operational to be Feb. 28, 1986.

230: 49-a Replacement or New Signs. Whenever the commissioner of transportation authorizes the replacement of an existing highway sign or the installation of a new highway sign which designates that a city or town lies ahead, that sign shall also state the distance in miles from the sign to the city or town limits that the motorist will first approach.

Source. 1985, 415: 3, eff. July 3, 1985.

Revision note. At the beginning of the section, substituted "commissioner of transportation" for "commissioner of public works and highways" pursuant to 1985, 402: 6, II. 1985, 402: 2, I, provided for the abolition of the department of public works and highways and the transfer of the functions, powers, duties and officials of that department to the department of transportation as established by 1985, 402: 1. 1985, 402: 2, VII, provided that the abolition of the department of public works and highways and the transfers

authorized by 1985, 402: 2, I, were to take effect on the date the department of transportation becomes operational on the date set according to 1983, 372: 5, II. 1983, 372: 5, II, is set out in a note following the analysis for RSA 21-G.

Pursuant to 1983, 372: 5, II, the joint committee on implementation of reorganization approved the plan implementing the department of transportation at a meeting held on Jan. 13, 1986. The joint committee on implementation of reorganization and the governor determined the effective date upon which the department became fully operational to be Feb. 28, 1986.

230: 51 Auxiliary Roads. Any service roads constructed by the state in conjunction with but not a part of a limited access facility shall be classified by the commissioner of transportation as a class IV, V or VI highway. After any such classification the provisions of RSA 230: 52 and 53 shall not apply and thereafter the towns or cities shall maintain any road classified as class IV or V and the highway user shall maintain any road classified as class VI.

Source. RSA 236: 7-a. 1961, 6: 1. 1971, 29: 1. 1981, 87: 1. 1985, 402: 6, I(b)(2).

Amendments—1985. Substituted "commissioner of transportation" for "commissioner of public works and highways" in the first sentence.

Effective date of 1985 amendment. 1985, 402: 41, II, provided that the provision of the act amending this section was to take effect on the date the department of transportation established by the act becomes operational on the date set according to

1983, 372: 5, II. 1983, 372: 5, II, is set out in a note following the analysis for RSA 21-G.

Pursuant to 1983, 372: 5, II, the joint committee on implementation of reorganization approved the plan implementing the department of transportation at a meeting held on Jan. 13, 1986. The joint committee on implementation of reorganization and the governor determined the effective date upon which the department became fully operational to be Feb. 28, 1986.

230: 52 Exclusion of Commercial Enterprises.

I. No commercial enterprise or activities shall be authorized or conducted by the commissioner of transportation or any other agency of the state within or on the property acquired for or designated as a limited access facility.

II. Notwithstanding the provisions of RSA 230: 52, I, advertising space and other traveler information services may be rented for a fee established

effect on the date the department of transportation established by the act becomes operational on the date set according to 1983, 372: 5, II. 1983, 372: 5, II, is set out in a note following the analysis for RSA 21-G.

Pursuant to 1983, 372: 5, II, the joint committee on implementation of reorgani-

zation approved the plan implementing the department of transportation at a meeting held on Jan. 13, 1986. The joint committee on implementation of reorganization and the governor determined the effective date upon which the department became fully operational to be Feb. 28, 1986.

230: 49-a Replacement or New Signs. Whenever the commissioner of transportation authorizes the replacement of an existing highway sign or the installation of a new highway sign which designates that a city or town lies ahead, that sign shall also state the distance in miles from the sign to the city or town limits that the motorist will first approach.

Source. 1985, 415: 3, eff. July 3, 1985.

Revision note. At the beginning of the section, substituted "commissioner of transportation" for "commissioner of public works and highways" pursuant to 1985, 402: 6, II. 1985, 402: 2, I, provided for the abolition of the department of public works and highways and the transfer of the functions, powers, duties and officials of that department to the department of transportation as established by 1985, 402: 1. 1985, 402: 2, VII, provided that the abolition of the department of public works and highways and the transfers

authorized by 1985, 402: 2, I, were to take effect on the date the department of transportation becomes operational on the date set according to 1983, 372: 5, II. 1983, 372: 5, II, is set out in a note following the analysis for RSA 21-G.

Pursuant to 1983, 372: 5, II, the joint committee on implementation of reorganization approved the plan implementing the department of transportation at a meeting held on Jan. 13, 1986. The joint committee on implementation of reorganization and the governor determined the effective date upon which the department became fully operational to be Feb. 28, 1986.

230: 51 Auxiliary Roads. Any service roads constructed by the state in conjunction with but not a part of a limited access facility shall be classified by the commissioner of transportation as a class IV, V or VI highway. After any such classification the provisions of RSA 230: 52 and 53 shall not apply and thereafter the towns or cities shall maintain any road classified as class IV or V and the highway user shall maintain any road classified as class VI.

Source. RSA 236: 7-a. 1961, 6: 1. 1971, 29: 1. 1981, 87: 1. 1985, 402: 6, I(b)(2).

Amendments—1985. Substituted "commissioner of transportation" for "commissioner of public works and highways" in the first sentence.

Effective date of 1985 amendment. 1985, 402: 41, II, provided that the provision of the act amending this section was to take effect on the date the department of transportation established by the act becomes operational on the date set according to

1983, 372: 5, II. 1983, 372: 5, II, is set out in a note following the analysis for RSA 21-G.

Pursuant to 1983, 372: 5, II, the joint committee on implementation of reorganization approved the plan implementing the department of transportation at a meeting held on Jan. 13, 1986. The joint committee on implementation of reorganization and the governor determined the effective date upon which the department became fully operational to be Feb. 28, 1986.

230: 52 Exclusion of Commercial Enterprises.

I. No commercial enterprise or activities shall be authorized or conducted by the commissioner of transportation or any other agency of the state within or on the property acquired for or designated as a limited access facility.

II. Notwithstanding the provisions of RSA 230: 52, I, advertising space and other traveler information services may be rented for a fee established

by the commissioner of transportation, with the advice and cooperation of the office of vacation travel, by rules adopted under RSA 541-A. The amount of the fee shall not exceed a fair portion of the cost of maintaining the service. Fees collected under this paragraph shall be deposited as provided in RSA 236: 86, III.

Source. 1945, 188: 1, part 7: 8. 1950, 5: 1, part 9: 1, par. 2. RSA 236: 8. 1981, 87: 1. 1985, 402: 6, I(b)(2). 1987, 209: 1, eff. July 14, 1987.

Amendments—1985. Substituted “commissioner of transportation” for “state commissioner of public works and highways”.

—1987. Designated the existing provisions of the section as par. I and added par. II.

Effective date of 1985 amendment. 1985, 402: 41, II, provided that the provision of the act amending this section was to take

effect on the date the department of transportation established by the act becomes operational on the date set according to 1983, 372: 5, II. 1983, 372: 5, II, is set out in a note following the analysis for RSA 21-G.

Pursuant to 1983, 372: 5, II, the joint committee on implementation of reorganization approved the plan implementing the department of transportation at a meeting held on Jan. 13, 1986. The joint committee on implementation of reorganization and the governor determined the effective date upon which the department became fully operational to be Feb. 28, 1986.

CROSS REFERENCES

Adoption of rules by commissioner of transportation generally, see RSA 21-L: 12, 12-a.

Authorization for installation of vending machines in state highway rest area facilities, see RSA 230: 30-a.

230: 53 Regulations; Posting. The commissioner of transportation may regulate, restrict, or prohibit the use of such limited access facilities by trucks, buses and other commercial vehicles, may regulate or prohibit the use of such facilities by all other types of vehicles, and may regulate or prohibit other use of such facilities. Such regulations shall be posted on every such highway and a return thereof shall be filed with the department of transportation to be kept in a special book which shall be open to public inspection.

Source. 1943, 79: 1, par. 6. 1945, 188: 1, part 7: 9. 1950, 5: 1, part 9: 1, par. 2. RSA 236: 9. 1961, 2: 1. 1981, 87: 1. 1985, 402: 6, I(a)(2), (b)(2).

Amendments—1985. Substituted “commissioner of transportation” for “commissioner of public works and highways” in the first sentence and “department of transportation” for “state department of public works and highways” in the second sentence.

Effective date of 1985 amendment. 1985, 402: 41, II, provided that the provision of the act amending this section was to take

effect on the date the department of transportation established by the act becomes operational on the date set according to 1983, 372: 5, II. 1983, 372: 5, II, is set out in a note following the analysis for RSA 21-G.

Pursuant to 1983, 372: 5, II, the joint committee on implementation of reorganization approved the plan implementing the department of transportation at a meeting held on Jan. 13, 1986. The joint committee on implementation of reorganization and the governor determined the effective date upon which the department became fully operational to be Feb. 28, 1986.

Discontinuance of Relocated Portions of Class I and Class II Highways

230: 55 Notice of Finding. Whenever the commissioner of transportation shall alter or relocate any portion of any class I or class II highway, and finds that there is no further occasion to use such portion for class I or class II highway purposes, he shall post notice of such finding in 2

which the water in a stream, pond or ditch is turned upon the highway and injures or renders it unsuitable for public travel, shall be guilty of a violation if a natural person, or guilty of a misdemeanor if any other person. If such highway is maintained by the town, the fine shall be for the use of the town and if such highway is maintained by the state, the fine shall be for the use of the department of transportation. Nothing in this section shall be construed as prohibiting the placing of snow within the limits of a highway for the purpose of crossing or recrossing by sleds, logging or farming equipment.

Source. 1881, 50: 1. PS 77:12. PL 92: 13. 1941, 41: 1. RL 108: 13. 1945, 188: 1, part 19: 17. RSA 249: 22. 1973, 530: 27. 1981, 87: 1. 1985, 402: 6, I(a)(7).

Amendments—1985. Substituted “department of transportation” for “department of public works and highways” at the end of the second sentence.

Effective date of 1985 amendment. 1985, 402: 41, II, provided that the provision of the act amending this section was to take effect on the date the department of transportation established by the act becomes

operational on the date set according to 1983, 372: 5, II. 1983, 372: 5, II, is set out in a note following the analysis for RSA 21-G.

Pursuant to 1983, 372: 5, II, the joint committee on implementation of reorganization approved the plan implementing the department of transportation at a meeting held on Jan. 13, 1986. The joint committee on implementation of reorganization and the governor determined the effective date upon which the department became fully operational to be Feb. 28, 1986.

236: 22 Removal of Fences Obstructing.

236: 23 —Service of Notice. Such notice may be served by any agent of the department of transportation on such owner or occupant or his agent.

Source. 1945, 188: 1, part 19: 20. RSA 249: 25. 1981, 87: 1. 1985, 402: 6, I(a)(7).

Amendments—1985. Substituted “department of transportation” for “department of public works and highways”.

Effective date of 1985 amendment. 1985, 402: 41, II, provided that the provision of the act amending this section was to take effect on the date the department of transportation established by the act becomes operational on the date set according to

1983, 372: 5, II. 1983, 372: 5, II, is set out in a note following the analysis for RSA 21-G.

Pursuant to 1983, 372: 5, II, the joint committee on implementation of reorganization approved the plan implementing the department of transportation at a meeting held on Jan. 13, 1986. The joint committee on implementation of reorganization and the governor determined the effective date upon which the department became fully operational to be Feb. 28, 1986.

General Provisions

236: 29 Removal of Obstructions. The department of transportation may remove all obstructions in class I, class II or class III highways, and the highway agent of any city or town may remove all obstructions on any other highway and on town maintained portions of class II highways.

Source. 1917, 154: 1. PL 91: 10. RL 107: 13. 1945, 188: 1, part 19: 24. RSA 249: 29. 1981, 87: 1. 1985, 402: 6, I(a)(7).

Amendments—1985. Substituted “department of transportation” for “state department of public works and highways”.

Effective date of 1985 amendment. 1985, 402: 41, II, provided that the provision of the act amending this section was to take effect on the date the department of transportation established by the act becomes operational on the date set according to

1983, 372: 5, II. 1983, 372: 5, II, is set out in a note following the analysis for RSA 21-G.

Pursuant to 1983, 372: 5, II, the joint committee on implementation of reorganization approved the plan implementing the department of transportation at a meeting held on Jan. 13, 1986. The joint committee on implementation of reorganization and the governor determined the effective date upon which the department became fully operational to be Feb. 28, 1986.

ble, in accordance with subsection (i) of section 131, of Title 23, United States Code.

Source. RSA 249-A:17. 1969, 429:1. 1971, 245:1. 1981, 87:1. 1985, 402:6, I(b)(7). 1987, 209:2, eff. July 14, 1987.

Amendments—1985. Substituted “commissioner of transportation” for “commissioner of public works and highways” at the beginning of the first sentence.

—1987. Designated the existing provisions of the section as par. I and added pars. II-V.

Effective date of 1985 amendment. 1985, 402:41, II, provided that the provision of the act amending this section was to take effect on the date the department of trans-

portation established by the act becomes operational on the date set according to 1983, 372:5, II. 1983, 372:5, II, is set out in a note following the analysis for RSA 21-G.

Pursuant to 1983, 372:5, II, the joint committee on implementation of reorganization approved the plan implementing the department of transportation at a meeting held on Jan. 13, 1986. The joint committee on implementation of reorganization and the governor determined the effective date upon which the department became fully operational to be Feb. 28, 1986.

236:88 Advertising Devices Within Highway Rights-of-Way. Any advertising device so located as to be within the right-of-way of any interstate, federal aid primary, federal aid secondary, or turnpike highway shall be deemed to be illegally located. Removal and disposal of said device shall be effected after 10 days' written notice to the owner of said device, provided the identity and mailing address of the owner are displayed on the device, by the department of transportation.

Source. RSA 249-A:19. 1971, 245:1. 1981, 87:1. 1985, 402:6, I(a)(7).

Amendments—1985. Substituted “commissioner of transportation” for “commissioner of public works and highways” at the end of the second sentence.

Effective date of 1985 amendment. 1985, 402:41, II, provided that the provision of the act amending this section was to take effect on the date the department of transportation established by the act becomes operational on the date set according to

1983, 372:5, II. 1983, 372:5, II, is set out in a note following the analysis for RSA 21-G.

Pursuant to 1983, 372:5, II, the joint committee on implementation of reorganization approved the plan implementing the department of transportation at a meeting held on Jan. 13, 1986. The joint committee on implementation of reorganization and the governor determined the effective date upon which the department became fully operational to be Feb. 28, 1986.

Control of Junk Yards

236:90 Policy.

ANNOTATIONS

I. Cited

Cited in *State v. Bryant* (1935) 127 NE 69, 493 A2d 322.

236:91 Definitions.

[No changes in paragraphs I-III.]

IV. “Junk yard” means an establishment or place of business which is maintained, operated, or used for storing, keeping, buying or selling junk, or for the maintenance or operation of an automobile graveyard, and includes garbage dumps and sanitary fills. The word does not include any motor vehicle dealers registered with the director of motor vehicles under RSA 261:104 and controlled under RSA 236:126.

[No changes in paragraphs V-X.]

NEW JERSEY

- Legislation

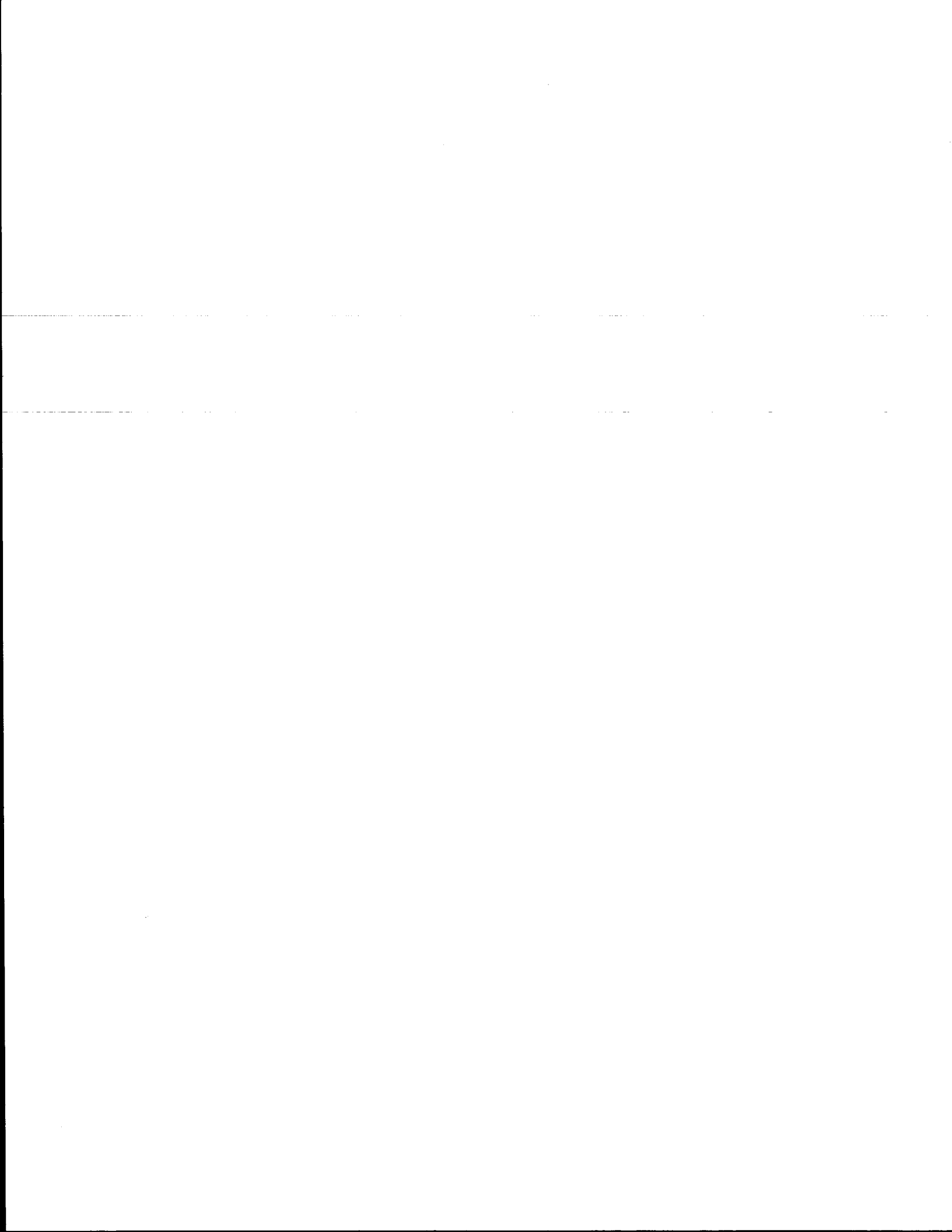

39:4-59. Begging rides prohibited

No person shall stand in a highway for the purpose of or while soliciting a ride from the operator of any vehicle other than an omnibus or a street car. As amended L.1951, c. 23, p. 78, § 34.

Library references: Automobiles ~~C~~324; C.J.S. Motor Vehicles § 714.

Historical Note

Source. L.1928, c. 281, Art. VII, § 3, stand in a roadway for the purpose of or while soliciting a ride from the operator of a private vehicle." p. 731.

Prior to amendment in 1951, this section provided: "No person shall

operator of a private vehicle."

39:4-60. Soliciting trade or contributions prohibited; designation of particular highway as hazardous for such purposes; signs

No person shall stand in the roadway of a highway to stop, impede, hinder or delay the progress of a vehicle for the purpose of soliciting the purchase of goods, merchandise or tickets, or for the purpose of soliciting contributions for any cause, and the only question of law and fact in determining guilt under this section shall be whether goods, merchandise or tickets were tendered or offered for sale, or whether a contribution was solicited.

In addition to the prohibition contained in the first paragraph of this section: whenever in his judgment the public safety so requires, the Director of the Division of Motor Vehicles may, by regulation, designate any highway or sections of any highway as a location wherein the standing of any person or the parking of any vehicle for the purpose of soliciting the purchase of goods, merchandise or tickets, or for the purpose of soliciting contributions for any cause, is deemed hazardous or inimical to the proper flow of traffic, and shall be prohibited. Each highway or section thereof so designated shall be clearly marked by appropriate signs which shall be erected and maintained by the authority having the responsibility for the maintenance of such highway, upon receipt by such authority of written notice from the director of the adoption of such regulation. No person shall stand in, and no operator shall allow a vehicle to stand in, any section of a highway so designated and marked to stop, impede, hinder or delay the progress of a vehicle for the purpose of soliciting the purchase of goods, merchandise or tickets, or for the purpose of soliciting contributions for any cause, and the only question of law and fact in determining guilt under this section shall be whether goods, merchandise or tickets were tendered or offered

OPERATION OF VEHICLES, ETC. 39:4-62

for sale, or whether a contribution was solicited. Whenever in his judgment the public safety so requires the Director of the Division of Motor Vehicles may, by regulation, amend or alter any designation made by him pursuant to the provisions of this paragraph. Nothing contained in this paragraph shall be construed to authorize or permit any person to stand in or to allow a vehicle to stand in any highway where the same is or shall be prohibited by any other provision of this Title or by any amendment thereof or supplement thereto, or by any ordinance, resolution, regulation or order duly adopted pursuant to authority thereunder. As amended L.1951, c. 23, p. 78, § 35.

Library references: Automobiles § 324, 333; C.J.S. Motor Vehicles §§ 684, 714.

Historical Note

Source. L.1928, c. 281, Art. VII, § 4, p. 731. The 1951 amendment added the second paragraph.

39:4-61. Tailboard riding

No person shall ride upon the rear end of a vehicle, without the consent of the driver, and when so riding, no part of the person's body shall protrude beyond the limits of the vehicle.

Historical Note

Source. L.1928, c. 281, Art. VII, § 11, p. 732.

Notes of Decisions

Library references

Automobiles 324.

C.J.S. Motor Vehicles § 714.

1. Care required

Fact that persons thrown from truck as it passed over rough railroad crossing were then riding on extended tailboard of truck held not

to establish contributory negligence on their part, where they were so riding with consent of driver, and there was no conclusive evidence that any part of their bodies protruded beyond limits of truck. *Lumley v. West Jersey & S. S. R. Co.*, 118 N.J.L. 140, 191 A. 792 (1937).

39:4-62. Leaving curb

A vehicle waiting at the curb shall promptly give place to a vehicle about to take on or let off passengers.

Library references: Automobiles § 5(5); C.J.S. Motor Vehicles § 27.

Historical Note

Source. L.1928, c. 281, Art. VII, § 13, p. 732.

NEW JERSEY

P. L. 1979, CHAPTER 66, approved April 4, 1979

1978 Assembly No. 1559

AN Act concerning the prohibition of commercial activity on State and interstate highway system rights of way and supplementing chapter 4 of Title 39 of the Revised Statutes.

1 BE IT ENACTED by the Senate and General Assembly of the State
2 of New Jersey:

1 1. No person shall tender or offer for sale goods or merchandise
2 of any kind, engage in any other commercial activity, or solicit
3 contributions for any cause, on any portion of the right of way of
4 a State or interstate highway system, including any rest areas
5 located on such right of way.

6 Nothing in this section shall be construed to inhibit the operation
7 of commercial traffic, the rendering of emergency services to
8 vehicles or travelers on the State or interstate highway system nor
9 the installation and use of public telephones at locations on the
10 rights of way approved by the State Department of Transportation.

1 2. This act shall take effect immediately.

TITLE 45

NEW JERSEY

45:23-4 PROFESSIONS AND OCCUPATIONS

tickets, coupons or other vouchers are to be redeemed by such merchant.

Library references: Trade-Regulation \Leftrightarrow 878; O.J.S. Trade-Marks, Trade-Names, and Unfair Competition \S 230.

Historical Note

Source. L.1905, c. 265, \S 5, p. 555 [C.S. p. 5649, \S 5].

CHAPTER 24

TRANSIENT MERCHANTS OR ITINERANT VENDORS; HAWKERS AND PEDDLERS

ARTICLE 1. TRANSIENT MERCHANTS OR ITINERANT VENDORS

Sec.

- 45:24-1. "Transient merchants" and "itinerant vendors" defined.
- 45:24-2. Declaration as to goods to be sold; contents.
- 45:24-3. License fee; payment before sale; term of license.
- 45:24-4. Application for license; contents; separate license for each location.
- 45:24-5. Bond; amount, term and conditions.
- 45:24-6. Appointment of licensing officer as agent for service of process.
- 45:24-7. Charitable, religious and historical societies unaffected.
- 45:24-8. Penalties.

ARTICLE 2. HAWKERS AND PEDDLERS

- 45:24-9. Special licenses to honorably discharged soldiers, sailors and marines, nurses or army field clerks and exempt firemen; ordinances on hawking, peddling and vending; "present emergency" defined.
- 45:24-9.1 Restriction on issue of licenses to soldiers, etc.
- 45:24-10. Issuance of license by county clerk; prerequisites.
- 45:24-11. Applicant's signature and photograph to appear on license.
- 45:24-12. Term of license to exempt firemen.
- 45:24-13. Sale or transfer of licenses by soldiers, sailors and marines; cancellation; misdemeanor.

ARTICLE 1. TRANSIENT MERCHANTS OR ITINERANT VENDORS

45:24-1. "Transient merchants" and "itinerant vendors" defined

The words "transient merchants" or "itinerant vendors", as used in this article, mean persons, corporations or partnerships, whether principal or agent, who engage in a merchandising business in New Jersey with intent to close out or discontinue such business within one year from the date of commencement, including those who for the purpose of carrying on such business, hire, lease or occupy any building, structure or railroad car for the exhibition and sale of such goods, wares and merchandise, but nothing in this article shall be construed to affect the sale of fruits, vegetables and farm products, such as meat, poultry, butter and eggs.

Historical Note

Source. L.1931, c. 88, § 1, p. 148.

Cross References

Camp meeting associations and seaside resorts, power to license, see §§ 40:05-1, 40:98-1.
Municipalities' power to license, see §§ 40:52-1 to 40:52-4.

Notes of Decisions

Library references

Licenses C-15(2).
C.J.S. Licenses § 30.

City of Newark, 44 N.J.Super. 530, 130 A.2d 907 (1957).

I. Construction and application

Possession of military veteran's license, issued by county clerk, to hawk, peddle and vend, did not exempt holder from necessity of obtaining transient merchant's license, imposed by city ordinance, in order to conduct business of selling children's toys during Christmas season, as word "vending" in statute respecting veterans' vending licenses is restricted to selling by one walking or driving about and does not include selling at fixed or permanent location. Shapiro v.

One leasing a store for three months, including Christmas season, for purpose of selling children's toys, without reserving right to extend lease, if such business prospered, was properly classed by city as "transient merchant" within ordinance imposing license fees on such merchants. Id.

Evidence in prosecution for violation of licensing ordinance held sufficient to show defendant was "itinerant vender" within L.1921, p. 478, repealed. Levin v. City of Asbury Park, 154 A. 742, 9 N.J.Misc. 515 (1931).

45:24-2 PROFESSIONS AND OCCUPATIONS

45:24-2. Declaration as to goods to be sold; contents

All transient merchants or itinerant vendors shall, before offering for sale any personal property, make a declaration, under oath, to the licensing official of the municipality in which they propose to conduct such sale, of the number of days they propose to engage in such business, together with a specific statement as to the location of such personal property by street and number and whether on the premises from which they are to be sold or in warehouses or storage.

Library references: Licenses \S 22; C.J.S. Licenses $\S\S$ 34, 38, 39.

Historical Note

Source. L.1931, c. 88, \S 2, p. 148.

45:24-3. License fee; payment before sale; term of license

All transient merchants or itinerant vendors shall, before offering for sale any personal property, pay to the licensing official of the municipality in which such sale is to take place, a sum of not more than one thousand dollars, and upon payment of such sum as may be specified in the ordinances of the municipality in which the transient merchant or itinerant vendor is to do business, he shall be entitled to apply for and receive a license which shall continue in favor of the person to whom it is issued for the period of one hundred and eighty days from the day of issuance.

Historical Note

Source. L.1931, c. 88, \S 3, p. 149.

Notes of Decisions

Construction and application Ordinances 2

Library references

Licenses \S 28.
C.J.S. Licenses $\S\S$ 46, 47.

1. Construction and application

Possession of military veteran's license, issued by county clerk, to hawk, peddle and vend. did not exempt holder from necessity of obtaining transient merchant's license, imposed by city ordinance, in order to conduct business of selling children's toys during Christmas season, as word "vending" in statute respecting veterans'

vending licenses is restricted to selling by one walking or driving about and does not include selling at fixed or permanent location. *Shapiro v. City of Newark*, 44 N.J. Super. 530, 130 A.2d 907 (1957).

This section impliedly authorized municipalities to enact ordinances regulating and authorizing issuance of licenses to such merchants. *Id.*

2. Ordinances

A license fee of \$1,000 for 180 days, fixed by city ordinance for transient merchants or itinerant vendors, as authorized by this section, was not invalid as confiscatory, in absence of showing that it was unreasonable as

not based on proper standard. *Shapiro v. City of Newark*, 44 N.J.Super. 530, 130 A.2d 907 (1957).

An ordinance purporting to put this article into effect, and requiring not only itinerants but "new merchants," defined as "person who engages in business for hiring premises and intending to remain longer than one year, to obtain license, was void as applied to new merchant, since it discriminated between newly established businesses and those already in

existence. *Heetner v. City of Newark*, 173 A. 339, 12 N.J.Misc. 560 (1934).

An ordinance exacting \$500 monthly license fee from itinerant vendors was not in conflict with the general act for licensing and regulating of itinerant vendors. L.1921, p. 478, repealed, in view of L.1927, p. 521, incorporated in § 40:52-1, conferring additional powers. *Levin v. City of Asbury Park*, 154 A. 742, 0 N.J.Misc. 515 (1931).

45:24-4. Application for license; contents; separate license for each location

All applications for such license shall be sworn to and shall disclose the name and residence of the owner or person in whose interest such business is conducted, and shall further state the average quantity and kind, as nearly as can be, and the value of the personal property intended to be sold or exposed for sale in that municipality. It shall also give the names and post-office addresses of the persons from which goods making up the stock were or are to be purchased and the licensing official of the municipality in arriving at the valuation may require the submission of bills or invoices of such personal property. A separate license shall be obtained for each branch, establishment or separate place of business in which the occupation of a transient merchant or itinerant vendor is carried on, and each license shall authorize the licensee to carry on, pursue or conduct the business of a transient merchant or itinerant vendor only at the location indicated thereby.

Library references: Licenses ⇐22; C.J.S. Licenses §§ 34, 38, 39.

Historical Note

Source. L.1931, c. 88, § 4, p. 140.

45:24-5. Bond; amount, term and conditions

Before a license shall issue, the applicant shall execute and deliver to the licensing official of the municipality, a good and sufficient bond with good and sufficient surety, to be approved by the licensing official, equal in amount to twenty-five per cent of the value of the personal property shown in the declarations and disclosures required under the provisions of this article, but in no event shall the bond be less than one thousand dollars. It shall

45:24-5 PROFESSIONS AND OCCUPATIONS

remain in force for one year, and be conditioned to indemnify and pay the municipality any penalties or costs incurred in the enforcement of any of the provisions of this article, and to indemnify or reimburse any purchaser of such personal property in a sum equal to at least the amount of any payment such purchaser may have been induced to make through the misrepresentation as to the kind, quality or value of the personal property, whether the misrepresentations were made by the owners or their servants, agents or employees, either at the time of making the sale or through any advertisement printed or circulated with reference to such personal property or any part thereof.

Library references: Licenses ↯26; C.J.S. Licenses § 36.

Historical Note

Source. L.1931, c. 88, § 5, p. 149.

45:24-6. Appointment of licensing officer as agent for service of process

Before a license shall issue, the applicant shall file with the licensing official of the municipality, an instrument in writing nominating and appointing the licensing official his true and lawful agent with full power and authority to acknowledge service or notice of process for and on behalf of the applicant in respect to any matters connected with or arising out of the license and the bond given as required by the provisions of section 45:24-5 of this title or for the performance of the conditions of the bond or for any breach thereof. It shall also contain recitals to the effect that the applicant consents and agrees that service of any notice or process may be made upon such agent and when so made shall be as valid as if personally served upon the applicant according to the laws of this or any other state, and waiving all claim or right of error by reason of such acknowledgment of service or manner of service.

Library references: Licenses ↯25; Process ↯80; C.J.S. Licenses § 35; C.J.S. Process § 50.

Historical Note

Source. L.1931, c. 88, § 6, p. 150.

45:24-7. Charitable, religious and historical societies unaffected

Nothing in this article shall apply to or require the obtaining of a license by any charitable or religious society that shall conduct sales of personal property when the proceeds thereof shall

be applied to the payment of the expenses thereof and to the charitable or religious object for which the society exists; and nothing in this article shall apply to or require the obtaining of a license by any art, antique or historical society that shall conduct an exhibition and sale of art objects, pictures, paintings, prints, historical articles and furniture generally known and designated as antiques and kindred objects; and nothing in this article shall apply to or require the obtaining of a license by any agricultural show, fair or garden society selling or closing out certain of their exhibits, if such society was an incorporated association not for pecuniary profit of this state prior to March twenty-sixth, one thousand nine hundred and thirty-five, or if incorporated subsequent thereto, such society shall have a bona fide membership of at least one hundred persons.

Library references: Licenses \Leftarrow 19(3); C.J.S. Licenses § 31.

Historical Note

Source. L.1931, c. 88, § 7, p. 151, as am. by L.1935, c. 128, § 1, p. 333.

45:24-8. Penalties

Any transient merchant or itinerant vendor who fails to comply with the requirements of this article or any part thereof, or makes a false or fraudulent representation in any statement required by this article to be filed by him, or falsely represents by advertising or otherwise that such personal property is in whole or in part damaged goods saved from fire, or makes any false statement as to the previous history or character of such personal property, shall be subject to a fine of not less than twenty-five dollars nor more than two hundred dollars, or may be committed for a period not exceeding ninety days, or both.

Library references: Licenses \Leftarrow 40; C.J.S. Licenses §§ 66, 67, 78; C.J.S. Trading Stamps and Coupons § 5.

Historical Note

Source. L.1931, c. 88, § 8, p. 151.

45:24-9 PROFESSIONS AND OCCUPATIONS

ARTICLE 2. HAWKERS AND PEDDLERS

45:24-9. Special license to honorably discharged soldiers, sailors, marines, nurses or army field clerks and exempt firemen; ordinances on hawking, peddling and vending; "present emergency" defined

The following persons shall have the right to hawk, peddle and vend any goods, wares or merchandise or solicit trade within this State, by procuring a license for that purpose to be issued in the manner and under the conditions hereinafter in this article prescribed, except, however, the aforesaid right to hawk, peddle and vend any goods, wares or merchandise or solicit trade shall not extend to or include any public beach or public boardwalk:

a. Every honorably discharged soldier, sailor, marine, nurse or army field clerk of the United States, having been in the active military or naval service of the United States in any war in which this country has been engaged prior to the World War, or in the Boxer uprising, the Philippine insurrection or the Mexican expedition, or in any Indian wars or uprisings, or in the World War prior to November 11, 1918, that is to say the date of the armistice, or in World War II subsequent to December 8, 1941, the date of declaration of war upon Japan, or who served or shall have served in the Armed Forces of the United States, during the present emergency, and who is a resident of this State.

b. Every exempt member of a volunteer fire department, volunteer fire engine, hook and ladder, hose, supply company or salvage corps, of any municipality or fire district in this State, who holds an exemption certificate issued to him as an exempt member of any such department, company or corps, and who is a resident of this State.

Hawking, peddling and vending hereafter may be regulated by municipal ordinance on public streets and highways.

The term "present emergency" as used in this act shall mean and include any time after June 23, 1950, and prior to the termination, suspension or revocation of the proclamation of the existence of a national emergency issued by the President of the United States on December 16, 1950, or termination of the existence of such national emergency by appropriate action of the President or Congress of the United States. As amended L.1943, c. 99, p. 322, § 1; L.1950, c. 156, p. 341, § 1; L.1952, c. 344, p. 1123, § 1; L.1955, c. 245, p. 922, § 1.

Historical Note

Sources. L.1911, c. 133, § 1, p. 190 [1924 Suppl. § *136-1520A(1)]. L.1904, c. 141, § 1, p. 273 [C.S. p. 3937, § 20], as am. by L.1934, c. 119, § 1, p. 319, L.1936, c. 242, § 1, p. 768. L.1936, c. 178, § 1, p. 420, suppl. to L.1904, c. 141, p. 273.

Passed over veto. Filed December 10, 1955. L.1955, c. 245, p. 922, § 4

provides that, "This act shall take effect July 1, 1955."

L.1952, c. 344, p. 1123, § 2, provides: "Nothing herein contained shall be deemed or construed to alter, modify, supersede, repeal, or in any way affect any of the provisions of Title 39 of the Revised Statutes."

Cross References

Hawking and peddling on public beach or boardwalk, see §§ 2A:170-69.2, 2A:170-69.3.

Notes of Decisions

Constitutionality 1
Construction and application 2
Ordinances 3
Validity 1
Veterans 4

violate it, sentence imposed for violation of ordinance would be suspended and fine imposed and costs assessed would be ordered refunded. Borough of Harrington Park v. Hogenbirk, 52 N.J.Super. 223, 145 A.2d 161 (1958).

Library references

Hawkers and Peddlers ↔4(1).et seq.
Licenses ↔20 et seq.
C.J.S. Hawkery and Peddlery § 7 et seq.
C.J.S. Licenses § 32 et seq.

Under 1952 and 1955 amendments of this section, license rights of veterans are subject to any reasonable regulations; and Harrington Park ordinance, which merely provided no one could park his vehicle on a public street and use it as a business stand to sell goods or merchandise to occupants of other vehicles moving or standing on highway, constituted a reasonable regulation and not a prohibition of veteran's hawking, peddling and vending privileges. Id.

1. Validity

L.1904, c. 141, p. 273, as amended by L.1931, c. 321, p. 796, and L.1934, c. 119, p. 319, incorporated in part in this section, did not violate constitutional prohibition against grant of exclusive privilege to any individual. Strauss v. Borough of Bradley Beach, 117 N.J.L. 45, 186 A. 681 (1936), affirmed 118 N.J.L. 561, 194 A. 160.

One engaged in buying junk in the city of Bayonne was not "hawking, peddling and vending merchandise," or "soliciting trade" within the meaning of this section, and his failure to procure a license from the municipality before engaging in such business was a violation of the local ordinance, for which violation he was properly convicted. Scerbo v. Bayonne Comm'rs, 43 N.J.L.J. 19 (1920).

2. Construction and application

In view of novelty of ordinance, providing that no one could park his vehicle on a public street and use it as a business stand to sell goods and merchandise to occupants of other vehicles moving or standing on highway, and of fact that defendant had apparently sought to test validity of ordinance rather than to flagrantly

3. Ordinances

This section authorizing honorably discharged soldiers to peddle wares within State, which gives municipalities power to regulate peddling, does not give such municipalities right to both regulate and license, and a municipi-

45:24-9 PROFESSIONS AND OCCUPATIONS

pal ordinance enacted pursuant to the statute, which sets up licensing requirements for veterans to peddle, is invalid regardless of municipal powers under §§ 40:179-103 and 40:52-1 and Const. art. 4, § 7, par. 11. *Tagmire v. Atlantic City*, 35 N.J.Super. 11, 113 A.2d 59 (1955).

Where all sections of municipal ordinance regulating licensing of peddlers were intimately related and formed integrated whole, fact that some provisions therein were illegal and unconstitutional rendered entire ordinance invalid. *Id.*

4. Veterans

Possession of military veteran's license, issued by county clerk, to hawk, peddle and vend, did not exempt holder from necessity of obtaining transient merchant's license, imposed by city ordinance, in order to conduct business of selling children's toys during Christmas season, as word "vending" in statute respecting veterans' vending licenses is restricted to selling by one walking or driving about and does not include selling at fixed or permanent location. *Shapiro v. City of Newark*, 44 N.J.Super. 530, 130 A.2d 907 (1957).

This section was designed to class veterans of various wars as a body and to entitle them to the privilege of peddling throughout the State, regardless of the action of municipalities, whether such action takes prohibitive or regulative form; and statute is applicable to State generally, making no exceptions, and if in conflict with municipal ordinance, latter must cease to be effective. *Germano v. Keenan*, 25 N.J.Super. 37, 95 A.2d 430 (1953).

A municipality may not curtail statutory right of duly licensed veteran to peddle, hawk or vend merchandise on city streets, but it may, by appropriate ordinance in exercise of its police power, control the setting up of stands or similar construction on city sidewalks which unduly restrict use of streets and sidewalks by general public. *City of Newark v. Germano*, 20 N.J.Super. 143, 89 A.2d 298 (1952).

Defendants were not immune from ordinance prohibiting sidewalk stands for sale of merchandise by virtue of their being World War II veterans possessing licenses to hawk goods. *Id.*

Where defendants' persistent violations of ordinance prohibiting sidewalk stands for sale of merchandise were based on sincere but mistaken belief in scope of their rights under statute licensing veterans to hawk goods, fines for such violations would be suspended. *Id.*

War veterans holding hawkers and peddlers license were entitled to injunction against extra-legal activities of municipal law enforcing officers interfering with veterans in peddling merchandise on municipal beach, notwithstanding that such peddling was contrary to municipal ordinance. *Higgins v. Krogman*, 142 N.J.Eq. 691, 61 A.2d 444 (1948).

War veterans holding hawkers and peddlers licenses issued under provision of this section authorizing special licenses to veterans were entitled to temporary restrain. against extra-legal activities of municipal law-enforcing officers interfering with veterans in peddling merchandise on municipal beach, notwithstanding that such peddling was contrary to municipal ordinance. *Higgins v. Krogman*, 140 N.J. Eq. 518, 55 A.2d 175 (1947), affirmed 142 N.J.Eq. 691, 61 A.2d 444.

War veterans holding hawkers and peddlers licenses issued under this section were not precluded from maintaining suit to enjoin municipal officials from interfering with veterans in hawking and peddling of merchandise upon city beach on ground that veterans came into court with "unclean hands" because of their violation of city ordinance specifically prohibiting peddling on the beach. *Id.*

A World War veteran who held license to peddle merchandise in state under this section was entitled to peddle in borough having ordinance prohibiting all peddling. *Strauss v. Borough of Bradley Beach*, 117 N.J.L. 45, 186 A. 681 (1936), affirmed 118 N.J. L. 561, 194 A. 160.

HAWKERS AND PEDDLERS 45:24-10

L.1904, p. 273, § 1, incorporated in this section, providing for licenses to honorably discharged soldiers, etc., to hawk, peddle, and vend goods, gave no right to such licensees to sell wares at fixed stand contrary to valid municipal ordinance requiring local license therefor. *Pevey v. Greenberg*, 101 N.J.L. 435, 128 A. 865 (1925).

45:24-9.1 Restriction on issue of licenses to soldiers, etc.

No license shall be issued to any person described in subparagraph "a" of section 45:24-9 of this title for hawking, peddling, and vending emblems, flags, natural or artificial flowers, magazines, pamphlets, postcards or any printed matter, or any article emblematic or symbolic of, or referring to the army, navy, marine corps, or any veterans' association, unless such licensee shall have been a bona fide resident of the county wherein he resides for three months immediately preceding the issuance of such license; and any such license shall be effective only in the county wherein such licensee resides.

Library references: *Hawkers and Peddlers* § 4(2); *C.J.S. Hawkerc and Peddlers* § 7.

Historical Note

Source. L.1904, c. 141, § 1, p. 273 [C.S. p. 3037, § 20], as am. by L.1934, c. 119, § 1, p. 319, L.1936, c. 242, § 1, p. 768.

45:24-10. Issuance of license by county clerk; prerequisites

In the case of an exempt fireman, on the presentation to the clerk of the county in which such person may be or resides of such certificate of exemption, the clerk shall issue without cost to such exempt fireman a license certifying him to be entitled to the benefits of this article.

In the case of an honorably discharged soldier, sailor, marine, nurse or army field clerk, on the presentation to the clerk of the county in which such person resides of an application sworn to by said applicant together with a certificate of honorable discharge from the army, navy or marine corps of the United States, which application shall also set forth that the applicant has resided within the state for at least six months and in the county at least three months immediately preceding his application for license, the county clerk shall forward a copy of such application to the adjutant general of the state for permanent record. The adjutant general, upon receipt of such copy, shall notify the county clerk whether or not such applicant has theretofore been a licensee and whether or not such license has been canceled. Upon receipt of notice from the adjutant general that such applicant

45:24-10 PROFESSIONS AND OCCUPATIONS

has not been the holder of a license theretofore canceled, the county clerk shall issue to such soldier, sailor, marine, nurse or army field clerk a license entitling him to the benefits of this article.

Historical Note

Sources. L.1911, c. 133, § 2, p. 190 [1924 Suppl. § *136-1520A(2)], as am. by L.1931, c. 346, § 1, p. 844. L.1904, c. 141, § 2, p. 274 [C.S. p. 3937, § 21], as am. by L.1931, c. 321, § 1, p. 796, L. 1934, c. 119, § 2, p. 319.

Notes of Decisions

Library references

Hawkers and Peddlers ⇐4(1).
C.J.S. Hawkery and Peddlers § 7.

1. Construction and application

Section 45:24-9 authorizing honorably discharged soldiers to peddle wares within State, which gives municipalities power to regulate peddling, does not give such municipali-

ties right to both regulate and license, and municipal ordinance enacted pursuant to the statute, which sets up licensing requirements for veterans to peddle, is invalid regardless of municipal powers under §§ 40:179-103 and 40:52-1 and Const. art. 4, § 7, par. 11. *Tagmire v. Atlantic City*, 35 N.J.Super. 11, 113 A.2d 59 (1955).

45:24-11. Applicant's signature and photograph to appear on license

Before a license issued pursuant to this article shall be valid the licensee shall affix his signature thereto in the presence of the county clerk or a duly authorized representative thereof, who shall sign as witness, and who shall affix thereto a photograph of the licensee which shall be supplied by the licensee, and shall be two inches by three inches in size. No license shall be valid without the photograph attached.

Library references: Hawkery and Peddlers ⇐4(1); C.J.S. Hawkery and Peddlers § 7.

Historical Note

Sources. L.1911, c. 133, § 2, p. 190 [1924 Suppl. § *136-1520A(2)], as am. by L.1931, c. 346, § 1, p. 844. L.1931, c. 321, § 3(2), p. 796.

45:24-12. Term of license to exempt firemen

Licenses issued pursuant to this article to exempt volunteer firemen shall expire three years after their issue.

Library references: Hawkery and Peddlers ⇐4(1); C.J.S. Hawkery and Peddlers § 7.

Historical Note

Source. L.1911, c. 133, § 2, p. 190 [1924 Suppl. § *136-1520A(2)], as am. by L.1931, c. 346, § 1, p. 844.

HAWKERS AND PEDDLERS 45:24-13

45:24-13. Sale or transfer of licenses by soldiers, sailors and marines; cancellation; misdemeanor

Any city magistrate or recorder, after due notice and a hearing, shall have power to order the cancellation of any license issued under authority of subparagraph "a" of section 45:24-9 of this title which has been sold or transferred by the original licensee. The city magistrate or recorder shall mail the order of cancellation to the county clerk in whose county the license was granted and thereupon the county clerk shall cancel the same of record and file the order of cancellation in his office and send notice of such cancellation to the office of the adjutant general. Any licensee holding a license issued under authority of subparagraph "a" of said section 45:24-9 who shall sell or transfer such license shall be guilty of a misdemeanor and punished accordingly.

Library references: Hawkers and Peddlers ~~§~~4(1), 7; C.J.S. Hawkers and Peddlers §§ 7, 11.

Historical Note

Source. L.1931, c. 321, § 4, p. 797, as am. by L.1934, c. 119, § 3, p. 320.

Cross References

Punishment, misdemeanor, see § 2A:85-7.



NEW MEXICO

- Examples



NEW MEXICO

AIR SPACE AGREEMENT

THIS AGREEMENT, made this _____ day of _____,
19____, by and between the NEW MEXICO STATE HIGHWAY AND
TRANSPORTATION DEPARTMENT (hereinafter "Department") and _____
_____ (hereinafter "PERMITTEE").

WITNESSETH:

WHEREAS, for purposes of this Agreement, "Air Space" is
defined as that space located above, at or below the highway's
established gradeline lying within the approved right of way
limits.

WHEREAS, this Agreement is controlled by the provisions of
Volume 7, Chapter 4, Section 3 of the Federal-Aid Highway Program
Manual, and so requires Federal Highway Administration concurrence
before becoming effective; and

WHEREAS, Permittee is desirous to use highway right of way
for a _____ not inconsistent with or
detrimental to Department's statutory obligations for highway
control and maintenance;

NOW, THEREFORE, the parties agree as follows:

1. DEPARTMENT AGREES:

a. To permit the following described Air Space to be
used _____

(LEGAL GOES HERE)

b. To permit the described Air Space to be used for a
period of _____ years from the date of

possession unless the Agreement is otherwise terminated or revoked as provided herein.

c. To allow Permittee the option of extending the terms of this Agreement for an additional _____ year period by giving written notice to Department prior to expiration of the original term unless the Agreement is otherwise terminated or revoked as provided herein.

2. PERMITTEE AGREES:

a. To develop and use the described Air Space solely and exclusively _____ in compliance with the attached plans incorporated herein as Exhibit "A" and "B".

b. That in the event the site is abandoned or is not used for the purposes herein set forth for a period of _____ months after completion of improvements on described Air Space, this Agreement shall be subject to termination.

c. That the described Air Space shall not be transferred, assigned or conveyed to another party without the prior written approval of the Department and the Federal Highway Administration which consent will not be unreasonably withheld.

d. To maintain any improvements including the _____ in good condition both as to safety and appearance. But said maintenance shall in no way cause interference with highway use. If in Department's discretion Permittee fails to adequately maintain the

safety and appearance of its improvements, the Department will send written notice for correction to Permittee. After _____ days from the date of the written notice, Department may either revoke this Agreement or enter the premises to perform the necessary maintenance work and all such costs shall be reimbursed by Permittee.

e. To pay the Department a rental fee of \$ _____ a year per year for the first _____ years. At the end of the first _____ year term, the rental will be re-negotiated and established by mutual agreement of both parties for the additional _____ years. At the end of the second _____ years, the parties will again re-negotiate. In the event that the parties cannot reach a negotiated rental price, the fee shall be adjusted to reflect the cumulative percentage change in the U.S. Department of Labor Consumer Price Index (All Urban Consumers 1967 Base = 100). This fee is payable annually in advance. The initial payment is due within 30 days after Permittees have taken possession of the air space and subsequently on every anniversary date thereafter.

f. To allow entry by authorized Department or Federal Highway Administration representatives when deemed necessary by Department for purposes of highway inspection, maintenance or reconstruction or for the purposes of insuring compliance with all the provisions

of this Agreement.

g. To indemnify Department and hold it harmless from any and all claims of injury to persons or property arising out of the negligent acts, errors and omissions of Permittee, its employees, agents, business invitees and customers in the maintenance and use of the described air space.

h. To purchase a policy of comprehensive general liability insurance including contractual liability coverage for its "hold harmless" obligation contained in the preceding paragraph of this Agreement. A certificate of insurance showing the required coverage will be provided prior to execution of this Agreement and upon demand, Permittee will furnish a copy of its policy to Department.

i. That Permittee will not enter into possession until such time as the required insurance policies are in force with appropriate certificates of insurance having been delivered to the Department containing a statement that the premiums have been paid in full and that the policy will not be canceled without thirty (30) days notice to Department.

j. That Permittee for itself, heirs, successors in interest and assigns as a part of the considerations hereof, does hereby covenant and agrees that in the event, he constructs, maintains or otherwise operates facilities on described air space for a purpose for

which a Department of Transportation program or activity is extended or for another purpose involving the provision of similar services or benefits, Permittee shall maintain and operate such facilities and services in compliance with all other requirements imposed pursuant to Title 49, Code of Federal Regulations, Department of Transportation, Subtitle A, Office of the Secretary, Part 21, Nondiscrimination in Federally-assisted programs of the Department of Transportation - Effectuation of Title VI of the Civil Rights Act of 1964, and as said Regulations may be amended. That in the event of breach of any of the above nondiscrimination covenants, the Department shall have the right to terminate the Agreement and to re-enter and repossess said land and the facilities thereon and hold the same as if said Agreement had never been made or issued. Permittee for itself, its successor in interest and assigns, as a part of the consideration hereof does hereby covenant and agrees that (1) no person on the ground of race, color, sex or national origin shall be excluded from participation in, denied the benefits of, or be otherwise subjected to discrimination in the use of said facilities; (2) that in the construction of any improvements on, over or under such land and the furnishing of services thereon, no person on the ground of race, color, sex or national origin shall be excluded from participation in, denied

the benefits of, or otherwise be subjected to discrimination; (3) that Permittee shall use the premises in compliance with all other requirements imposed by or pursuant to Title 49, Code of Federal Regulations Department of Transportation, Subtitle A, Office of the Secretary, Part 21, Nondiscrimination in Federally-assisted programs of the Department of Transportation - Effectuation of Title VI of the Civil Rights Act of 1964, and as said Regulations may be amended. That in the event of breach of any of the above nondiscrimination covenants, the Department shall have the right to terminate the Agreement and to re-enter and repossess said land and the facilities thereon and hold the same as if said Agreement had never been made or issued.

k. That if any provision of this Agreement is violated by Permittee, and after written notice such violation is not corrected within such length of time as is determined reasonable by Department, the Agreement may be revoked by Department.

l. That if this Agreement is revoked, terminated or canceled as provided herein, Department in its discretion may either accept ownership of the improvements including _____ or it may require removal including satisfactory scarification of the _____ if required shall be accomplished by Permittee in a manner prescribed by Department and at no

cost to the Department or the Federal Highway Administration. If this Agreement is terminated, the Department or the Federal Highway Administration shall not be liable or responsible to Permittee in any manner for damages of any nature whatsoever, which may be incurred by Permittee as a result of termination of this Agreement.

m. Upon termination of this Agreement, as described herein. the Department shall have the right to re-enter and repossess the right of way, and upon termination, any permission Permittee may have under this permit to in any way enter upon or utilize the right of way for any purpose shall extinguish and have no further effect.

n. That this Agreement be terminated for the convenience of either party upon written notice received six (6) months in advance of termination without the necessity of showing the other's breach or default.

IN WITNESS WHEREOF the parties hereto have set their hands and seals on the day and year first above written.

NEW MEXICO STATE HIGHWAY AND
TRANSPORTATION DEPARTMENT

Secretary

"PERMITTEE"

By: _____
Name _____

A-234

Address _____

City _____

Approved by the Federal Highway
Administration on _____,
19__.

Division Administrator

Reviewed, as to form only, by
the State Highway and Transportation
Department's Legal Division
on _____, 19__.

Legal Division Director

NEW YORK

- Legislation



§ 1156. **Pedestrians on roadways.** (a) Where sidewalks are provided and they may be used with safety it shall be unlawful for any pedestrian to walk along and upon an adjacent roadway.

(b) Where sidewalks are not provided any pedestrian walking along and upon a highway shall when practicable walk only on the left side of the roadway or its shoulder facing traffic which may approach from the opposite direction. Upon the approach of any vehicle from the opposite direction, such pedestrian shall move as far to the left as is practicable.

§ 1157. **Pedestrians soliciting rides, or business.** (a) No person shall stand in a roadway for the purpose of soliciting a ride, or to solicit from or sell to an occupant of any vehicle.

(b) No person shall stand on or in proximity to a street or highway for the purpose of soliciting the watching or guarding of any vehicle while parked or about to be parked on a street or highway.

(c) No person shall occupy any part of a state highway, except in a city or village, in any manner for the purpose of selling or soliciting.

**ARTICLE 28
TURNING AND STARTING AND SIGNALS
ON STOPPING AND TURNING**

Section	
1160.	Required position and method of turning at intersections.
1161.	U turns in certain areas prohibited.
1162.	Starting parked vehicle.
1163.	Turning movements and required signals.
1164.	Signals by hand and arm or signal lamps.
1165.	Method of giving hand-and-arm signals.
1166.	Required position for turning at alley, driveway, private road or onto property off the roadway.

§ 1160. **Required position and method of turning at intersections.** The driver of a vehicle intending to turn at an intersection shall do so as follows:

(a) **Right turns.** Both the approach for a right turn and a right turn shall be made as close as practicable to the right hand curb or edge of the roadway.

(b) **Left turns on two-way roadways.** At any intersection where traffic is permitted to move in both directions on each roadway entering the intersection, an approach for a left turn shall be made in that por-

tion of the right half of the roadway nearest the center line thereof and by passing to the right of such center line where it enters the intersection and after entering the intersection the left turn shall be made so as to leave the intersection to the right of the center line of the roadway being entered. Whenever practicable the left turn shall be made in that portion of the intersection to the left of the center of the intersection.

(c) **Left turns on other than two-way roadways.** At any intersection where traffic is restricted to one direction on one or more of the roadways, the driver of a vehicle intending to turn left at any such intersection shall approach the intersection in the extreme left-hand lane of the roadway lawfully available to traffic moving in the direction of travel of such vehicle and after entering the intersection the left turn shall be made so as to leave the intersection, as nearly as practicable, in the left-hand lane lawfully available to traffic moving in such direction upon the roadway being entered.

(d) When markers, buttons, signs, or other markings are placed within or adjacent to intersections and thereby require and direct that a different course from that specified in this section be traveled by vehicles turning at an intersection, no driver of a vehicle shall turn a vehicle at an intersection other than as directed and required by such markers, buttons, signs, or other markings.

§ 1161. **U turns in certain areas prohibited.** No motor vehicle shall make a U turn upon any curve, or upon the approach to, or near the crest of a grade, where such motor vehicle cannot be seen by the driver of any other motor vehicle approaching from either direction within five hundred feet.

§ 1162. **Starting parked vehicle.** No person shall move a vehicle which is stopped, standing, or parked unless and until such movement can be made with reasonable safety.

§ 1163. **Turning movements and required signals.** (a) No person shall turn a vehicle at an intersection unless the vehicle is in proper position upon the roadway as required in section eleven hundred sixty, or turn a vehicle to enter a private road or driveway, or otherwise turn a vehicle from a direct course or move right or left upon a roadway unless and until such movement can be made with reasonable safety. No person shall so turn any vehicle without giving an appropriate signal in the manner hereinafter provided.

(b) A signal of intention to turn right or left when required shall be given continuously during not less than the last one hundred feet traveled by the vehicle before turning.

(c) No person shall stop or suddenly decrease the speed of a vehicle without first giving an appropriate signal in the manner provided



NORTH CAROLINA

- Legislation
- Rules



business exclusively by the erection or placement of such outdoor advertising signs, structures, boards, bulletins or devices as specified in this section, he may be licensed to do so upon the payment annually of one dollar (\$1.00) for each sign up to 1,000 in number, and for 1,000 or more, the sum of one thousand dollars (\$1,000) for the privilege in lieu of all other taxation as provided in this section, except such further taxation as may be imposed upon him by cities or towns, acting under the power to levy not in excess of one half of that specified in paragraph two of subsection (a) of this section.

(b) Every person, firm, or corporation shall show in its application for the State license herein provided for the name of each incorporated city or town within which, and the county within which, it is maintaining or proposes to maintain said signboards, poster boards, painted bulletins or other painted or printed signs or other outdoor advertising devices within the State of North Carolina. No person, firm, or corporation, licensed under the provisions of this section, shall erect or maintain any outdoor advertising structure, device or display until a permit for the erection of such structure, device or display shall have been obtained from the Secretary of Revenue. Application for such permit shall be in writing, signed by the applicant or his duly authorized agent, upon blanks furnished by the Secretary of Revenue, in such form and requiring such information as said Secretary of Revenue may prescribe. Each application shall have attached thereto the written consent of the owners or duly authorized agent of the property on which structures, device or display is to be erected or maintained, and shall state thereon the beginning and ending dates of such written permission: Provided, the subsection shall not apply to persons, firms, or corporations who or which advertise their or its own business exclusively, and who or which have been licensed therefor pursuant to subsection (a) of this section.

(c) It shall be unlawful for any person engaged in the business of outdoor advertising to in any manner paint, print, place, post, tack or affix, or cause to be painted, printed, placed, posted, tacked or affixed any sign or other printed or painted advertisement on or to any stone, tree, fence, stump, pole, building or other object which is upon the property of another without first obtaining the written consent of such owner thereof, and any person, firm, or corporation who in any manner paints, prints, places, posts, tacks or affixes, or causes to be painted, printed, posted, tacked or affixed any such advertisement on the property of another except as herein provided shall be guilty of a misdemeanor, and shall be punished by a fine not exceeding fifty dollars (\$50.00), or imprisonment of 30 days: Provided, that the provisions of this section shall not apply to legal notices.

* (d) It shall be unlawful for any person, firm, or corporation to paint, print, place, post, tack or affix any advertising matter within the limits of the right-of-way of public highways of the State without the permission of the Department of Transportation, or upon the streets of the incorporated towns of the State without permission of the governing authorities, and if and when signs of any nature are placed without permission within the highways of the State, or within the streets of incorporated towns, it shall be the duty of the Department of Transportation or any other administrative body or other governing authorities of the cities and towns of said State to remove said advertising matters therefrom.

(e) Every person, firm, or corporation owning or maintaining signboards, poster boards, printed bulletins, or other outdoor advertisements of any nature within this State shall have imprinted on the same the name of such person, firm, or corporation in sufficient size to be plainly visible and permanently affixed thereto.

(f) A license shall not be granted any person, firm, or corporation having his or its principal place of business outside the State for the display of any

CASE NOTES

This section preempts § 150A-43 (see now § 150B-43) and specifically provides opportunity to have de novo proceeding before trial judge which satisfies due process requirements. *National Adv. Co. v. Bradshaw*, 48 N.C. App. 10, 268 S.E.2d 816, cert. denied, 301 N.C. 400, 273 S.E.2d 446 (1980).

This section clearly limits the scope of review to (1) constitutional violations, (2) statutory or regulatory irregularities or (3) other errors of law. *National Adv. Co. v. Bradshaw*, 60 N.C. App. 745, 299 S.E.2d 817 (1983).

Although the scope of review de novo is broad, the superior court may take action only if the agency decision is (1) in violation of constitutional provisions; (2) not made in accordance with this article or the regulations thereunder; or (3) affected by other error of law. Thus, the superior court has the implied power to reverse when the evidence does not support the decision. *Ace-Hi, Inc. v. Department of Transp.*, 70 N.C. App. 214, 319 S.E.2d 294 (1984).

Administrative Remedies Must Be Exhausted. — The express language of this section makes clear the legislative intent that recourse to the courts is to be had by the aggrieved party only after exhausting all adminis-

trative remedies made available to him by rules and regulations enacted pursuant to this Article. *Freeland v. Greene*, 33 N.C. App. 537, 235 S.E.2d 852 (1977).

Court Not Bound by Secretary's Findings and Conclusions. — While an interpretation of a statute or rule of an agency administering it is to be accorded some deference, the superior court's review of a decision by the Secretary of Transportation is de novo. Therefore, the superior court is thus not bound by the Secretary's findings of fact and conclusions of law and may arrive at a different conclusion of law based upon the same evidence. *Appalachian Poster Adv. Co. v. Bradshaw*, 65 N.C. App. 117, 308 S.E.2d 764 (1983).

Appellant Is Not Limited to Administrative Record. — Under this section, an appellant from decision and order of the Department of Transportation has the right to a hearing de novo in the Superior Court of Wake County; therefore, appellant is not limited to the administrative record. *Ace-Hi, Inc. v. Department of Transp.*, 70 N.C. App. 214, 319 S.E.2d 294 (1984).

Cited in *Bracey Adv. Co. v. North Carolina Dep't of Transp.*, 62 N.C. App. 197, 302 S.E.2d 490 (1983).

§ 136-135. Enforcement provisions.

Any person, firm, corporation or association, placing, erecting or maintaining outdoor advertising along the interstate system or primary system in violation of this Article or rules and regulations promulgated by the Department of Transportation shall be guilty of a misdemeanor. In addition thereto, the Department of Transportation may seek injunctive relief in the Superior Court of Wake County and require the outdoor advertising to conform to the provisions of this Article or rules and regulations promulgated pursuant hereto, or require the removal of the said illegal outdoor advertising. (1967, c. 1248, s. 10; 1973, c. 507, s. 5; 1975, c. 568, s. 14; 1977, c. 464, s. 32.)

CASE NOTES

Applied in *Ace-Hi, Inc. v. Department of Transp.*, 70 N.C. App. 214, 319 S.E.2d 294 (1984).

§ 136-136. Zoning changes.

All zoning authorities shall give written notice to the Department of Transportation of the establishment or revision of any commercial and industrial zones within 660 feet of the right-of-way of interstate or primary highways. Notice shall be by registered mail sent to the offices of the Department of Transportation in Raleigh, North Carolina, within 15 days after the effective date of the zoning change or establishment. (1967, c. 1248, s. 11; 1973, c. 507, s. 5; 1977, c. 464, s. 7.1.)

CASE NOTES

Commission's (Now Department's) Determination Exclusive. — The State Highway Commission's (now Department of Transportation's) determination of what signs should be erected for the information of the traveling

public was exclusive once it authorized the opening of a road for public use. *Gilliam v. Propst Constr. Co.*, 256 N.C. 197, 123 S.E.2d 504 (1962).

§ 136-32.1. Misleading signs prohibited.

No person shall erect or maintain within 100 feet of any highway right-of-way any warning or direction sign or marker of the same shape, design, color and size of any official highway sign or marker erected under the provisions of G.S. 136-30 and 136-31, or otherwise so similar to an official sign or marker as to appear to be an official highway sign or marker. Any person who violates any of the provisions of this section is guilty of a misdemeanor and shall be punished by a fine or imprisonment, or both, in the discretion of the court. (1955, c. 231.)

§ 136-32.2. Placing blinding, deceptive or distracting lights unlawful.

(a) If any person, firm or corporation shall place or cause to be placed any lights, which are flashing, moving, rotating, intermittent or steady spotlights, in such a manner and place and of such intensity:

- (1) Which, by the use of flashing or blinding lights, blinds, tends to blind and effectively hampers the vision of the operator of any motor vehicle passing on a public highway; or
- (2) Which involves red, green or amber lights or reflectorized material and which resembles traffic signal lights or traffic control signs; or
- (3) Which, by the use of lights, reasonably causes the operator of any motor vehicle passing upon a public highway to mistakenly believe that there is approaching or situated in his lane of travel some other motor vehicle or obstacle, device or barricade, which would impede his traveling in such lane;

[he or it] shall be guilty of a misdemeanor and shall upon conviction be fined not more than fifty dollars (\$50.00) or imprisoned not more than 30 days or both.

(b) Each 10 days during which a violation of the provisions of this section is continued after conviction therefor shall be deemed a separate offense.

(c) The provisions of this section shall not apply to any lights or lighting devices erected or maintained by the Department of Transportation or other properly constituted State or local authorities and intended to effect or implement traffic control and safety. Nothing contained in this section shall be deemed to prohibit the otherwise reasonable use of lights or lighting devices for advertising or other lawful purpose when the same do not fall within the provisions of subdivisions (1) through (3) of subsection (a) of this section.

(d) The enforcement of this section shall be the specific responsibility and duty of the State Highway Patrol in addition to all other law-enforcement agencies and officers within this State; provided, however, no warrant shall issue charging a violation of this section unless the violation has continued for 10 days after notice of the same has been given to the person, firm or corporation maintaining or owning such device or devices alleged to be in violation of this section. (1959, c. 560; 1973, c. 507, s. 5; 1975, c. 716, s. 5; 1977, c. 464, ss. 7.1, 17.)

dictment for tearing down a fence, the defendant cannot avoid liability by showing that he acted as agent for another. *State v. Campbell*, 133 N.C. 640, 45 S.E. 344 (1903).

Title to Land No Defense. — It is well settled that where the State, in an indictment under this section, for unlawfully and willfully removing a fence, shows actual possession in the prosecutor, the defendant cannot excuse himself by showing title to the land upon which the fence was situated. *State v. Graham*, 53 N.C. 397 (1861); *State v. Hovis*, 76 N.C. 117 (1877); *State v. Marsh*, 91 N.C. 632 (1884); *State v. Howell*, 107 N.C. 835, 12 S.E. 569 (1890); *State v. Fender*, 125 N.C. 649, 34 S.E. 448 (1899); *State v. Campbell*, 133 N.C. 640, 45 S.E. 344 (1903); *State v. Taylor*, 172 N.C. 892, 90 S.E. 294 (1916).

Question of Title Cannot Be Raised. — Where a party has neither possession, nor a right of possession to land, he cannot, upon an indictment for unlawfully removing a fence therefrom, raise a question as to a right of entry, nor is it any defense to him that he did the act to bring on a civil suit in order to try the title. *State v. Graham*, 53 N.C. 397 (1861).

Destroying Fence When Line Is in Dispute. — Although a defendant cannot plead his title as a defense to an indictment for destroying fences, etc., on the land in possession of another, he can plead his title if the land is not in the possession of the prosecutor. In case of a

disputed line, if the prosecutor erects a fence on land in possession of the defendant, the defendant is not liable under this section for pulling it down. *State v. Watson*, 86 N.C. 626 (1882); *State v. Fender*, 125 N.C. 649, 34 S.E. 448 (1899). Nor is a quasi tenant occupying by the consent of the owner subject to prosecution under this section for the removal of a fence. *State v. Williams*, 44 N.C. 197 (1853).

Fence Made from Rails Taken from Another. — Although rails of which a fence around an enclosure was made were taken from the land of another, no right to go on the land and remove the fence exists in favor of the person from whom the rails were taken, as the fence is a part of the realty, and such a trespass comes within the meaning of this section. *State v. McMinn*, 81 N.C. 585 (1879).

Removal by Officer of Fence Erected Across a Street. — A fence erected across a public street is a public nuisance, and a city marshal will not be liable for abating the nuisance by pulling it down. *State v. Godwin*, 145 N.C. 461, 59 S.E. 132 (1907).

Defective Bill of Indictment. — A motion in arrest of judgment after conviction for removal of fences on the ground that the bill of indictment is defective will not be granted, unless it appears that the bill is so defective that judgment cannot be pronounced upon it. *State v. Taylor*, 172 N.C. 892, 90 S.E. 294 (1916).

§ 14-145. Unlawful posting of advertisements.

Any person who in any manner paints, prints, places, or affixes, or causes to be painted, printed, placed, or affixed, any business or commercial advertisement on or to any stone, tree, fence, stump, pole, automobile, building, or other object, which is the property of another without first obtaining the written consent of such owner thereof, or who in any manner paints, prints, places, puts, or affixes, or causes to be painted, printed, placed, or affixed, such an advertisement on or to any stone, tree, fence, stump, pole, mile-board, milestone, danger-sign, danger-signal, guide-sign, guide-post, automobile, building or other object within the limits of a public highway, shall be guilty of a misdemeanor and shall be fined not exceeding fifty dollars (\$50.00) or imprisoned not exceeding 30 days. (Ex. Sess. 1924, c. 109.)

Cross References. — As to injuring, defacing, or destroying notices and advertisements, see §§ 14-384 and 14-385.

Legal Periodicals. — For comment

on application of this section, see 3 N.C.L. Rev. 25.

For survey of 1978 constitutional law, see 57 N.C.L. Rev. 958 (1979).

CASE NOTES

Quoted in Pelham Realty Corp. v. Board of Transp., 50 N.C. App. 106, 272 S.E.2d 777
 Transp., 303 N.C. 424, 279 S.E.2d 826 (1981). (1980).
 Cited in Pelham Realty Corp. v. Board of

✓ § 136-89.56. **Commercial enterprises.**

No commercial enterprises or activities shall be authorized or conducted by the Department of Transportation, or the governing body of any city or town, within or on the property acquired for or designated as a controlled-access facility, as defined in this Article, except for vending machines permitted by the Department of Transportation and placed by the Division of Services for the Blind, Department of Human Resources, as the State licensing agency designated pursuant to Section 2(a)(5) of the Randolph-Sheppard Act (20 USC 107a(a)(5)). The Department of Transportation shall regulate the placing of the vending machines in highway rest areas and shall regulate the articles to be dispensed. In order to permit the establishment of adequate fuel and other service facilities by private owners or their lessees for the users of a controlled-access facility, the Department of Transportation shall permit access to service or frontage roads within the publicly owned right-of-way of any controlled-access facility established or designated as provided in this Article, at points which, in the opinion of the Department of Transportation, will best serve the public interest. The location of such fuel and other service facilities may be indicated to the users of the controlled-access facilities by appropriate signs, the size, style, and specifications of which shall be determined by the Department of Transportation.

The location of fuel and other service facilities may be indicated to the users of the controlled access facilities by appropriate logos placed on signs owned, controlled, and erected by the Department of Transportation. The owners, operators or lessees of fuel and other service facilities who wish to place a logo identifying their business or service on a sign shall furnish a logo meeting the size, style and specifications determined by the Department of Transportation and shall pay the Department for the costs of initial installation and subsequent maintenance. The fees for logo sign installation and maintenance shall be set by the Board of Transportation based on cost. (1957, c. 993, s. 9; 1973, c. 507, s. 5; 1977, c. 464, s. 7.1; 1981, c. 481, s. 1; 1983, c. 604, s. 1; 1985, c. 456; c. 718, ss. 2, 3.)

§ 136-89.57: Repealed by Session Laws 1965, c. 474, s. 1.

§ 136-89.58. **Unlawful use of National System of Interstate and Defense Highways and other controlled-access facilities.**

On those sections of highways which are or become a part of the National System of Interstate and Defense Highways and other controlled-access facilities it shall be unlawful for any person:

- (1) To drive a vehicle over, upon or across any curb, central dividing section or other separation or dividing line on said highways.
- (2) To make a left turn or a semicircular or U-turn except through an opening provided for that purpose in the dividing curb section, separation, or line on said highways.
- (3) To drive any vehicle except in the proper lane provided for that purpose and in the proper direction and to the right of the central dividing curb, separation section, or line on said highways.

There is excepted from the foregoing prohibition on landing and taking off by aircraft on state highways, the landing and taking off of aircraft pursuant to written authorization granted by the State Highway Administrator. The administrator may grant such authorization upon good cause being shown and upon showing that arrangements have been made with law enforcement officials to handle vehicular traffic on the highway during such operation.

History Note: Filed as a Temporary Amendment
Eff. March 15, 1982, for a Period of 47 Days to
Expire on May 1, 1982;
Statutory Authority G.S. 136-18(5);
Eff. July 1, 1978;
Temp. Lapsed Eff. May 1, 1982;
Amended Eff. October 1, 1982.

.0413 PARADES ON HIGHWAY SYSTEM ROADS

It shall be unlawful for any person, firm, organization, school or other group of persons to conduct or participate in a parade on the main-traveled lanes of any street or highway of the state highway system located outside the limits of a municipality.

History Note: Statutory Authority G.S. 136-18(5);
Eff. July 1, 1978.

.0414 PARKING VEHICLE FOR SALE OR DISTRIBUTION OF GOODS

It shall be unlawful for any person to park any vehicle on the right of way of any primary or secondary highway or road of the State Highway System for the purpose of using said vehicle for the sale or distribution of fruits, vegetables, goods, wares, or merchandise of any character, and it shall be unlawful for any person to erect any stand or structure on the right of way of any primary or secondary highway or road of the State Highway System or to sell from said vehicle, stand, or structure or from any place on the right of way of any primary or secondary highway or road of the State Highway System any fruits, vegetables, goods, wares or merchandise of any character.

History Note: Statutory Authority G.S. 136-18(5);
Eff. July 1, 1978.

.0415 ADVERTISING SIGNS WITHIN RIGHT OF WAY

It shall be unlawful for any person, firm or corporation to erect or place any advertising or other sign, except regulation traffic and warning signs approved by the Department of Transportation, on any highway or the right of way thereof, or so as to overhang the right of way, or to permit the erection or

SECTION .0400 - GENERAL ORDINANCES

.0401 PENALTY IMPOSED FOR VIOLATION OF ORDINANCES

The violation of any ordinance contained in this Section shall constitute a misdemeanor.

History Note: Statutory Authority G.S. 136-18(5);
Eff. July 1, 1978.

.0402 PILING OBSTRUCTIONS ON HIGHWAYS OR WITHIN RIGHT OF WAY

It shall be unlawful to pile, place or leave, or cause to be piled, placed or left temporarily or permanently, any trash, refuse, garbage, lumber, logs, cordwood, tree-laps, scrapped automobile, scrapped truck or part thereof, or any other material upon any road or highway or the shoulders thereof, or within the right of way or over the ditches or drainways of any road or highway of the state highway system.

History Note: Statutory Authority G.S. 136-18(5); 136-90;
Eff. July 1, 1978.

.0403 DEPOSITING MUD ON STATE HIGHWAYS

No person operating a vehicle with "dual wheels" or a vehicle equipped with four wheel drive shall track or cause mud to be deposited on the paved portion of any state highway so as to create a hazard to the traveling public. Any person who causes or permits mud to be tracked or deposited by a vehicle with dual wheels or a vehicle equipped with four wheel drive shall immediately remove the same or cause it to be removed. Any person violating this section shall be guilty of a misdemeanor.

History Note: Statutory Authority G.S. 136-18(5); 136-90;
Eff. July 1, 1978.

.0404 RURAL MAILBOXES INTERFERING WITH TRAFFIC OR MAINTENANCE

It shall be unlawful to place any rural mailbox so as to interfere with the traffic or maintenance of the roads and highways of the state highway system.

History Note: Statutory Authority G.S. 136-18(5); 136-90;
Eff. July 1, 1978.

.0405 MOVING VEHICLES WHICH DAMAGE SURFACE OR SHOULDER

It shall be unlawful to move on, over, or across any bridge, road or highway, including shoulders thereof, of the state highway system any object, tractor, engine, farm equipment or

NORTH CAROLINA



LOGO

BUSINESS SIGN FACE SPECIFICATIONS

The Business sign shall be a highway blue sign with a white border and white legend, except that colors consistent with customary use should be used with nationally, regionally or locally known symbols or trademarks. Total reflectorization is required. (Reference Federal Standard 595a, Color Number 15090, for the approved "blue" color). Enclosed lens reflective sheeting which meets the requirements of the attached specifications shall be used on Interstate Route 95. (See Attachment 2). High Performance Wide Angle Retroreflective Sheeting which meets the requirements of the attached specification shall be used on all other Interstate routes and all non-interstate freeways. (See Attachment 4).

Eligible applicants have the option of using either their recognized logo or the name of their business on Business signs. When a symbol or trademark is used instead of the business name, any legend thereon shall be proportional to the size customarily used on said symbol or trademark. Regardless of whether a logo or name of the business is used, the display shall be centered both vertically and horizontally on the Business Sign.

The Mainline Business Signs shall have a 3/4 inch white border and the legend shall be at least 10 inch letters whether capital or lower case if two lines of copy are utilized and at least 10 inch letters if there is only one line of copy if a symbol or trademark is not used. Signs shall have 3 inch corner radii. Sign sizes shall be 48 inches by 36 inches for "GAS" and 60 inches by 36 inches for all other services.

The Ramp Business Signs shall have 3/4 inch white border and the legend should be at least 4 inch letters whether capital or lower case if two lines of copy are utilized and at least 4 inch letters if there is only one line of copy if a symbol or trademark is not used. Signs shall have 3 inch corner radii. Sign sizes shall be 24 inches by 18 inches for "GAS" and 30 inches by 18 inches for all other services.

When the background color is not blue, a field of blue must be present adjacent to the white border. On mainline signs the field shall be at least 1 1/2 inches wide and on ramp or trailblazer signs it must be at least 3/4 inches wide.

Business Signs shall be made of a flat aluminum sheet having a minimum thickness of 0.063 inch and a maximum thickness of 0.125 inch. See Attachments 3 and 4 for specifications.

Each Business Sign shall be made with 5/32 inch holes (spaced as per punching detail) for attaching to "specific information panel".

Each Business Sign to be used as a trailblazing sign shall be made with two 3/8 inch holes (spaced as per punching detail) for attaching to channel posts.

Any message, trademarks, or symbols which interfere with, imitate or resemble any official warning or regulatory traffic sign, signal, or device is prohibited.

Layouts for business signs shall be submitted to the Division Engineer for his approval. Approval is required before the business signs are fabricated.

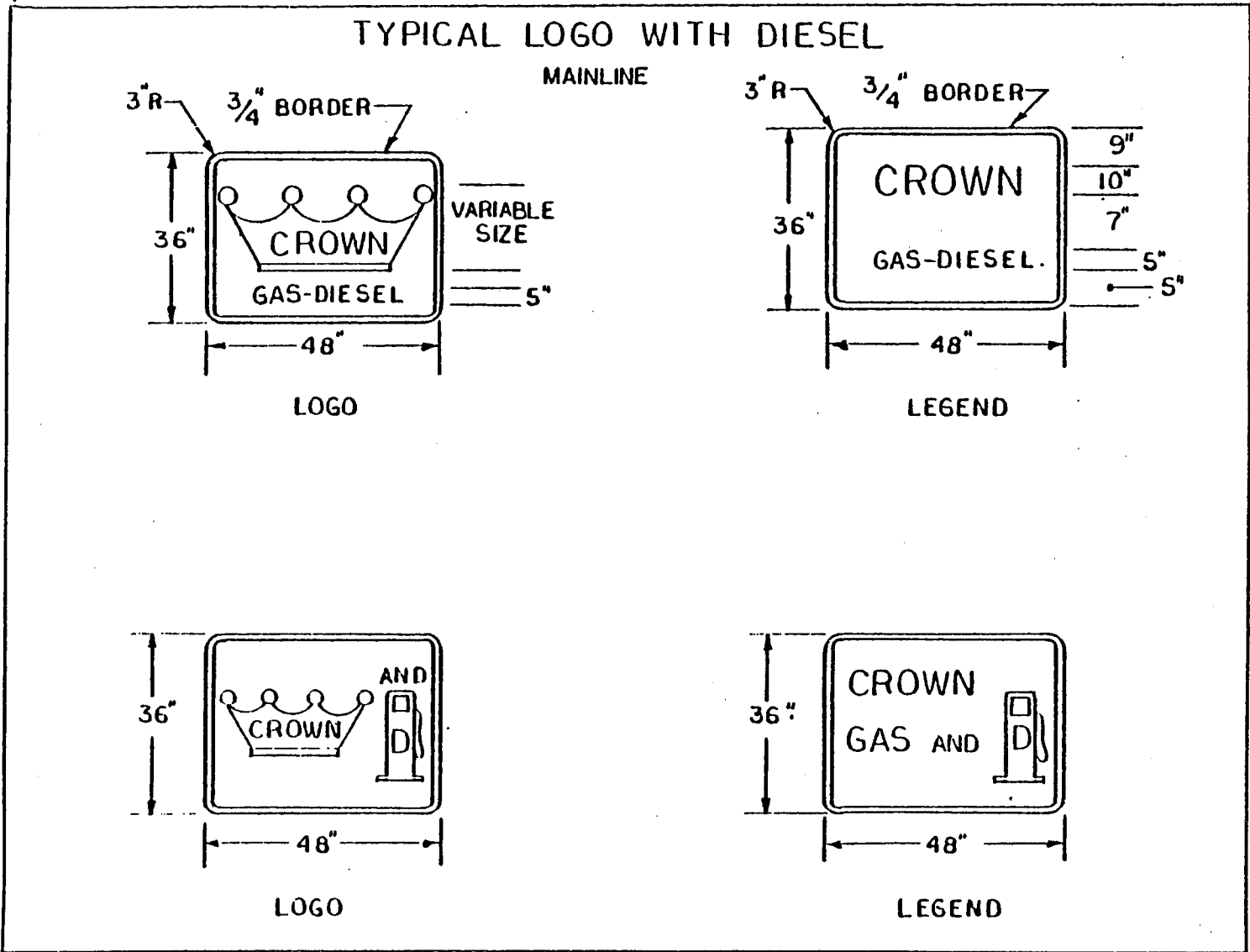

TYPICAL LOGO BUSINESS SIGNS
MAINLINE

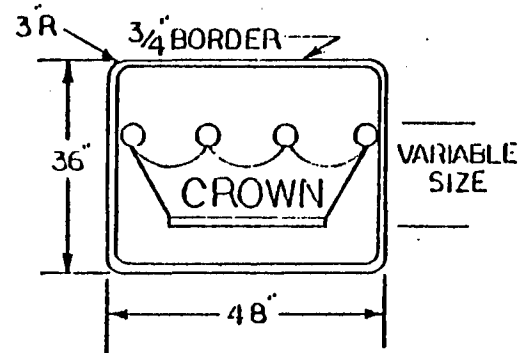

LOGO

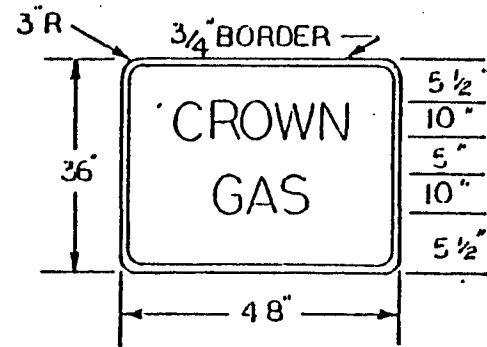

TYPICAL
GAS

LEGEND

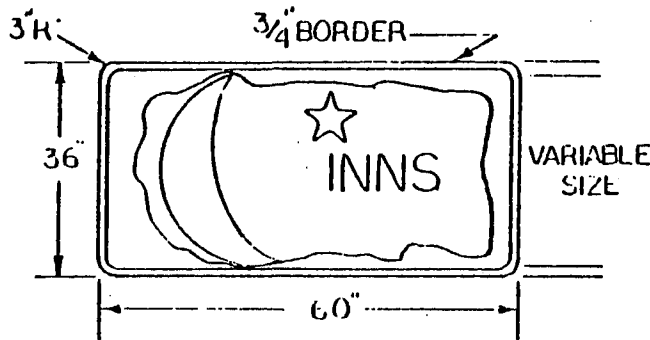

LOGO

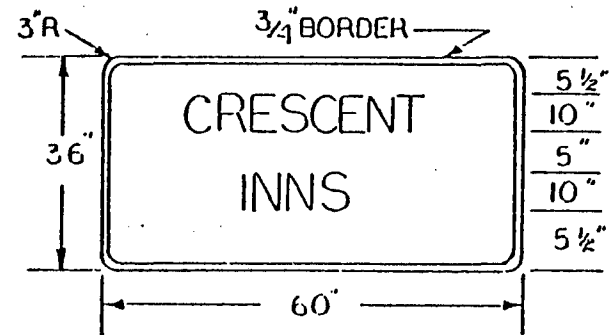

LEGEND

TYPICAL
FOOD, LODGING, OR CAMPING SIGNS

TYPICAL LOGO WITH DIESEL

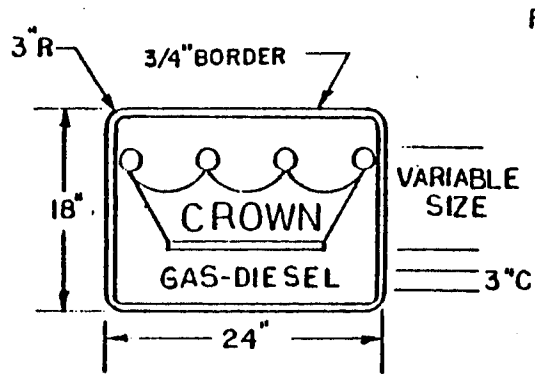

LOGO

RAMP

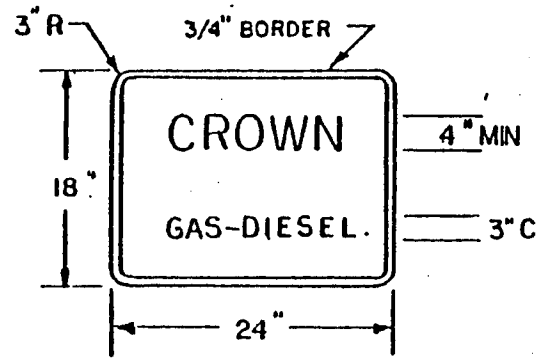

LEGEND

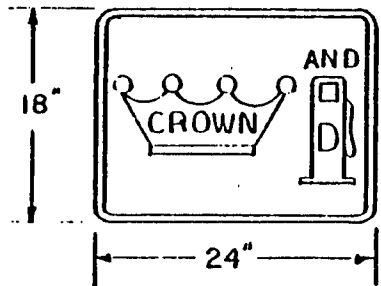

LOGO

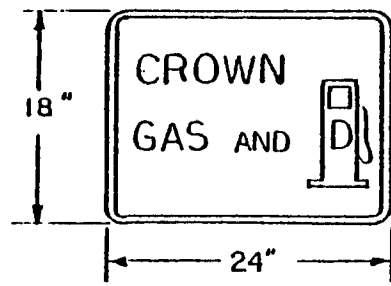

LEGEND

TYPICAL LOGO BUSINESS SIGNS

RAMP

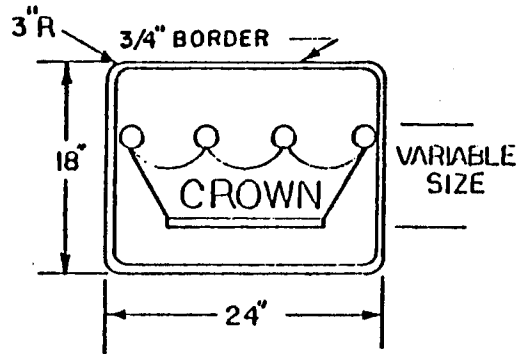

LOGO

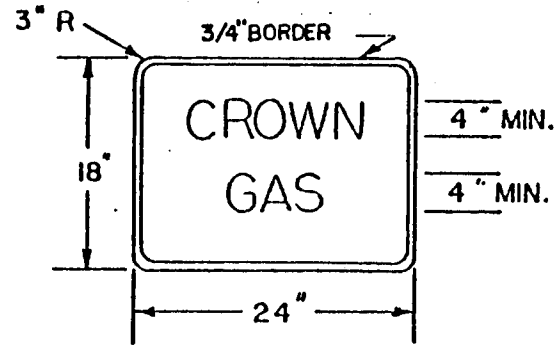

TYPICAL
GAS

LEGEND

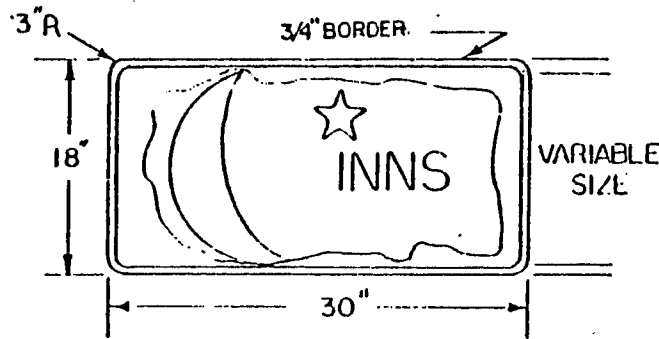

LOGO

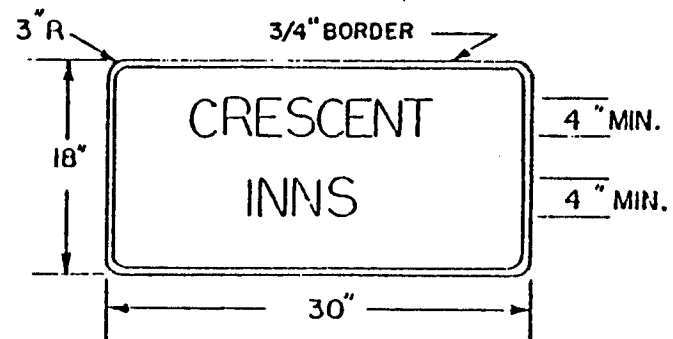

LEGEND

TYPICAL FOOD, LODGING, OR CAMPING SIGNS

LOGO BUSINESS SIGN BLANK DETAILS

MAINLINE

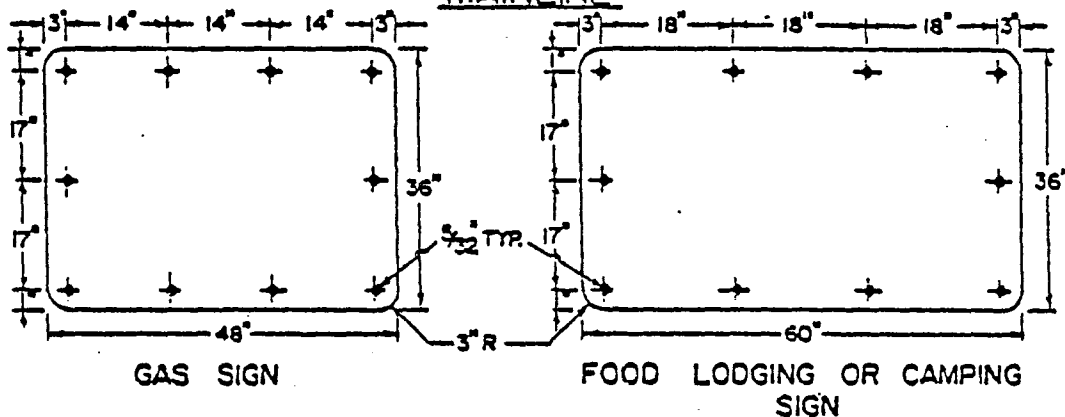

RAMP

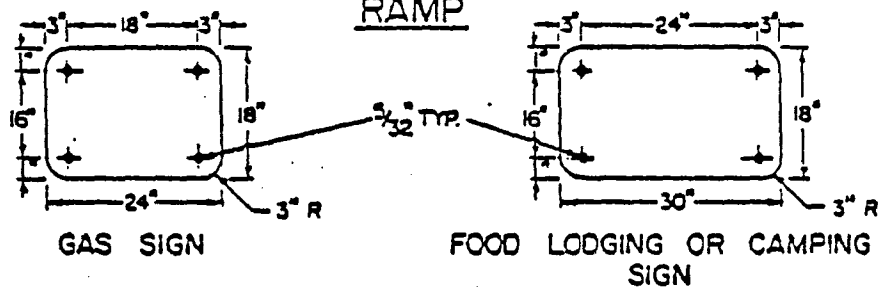

TRAILBLAZING SIGNS

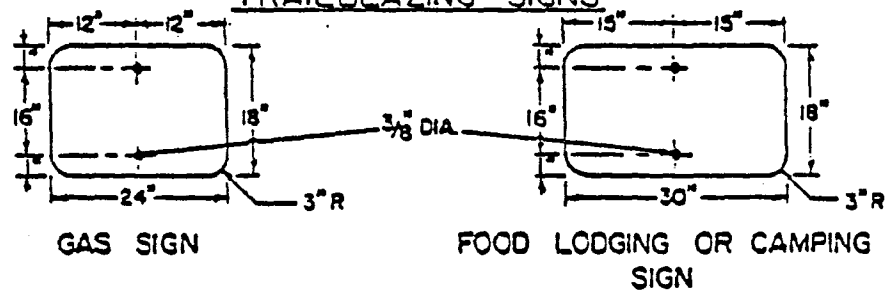

THE SIGN BLANK SHALL BE FABRICATED FROM FLAT SHEET ALUMINUM
OF .063 INCH MINIMUM AND .125 INCH MAXIMUM THICKNESS.

TEB 226

<u>Aluminum</u>	<u>Aluminum Association Alloy</u>	<u>ASTM Spec.</u>
Sheets and Plates	6061-T6 or 5052 H38	B209

.0216 SPECIFIC INFORMATION SIGNING PROGRAM

The Specific Information Signing Program, hereinafter "program", provides certain eligible businesses with the opportunity to be listed on official signs within the right-of-way of interstate highways and fully controlled access highways. The traffic engineering branch is responsible for receiving requests for information concerning the Program. Direct requests to Manager, Traffic Engineering Branch, Division of Highways, Department of Transportation, P. O. Box 25201, Raleigh, N. C. 27611. Division Engineers for the division in which the interchange is located are responsible for receiving and distributing applications and copies of policies and procedures, executing agreements and administering the agreements in accord with the rules, regulations, policies and procedures of the board and the department.

History Note: Authority G.S. 136-89.56; 136-137; 136-139;
143B-346; 143E-348; 143E-350(f);
23 C.F.R. 750, Subpart A; 23 U.S.C. 131(f);
Eff. April 1, 1982;
Amended Eff. November 1, 1985.

.0217 PROGRAM DEFINITIONS

(a) "Specific Information Panel", hereinafter "panel" means a panel, rectangular in shape, located within the highway right of way and consisting of:

- (1) the words "GAS", "FOOD", "LODGING", or "CAMPING" and directional information;
- (2) space for one or more individual business (logo) signs to be mounted on the panel.

(b) "Business sign" or "logo sign" means a separately attached sign, furnished and owned by a participating business, mounted on the rectangular panel or mounted separately for trailblazing to show the brand, symbol, trademark, or name, or combination of these, for the motorist service available on the crossroad at or near the interchange.

(c) "Public telephone" means a coin operated telephone or a business telephone which is available for public use during all business hours. If there is an outside coin-operated telephone in the immediate vicinity of the business (within the intersection area, at an adjacent business or across the road), the business is in compliance. A business phone at an adjacent business is not a public telephone for a particular applicant business.

(d) "Interstate Highway" means any section of the highway that is a part of the "National System of Interstate and Defense Highways". A highway listed as "Interstate Business Loop (or

Spur)" or "Temporary Interstate" is not considered a part of the Interstate Highway System.

(e) "Rural Interchange" means an interchange on an Interstate or other fully controlled access highway, any portion of which is outside the corporate limits of any municipality.

(f) "Supplemental Service Sign" means a panel, rectangular in shape, white legend and border on a blue background, with the words "GAS", "FOOD", "LODGING", "CAMPING" or any combination thereof.

(g) "Tire Repair (by an employee)" means on premise tire repair by an employee or a contract between the subject business and another business to do tire repair for them.

(h) Fully Controlled Access Highway means a highway on which the authority to control access is exercised to give preference to through traffic by providing access connections with selected public roads only by prohibiting crossings at grade or direct private driveway connections.

History Note: Authority G.S. 136-89.56; 136-137; 136-139;
143B-346; 143B-348; 143B-350(f);
23 C.F.R. 750, Subpart A; 23 U.S.C. 131(f);
Eff. April 1, 1982;
Amended Eff. April 1, 1986; November 1, 1985.

.0218 LOCATION OF PANELS

The department shall control the erection and maintenance of official signs giving specific information of interest to the traveling public in accordance with following criteria:

- (1) The department may erect panels at rural interchanges. The department may also erect panels at an interchange within a municipal corporate limit with a population of 25,000 or less, at the time application for business signs is made.
If an interchange is taken into a municipal corporate limit after the initial business signs are erected, business signs may be added to the original panels until the panels have the full complement of business signs. No additional panels will be erected at an interchange that has been taken into a municipal corporate limit with 25,000 population or greater.
- (2) Panels shall be fabricated and located as detailed on the signing plans for the interchanges and shall be located in a manner to take advantage of natural terrain and to have the least impact on the scenic environment.
- (3) A separate mainline panel shall be provided on the interchange approach for each qualified type of motorist service except as provided in (d) of this Rule. No more

than one panel shall be erected for a type of service in each direction approaching an interchange. Where a qualified type of motorist service is not available at an interchange, the panel may not be erected.

- (4) The mainline panels shall be erected between the previous interchange and 800 feet in advance of the exit direction sign for the interchange from which the services are available. The panels should be placed in alignment farther from the roadway (preferably 40 feet from roadway) than that of guide signs. There shall be at least 800 feet spacing between the panels and guide signs. In the direction of traffic, the successive panels shall be those for "CAMPING", "LODGING", "FOOD", and "GAS" in that order. A combination type panel may be used in remote rural areas of the Interstate System, or other fully controlled access highway and when space does not permit all signs and only two of each type of service is available at the location. A maximum of two business signs may appear below each respective service on a combination type panel. If all four services are available, "GAS" and "FOOD" should be combined on one sign, and "LODGING" and "CAMPING" should be combined on one sign. When the number of business facilities at a rural interchange are increased to more than two for one or more services, existing combination service business signing must be removed and replaced with sign panels, dedicated to each service. If the spacing limitations prohibit the erection of Specific Information Panels for all of the types of services available, preference shall be given to "GAS", "FOOD", "LODGING" or "CAMPING" services in that order. No panels shall be erected where minimum spacing limitations cannot be met.

If a panel(s) cannot be erected due to spacing limitations, a supplemental service sign, which lists the additional services available, may be erected below existing guide sign(s). Not more than three services may be erected below an existing guide sign.

- (5) On each exit ramp, a ramp panel for the qualified type of motorist service may be erected.

If all of the qualified services are visible from the exit ramp terminal, ramp panels are not required.

- (6) The ramp panel shall be erected as detailed on the signing plans for the interchange. If conditions permit, the successive panels along the ramp in the direction of traffic shall be those for "CAMPING", "LODGING", "FOOD", and "GAS" in that order.

- (7) The signing panels on the ramps should be consistent with those on the mainline. If there is insufficient space on

the ramp or the mainline for all the panels, priority shall be given to "GAS", "FOOD", "LODGING", then "CAMPING" services in that order. If panel(s) cannot be erected on a ramp due to spacing limitations, a supplemental service sign, which lists the additional services available, may be erected.

- (8) Panels shall not be erected at an interchange where the motorist cannot conveniently re-enter the freeway and continue in the same direction of travel. Panels shall not be erected at any interchange with another controlled access facility.

History Note: Authority G.S. 136-89.56; 136-137; 136-139;
143B-346; 143B-348; 143B-350 (f);
23 C.F.R. 750, Subpart A; 23 U.S.C. 131 (f);
Eff. April 1, 1982;
Amended Eff. April 1, 1986; November 1, 1985.

.0219 ELIGIBILITY FOR PROGRAM

Business signs may be permitted, provided said businesses comply with the following criteria and have a public telephone:

- (1) The individual business installation whose name, symbol or trademark appears on a business sign shall give written assurance of the business's conformity with all applicable laws concerning the provision of public accommodations without regard to race, religion, color, sex, or national origin.
- (2) The maximum distance that a "GAS", "FOOD", or "LODGING" service can be located from the Interstate, or other fully controlled access highway shall not exceed three miles, with the maximum distance being ten miles for a "CAMPING" service, in either direction via an all-weather road. Said distances shall be measured from the point on the interchange crossroad, coincident with the centerline of the Interstate, or other fully controlled access highway route median, along the roadways to the respective motorist service. The point to be measured to for each business is a point on the roadway that is perpendicular to the corner of the nearest wall of the business to the interchange. The wall to be measured to shall be that of the main building or office. Walls of sheds (concession stands, storage buildings, separate restrooms, etc.) whether or not attached to the main building are not to be used for the purposes of measuring.

If the office (main building) of a business is located more than .2 mile from a public road on a private road or drive, the distance to the office along the said

- drive/road shall be included in the overall distance measured to determine whether or not the business qualifies for business signing. The office shall be presumed to be at the place where the services are provided.
- (3) "GAS" and associated services. Criteria for erection of a business sign on a panel shall include:
- (a) appropriate licensing as required by law;
 - (b) vehicle services for fuel, motor oil, tire repair (by an employee) and water;
 - (c) restroom facilities and drinking water suitable for public use;
 - (d) an on-premise attendant to collect monies, make change, and make or arrange for tire repairs;
 - (e) year-round operation at least 16 continuous hours per day, seven days a week.
- (4) "FOOD". Criteria for erection of a business sign on a panel shall include:
- (a) appropriate licensing as required by law, and a permit to operate by the health department;
 - (b) year-round operation at least 12 continuous hours per day to serve three meals a day (sandwich type entrees may be considered a meal) (breakfast, lunch, supper), seven days a week;
 - (c) indoor seating for at least 20 persons;
 - (d) public restroom facilities.
- (5) "LODGING". Criteria for erection of a business sign on a panel shall include:
- (a) appropriate licensing as required by law, and a permit to operate by the health department;
 - (b) adequate sleeping accommodations consisting of a minimum of 10 units each, including bathroom and sleeping room;
 - (c) off-street vehicle parking for each lodging room for rent;
 - (d) year-round operation.
- (6) "CAMPING". Criteria for erection of a business sign on a panel shall include:
- (a) appropriate licensing as required by law, including meeting all state and county health and sanitation codes and having adequate water and sewer systems which have been duly inspected and approved by the local health authority (the operator shall present evidence of such inspection and approval);
 - (b) at least 10 campsites with accommodations for all types of travel-trailers, tents and camping vehicles;
 - (c) adequate parking accommodations;

- (d) continuous operation, seven days a week during business season;
- (e) removal or masking of said business sign by the Department during off seasons, if operated on a seasonal basis.

History Note: Authority G.S. 136-89.56; 136-137; 136-139;
143B-346; 143B-348; 143B-350(f);
23 C.F.R. 750, Subpart A; 23 U.S.C. 131(f);
Eff. April 1, 1982;
Amended Eff. April 1, 1986; November 1, 1985.

.0220 COMPOSITION OF SIGNS

Composition, design and layout of panels and logo signs shall be in accord with standards approved by the State Highway Administrator. Businesses which contract with the Department shall be furnished the standards and must conform the business signs to the standards.

No business sign shall be displayed which would mislead or misinform the traveling public. Any message, trademarks, or brand symbols which interfere with, imitate, or resemble any official warning or regulatory traffic sign, signal or device is prohibited.

History Note: Authority G.S. 136-89.56; 136-137; 136-139;
143B-346; 143B-348; 143B-350(f);
23 C.F.R. 750, Subpart A; 23 U.S.C. 131(f);
Eff. April 1, 1982.

.0221 FEES

(a) The fee for an initial installation is two hundred fifty dollars (\$250.00) per business sign. Contracts are renewed annually every November 1. The annual fee is two hundred fifty dollars (\$250.00) per business sign. The initial fee shall cover a one-year period beginning with placement and acceptance of the "business sign" or "logo sign" by the department. The fee for that period of time between the first anniversary of placement and acceptance and the first annual renewal date shall be the prorated portion of the annual fee. Any business which meets the criteria to participate in the program may pay the cost of initial installation of a complete logo sign panel subject to a credit to be determined by the department at the time it receives any fee from a business which later qualifies and elects to participate in the program on the subject panel. The aforesaid payment of the cost of initial installation of a complete logo sign panel in no way relieves the participating business from the

obligation of its payment of the annual maintenance fee per business sign.

(b) Fees are payable by check or money order and due in advance of the period of service covered by said fee. Failure to pay a charge when due is ground for removal of the sign and termination of the contract.

(c) When requested by a business, the department may perform additional requested services in connection with changes of the business sign, upon payment of twenty-five dollar (\$25.00) service charge per business sign, and any new or renovated business sign required for such purpose shall be provided by the applicant. If the department removes or masks a business sign because of seasonal operation, there will be no additional charge to the business.

(d) The department shall not be responsible for damages to business signs caused by acts of vandalism, accidents, natural causes (including natural deterioration), etc., requiring repair or replacement of business sign(s). Applicants in such event shall provide a new or renovated business sign together with payment of a twenty-five dollar (\$25.00) service charge per business sign to the Department to replace such damaged business sign(s).

(e) Any participating business which did not previously participate in the initial cost of the installation of logo sign panels, may by making application to the Department and paying the balance of construction costs not previously paid, avoid being removed from this program by applications of other businesses deemed closer to the interchange. This payment of the balance of construction costs in no way relieves the participating business from the obligation of its payment of the annual maintenance fee per business sign.

(f) Any business which meets the criteria to participate in the program, by making application to the Department and prepaying all construction cost fees for addition to existing logo signs, may avoid being removed from this program by applications of other businesses deemed to be closer to the interchange. This prepayment of all construction cost fees in no way relieves the participating business from the obligation of its payment of the annual maintenance fee per business sign.

History Note: Authority G.S. 136-89.56; 136-137; 136-139;
143B-346; 143B-348; 143B-350(f);
23 C.F.R. 750, Subpart A; 23 U.S.C. 131(f);
Eff. April 1, 1982;
Amended Eff. April 1, 1986; November 1, 1985;
October 1, 1985.

.0222 CONTRACTS WITH THE DEPARTMENT

(a) The department shall perform all required installation, maintenance, removal and/or replacement of all business signs upon panels.

(b) Individual businesses requesting placement of business signs on panels shall apply by submitting to the Department of Transportation a completed Agreement form. As a condition of said Agreement, the applicant must agree to submit the required initial fee within 30 days after the business is approved by the department. The department shall provide a statement(s) to the applicant at the time agreements are provided that itemize the number of business signs required, their fee(s) and remittance requirements. Failure to submit the required fee and forms will result in removal by the department of the business's signs from the construction project plans.

(c) Businesses must submit a layout of their proposed business sign for approval by the department before the business sign is fabricated.

(d) No business sign shall be displayed which, in the opinion of the department, is unsightly, badly faded, or in a substantial state of dilapidation. The department shall remove, replace, or mask any such business signs as appropriate. Ordinary initial installation and maintenance services shall be performed by the department at such necessary times upon payment of the annual renewal fee, and removal shall be performed upon failure to pay any fee or for violation of any provision of these Rules and the business sign shall be removed. The business shall furnish all business signs.

(e) When a business sign is removed, it will be taken to the division traffic services shop of the division in which the business is located. The business will be notified of such removal and given 30 days in which to retrieve their business sign(s). After 30 days, the business sign will become the property of the department and will be disposed of as the department shall see fit.

(f) Should the department determine that trailblazing to a business that is signed for at the interchange is desirable, it shall be done with an assembly (or series of assemblies) consisting of a ramp size business sign and an appropriate white on blue arrow. The business shall furnish all business sign(s) required and deemed necessary by the department. Fees shall be same as for other business sign(s). If several different services are located on the same business site, duplicate type logo signs shall not be erected in a single logo trailblazer installation. In such trailblazer installations, only one logo sign and one directional arrow sign will be used. The business may submit, subject to approval by the Department, different logo

signs to identify different services which may be located on the same business site.

(g) Should a business qualify for business signs at two interchanges, the business sign(s) will be erected at the nearest interchange. If the business desires signing at the other interchange also, it may be so signed provided it does not prevent another business from being signed.

(h) Where there are more businesses which meet the criteria to participate in the program than space is available on the panel(s), then those businesses closer to the interchange, measured as described in Rule .0219 (b), shall be permitted to participate, except as provided for in Subsections .0221 (a), (e), and (f).

(i) Should the number of businesses of a particular service at an interchange increase to more than the maximum number of business signs allowed on a panel, and a closer business qualifies and requests installation of its business signs, the business sign(s) of the farthest business shall be removed at the renewal date, provided that any business which has previously paid the full cost of erecting a panel shall not be removed under this subsection. A business which has turned down a previous opportunity offered by the Department to participate in the program may not qualify as a closer business under this subsection, except as provided for in Subsections .0221 (a), (e), and (f).

(j) When it comes to the attention of the department that a participating business is not in compliance with the minimum State criteria, the Division Engineer's Office shall promptly verify the information and if a breach or agreement is ascertained, inform the business that it will be given a maximum of 30 days to correct any deficiencies or its business signs will be removed. If the business is removed and later applies for reinstatement, this request shall be handled in the same manner as a request from a new applicant.

(k) The department reserves the right to cover or remove any or all business signs in the conduct of maintenance or construction operations, or for research studies, or whenever deemed by the department to be in the best interest of the Department or the traveling public, without advance notice thereof. The department reserves the right to terminate this program or any portion thereof by furnishing the business written notice of such intent not less than 30 calendar days prior thereto.

(l) The transfer of ownership of a business for which an agreement has been lawfully executed with the original owner shall not in any way affect the validity of the agreement for the business sign(s) of the business, provided that the appropriate

Division Engineer is given notice in writing of the transfer of ownership within 30 days of the actual transfer.

History Note: Authority G.S. 136-89.56; 136-137; 136-139;
143B-346; 143B-348; 143B-350(f);
23 C.F.R. 750, Subpart A; 23 U.S.C. 131(f);
Eff. April 1, 1982;
Amended Eff. April 1, 1986; November 1, 1985;
February 1, 1984.

.0223 APPEAL OF DECISION OF DIVISION ENGINEER TO SECRETARY

(a) Any business which applies to participate in the program and is refused or any business participating in the program which has its contract terminated, signs removed or believes that the program is otherwise not being administered in accord with these Rules, department policy or the terms of the agreement, may appeal the decision of the Division Engineer to the Secretary. The decision of the Secretary is final.

(b) The business which decides to appeal a decision of the Division Engineer shall so notify the appropriate engineer of his decision to appeal by certified mail, return receipt requested, within 10 days of the receipt of notice of the decision of the Engineer. The Division Engineer shall then forward the notice given to him by the business to the Secretary.

(c) Within 20 days from the time of submitting his notice of appeal to the Division Engineer, the business shall submit to the Secretary a written appeal setting forth with particularity the facts upon which its appeal is based.

(d) Within 30 days from the receipt of the said written appeal or within such additional time as may be agreed to between the Secretary and the business, the Secretary shall make an investigation of the said appeal. The Secretary shall then make appropriate findings of fact and conclusions pertaining to the appeal on behalf of the Department of Transportation and the findings and conclusion shall be served upon the business seeking the review by certified mail, return receipt requested.

History Note: Authority G.S. 136-89.56; 136-137; 136-139;
143B-346; 143B-348; 143E-350(f);
23 C.F.R. 750, Subpart A; 23 U.S.C. 131(i);
Eff. April 1, 1982.

(Use on I-95 Only)

ATTACHMENT 2

SPECIFICATION
FOR
REFLECTIVE SHEETING

1. SCOPE AND DESCRIPTION

1.1 This specification covers requirements for flexible, colored, reflective sheeting for use on highway signs. The reflective material specified herein is intended for use on surfaces of highway signs to assure their adequate visibility at all times upon exposure to a light source when totally dry or even if totally wet. The reflective sheeting is intended for application to new sheet aluminum (Aluminum Association alloy 6061-T6 and/or 5052-H38). This reflective sheeting shall consist of spherical lens elements embedded within a transparent plastic having a smooth, flat outer surface. This material as supplied shall be of good appearance, free from ragged edges, cracks, and extraneous materials and shall exhibit good quality workmanship. It shall have a protective backing (liner).

1.2 CLASSIFICATION

The reflective material shall be of the following types and classes.

- Type I - Sheeting, reflective (rolls)
- Type II - Tape, reflective (rolls)
- Class 1 - Pressure sensitive adhesive backing
- Class 2 - Heat activated adhesive backing.

1.3 SURFACE IDENTIFICATION

The reflective sheeting specified herein shall have an identification mark on the surface. This mark shall appear on all colors of reflective sheeting supplied in accordance with this specification to signify that the sheeting meets all requirements of the specification. The identification mark shall not interfere with the function of the reflective device, but shall be visible to an inspector both in daylight and under illumination at night.

2. APPLICABLE SPECIFICATIONS AND STANDARDS

2.1 References to Specifications, Standards, and Test Methods shall be the latest edition of these documents. The following publications form a part of this specification to the extent specified herein:

Federal Specification L-S-300C, "Sheeting and Tape, Reflective: Nonexposed Lens, Adhesive Backing," March 20, 1979, Superintendent of Documents, U.S. Government Printing Office, Washington, D.C. 20402

ASTM Standards, American Society for Testing and Materials. 1916 Race Street, Philadelphia, Pennsylvania 19103

B-209 Specification for Aluminum and Aluminum-Alloy Sheet and Plate.

E-97 Standard Method for Test for 45-degree, 0-degree Directional Reflectance of Opaque Specimens by Filter Photometry.

D-523 Standard Method for Test for Specular Gloss.

E-284 Standard Definition of Terms Relating to Appearance of Materials.

E-810 Standard Test Method for Coefficient of Retroreflection of Retroreflective Sheeting.

HTO-21 - Specifications for Standard Highway Colors, Color Tolerance Charts (FHWA) - 1971, Department of Transportation, Federal Highway Administration, Washington, D.C. 20591

Munsell Book of Color, Munsell Color Company, 2441 North Calvert Street, Baltimore, Maryland 21218

3. REQUIREMENTS

3.1 General - Reflective sheeting manufactured to these specifications shall meet or exceed the requirements of Federal Specification L-S-300C and all the requirements of this specification. In case of a conflict, the requirements of this specification will prevail.

3.2 Photometric -

3.2.1 Brightness Values (dry) The reflective sheeting shall have the minimum brightness values shown in Table I. These values at 0.2 and 0.5, degrees divergence shall be expressed as average candlepower per foot candle per square foot of material. These measurements shall be conducted in accordance with Federal Specification L-S-300C or by an approved equally applicable method.

3.2.2 Brightness Values (totally wet) After accelerated weathering as specified in Federal Specification L-S-300C, the reflective intensity values of the sheeting material, when totally wet, shall not be less than 50% of the values in Table I.

3.3 Film -

3.3.1 General - The reflective sheeting shall have sufficient strength and flexibility so that it can be handled, processed, and applied according to the recommendations of the sheeting manufacturer without appreciable stretching, tearing, or other damage.

It shall permit application over and conformance to moderate, shallow embossing characteristics of certain sign borders and symbols. Following liner removal, the reflective sheeting shall not shrink more than 1/32 inch (0.79 mm) in 10 minutes nor more than 1/8 inch (3.18 mm) in 24 hours in any dimension per 9 inch (22.9 cm) square at 72°F (22°C) and 50% relative humidity.

3.3.2 Flexibility - The sheeting, when applied according to methods approved by the manufacture onto cleaned and etched 0.20 inch X 2 inch X 8 inch (5.08 mm X 5.1 cm X 20.3 cm) aluminum, conditioned (24 hours) and tested at 72°F and 50% relative humidity, shall be sufficiently flexible to show no cracking when bent around a 3/4 inch (19.05 mm) mandrel. The reflective material shall not be removable from the panels without damage.

TABLE I
MINIMUM REFLECTIVE INTENSITY VALUES

OBSERVATION (Divergence) Angle°	ENTRANCE (Incidence) Angle°	White	Brown	Yellow	Red	Orange	Green	Blue
0.2	-4	70	1.0	50.0	14.5	25.0	9.0	4.0
0.2	+30	30	0.3	22.0	6.0	7.0	3.5	1.7
0.5	-4	30	0.35	25.0	7.5	13.5	4.5	2.0
0.5	+30	15	0.2	13.0	3.0	4.0	2.2	0.8

3.3.3 Surface - The sheeting surface shall be smooth and flat to facilitate cleaning and to provide optimum wet performance and exhibit an 85° glossmeter reading of not less than 40 (ASTM D523-67, "Standard Method of Test for Specular Gloss"). The sheeting surface shall be readily processed and compatible with recommended transparent and opaque process colors and show no loss of the color coat with normal handling, cutting, and application.

The sheeting shall permit cutting, application, and color processing at temperatures of 60-100°F (16°-38°C) and relative humidities of 20-100%. The sheeting shall be heat resistant and permit force curing without staining of unapplied sheeting at temperatures up to 150°F (66°C), and up to 200°F (93°C) on applied sheeting. The sheeting surface shall be solvent resistant such that it may be cleaned with gasoline, VM&P naphtha, mineral spirits, turpentine, methanol and xylol without damage to the material.

3.3.4 Lens Elements - The reflective sheeting shall possess stable and durable spherical lens elements which, following separation from the film, shall show no deterioration following submersion in a 5N solution of sulphuric acid (H_2SO_4) for 30 minutes at 72°F (22°C).

3.4 Color - The color shall be as specified in Table II. The colors shall conform to standard colors as shown on the Color Tolerance Charts published by the Federal Highway Administration. The colors shall be the same both in daylight and under retro-reflective illumination during darkness. Color conformance shall be determined both visually and by comparison with these charts according to ASTM D 1535-68, "Standard Method of Specifying Color by the Munsell System". Conformance of this sheeting material to the chromaticity limits of Table II shall be determined by test instruments according to ASTM E-97-55, "Standard Method of Test for 45-Deg, 0-Deg Directional Reflectance of Opaque Specimens by Filter Photometry". Geometric characteristics must be confined to illumination incident within 10 degrees of and centered about, a direction of 45 degrees from the perpendicular to the test surface; viewing is within 15 degrees of, and centered about, the perpendicular to the test surface. Conditions of illumination and observation must not be interchanged. The standards to be used for reference shall be the MUNSELL PAPERS designated in Table II. Papers must be recently calibrated on a spectrophotometer.

The test instruments for the above mentioned tests shall be one or more of the following:

GARDNER Multipurpose Reflectometer or Model XL20
Color Difference Meter
GARDNER Model AC-2a Color Difference Meter or Model
XL30 Color Difference Meter
MEECO Model V Colormaster
HUNTERLAB D25 Color Difference Meter
HUMAN EYE (for use in comparison of nighttime color
against daytime color)

3.5 Adhesive -

- 3.5.1 The reflective sheeting shall include a pre-coated pressure sensitive adhesive or a tack-free, heat-activated adhesive, either of which may be applied without the necessity of additional adhesive coatings on the reflective sheeting or application surface.
- 3.5.2 The protective liner attached to the adhesive shall be removed by peeling without soaking in water or other solvents and shall be easily removed after accelerated storage for four hours at 160°F (71°C) under weight of 2.5 pounds per square inch (0.18 kg per square cm). The liner may be marked on the exposed side with the manufacturer's identification, application instructions, and/or other information commonly included on the manufacturer's commercial product.
- 3.5.3 The adhesive shall form a durable bond to new aluminum blanks of Aluminum Association alloys 6061-T6 and/or 5052-H38. This adhesive backing for reflective sheeting and tape shall produce a bond to support a 1-3/4 pound (0.79 kg) weight for five minutes, without the bond peeling for a distance of more than 2.0 inches (5.1 cm), when applied to a smooth aluminum surface and tested in accordance with paragraph 4.4.4 of Federal Specification L-S-300C.

3.6 Durability -

- 3.6.1 Reflective sheeting processed, applied to sign base materials, and cleaned in accordance with methods approved by the manufacturer for use on traffic control signs, shall perform satisfactorily for the number of years stated in Table III. The reflective sheeting is deemed to have

TABLE II

COLOR SPECIFICATIONS LIMITS AND REFERENCE STANDARDS

Color	Chromaticity Coordinates*								Reflectance Limit		Ref. Std. MUNSELL PAPERS
	1		2		3		4		Y		
	x	y	x	y	x	y	x	y	Min.	Max.	
White	.305	.290	.350	.342	.321	.361	.276	.308	35.0	----	6.3GY 6.77/0.8
Gold	.433	.390	.475	.420	.452	.450	.410	.420	20.0	30.0	.55Y 5.38/7.4
Brown	.445	.353	.604	.396	.556	.443	.445	.386	4.0	9.0	5YR 3/6
Yellow	.482	.450	.532	.465	.505	.494	.475	.485	29.0	45.0	1.25Y 6/12
Orange	.535	.375	.607	.393	.582	.417	.535	.399	18.0	30.0	2.5YP 5.5/14.0
Red	.602	.317	.664	.336	.644	.356	.575	.356	8.0	12.0	8.2R 3.78/14.0
Dark Red	.622	.311	.688	.311	.659	.341	.622	.341	5.0	9.0	6.8R 3.56/14.6
Green	.130	.369	.180	.391	.155	.460	.107	.439	3.5	9.0	.65BG 2.84/8.45
Blue	.147	.075	.176	.091	.176	.151	.106	.113	1.0	4.0	5.8PB 1.32/6.8

*The four pairs of chromaticity coordinates determine the acceptable chromaticities on the CIE chromaticity diagram.

failed if, before it reaches the performance life specified in Table III, it has deteriorated to the extent that: (a) the sign is ineffective for its intended purpose when viewed from a vehicle, or (b) the average nighttime reflective brightness is less than that specified in Table III, or (c) the color has stained, discolored, streaked, faded, or turned dark, or (d) the material has developed cracks, scaling, pitting, blistering, edge lifting, or other deterioration.

If the reflective material has not performed satisfactorily in accordance with the above paragraph for the time specified, it is deemed to have failed.

TABLE III

<u>SHEETING TYPE AND COLOR</u>	<u>AVERAGE MINIMUM CANDLEPOWER PER FOOT CANDLE PER SQUARE FOOT (CANDELAS) PER LUX PER SQUARE METER) AT 0.2° DIVERGENCE AND -4° INCIDENCE*</u>	<u>SATISFACTORY PERFORMANCE LIFE (YEARS)</u>
White	35.00	7
Yellow	25.00	7
Red	7.25	7
Blue	2.00	7
Green	4.50	7
Orange	12.50	5
Brown	0.50	7

*Following sign cleaning in accordance with procedures approved by the sheeting manufacturer, candlepower measurements shall be made.

- 3.6.2 The reflective material exposed for 24 months in Florida at 45° south facing, unprotected, shall not support fungus growth and accumulate dirt to the extent that the reflective brightness before cleaning is less than 75% of the reflective brightness after cleaning, when measured at 0.2° divergence and -4° incidence.
- 3.6.3 Cleaning and clear overcoating shall not be required to enable the sheeting to meet the performance life specified in Table III.

ATTACHMENT 3

STANDARD SIGN PANELS SPECIFICATIONS

Standard sign panels shall be fabricated from aluminum alloy sheets. The materials shall conform to the requirements of the following specifications:

<u>Aluminum</u>	<u>Aluminum Association Alloy</u>	<u>ASTM Spec.</u>
Sheets and Plates	6061-T6 or 5052 H38	B209

PREPARATION OF ALUMINUM SIGN SURFACES

Preparation of aluminum shall conform to the requirements of Subarticle 1.5.5(E) of the "Standard Specifications for Structural Supports for Highway Signs, Luminaires and Traffic Signals", AASHTO 1975.

Prior to application of reflective sheeting to the aluminum, the sign panels shall be treated in strict accordance with one of the following procedures:

(A) Cleaning and Etching:

1. Preliminary Cleaning:

A complete immersion in an eight percent solution of inhibited alkaline cleaner at 160°F (71°C) to 180°F (82°C) for six minutes followed by a cold water rinse.

2. Etching:

The metal shall be given, at the option of the Contractor, either an acid etch or an alkaline etch. The etching shall provide a clean, mat, nonshine or non-glare finish suitable for the application of paint or sheeting and for the unpainted back or reverse side of highway signs.

For acid etch, the metal shall be cleaned and then given a surface etch by complete immersion for a period of not less than 16 minutes in an 18 to 20 percent dilute phosphoric acid solution followed by spraying with a cold water rinse and immersion for one minute in circulating hot water at not less than 180°F (82°C).

For alkaline etch, the metal shall be cleaned and then given a surface etch by immersion in an alkaline etching material that is controlled by titration. The immersion period, temperature, and concentration of the etching solution is to be as recommended by the solution manufacturer. After immersion, the metal is to be thoroughly rinsed followed by removal of all smut with an acidic

chromium compound type solution as recommended by the manufacturer of the etching solution and then given a second thorough rinse.

(B) Chromate Conversion Coating:

In lieu of cleaning and etching, the aluminum sheet may be treated with a chromate conversion coating so that the metal will be suitable for the direct application of reflective sheeting.

(C) Handling:

No metal shall be handled, except by appropriate handling devices or by workmen wearing clean canvas gloves, between the beginning of the cleaning operations and the completion of the application of the paint or reflective sheeting. There shall be no opportunity for the metal to come in contact with grease, oils, or other contaminants during such time period.

ATTACHMENT 4

SPECIFICATION FOR HIGH PERFORMANCE WIDE ANGLE RETROREFLECTIVE SHEETING

1.0 Scope

- 1.1 This specification covers flexible, colored, wide angle retroreflective sheeting designed to enhance nighttime visibility of signs and objects.

Printed colored areas of signs are covered only by section 5.2.4.

- 1.2 Prequalification. Retroreflective sheeting offered to the using agency shall be prequalified as follows:

1.2.1 Sheeting manufacturer shall provide certified test data showing that representative production material of the type to be supplied has met the requirements for accelerated outdoor weathering in Section 5.9.

1.2.2. Sheeting manufacturer shall provide documented evidence that representative production material of the type to be supplied has been used successfully in a substantial traffic signing program in similar climatic conditions for at least two years.

2.0 APPLICABLE DOCUMENTS

The following documents, latest issue in effect, form a part of this specification to the extent specified herein:

- 2.1 ASTM Standards, American Society for Testing and Materials
1916 Race Street, Philadelphia, Pennsylvania 19103
- 2.1.1 B-209 Specification for Aluminum and Aluminum-Alloy Sheet and Plate.
- 2.1.2 E-97-Standard Method for Test for 45-degree 0-degree Directional Reflectance of Opaque Specimens by Filter Photometry.
- 2.1.3 D523-Standard Method for Test for Specular Gloss.
- 2.1.4 E-284-Standard Definition of Terms Relating to Appearance of Materials.
- 2.1.5 E-810-Standard Test Method for Coefficient of Retroreflection of Retroreflective Sheeting.

3.0 CLASSIFICATION

3.1 Retroreflective sheeting shall consist of a white or colored sheeting having a smooth outer surface which has retroreflective properties over its entire surface.

3.1.1 The sheeting shall have either a precoated pressure sensitive adhesive (Class I) or a tack-free adhesive (Class 2) activated by heat applied in a heat-vacuum applicator in a manner recommended by the sheeting manufacturer. Both adhesive classes shall be protected by an easily removable liner.

4.0 TEST METHODS

4.1 Test Conditions. Unless otherwise specified herein, all applied and unapplied test samples and specimens shall be conditioned at the standard conditions of $70^{\circ} \pm 3^{\circ}\text{F}$ ($21^{\circ} \pm 2^{\circ}\text{C}$) and $50\% \pm 5\%$ Relative Humidity for 24 hours prior to testing.

4.2 Test Panels. Unless otherwise specified herein, when tests are to be performed using test panels, the specimens of retroreflective material shall be applied to smooth aluminum cut from ASTM B-209 Alloy 5052-H36, 5052-H8, 5154-H38, 5052-H38, or 6061-T6 sheets on 0.020 inch (0.051 cm), 0.040" (0.102 cm) or 0.063" (0.160 cm) thickness. The aluminum shall be degreased, lightly acid etched, and chromate conversion coated in accordance with Department of Correction standard manufacturing procedures before the specimens are applied. The specimens shall be applied to the panels in accordance with the recommendations of the retroreflective sheeting manufacturer.

5.0 TESTS AND OTHER REQUIREMENTS

5.1 Color Requirements. Conformance to color requirements shall be determined by instrumental method in accordance with ASTM E97 (Geometric characteristics must be confined to: Illumination incident within 10 degrees of and centered about a direction of 45 degrees from a perpendicular to the test surface, viewing is within 15 degrees of, and centered about, a perpendicular to the test surface. Conditions of illumination and observation must not be interchanged). The standards for calibrating the test apparatus shall be the MUNSSELL PAPERS designated in Table I or II. They must be recently calibrated on a spectrophotometer. The test instrument shall be one of the following:

1. Gardner Multipurpose Reflectometer or Model XL20 Color Difference Meter.
2. Gardner Models AC-2a or XL30 Color Difference Meter.
3. Meeco Model V Colormaster.
4. Hunterlab D25 Color Difference Meter.

TABLE I

Color Specification Limits* and Reference Standards

Color	x	y	x	y	x	y	x	y	Reflectance Limit (Y)		Munsell Paper***
									Min.	Max.	
White**	.303	.287	.368	.353	.340	.380	.274	.316	27.0		5PB 7/1
Yellow	.498	.412	.557	.442	.479	.520	.438	.472	15.0	40.0	1.25Y 6/12
Red	.613	.297	.708	.292	.636	.364	.558	.352	2.5	11.0	7.5R 3/12
Blue	.144	.030	.244	.202	.190	.247	.066	.208	1.0	10.0	5.8PB 1.32/6.8
Green	.030	.380	.166	.346	.286	.428	.201	.776	3.0	8.0	10G 3/8
Orange	.550	.360	.630	.370	.581	.418	.516	.394	14.0	30.0	2.5YR 5.5/14.0

*The four pairs of chromaticity coordinates determine the acceptable color in terms of the CIE 1931 standard colorimetric system measured with standard illumination Source C.

**Silver white is an acceptable color designation.

***Available from Munsell Color Company, 2441 Calvert Street, Baltimore, Maryland 21218. Catalog No. MCP-90040.

5.2 Coefficient of Retroreflection. The coefficients of retro-reflection shall be determined in accordance with ASTM E-810, for the minimum requirements of Table II, as specified.

5.2.1 Units. Coefficients of retroreflection shall be specified in units of candelas per footcandle per square foot.

5.2.2 The observation angles shall be 0.2° and 0.5°.

5.2.3 The entrance angles shall be -4° and 30°.

TABLE II

Minimum Coefficient of Retroreflection
(Candelas Per Footcandle Per Square Foot)

Observation Angle (°)	Entrance Angle (°)	White	Red	Yellow	Green	Blue	Orange
0.2	-4	250	45	170	45	20.0	100.0
0.2	+30	150	25	100	25	11.0	60.0
0.5	-4	95	15	62	15	7.5	30.0
0.5	+30	65	10	45	10	5.0	25.0

5.2.4 For areas printed with transparent colors, the coefficient of retroreflection shall be not less than 50% of the above values for the corresponding color in Table II.

5.3 Specular Gloss. The reflective sheeting shall have an 85° specular gloss of not less than 50 when tested in accordance with ASTM-D523.

5.4 Color Processing. The sheeting shall permit cutting and color processing with compatible transparent and opaque process colors in accordance with the sheeting manufacturer's recommendation at temperatures of 60°F to 100°F (16°C to 38°C).

The sheeting shall be heat resistant and permit curing without staining of applied or unapplied sheeting at temperatures recommended by the sheeting manufacturer.

5.5 Shrinkage. A 9-inch by 9-inch reflective sheeting specimen with liner shall be conditioned a minimum of one hour at standard conditions. The liner shall be removed and the specimen placed on a flat surface with the adhesive side up. Ten minutes after the liner is removed and again after 24 hours, the specimen shall be measured to determine the amount of dimensional change. The reflective sheeting shall not shrink in any dimension more than 1/32 inch in 10 minutes in any dimension nor more than 1/8 inch in 24 hours.

5.6 Flexibility. The sheeting with the liner removed and conditioned as in 4.1 shall be sufficiently flexible to show no cracking when slowly bent, in one seconds' time around a 1/8 inch mandrel with adhesive contacting the mandrel. Talcum powder shall be spread on the adhesive to prevent sticking to the mandrel.

5.7 Adhesive. The protective liner attached to the adhesive shall be removed by peeling without soaking in water or other solutions without breaking, tearing, or removing

any adhesive from the backing. The protective liner shall be easily removed following accelerated storage for 4 hours at 160°F (71°C) under a weight 2.5 pounds per square inch (0.176 Kg/cm²). The adhesive backing of the reflective sheeting shall produce bond to support a 1-3/4 pound weight (0.79 Kg) for 5 minutes, without the bond peeling for a distance of more than 2 inches (5.08 cm) when applied to a test panel prepared as in 5.2. Apply 4 inches of a 1" X 6" (2.54 cm X 15.2 cm) specimen to a test panel. Condition and then suspend the weight from the free end of the sample and allow it to hang free at an angle of 90° to the panel surface for 5 minutes.

5.8 Impact Resistance. The reflective sheeting, applied according to the manufacturer's recommendations to a cleaned, etched, chromate conversion coated aluminum panel of alloy 5052-H 38, 0.04" (0.10 cm) by 3" (7.6 cm) by 5" (12.7 cm) and conditioned as in 5.1, shall show no cracking when the face of the panel is subjected to an impact of a 2-inch diameter steel ball (1.19 lbs., 0.54 Kg) dropped from a height of 8.5 inches (21.6 cm) through a 2.125-inch (5.4 cm) tube.

5.9 Resistance to Accelerated Outdoor Weathering. The reflective surface of the sign shall be weather resistant and show no appreciable cracking, blistering, crazing, dimensional change or delamination after two years unprotected outdoor exposure facing the equator and inclined 45° from the vertical.

After cleaning, the coefficient of retroreflection shall not be less than 80% of the values in Table II and the colors shall conform to paragraph 5.9.1.

Following weather exposure, panels shall be washed in a 5% HCL solution for 45 seconds, rinsed thoroughly with clean water, blotted with a soft clean cloth, brought to equilibrium at standard conditions tested. The sample shall:

- 5.9.1 Show "good" colorfastness or better when tested as in 5.10.
- 5.9.2 Show no evidence of cracking, scaling, pitting, blistering, edge lifting, curling or more than 1/32 inch (0.08 cm) shrinkage or expansion.
- 5.9.3 Retain not less than 80 percent of the coefficient of retroreflection values specified in Table II.
- 5.9.4 Not be removable from the aluminum panels without damage.

Retroreflective photometric performance measurements after weather exposure shall be made only at angles of 0.2° observation and -4° entrance. Where more than one panel of a color is measured, the coefficient of retroreflection shall be the average of all the determinations.

5.10 Colorfastness

One specimen, exposed and prepared as specified in 5.9 shall be wet out with a mild detergent and water solution and compared with a similarly treated unexposed specimen under natural (North sky) daylight or artificial daylight having a color temperature of 7600° Kelvin. The colorfastness shall be evaluated as follows:

Excellent - No perceptible change in color.

Good - Perceptible but no appreciable change in color.

Appreciable change in color means a change that is immediately noticeable in comparing the exposed specimen with the original comparison specimen. If closer inspection or a change of angle of light is required to make apparent a slight change in color the change is not appreciable.

5.11 Coefficient of Retroreflection During Rainfall

The coefficient of retroreflection of the retroreflective sheeting when totally wet, shall not be less than 90% of the dry values in Table II. Wet performance measurements shall be made on new sheeting in accordance with the standard rainfall test below.

The coefficient of retroreflection under simulated rainfall conditions (wet performance) shall be determined using ASTM E-810 as in 5.2, but with the addition of the water nozzle setup as prescribed in Federal Specification FP-79.

Place the test panels on which the sheeting has been applied in an upright position six inches below and four inches in front of the water nozzle.

Apply sufficient water pressure so that the upper surface of the spray envelope strikes the top of the specimen. With water falling on the specimen, determine the coefficient of retroreflection at angles of 0.2° observation and minus 4° entrance only. Where more than one panel of a color is measured the coefficient of retroreflection during rainfall shall be the average of all the determinations.

PERFORMANCE REQUIREMENTS

6.1 Certification

The manufacturer of the sheeting shall submit with each lot or shipment, a certification which states that the material supplied will meet all of the requirements listed herein.

6.2 Manufacturer's Field Performance Warranty and Obligation

The fabricator warrants to the purchaser that all materials furnished under this specification will be new, of good components and workmanship and agrees to the following conditions. Retroreflective sheeting processed and applied to sign blank materials in accordance with the manufacturer's recommendations, shall be warranted by the manufacturer to perform effectively for the number of years stated in Table III of this specification. The retroreflective sheeting will be considered unsatisfactory if it has deteriorated due to any cause except defacement resulting from vandalism or damage resulting from impact by a motor vehicle or other object to the extent that:

- (1) the sign is ineffective for its intended purpose when viewed from a moving vehicle under normal day and night driving condition,

or

- (2) the coefficient or retroreflection is less than the minimum specified for that sheeting during that period listed in Table III, and shall not decrease more than 16% during the seven-year warranty period nor more than 20% during the 10-year warranty period when measured by a Model 910-F GAMMA SCIENTIFIC, INC. reflectometer,

or

- (3) the sign is unsatisfactory with regard to uniform appearance, color, and reflectorization due to cracking, delamination, blistering, crazing, or discoloration of the sheeting, as determined in 6.2.3 below.

TABLE III

MINIMUM COEFFICIENT OF RETROREFLECTION
Candelas per Footcandle per Sq. Ft.
(.2° DIV. and -4° INCIDENCE) (1)

Sheeting Color	Minimum Coefficient of Retro. (Three Years)	Minimum Coefficient of Retro. (Seven Years)	Minimum Coefficient of Retro. (Ten Years)
White		212	200
Yellow		144	136
Green		38	36
Red		38	36
Blue		17	16
Orange	80		

(1) All measurements shall be made after sign cleaning.

6.2.1 Where the performance requirements have not been met, the manufacturer shall cover the sign costs as follows for sheetings shown to be unsatisfactory during:

The First Ten Years - The manufacturer shall cover the cost of restoring the sign face to its original effectiveness at no cost to the purchaser.

6.2.2 The fabricating agency shall be responsible for dating all signs (month, year) at the time of sheeting application. That date constitutes the start of the field performance obligation period.

6.2.3 Finished signs shall be uniform in appearance and color(s) over the entire reflecting surfaces both day and night. Said signs shall display the same color(s) both in daylight and under automobile headlights at night. Each sign will be subjected to a visual test* both in daylight and under illumination from automobile headlights at night. Objectionable non-uniformity of color(s) in daylight shall be cause for rejection of the sign. Objectionable non-uniformity of color(s) and reflectivity (retroreflection) under automobile headlights at night shall be cause for the sign to be tested for retroreflection to determine compliance with the following requirements. The retroreflection values on any sign shall not vary from each other by more than a ratio of 1.30 at any

*For this test, the human eye shall be the test instrument.

two points 12 inches apart, nor more than 1.50 at any two points anywhere on the sign, nor more than 1.30 at any two points on the border or between any two adjacent letters, numerals, or symbols. Failure to meet the above requirements shall be cause for rejection of the sign. Retroreflection will be tested using a Gamma Scientific Retroreflectometer Model 910-F.

- 6.2.4 The manufacturer supplying the sheeting shall issue, in writing, a declaration that:
- A. The conditions of storage of the retro-reflective sheeting in the fabricator's warehouses and/or fabrication plants are acceptable.
 - B. The treating processes of the substrate material as currently being used by the fabricator is acceptable.
 - C. The sheeting application techniques, process colors and all other processes related to sign manufacturing as are currently being used by the fabricator are acceptable.
 - D. The methods of packaging and storage of finished signs as currently employed by the fabricator are acceptable.

TECHNICAL ASSISTANCE REQUIREMENTS

7.1 Instruction and Training

The manufacturer supplying the retroreflective sheeting shall provide the services of a qualified technician for instruction and training at the sign fabrication facilities designated by the fabricator. This instruction shall be available on an annual basis at no additional cost, and shall include but not be limited to training films, material application, equipment operation, silk screening techniques, packaging, storage and other proven sign shop practices as they apply to the reflective sheeting supplied by the manufacturer, and to assure that the resulting signs can comply with the applicable specifications.

Additional on-site technical assistance by the manufacturer supplying the retroreflective sheeting shall be provided at least once during each quarter of sign production, if required.

7.2 Technical Assistance

On-site technical service shall be available within 72 hours of notification by the manufacturing shop of production difficulties.

7.3 Equipment

The manufacturer supplying the retroreflective sheeting shall provide service for his recommended sheeting application equipment and certify that factory trained personnel be available on 72 hours notice to render such service.

"Service" is understood to mean the capability of calibration and trouble shooting, as well as the training and retraining of personnel as required.

SIGN FABRICATORS AND SUPPLIERS

As a service to businesses desiring to purchase logo signs, below is a list of sign fabricators and suppliers that have indicated they could furnish logo signs. The N.C. Department of Transportation is in no way recommending any of these companies or guaranteeing the quality of the product furnished by these companies. It should be noted that there are probably other sign fabricators and suppliers of which we are not aware that could supply you with logo signs. This list is not intended as an all inclusive list of sign fabricators and suppliers and the list may be changed as conditions warrant.

Allstate Sign & Plaque Corporation
79 Main Street
Mineola, New York 11501
(516) 747-0617

Atlanta Creative Graphics
993 Mansell Road
Roswell, GA 30075
(404) 587-0188

CoSco Signs
Route 14, Box 347
Lexington, NC 27292
(919) 764-2958

Modern Metal Products Co.
P. O. Box 20388
Greensboro, NC 27420
1-800-632-1250

Dave Smith & Company, Inc.
Drawer 7717
Ft. Lauderdale, Florida 33338
(305) 566-5300

Hall Signs, Inc.
P. O. Box 313
3000 W. Third
Bloomington, Indiana 47401
(818) 332-9355

Harlan Laws Corporation
Drawer 15070
Durham, NC 27704
(919) 596-2124

Interstate Highway Sign Co.
P. O. Box 2380
6005 Scott Hamilton Drive
Little Rock, Arkansas 72203
(501) 565-8484

Korman Signs, Inc.
3027 Lincoln Avenue
Richmond, VA 23228
(804) 262-6050

Sargent-Sowell, Inc.
1185 108th Street
Grand Prairie, Texas 75050
(214) 647-1525

Superior Manufacturing Co., Inc.
Traffic Control Products
P. O. Box 5953
Jackson, Mississippi 39208
(601) 939-2132

Vulcan Signs and Stampings
P. O. Box 850
400 E. Berry Avenue
Foley, Alabama 36535
(205) 943-1541

Walter Sign Corporation
4700 76th Street
Elmhurst, New York 11373
(212) 899-7000

ID Systems
181 Armour Drive, N.E.
Atlanta, GA 30324
(404) 876-4860

Universal Signs & Accessories
2912 Orange Avenue
Fort Pierce, Florida 33450
(305) 461-0665

Showalter Signs
P. O. Box 403
Luray, VA 22835
(703) 743-7343

Revised 5-28-86

Revised 8-26-86

Revised 10-6-86



U.S. Department
of Transportation
Federal Highway
Administration

Memorandum

RECEIVED
REG. 4 F.H.W.A.

NORTH CAROLINA

MAR 16 1983

Subject: Vending Machines in Safety Rest Areas
Constructed or Located on the Interstate
Highway System

Date: MAR 11 1983

From: Associate Administrator for
Engineering and Operations
Washington, D.C. 20590

Reply to HNG-21
Attn. of:

To: Regional Federal Highway Administrators
Regions 1-10

This memorandum is being issued to provide guidance in the implementation of Section 111 of the Surface Transportation Assistance Act (STAA) of 1982 as it relates to the installation of vending machines in Interstate Highway System rest areas.

Section 111 of the act grants the States the authority to permit the placement of vending machines in safety rest areas constructed or located on rights-of-way of the National System of Interstate and Defense Highways. This is viewed as a logical expansion of the demonstration project mandated by the 1978 Surface Transportation Assistance Act and in which five States participated. Prior to this act, with the exception of the demonstration project, no commercial establishments were permitted on the Interstate System right-of-way.

In order to assist you in the implementation of Section 111, we are providing you with the following as guidance:

1. A vending machine is a coin or currency operated machine capable of automatically dispensing an article or product. By limiting installations to vending machines, it is expressly intended to preclude a vendor from establishing a stand or shop for the purpose of selling the article or product and also to exclude any form of personal salesmanship.
2. Items which may be dispensed are limited to such food, drink, and other articles as the State highway agency determines to be appropriate and desirable. Section 111 of Title 23 continues to prohibit automotive service stations on the rights-of-way of the Interstate System. Based on this prohibition, the dispensing, by any means, of petroleum products or motor vehicle replacement parts is banned.
3. The State highway agency need not operate the vending machines directly. It may enter into contracts with vendors for the installation, operation, and maintenance of such vending machines. All States, including those which are participating in the 1978 vending machine demonstration project, must give priority to vending machines operated through the State licensing agency designated pursuant

to the Randolph-Sheppard Act. All contracts shall be in writing and shall ensure retention by the State highway agency of full responsibility for and control over all activities within the rest area.

4. Mr. Phillips' March 26, 1982, office memorandum extended the completion date of the 1978 vending machine demonstration project to October 1, 1983, by which time all machines installed under the project must have been removed. Any continued operation beyond that date must be according to the STAA of 1982. Therefore, the States involved with the demonstration project should accomplish the Randolph-Sheppard Act coordination by the October date if the vending machine services are to be continued at the demonstration locations.
5. Documentation demonstrating a positive initiative to involve the designated Randolph-Sheppard Act State agency will be required before the State highway agency proposes alternate organizations or corporations to operate the vending machines. However, if the designated Randolph-Sheppard Act agency waives its rights in writing, the State highway agency is free to negotiate agreements described in "3" above with any organization or corporation.
6. We are in the process of documenting the fact that there was a technical error with legislation requiring all vending machines to be installed prior to October 1, 1983. Because we are optimistic this will be accomplished, you may proceed under the assumption that there will be no time limit for the installation of vending machines.
7. The ineligibility of Federal assistance for installation, operation, and maintenance of the vending machines includes any modification in existing rest area facilities or the construction of new facilities. This exclusion from Federal-aid participation would also extend to power supplies, water sources and any other ancillary items necessary for the installation, operation, and maintenance of the vending machines.
8. The nondiscrimination provisions of FHPM 6-2-5-1 paragraph 9c(6) apply to the installation, operation, and maintenance of vending machines.
9. The FHPM 6-2-5-1 paragraphs 6(e), 9c(5), and 12d will be modified to reflect the changes resulting from this act.

10. Attached is a list of the Randolph-Sheppard Act licensing agency for each State.

A handwritten signature in black ink, appearing to read "Rex C. Leathers". The signature is stylized with large, sweeping loops and a long horizontal stroke at the end.

Rex C. Leathers

Attachment

GENERAL ASSEMBLY OF NORTH CAROLINA
SESSION 1985
RATIFIED BILL

CHAPTER 718
SENATE BILL 319

AN ACT TO PERMIT THE DIVISION OF SERVICES FOR THE BLIND OF THE DEPARTMENT OF HUMAN RESOURCES TO OPERATE VENDING MACHINES ON INTERSTATE HIGHWAYS AND CONTROLLED-ACCESS HIGHWAYS.

The General Assembly of North Carolina enacts:

Section 1. G.S. 136-18(9) is amended by deleting the last sentence of that subdivision and by substituting:

"None of the roadside parks, picnic areas, picnic tables, scenic overlooks or other turnouts, or any part of the highway right-of-way shall be used for commercial purposes except for vending machines permitted by the Department of Transportation and placed by the Division of Services for the Blind, Department of Human Resources, as the State licensing agency designated pursuant to Section 2 (a) (5) of the Randolph-Sheppard Act (20 USC 107a (a) (5)). The Department of Transportation shall regulate the placing of the vending machines in highway rest areas and shall regulate the articles to be dispensed. Every other use or attempted use of any of these areas for commercial purposes shall constitute a misdemeanor and each day's use shall constitute a separate offense."

Sec. 2. The first sentence of G.S. 136-89.56 is amended by adding immediately after the words "as defined in this Article" the words: ", except for vending machines permitted by the Department of Transportation and placed by the Division of Services for the Blind, Department of Human Resources, as the State licensing agency designated pursuant to Section 2(a) (5) of the Randolph-Sheppard Act (20 USC 107a(a)(5))".

Sec. 3. G.S. 136-89.56 is amended by adding a new sentence immediately after the first sentence to read: "The Department of Transportation shall regulate the placing of the vending machines in highway rest areas and shall regulate the articles to be dispensed."

Sec. 4. This act shall be set up as a pilot program at six sites statewide; two (2) sites shall be North Carolina Welcome Centers and four (4) sites shall be rest stops.

Sec. 5. The Department of Human Resources, Division of Services for the Blind, shall report on the implementation and operation of the pilot program to the Joint Legislative Commission on Governmental Operations and to the Fiscal Research Division no later than May 1, 1986.

Sec. 6. This act is effective upon ratification and shall expire on June 30, 1987.

In the General Assembly read three times and ratified, this the 12th day of July, 1985.

ROBERT B. JORDAN III

Robert B. Jordan III
President of the Senate

LISTON B. RAMSEY

Liston B. Ramsey
Speaker of the House of Representatives

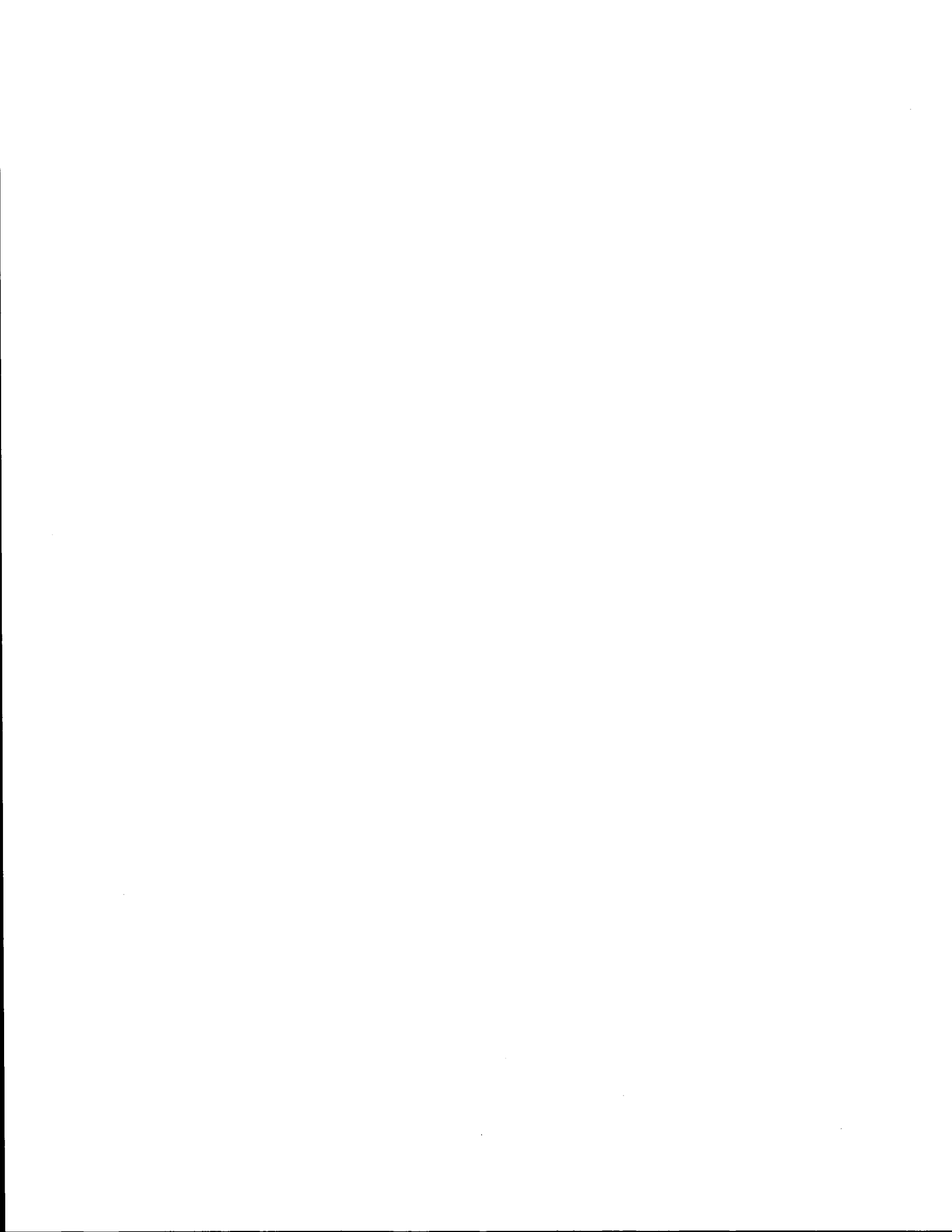

NORTH DAKOTA

- Legislation



NORTH DAKOTA

24-03-22. Highway maintenance radio net. The department is hereby authorized to purchase, install and maintain a state highway department radio communications network out of funds now and hereinafter designated as state highway maintenance funds. The department is further authorized to enter into an agreement with the federal civil defense administration for the purchase of radio equipment for said radio communications network on a 50-50 fund matching basis.

24-03-23. Encroachments on state highways. No part of the right of way for state highways shall be encroached upon by erection thereon of any structure, or placing thereon any personal property, other than a temporary parking of a motor vehicle, without a written permit from the commissioner. Any encroachment may be caused to be removed, obliterated, or corrected by order of the commissioner and the total cost thereof shall be paid by the person responsible for the encroachment. Property other than motor vehicles left upon highway right of way for a period exceeding seventy-two hours, the ownership of which cannot be determined after reasonable effort has been made to do so, shall be deemed abandoned and may be removed from the right of way and stored at the nearest site available for thirty days and if it is not claimed by the owner during such period, and the cost of removal and storage paid, it may be disposed of in the manner prescribed by the commissioner. Abandoned motor vehicles shall be subject to the provisions of sections 39-26-01 through 39-26-11. If such property shall be disposed of it shall, except as otherwise provided by this section, be sold or disposed of in the manner provided in sections 39-26-05 through 39-26-09. The receipts therefrom shall be deposited in the state treasury as provided in section 1 of article IX of the Constitution of North Dakota and credited to the permanent school fund.

24-12-04. Injury to mileboards, guideposts, traffic-control signals, signs, or markings. No person shall remove, injure, or destroy any mileboard, milestone, or guidepost, traffic-control signals, signs, or markings, or any inscription thereon, erected or placed upon any highway, road or street by any public authority or by any contractor, subcontractor or employee engaged in construction activities pursuant to a contract with a public authority therefor.

24-12-04.1. Rewards authorized. The highway commissioner or any political subdivision of this state is hereby authorized to offer a reward, the amount of which shall be determined by the highway commissioner or the governing body of the political subdivision not exceeding however the sum of three hundred dollars, for any information leading to the conviction of any person or persons violating the provisions of this chapter.

~~24-12-05.~~ Penalties. Any person who violates any provision of this title for which another penalty is not specifically prescribed is guilty of a class B misdemeanor.

24-12-06. Penalty for running tollgate. Repealed by S.L. 1975, ch. 106, § 673.

PENNSYLVANIA

- Legislation



from within his department, board, or commission to serve in his stead. An ex officio member who designates a representative shall notify the chairman, in writing, of such designation.

The Governor, the President Pro Tempore of the Senate and the Speaker of the House of Representatives each shall appoint six public members to the State Transportation Advisory Committee. The public members must have recent and extensive experience and knowledge in the fields of transportation of people and goods from industry, labor, academic, consulting, research sources and the appointing authorities shall give due consideration to insure a balanced representation by facilities and modes for air, land and water transportation as they exist in the Commonwealth, both public and private. Two of the initially appointed members of the committee designated by each appointive power shall serve one year, two for terms of two years and two for terms of three years from the date of their appointment. A term of each initially appointed member shall be designated by the appointed person, but their successors shall each be appointed for terms of three years. Any person appointed to fill a vacancy shall serve for only the unexpired term. Any member of the committee may be appointed to succeed himself.

The Governor shall annually designate the chairman from among the public members.

The State Transportation Advisory Committee shall meet the first Monday in February of each year and hold at least three additional meetings during the calendar year. It shall have the power and its duty shall be to consult with and advise the State Transportation Commission and the Secretary of Transportation in behalf of all the transportation modes of the Commonwealth and to aid and assist the State Transportation Commission and the Secretary of Transportation in the determination of goals and the allocation of available resources among and between the alternative modes in the planning, development and maintenance of programs, and technologies for transportation systems and to advise the several modes the planning, programs and goals of the department, and the State Transportation Commission.

1929, April 9, P.L. 177, art. XX, § 2001.4, added 1970, May 6, No. 120, § 12. As amended 1973, June 21, P.L. 63, No. 26, § 1, imd. effective.

§ 512. (Adm. Code § 2002). Powers and duties of the department

(a) The Department of Transportation in accord with appropriations made by the General Assembly, and grants of funds from Federal, State, regional, local or private agencies, shall have the power, and its duty shall be:

(1) To develop and maintain a continuing, comprehensive and coordinated transportation planning process:

(2) To develop programs designed to foster efficient and economical public transportation services in the State:

(3) To prepare plans for the preservation and improvement of the commuter railroad system;

(4) To develop plans for more efficient public transportation service by motor bus operation:

(5) To prepare and develop plans and programs for all modes of urban transportation, including in addition to commuter rail and motor bus, rapid rail, trolley coach, surface rail, corridor rail, and other innovative modes of urban transportation;

(6) To coordinate the transportation activities of the department with those of other public agencies and authorities:

(7) To cooperate with interstate commissions and authorities, State departments, councils, boards, commissions, authorities and other State agencies, with political subdivisions of the Commonwealth, with appropriate Federal agencies, public agencies in other states, and with interested private individuals and organizations in the

For Title 71, Consolidated Statutes, see Appendix following this Title

coordination of plans and policies for the development of ground, air and water commerce and facilities;

(8) To mark, build, rebuild, relocate, fix the width of, construct, repair, and maintain State designated highways and transportation facilities and rights of way;

(9) To undertake the powers and duties formerly performed by the Department of Community Affairs under the act of January 22, 1968 (Act No. 8), known as the "Pennsylvania Urban Mass Transportation Assistance Law of 1967,"¹ and the powers and duties formerly performed by the Department of Community Affairs and the Department of Commerce under the act of January 22, 1968 (Act No. 7), known as "The Pennsylvania Transportation Assistance Authority Act of 1967."²

(10) To have exclusive authority and jurisdiction over all State designated highways;

(11) To superintend, supervise and control the work of constructing, reconstructing, maintaining and repairing State designated highways, and other transportation facilities and rights of way;

(12) To enter into contracts for designing, constructing, repairing, or maintaining, State designated highways, and other transportation facilities and rights of way, airports or any parts thereof, as may now or hereafter be provided by law;

(13) To prepare and submit every even-numbered year prior to the first day of September, to the State Transportation Commission for its consideration, a program which it recommends to be undertaken by the Department of Transportation during the twelve fiscal years next ensuing. Each two years thereafter, the Department of Transportation, taking into consideration the recommendations of the State Transportation Commission, and other relevant information, shall review, revise, adjust and extend its construction program for two years. The preparation and consideration of the program shall be coordinated with the preparation and consideration of the Commonwealth's Capital Program by the State Planning Board.

Copies of construction programs shall be supplied to the members of the General Assembly and shall be open to the public for inspection and shall be made available to interested persons. The priority of improvement shall be based upon relative need and sufficiency ratings maintained by the department.

Copies of construction programs shall be supplied to the members of the General Assembly and shall be open to the public for inspection and shall be made available to interested persons. The priority of improvement shall be based upon relative need and sufficiency ratings maintained by the department.

(14) To appear or intervene as a party, when the secretary deems it appropriate, before the Public Utility Commission when transportation problems are being considered by the commission.

(15) To consult with appropriate officials as designated by the chief administrative officer of the Department of Agriculture, the Department of Environmental Resources, the Department of Community Affairs, the Department of Health, State Planning Board and the Fish Commission regarding the environmental hazards and the agricultural, conservation, sanitary, recreation and social considerations that may arise by reason of the location, design, construction or reconstruction of any transportation or air facility.

No highway, transit line, highway interchange, airport, or other transportation corridor or facility, shall be built or expanded in such a way as to use any land from any recreation area, wildlife and/or waterfowl refuge, historic site, State forest land, State game land, wilderness areas or public park unless: (i) there is no feasible and prudent alternative to the use of such land, and (ii) such corridor or facility is planned and constructed so as to minimize harm to such recreation area, wildlife and/or waterfowl refuge, historic site, State forest land, State game land, wilderness area, or public park.

(16) To represent the transportation interests of the Commonwealth including any of its agencies or instrumentalities at the direction of the Governor, or when the

secretary deems it appropriate before any Federal agency or commission which determines national or regional transportation rates, routes or policy.

(17) To acquire, by purchase, lease, eminent domain proceedings, gift or otherwise, so as to restore or replace, for just compensation, from a railroad, or in the event any such railroad is subject to a proceeding under the Bankruptcy Law, by a direction from the court having jurisdiction in such bankruptcy proceedings to the trustee or trustees or the debtor to offer to convey to the State, for just compensation, all of its right, title, and interest free and clear of all encumbrances, in any right-of-way, tract and other related real and personal property on any branch line or other railroad within the State which has been damaged or destroyed within the period between January 1, 1972 and December 31, 1972 as a result of natural disaster or suspended by action of its owners or operator and which have not been scheduled for restoration or replacement under a Federal loan program and provided that there is demonstrated a valid need for the establishment or reestablishment of railroad service in the affected area.

(18) To sell or lease any right-of-way, track, and other related real and personal property on any branch line or other railroad within the State which has been damaged or destroyed within the period between January 1, 1972 and December 31, 1972 as a result of natural disaster or suspended by action of its owners or operators which has been acquired for restoration or replacement, so as to provide for the operation of restored or replaced railroad lines with regional and local public bodies and agencies and private corporations with the technical capability to carry out the proposed railroad service.

(b) Upon the submission of the preliminary plan or design to the Department of Transportation for any transportation route or program requiring the acquisition of new or additional right-of-way, the Department of Transportation except in cases involving complaint proceedings under the jurisdiction of the Public Utility Commission shall have the power and its duty shall be to follow the hearing procedures now or hereafter required by the Federal Government for Federal-aid transportation programs pursuant to Titles 23 and 49 of the United States Code as amended and the regulations and procedures thereunder even though the transportation route or program does not contemplate the use of or actually employ Federal funds. At the hearings required by this subsection the Department of Transportation shall consider the following effects of the transportation route or program:

- (1) Residential and neighborhood character and location;
- (2) Conservation including air, erosion, sedimentation, wildlife and general ecology of the area;
- (3) Noise, and air and water pollution;
- (4) Multiple use of space;
- (5) Replacement housing;
- (6) Displacement of families and businesses;
- (7) Recreation and parks;
- (8) Aesthetics;
- (9) Public health and safety;
- (10) Fast, safe and efficient transportation;
- (11) Civil defense;
- (12) Economic activity;
- (13) Employment;
- (14) Fire protection;
- (15) Public utilities;
- (16) Religious institutions;

For Title 71, Consolidated Statutes, see Appendix following this Title

coordination of plans and policies for the development of ground, air and water commerce and facilities;

(8) To mark, build, rebuild, relocate, fix the width of, construct, repair, and maintain State designated highways and transportation facilities and rights of way;

(9) To undertake the powers and duties formerly performed by the Department of Community Affairs under the act of January 22, 1968 (Act No. 8), known as the "Pennsylvania Urban Mass Transportation Assistance Law of 1967,"¹ and the powers and duties formerly performed by the Department of Community Affairs and the Department of Commerce under the act of January 22, 1968 (Act No. 7), known as "The Pennsylvania Transportation Assistance Authority Act of 1967."²

(10) To have exclusive authority and jurisdiction over all State designated highways;

(11) To superintend, supervise and control the work of constructing, reconstructing, maintaining and repairing State designated highways, and other transportation facilities and rights of way;

(12) To enter into contracts for designing, constructing, repairing, or maintaining, State designated highways, and other transportation facilities and rights of way, airports or any parts thereof, as may now or hereafter be provided by law;

(13) To prepare and submit every even-numbered year prior to the first day of September, to the State Transportation Commission for its consideration, a program which it recommends to be undertaken by the Department of Transportation during the twelve fiscal years next ensuing. Each two years thereafter, the Department of Transportation, taking into consideration the recommendations of the State Transportation Commission, and other relevant information, shall review, revise, adjust and extend its construction program for two years. The preparation and consideration of the program shall be coordinated with the preparation and consideration of the Commonwealth's Capital Program by the State Planning Board.

Copies of construction programs shall be supplied to the members of the General Assembly and shall be open to the public for inspection and shall be made available to interested persons. The priority of improvement shall be based upon relative need and sufficiency ratings maintained by the department.

Copies of construction programs shall be supplied to the members of the General Assembly and shall be open to the public for inspection and shall be made available to interested persons. The priority of improvement shall be based upon relative need and sufficiency ratings maintained by the department.

(14) To appear or intervene as a party, when the secretary deems it appropriate, before the Public Utility Commission when transportation problems are being considered by the commission.

(15) To consult with appropriate officials as designated by the chief administrative officer of the Department of Agriculture, the Department of Environmental Resources, the Department of Community Affairs, the Department of Health, State Planning Board and the Fish Commission regarding the environmental hazards and the agricultural, conservation, sanitary, recreation and social considerations that may arise by reason of the location, design, construction or reconstruction of any transportation or air facility.

No highway, transit line, highway interchange, airport, or other transportation corridor or facility, shall be built or expanded in such a way as to use any land from any recreation area, wildlife and/or waterfowl refuge, historic site, State forest land, State game land, wilderness areas or public park unless: (i) there is no feasible and prudent alternative to the use of such land, and (ii) such corridor or facility is planned and constructed so as to minimize harm to such recreation area, wildlife and/or waterfowl refuge, historic site, State forest land, State game land, wilderness area, or public park.

(16) To represent the transportation interests of the Commonwealth including any of its agencies or instrumentalities at the direction of the Governor, or when the

36 P.S. § 670-417
Note 4

HIGHWAYS AND BRIDGES

remedy was provided. *Vance v. Kassab*, 325 A.2d 924, 15 Pa.Cmwth. 328, 1974.

Suit to restrain secretary of department of transportation from constructing a drainage pipe which would allegedly "have the effect" of discharging water onto plaintiffs' property was not barred by doctrine of immunity inasmuch as plaintiffs did not seek affirmative action on part of secretary, but only sought to restrain him from installing highway drainage facilities claimed prospectively to be productive of an allegedly illegal and unconstitutional discharge of water. *Id.*

A complaint in equity by the Department of Highways to enjoin defendants from interfering with the entry of state employees on their land to maintain the highway drainage system and from

blocking or interfering with such system will not be dismissed on the ground that the Department has an adequate remedy at law under this section imposing a penalty. *Com. v. Sullenberger*, 87 Dauph. 62, 1967.

5. Damages

Entitlement to and determination of damages under statute [36 P.S. § 670-417] allowing property owners compensation for damages that result from Department of Transportation's entry upon land for drainage system maintenance is governed exclusively by eminent domain code. In re Condemnation By Com., Dept. of Transp., 506 A.2d 990, Cmwth.1986.

§ 670-418. Changing or protecting stream channels

Notes of Decisions

Construction and application ½

facilities bordering defendant's land and a highway, equity lacked jurisdiction to entertain defendant's counterclaim seeking to have plaintiff change its drainage system in keeping with the natural contour of his lands. *Com. v. Devlin*, 23 D. & C.2d 552, 76 Dauph. 27, 1962.

½. Construction and application

In action by Commonwealth to enjoin defendant from interfering with certain of its drainage

§ 670-420. Rules for use of, and injury to, highways; penalty

(a) The secretary is empowered to make reasonable rules and regulations governing the use of all State highways, and, by the placement of official traffic control devices, or curbs, medians or other physical barriers, may control the flow of traffic thereon.

(b) The secretary may issue permits for the opening of streets and driveways onto State highways and for the opening of the surface and occupancy of State highways on terms and conditions established in department regulations, and may delegate such authority to any municipality which agrees to issue permits in compliance with such regulations or local regulations approved by the secretary which shall contain standards which are in every particular at least as high as those contained in the department regulations. No person, municipality or municipality authority shall open a driveway onto a State highway or open the surface of or occupy a State highway without such a permit.

(c) A municipality which refuses within sixty (60) days to issue a permit requested by a person pursuant to the provisions of subsection (b) shall, within ten (10) days of receipt of a written request, provide that person with a written statement specifying the reasons for its refusal.

(d) Any person who is denied issuance of a permit under this section may appeal pursuant to the provisions of Title 2 of the Pennsylvania Consolidated Statutes (relating to administrative law and procedure), except that an appeal from the refusal by a municipality to issue a permit under subsection (c) shall be to the Commonwealth Court.

(e) Any person violating any rule or regulation promulgated under this section, or who shall, by any method or device, or in any manner, wilfully or maliciously destroy, injure, or damage any such highway in this Commonwealth, shall, upon summary conviction thereof, be sentenced to pay a fine of not less than one hundred dollars (\$100.00) for each offense, together with the costs of prosecution and all necessary restoration, which shall be recovered, as in similar cases, upon complaint of any person before a magistrate or justice of the peace, and the fine or fines so recovered shall be paid into the Motor License Fund.

As amended 1979, Dec. 13, P.L. 531, No. 117, § 1, effective in 60 days; 1982, March 7, P.L. 147, No. 47, § 1, imd. effective.

(d) The secretary shall have the power to promulgate such reasonable rules and regulations as he deems necessary to carry out the provisions of this section.

(e) Any person aggrieved by findings made or actions taken under clause (15) of subsection (a) or subsection (b) shall have the right to appeal to the Court. This appeal shall be the sole and exclusive judicial remedy available to contest any such findings or actions.

As amended 1963, Aug. 14, P.L. 918, § 3; 1970, May 6, P.L. 356, No. 120, § 13; 1970, Dec. 3, P.L. 834, No. 275, § 21, effective Jan. 19, 1971; 1972, May 9, P.L. 271, No. 65, § 1, imd. effective; 1973, June 27, P.L. 81, No. 35, § 1, imd. effective; 1974, March 13, P.L. 188, No. 34, § 1; 1974, March 13, P.L. 194, No. 37, § 1, imd. effective; 1978, Oct. 4, P.L. 972, No. 192, § 2, effective Feb. 1, 1979; 1979, Dec. 7, P.L. 478, No. 100, § 2, imd. effective. As affected 1980, Oct. 5, P.L. 693, No. 142, § 321, effective in 60 days. As amended 1982, Dec. 9, P.L. 1077, No. 251, § 1, effective in 60 days.

166 P.S. § 1951 et seq. (repealed; see, now, 55 P.S. § 600.101 et seq.).

266 P.S. § 1901 et seq. (repealed).

Functions Transferred

Sections 9(b), 10(b), 14 and 15 of Act 1978, June 20, P.L. 477, No. 70, effective Jan. 1, 1979, transferred to the Department of Aging all of the functions, powers and duties of the Department of Transportation relating to the aged.

Suspended in Part

Subsection (e) of this section is suspended by Pa.R.A.P., Rule 5101(c), 42 Pa.C.S.A., insofar as it relates to practice or procedure in (including the finality of the decision of or the right of appeal from or to) the Supreme Court, Superior Court or the Commonwealth Court, or to practice or procedure in a trial court or government unit when an appeal has been or is being taken to, or review has been or is being sought in, one of such appellate courts. See, now, Pa.R.A.P., Rules 108(a)(2) and 1512, 42 Pa.C.S.A.

For effective date of the act of 1963, see note under § 62 of this title.

1974 Amendments: Act No. 34, in subdivision (13) of subsection (a), extended scope of recommended construction programs from six to twelve years, and Act No. 37 added subsections (c) and (d).

1978 Amendment: Added subsection (e).

1979 Amendment: In first paragraph of clause (15) of subsec. (a), inserted "Department of Agriculture, the" preceding "Department of Environmental Resources", and inserted "agricultural" preceding "conservation, sanitary, recreation and social considerations".

Section 321 of Act 1980, Oct. 5, P.L. 693, No. 142, provides in part:

"The time for appeal under [subsec. (e) of this section] shall run from the publication of the findings required in [subsec. (b) of this section]."

1982 Amendment: In subsec. (c), substituted "department" for "secretary" in introductory paragraph, and substantially rewrote clause (1), which prior thereto read:

"The lessee shall be a public agency, but such public agency may sublease to another public agency or, if there be no such agency desiring to sublease, then to one or more private entities: Provided, That such private entities shall make payments in lieu of taxes to the political subdivi-

sions in which such leased property is located in an amount equal to the annual taxes that would normally be due on such property, if taxable: And provided, further, That the secretary may lease directly to a private entity during the interim period between property acquisition and construction."

Library References

P.L.E. Highways § 22.

Notes of Decisions

Eminent domain 4
Environmental preservation 3
Federal aid 5
Jurisdiction 2
Sovereign immunity 6
Taxation, lessees 7
Validity ½

½. Validity

In view of fact that lessees of real property acquired by the Commonwealth for state highways enjoy all benefits provided by the political subdivision wherein the property is located including police and fire protection, hospital accessibility and academic facilities and because, absent this

UTAH

- Legislation

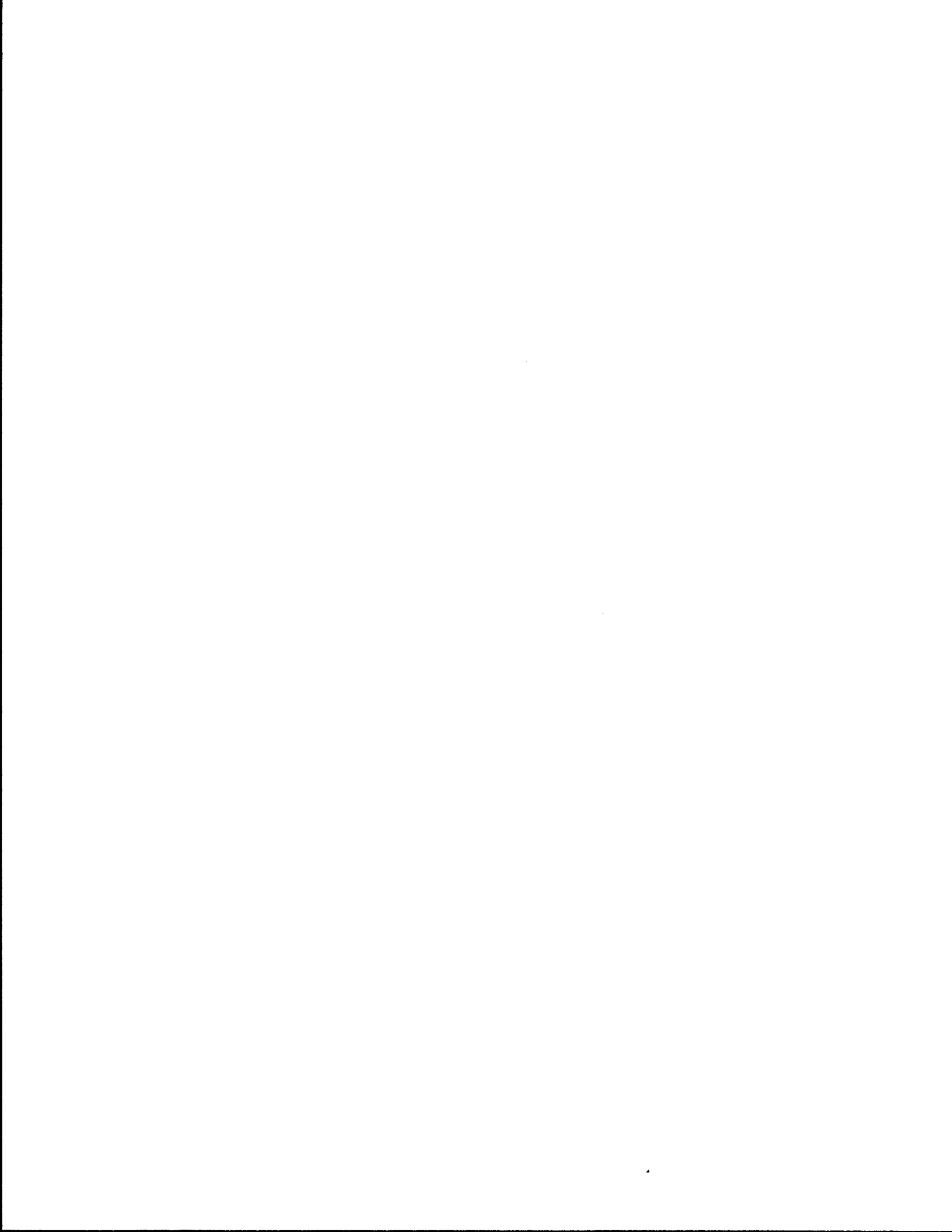

7-12-137. Dump grounds, junk or salvage yards adjacent to highways - Regulation authorized - Definitions.

7-12-137.1. Junkyard Control Act - Short title.

7-12-137.2. Junkyard Control Act - Purpose.

7-12-137.3. Junkyard control Act - Definitions.

7-12-137.4. Junkyard Control Act - License required.

7-12-137.5. Junkyard Control Act - Issuance of licenses - Fees - Duration - Renewal - Disposition of proceeds.

7-12-137.6. Junkyard Control Act - Conditions for screening of junkyard within 1,000 feet of highway.

7-12-137.7. Junkyard Control Act - Screening of existing junkyards.

7-12-137.8. Junkyard Control Act - Rules and regulations for screening - Authority of commission.

7-12-137.9. Junkyard Control Act - Junkyards not adaptable to screening - Authority of commission to acquire land - Compensation.

7-12-137.10. Junkyard Control Act - Junkyard operated in violation of act is public nuisance - Abatement - Correction notice.

7-12-137.11. Junkyard Control Act - Enforcement authority - Agreements with United States.

7-12-137.12. Junkyard Control Act - Present ordinances or regulations saved.

7-12-137.13. Junkyard Control Act - Violations - Misdemeanor.

7-12-138. Obstructing traffic on sidewalks or highways prohibited.

7-12-138.5. Gates on B system county highways.

7-12-139. Driving animals over highways - Liability for damages.

7-12-140. Limited highways - Penalty for driving animals over.

7-12-141. Escaping water, other obstructions - Injuring or obstructing highway - Penalty for violations.

7-12-142. Injury to trees on highways - Penalty for violations.

7-12-143. Violations of regulations as to use - Injury to signs, warnings or barriers - Penalty for damage to signs - Penalty for resulting injury to persons or property.

7-12-144. Liability for damage to highways, highway equipment or road signs.

7-12-145. Restrictions on use because of climatic conditions.

7-12-146. Loads on vehicles - Confining, securing and fastening load required.

7-12-147. Liability for damages to highway or structure from illegal operation or violation of maximum weight law.

7-12-148. Size, weight and load limitations for vehicles - Alteration by local authorities - Exceptions - Rules for movement of farm machinery.

7-12-149. Limitations as to size, dimensions and extensions of vehicle.

7-12-150. Towing requirements and limitations of vehicles.

7-12-151. Maximum gross weight limitation for vehicles - Exemptions - Overweight permit authorized - Formula for weight limitations.

7-12-152. Adoption of size or weight limitations prescribed by the Federal Highway Laws.

7-12-153. Weighing vehicles - Summary powers of peace officers - Penalty for violations.

7-12-154. Special permits for vehicles of excessive weight or size - Applications - Restrictions - Fees - Special weight formula - Issuance of instructions - "Special Mobile Equipment" defined.

7-12-155. Special transportation permits for vehicles of unusual physical nature - Insurance requirements - Fees - Penalty for violations.

7-12-156. Highway patrol to adopt regulations to carry out laws relating to size, weight and load.

7-12-157. Compliance with federal size and/or weight standards to qualify for federal aid.

27-12-133. Excavations, structures or objects prohibited within right-of-way except in accordance with regulations - Penalty for violation.

Except as otherwise provided in Section 54-4-15, Utah Code Annotated, 1953, no right-of-way of any state highway, county road or city street shall be dug up or excavated and no approach road, driveway, pole, pipeline, conduit, sewer, ditch, culvert, billboard, advertising sign, or any other structure or object of any kind or character shall be placed, constructed, or maintained within any such right-of-way except as permitted by, and in accordance with, the regulations of the highway authorities having jurisdiction over such right-of-way.

Any person who violates the provisions of this section is guilty of a misdemeanor. 1963

27-12-134. Authorities may regulate, require permit and security for excavation or construction - Limitation on authority.

Except as otherwise provided in section 54-4-15, Utah Code Annotated, 1953, the highway authorities of the state, counties, cities, and towns are authorized to adopt regulations, and may require a permit containing reasonable terms and conditions, for the crossing, digging-up, or the placement, construction, and maintenance of approach roads, driveways, structures, poles, pipelines, conduits, sewers, ditches, culverts, facilities, or any other structures or objects of any kind or character on the public highway rights-of-way under their respective jurisdiction. Said highway authorities may require a surety bond or other reasonable security which may be forfeited in the event the regulations or the conditions of a permit are breached.

The authority granted by this section shall not be exercised so as to deny reasonable ingress and egress to property adjoining a public highway except where said highway authorities have acquired such right of ingress and egress by gift, agreement, purchase, eminent domain, or otherwise or where no right of ingress or egress exists between the right-of-way and the adjoining property. 1963

27-12-135. Installations constructed in violation of regulations - Rights of highway authorities to remove or require removal.

If any person, firm, or corporation places, constructs, or maintains any approach road, driveway, pole, pipeline, conduit, sewer, ditch, culvert, billboard, advertising sign, or any other structure or object of any kind or character within the right-of-way of any state highway or county road, or city street without complying with the regulations of the highway authorities having jurisdiction over such right-of-way, said highway authorities may:

(1) Remove such installation from the right-of-way or require such person, firm, or corporation to remove the same; or,

(2) Give written notice to such person, firm, or corporation to remove such installation from the right-of-way. Such notice may be served either by personal service or by mailing the notice to the person, firm, or corporation by registered mail and posting a copy thereof on such installation for a period of 10 days. If such installation is not removed within 10 days after the notice is complete, said highway authorities may remove the same at the expense of the person, firm, or corporation and recover costs and expenses, and also the sum of \$10 for each day the same remained within the right-of-way after notice was completed, in an action for that



VERMONT

- Legislation



Posting signs provided by the agency informing the traveler of the restriction shall be conspicuously placed at each end of the highway or portion of the highway. The secretary shall be responsible for furnishing notice of any restricted use of state highways.

(b) A person who violates these rules shall be guilty of a traffic offense under 23 V.S.A. chapter 23, for which he or she shall be fined not more than \$100.00, and shall be liable to the state or town in which the damage is done for all damages to the highway to be recovered in an action of tort on this statute.—Added 1985, No. 269 (Adj. Sess.), § 1.

Prior law. 19 V.S.A. §§ 1552, 1553.

Cross references. Restricted use of covered bridges, see §§ 313-315 of this title.

§ 1111. Permitted use of the right-of-way

(a) **Permits.** Permits must be obtained by anyone or any corporation wishing to use as described in this section any part of the highway right-of-way on either the state or town system. Notwithstanding any other statutory requirement, a permit shall be required for any use of any highway right-of-way, consistent with the provisions of this section. The authority for issuing permits given to the board, the secretary and the attorney general shall also apply to the legislative bodies of towns.

(b) **Driveway entrances, highway grades; drainage.** It shall be unlawful to develop, construct, regrade or resurface any driveway, entrance, or approach, or build a fence or building, or deposit material of any kind within, or to in any way affect the grade of a highway right-of-way, or obstruct a ditch, culvert or drainage course that drains a highway, or fill or grade the land adjacent to a highway so as to divert the flow of water onto the highway right-of-way, without a written permit from the agency or the selectmen of a town, as the case may be. The agency or selectmen, within their respective jurisdictions, may make such rules to carry out the provisions of this section as will adequately protect and promote the safety of the traveling public, but shall in no case deny reasonable entrance and exit to or from property abutting the highways, except on limited access highways, using safety as the test for reasonableness.

(c) **Installing pipes and wires in highway.** It shall be unlawful to dig up or excavate a trench in a public highway for the purpose of installing pipes or wires without a written permit from the agency in the case of state highways and the selectmen for town highways. The permit shall include any conditions imposed by the issuing

party. All inspection of excavation and backfilling shall be done under the supervision of an agent of either the town or state as the case may be. Failure of any person, corporation or municipality to perform the work or to restore the highways in a satisfactory and timely manner to the agency or the town may result in either the agency or the town completing the work at the expense of the permit holder; provided however, the agency or town shall give timely notice to the permit holder of any defects, and the permit holder upon receipt of notice, shall have a reasonable time in which to repair the defects. The agency or the selectmen may recover reasonable expenses incurred in this manner in an action of tort on this statute in the name of the state or town with costs.

These provisions shall not apply to cities and shall not prevent a person, corporation, or municipality from excavating to make emergency repairs to a break in a pipe or a short in a wire, but in all cases all work shall be completed to the satisfaction of the agency or the town. Notice shall be given to the appropriate persons as expeditiously as possible after discovery of the problem.

(d) **Use by private sewer companies.** The board may issue a permit allowing the use of highway rights-of-way by private sewer companies if, following notice and hearing, the board certifies that the requested use will serve the needs of the public. In issuing the permit, the board may attach conditions as are required, including but not limited to the following:

(1) the installation of sewer lines shall conform with plans and specifications approved by the agency and shall be relocated at no cost to the state whenever the right-of-way is needed for highway purposes;

(2) the agency shall be reimbursed by the permit applicant for the actual costs of the review, inspection and engineering services provided by the agency for these installations.

(e) **Project inspectors; highway access plan.** The agency may assign an inspector to the project during construction at the applicant's expense. Any application to the agency for a drive or access permit by reason of any development subject to the provisions of this section shall include a proposed highway access plan for the entire tract of land. The agency shall impose reasonable conditions to reduce the number of accesses that will be required for the tract of land. These conditions may include a required setback of any construction or improvements from the highway to permit the construction of frontage road or roads, acceleration and deceleration

lanes, and/or other areas for off-highway control and management of vehicles, and may require reimbursement for any costs to the state for the installation of traffic control devices or road improvements reasonably required because of the development and may permit integration of the access and on-site traffic control facilities and connection of frontage roads between contiguous tracts of land as development is occurring or may occur along the highway.

(f) **Revoking access; frontage road.** The board may, as development occurs on land abutting the highway, provide as a condition of any permit for the elimination of access previously permitted and require the construction of a common frontage road.

(g) **Permit suspension.** In addition to any other enforcement powers that may be provided for by law the secretary or his or her designated representative, on behalf of the agency or the board of selectmen on behalf of a town, may suspend any permit under this section until compliance is obtained.

(h) **Restraining prohibited acts.** Whenever the secretary believes that any person is in violation of the provisions of this chapter he or she may also bring an action in the name of the agency in a court of competent jurisdiction against the person to collect civil penalties as provided for in subsection (j) of this section and to restrain by temporary or permanent injunction the continuation or repetition of the violation. The selectmen have the same authority for town highways. The court may issue temporary or permanent injunctions without bond, and any other relief as may be necessary and appropriate for abatement of any violation.

(i) **Assurance of discontinuance.** The secretary or the selectmen may accept an assurance of discontinuance of any violation of the terms of this chapter including when applicable schedules of abatement for a violation. Any assurance of discontinuance shall be in writing, and shall be filed with the attorney general, the court having jurisdiction over the subject matter and the town clerk of the town in which the violation occurred for recording in the land records. The attorney general, within ten days of receipt of the assurance, if he or she objects to the terms, may petition the board for a hearing of the violation in the manner prescribed by law. The board shall hold a hearing on the petition within 30 days of its receipt and shall issue an appropriate order within 15 days thereafter. Evidence of violation of an assurance shall be prima facie proof of the violation as cited in the assurance. Prior to institution of any action or proceeding under this subsection, the secretary whenever he or she believes any person to be or to have been in violation may issue a

notice of violation setting forth the nature of the violation, the corrective action necessary to abate the violation, and notice of intention to institute an action or proceeding against the person responsible for the violation. In this event, the secretary shall within 30 days provide the person with notice, an opportunity to be heard and an opportunity to settle the matter before instituting an action or proceeding as provided for in this subsection.

(j) **Civil penalty.** Any person who violates the provisions of this chapter or the terms of an order issued by a court under this chapter shall forfeit and pay to the state a civil penalty of not less than \$100.00 and not more than \$10,000.00 for each violation; provided however, where violation of an order is of a continuing nature, each day during which the violation continues after the date fixed by the court for the correction or termination of the violation shall constitute an additional separate and distinct offense except during the time an appeal from the order may be taken or is pending. For the purposes of this subsection the court issuing the injunction on petition of the secretary shall retain jurisdiction for purposes of awarding the civil penalty.—Added 1985, No. 269 (Adj. Sess.), § 1.

Prior law. 19 V.S.A. §§ 43, 1524–1526.

Chapter 15. Federal Aid

SECTION

- 1501. Acceptance of federal aid.
- 1502. Cooperation with federal government.
- 1503. Designation of highways; approval of contracts.
- 1504. Cooperation by municipalities.
- 1505. Federal bridges; construction.
- 1506. Maintenance; payment.
- 1507. Moneys received.
- 1508. Matching funds.
- 1509. Construction of federal aid highways.
- 1510. Local authorization.
- 1511. Town approval of projects on the state highway system.

§ 1501. Acceptance of federal aid

The state of Vermont assents to, approves and pledges its good faith to meet the terms of an act of Congress approved July 11, 1916, entitled "An act to provide that the United States shall aid the states in the construction of rural post roads, and for other purposes." and amendments to the act including flight strips, and the agency and the transportation board are authorized to take such action as may be necessary to secure to the state the aid and benefits provided by the act. Whenever the transportation board determines that funds otherwise authorized to be appropriated to the state under the fed-

VIRGINIA

- Rules

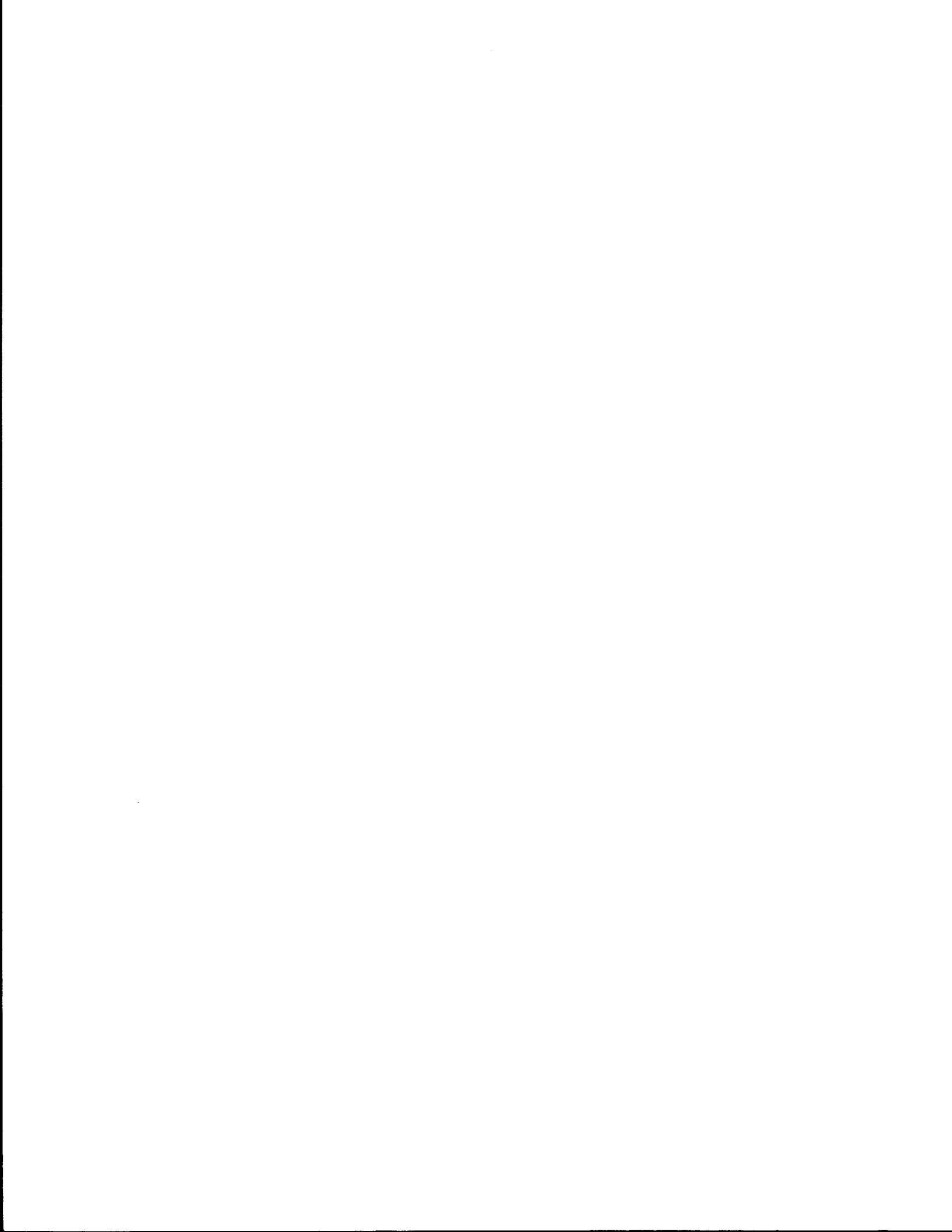

VIRGINIA

1.020

GENERAL RULES AND REGULATIONS OF THE STATE HIGHWAY AND TRANSPORTATION COMMISSION

These general Rules and Regulations are the rules and regulations adopted pursuant to the authority of Section 33.1-12 (3) of the Code of Virginia (1950), as amended, and in accordance with Section 9-6.14.1 et seq. of said Code.

SECTION 1. Definitions: When used in these Rules and Regulations,

- (a) COMMISSION means the State Highway and Transportation Commission, Commonwealth of Virginia.
- (b) COMMISSIONER means the Chairman of the State Highway and Transportation Commission for the Commonwealth of Virginia.
- (c) COMMONWEALTH means the Commonwealth of Virginia.
- (d) DEPARTMENT means the Department of Highways and Transportation, Commonwealth of Virginia.
- (e) RIGHT OF WAY means that property within the entire area of every way or place of whatever nature within the system of State Highways under the ownership, control, or jurisdiction of the Commission or Department, which is open or which is to be opened within the future for the use of the public for purposes of travel in the Commonwealth. The area set out above includes not only the traveled portion but the entire area within and without the traveled portion, from boundary line to boundary line, and also all parking and recreation areas which are under the ownership, control or jurisdiction of the Commission or Department.

(f) SYSTEM OF STATE HIGHWAYS means all highways and roads under the ownership, control, or jurisdiction of the Commission including but not limited to the Primary, Secondary, and Interstate Systems.

SECTION 2. No work of any nature shall be performed on any real property under the ownership, control, or jurisdiction of the Commission, including but not limited to the right of way of any highway in the system of State Highways until written permission is first obtained from the Commissioner. Written permission, under this section, is granted by way of Permit except that the letting of a contract by and between the Department and any other party grants to that party automatically the permission spoken of in this section for the area under contract, unless otherwise stated in the contract. The Land Use Permit Manual shall set forth specific requirements for such permits.

SECTION 3. All Permits, except as hereinafter provided must be in writing and signed by the person duly authorized by the Commissioner. Except as hereinafter provided, application for all Permits shall be made through the Resident Engineer of the county where the work is to be performed.

SECTION 4. A Permit may be denied any applicant and all permits issued by the Commission or the Commissioner may be revoked whenever in the opinion of the Commissioner, safety, use, or maintenance of the highway so requires.

SECTION 5. No Land Use Permit shall be issued until the applicant has complied with the restrictions, specifications, and fee requirements set forth in the Land Use Permit Manual, where applicable, and pursuant to the Manual of 'Minimum Entrance Standards to State Highways', when applicable. The manuals referred to are those prepared and published by the Commission or Commissioner and kept on file in the Central, District, and Resident offices of the Department, changes to which must be adopted or ratified by the Commission.

SECTION 6. Applicants to whom Permits are issued shall at all times indemnify and save harmless the Commission, members of the Commission, the Commonwealth, and all Commonwealth employees, agents, and officers, from responsibility, damage, or liability arising from the exercise of the privileges granted in such Permit.

SECTION 7. Any structures placed upon or within the right of way pursuant to a permit issued by the Commission or Commissioner shall be relocated or removed whenever ordered by the Commissioner. Such relocation or removal shall be accomplished at no expense to the Commonwealth unless the Department agrees or has agreed otherwise.

SECTION 8. No person, firm or corporation shall use or occupy the right of way of any highway for any purpose except travel thereon except as may be authorized by the Commission or Commissioner either in the Land Use Permit Manual or as provided by law.

SECTION 9. No person, firm or corporation shall stand or park a vehicle of any description on any bridge forming a part of the system of State Highways unless authorized by the Commissioner. No person shall fish or seine from any such bridge except when facilities are provided for such purposes as set out in Section 33.1-207 of the Code of Virginia (1950), as amended. No person, firm or corporation shall use any such bridge as a wharf from which to load or unload any vehicle nor as a place of deposit for any property, nor for any other purpose except for crossing. Nor shall the master or owner of any vessel make it fast to or lay it alongside such bridge. Provided, however, this section shall not apply to highway maintenance vehicles or vessels.

SECTION 10. No person, firm or corporation shall without the consent of the Commissioner remove, injure, destroy, break, deface, or in any way tamper with any property, real or personal, which is growing or has been placed on the right of way of any highway within the system of State Highways by or with the consent of the Commission or Commissioner.

SECTION 11. Mailboxes and newspaper boxes may be placed on the right of way of any system of State Highways without a permit, but shall be so placed as not to, in the opinion of the Commissioner, interfere with the safety, maintenance and use of the highway. Such opinion is to be found in the Department's Land Use Permit Manual.

SECTION 12. No person, firm or corporation may cause water from any source to flow upon the right of way of any highway within the system of State Highways nor shall any person, firm, or corporation cause any increase of the water at present lawfully on the right of way of any highway or concentrate the flow of water upon the right of way of any highway in the system of State Highways without the written consent of the Resident Engineer for the Department.

SECTION 13. No road, railroad, or tracks of any description shall be laid along, upon, or across any portion of a highway in the system of State Highways without the written consent of the Commissioner. The Land Use Permit Manual shall set forth specific requirements for said written consent.

SECTION 14. All areas maintained by the Department for parking, picnics, or recreational purposes shall be considered as part of the system of State Highways for the purpose of these General Rules and Regulations of the Commission. The rules and/or regulations governing each area will be duly posted in that area. No person, firm, or corporation shall violate any of these rules and/or regulations nor shall they deface, injure, knock down, destroy, or remove any such signs regularly posted.

SECTION 15. The Commission under Section 33.1-12 (3) Code of Virginia (1950) as amended reserves the power to regulate entrances from adjacent property upon the right of way of any highway within the system of State Highways. No entrance of any nature shall be made, built, or constructed upon the right of way of any highway within the system of State Highways until the location has been determined in the opinion of the appropriate officer of the Department to be acceptable from a public safety standpoint, and further, until approval has been granted by the Department. The design and construction of such entrances as approved by the Commissioner pursuant to Section 33.1-198 Code of Virginia (1950) as amended must comply with the "Manual of Minimum Entrance Standards" to State Highways and the Land Use Permit Manual where the same are applicable.

SECTION 16. If any object or objects are placed on, above, or under the right of way of any highway within the system of State Highways in violation of the preceding sections and the owner, after ten days' notice, refuses to improve the object or objects, the Commissioner may cause same to be removed at owner's expense.

This shall not be interpreted to prevent the Commissioner from immediately removing any object or objects which in his opinion must be removed for public safety, use, or maintenance of any highway within the system of State Highways. Removal in this instance shall also be at owner's expense.

SECTION 17. No airport runways, heliports, etc., either private or commercial shall be placed adjacent to highway right of way in such a manner as to impede the safe flow of vehicular traffic. Runways, etc., shall be placed a proper distance to allow a minimum glide slope for aircraft of 3° approaching said runway or at a height over the roadway of 30 feet, whichever is the greatest. All airport and/or heliports proposed in the vicinity of highway rights of way shall take these minimum road clearances into consideration when planning the location of the end of their runways.

SECTION 18. Any person, firm, or corporation violating any of the preceding section shall be civilly liable to the Commonwealth for any and all expenses and/or damages incurred by the Department and shall be guilty of a misdemeanor and, upon conviction, shall be punished as provided for in Section 33.1-19 of the Code of Virginia (1950), as amended.



WASHINGTON

- Legislation
- Rules
- Examples

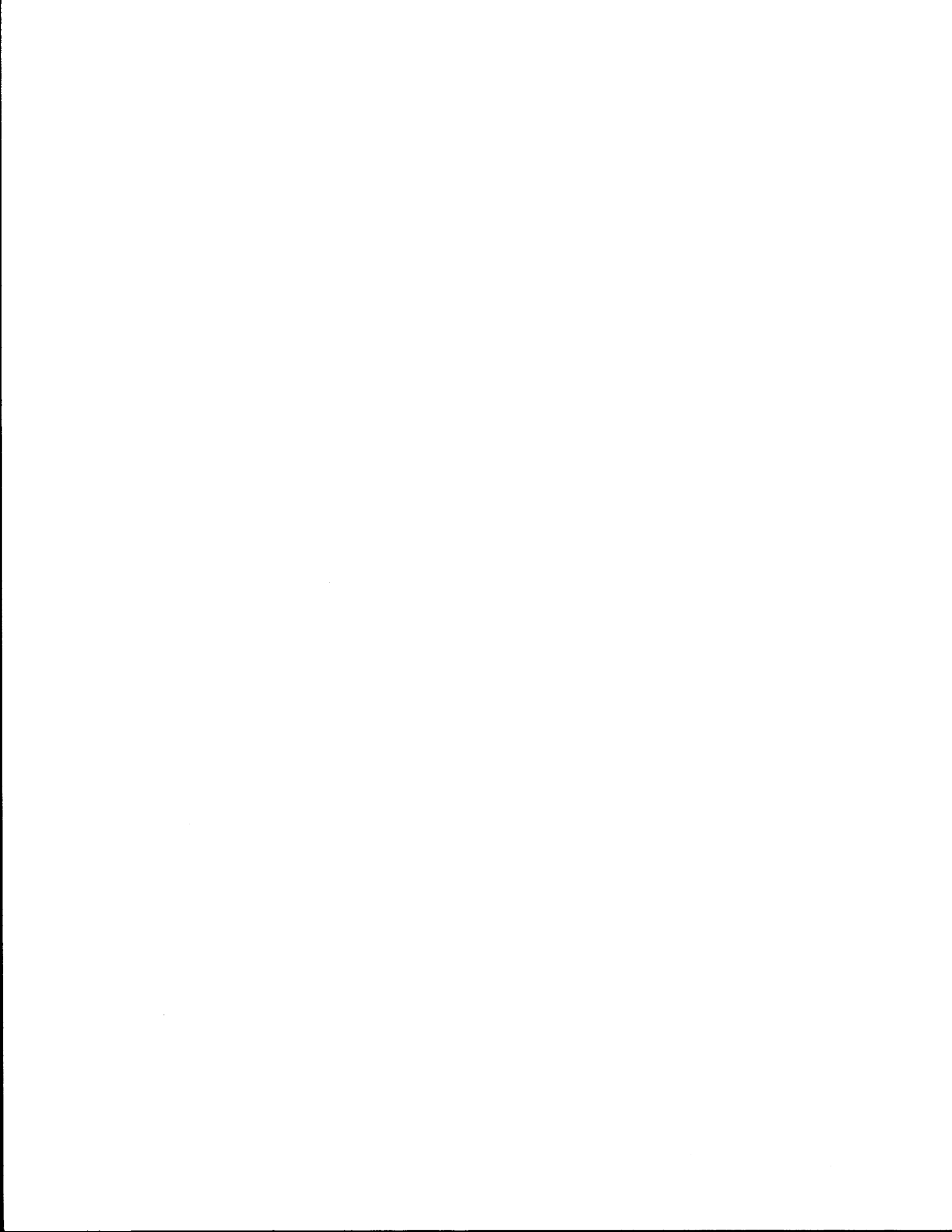

separate action and of entry of judgment therein at the amounts provided for in civil actions, judgment shall be entered restoring the property to the claimant without any confirmation of title as to any other claimant thereto, relieving the sheriff from necessity of selling the property and making return thereon, and continuing the effect of the bond for a period of six years thereafter for the benefit of such adverse claimants to the property, if any, as may thereafter make claim to the property. If the claimant does not make good such claim of title to or right to possession of the property, judgment shall be rendered against the claimant and the sureties of the claimant for the value of the property as finally shown by the affidavit as above provided for, together with such fees for filing the affidavit and bond as a separate action and for entry of judgment therein and other costs and disbursements as taxed in any civil action including the statutory attorney fee as part thereof, for all of which execution may accordingly issue, and relieving the sheriff from the necessity of selling the property or making return thereon. [1984 c 7 § 181; 1961 c 13 § 47.32.100. Prior: 1937 c 53 § 77; RRS § 6400-77; prior: 1925 ex.s. c 131 § 11; RRS § 6837-11.]

Severability—1984 c 7: See note following RCW 47.01.141.

47.32.110 Merchandising structures—Permit—Removal. It is unlawful for any person to build, erect, establish, operate, maintain, or conduct along and upon the right of way of any state highway any platform, box, stand, or any other temporary or permanent device or structure used or to be used for the purpose of receiving, vending, or delivering any milk, milk cans, vegetables, fruits, merchandise, produce, or any other thing or commodity of any nature unless a permit therefor has first been obtained from the department. The department shall in each instance determine where any platform, box, stand, or any other temporary or permanent device or structure shall be permitted. Upon the existence of any such device or structure without a permit having been first obtained, it shall be considered an obstruction unlawfully upon the right of way of the state highway, and the department may proceed to effect its removal. [1984 c 7 § 182; 1961 c 13 § 47.32.110. Prior: 1937 c 53 § 78; RRS § 6400-78; 1927 c 309 § 48; RRS § 6362-48; 1923 c 181 § 10; RRS § 6358-1.]

Severability—1984 c 7: See note following RCW 47.01.141.

47.32.120 Business places along highway. It is unlawful for any person to erect a structure or establishment or maintain a business, the nature of which requires the use by patrons or customers of property adjoining the structure or establishment unless the structure or establishment is located at a distance from the right of way of any state highway so that none of the right of way thereof is required for the use of the patrons or customers of the establishment. Any such structure erected or business maintained that makes use of or tends to invite patrons to use the right of way or any portion thereof of any state highway by occupying it while a patron is a public nuisance, and the department

may fence the right of way of the state highway to prevent such unauthorized use thereof. [1984 c 7 § 183; 1961 c 13 § 47.32.120. Prior: 1937 c 53 § 79; RRS § 6400-79.]

Severability—1984 c 7: See note following RCW 47.01.141.

47.32.130 Dangerous objects and structures as nuisances—Logs—Abatement—Removal. (1) Whenever there exists upon the right of way of any state highway or off the right of way thereof in sufficiently close proximity thereto, any structure, device, or natural or artificial thing that threatens or endangers the state highway or portion thereof, or that tends to endanger persons traveling thereon, or obstructs or tends to obstruct or constitutes a hazard to vehicles or persons traveling thereon, the structure, device, or natural or artificial thing is declared to be a public nuisance, and the department is empowered to take such action as may be necessary to effect its abatement. Any such structure, device, or natural or artificial thing considered by the department to be immediately or eminently dangerous to travel upon a state highway may be forthwith removed, and the removal in no event constitutes a breach of the peace or trespass.

(2) Logs dumped on any state highway roadway or in any state highway drainage ditch due to equipment failure or for any other reason shall be removed immediately. Logs remaining within the state highway right of way for a period of thirty days shall be confiscated and removed or disposed of as directed by the department. [1984 c 7 § 184; 1961 c 13 § 47.32.130. Prior: 1947 c 206 § 3; 1937 c 53 § 80; Rem. Supp. 1947 § 6400-80.]

Severability—1984 c 7: See note following RCW 47.01.141.

Obstructing highway, public nuisance: RCW 9.66.010.

Placing dangerous substances or devices on highway: RCW 9.66.050, 46.61.645, 70.93.060.

47.32.140 Railroad crossings, obstructions—Hearing. Each railroad company shall keep its right of way clear of all brush and timber in the vicinity of a railroad grade crossing with a state highway for a distance of one hundred feet from the crossing in such manner as to permit a person upon the highway to obtain an unobstructed view in both directions of an approaching train. The department shall cause brush and timber to be cleared from the right of way of a state highway in the proximity of a railroad grade crossing for a distance of one hundred feet from the crossing in such manner as to permit a person upon the highway to obtain an unobstructed view in both directions of an approaching train. It is unlawful to erect or maintain a sign, signboard, or billboard, except official highway signs and traffic devices and railroad warning or operating signs, outside the corporate limits of any city or town within a distance of one hundred feet from the point of intersection of the highway and railroad grade crossing unless, after thirty days notice to the Washington utilities and transportation commission and the railroad operating the crossing, the department determines that it does not obscure the sight distance of a person operating a vehicle or train approaching the grade crossing.

WASHINGTON

DEPARTMENT OF TRANSPORTATION

DIRECTIVE

D 55-76 (MT)

Effective Date:

August 23, 1979

Maintenance and Operations
Engineer

USE OF SAFETY REST AREAS
FOR DISPENSING REFRESHMENTS

I. INTRODUCTION

A. PURPOSE:

To provide guidance for authorizing the dispensing of refreshments by non-profit organizations in safety rest areas.

B. SUPERSESSION:

D 25-58 (HA), "Use of Safety Rest Areas for Dispensing Refreshments", dated April 10, 1972.

C. REFERENCES:

1. Federal Highway Administration Circular Memorandum 36-01, "The Use of Safety Rest Areas for Dispensing Refreshments", dated December 17, 1969.
2. Washington Highway Laws, 1970, 47.32.110, "Merchandising Structures - Permit - Removal".

II. RULES

- A. It is unlawful for anyone to establish, maintain or conduct an operation utilizing any type of structure along and upon the right of way of any state highway without a permit having been obtained from the Department of Transportation.
- B. Responsible non-profit organizations who offer their services may be authorized to serve refreshments in safety rest areas in accordance with the rules prescribed on the application form (appendix).
- C. Permits are issued on a first come first served basis. Only one organization may operate in the rest area at a time.
- D. The Department provides appropriate signing on the highway.

III. PROCEDURES

<u>RESPONSIBILITY</u>	<u>ACTION</u>
	A. ON HIGHWAY SIGNING
District Administrator	<ol style="list-style-type: none"> 1. On highway signs indicate service, e.g., "Free Coffee", placed in two (2) lines with eight inch (8"), series "C" white letters on a blue background, thirty-six inches (36") wide and thirty inches (30") high. 2. Attach the temporary sign to the rest area advance sign in a manner that will allow for optimum sign legibility. 3. Charge cost of signing to routine maintenance.
	B. PROCESSING REQUESTS
Maintenance and Operations Engineer	<ol style="list-style-type: none"> 1. Upon receipt of a request in Headquarters, coordinate with and forward request to appropriate District Administrator for action.
District Administrator	<ol style="list-style-type: none"> 2. Upon receipt of a request in the District, obtain completed application in quadruplicate from requesting organization. 3. Approve or disapprove request. 4. Furnish applicant the original and forward one (1) copy of approved application to Headquarters Records Control, one (1) copy to the State Maintenance and Operations Engineer and retain one (1) copy. 5. Notify appropriate State Patrol Office of operation. 6. Provide highway signing on dates of operation. 7. Arrange for routine maintenance patrol on rest area during and following the organization's installation.

IV. APPENDIX

DOT Form 540-002, "Application to Dispense Refreshments."

APPLICATION TO
DISPENSE REFRESHMENTS

WASHINGTON STATE
DEPARTMENT OF TRANSPORTATION

D 55-76 (MT)

APPENDIX

We, _____,

a non-profit organization, request permission to dispense free refreshments at:

Rest Area Location: _____ on the
_____ lane.
(Southbound, Northbound, etc.)

Date(s) of use: _____

Hours: From _____ to _____

We understand that we must comply with the following rules:

1. The activity is to be conducted for improving the safety of highway travel, not as an advertisement of any organization or activity.
2. The services offered, and refreshments, are to be free of charge to the motorists.
3. Solicitation of contributions, donations, etc., is forbidden.
4. Handing out or posting printed literature is prohibited. Verbal promotion is acceptable; however, any type of solicitation is strictly forbidden, and is cause for denying the violating group use of the rest area.
5. The activity is to be carried out solely within the safety areas, free from any ramp or surface used for the movement of vehicles.
6. The serving organization may have a sign on their booth showing the service and the organization. For example, "Free Coffee, Compliments of _____".
7. All dogs must be on a leash.
8. Fires are not permitted.
9. Trees, shrubs, and flowers are not to be picked, mutilated or removed.
10. Clean-up of the rest area must be conducted by the participating group or organization.

Representative _____
Print Signature

Address _____

Telephone _____

APPROVED
DISAPPROVED

District Administrator

WASHINGTON

AGREEMENT

THIS AGREEMENT, made and entered into this 15th day of October, 1984, between the WASHINGTON STATE DEPARTMENT OF TRANSPORTATION, hereinafter referred to as "WSDOT," and the WASHINGTON STATE DEPARTMENT OF SERVICES FOR THE BLIND, hereinafter referred to as "DEPARTMENT";

WHEREAS, WSDOT in the interest of the traveling public has constructed or plans to construct safety rest areas as part of the State Highway System; and

WHEREAS, the FEDERAL HIGHWAY ADMINISTRATION has modified rules, allowing vending machines in safety rest areas, in accordance with Section III of the Surface Transportation Act of 1982; and

WHEREAS, the DEPARTMENT desires to join WSDOT in the development, installation, operation and maintenance of vending machines in rest areas at specified locations, and

WHEREAS, it is desirable to describe the division of responsibility of WSDOT and the DEPARTMENT in the development, installation, operation and maintenance of said facilities;

NOW, THEREFORE, in recognition of the responsibilities, interests and limitations set forth above, WSDOT and the DEPARTMENT mutually agree as follows:

I. GENERAL

WSDOT hereby gives and grants to the DEPARTMENT the right and privilege to operate, or cause to be operated, vending machines with WSDOT safety rest areas for the purpose of selling food and beverages. Establishment of stands or shops for the purpose of selling the articles or products and any form of personal salesmanship is prohibited. Vending of motor vehicle replacement parts or petroleum products is prohibited.

This Agreement does not in any way encumber WSDOT's right to issue permits to nonprofit organizations for dispensing free food or beverages for improving the safety of highway travel.

WSDOT reserves the right to limit initial vending activities to the following individual rest area sites for a one-year period to determine the impact of such activities on the operation of the safety rest areas: SR 5, Maytown, vicinity MP 93; SR 90, Winchester (westbound), vicinity MP 161; SR 5, Smokey Point (northbound), vicinity MP 207. Other safety rest areas may be added by mutual agreement.

The DEPARTMENT will enter into contracts with vendors for placement and operation of vending machines in safety rest areas.

WSDOT reserves the right to approve the commodities sold through vending machines. The vendors shall submit a list of commodities for approval by WSDOT. Prior to vending any commodity, the vendor must have that commodity included on the list approved by WSDOT.

No contract between the DEPARTMENT and its vendors shall create any obligation or liability to WSDOT with regard to this Agreement.

Nothing in this Agreement with respect to the proposed improvement or the plans and specifications thereof shall be construed or deemed to be a ratification or an adoption by WSDOT of said improvement, plans, or specifications as WSDOT's own.

II. DEPARTMENT AND VENDOR RESPONSIBILITIES AND DUTIES

- A. Shall provide utilities and shelters for vending machines.
- B. Shall pay WSDOT \$25 per month per vending machine as reimbursement for site costs and utilities (whether or not the machine is connected to electricity, water or sewer). Payment shall be made within 30 days of receipt of billing.
- C. Be responsible for the costs of wiring, plumbing and placement and/or removal of vending machines, including any additional utility capacity beyond that existing or proposed at the site.
- D. Be responsible for any damage to the vending machines or property of or in custody of WSDOT.

- E. Shall comply with all city, county, state and federal laws, and the purchase of all licenses and permits and payment of all taxes that are applicable to performance, at no cost to WSDOT.
- F. Shall ensure that their contractors are responsible to provide a shelter to accommodate the vending machines. The structure must be architecturally compatible with the existing or proposed WSDOT structures within the safety rest areas. No advertising, except for symbol signs for food and drink, will be affixed to the vending machine structure.

The structure shall incorporate litter barrels conforming to the Model Litter Control and Recycling Act requirements of such total capacity to accommodate all litter or refuse created by the sale of all commodities within the vending machines.

Shall submit a site plan and shelter drawings for approval by WSDOT prior to any work within the safety rest areas. The site plan must show all existing site conditions (utilities, buildings, walkways drainage features, roadways, etc.) which occur within 150 feet of the proposed vending machine shelter.

- G. Shall not modify any facility (including the vending machine shelter) within the safety rest area without prior approval of WSDOT.
- H. Shall drive their motor vehicles on the roadways and/or pavements designated for motor vehicles.
- I. Shall post emergency and service telephone numbers on each vending machine and provide a system agreeable to WSDOT by which the traveling public may be reimbursed for losses due to vending machine malfunction or failure to deliver goods.
- J. In the event this Agreement is terminated, shall remove all vending machines and related facilities and restore the safety rest area site to its pre-vending machine condition within 60 days of notice by WSDOT.
- K. Shall be fully responsible for maintenance and operation of all vending machines.

- L. Shall erect and maintain a sign attached to the vending machine shelter in a conspicuous location approved by WSDOT, designating the DEPARTMENT'S involvement and receipt of revenue associated with the vending machine. The sign shall be of a size and configuration so as to allow reading from a distance of five feet by a normally sighted person.
- M. Shall provide to WSDOT every six months, a report of gross sales data, by item, showing quantities and income, for each safety rest area.

III. WSDOT RESPONSIBILITIES AND DUTIES

- A. Shall be responsible for giving reasonable access to existing facilities within the safety rest area for hook-up and use by the DEPARTMENT and/or its Vendors, providing such use would not overload or in any way damage WSDOT's use of the utility. Approval by WSDOT will be on a site-by-site basis after review and/or modification of the plan and/or drawings submitted by the Department and/or its Vendors to WSDOT.
- B. Shall bill the DEPARTMENT for vending machine space and utility service on a quarterly basis.
- C. May approve plans submitted by the DEPARTMENT for temporary facilities (to remain not more than one year) at no more than four (4) individual safety rest area sites.
- D. Shall approve or reject any or all submittals by the DEPARTMENT within 45 days of receipt by WSDOT.
- E. Shall collect and dispose of all litter and/or debris accumulated in the litter barrels located at the vending machine shelter.
- F. Shall allow access to utilities according to the approved plan or drawings, at no additional costs beyond the \$25 per month per vending machine as shown in Section II, Item B.
- G. Shall provide litter pickup and structure maintenance at the vending machine shelter.

- H. Shall notify in advance the DEPARTMENT or its Vendor in the event the safety rest area is scheduled to be closed. Notice of emergency closures will be on an ASAP basis. Notice of loss of utilities will be handled on the same basis as closure of the safety rest area.
- I. Shall relocate the vending shelter in the event future safety rest area work so dictates. Costs to relocate shall be borne by the WSDOT.

IV. NONDISCRIMINATION AND AFFIRMATIVE ACTION

The DEPARTMENT and/or its Vendors agree not to discriminate against any client, employee or applicant for employment or service because of race, creed, color, national origin, sex, marital status, age or the presence of any sensory, mental or physical handicap with regard to, but not limited to, the following: employment, upgrading; demotion or transfer; recruitment or recruitment advertising; lay-offs or terminations; rate of pay or other forms of compensation; selection for training; rendition of services.

It is further understood that any Vendor for the DEPARTMENT who is in violation of this clause (or an applicable affirmative action program) will be subject to review by WSDOT. Unless a satisfactory showing is made that discriminatory practices or noncompliance with applicable affirmative action programs have terminated and that a recurrence of such acts is unlikely, WSDOT, with just cause, will terminate this Agreement.

V. INSURANCE

The DEPARTMENT shall cause to be furnished, by its Vendors commercial insurance protection, adequate in scope and amounts to protect WSDOT against loss which may foreseeably arise from acts or omission of the Vendors, which amounts in no event shall be less than:

\$1,000,000 comprehensive single limit including bodily injury, personal injury, property damage, and including products liability and fire legal liability.

Certification of coverage giving assurance of 30 days prior to notice of cancellation, material change or intention not to renew coverage is required in order to ensure coverage remaining valid.

WSDOT and the DEPARTMENT shall be named additionally insured to protect the interest of WSDOT and the DEPARTMENT against litigation arising from acts or omissions of the Vendors -- this will include a statement of severability of interest.

The DEPARTMENT will cause to be furnished a copy of the Certificate of Insurance to WSDOT. The Vendors will be responsible for Workmans Compensation Insurance covering all employees who are employed from time to time for any purpose connected with the vending machine operation.

VI. LIABILITY

Neither the DEPARTMENT nor WSDOT will be liable for failure to perform their respective obligations under this Agreement when such failure is caused by fire, explosion, water, Act of God or inevitable accident, civil disorder or disturbances, strikes, vandalism, riots, sabotage, or other events beyond their control.

WSDOT will not be liable for any loss of product or damage to equipment resulting from loss of utility service, vandalism, riots, sabotage, fire, explosion, water, act of God, or inevitable accident, civil disorder or disturbances, strikes, or other events beyond their control to the vending machines.

VII. DURATION AND RENEWAL

Failure to perform by the DEPARTMENT or WSDOT shall be just cause for termination of this Agreement by either party following a 60-day notice of intent to terminate to the other party.

Termination by the DEPARTMENT will be ineffective until all provisions of Section II, Item J, have been complied with.

WSDOT may terminate this Agreement in whole, or from time to time in part, whenever:

- (a) If in the sole opinion of WSDOT, the continuation of the project would not produce beneficial results commensurate with the further expenditure of funds.
- (b) WSDOT determines that such termination is in its best interests.

This Agreement will be reviewed annually by the DEPARTMENT and WSDOT and, if mutually agreeable, will be renewed for another one-year period. Modification, if mutually agreeable, does not jeopardize the force of this Agreement.

This Agreement shall continue in effect until thirty (30) days following receipt of written notice of intent to terminate by either party.

VIII. INCORPORATION IN OTHER CONTRACTS

Terms and conditions of the Agreement are hereby agreed upon and will be incorporated in its entirety in any contract entered into by the DEPARTMENT for vending machines in WSDOT safety rest areas.

DEPARTMENT OF SERVICES
FOR THE BLIND

Shirley Smith
Signature

Assistant Director
Title

August 22, 1984
Date

Approved as to Form Only

Ernest M. Furnia
Assistant Attorney General

WASHINGTON STATE DEPARTMENT
OF TRANSPORTATION

W Ernst
Signature

State Maintenance Engineer
Title

October 15, 1984
Date

APPROVED AS TO FORM

Ronald Wise
AAG FOR DOT

7:Agmt8

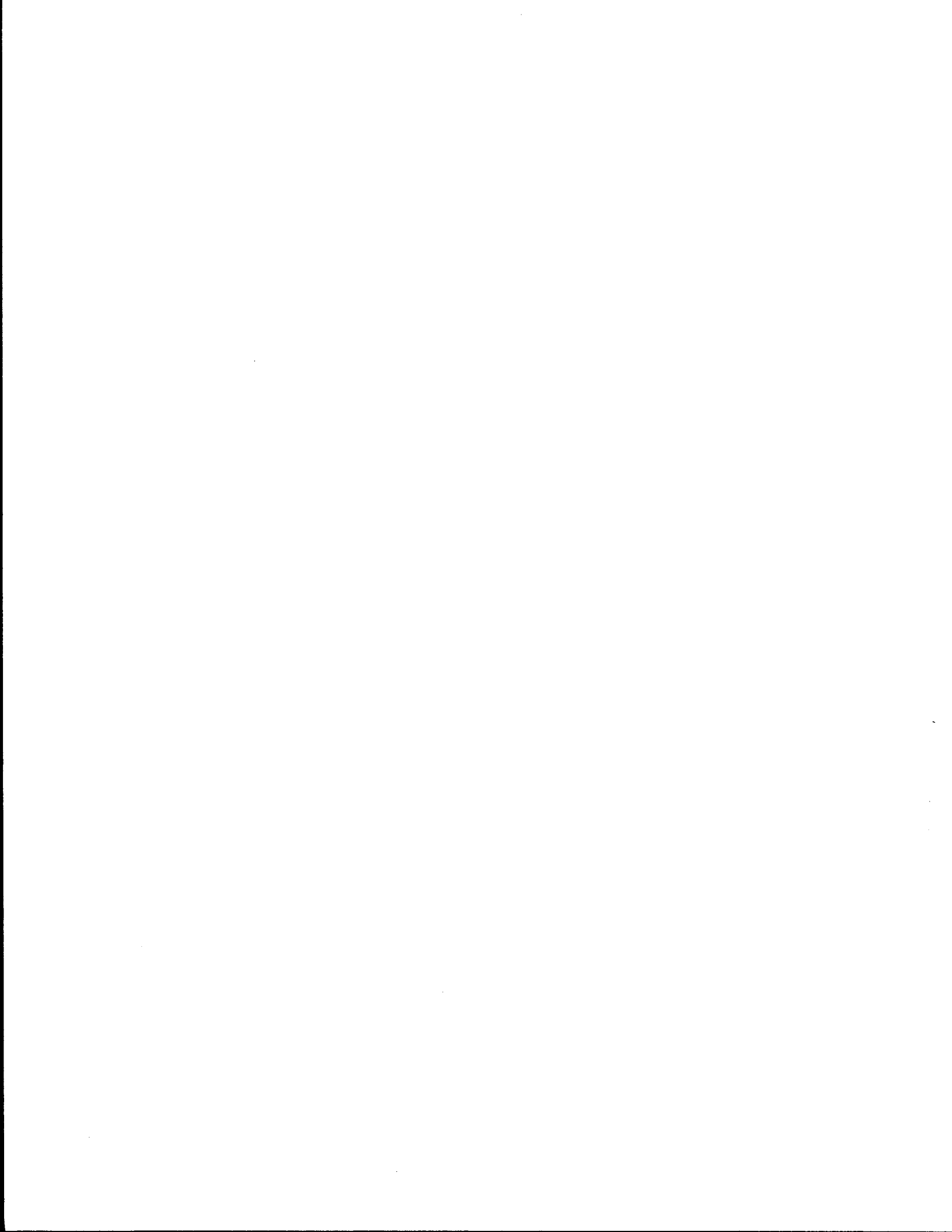

WEST VIRGINIA

- Legislation



WEST VIRGINIA

ARTICLE 16, CHAPTER 17.

Section 1. OBSTRUCTIONS DEFINED; ABATEMENT BY INJUNCTION—Obstructions, within the meaning of this chapter, shall include trees which have been cut or have fallen either on adjacent land or within the bounds of a public road in such manner as to interfere with travel thereon; limbs of trees which have fallen within a public road or branches of trees overhanging the same so as to interfere with travel thereon; landslides; carcasses of dead animals, lumber, wood or logs piled within the bounds of a public road; machines, vehicles, conveyances and implements abandoned or habitually placed within the bounds of a public road; fences, buildings, or other obstructions within the bounds of a public road; ashes, cinders, earth, stone or other material placed on a public road or in any ditch or waterway along such road; water diverted from its regular course or channel so as to injure or endanger a public road; any road connected without lawful authority with a public road in such manner as to obstruct or impede travel thereon or the flow of water in the gutters or drains along such road; pipe lines, telegraph, telephone, trolley or other poles and wires connected therewith, constructed or erected on a public road in such a way as to interfere with the uses thereof; or any other thing which will prevent the easy, safe and convenient use of such public road for public travel. Such obstructions shall be considered within the bounds of any state or county-district road whenever any part thereof shall occupy any part of the right of way provided by law or acquired for road purposes, not including the additional land acquired for slopes, cuts or fills.

Such obstructions so placed and left within the limits of such road are hereby declared to be public nuisances, and, in addition to other remedies provided in this chapter, the county court or the state road commission, as the case may be, may apply to the circuit court, or other court of competent jurisdiction of the county in which they may be, for an injunction to abate such nuisance.

Section 2. DUTY OF LANDOWNER, OCCUPANT AND PUBLIC UTILITY TO REMOVE OBSTRUCTIONS AND FILL EXCAVATIONS—It shall be the duty of the owner or occupant of land situated along any state or county-district road to remove all obstructions within the bounds of the road which have been placed there by himself or with his consent.

It shall be the duty of all telephone, telegraph, electric railway or other electrical companies to remove and reset telephone, telegraph, trolley and other poles and wire connected therewith when the same constitute obstructions to the use of a state or county-district road by the traveling public.

It shall be the duty of all pipe line companies whose lines have been laid across or along any state or county-district road in this State for the purpose of transporting natural gas, oils, water, or any other substance, to fill up all excavations made thereby and to make the road in all respects as good as it was before the excavation was made, and to keep the same in like good condition, and, when any such line has been laid along any such road on the right of way thereof and constitutes an obstruction to the traveling public, to relay or remove the same.

Section 5. LIABILITY FOR FAILURE TO REMOVE OBSTRUCTIONS—If any obstruction, such as mentioned in section one of this article, be not removed by the person who, by himself or agent, caused the same, within ten days after written notice so to do, given on behalf of the state road commission or county court, by the engineer or person in charge of such road, then the person causing the obstruction shall be liable to such commission or county court, as the case may be, in a sum of not less than one nor more than five dollars for each day such obstruction remains unremoved after the service of such notice.

ARTICLE 19, CHAPTER 17.

Section 13. MISCELLANEOUS OFFENCES; PENALTY—If any person, by himself or agent, without lawful authority so to do, shall destroy, injure or deface any of the guide boards, milestones or posts, parapets, walks, culverts, bridges, masonry of any kind, gates belonging to or forming a part of a public road, or toll houses in connection with a bridge authorized by law to receive tolls thereon; or who shall wilfully break down or destroy any bench or log placed across a stream for the accommodation of travelers; or who shall injure any statue, monument, chair or other seat, or lamp post, constructed on or being in any way connected with a public road, space or park, or any railing or fencing erected for public use, or inclosing any such space or park, or any railing, posts or guards along a public road for the protection of travel thereon, or any walk or crossing for footpassengers; or who shall obstruct or injure any public road or ditch made for the draining thereof, or any of its sewers, curbing, gutters, drains or culverts; or who shall place or leave in a public road any ashes, cinders, earth, stone or other material, obstructive to the travel and use of such road; or who shall place or leave in any public road any vehicle or conveyance of any kind, or any kind of implement, so as to interfere with travel thereon; or who shall divert any stream of water from its regular course or channel so as to injure or endanger a public road; or who shall connect any road with a public road in such manner as to impede the flow of water in the ditches or gutters thereof or obstruct or impede travel thereon; or who shall throw or place, or cause to be thrown or placed, on any public road, any tacks, nails, scrap metal, glass, crockery, wire or other substance injurious to the feet of persons or animals, or the tires of vehicles; or who shall remove, injure or destroy any material or equipment used or intended for use in the construction, reconstruction, repair or maintenance of any public road; or who shall kill a tree and leave it standing within fifty feet of any public road; shall be guilty of a misdemeanor, and upon conviction thereof, shall be fined not less than ten nor more than fifty dollars, and shall moreover be liable to the state road commission, county court or individual, as the case may be, for any injury caused by such act.

The term "public road," as used in this section, shall include any street, alley or public highway.

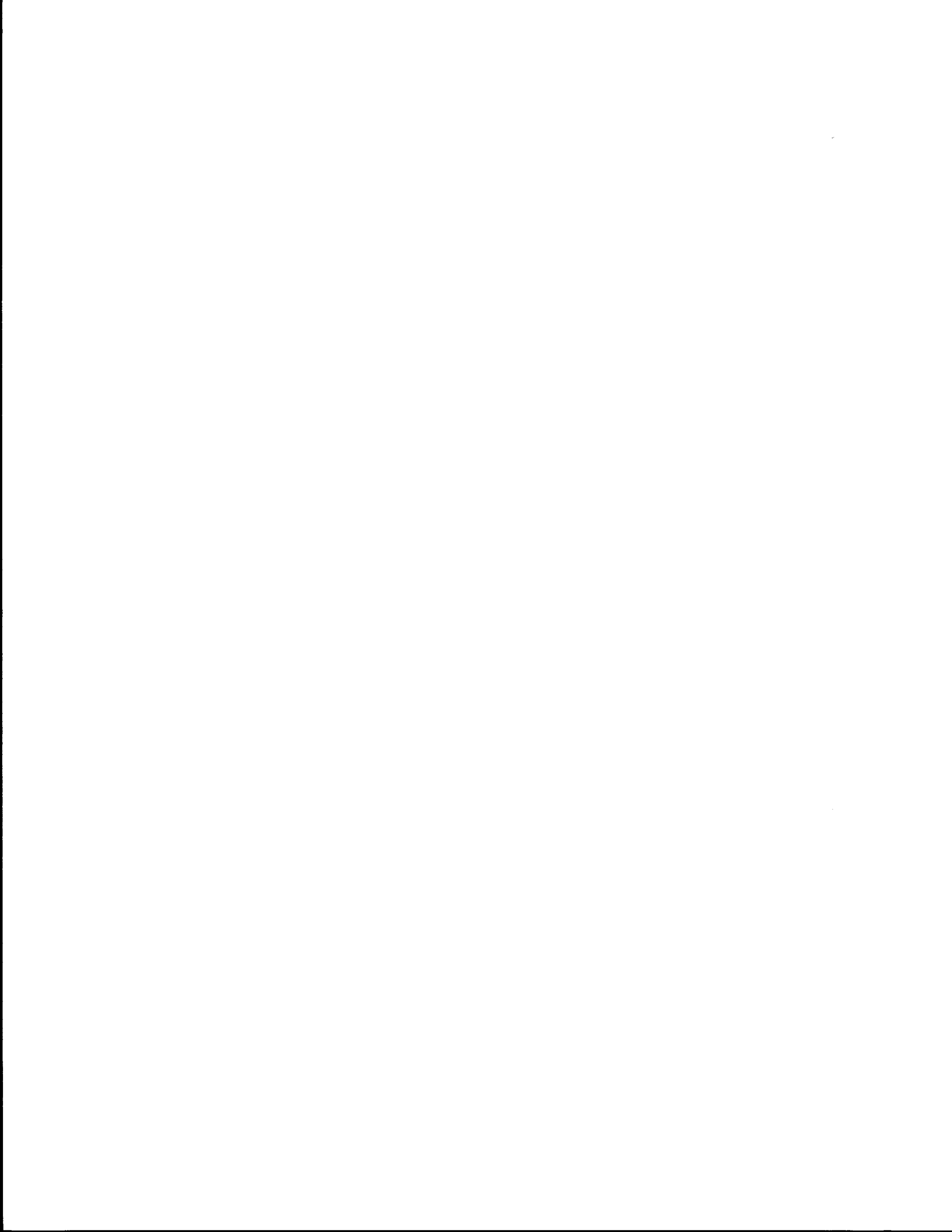

WYOMING

- Legislation
- Rules
- Examples

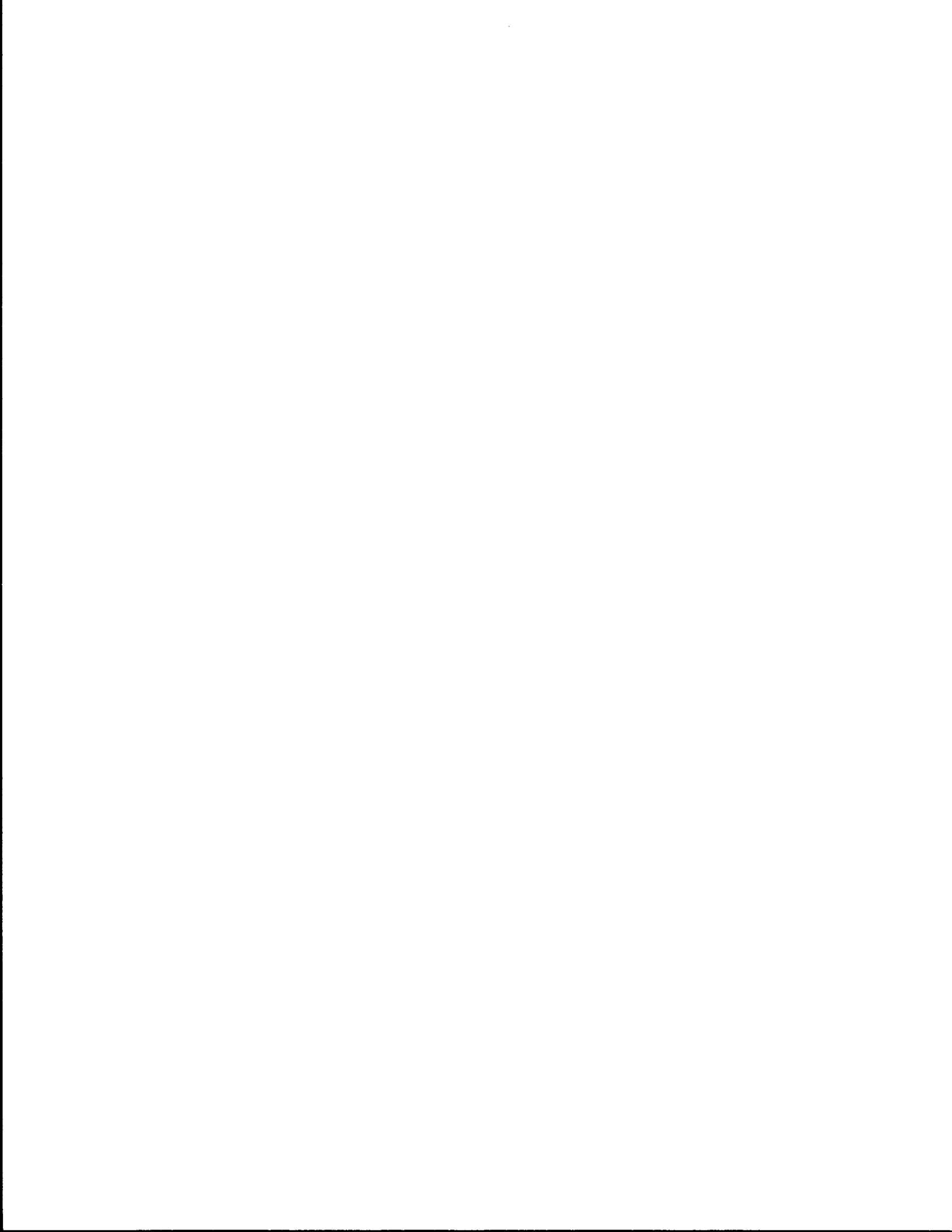

WYOMING

§ 1-26-811

§ 1-26-813

(ii) Take, cent lands su and repair its thereof; and

right-of-way over adja- orporation to construct ts location or relocation

(iii) Acquire a right to conduct water by aqueducts and to make appropriate drains.

(b) Any land taken, appropriated and held otherwise than by the consent of the owner shall not exceed two hundred (200) feet in width unless greater width is necessary for excavations, embankments, depositing waste earth or for construction of other appurtenant facilities necessary for the operation of the railroad. (Laws 1981, ch. 174, § 1.)

§ 1-26-811. Crossing public highways; privileges and duties.

(a) A railroad company may raise or lower any county road or other public highway for the purpose of having its railroad pass over or under the road or highway. Repair or reconstruction of roads or highways shall be expeditiously completed.

(b) While engaged in raising or lowering any county road or other public highway or in making any other alteration which may obstruct the public way, a railroad company shall provide and maintain suitable temporary ways to enable travelers to avoid or pass obstructions. (Laws 1981, ch. 174, § 1.)

§ 1-26-812. Crossings for owner of land on both sides of track.

When any person owns land on both sides of any railroad, the company owning the railroad shall construct and maintain reasonably adequate means of crossing the railroad. (Laws 1981, ch. 174, § 1.)

§ 1-26-813. Right-of-way along public ways granted; permission necessary for new lines.

Corporations authorized to do business in this state for the purpose of constructing, maintaining and operating a public utility may set their fixtures and facilities along, across or under any of the public roads, streets and waters of this state in such manner as not to inconvenience the public in their use. Any public utility desiring to install their facilities in any city shall first attempt to

obtain consent from the city council. A person or firm must first obtain permission from the state highway commission or the board of county commissioners in the county where the construction is contemplated before entering upon any state highway or county road for the purpose of commencing the construction. (Laws 1981, ch. 174, § 1.)

§ 1-26-814. Right of eminent domain; petroleum or other pipeline companies; purposes.

Whenever any utility or any petroleum or other pipeline company, authorized to do business in this state, has not acquired by gift or purchase any land, real estate or claim required for the construction, maintenance and operation of their facilities and appurtenances or which may be affected by any operation connected with the construction or maintenance of the same, the utility or company has the right of eminent domain and may condemn the easement required by the utility or company. (Laws 1981, ch. 174, § 1.)

§ 1-26-815. Same; ways of necessity for authorized businesses; purposes; extent.

(a) Any person, association, company or corporation authorized to do business in this state may appropriate by condemnation a way of necessity over, across or on so much of the lands or real property of others as necessary for the location, construction, maintenance and use of reservoirs, drains, flumes, ditches including return flow and wastewater ditches, underground water pipelines, pumping stations and other necessary appurtenances, canals, electric power transmission lines, railroad trackage, sidings, spur tracks, tramways, roads or mine truck haul roads required in the course of their business for agricultural, mining, exploration drilling and production of oil and gas, milling, electric power transmission and distribution, domestic, municipal or sanitary purposes, or for the transportation of coal from any coal mine or railroad line or for the transportation of oil and gas from any well.

(b) The right of condemnation may be exercised for the purpose of:

- (i) Acquiring, enlarging or relocating ways of necessity;
- and

welfare of the citizens of Wyoming, provided that no present and [or] future operation of any existing municipal garbage disposal system or any extension of or changes therein, which involves substantially daily burning, and no present and [or] future operation of any now existing municipal sewage disposal system or facilities or any extension of or changes therein, shall be considered as within the scope of the foregoing provisions of this act [§§ 35-10-101, 35-10-102] or as a violation thereof but further provided that the foregoing exception concerning any existing municipal garbage disposal system, whether or not such involves substantially daily burning, shall not be applicable to or except from the scope of this act, any such system which has been commenced since prior construction in the close vicinity thereof, of occupied residential buildings or occupied business properties, ten or more in number. (Laws 1945, ch. 131, § 1; C.S. 1945, § 9-705; W.S. 1957, § 35-462.)

§ 35-10-102. Penalty for violation of section 35-10-101.

Any person violating the provisions of this act [§ 35-10-101] shall be guilty of a misdemeanor and upon conviction thereof shall be punished by a fine of not less than fifty dollars (\$50.00) nor more than two hundred dollars (\$200.00) or shall be imprisoned in the county jail not to exceed six (6) months, or shall be punishable by both such fine and imprisonment. (Laws 1945, ch. 131, § 2; C.S. 1945, § 9-706; W.S. 1957, § 35-463.)

ARTICLE 4. MISCELLANEOUS OFFENSES

§ 35-10-401. Obstructing or injuring highways, streets, bridges or navigable streams generally; offensive manufactures or businesses; pollution of waters.

(a) If any person, company or corporation shall obstruct or injure or cause or procure to be obstructed or injured, any public road or highway, or common street or alley of any town or village, or any public bridge or causeway, or public river or stream, declared navigable by law, or shall continue such obstruction, so as to render the same inconvenient or dangerous to pass, or shall erect or establish any offensive trade, or manufacture or business, or continue the same after it has been erected or established, or shall in anywise pollute or obstruct any watercourse, lake, pond, marsh or common sewer, or continue such obstruction or pollution, so as to render the same unwholesome or offensive to the county, city, town or neighborhood thereabouts; every person, company or corporation so offending, shall upon conviction thereof, be fined not exceeding one hundred dollars (\$100.00); and every such nuisance may, by order of the district court before whom the conviction may take place, be removed and abated by the sheriff of the proper county.

(b) Whoever, in any manner, wrongfully obstructs any public highway, or injures any bridge, culvert, or embankment, or injures any material used in

§ 35-10-401

PUBLIC HEALTH AND SAFETY

§ 35-10-401

the construction of any such road, shall be fined in any sum not more than one hundred dollars (\$100.00), to which may be added imprisonment in the county jail not more than three (3) months. (C.L. 1876, ch. 35, § 120; Laws 1886, ch. 73, § 1; R.S. 1887, § 1003; Laws 1890, ch. 73, § 67; R.S. 1899, §§ 5020, 5107; C.S. 1910, §§ 5864, 5958; C.S. 1920, §§ 7153, 7247; R.S. 1931, §§ 32-361, 32-702; C.S. 1945, §§ 9-711, 9-712; W.S. 1957, § 35-479.)

WYOMING STATE HIGHWAY DEPARTMENT

OPERATING POLICY

DATE OF ISSUE: November 25, 1985

POLICY NUMBER: 19-3

AUTHORITY: Superintendent and
Chief Engineer

SUBJECT: RIGHT-OF-WAY ENCROACHMENTS

PURPOSE: To outline the Department policy on encroachments on rights-of-way, and to set forth guidelines and procedures for permitting warranted encroachments. For the purposes of this policy, an encroachment is a facility within highway rights-of-way (including above and below ground) that is owned and maintained by a party other than the Department.

The responsibility for compliance with these guidelines within each district lies with the district engineer, and legal authority necessary to fulfill such responsibility within his district is delegated to each district engineer.

The responsibility for maintenance of any encroachment permitted within the right-of-way lies with the owner and his successors, and shall not become the responsibility of the Department. A license is granted in conformance with Wyoming Statute 1-26-813, and constitutes permission according to statute. Granting of this license does not imply any title interest in the land being vested by the Wyoming Highway Department, and the licensee assumes all responsibility for title clearance by virtue of occupying highway right-of-way.

I. INTERSTATE ENCROACHMENTS

Parallel encroachments on interstate highways, for purposes other than serving a highway facility, are generally not permitted. Under extenuating circumstances application may be made to the Department and forwarded to FHWA for approval. Such encroachment, if allowed, requires an official relocation of the no access line and requires any access for maintenance to the facility to be from outside the no access line.

II. PUBLIC UTILITY ENCROACHMENT

State statute gives any public utility, such as power companies, telephone companies, cities and towns the right to place utility facilities within the right-of-way. Before doing so they must obtain Department permission. For purposes of licensing, cable television company facilities are considered a public utility.

Permission shall be obtained by the owner of any proposed facility by submitting Form E-54 to the appropriate district office in whose area the facility is to be installed. Form E-54 shall be executed by the owner and not by any of his agents, i.e., contractor or consulting engineering firm. The E-54 shall provide that the facility will be constructed in a manner conforming with applicable federal, state, and/or local laws, codes, and ordinances. Specific procedures for implementing such permission shall be delegated to the Construction and Maintenance branch.

Utility facilities requiring periodic maintenance and/or inspection by work crews shall be placed outside of the right-of-way and shall have a separate or designated access point.

III. MUNICIPALITIES AND SEWER DISTRICTS

Form E-54 should be used to license municipal owned facilities within the city limits and for crossings or parallel runs of less than 500 feet outside of the city limits. In cases where a municipality wishes to construct a major utility project within Department right-of-way outside the city limits and over 500 feet in length, such as a large high pressure transmission line from a water well field, or water storage facility, an E-54 should not be used. The information shall be turned over to the utilities section with all pertinent engineering data in order that a specific agreement can be drawn up. The district engineer must approve the agreement prior to its being sent to the utility company for signature.

IV. RAILROADS

The district engineer shall not issue Form E-54 to railroads for crossings, but shall submit all data to the utilities section, so that a specific agreement can be written. Requests from industrial users for spur tracks must be submitted in conjunction with the railroad company rather than the industrial user alone.

All agreements shall be approved by the district engineer involved prior to being sent to the railroad for final approval.

V. PRIVATE UTILITY LINES

It is Department policy to allow private parties to cross our roadway with utility lines when they are installed to Department specifications. These include water, gas, power, and telephone lines, and petroleum product transmission lines. Parallel utility runs by private parties are prohibited.

In the case of transmission lines owned by companies with condemnation authority, such as coal slurry pipelines or petroleum transmission lines, the advantages of granting permission to encroach will be investigated. If it appears to be in the public interest to grant permission for encroachment, and does not otherwise interfere with the use of the right-of-way for highway purposes, a special agreement shall be drawn up by the utilities section permitting the encroachment. This agreement should specify the rights of access to construct and maintain the facility, a detailed alignment and grade, specific construction procedure to be used around Department structures, and provisions for inspection if deemed necessary. Access to utility lines outside the right-of-way where no access is maintained shall not be allowed, and in no case shall utility maintenance be done from the highway right-of-way. Agreements shall be approved by the district engineer.

VI. LANDSCAPING LICENSE

It is the policy of the Department to allow the beautification of the right-of-way by the adjacent landowner or local municipality when it does not compromise the integrity and safety of the highway. Any firm or individual wishing to modify the right-of-way must submit Form A-26 to the district office in which the property is located.

Any landscaping is to be for aesthetic purposes only, and shall not be used for any business or residential purposes. The paving of any portion of the right-of-way for use by a business for parking or display of merchandise is strictly prohibited.

It is imperative that all drainages through a landscaped area be maintained. All shrubbery or trees planted within the right-of-way shall be at least 50 feet from the edge of the traveled way in rural areas and consistent with the surrounding property in urban areas. The setback for all shrubbery shall meet all municipal codes and shall not restrict sight distances below the required minimum established by the traffic operations branch.

Any party allowed to landscape as provided in this section shall indemnify and hold harmless the State for all injury sustained and property damage caused by landscaping operations.

VII. SIGNS, AWNINGS, CANOPIES, MARQUEES

Within the central business district of a city or town as designated by the Department planning branch, the erection of awnings, canopies, marquees and on premise advertising signs may encroach into Departments' right-of-way under the following conditions:

- A. Under eight (8) feet from right-of-way line to back of curb.
 1. Signs, awnings, canopies, etc. must be supported totally from the face of the building or from supports outside the right-of-way.
 2. The farthest protrusion into the right-of-way is to be at least two (2) feet behind back of curb.
 3. The owner must agree not to erect any signs that obstructs or otherwise compromises the usefulness of any traffic control devices in the vicinity.
- B. From eight (8) feet to fourteen (14) feet from right-of-way line to the back of the curb.
 1. Awnings, canopies, etc., may be supported by supports within the right-of-way, provided both the supports and covering remain a minimum of two (2) feet behind back of curb.
 2. If traffic control devices supports need to be attached to any canopy or overhanging structure, the Department has the right to attach to or to project supports through, the overhang.
- C. Greater than fourteen (14) feet from right-of-way line to back of curb.
 1. Awnings, canopies etc. may be supported by supports within the right-of-way provided both the supports and covering remains a minimum of six (6) feet behind back of curb.
- D. In all cases, the street must have a curb and gutter section.
- E. Where city ordinances are more restrictive, the city ordinances shall govern.
- F. The Department prepare an agreement with the city for encroachment in lieu of dealing with each business owner. The agreement shall contain the following provisions.

- 1) The City shall release the Department from any claims for injury or damages brought about as the result of private businesses utilizing Department right-of-way.
- 2) During times of highway reconstruction, the City shall assume the cost of removal if additional street width requires utilizing additional amounts of Department right-of-way.
- 3) The City shall be responsible for establishing standards for type of construction and maintenance thereof.
- 4) The City shall enforce the clearances as established in this policy unless they have more restrictive ordinances of their own.

If the above criteria are not met, the protrusion of signing, canopies, etc., into the right-of-way is prohibited.

None of the above encroachments shall be permitted if by reason of color, lighting, or placement in any other manner, such encroachment detracts from the effectiveness of official traffic control devices or if they constitute a traffic hazard.

VIII. SUBSTRUCTURES

Within a city commercial area, but not in a rural commercial area, presently existing substructures (i.e. foundations) may be considered permitted encroachments, provided that the farthest protrusion, above ground or underground, does not extend beyond the curbside of the sidewalk. Whenever a street is to be widened by reconstruction, underground protrusions shall be reduced to no more than five (5) feet into the right-of-way, or to a point at least two (2) feet behind the back of curb, whichever is less. No new encroachments will be allowed.

IX. ACCESS DRIVEWAYS

The policies on access driveways are covered in Operating Policy 21-1, Highway Access Control.

X. SEISMOGRAPHIC ACTIVITIES

Drilling, blasting or any type of longitudinal seismographic investigations will not be allowed within any right-of-way.

The laying of temporary cable across interstate, primary and secondary highways will be permitted under the following provisions:

- A. Written approval is obtained from the district engineer two weeks prior to using the right-of-way.
- B. The company signs Form M-23, Seismograph Cable Crossing License, in which they agree to:

- 1) release the Department from liability in the event of any accident or injury;
- 2) meet traffic control requirements of the Department;
- 3) an expiration date.

C. Cables are to be run through existing culverts if there is one in the area. If there is no existing culvert in the area, 1,000 feet in either direction, the cable may cross on the roadway surface if:

- 1) the cable is firmly secured;
- 2) the cable is removed daily; and
- 3) the cable is adequately signed and flagged.

D. There will be no work vehicles parked within the right-of-way.

E. Any violation to the above will result in a 90-day suspension in the use of right-of-way regardless of whether the company had previous permission. Each violation and subsequent suspension shall be reported to the state construction and maintenance engineer for compilation and distribution to the other districts. Any suspension shall be considered binding statewide, not just within the district in which the violation occurred.

XI. CONDUCTING BUSINESS FROM THE RIGHT-OF-WAY

Under no circumstances will any business or other commercial activity be transacted, nor permits issued for the transaction of any type of business or commercial activity on rights-of-way.

XII. REMOVAL

Department rights-of-way shall remain inviolate from encroachments without a permit issued by authority of the Department. Any use of the right-of-way which interferes with the construction and maintenance of the highway or safe use by the traveling public shall be considered encroachment.

Encroaching property causing an immediate hazard to the public may be removed immediately as covered by W.S. 35-10-401. Any encroaching property not causing immediate hazard, and where the owner cannot be determined after 48 hours, is deemed abandoned, and will be removed and stored at the direction of the district engineer. If subsequent ownership can be proven, the property will be released upon payment of removal cost and storage cost.

When 30 days have expired, the district engineer will contact the Department purchasing agent for the disposition of the property.

Judgment shall be exercised by the district engineer as to how he shall accomplish encroachment removal, and prevention of additional encroachments. As a guide, the following is suggested:

- A. Contact owner to attempt voluntary compliance.
- B. Letter, certified with return receipt, giving official notice of encroachment and setting time limit for removal.
- C. Contact law enforcement agencies, pursuant to W.S. 6-6-306.
- D. Sign criminal complaint, if necessary, pursuant to W.S. 6-6-303.
- E. Actual physical removal by Department personnel.

In the case of transient peddlers conducting business within the right-of-way, steps A, C, and D are recommended.

XIII. VIOLATIONS

Any persons in violation of this regulation are subject to prosecution pursuant to the provisions of W.S. 6-6-305. Trespassing upon highway rights-of-way in violation of the provisions of this regulation is hereby declared an unlawful activity.

- Ref.: W.S. 1-26-813
W.S. 6-6-301 thru 307
W.S. 35-10-401
W.S. 37-3-114
F.H.W.A. PPM 30-4.1

WYOMING STATE HIGHWAY DEPARTMENT

OPERATING POLICY

DATE OF ISSUE: November 14, 1984

POLICY NUMBER: 19-8

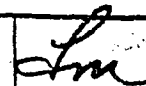
AUTHORITY: Superintendent and
Chief Engineer

SUBJECT: PLACEMENT OF UTILITIES ON BRIDGES

This policy establishes controls and operational procedures for the placement of utilities on bridges and other highway structures.

I. AUTHORIZATION

No utility company shall locate, relocate or otherwise place and maintain a utility on any bridge or other highway structure under the jurisdiction of the State Highway Commission of Wyoming without first obtaining approval through licensed permission issued by the Wyoming Highway Department.

II. UTILITIES GENERAL

Utility placements on bridges over railroads will require approval by the railroad company, as well as by the Wyoming Highway Department. The attachment of utilities to the bridge deck surface, to the top of curbs/sidewalks, or to traffic or pedestrian railing shall not be permitted. The welding of utility attachments to main steel girders or the direct attachment to main load-carrying girders shall not be permitted. Final installations will be subject to inspection by Department personnel.

III. VOLATILE MATERIALS

Utility lines that transport volatile (flammable, corrosive or explosive) materials shall not be located, relocated, or otherwise placed and maintained on any bridge or other highway structure unless they conform to the following requirements:

- A. The maximum line size shall be four inches inside diameter.
- B. The maximum line pressure shall be 60 psig and shall be verified in the presence of Department personnel.
- C. Each line shall be properly encased.
- D. Each line shall have a shutoff valve automatically activated by a sudden pressure drop, located within 300 feet of each end of the structure.

IV. PERMISSION**A. New Structures**

A survey of the existing utilities at the structure site will be completed by the District and forwarded to the headquarters office as part of the normal utility survey. The utilities branch will determine the requirements for relocation of the existing utilities and the requirements for possible new utilities (e.g., telephone lines). If a utility is to be attached to a new structure, the bridge branch shall be so notified by the utilities branch.

The bridge branch will obtain from the utility company, either through the utilities branch or the district, information pertinent to the utility attachment. With this information, the bridge branch will incorporate the utility attachment into the contract structure plans.

If it is determined by the utilities branch that the Wyoming Highway Department will not pay for the location or relocation of the utility, then the design work done by the Wyoming Highway Department to incorporate the utility attachment into the contract plans shall be billed to the utility company through an Authority for Rendering Special Service (see Operating Policy 24-3), which shall be completed prior to any design work. Under no circumstances will the utility company be allowed to design the utility attachment system or cause it to be designed.

B. Existing Structures

The utility company shall request permission for the utility placement through contact with the district engineer. The request shall be accompanied by detailed sketches showing the type, number, size, routing location and method of attachment of the utility, as well as any other information pertinent to the attachment. The district will forward this material to the bridge branch for review. The bridge branch will make a written reply to the district, indicating disapproval, approval as submitted, or approval contingent upon resubmittal of the request revised as indicated.

Following approval by the bridge branch, the district may issue a license granting permission to the utility company to attach the utility to the structure as shown on the approved request, said request to become a permanent attachment to the license. The district will forward one copy of the license, with attachments, to the bridge branch and one copy of same to the utilities branch.

WYOMING STATE HIGHWAY DEPARTMENT

OPERATING POLICY

DATE OF ISSUE: May 18, 1983

POLICY NUMBER: 21-1

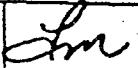
AUTHORITY: Superintendent and
Chief Engineer

SUBJECT: HIGHWAY ACCESS CONTROL

GENERAL: All highways under control of the Department are access controlled and no approaches may be constructed to any highways unless application is made by the landowner and approved by the Department under rules and regulations as adopted by the Commission.

On existing state highway systems there exists degrees of access control depending upon the classification and intent of the highway system. Access control varies from full control of access to limited control of access.

I. FUNCTIONAL CLASSIFIED HIGHWAY SYSTEMS

A. Rural Areas

Rural Principal Arterials - Consists of the interstate system and all non-interstate principal arterials.

Serves movements having trip length and travel density characteristics indicative of substantial statewide or interstate travel, and all cities of 50,000 or more and most cities over 25,000. High access control, with high mobility.

Rural Minor Arterials - Serves movements having characteristics of interstate and intercounty service. Serves county seats not otherwise served by principal arterials. Limited access. Spaced so that all incorporated places are within 30 miles of an arterial highway.

Rural Major Collectors - Link large towns, provide the most important intracounty travel corridors. Spaced to serve major traffic generators such as agriculture, mining, recreation and industry. A compromise between mobility and land access.

Rural Minor Collectors - Collects traffic from rural local roads, links developed areas with major collector and arterial system. Greater degree of access to land uses, with lower mobility.

Rural Locals - Land service roads with low speeds and traffic volumes. Provides access to individual properties and the higher mobility systems.

B. Urban Areas

Urban Principal Arterials - Serves the major centers of metropolitan activity, high volume traffic corridors and longest trips. Integrated to major rural connections. Access subordinated to mobility. Includes Interstate System.

Urban Minor Arterials - Interconnects and augments the principal arterial system and provides intercommunity continuity. Somewhat lower level of mobility with slightly greater access than principal arterials.

Urban Collectors - Provides both land access service and traffic circulation within residential neighborhoods. Collects local traffic and channels it to the arterial system.

Urban Locals - All streets not included in other systems. Primary access to individual urban properties, with low level mobility and poor service to through-traffic movement.

II. FULL CONTROL OF ACCESS

The only access points allowed are those designed and built at the time of initial construction. This is to protect the integrity of the highway so it may serve the traffic and function for which it was built. Common types of full access control locations are:

Interstate highways. (Access only at interchanges)

Cross roads abutting interchange ramps. (No approach closer than 150 feet in urban area; 300 feet in rural area to ramp termini).

Intersections of roadways.

Marginal or by-pass routes. (Access only with selected public roads or major traffic generators.)

III. LIMITED CONTROL OF ACCESS

Following are definitions of areas to be covered for limited access control to state highways:

- A. Urban - An area, either incorporated or unincorporated where it has been developed primarily for residential and/or business purposes. The speed limits will generally be 40 MPH or less, the street or highway will normally be curbed, and at least 50 percent of the frontage on one side of the highway within one half mile of the driveway location developed with residences and/or businesses.
- B. Fringe Urban - An area abutting the urban area that is developing into strip business and/or residential which by nature of this development will be annexed within the city or corporate limits within the next three to five years. This area should not generally exceed one mile beyond the existing corporate limits.
- C. Rural - All locations not included in the above two definitions should be considered as rural.
- D. Frequency or Spacing of Direct Access Driveways - Generally the following table and/or statements shall govern the spacing and frequency of direct access driveways. Frontage as used in this policy refers to ownership. Generally a maximum of one approach per ownership provides adequate access for residential uses. Generally a maximum of two approaches per ownership provides adequate access for commercial and industrial uses.

All direct access driveways must meet the Department's current minimum design criteria as it relates to safety, geometrics and sight distance.

MAXIMUM ALLOWABLE APPROACHES UNDER IDEAL CONDITIONS

FUNCTIONAL CLASS	URBAN	FRINGE URBAN	RURAL
Principal Arterial (Non-Interstate)	2 or 4 lane (with or without turning lanes) 1 per 100 ft. frontage per side	2 or 4 lane <u>Without Turn Lanes</u> 1 per 200 ft. frontage per side <u>Plus Turn Lanes</u> 1 per 100 ft. frontage	3 per mile per side farm residences field drives or commercial activity *
Minor Arterial	1 per 100 ft. frontage per side	1 per 100 ft. frontage per side	6 per mile per side *
Collector	2 per 100 ft. frontage per side	2 per 100 ft. frontage per side	Major Collector 6 per mile per side * Minor Collector No set restriction on numbers
Local	No set restriction on number	No set restriction on number	No set restriction on number

*This may be modified when more are warranted due to geographical features or change in land ownership.

IV. RESERVATIONS

The Department reserves the right to make, at any time, such changes, additions, repairs and relocations to any direct access driveway or its appurtenances within the right-of-way as may be necessary to permit the relocation, reconstruction, widening and maintenance of the highway and/or to provide proper protection to life and property on or adjacent to the highway.

V. EXCEPTION

Any requested deviation from this policy shall be submitted to a special review board by the District Engineer. The special review board will study and review the application with written recommendations to the executive staff. The composition of the special review board will be:

State Right-of-Way Engineer

State Traffic Engineer, Operations

State Traffic Engineer, Design

WYOMING STATE HIGHWAY DEPARTMENT

Form E-54
Revised 9-87

LICENSE

THE WYOMING HIGHWAY DEPARTMENT, (hereinafter called the "Department") hereby grants a License to _____, (hereinafter called the "Licensee").

For the installation of _____

located in: Section _____ Township _____ Range _____ Route _____
Section _____ Township _____ Range _____ County _____
Section _____ Township _____ Range _____ Maintenance Section _____
ACCESS CONTROLLED: Yes _____ No _____ Mile Post _____

upon the property of Department acquired for and/or utilized in the operation and maintenance of a state highway.

The Licensee hereby acknowledges and agrees as follows:

1. The facility will be placed in a manner conforming to recognized standards, applicable Federal, State, or local laws, codes, ordinances, and regulations; in the exact location shown on the attached "Exhibit A"; and as directed by the Department. Placing the facility in a location other than originally approved without obtaining prior Department approval by submitting a revised "Exhibit A" may void any and all claims by the Licensee for compensation for damage to the facility and/or injury caused by the Department during its normal functions of operating and maintaining the highway and may void the license.
2. Any future alterations, modifications, or removals of the facility within the highway right-of-way, required and requested by the Department, shall be completed without delay. Adjustments will be accomplished at no expense to the Department, unless otherwise provided for by law.
3. This license is issued pursuant to W.S. 1-26-813 and grants permission for the Licensee to occupy a portion of the right-of-way controlled by the Department. This permission is limited by the type of controlling interest held by the Department. Responsibility to satisfy any other fee (deeded) interest rests with the Licensee.
4. This license will not be modified, transferred, or assigned without the written consent of the Department. This license does not allow for installation of additional facilities, nor does this license set aside a strip of land of specific width for the exclusive use by the Licensee.
5. The maintenance, use, inspection, and access to the facility shall be accomplished from locations outside of the lines of no access or access control. Ingress or egress to and from the facility from the traveled ways of access controlled road is hereby expressly forbidden.
6. Attached to this license is a plan sheet(s) labeled "Exhibit A", dated _____, which clearly shows the facility's alignment, grade, vertical and horizontal clearances, type of material, operating pressure and/or capacity, land and highway milepost ties, as well as dimensions from the proposed facility to the roadway and/or right-of-way line, which by this reference is made a part thereof.
7. The Licensee agrees to the standards for traffic control as outlined in the "Wyoming State Highway Department Traffic Control For Roadway Work Operations" manual. Standards developed by the Licensee may be substituted for the cited manual provided they have been approved by the State Traffic Engineer-Operations. The Licensee must cease all operations if he does not comply with traffic control standards.
8. The Licensee agrees to forever indemnify the Department and save it harmless from all liability for damages to property, or injury to or death of persons, including all costs and expenses related thereto, arising wholly or in part, or in connection with the existence, construction, alteration, repair, renewal, use, or removal of the facility by the Licensee or his agents, for those facilities located within the state or Federal highway described or noted herein.

9. Specific construction considerations may be attached to this form by the Department. The Licensee agrees to incorporate the applicable requirements into the design of the facility and assures compliance with these requirements during the construction of the facility. Non-compliance will void this permit.
10. The Licensee is required to notify the Department in writing to cancel and/or nullify any issued license if the described facility is to be abandoned in place, will be removed, or will not be constructed. In case of abandonment in place, the Department will determine if abandonment in place will hinder the Department's future operations and the Department will require removal of the facility slated for abandonment.
11. This license will be null and void if construction of the described facility does not commence within six (6) months of approval, unless prior arrangements have been made specifying a specific construction period. This license shall be null and void if the described facility is not in use for a period of eighteen (18) months or longer, and the Licensee may be required to remove the facility.
12. Based upon the complexity, construction methods or other concerns, the Department may assign part-time or full-time inspector(s) to the Licensee's project. The cost of such inspection will be at the sole expense of the Licensee, and the Department's District Office will initiate an "Authority For Rendering Special Services (ARS)", as provided in Operation Policy 24-3, to cover such costs.
13. District Stipulations:

The undersigned, Licensee/Owner of the facility, hereby accepts this License, subject to the terms and conditions stated herein.

LICENSEE/OWNER

Company Name: _____

By: _____

Address: _____

Telephone No. _____

Date: _____

WYOMING STATE HIGHWAY DEPARTMENT

By: _____
 District Engineer Date

By: _____
 District Maintenance Engineer Date