

ZX SPECTRUM SOFTWARE CATALOG WITH SCREENSHOTS

From the collection www.worldofspectrum.org
Converted to PDF by Samir Ribić

July, 2007

007 De-Pulsar (Tony Bryan,)
Utility

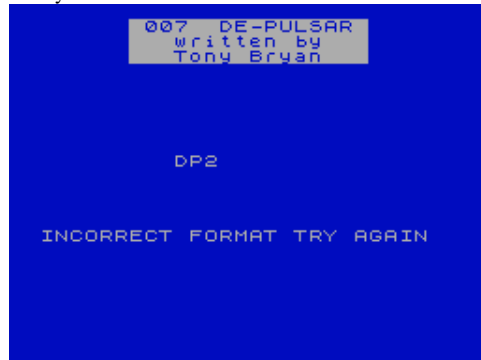

007 Header Reader (ZX-Guaranteed,1985)
Utility: Copier

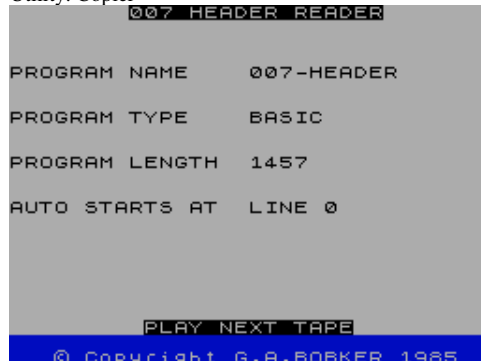

007 Spy (ZX-Guaranteed,1983)
Utility: Copier



007 Spy Tape 2 (ZX-Guaranteed,1983)
Utility: Copier

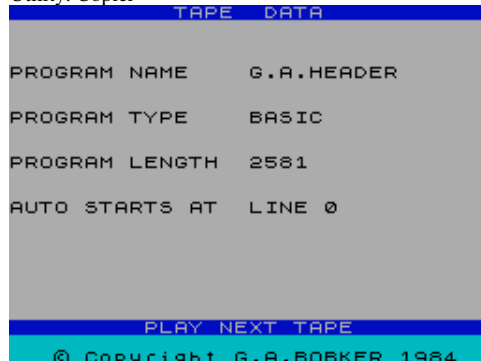

1000 (Willis Software,1997)
Board/Card Game



007 Disassembler (ZX-Guaranteed,1992)
Utility: Assembler/Disassembler/Monitor



007 MD (ZX-Guaranteed,1985)
Utility: Copier



007 Spy M (ZX-Guaranteed,1984)
Utility: Copier



007-Spy Tape Copier (Tony Bryan,)
Utility: Copier



100% Dynamite (Ocean Software Ltd,1990)
Compilation



007 Fast (ZX-Guaranteed,1984)
Utility: Copier

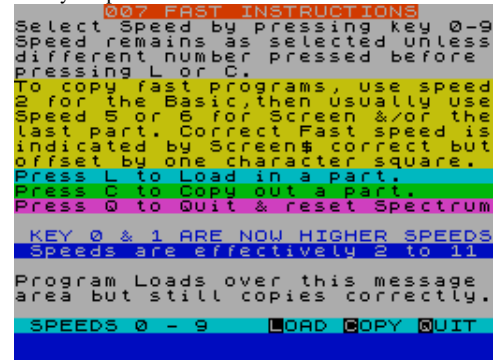

007 Multispy (ZX-Guaranteed,)
Compilation



007 Spy N (ZX-Guaranteed,1984)
Utility: Copier



007 Super File 2 (ZX-Guaranteed,1987)
Utility: Copier

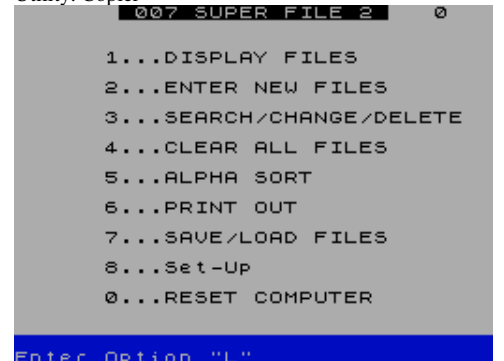

100 km Race (Coyote Software,)
Arcade



100 Programs for the ZX Spectrum (Prentice-Hall, 1984)
Compilation

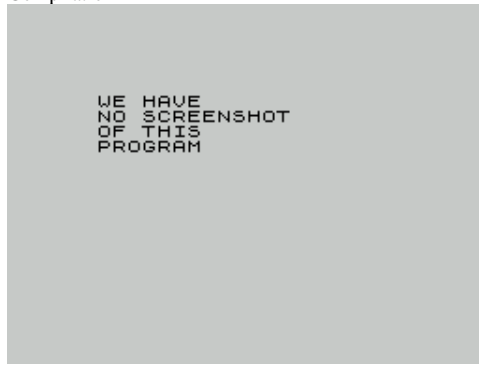

10 Adventure Game Pack (Central Solutions, 1986)
Compilation

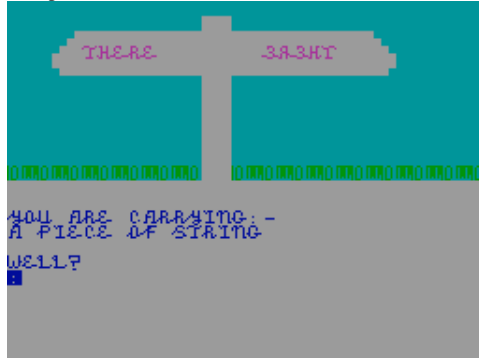

10 Computer Hits 2 (Beau-Jolly Ltd, 1987)
Compilation



10 Computer Hits 5 (Beau-Jolly Ltd, 1989)
Compilation



10 Great Games 3 (Gremlin Graphics Software Ltd, 1988) Compilation



100 Rutinas C.M. (Iveson Software S.A., 1985)
Utility: Assembler/Disassembler/Monitor



10 Adventure Game Pack Volume 2 (Central Solutions, 1986)
Compilation



10 Computer Hits 3 (Beau-Jolly Ltd, 1987)
Compilation



10 Fingers (Digital Reality [2], 1996)
Educational



10 Great Games II (Gremlin Graphics Software Ltd, 1988) Compilation



105 Grafikzeichen (CPL Computer Plus Soft GmbH, 1984)
Utility

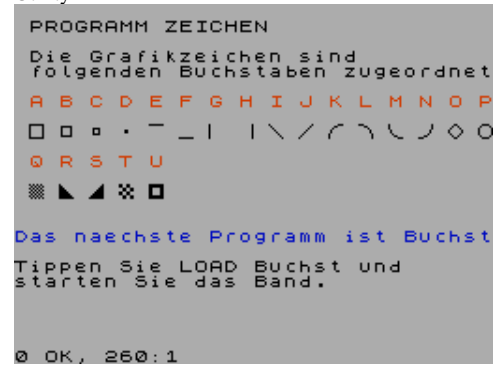

10 Computer Hits 1 (Beau-Jolly Ltd, 1987)
Compilation



10 Computer Hits 4 (Beau-Jolly Ltd, 1988)
Compilation



10 Great Games (Gremlin Graphics Software Ltd, 1988)
Compilation

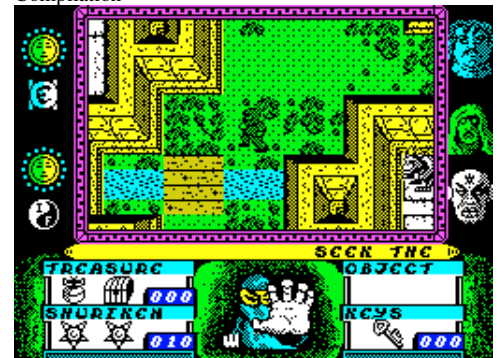

10 Juegos I (Microparadise Software, 1984)
Compilation



10 Juegos II (Microparadise Software,1984)
Compilation



10 Pack (Gremlin Graphics Software Ltd,1991)
Compilation



10 Pack Vol 3 (Automata UK Ltd,1985)
Compilation



11-a-Side Soccer (Code Masters Gold,1988)
Sport



128 - 4 Pack (Tynesoft,1987)
Compilation



10 Mega Games Volume One (Gremlin Graphics
Software Ltd,1989) Compilation



10 Pack Vol 1 (Automata UK Ltd,1985)
Compilation



10th Frame (US Gold Ltd,1987)
Simulation

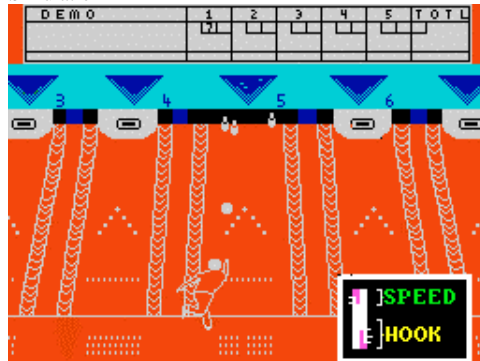

123 (Silverbird Software Ltd,1989)
Compilation

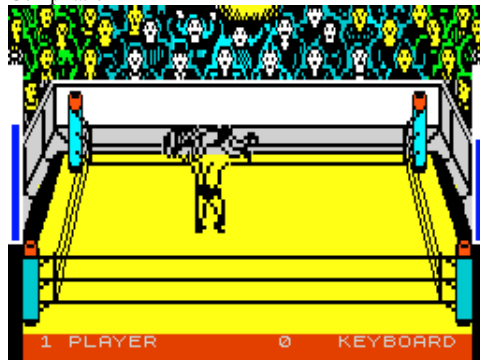

128 - 6 Pack (Tynesoft,1987)
Compilation



10 Mega Hits (Beau-Jolly Ltd,1985)
Compilation

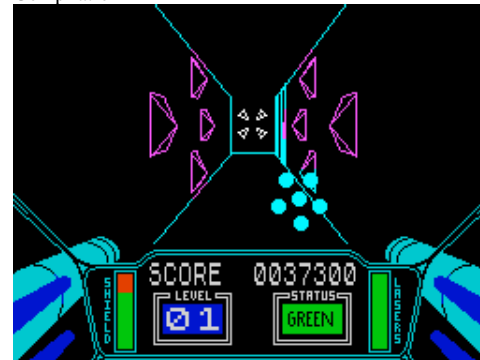

10 Pack Vol 2 (Automata UK Ltd,1985)
Compilation

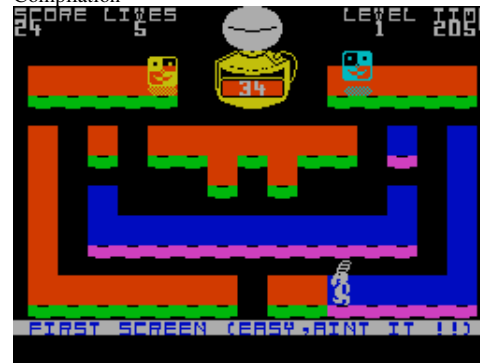

10 Titles for the Spectrum Plus (Boots,)
Compilation



128/48 Copy (,)
Utility: Copier



128 Demo (Castor Cracking Group,1987)
Scene Demo



128K Load (Sinclair User,1989)
Utility

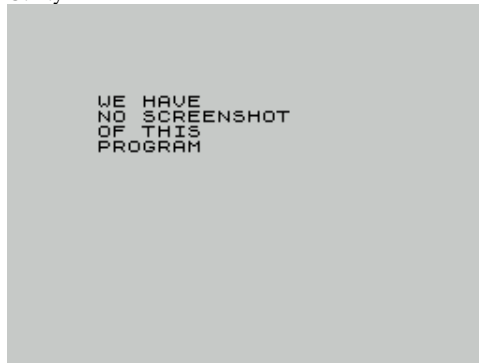

128 Music (R.D. Foord Software,1986)
Music

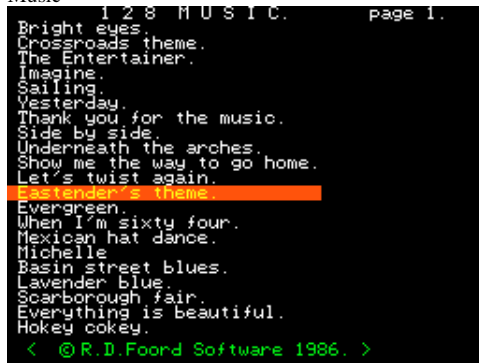

128 Music 2 (Castor Cracking Group,1987)
Scene Demo



13 Rue del Percebe (Pepsi Soft,1992)
Text Adventure



15 Puzzle (Sinclair Programs,1983)
Arcade

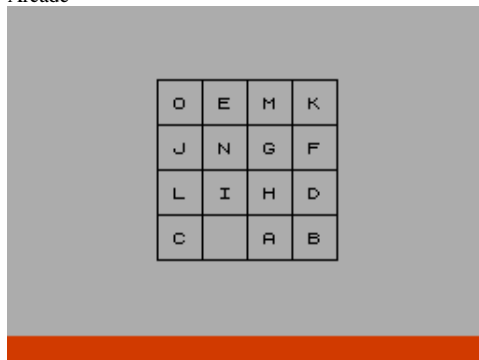

128k Music (Simon Owen,1989)
Scene Demo



128 Music + Carols (R.D. Foord Software,1986)
Compilation

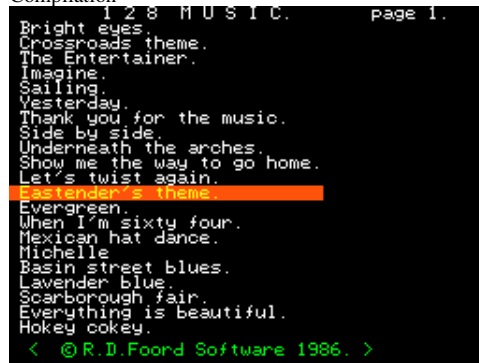

128 Shop Manager Demo (Sinclair Research Ltd.)
Simulation



15 Giochi Grafici (J. Soft,)
Compilation



15's (A. Vashin,1996)
Arcade



128Magnet Demo (Bromba,)
Scene Demo

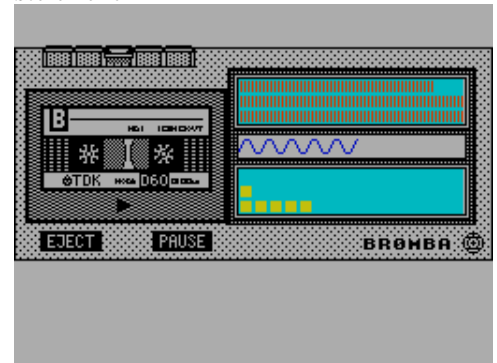

128 Music 1 (Castor Cracking Group,1987)
Scene Demo



12 Mysterious Books (Demiurge ASH,1999)
Text Adventure



15 OS (Laszlo Nyitrai,1998)
Board/Card Game



15's (Greedy Guys Group,1996)
Board/Card Game

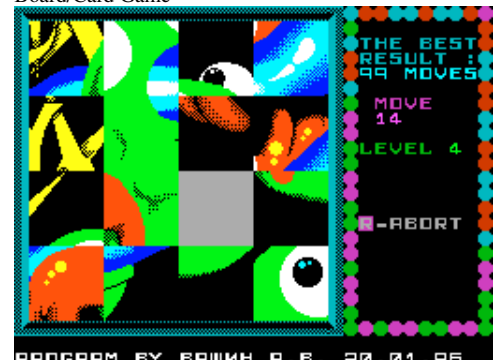

15, The (16/48 Tape Magazine,1984)
Arcade



16/48 Machine Code Tutor, The (16/48 Tape Magazine,1984)
Educational



16/48 Magazine Tape 01 (16/48 Tape Magazine,1983)
Covertape



16/48 Magazine Tape 02 (16/48 Tape Magazine,1983)
Covertape



16/48 Magazine Tape 03 (16/48 Tape Magazine,1984)
Covertape



16/48 Magazine Tape 04 (16/48 Tape Magazine,1984)
Covertape



16/48 Magazine Tape 05 (16/48 Tape Magazine,1984)
Covertape



16/48 Magazine Tape 06 (16/48 Tape Magazine,1984)
Covertape



16/48 Magazine Tape 07 (16/48 Tape Magazine,1984)
Covertape



16/48 Magazine Tape 08 (16/48 Tape Magazine,1984)
Covertape



16/48 Magazine Tape 09 (16/48 Tape Magazine,1984)
Covertape



16/48 Magazine Tape 10 (16/48 Tape Magazine,1984)
Covertape



16/48 Magazine Tape 11 (16/48 Tape Magazine,1984)
Covertape



16/48 Magazine Tape 12 (16/48 Tape Magazine,1984)
Covertape



16/48 Magazine Tape 13 (16/48 Tape Magazine,1985)
Covertape



16/48 Magazine Tape 14 (16/48 Tape Magazine,1985)
Covertape

```
WE HAVE  
NO SCREENSHOT  
OF THIS  
PROGRAM
```

16/48 Magazine Tape 15 (16/48 Tape Magazine,1985)
Covertape

```
WE HAVE  
NO SCREENSHOT  
OF THIS  
PROGRAM
```

16/48 Magazine Tape 16 (16/48 Tape Magazine,1985)
Covertape

```
WE HAVE  
NO SCREENSHOT  
OF THIS  
PROGRAM
```

16/48 Magazine Tape 17 (16/48 Tape Magazine,1985)
Covertape

```
WE HAVE  
NO SCREENSHOT  
OF THIS  
PROGRAM
```

16/48 Magazine Tape 18 (16/48 Tape Magazine,1985)
Covertape

```
WE HAVE  
NO SCREENSHOT  
OF THIS  
PROGRAM
```

16/48 Magazine Tape 19 (16/48 Tape Magazine,1985)
Covertape

```
WE HAVE  
NO SCREENSHOT  
OF THIS  
PROGRAM
```

16/48 Magazine Tape 20 (16/48 Tape Magazine,1985)
Covertape

```
WE HAVE  
NO SCREENSHOT  
OF THIS  
PROGRAM
```

16/48 Magazine Tape 21 (16/48 Tape Magazine,1985)
Covertape

```
WE HAVE  
NO SCREENSHOT  
OF THIS  
PROGRAM
```

16/48 Magazine Tape 22 (16/48 Tape Magazine,1985)
Covertape

```
WE HAVE  
NO SCREENSHOT  
OF THIS  
PROGRAM
```

16/48 Magazine Tape 23 (16/48 Tape Magazine,1985)
Covertape

```
WE HAVE  
NO SCREENSHOT  
OF THIS  
PROGRAM
```

16/48 Magazine Tape 24 (16/48 Tape Magazine,1985)
Covertape

```
WE HAVE  
NO SCREENSHOT  
OF THIS  
PROGRAM
```

16/48 Magazine Tape 25 (16/48 Tape Magazine,1986)
Covertape

```
WE HAVE  
NO SCREENSHOT  
OF THIS  
PROGRAM
```

16/48 Magazine Tape 26 (16/48 Tape Magazine,1986)
Covertape

```
WE HAVE  
NO SCREENSHOT  
OF THIS  
PROGRAM
```

16/48 Modem 2 (Pagani Massimo,1985)
Utility

16/48

Per collegarti alla nostra banca dati devi comporre sulla tastiera del tuo SPECTRUM il nostro numero di telefono ed attendere i messaggi del computer.
Il numero e' **8467343**

Inserisci il numero : "L"

16 Jatekgyaros (Jatekgyaros,2005)
Compilation

```
WE HAVE  
NO SCREENSHOT  
OF THIS  
PROGRAM
```

16K Multitasking (YRS,2003)
Utility

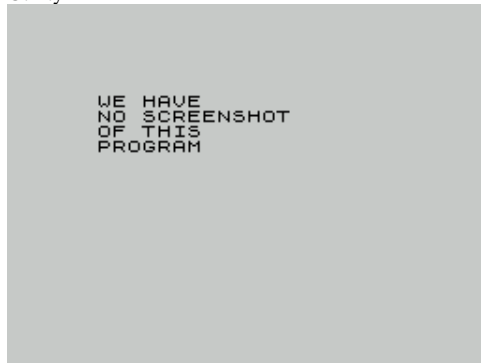

180 (CCS,1984)
Sport

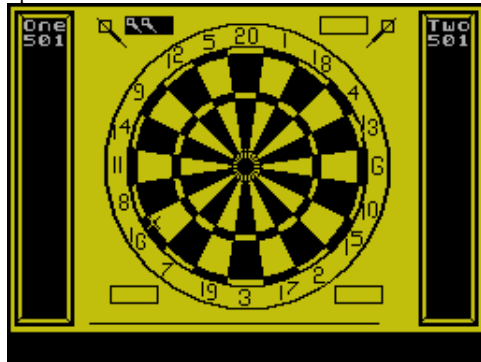

180! Darts (A'n'F Software,1984)
Sport

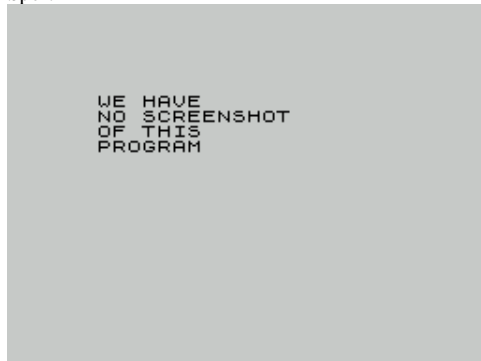

1942 Mission (Tartan Software,1985)
Text Adventure

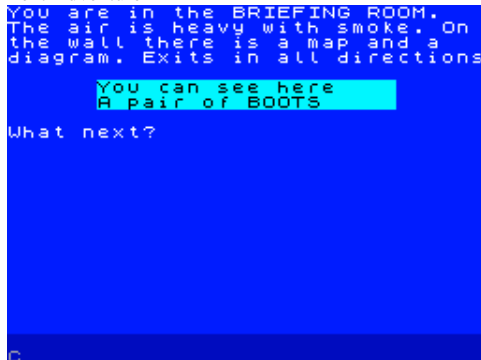

1984 (Amazing Games,1984)
Educational



16K Superchess (CP Software,1983)
Board/Card Game

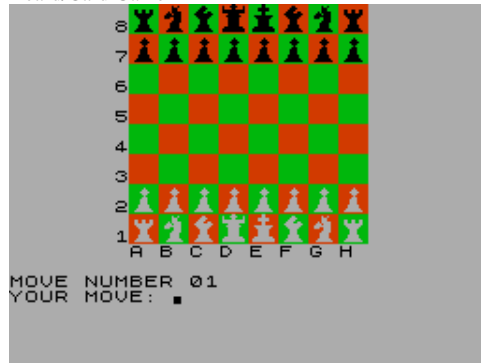

180 (Mastertronic Added Dimension,1986)
Sport



1942 (Elite Systems Ltd,1986)
Simulation



1943: The Battle of Midway (Go!,1988)
Arcade

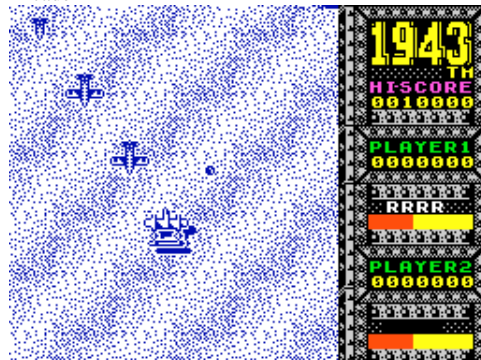

1984 (Incentive Software Ltd,1983)
Simulation

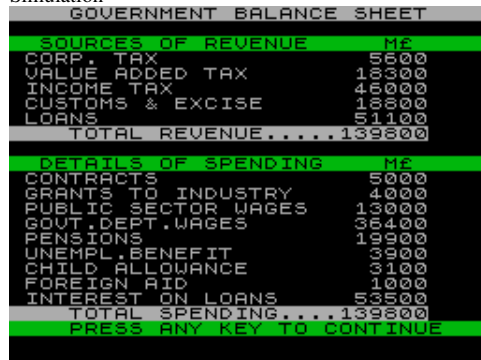

16-OS Puzzle (Laszlo Nyitrai,2005)
Board/Card Game

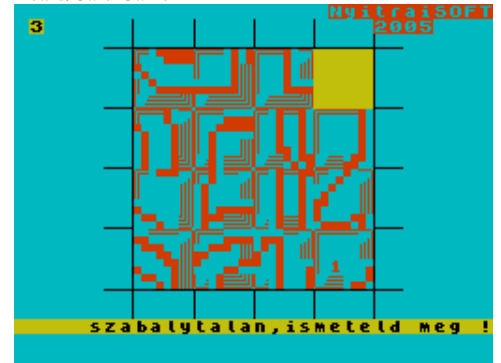

180 (Mikro-Gen Ltd,1983)
Sport



1942 + Batty (MCM Software S.A.,1989)
Compilation



1960's Locospotter (Ashley Greenup,1984)
Simulation

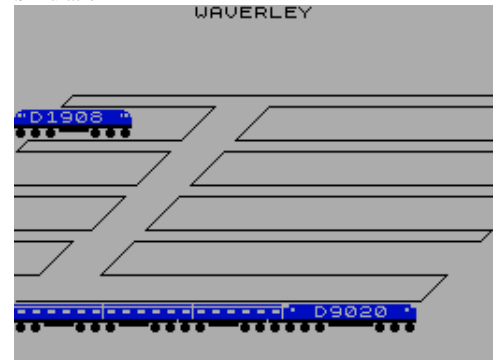

1984 Locospotter (Ashley Greenup,1984)
Simulation

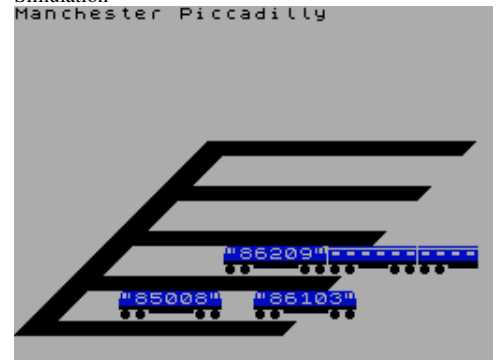

1985 - The Day After (Mastertronic Ltd,1985)
Arcade



1994 - Ten Years After (Visions Software Factory,1983)
Arcade

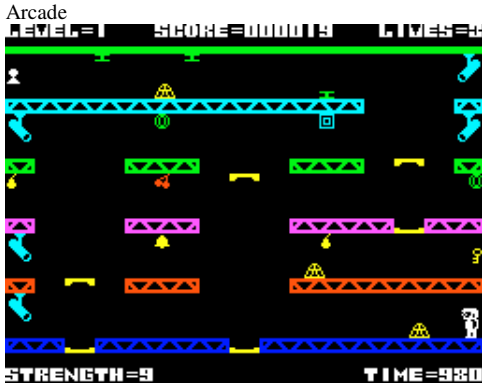

19 Part 1: Boot Camp (Cascade Games Ltd,1988)
Arcade



2003: A Space Oddity (DKTronics Ltd,1984)
Arcade



20 Characters Sets (Tilt Software,1990)
Utility

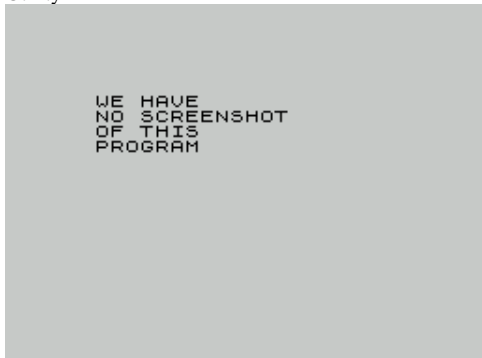

1990 (Dennis van Berkel,1989)
Scene Demo



1998 Demo 2 (Hooy-Program,1998)
Scene Demo



19 Part 2: Combat Zone (Cascade Games Ltd,)
Arcade



20-20 Vision (Gadtek Games,1986)
Arcade



20 Chart Busters (Beau-Jolly Ltd,1988)
Compilation

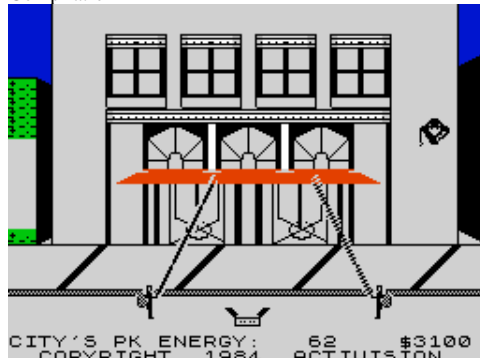

1994 Locospotter (Ashley Greenup,1994)
Simulation

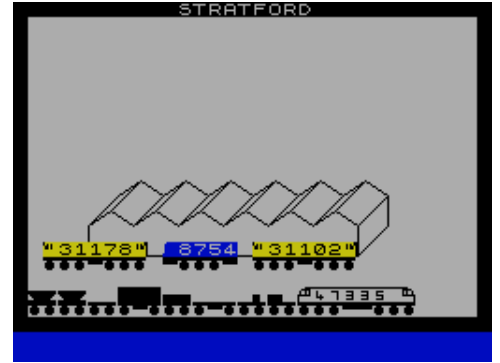

1999 (Summit Software,1987)
Arcade

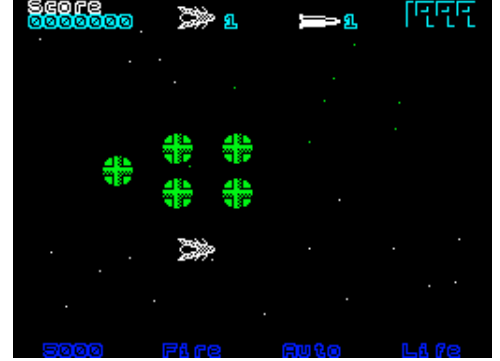

1st Demo (Adriano,1993)
Scene Demo



2088 (Zeppelin Games Ltd,1988)
Arcade



20 Game Pack (Comet,)
Compilation

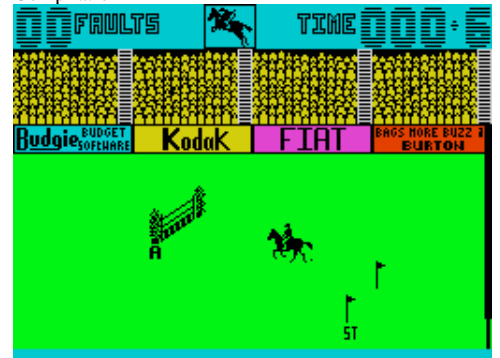

20 Tons (Spectrum Computing,1985)
Arcade



25 Jatekgyaros (Jatekgyaros,2005)
Compilation



2 Player Soccer Squad (Cult Games,1991)
Simulation



2 Por 1: Goody + The Last Mission (Opera Soft S.A.,)
Compilation

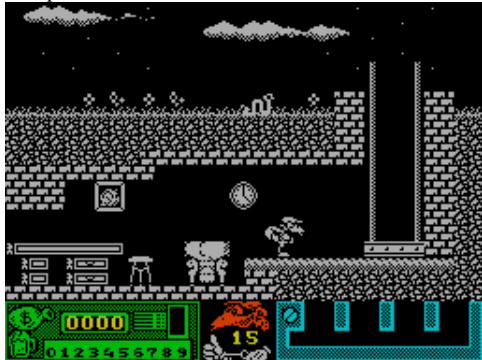

2 Por 1: Renegade + Target Renegade (Erbe Software S.A.,1988) Compilation



20 Utilidades (Hobby Press S.A.,1986)
Compilation

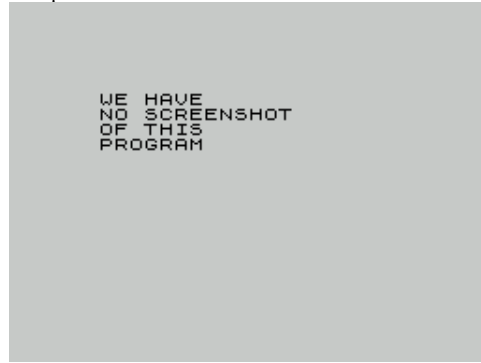

2D Game Maker (CRL Group PLC,1988)
Arcade Game Development Tool



2 Por 1: Bedlam + Side Arms (Erbe Software S.A.,1988)
Compilation



2 Por 1: Motor Massacre + Final Assault (Erbe Software S.A.,) Compilation

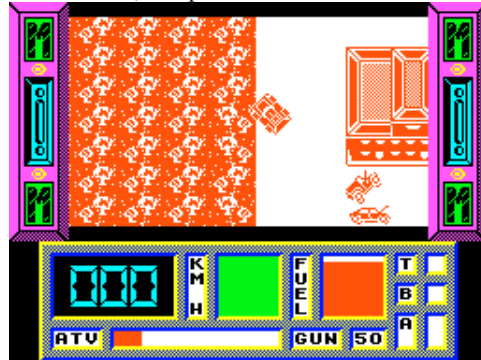

2 Por 1: Road Blasters + Street Fighter (Erbe Software S.A.,1988) Compilation



2112 AD (Design Design Software,1985)
Arcade Adventure

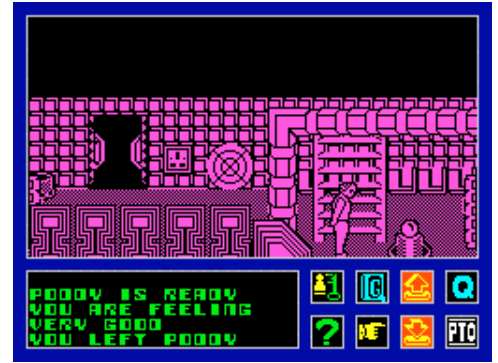

2 Hot 2 Handle (Ocean Software Ltd,1992)
Compilation



2 Por 1: Chase H.Q. + Indiana Jones y la Ultima Cruzada (Erbe Software S.A.,1989) Compilation



2 Por 1: Platoon + Arkanoid - Revenge of Doh (Erbe Software S.A.,) Compilation



2 Por 1: Rock 'n Roller + Wells 'n' Fargo (Erbe Software S.A.,) Compilation

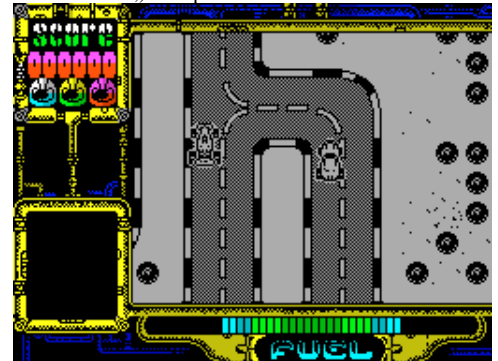

2 Por 1: Silent Shadow + Mad Mix Game (Erbe Software S.A.,1988) Compilation

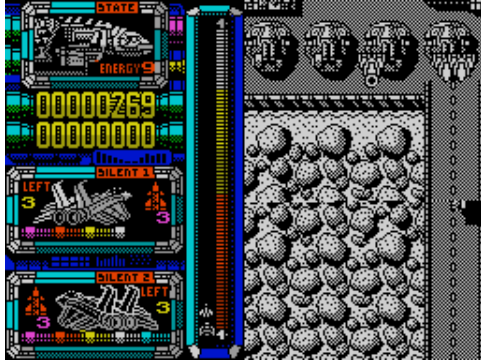

2 Por 1: The Deep + The Muncher (Erbe Software S.A.,1989) Compilation



2-Speed Copy (Ivan Stich,) Utility: Copier



2 X 1: Hundra + Turbo Girl (Dinamic Software,) Compilation

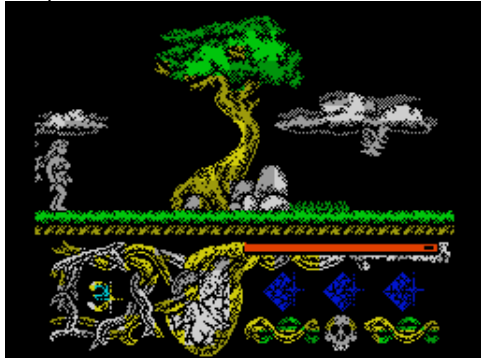

30+1 Programs (Laszlo Nyitrai,2003) Compilation



2 Por 1: Super Scramble Simulator + Forgotten Worlds (Erbe Software S.A.,1989) Compilation

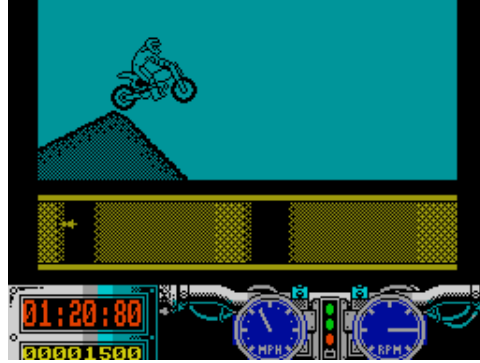

2 Por 1: Thunder Blade + Cybernoid II (Erbe Software S.A.,1988) Compilation



2 X 1: Capitan Sevilla + Meganova (Dinamic Software,) Compilation



2 X 1: Phantis + Freddy Hardest (Dinamic Software,) Compilation



30 Games (Argus Press Software Ltd,1986) Compilation



2 Por 1: Techno-Cop + Mickey Mouse (Erbe Software S.A.,1988) Compilation

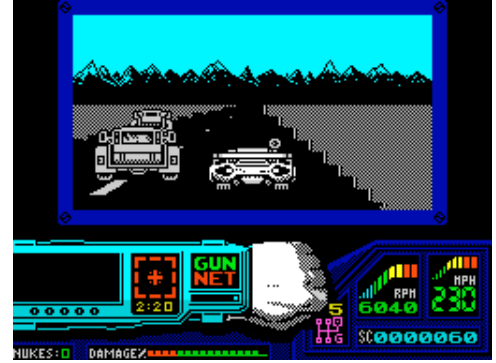

2 Por 1: Venom Strikes Back + North Star (Erbe Software S.A.,) Compilation



2 X 1: Don Quijote + Mega-Corp (Dinamic Software,) Compilation



30+1 Kazetta (Laszlo Nyitrai,2002) Compilation



30 Hour Basic - Spectrum Edition (National Extension College Trust Ltd,1983) Educational

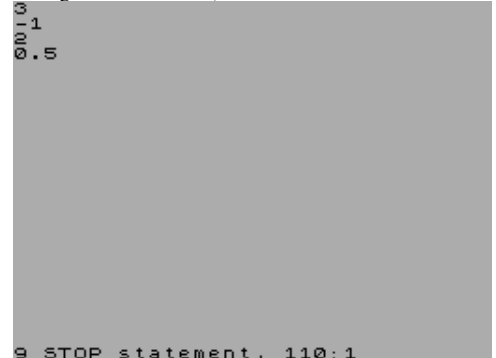

30 Red Hot Hits (Beau-Jolly Ltd,1989)
Compilation

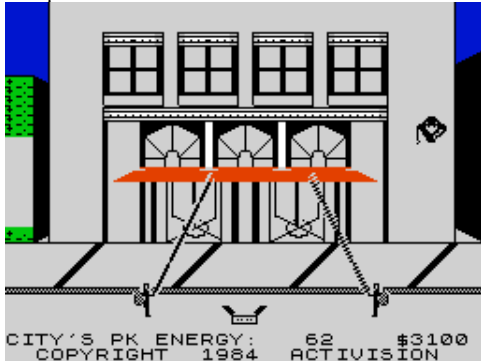

3D Construction Kit (Domark Ltd,1991)



3D-Graphs (Mikro+kleincomputer Informa Verlag AG,1984)

Utility: BASIC Related

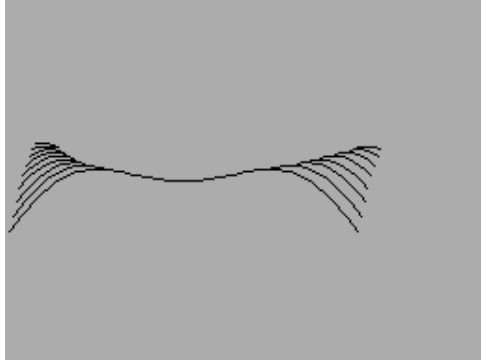

3D-OXXO (Roelof Koning,1985)

Arcade

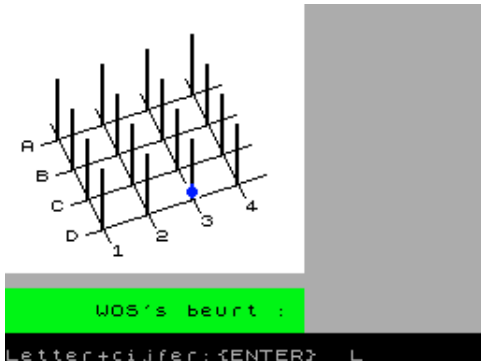

3K Music (.)

Utility: Music Creation



3D (EP Software,)

Arcade

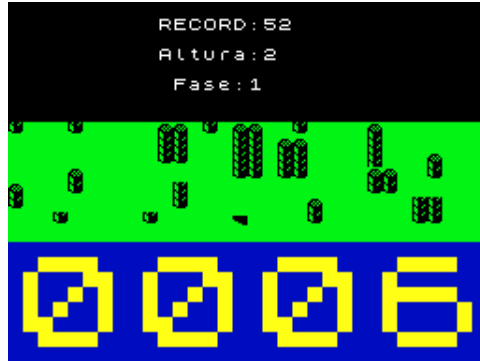

3-Deep Space (Postern,1984)

Arcade



3D-Interceptor (Ventamatic,1984)

Arcade



3D-Roost (Fenomen,1998)

Board/Card Game

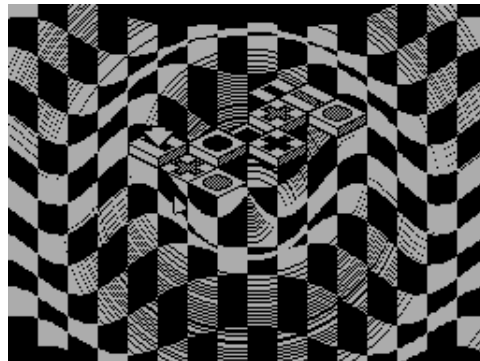

3K Music M (.)

Utility: Music Creation



3DC (Encore,1987)

Arcade



3D Game Maker (CRL Group PLC,1987)

Arcade Game Development Tool



3-D Noughts and Crosses (Precision Software Engineering,1983)

Arcade



3D-Word (Sinclair User,1985)

Utility: BASIC Related



3 Mega Tunes (Your Sinclair,1991)

Scene Demo



<3 Smash (Icabod,2006)
Scene Demo



40 Principales Vol. 1, Los (Erbe Software S.A.)
Compilation



40 Principales Vol. 4, Los (Erbe Software S.A.)
Compilation



40 Principales Vol. 7, Los (Erbe Software S.A.)
Compilation



40 Sermon Outlines for Busy Preachers (Melvyn Hamilton,1984) Utility



40 Characters Per Line (P.K. Bown,1983)
Utility

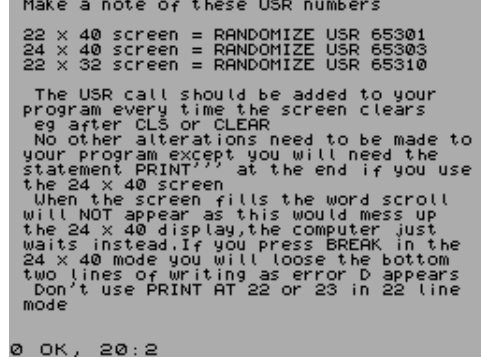

40 Principales Vol. 2, Los (Erbe Software S.A.)
Compilation



40 Principales Vol. 5, Los (Erbe Software S.A.)
Compilation



40 Principales Vol. 8, Los (Erbe Software S.A.)
Compilation



42 Columns (Spectrum Computing,1984)
Utility



40 Principales Vol. 10, Los (Erbe Software S.A.)
Compilation



40 Principales Vol. 3, Los (Erbe Software S.A.)
Compilation



40 Principales Vol. 6, Los (Erbe Software S.A.)
Compilation



40 Principales Vol. 9, Los (Erbe Software S.A.)
Compilation



48/80 Forth (East London Robotics Ltd,1983)
Utility: Programming

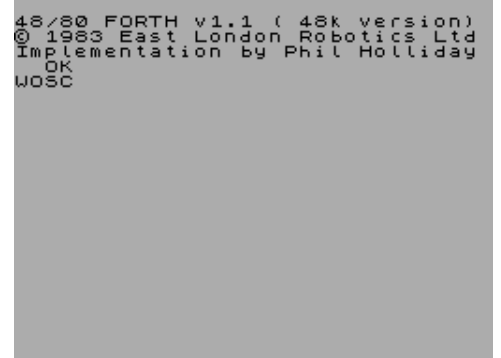

48 Irons (Galaxy Inc,1995)
Arcade Adventure



48K-Block-Splitter (Slabihoud Software,1986)
Utility

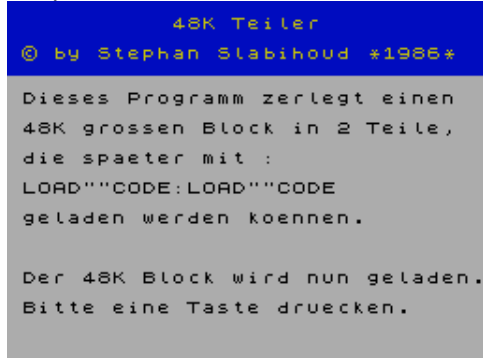

48K issue 03 (Monser S.A.,1985)
Covertape



48K issue 06 (Monser S.A.,1985)
Covertape



48K issue 09 (Monser S.A.,1985)
Covertape



48 Irons Help (FFC Computers,1996)
Arcade Adventure

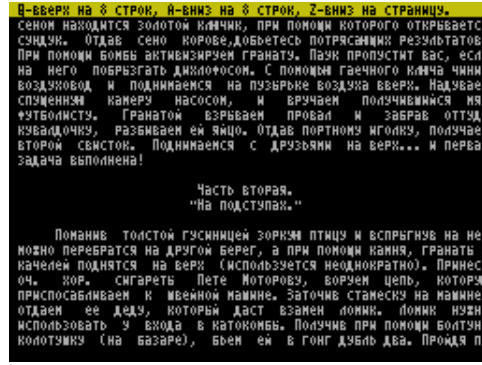

48K issue 01 (Monser S.A.,1985)
Covertape

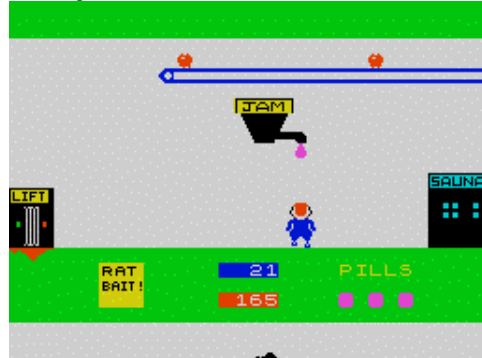

48K issue 04 (Monser S.A.,1985)
Covertape



48K issue 07 (Monser S.A.,1985)
Covertape



48K issue 10 (Monser S.A.,1985)
Covertape



48K/128K BREAK and ERROR trapper (Simon Salwan,1988)
Utility

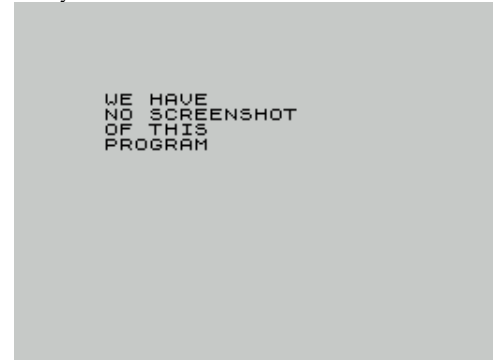

48K issue 02 (Monser S.A.,1985)
Covertape



48K issue 05 (Monser S.A.,1985)
Covertape



48K issue 08 (Monser S.A.,1985)
Covertape

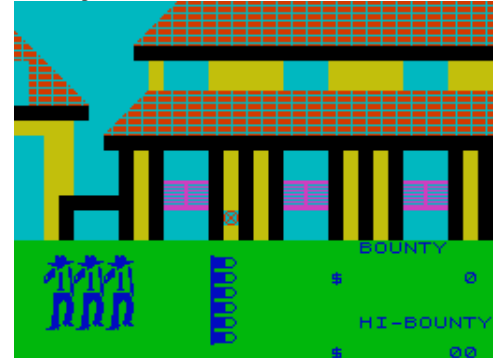

48K issue 11 (Monser S.A.,1985)
Covertape



48K Toolkit (Peker Computers Ltd,1985)
Utility



4Chandemo2 es Spectone1 Leiras (Zoltan Janosy,1987)
Utility: Music Creation

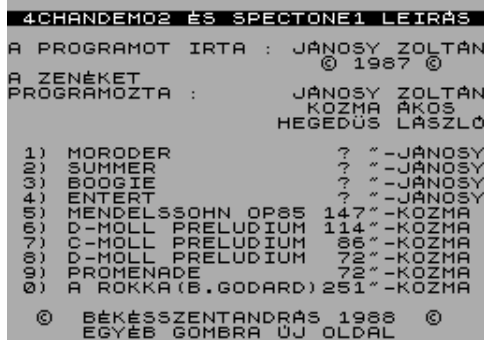

4 Game Pack No. 1 (Atlantis Software Ltd,1992)
Compilation



4 Games For Children (Kindersoft UK Ltd,1984)
Educational

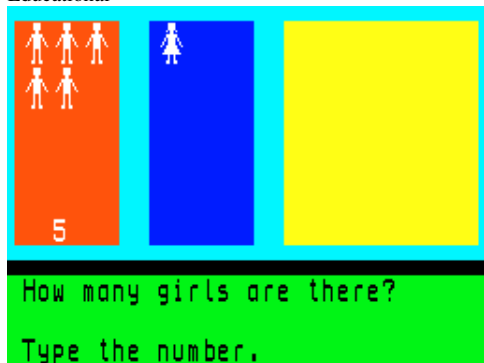

4 Minute Warning (Magination Software,1984)
Arcade

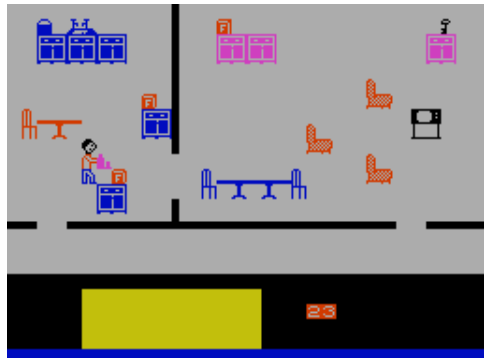

4 Aces (Digital Integration,1987)
Compilation

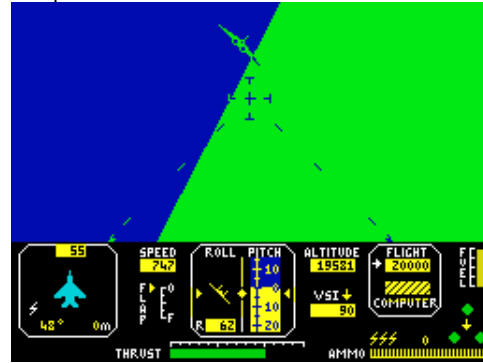

4 Crash Smashes (Gremlin Graphics Software Ltd,1986)
Compilation



4 Game Pack No. 2 (Atlantis Software Ltd,1992)
Compilation

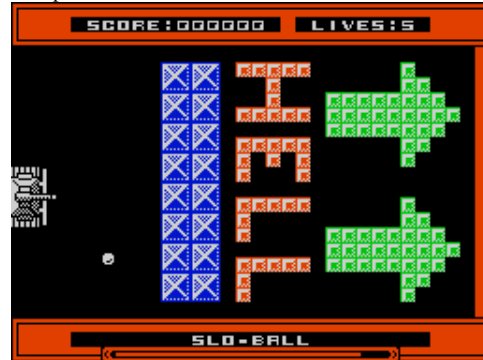

4 Gewinnt (Slabihoud Software,1986)
Board/Card Game

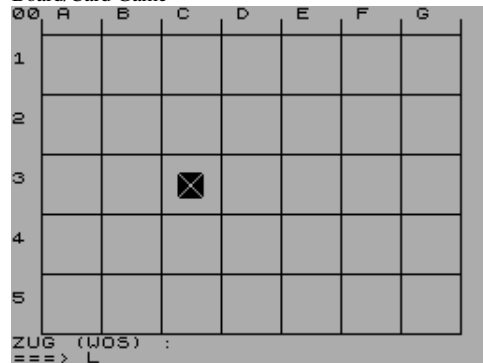

4-Most Action (Alternative Software Ltd,1991)
Compilation

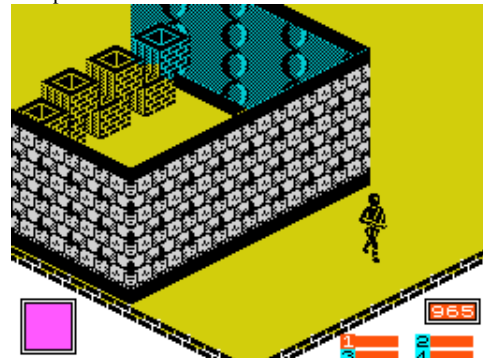

4 Adventure Games (Aacksoft,1986)
Compilation

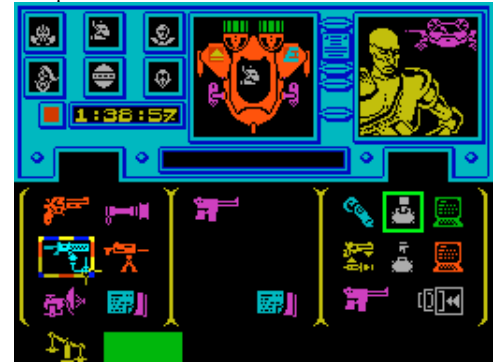

4 Crash Smashes II (Gremlin Graphics Software Ltd,1986)
Compilation

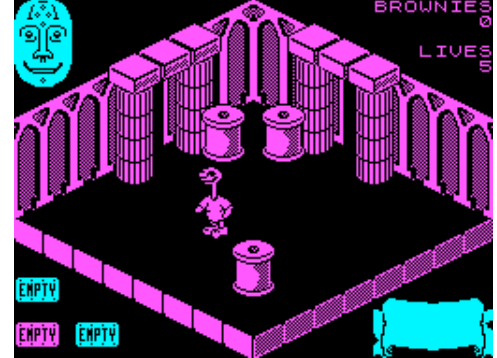

4 Game Pack No. 3 (Atlantis Software Ltd,1992)
Compilation



4 in 1 (Hit-Pak,1986)
Compilation



4-Most Adventures (Alternative Software Ltd,1991)
Compilation

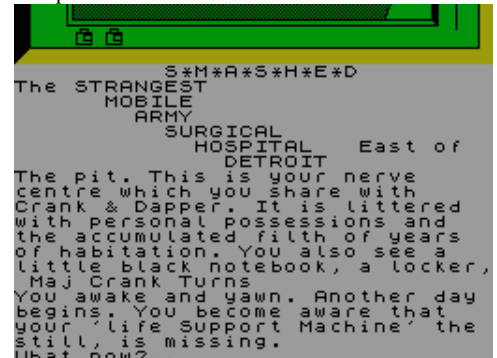

4-Most Airpower (Alternative Software Ltd,1991)
Compilation

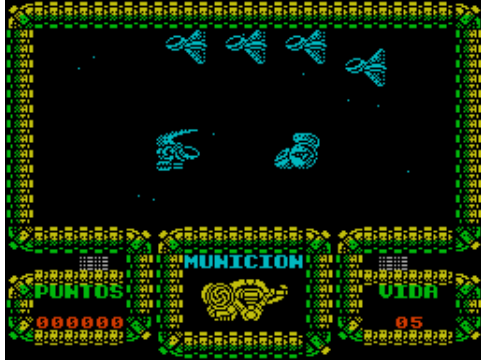

4-Most Cute (Alternative Software Ltd,1991)
Compilation



4-Most Horror (Alternative Software Ltd,1991)
Compilation



4-Most Sport (Alternative Software Ltd,1991)
Compilation



4-Most Toppers (Alternative Software Ltd,1992)
Compilation

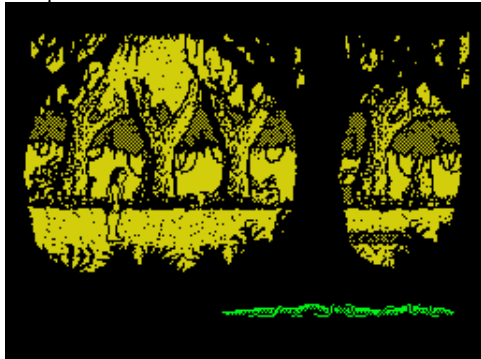

4-Most Balls, Boots and Brains (Alternative Software
Ltd,1992) Compilation

RESULTS				GATES	
LEAGUE RESULTS SERVICE WEEK 19					
ARSENAL	1	SOUTHAMPTON	2	26739	
CHARLTON ATH	0	TOTTENHAM	4	11150	
LEEDS	0	PORTSMOUTH	3	31381	
LIVERPOOL	0	QUEENSBERRY	1	33354	
LUTON TOWN			2 SHEFFIELD WED 1		
HOME TEAM			AWAY TEAM		
SEALY		HODGE			
BROOKER		STERLAND			
JOHNSON		HORTONINGTON			
NICHOLAS		SMITH			
FOSTER		URR			
OWEN		SHOIN			
HILL		HEBSON			
STEIN	2	HARWOOD	1		
WELLS		CHARMAN			
GRIBBS		DOHNE			
DIBBLE		BROASHAN			

4-Most Fight & Fright (Alternative Software Ltd,1991)
Compilation



4-Most Megaheroes (Alternative Software Ltd,1991)
Compilation



4-Most Super Sports (Alternative Software Ltd,1993)
Compilation



4-Most Warzone (Alternative Software Ltd,1991)
Compilation



4-Most Big Hits (Alternative Software Ltd.)
Compilation

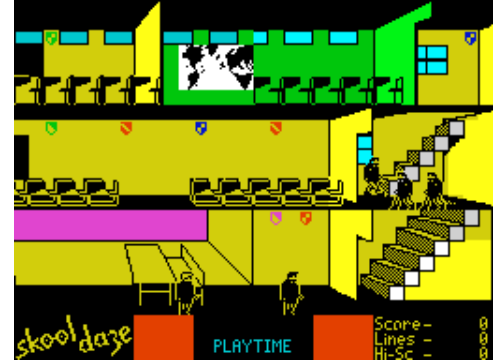

4-Most Fun (Alternative Software Ltd,1991)
Compilation



4-Most Speedstunts (Alternative Software Ltd,1991)
Compilation



4-Most Thrillers (Alternative Software Ltd,1992)
Compilation

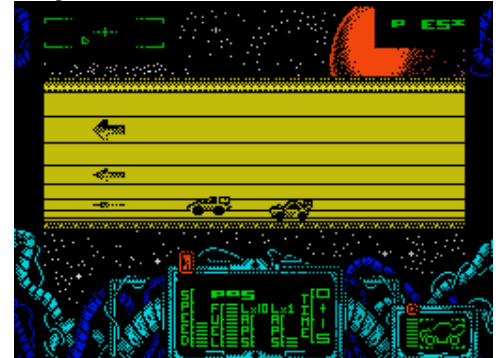

4-Most World Sport (Alternative Software Ltd,1991)
Compilation



4 on a Row (CrisiSoft,2005)
Board/Card Game

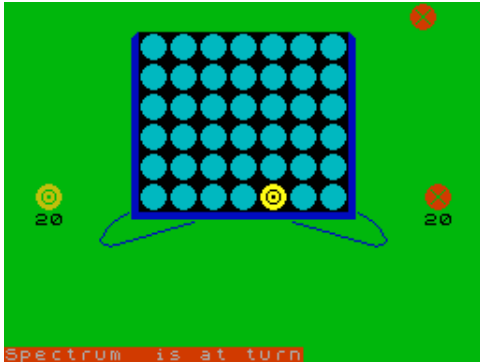

4 Smash Hits (Hewson Consultants Ltd,1987)
Compilation

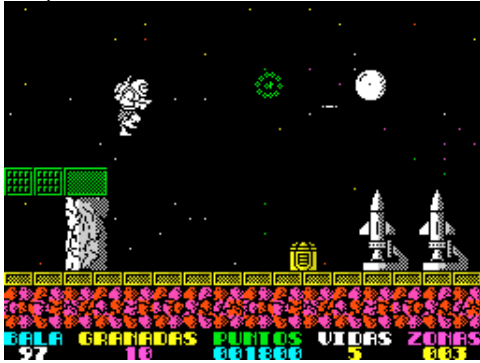

4th Dimension (Hewson Consultants Ltd,1990)
Compilation



4 X 1 (Dinamic Software,1988)
Compilation

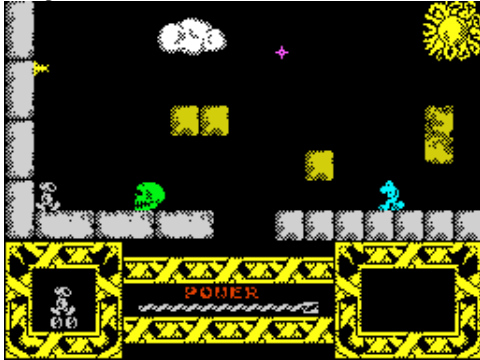

50/50 (Home (Programs) Soft,1993)
Scene Demo



4 Quality Games (Cascade Games Ltd,1984)
Compilation

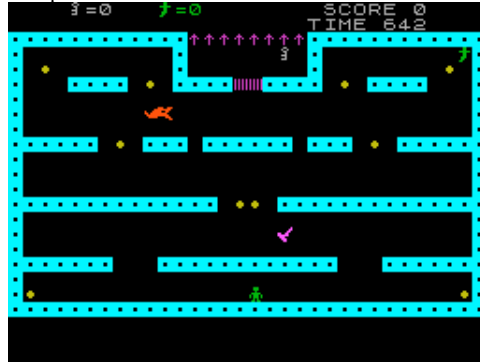

4 Soccer Simulators (Code Masters Gold,1988)
Compilation



4 Top Games (Martech Games Ltd,1987)
Compilation

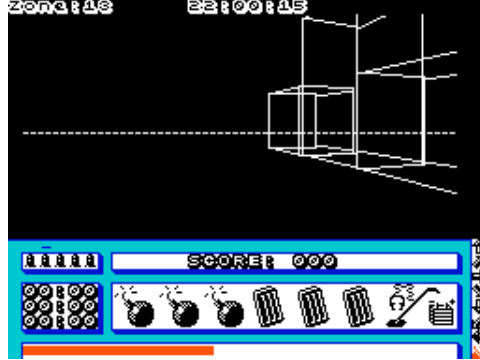

4x4 Off-Road Racing (US Gold Ltd,1988)
Arcade



51 (Th. Dargell,1983)
Board/Card Game



4 Rowz (Amazing Software Making,1997)
Board/Card Game

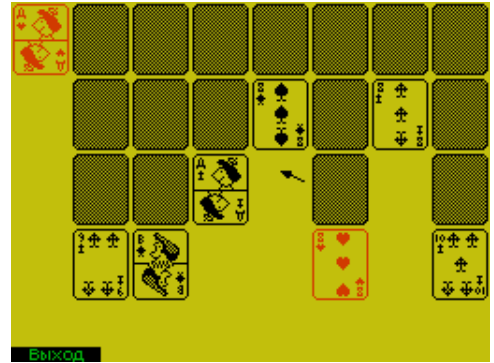

4 Super 4 (Dinamic Software,1986)
Compilation



4 Way Smooth Scroller (Spectrum Computing,1984)
Utility: BASIC Related



4X4 Puzzle (Clevers Group/Triumph Game Labs,1999)
Board/Card Game

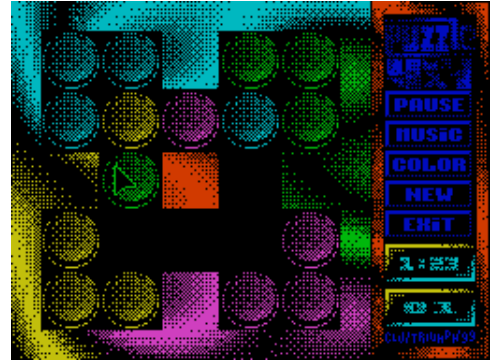

51 Games Compilation (Laszlo Nyitrai,2002)
Compilation



55 (PSS,1985)
Compilation



5 in 1 Tetris (Mortal Kombat Hackers Group,1995)
Arcade

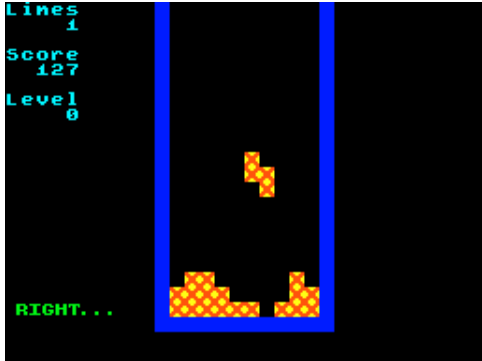

61 Hungary Games (Jatekgyaros,2005)
Compilation



64 Karaktera (Radio Ventilator 202,1984)
Utility: Font/UDGs



66 (Stankisoft,)
Board/Card Game



5 Computer Hits (Beau-Jolly Ltd,1987)
Compilation



5 in a Row (Hill MacGibbon,1986)
Board/Card Game

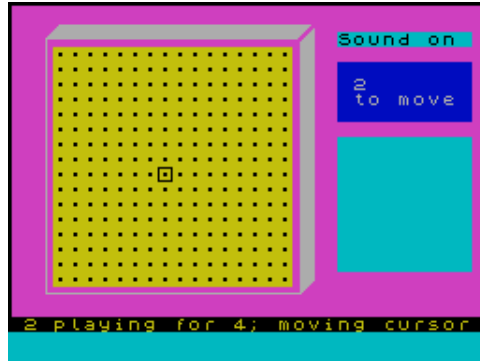

64 Characters Per Line Printing (16/48 Tape Magazine,1984)
Utility



64x32 Screen (Peekay Software,1984)
Utility: Font/UDGs

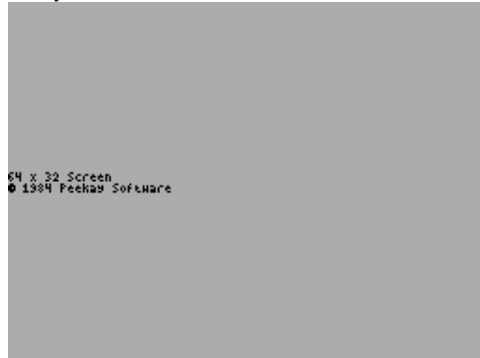

6 Computer Hits (Beau-Jolly Ltd,1985)
Compilation



5 Exitos de Opera Soft (Opera Soft S.A.,1990)
Compilation

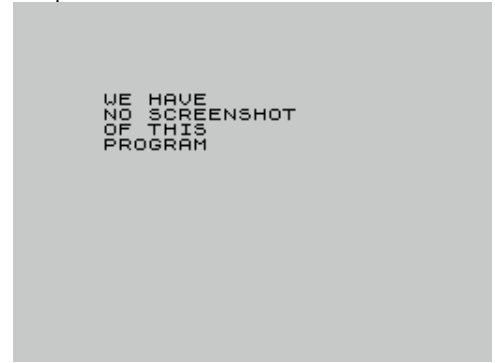

5th Music Demo (Kassoft,1989)
Scene Demo



64 Columns (Spectrum Computing,1984)
Utility



64 Zeichen (ZX Computing,1986)
Utility: Font/UDGs



6 Game Action Pack (Boots,1987)
Compilation



6 Games Compilation (Laszlo Nyitrai,2002)
Compilation



6-Pak (Hit-Pak,1987)
Compilation



720 Degrees (US Gold Ltd,1987)
Arcade



750cc Grand Prix (Code Masters Ltd,1991)
Arcade

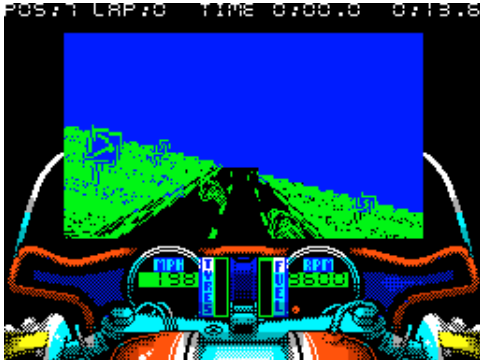

7th Reality Demo (Digital Reality [2],1996)
Scene Demo



6 in 1 (Tartan Software,1987)
Compilation

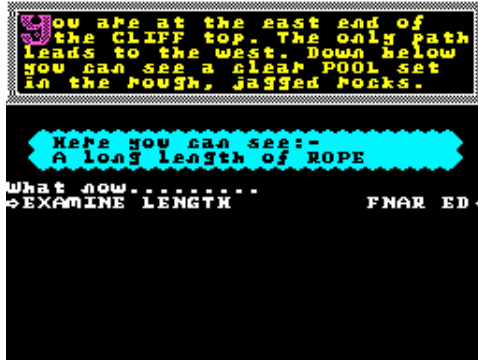

6-Pak Vol 2 (Hit-Pak,1987)
Compilation

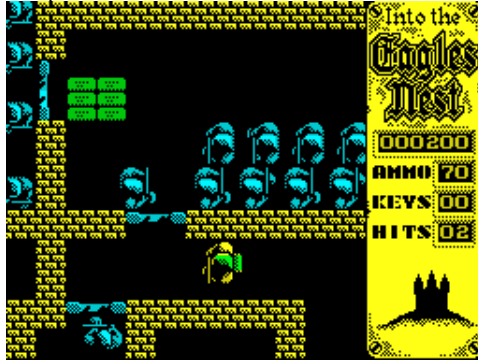

737 Cockpit (Machinecraft,1982)
Arcade



7.5, Las (MicroHobby,1986)
Board/Card Game



7x7 (MicroHobby,1986)
Arcade

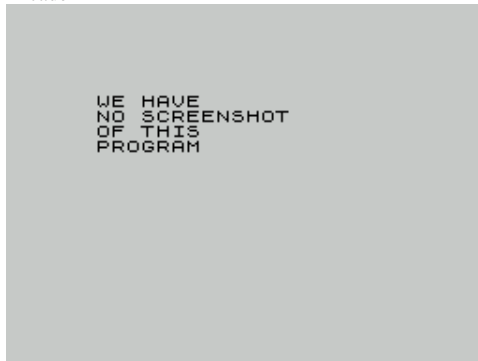

6 in Line (Phantom Family Corp,1999)
Board/Card Game

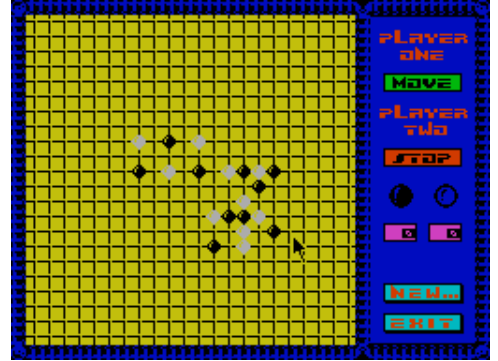

6-Pak Vol 3 (Elite Systems Ltd,1988)
Compilation



747 Flight Simulator (Dacc Ltd,1984)
Simulation

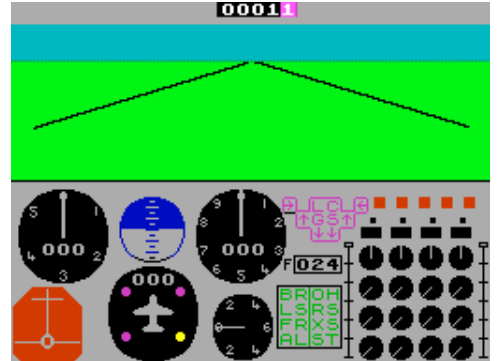

7 Card Stud (Martech Games Ltd,1986)
Board/Card Game

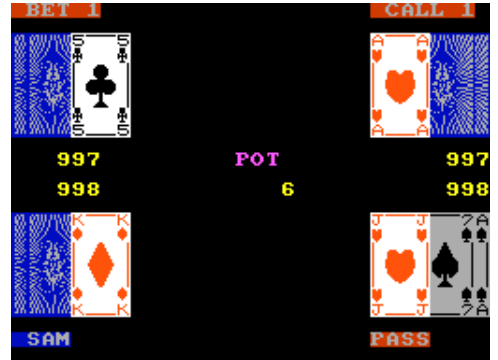

80'Puzzles (Flash Inc,1998)
Board/Card Game



8-Letter Anagrams (Ian J. Rogers.)
Board/Card Game

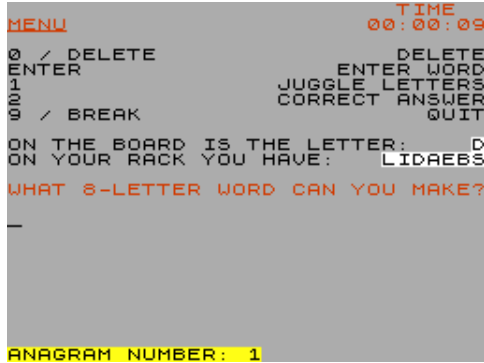

99Y (UK Lead,1986)

Text Adventure

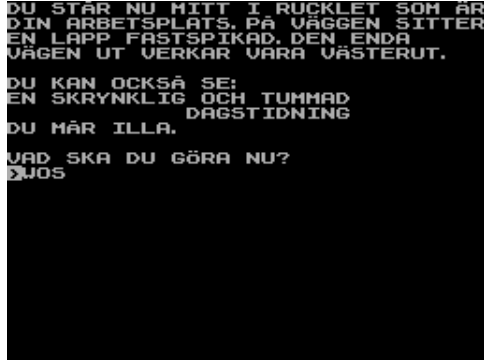

Aaargh! (Melbourne House,1989)
Arcade



Aackotax (Aackosoft/Kluwer Technische Boeken,1984)
Utility



Abadia del Crimen + Sir Fred, La (Mister Chip.)
Compilation



8x8 (Computer Kontakt,1987)

Utility

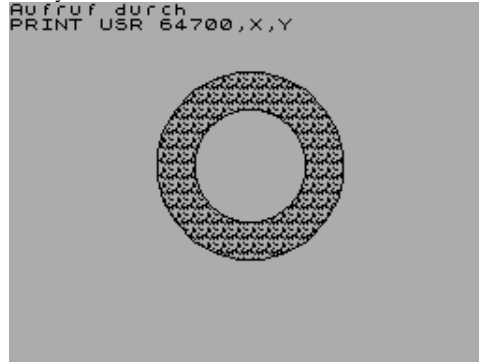

9-Hole Golf (Galileo,1986)
Sport



Aackocalc (Aackosoft.)
Utility: Spreadsheet

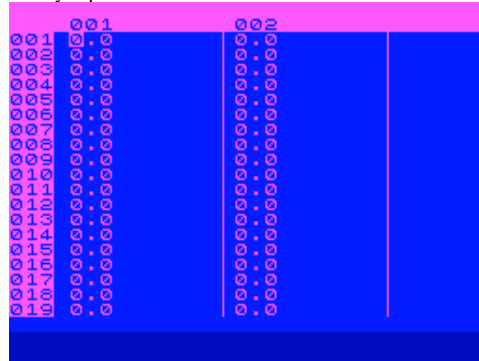

Aackotext (Aackosoft.)
Utility: Word Processor



Abadia del Crimen, La (Opera Soft S.A.,1988)
Arcade Adventure



911 TS (Elite Systems Ltd,1985)

Arcade



A-10 Thunderbolt (Gadget Software Unlimited,1995)
Arcade



Aacko Super Tool (Aackosoft,1984)
Utility: BASIC Related



AA Zempl (Axoft,1991)
Educational

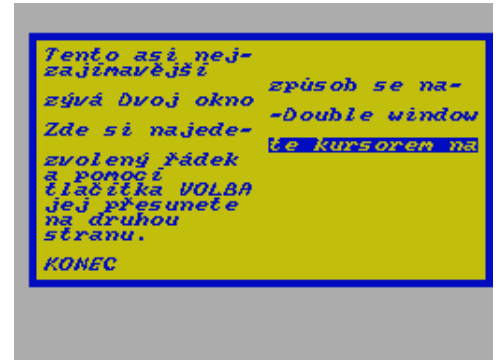

Abakus (.)
Educational

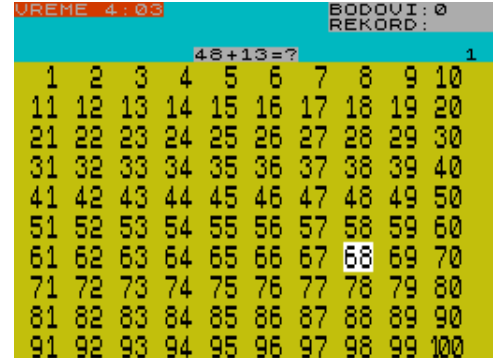

Abakus (Anwi PJP TLS,1984)
Simulation

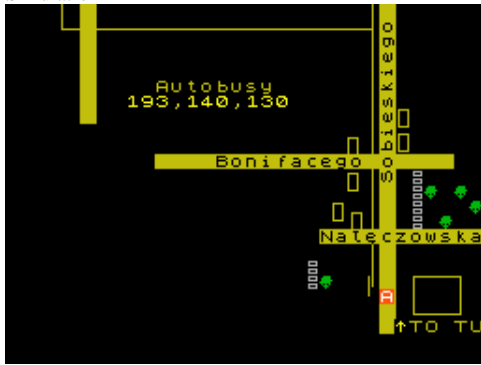

ABC Draw (Arh. Zivotic,) Utility: Drawing

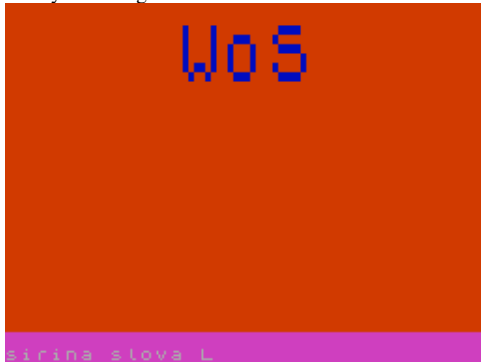

Abington (,) Text Adventure

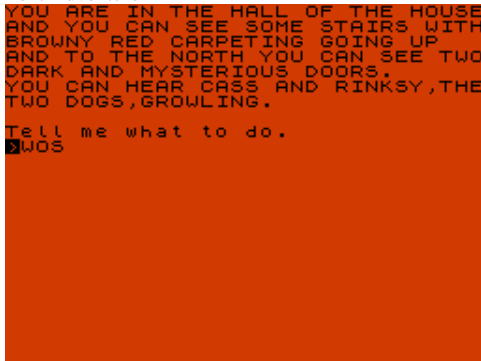

Abu Simbel Profanation (Dinamic Software,1985)
Arcade Adventure



Academial Patience (Tiger's Claw,) Board/Card Game

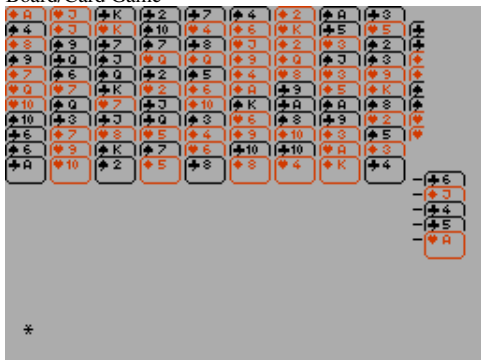

Abbreviations (Teacher's Pet Software,1988)
Educational

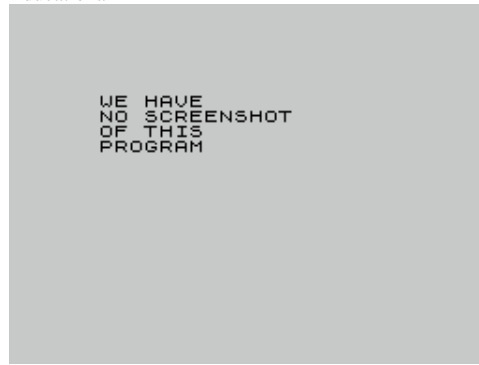

A, B, C ... Lift-Off! (Longman Software,1983)
Educational

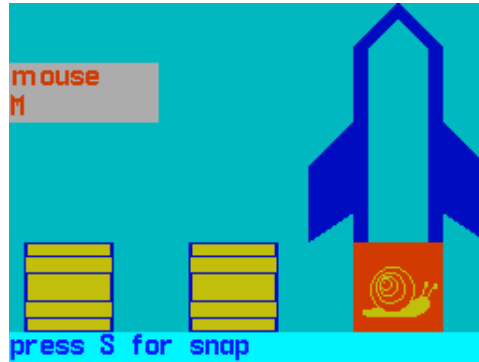

Abracadabra (Procin Soft Line,1988)
Text Adventure



Abwehr (Werner Spahl,1983)
Arcade

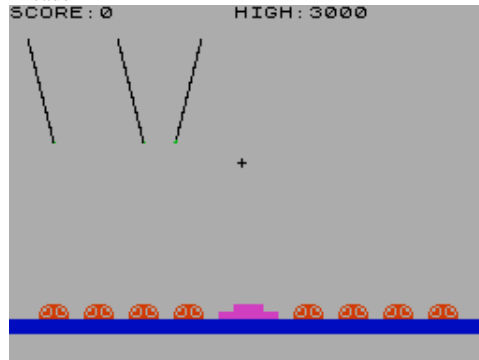

Academias (Sussex Software,1984)
Educational



ABC (Artic Computing Ltd,1983)
Educational

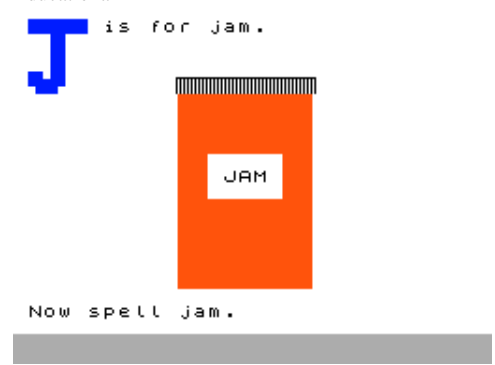

Abe's Mission: Escape (Brothers,2002)
Arcade Adventure

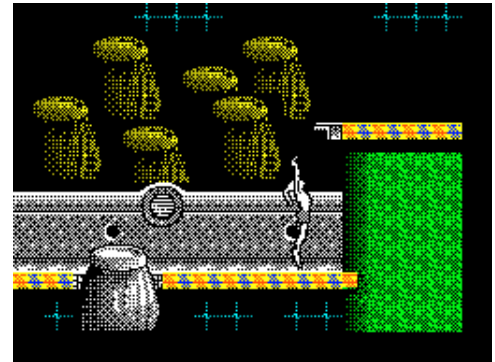

A-B Side (Softhouse Ltd,1996)
Utility



Abyss (CCS,1984)
Text Adventure



Academy (CRL Group PLC,1987)
Arcade



Accelerator (Century City Software Ltd,1984)

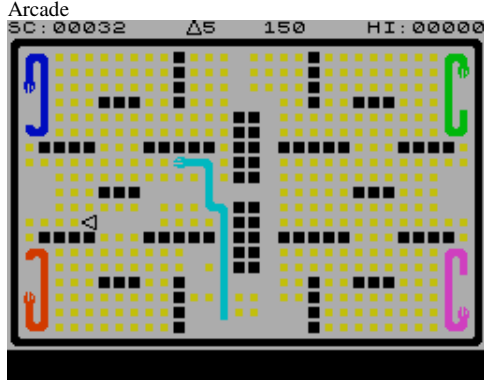

Account Management System (Fulwood Software,1984)
Utility



Ace 1 + 2 (Encore,1987)
Compilation



Ace in the H.O.L.E. (Kayde Software Ltd,1983)
Text Adventure

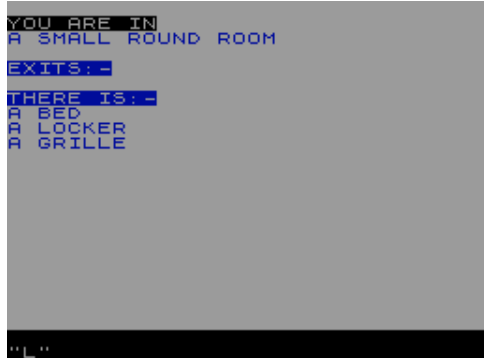

Aces High (Spectrum Computing,1983)
Simulation



Accidente (Video Spectrum,1984)



Accounts Spectrum (Hestacrest Business Software,1983)
Utility



ACE 2: The Ultimate Head to Head Conflict (Cascade Games Ltd,1987) Simulation



Ace Low (CCS,1983)
Board/Card Game

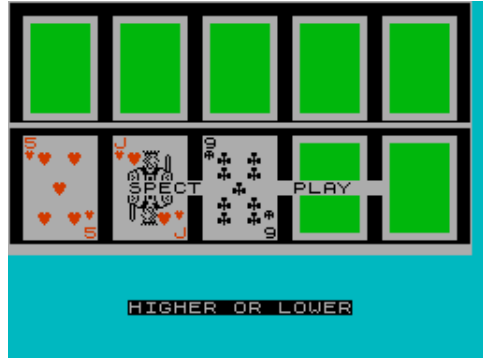

Acheton (Topologika,1988)
Text Adventure



Account (Aackosoft,1984)

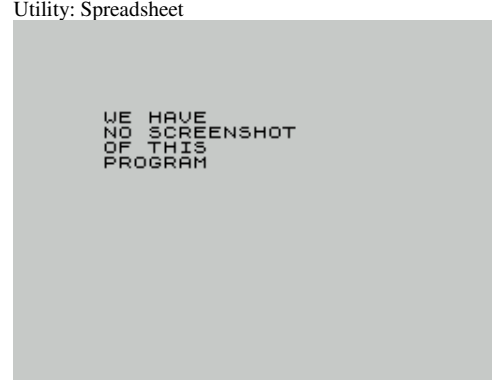

ACE (Cascade Games Ltd,1986)
Simulation



ACE 2088 (Cascade Games Ltd,1988)
Arcade



Ace of Aces (US Gold Ltd,1986)
Arcade

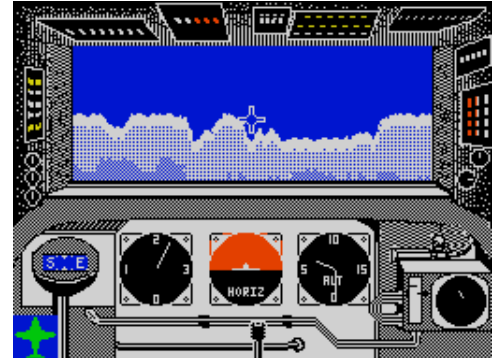

Achus Babilonia (Penazo Soft,1993)
Text Adventure



Acid (Denis & Gandalf Software,1986)
Utility: Screen Manipulation



Ack Ack Attack (ZX Computing,1984)
Arcade



Acorazado, El (Zafiro Software Division,)
Arcade



Acoustic Dreams (The Gasman,1997)
Scene Demo



Across the Ravine (Granada Publishing,1983)
Arcade

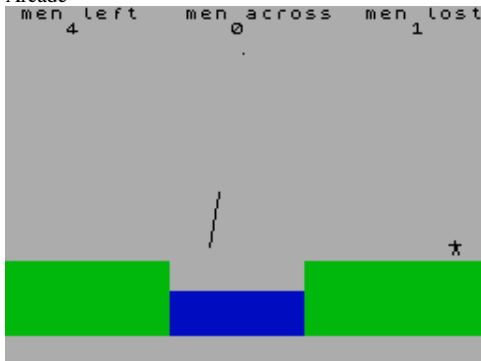

Acid Andy (The United Minds,1994)
Scene Demo



AC Linear Circuit Analysis (Number One
Systems,1984)
Utility: Electronics



Acorn's Quest (AH Software,1984)
Text Adventure

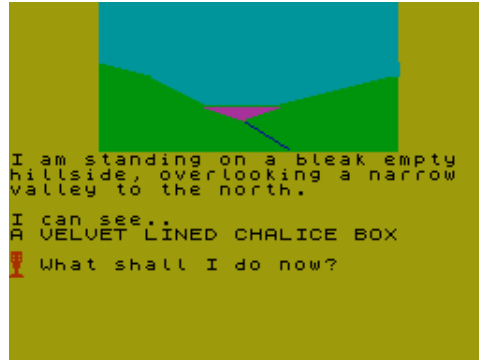

Acro Jet (US Gold Ltd,1986)
Simulation



Action (Megacode,1996)
Scene Demo

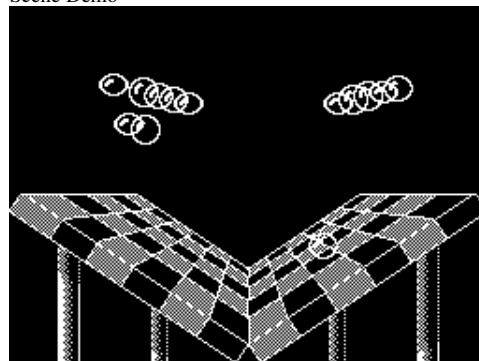

Acid Killer (New Frontier,)
Arcade



Acme Glass Cube (Iolo Davidson,1982)
Board/Card Game



Acorralado (MicroHobby,1985)
Arcade



Acrojet - Bonus Game With Breakthru (US Gold
Ltd,1986)
Simulation



Action Biker (Mastertronic Ltd,1985)
Arcade

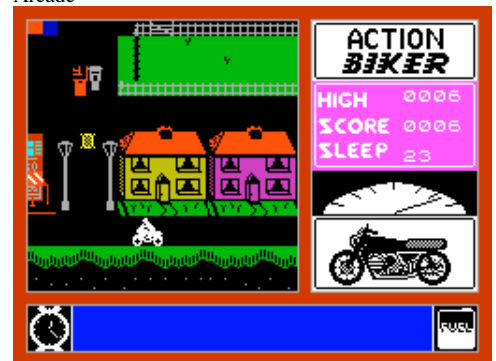

Action Countdown (Kixx,1989)
Compilation



Action Fighter (Firebird Software Ltd,1989)
Arcade



Action Pack (Prism Leisure Corporation PLC,1990)
Compilation

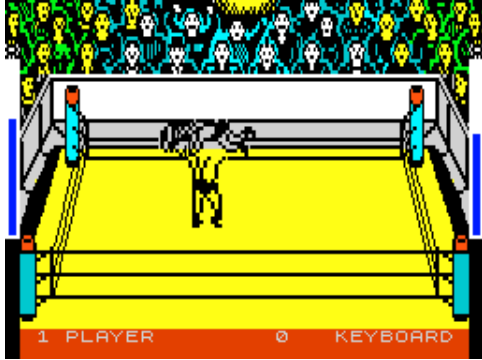

Action Pack 3 (Alligata Software Ltd,1987)
Compilation



Action Stations (Soft Sell,1983)
Board/Card Game



Action Double (Challenge Software,1991)
Compilation

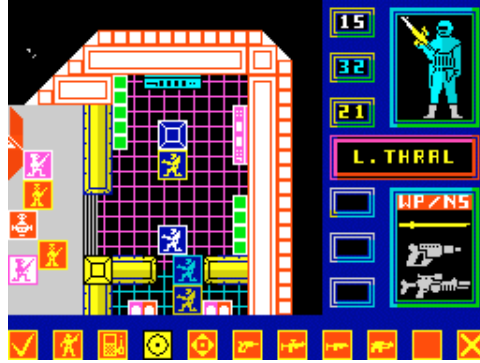

Action Force (Virgin Games Ltd,1987)
Arcade



Action Pack 1 (Alligata Software Ltd,1986)
Compilation



Action Reflex (Mirrorsoft Ltd,1986)
Arcade



Active Computer Learning (Express Marketing Ltd,1984)
Educational



Action Farce II (Crash,1989)
Arcade

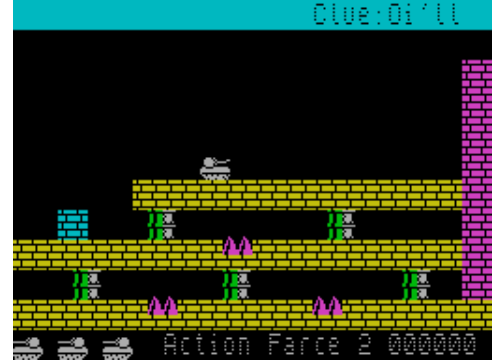

Action Force II (Virgin Mastertronic Ltd,1987)
Arcade

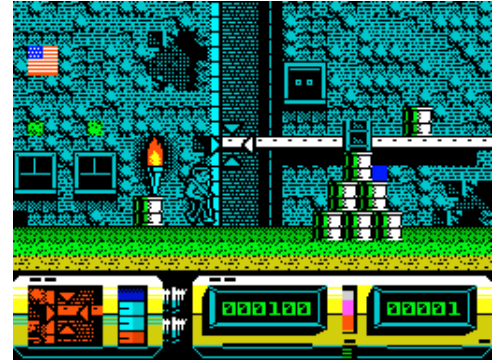

Action Pack 2 (Alligata Software Ltd,1986)
Compilation



Action Replay (Design Design Software,1986)
Compilation

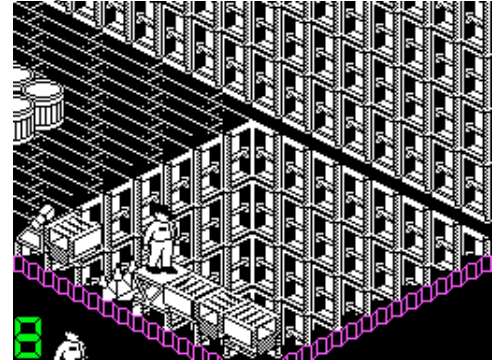

Acua-Tor (MicroHobby,1985)
Arcade



Adaptador S.I.T.I. (Ventamatic,1985)
Utility

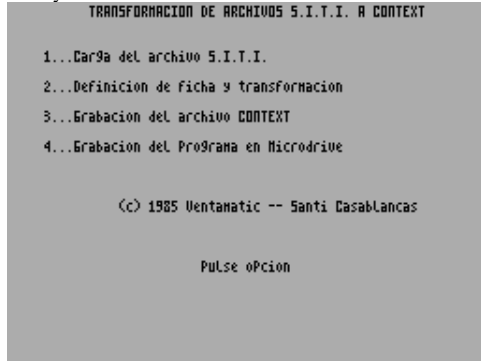

Addams Family, The (Ocean Software Ltd,1991)
Arcade Adventure



Adder Game (Panda Software,1982)
Arcade

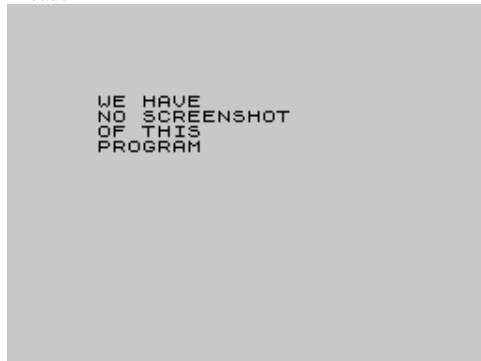

Adding and Subtracting (Widgit Software Ltd,1983)
Educational

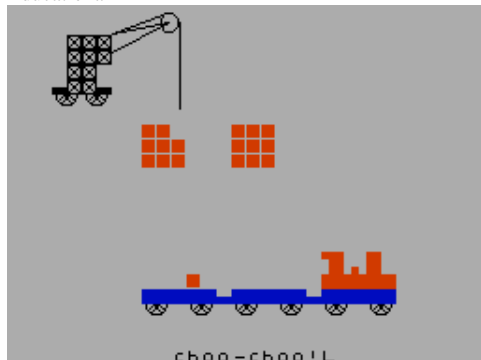

Adidas Championship Football (Ocean Software Ltd,1990)
Sport



Ad Astra (Gargoyle Games,1984)
Arcade



Adder (16/48 Tape Magazine,1984)
Educational



Addictaball (Alligata Software Ltd.)
Arcade



Address Manager (Oxford Computer Publishing,1985)
Utility: Database



Adidas Championship Tie-Break (Ocean Software Ltd,1990)
Sport

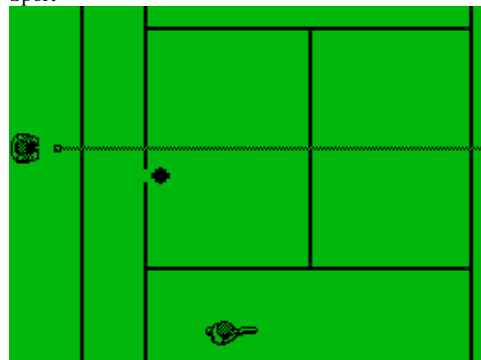

Addaladda (Contrast Software,1983)
Arcade



Adder Attack (Mogul Communications Ltd,1983)
Arcade

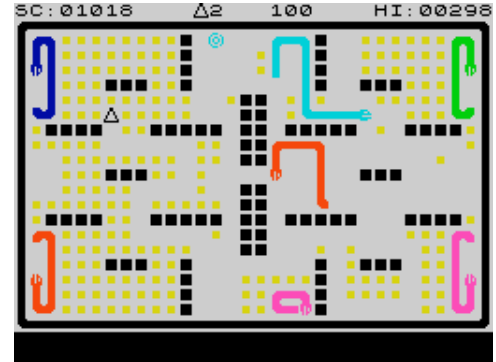

Addicta Pack (Prism Leisure Corporation PLC.)
Compilation



Add-Venture (AWA Software,1983)
Educational

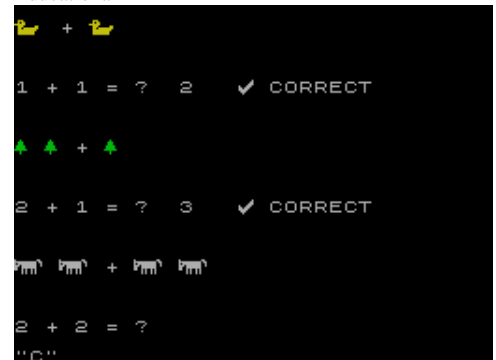

Adivina Adivinanza (Software Editores,1986)
Board/Card Game



Adivinalo (MicroHobby,1985)
Arcade



AD lister (,)

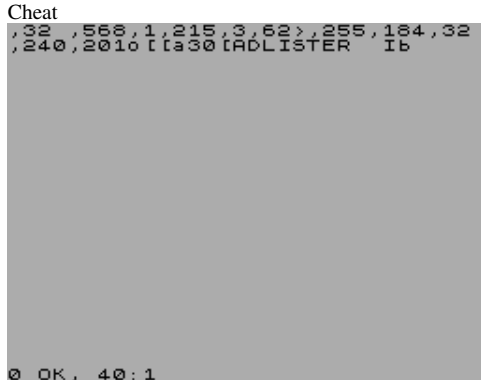

Adressenkartei (,)
Utility: Spreadsheet

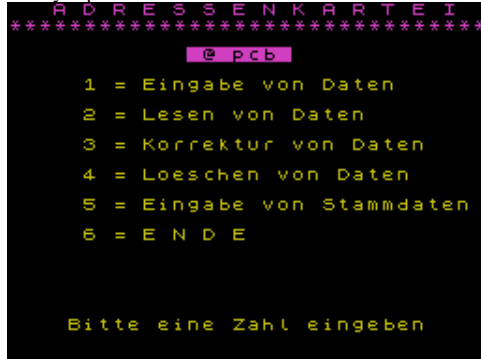

Advanced Art Studio (Rainbird Software Ltd,1986)
Utility: Drawing



Advanced Lawnmower Simulator II (J. Aron Software Ltd,1990) Simulation

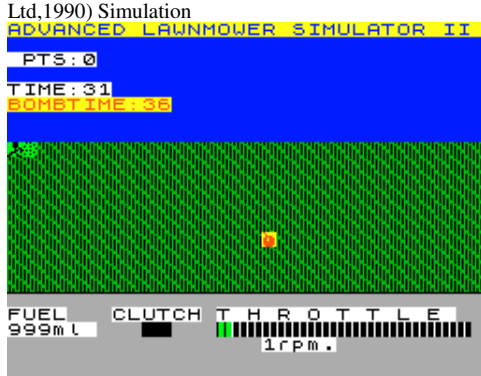

Advanced Mathematics (WH Smith,1983)
Educational



Adivinar el Refran (Software Editores,1986)
Board/Card Game



Admiral (Ice Group,1998)
Board/Card Game

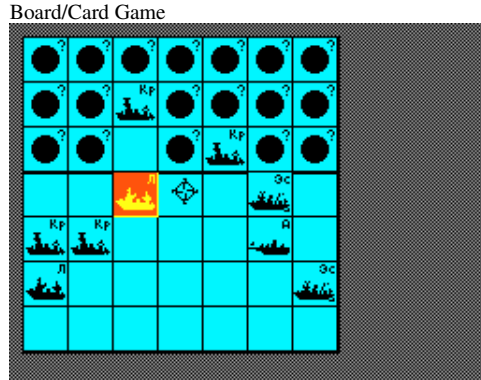

Adressenverwaltung (Horst Weigand,1984)
Utility: Database

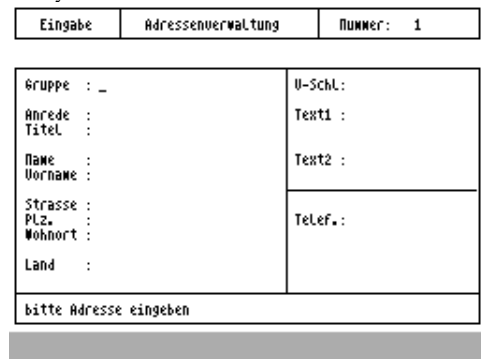

Advanced Graphics with the Sinclair ZX Spectrum (Papermac,1983) Compilation



Advanced Lawnmower Simulator II (J. Aron Software Ltd,1990) Simulation

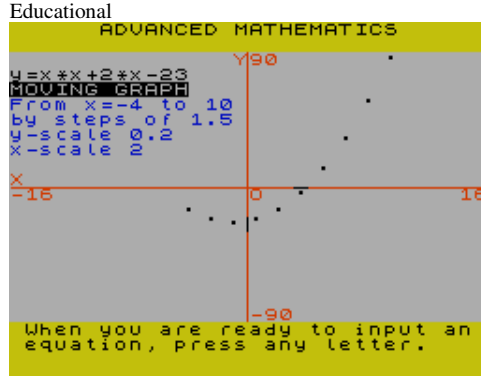

Advanced Mathematics (WH Smith,1983)
Educational



Adivino (LAR Software,1983)
Music



Admiral Graf Spee (Temptation Software,1982)
Strategy



Adultia (,)

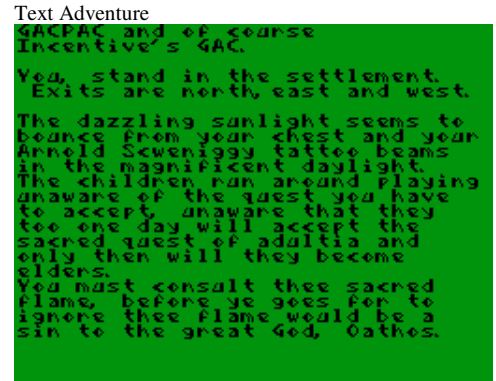

Advanced Lawnmower Simulator (Your Sinclair,1988)
Simulation

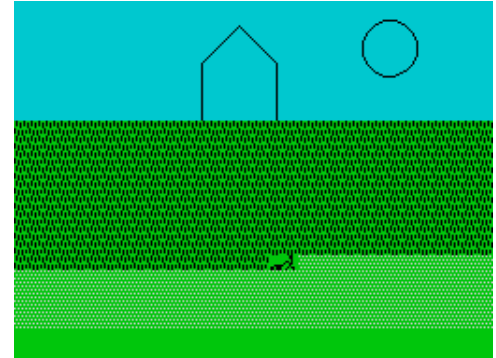

Advanced Milkfloat Simulator, The (Stuart Brady,1998)

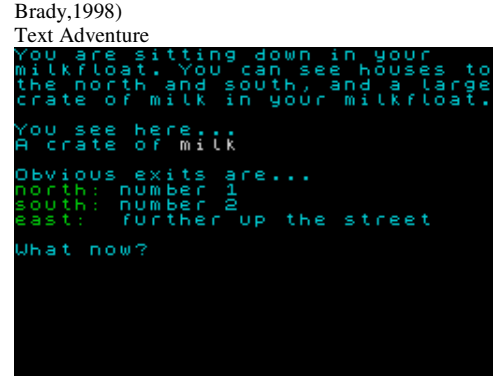

Advanced Milkfloat Simulator, The (Stuart Brady,1998)



Advanced Patience (Tiger's Claw,1994)
Board/Card Game



Advance to Mayfair (Amazing Games,1985)
Board/Card Game



Adventure (Crowther & Woods,1984)
Text Adventure



Adventure 1 (Abersoft,1982)
Text Adventure

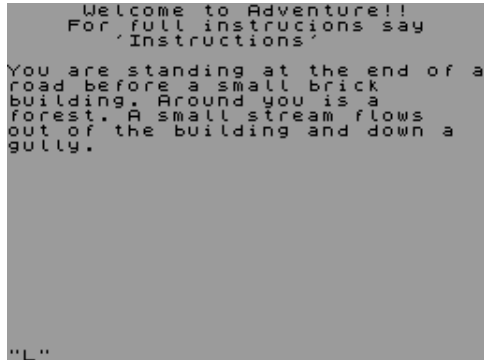

Adventure 2: Politico (D.J. Moody,1995)
Strategy



Advanced Pinball Simulator (Code Masters Ltd,1990)
Arcade

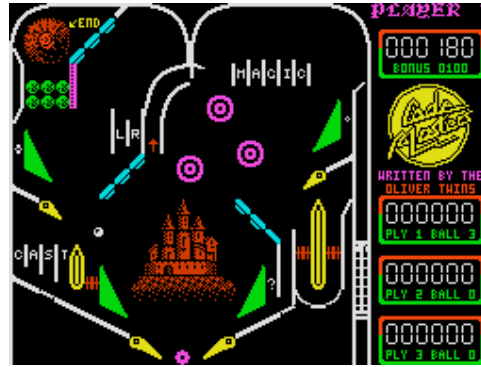

Advent (16/48 Tape Magazine,1985)
Arcade Adventure



Adventure (D.J. Moody,)
Strategy



Adventure 100 (Hyperion Software,)
Text Adventure

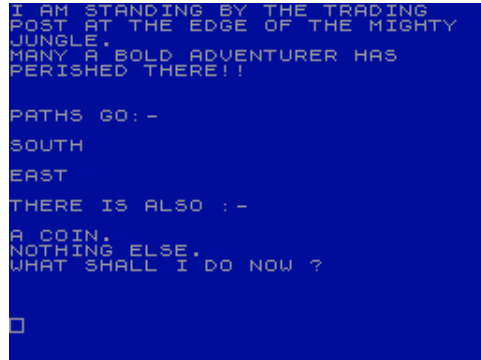

Adventure 200 (Foilkade Ltd,1982)
Text Adventure

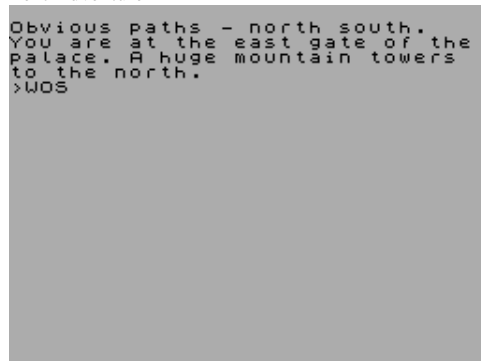

Advanced Soccer Simulator (Mastertronic Plus,1989)
Simulation

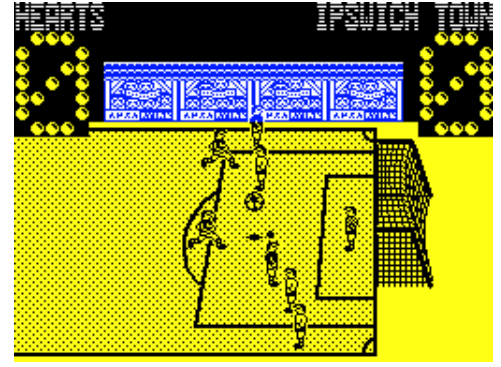

Adventure (Adventuresoft UK Ltd,1985)
Text Adventure



Adventure (Micro Gold,1983)
Text Adventure

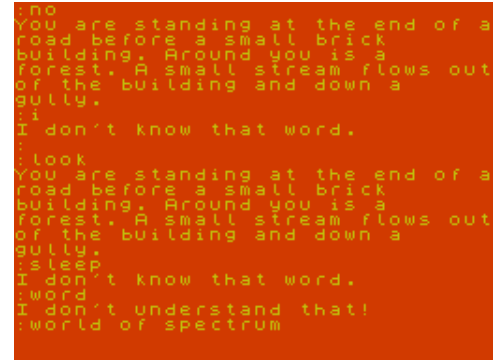

Adventure 10 Pack (Psychaedelic Hedgehog Software,1991)
Compilation

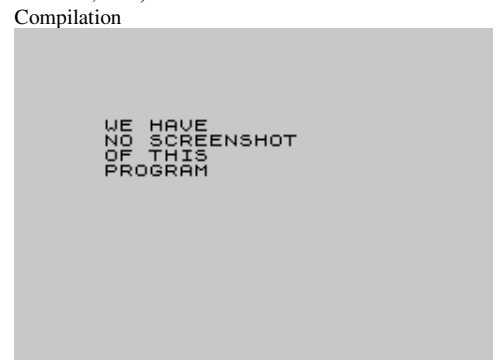

Adventure 3: The Satan Crystals (D.J. Moody,)
Strategy

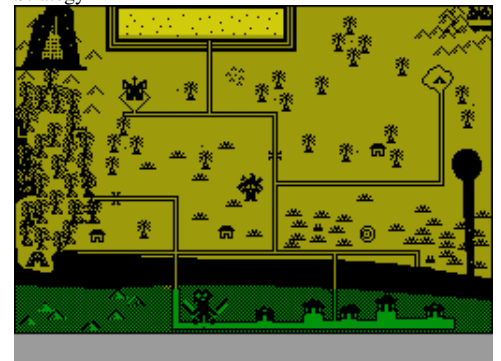

Adventure 4 (D.J. Moody,) Strategy



Adventure A: Planet of Death (Artic Computing Ltd,1982)

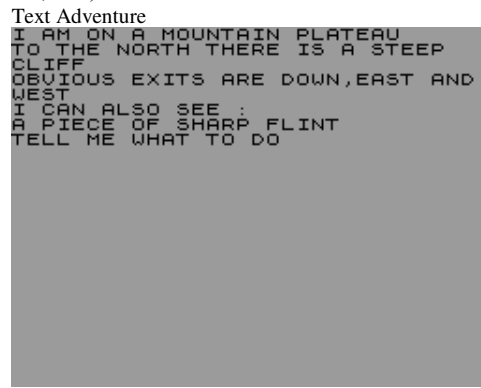

Adventure B: Inca Curse (Artic Computing Ltd,1982)

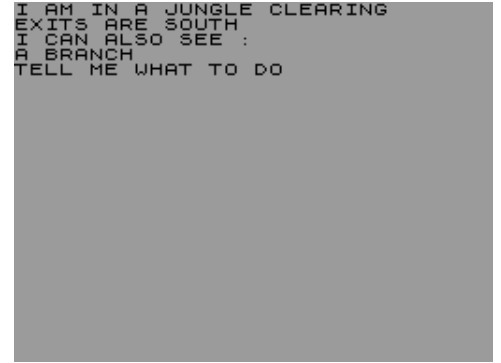

Adventure Builder System (Tartan Software,1987) Text Adventure Development Tool

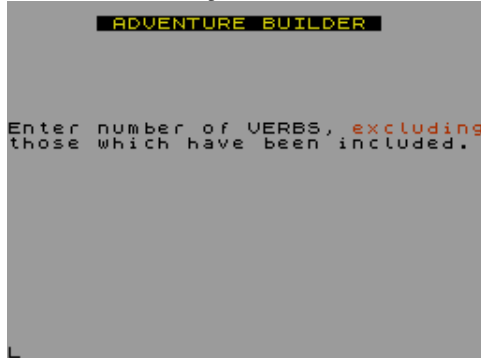

Adventure C: Ship of Doom (Artic Computing Ltd,1982) Text Adventure

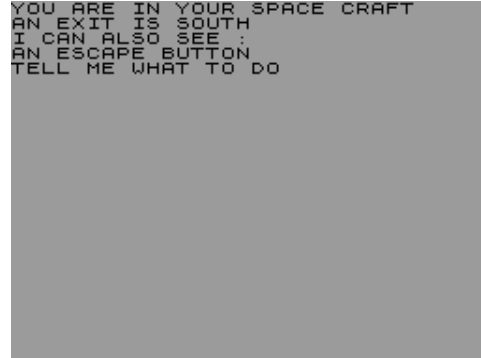

Adventure D: Espionage Island (Artic Computing Ltd,1982) Text Adventure

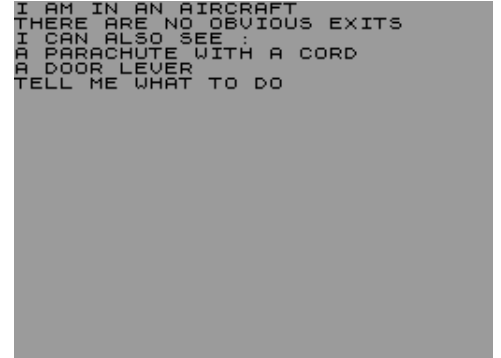

Adventure E: The Golden Apple (Artic Computing Ltd,1983)

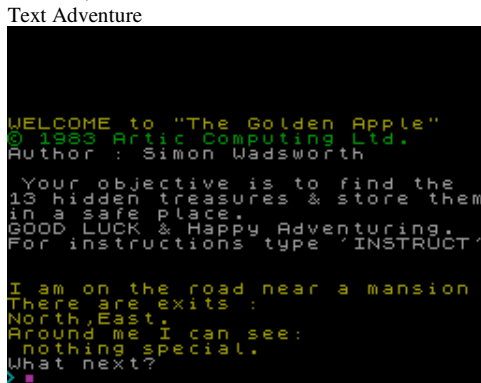

Adventure F: Eye of Bain, The (Artic Computing Ltd,1984)

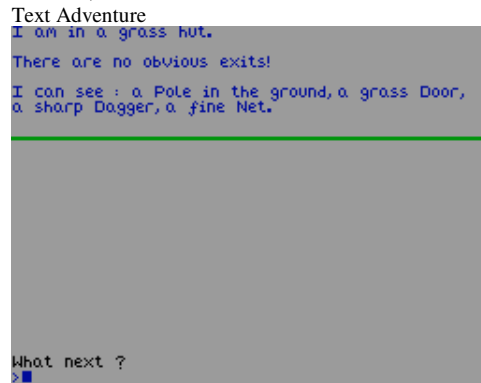

Adventure G: Ground Zero (Artic Computing Ltd,1984)

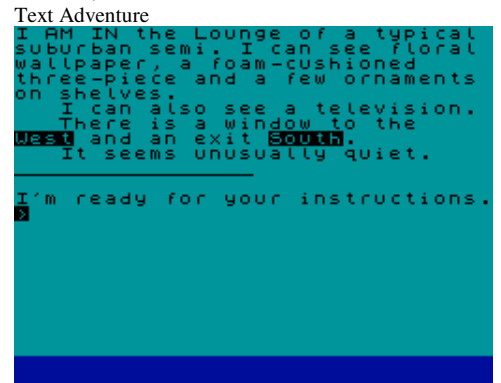

Adventure Game Freak, The (Spectrum Computing,1984) Demo



Adventure Games Pack (Psychaedelic Hedgehog Software,1992) Compilation



Adventure H: Robin Hood (Artic Computing Ltd,1985)

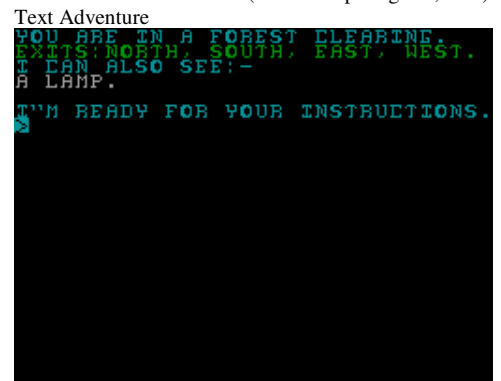

Adventure Holiday (L'Ensouleiado Software,1985) Text Adventure



Adventure in Bristol (Garry Lancaster,1985) Text Adventure

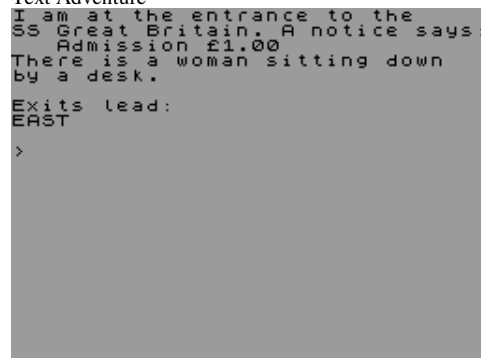

Adventure Island (Contrast Software,1983) Strategy

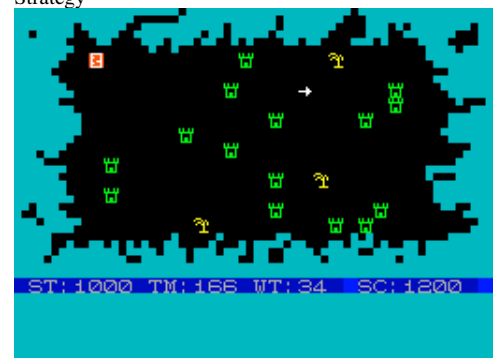

Adventure Island + Munchman + Outline (Contrast Software,1983) Compilation



Adventure Probe Offer Tape (The Guild,) Compilation



Adventurer's Nightmare (Wicosoft,1983) Text Adventure

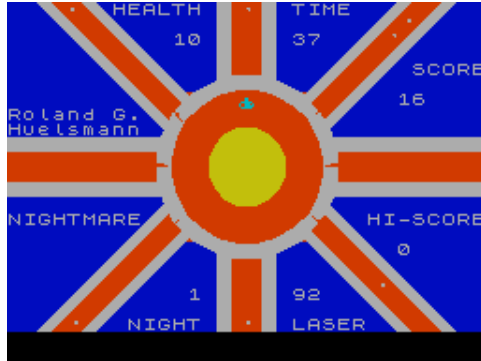

Adventures of Barsak the Dwarf (Gilsoft International,1984) Text Adventure

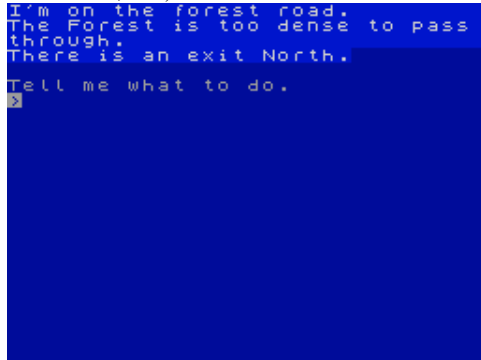

Adventures of Brian the Bold, The + Survival (Central Solutions,1985) Compilation

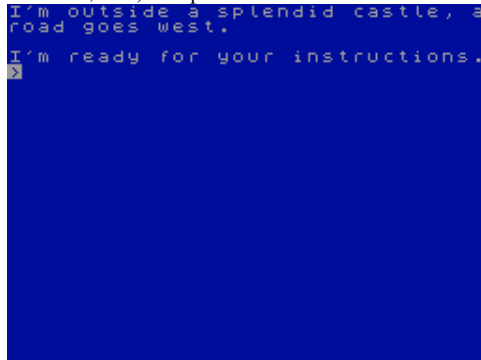

Adventureland (Adventure International,1985) Text Adventure



Adventure Quest (Level 9 Computing Ltd,1983) Text Adventure

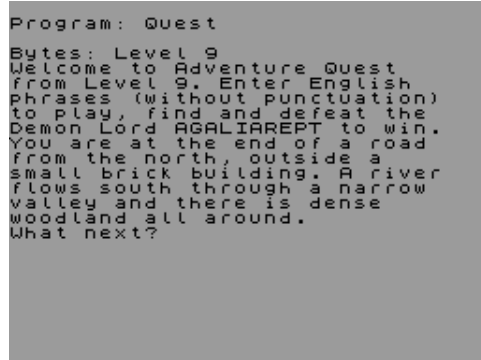

Adventurer, The (Shaw Brothers,1989) Arcade



Adventures of Bond, Basildon Bond, The (Probe Software Ltd,) Text Adventure



Adventures of Buratino (Copper Feet,1993) Arcade Adventure



Adventure Playground (Widgit Software Ltd,1984) Compilation



Adventurer (Proxima Software,1991) Arcade Adventure

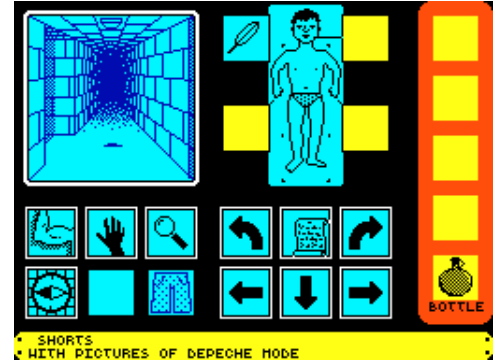

Adventures in the Lost Valley (Mega-Soft [2],) Text Adventure

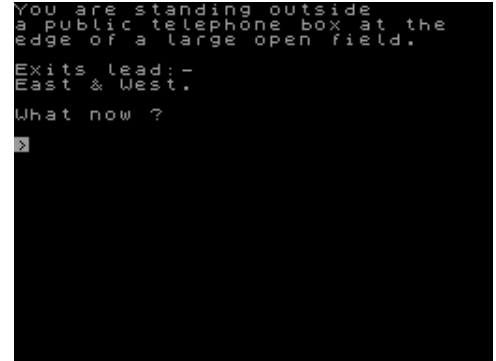

Adventures of Brian the Bold, The (Central Solutions,1985) Text Adventure

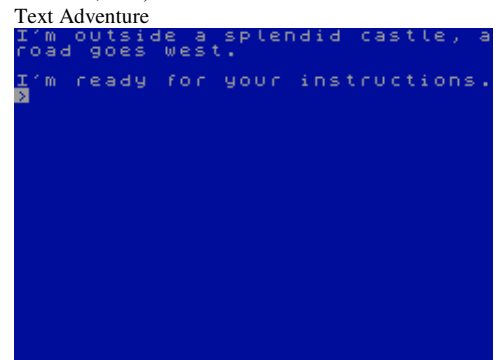

Adventures of Sid Spider, The (David Pegg,2002) Arcade

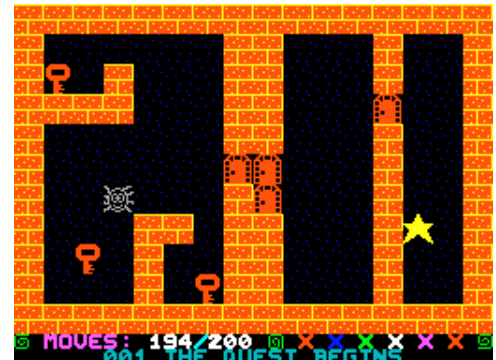

Adventures of St. Bernard, The (Carnell Software,1983)
Arcade Adventure



SCORE:000160 HI:000000 LIVES:2

Advertising Display Utility (Spectrum Computing,1984)
Utility: BASIC Related



AeroBirds (Compuiter Soft,2006)
Arcade



Afghan Attack (Southern Software,1985)
Text Adventure

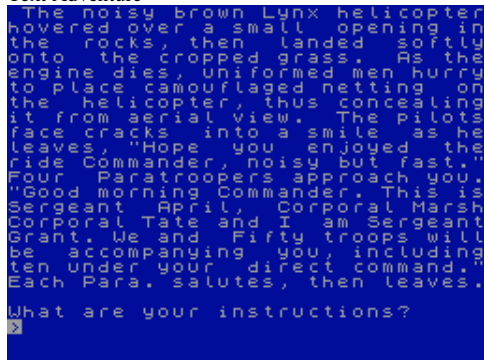

African Seeds (ZX Computing,1985)
Arcade

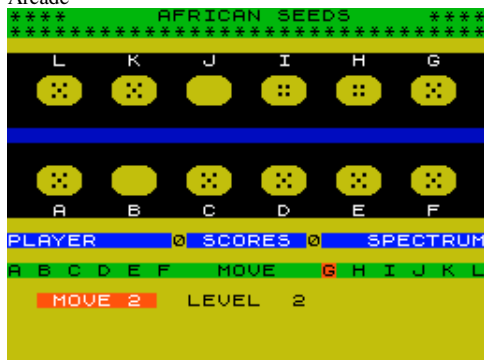

Adventure Tape 1 (Simon Wood,1989)
Compilation



Aegean Voyage (Spinnaker Software Corporation,1984)
Arcade



Aerofoil Directory (Placet Software,1983)
Utility



Africa (Phantomsoft.)
Text Adventure

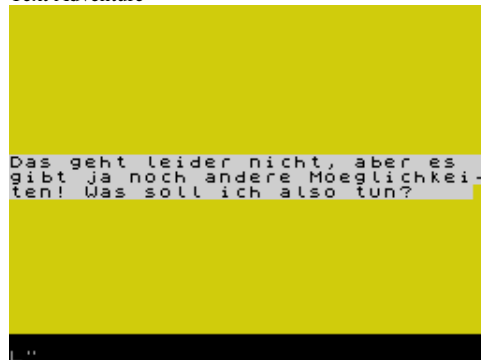

African Trail Simulator (Positive,1990)
Arcade

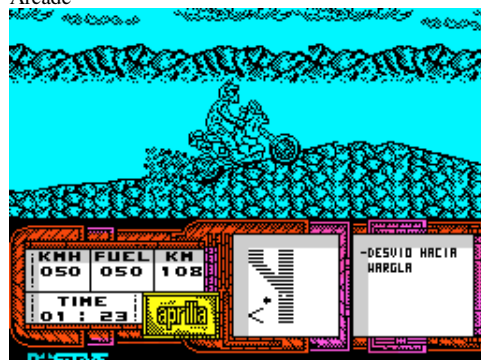

Adversary (unpublished,1984)
Board/Card Game



Aerea (JS Software,1984)
Strategy

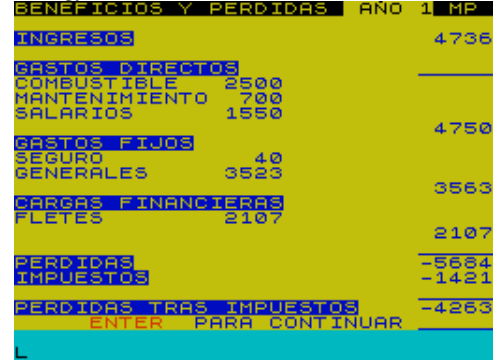

Aeromash (MicroHobby,1985)
Arcade



Africa Gardens (Gilsoft International,1984)
Text Adventure

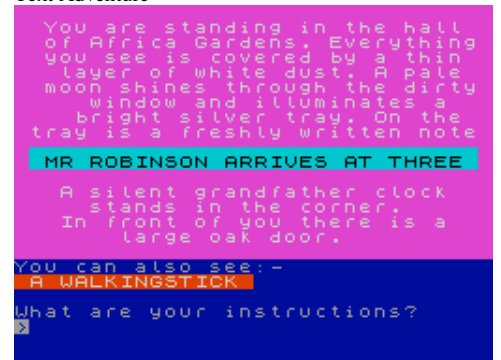

Afterburner (Activision Inc,1988)
Arcade



Aftermath (Alternative Software Ltd,1988)
Arcade



After Shock (Interceptor Micros Software,1986)

Text Adventure

```
Your Office.
Gazing out of the window across
the shattered city, the
distorted shapes of the
surrounding office blocks seem
as twisted fingers, pointing
accusingly skyward, through the
shifting veils of dust and
smoke. Numerous fires blazing
out of control; the sirens of
emergency service vehicles
wailing like tormented souls,
complete a picture more horrific
than any vision of Dante.

There is an exit East.

You can see:-
  a chair.
  a desk.
  a pen.
  a radio.
```

Agatha's Folly (Zenobi Software,1989)

Text Adventure

```
THE ENTRANCE HALL.
Glancing around at the peeling
plaster and grubby paint you
begin to wonder if you'll ever
have the time to make this place
look habitable. Even the stairs
are covered in grime, and the
rug on the floor is filthy.
Exit(s): S,E,W,N,U.
```

Agenda Noviembre (Software Editores,1986)

Utility



Agenda Personal (MicroHobby,1985)

Utility

```
AGENDA PERSONAL

NOMBRE      : IVAN
APELLIDOS   : SANCHEZ
DIRECCION   : UOS
POBLACION   : SPAIN
PROVINCIA   : GRANADA
TELEFONO    : 999
PREFIJO     : 69
DTO. POST.  : 001

ESTA TODO CORRECTO (S/N) ?.
```

Aftermath (Spectrum Computing,1985)

Text Adventure

```
You are in what seems to be a quiet,
impeccably clean store room, way
below the ground. There are massive
steel pillars supporting the room
above.

READILY VISIBLE OBJECTS ARE:
> A strong steel shovel. An anti-radiation suit.

> O.K. It's done.

OBVIOUS EXITS: Up.

What next?>WOSL
```

After the Fire (Channel 8 Software,1984)

Text Adventure

```
WE HAVE
NO SCREENSHOT
OF THIS
PROGRAM
```

Agenda (DIMensionNEW/Ideologic S.A.,1984)

Utility

```
MENU AGENDA
1. -ALTA DE DIRECCION
2. -BAJA DE DIRECCION
3. -BUSCAR NOMBRE
4. -MODIFICAR
5. -CALENDARIO PERPETUO
6. -SANTORAL
0. -GRABAR PROG+DATOS

introduce una opcion
```

Agenda Octubre (Software Editores,1986)

Utility



Agent 99 (Alkohol Soft,1988)

Text Adventure

```
M-ZOBER      S-SEVER      O-OPIS
Z-ZAPAD      U-POUZI     U-UYCHOD
P-POLOZ      J-JUH        I-INVENTAR

CAS 60

NACHADZAS SA VO USTUPNEJ MALE.
OKOLO TEBA SU ROZNE MODERNE AU-
TOMATY (ANI NEVIES NACO SLUZIA),
ZO STROPU SI TA PREZERA OBJEKTIVU
KAMERY.

MOZES IST NA :
SEVER ZAPAD UYCHOD
VIDIS: NIC ZAUJIMAVEHO

CO TERAZ ? C
```

Afteroids (Zigurat Software,1988)

Arcade

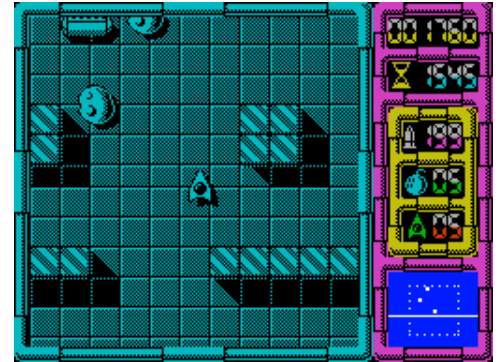

After the War (Dinamic Software,1989)

Arcade



Agenda Electronica, La (MicroHobby,1984)

Utility: Drawing



Agenda Personal (Ediciones y Textos S.A.,1985)

Utility



Agent Orange (A'nF Software,1987)

Arcade

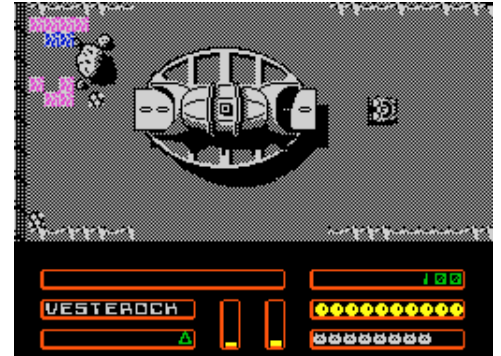

Agent X (Mastertronic Ltd,1986)
Arcade

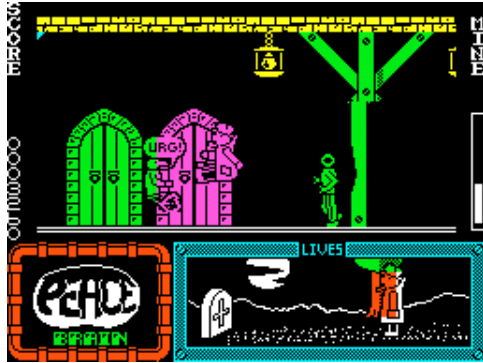

Agony Preview (Lodz City Coders,1993)
Scene Demo



Ahhh!! (CRL Group PLC,1984)
Arcade



Airbase Invader (CP Software,1984)
Arcade



Aircraft (Piper Books Ltd,1984)
Simulation



Agent X II (Mastertronic Ltd,1987)
Arcade



Ag Piton (Aguev E.,)
Arcade



Ahorcado, El (MicroHobby,1985)
Board/Card Game



Airborne Ranger (Microprose Software Ltd,1988)
Arcade



Air Defence (CCS,1985)
Strategy

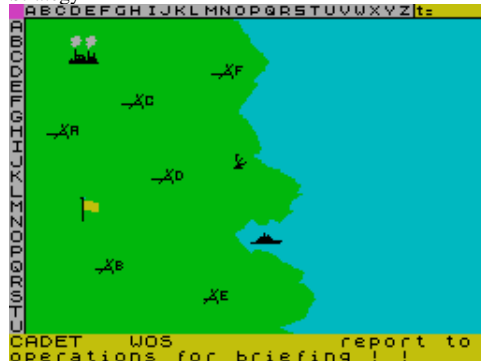

Agonia AY Demo (K3L Corp,1995)
Scene Demo



Ah Diddums (Imagine Software Ltd,1983)
Arcade



Air Attack (MicroHobby,1985)
Arcade



Airbrush (Soft Hits,1983)
Arcade



Air Fire (Rebit Soft Bank,)
Arcade



Airline (CCS,1982)
Simulation



Airport '82 (JRS Software Ltd,1982)
Arcade

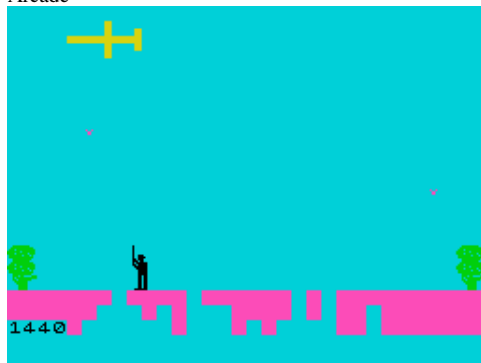

Air-Sea Supremacy (Ubi Soft Ltd.)
Compilation

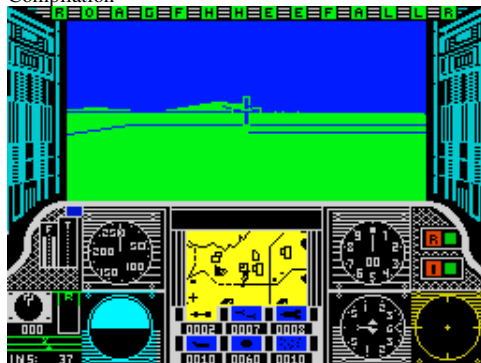

Air Traffic Control (Mikro-Gen Ltd,1984)
Simulation

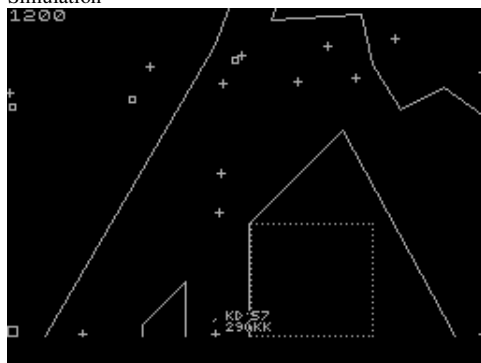

Ajedrez (MicroHobby,1985)
Board/Card Game



Airliner (Protek Computing Ltd,1982)
Simulation



Air-Raid (CCS,1983)
Arcade

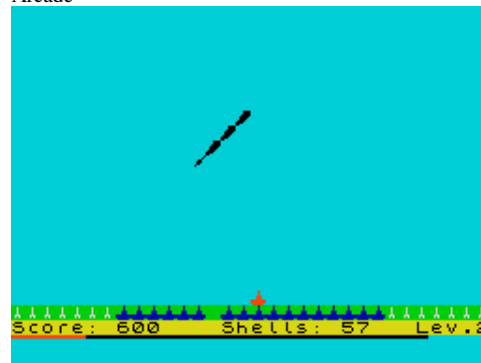

Air Space (Visual,1988)
Scene Demo



Airwolf (Elite Systems Ltd,1984)
Arcade



Ajedrez (Patxi Projects,1985)
Board/Card Game



Air on a G String (Garry Rowland,)
Music



Air Raid (Sinclair Programs,1984)
Arcade



Airspeeder (Friedrich Zohmann,)
Arcade

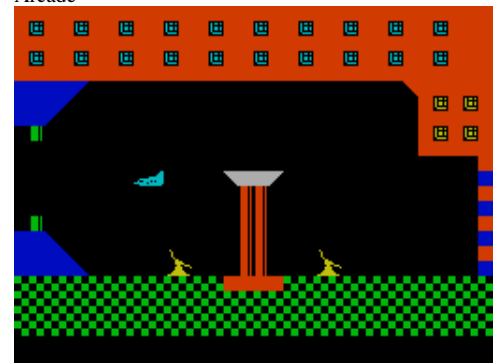

Airwolf II (Encore,1986)
Arcade



Ajedrez Karpov Profesional (Microparadise Software,1984)
Board/Card Game



Aj-Mu-Ku Loto (Ribic Samir/Emir Kacic,1987)

Utility: Mathematics

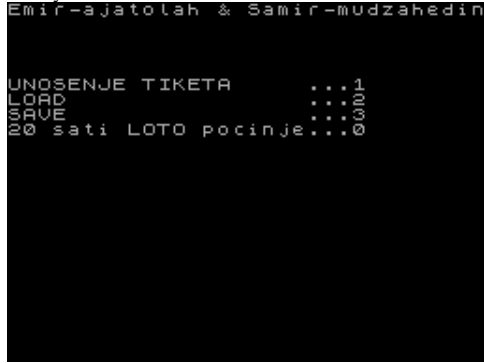

Akcionar II (INFO Soft,1990)

Strategy



Aktenzeichen Mohn (B. Bartis,1985)

Text Adventure



Alaska (.)

Arcade

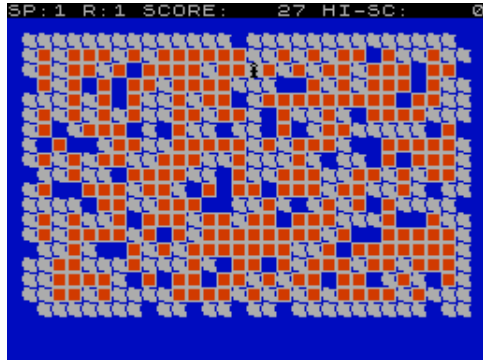

Alcatraz Harry 2: The Doomsday Mission (Scorpio Gamesworld,1984)

Arcade Adventure

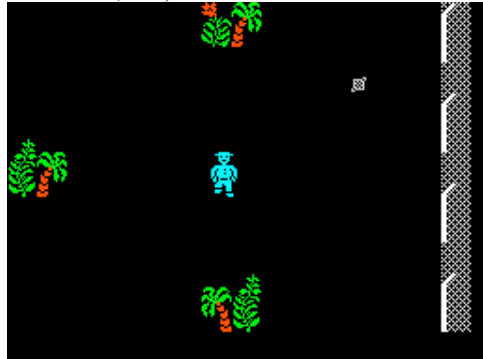

Akbarr (Ardent,1991)

Text Adventure

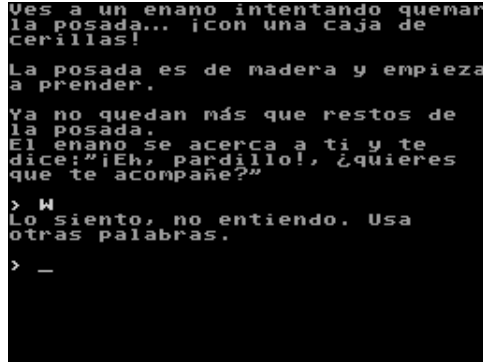

Akerico (Crazy Soft,2004)

Arcade

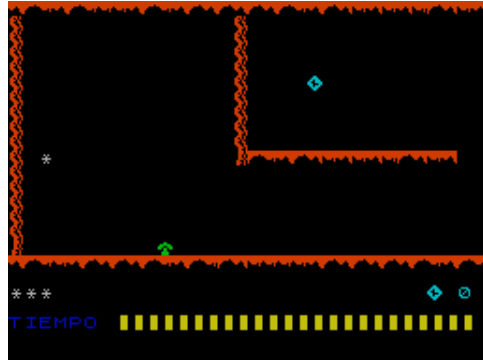

Aladdin's Cave (Artic Computing Ltd,1985)

Arcade



Album Platino (Serma Software,1987)

Compilation



Alchemist (Imagine Software Ltd,1983)

Arcade



Akcionar (Proxima Software,)

Arcade



Aknadach (Proxima Software,1990)

Board/Card Game

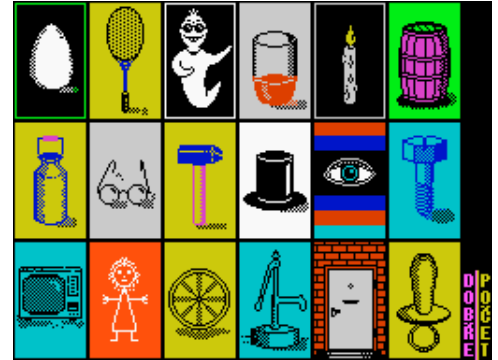

Alarma en la Base (Zafiro Software Division,)

Arcade



Alcatraz Harry (Mastertronic Ltd,1984)

Arcade Adventure



AlchNews 01 (Alchemist Research,1991)

Covertape

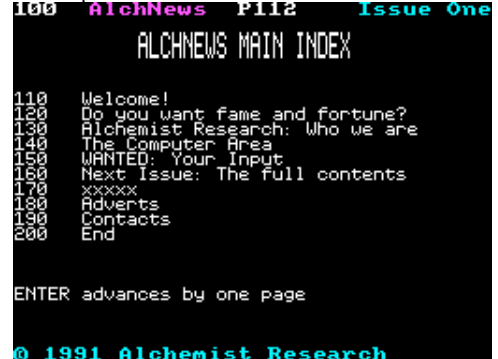

AlchNews 02 (Alchemist Research,1992)

```
Covertape
100 ALCHNEWS2 P111 01.27:28 PM
ALCHNEWS 48 BASIC
101 Front Ends and News
115 Mini Mag: What it is
120 Letters and Soapbox
130 Hints, Tips and Pokes
145 More from PAW
150 The Trading Post
160 The TECH. SEC.
170 Mystic Dwellings
180 Reviews and Re-Releases
190 Next Issue
200 The End

THE CLOCK: Press ~B~ to set it

© 1992 Alchemist Research
```

AlchNews 05 (Alchemist Research,1992)

```
Covertape
100 ALCHNEWS5 P105 02.57:34 AM
ALCHNEWS AUTUMN 1992
100 Main Menu
101 Front Ends & News
110 Alchemist PD
115 A.R. in Europe
120 Adventures
130 Software Reviews
140 Tech. Sec.
150 Advertisements & Contacts
159 END
PRESS ~X~ TO COPY ©92 AR.
```

AlchNews 08 (Alchemist Research,1993)

```
Covertape
P100 A.L.C.H.N.E.W.S. Ish8
SUMMER 1993
MAIN MENU
101 Front Ends
110 New UK User Group News
120 *Spellunkler 3* Review
130 Tech. Section
140 Reviews
150 Trading Post
160 Late Items & Next Issue
Address page 163 or type * I
Next Back Page Menu Front Copy *
© 1993 Alchemist Research Ltd.
```

AlchNews 11 (Alchemist Research,1994)

```
Covertape
ALCHNEWS Issue 11
March 1994
=====
Hello and welcome to yet another "new look" AlchNews! This issue sees the introduction of a great new system, specially designed by Dominic Morris. It's loosely designed on the ENIGMA system, but is more superior with 42 column text.
The controls to move the pages are the CURSOR keys. SPACE loads up the next section of the magazine. I and P control the ink and paper colours, set these to whatever your eyes prefer! Key Z does nothing!
As it's my first time using this system, things may seem a little higgledy piggledy but please bear with me, there will be some uniformity soon!
KEYS: <A> Alch-News INK: [ ]
Z,I,P,SP PAPER: [ ]
```

AlchNews 14 (Alchemist Research,1994)

```
Covertape
*****
Dec 1994 ALCHNEWS Issue 14
*****
Ah, tis Christmas time again. No doubt all of you are tucked up nice and warm enjoying the delights of this issue whilst sipping a mild Sherry and a mince pie in the light of the christmas lights.
Well, I'm glad someone is because I'm not! Yes, it's forward planning at Alchemist Research - it's not even Hallow's Eve yet!
One thing for sure, and that it's cold. It's early October and we've already seen snow in the Peak District park near my home! So, relax and let the postman deal with the hassle of getting your software for you - Alchemist Research is the place to come for your stopping-in software and entertainment!
KEYS: <A> Alch-News INK: [ ]
Z,I,P,SP PAPER: [ ]
```

AlchNews 03 (Alchemist Research,1992)

```
Covertape
100 ALCHNEWS3 P108 12.05:53 PM
ALCHNEWS ISSUE 3.
101 Front Ends
110 Letters & Mini Mag
115 More from PAW
120 The Extended 'TECH SEC'
130 Magic Button Project (2)
140 Mystic Dwellings
150 Hints, tips 'n' pokes
160 Trading Post
165 Review: DOOMSDAY
170 Hisoft Basic support group
180 Alchemist PD
190 Next Issue
200 The End

© 1992 Alchemist Research
```

AlchNews 06 (Alchemist Research,1992)

```
Covertape
P100 ALCHNEWS 6 Winter 1992
100 Main Menu
101 Front Ends
110 Spellunkler Fanzine
120 TECH. SEC.
130 Reviews
140 Spectrum Gold
150 Adverts
156 Next Issue
157 Our Address
Use N & B to flick through pages
Next Back Page Menu Front Copy *
© 1992 Alchemist Research Ltd.
```

AlchNews 09 (Alchemist Research,1993)

```
Covertape
Sep 93 Ish 09
Alch-News
WELCOME.
Hello New Readers!
Your Letters
FREE GIFT: ZX-FX Instructions.
Review of Spectrum Products.
Alchemist PD News.
Adventures
INTERFACE: New I/O Section
Trading Post
! LOAD NEXT PART !
Use Cursor Keys, and ENTER
```

AlchNews 12 (Alchemist Research,1994)

```
Covertape
*****
Issue 12 ***** ALCHNEWS 12 ***** June 1994
*****
Welcome to issue 12 of AlchNews, the Spectrum only tape and disk magazine. I'd like to welcome all the new readers we've picked up thanks to great support from CHIC COMPUTER CLUB and SPECTRUM UK.
I'd especially like to thank those who have taken the kind words spoken by the above and sent their subscriptions without first sampling our wares. I thank you for the trust you have shown and, to repay that trust, you may like to know that although your cheques have been cashed, the monies will remain in the account, so should anything untoward ever happen, you can guarantee of your money being refunded. This also applies to any other customers. Should you not be happy with
KEYS: <A> Alch-News INK: [ ]
Z,I,P,SP PAPER: [ ]
```

AlchNews 15 (Alchemist Research,1995)

```
Covertape
Alch News
March 1995, Issue 15
Welcome one and all to the fifteenth issue of AlchNews. Thanks to all of you who helped out to make issue 14 the biggest yet-let's see if we can break that record this time!
There's a big emphasis on tutorials and hardware this issue as many of you requested more of it-no doubt the clear and easy to follow guides are a big hit!
Disk owners will have something of a bonus on their disks, the remaining space is filled with software. Simply load MENU for more details. Ed.
```

AlchNews 04 (Alchemist Research,1992)

```
Covertape
100 ALCHNEWS4 P113 00.13:39 PM
ALCHNEWS SUMMER '92
101 Ed's Comments
103 Front Ends and News
107 Our Address
110 Alchemist Research Data
120 Alchemist PD
130 Want a job?
140 Tech. Sec.
150 END
Press ~B~ to Set Clock

© 1992 Alchemist Research
```

AlchNews 07 (Alchemist Research,1993)

```
Covertape
P100 A.L.C.H.N.E.W.S. Ish7
MAIN MENU.
110 PD Section
120 Adventures
130 Technical Advice
140 Reviews
150 Special Interest Groups
160 Trading Post
170 Next Issue
Address page 159 or type * I
Next Back Page Menu Front Copy *
© 1993 Alchemist Research Ltd.
```

AlchNews 10 (Alchemist Research,1993)

```
Covertape
Dec 93 Ish 10
Alch-News
Talking Ed's
Kind Words
Free Gifts
AlchNews Prices Breakdown.
The Making Of AlchNews
Letters
Question Time.
The RASPUTIN Takeover.
Contributing to AlchNews
Alchemist Research Products.
** LOAD PART TWO. **
Use Cursor Keys, and ENTER
```

AlchNews 13 (Alchemist Research,1994)

```
Covertape
*****
ALCHNEWS 13 September 1994
*****
It's been a busy quarter at Alchemist Research, and a very hot one - hasn't summer been good? We had a few heavy thunderstorms 'oop North', restricting the use of the computer equipment, but things are cooling a little now.
It's been a busy time for mail, too, but not in the positive sense. In mid-July, Alchemist Research was the 'luck' recipient of junk mail - terrible junk mail at that! One of them was a special discount on a package of 'wonderful PC software', the other a once-in-a-lifetime offer for computer training. These people obviously didn't know that we don't use a PC and that as far as I, the Ed, is concerned, several years in college
KEYS: <A> Alch-News INK: [ ]
Z,I,P,SP PAPER: [ ]
```

AlchNews 16 (Alchemist Research,1995)

```
Covertape
Issue 16 June 1995
Alch News
Hi and welcome to another issue of AlchNews. Once again another packed issue with emphasis on articles and information you want to read rather than the self-promotion and laurel resting some print.
Thanks to all of you who wrote in and congratulated us on the size of the last issue, it was hard work but your kind comments make it worthwhile!
A lot of you have also wanted to get in on the action, after seeing the efforts of others you've asked how to work for the Spectrum's biggest and brightest magazine so full details are featured. Happy reading!
```

AlchNews 17 (Alchemist Research,1995)

Covertape

September 1995 Issue 17

Alch News

NINTH BIRTHDAY ISSUE!!!

Sweeping changes have hit Alchemist Research. Promotion at work has severely cut my free time and, for a while, thought Alchemist Research would have to close.

However, after hundreds of letters and calls to continue, I've come up with a solution to keep Alchemist Research going. It's going to take a lot of hard work and sacrifices, but it will be worth it. I've not spent nine years building it up for nothing.

Full details are given inside. We hope you'll continue to support us. Ed.

AlchNews 20 (Alchemist Research,1996)

Covertape

June 1996 Issue 20

Alch News

MARTYN SHERWOOD ADMITS: "I'M DESPERATE"!

In YET ANOTHER failed attempt at a complaint to a regulatory body, this time to the PRESS COMPLAINTS COMMISSION, Mr. Sherwood admitted: "I am desperate for help". His letter, as usual, was full of blatant lies and errors, which can all be proven. His complaint was NOT acted upon (again!!)

Other Prism-foul ups this quarter include attacks from at least a dozen groups for his unsolicited letters and lies, and he has recently come under more serious fire from BOB BRENCHLEY of FORNAT / INDUG for twisting a piece of news into an anti-format piece, which also contained a "BLATANT LIE". More and more are tasting the bitter wrath of Sherwood - friend or foe!

AlchNews 23 (Alchemist Research,1997)

Covertape

Issue 23

Alch News

03/97

A.R. REPORTED - YET AGAIN!

In December 1996, we found out that a very sad individual in HARWICHSHIRE had reported us to both TRADING STANDARDS and the ADVERTISING STANDARDS AUTHORITY, now bringing the total to FIVE.

Although having a duty to check the complaint, they found NO FAULTS with ANY PART of Alchemist Research, just like with the previous complaints, even though this person told lies in his letter. I don't need to tell you who is wasting everyone's time and money - YOUR taxes pay for it - making these complaints but although we have ended fights, this sad loser just won't let the matter drop. In late 1996, we had to report Martyn Sherwood's FATHER to the police for allegedly making threats against the Editor. (Src: L.Garland). The incident is now on file. The Ed.

AlchNews 26 (Alchemist Research,1998)

Covertape

Issue 26

Alch News

01/98

INTERVIEW SPECIAL

Happy new year to everyone! As you can see, AlchNews has now become 'thirdly'. Yes, sadly there will only be three issues per year, unless more assistance can be found to edit the magazine.

On a brighter note, we have some excellent articles in this issue - interviews with two of the biggest names of the Spectrum world: Chris File and Jon Kilman. We also have coverage of the last N55 show plus more O05 bugs and a very comprehensive guide to ALL Sinclair and Timex hardware.

This issue's software includes a ZX-B1 emulator for the SPECTRUM Jet Set Willy 128k and the great driving simulation HARD DRIVIN'.

The Ed.

AlchNews 29 (Alchemist Research,1999)

Covertape

Issue 29

Alch News

01/99

There's far more good news to report in this issue than the last first of which is the arrival of new magazines. AlchNews is also now well and truly up and running on the Z88.

Hardware is looking good too, thanks to the EPROM project of Kevin Gurd and Miles Binloch. We've also seen a new disk system for the Spectrum +3.

But the software side of things is becoming rather stale. There has been very little in the way of new software, except for the Z88 of course, which is still moving in leaps and bounds! But we need to hear about it. Whether you have a snippet of news or an article about something you've done, hardware you've built or software you've written, TELL US. You get a free issue for your trouble and it keeps the Spectrum going a bit longer!

The Ed.

AlchNews 18 (Alchemist Research,1995)

Covertape

Dec 95

Alch News

Happy christmas to one and all! Peace and goodwill to all men - AND Sherwood?

...Well, yes. I've decided that the problems can go on no longer and need to be sorted, and I'm obviously the one to do it. So, please read the section entitled 'THE END', even if you are not involved.

Other than that, another great issue for you, with a warm welcome to our emulator viewers. Hope you enjoy the show! Have a sood holiday. Ed.

AlchNews 21 (Alchemist Research,1996)

Covertape

Issue 21 September 1996

Alch News

1986 10th BIRTHDAY 1996

We've finally made it! Ten years ago, Alchemist Research was founded. Initially a computer group for the Sinclair QL, it moved to the Spectrum a short time later. In the next decade it blossomed into the largest electronic Spectrum magazine and software library in the world, all free of charge and profit.

Sadly, it will not be a personal celebration. A member of my family has died of leukaemia very suddenly and unexpectedly. Please accept my apologies for this shorter issue. Ed.

Dedicated to the memory of Arthur Rhodes. All my love, Andrew &

AlchNews 24 (Alchemist Research,1997)

Covertape

Alch News

24

June 1997

This issue is something of a communications special. We feature news that you can still use your UTX-5000 to access bulletin boards and even get e-mail. We're also back on line again.

We also begin several articles covering the Cambridge Z88 laptop making AlchNews the best choice for Z88 computing anywhere!

Andy Davis, Editor.

AlchNews 27 (Alchemist Research,1998)

Covertape

Issue 27

Alch News

05/98

Who would have thought it? Me back in control at Alchemist PD! When I handed over the library to Dave Fountain & Lloyd Garland, I swore it would be the end!

But don't send your tapes and orders just yet - the library has been set up on the INTERNET! There are lots of sites distributing (illegally, may I add!) games, but nobody has set up a site of PD software.

Our site is therefore legal and features some classic programs that Spectrum users have all seen, but users on the World Wide Web haven't! In return, we are converting many snapshots and NEW games, such as new Manic Miner and Jet Set Willy games.

The Ed.

AlchNews 30 (Alchemist Research,1999)

Covertape

Issue 30

Alch News

05/99

The sudden death of Malcolm Mackenzie earlier this year was a shock to us all. But it touched no one more than his family and great friend David Leabury. Our hearts and thoughts go to those who lost a great husband, father and friend.

This issue is dedicated to Malcolm, a great man who did great things for a great computer. I knew him for a good few years and enjoyed his down to earth nature, his (lengthy!) telephone calls and our meetings at the N55 shows. You were a great friend and I will miss your wisdom and advice.

The Ed.

AlchNews 19 (Alchemist Research,1996)

Covertape

Issue 19 March '96

Alch News

PRISM HAS ONLY APPROX. 20 MEMBERS!

Although AlchNews is to feature no more articles about Prism and Martyn Sherwood in it's magazine, we found that we were subject to a hate campaign to try and get rid of us.

Mr Sherwood reported us to the DATA PROTECTION REGISTRAR, for reasons known only to himself. However, we were operating within their guidelines and no action was taken.

Press CURSOR RIGHT for more...

AlchNews 22 (Alchemist Research,1996)

Covertape

Alch News

22

December 1996

Thank you for all of your cards and letters of congratulations regarding our tenth birthday. Only 40 issues until our 20th!

This issue sees our continuing support for Microdrives, machine code, the +3 and emulators, plus reports from the first N55 show in Wetherby and some great UDITCH games. Have a great Christmas.

Andy Davis, Editor.

AlchNews 25 (Alchemist Research,1997)

Covertape

Issue 25

Alch News

03/97

I'm considering whether to make AlchNews 'thirdly' (i.e. only three issues per year). The reasons are because it gives me far more time to prepare the issue. Work leaves me little free time, which I wish to spend with my new family and a sailing boat I've just bought, rather than on the PC for hours on end.

As with any changes to AlchNews, your comments are welcome and will dictate whether the change is made. There are two other changes you should know of: ASM will no longer be handling tape orders for AlchNews. We weren't happy with the way they were handling things, so 'new boy' Mick Harrop will be taking over. Good luck, sucker! The other change is that our (brief) email address has closed. More details in the NEWS section.

The Ed.

AlchNews 28 (Alchemist Research,1998)

Covertape

Issue 28

Alch News

05/98

This is the saddest issue that I've ever had the honour (duty!) of editing. For what must be the best three fanzines ever to grace our scene are now bowing out.

Whom am I speaking? CLASSIX, 8 BIT and Z8 FILES. Yes, something of a shock, I'm sure you'll agree. You probably already knew that 8 BIT was to end next year, but it will end with the next issue, which you may now already have in your possession.

So where does that leave us, paper wise? Basically, nowhere. It looks like it's down to FORNAT and CRASHED (if they ever get back into gear) and ALCHNEWS & OUTLET to keep the Z8 community alive.

The Ed.

AlchNews 31 (Alchemist Research,1999)

Covertape

Issue 31

Alch News

12/99

I cannot apologise enough for the inexcusable delay with this issue. Several factors all at once halted production for a short period - myself moving house and all my equipment packed away for the move, which was delayed. Hardly any contributions for the issue, even from the regular writers, and, virtually no Sinclair news or happenings to write about.

Hopefully, by the next issue we'll have more people mucking in to help. AlchNews is now one of the last Sinclair productions to still keep going, we need you as much as you need us.

The Ed.

AlchNews 32 (Alchemist Research,2000)
Covertape

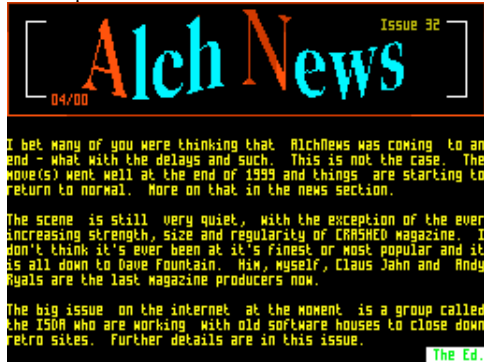

AlchNews 35 (Alchemist Research,2001)
Covertape



AlchNews 38 (Alchemist Research,2002)
Covertape



A-Level Maths (University Software,1983)
Educational



Alfa Soft: Buffalo Stance (Alfa Soft,)
Scene Demo



AlchNews 33 (Alchemist Research,2000)
Covertape



AlchNews 36 (Alchemist Research,2001)
Covertape



Ale Hop (MicroHobby,1985)
Arcade

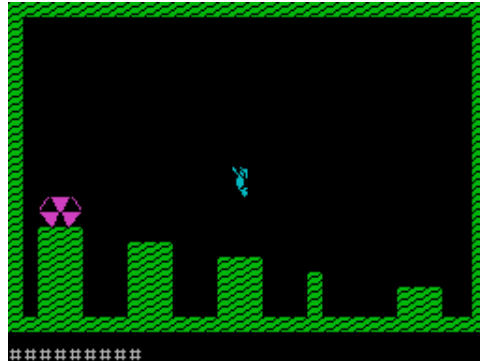

Alfa 1 (Microdinamite,)
Arcade

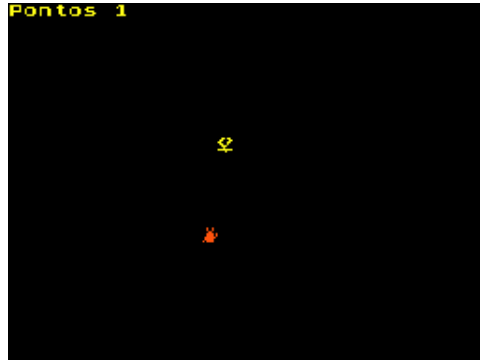

Alfa Soft: Heart (Alfa Soft,)
Scene Demo

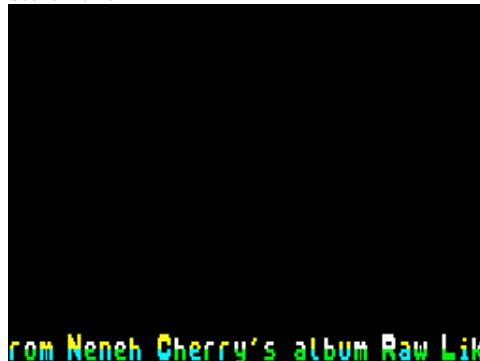

AlchNews 34 (Alchemist Research,2000)
Covertape



AlchNews 37 (Alchemist Research,2001)
Covertape



Alerta Ovni (Ricardo Villalba Martinez,1989)
Text Adventure

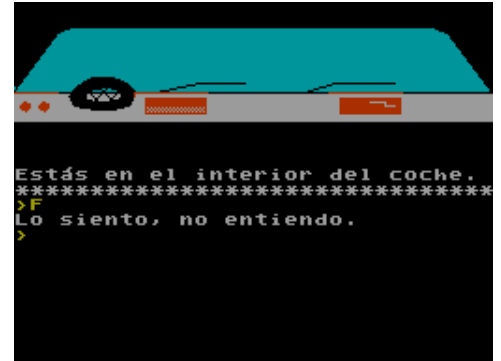

Alfa Soft: Baby, I Don't Care (Alfa Soft,1989)
Scene Demo



Alfa Soft: Popcorn (Alfa Soft,1989)
Scene Demo



Alfa Soft: Straight Up (Alfa Soft,)
Scene Demo

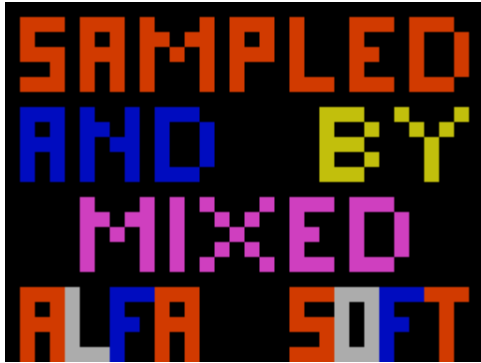

Algebra 9 (Delta,1990)
Utility: Mathematics

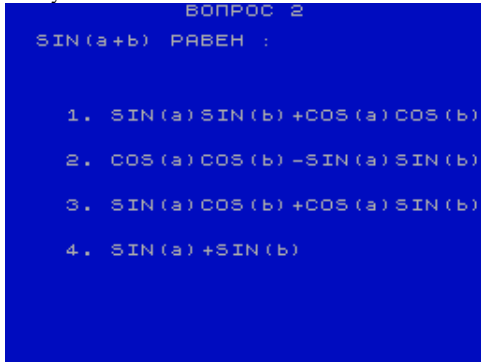

Alhambra, La (Pepsi Soft,1992)
Text Adventure

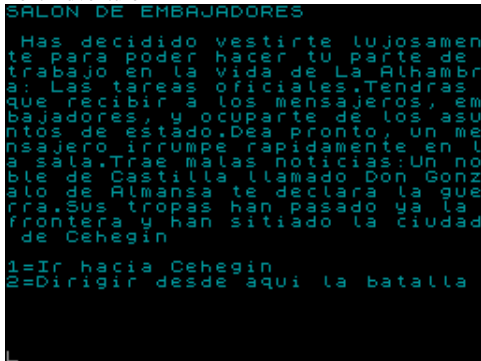

Ali-Bebe (Future Stars,1985)
Arcade



Alien (Gary Howland,)
Arcade

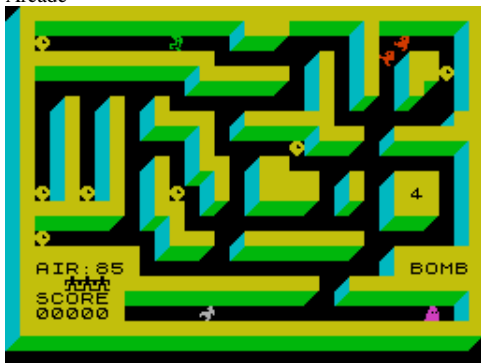

Alfa Soft: Woodpecker from Space (Alfa Soft,1989)
Scene Demo

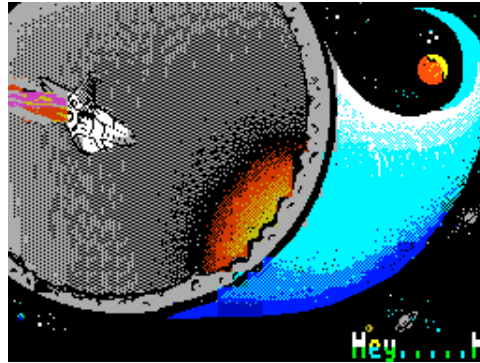

Algebraf (Stanislaw Karpiesiuk,1988)
Utility: Mathematics

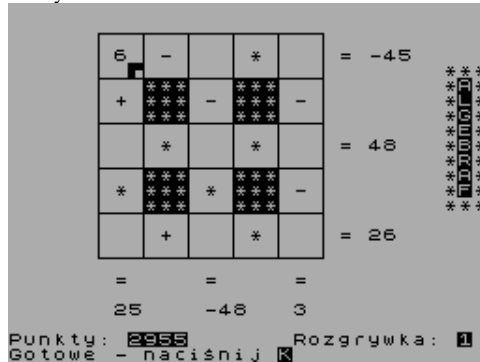

Alhambra Tales (Dinamic Software,)
Arcade

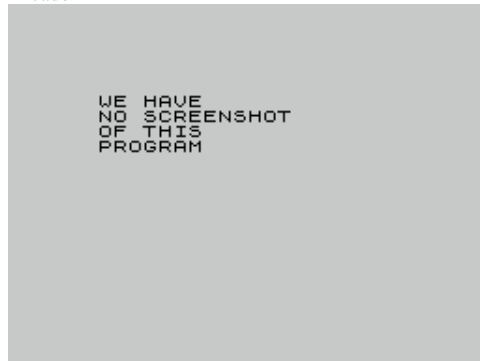

Alicia en el Pais de las Maravillas (Danisoft,)
Text Adventure



Alien (JRS Software Ltd,1982)
Arcade

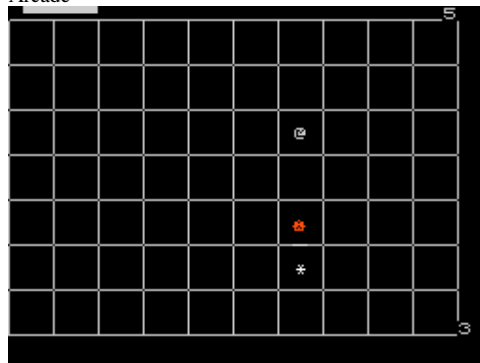

Algebra 10 (Delta,1990)
Utility: Mathematics

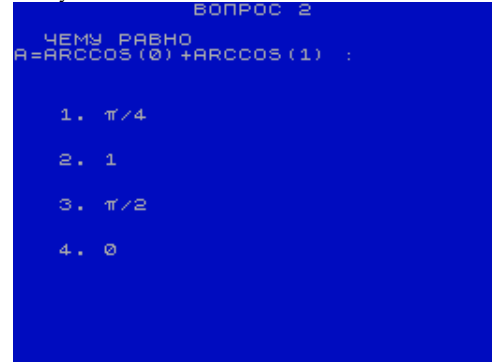

Alger (MicroHobby,1986)
Arcade



Ali Baba (Suzy Soft,1985)
Arcade



Alicia en el Pais de las Maravillas (MicroHobby,1985)
Text Adventure

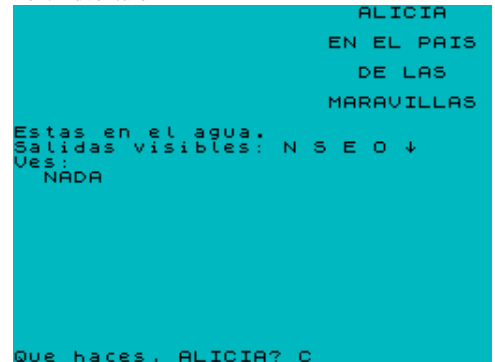

Alien (Mind Games,1984)
Arcade



Alien (Spectre Soft,1983)
Arcade



Alien Adventure (Stephen Hartley Software,1984)
Text Adventure

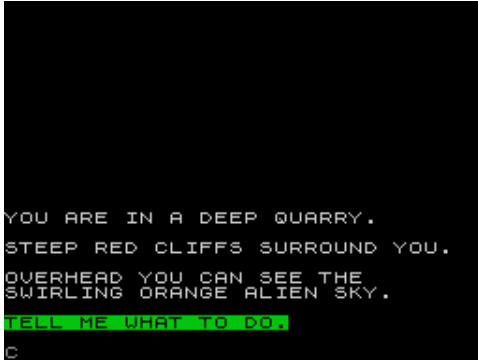

Alien Bank (MicroHobby,1985)
Arcade

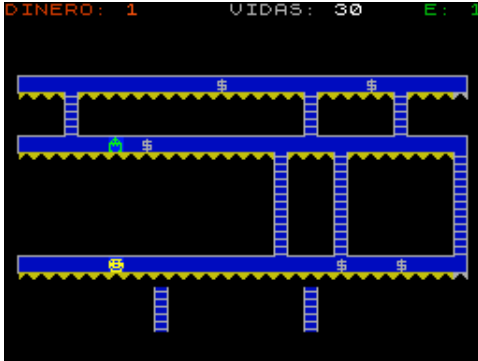

Alien City, The (Pirate Software Ltd,1984)
Text Adventure



Alien Curse (Profisoft,1984)
Arcade

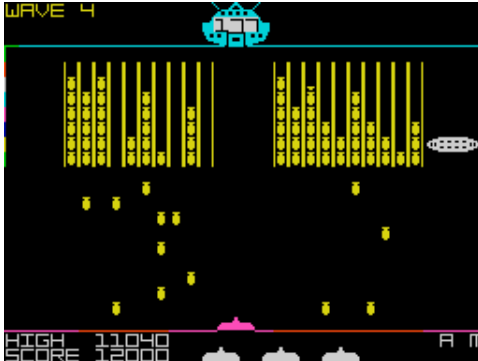

Alien 8 (Ultimate Play The Game,1985)
Arcade



Alien Attack (A.C.E. Software [3],1983)
Arcade



Alien Blaster (Anco Software Ltd,1983)
Arcade



Alien Command (Jega Software,1982)
Arcade



Alien Destroyer (Sinclair Research Ltd,1984)
Arcade



Alien 99 (True Video,2005)
Arcade



Alien Attack (R.D. Foord Software,1984)
Arcade



Alien Block (Control Software,1989)
Arcade



Alien Command (Microware,1983)
Arcade



Alien Evolution (Gremlin Graphics Software Ltd,1987)
Arcade



Alien Fiend (Paul Davies,)
Arcade



Alien Kill (Mastertronic Ltd,1984)
Arcade

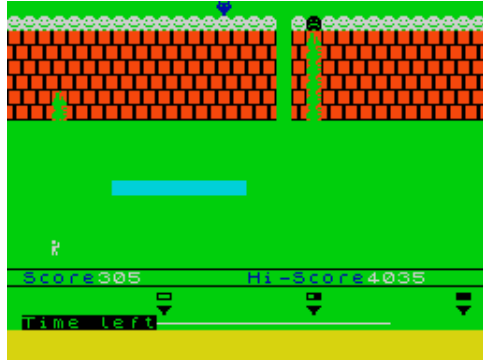

Alien Mine (Spartan Software,1984)
Arcade Adventure



Alien Rain (Impact Software [1],1983)
Arcade



Aliens (Electric Dreams Software,1986)
Arcade

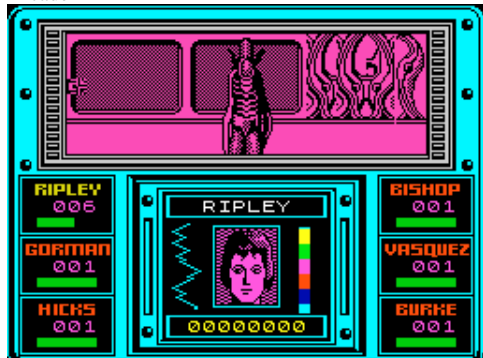

Alien Highway (Vortex Software,1986)
Arcade

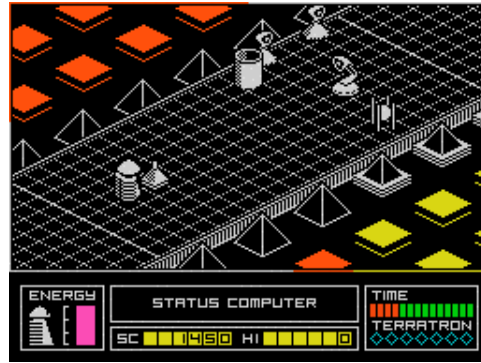

Alien Maze (CRL Group PLC,1983)
Arcade

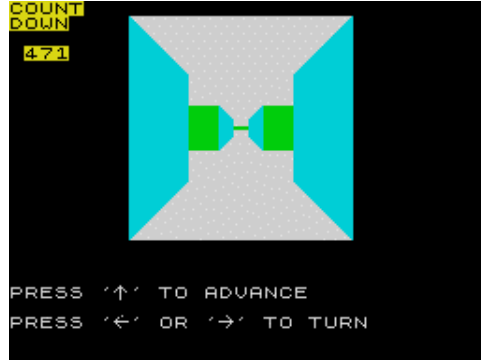

Alien Planet (The Guild,)
Text Adventure



Alien Research Centre (Zenobi Software,1990)
Text Adventure

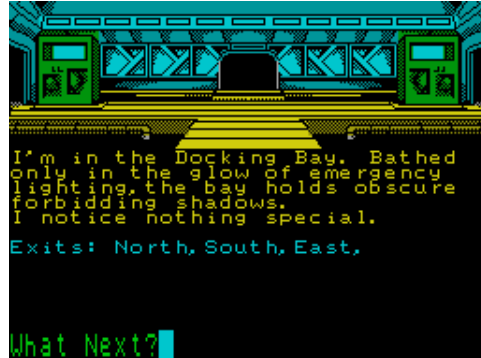

Aliens (Professional Software,1983)
Arcade



Alien Insects (Macronics Systems Ltd,1983)
Arcade

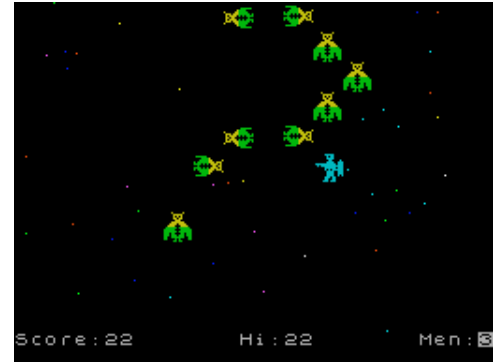

Alien Mine (IE Applications Ltd,1983)
Arcade



Alien Planet + Lords of Magic (The Guild,)
Compilation



Alien Rupture (Green Fish Software Enterprise,1984)
Arcade



Aliens (Spectrum Computing,1983)
Arcade

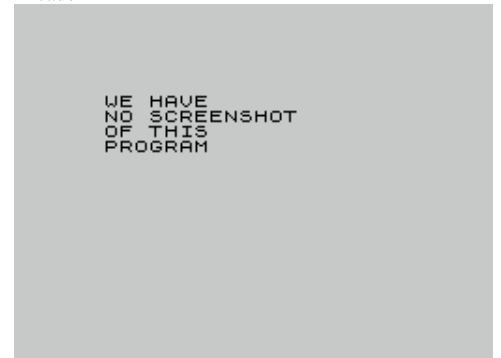

Aliens (Syndrome,2000)
Strategy



Aliens US (Electric Dreams Software,1987)
Arcade

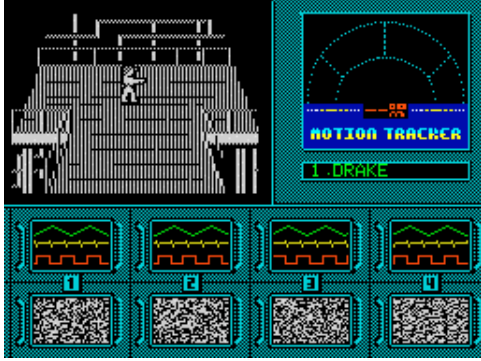

Alien Swoop (Space Age Software,1983)
Arcade



Aliquid Simplex (Your Computer,1984)
Arcade



All-American Basketball (Zeppelin Games Ltd,1992)
Sport



Aliens (Your Sinclair,1986)
Arcade

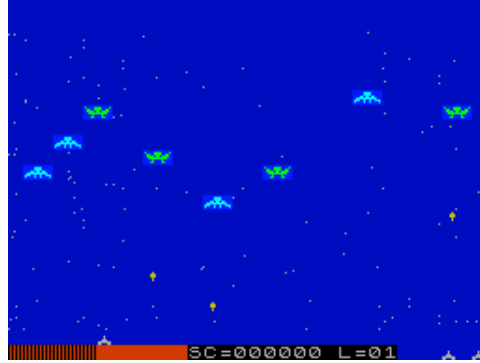

Alien Swarm (Titan Programs,1982)
Arcade

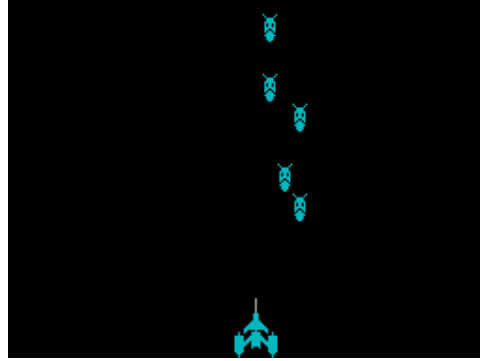

Alien Swoop + Domain (Space Age Software,1983)
Compilation



Alkerk2004 (Jatekgyaros,2004)
Board/Card Game

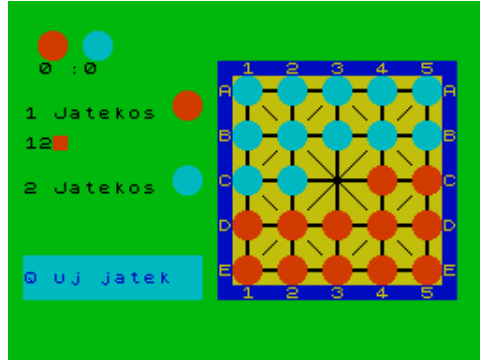

All In a Day's Work (Zenobi Software,1996)
Text Adventure

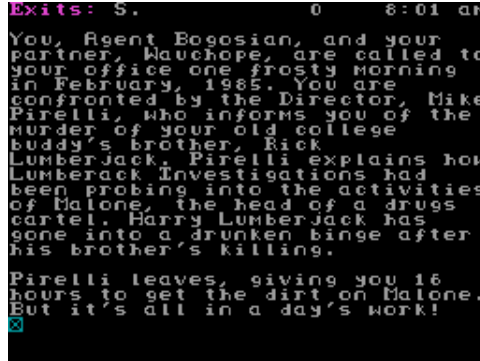

Alien Storm (US Gold Ltd,1991)
Arcade



Alien Swarm + Arena! (K-Tel Productions,1983)
Compilation

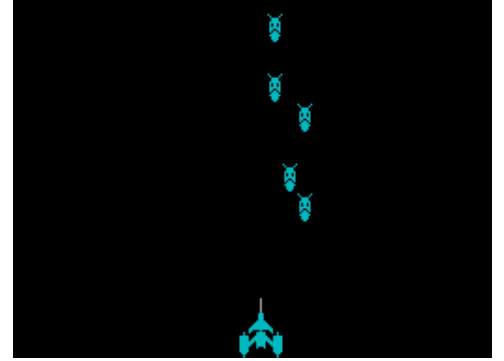

Alien Syndrome (ACE Software [1],1987)
Sport

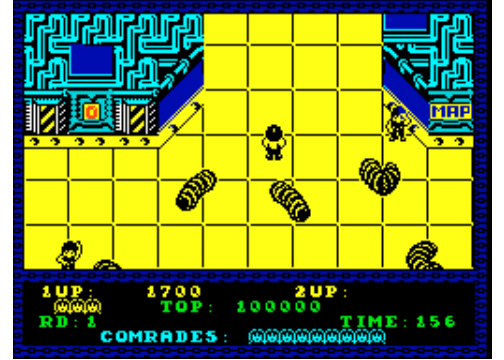

Al Ladron (Luis F. Sanchez,1990)
Text Adventure

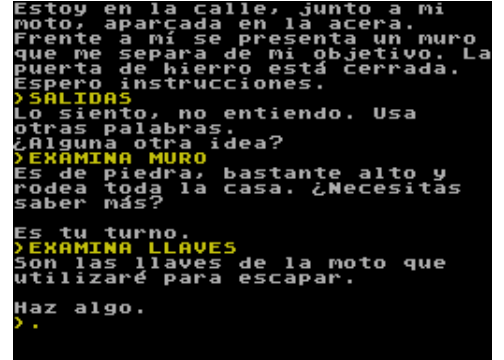

All or Nothing (Abbex Electronics,1984)
Arcade Adventure



All Sorts (Roelof Koning,1993)

Educational

```
Original string:
Hd1IdIo;PvoUp,SA.wr\Mf;EI!FMI#hM
)>kbCH#CHvu [J dIQ&Bo+f=@8_CUJUG>G
BubbleSORT at work:
1,HA.IIPMS;EI!FMI#UM)N>dbCH#CHdf
[ J dIQ&Bh+f=@8_CUJUG>GikoooprUVVw
```

All-Sort S1 (Alan Firminger,1983)

Utility

```
1 file name: ALL-SORT
2 comment:
3 single sort 4 preset
5 fail soft
6 arrays
7 key arrays
  seq (a/d)
  from
  len
8 residual seq retained
A copy B generate M
```

All Stars (The Edge Software,1988)

Compilation

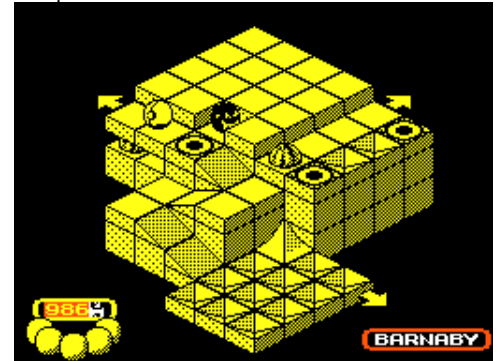

All Systems Go (Anik Microsystems,1984)

Arcade



All Time Great Tour 1 (Lambourne Games,1992)

Simulation

```
ENTER TEAM FOR : HACKERS ANON
1. BARROW
2. D.AMISS
3. RAHPRAKASH
4. HARPER
5. U.FERGUSON
6. C.HUNTE
7. DEWDNEY
8. BACCHUS
9. HAYNES
10. H.JOHNSON
11. N.PHILLP
12. G.GOMEZ
Is team correct Y/N ? YC
```

All Time Great Tour 2 (Lambourne Games,1993)

Simulation



Almacen, El (MicroHobby,1985)

Arcade



Almacen Lunar (MicroHobby,1986)

Arcade



Alma de Guerrero (Beyker Soft,2003)

Arcade

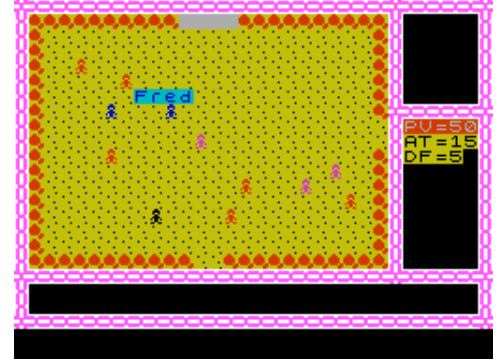

Almanac (.)

Utility: Astronomy/Astrology

```
DATA FOR THE DATE OF 5 2 1999
SUN'S LONGITUDE 315.746 deg
SUN'S MEAN R.A. 21.2463 hrs
SUN'S MEAN DEC. -15.969 deg
SUNRISE LOCAL TIME 7.2844 hrs
SUNSET LOCAL TIME 17.1536 hrs
TIME OF SUNRISE GMT 7.2177 hrs
TIME OF SUNSET GMT 17.087 hrs
PRESS "c" TO COPY TO PRINTER
ANY OTHER KEY TO CARRY ON
```

Alo Bao (Load 'n' Run [Ita],1985)

Arcade

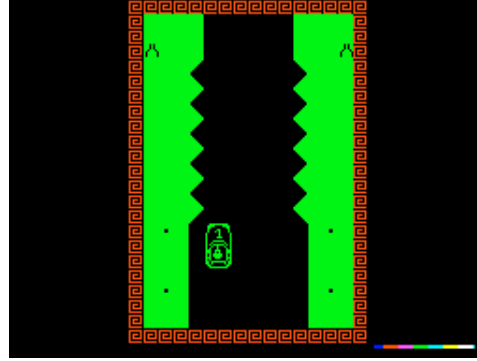

Alpha 1 (Stefan Wisskirchen,1984)

Arcade



Alphabet (Widgit Software Ltd,1983)

Educational



Alphabet Games (Sinclair Research Ltd,1983)

Educational



Alpha-Beth (A'n'F Software,1985)

Educational



Alphabet Soup (Reflex Software,1984)
Educational

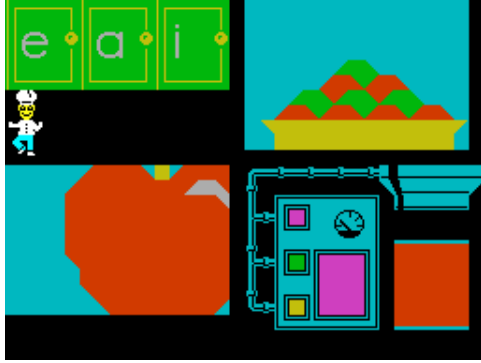

Alpha-Gen (A'n'F Software,1985)
Educational



Alpine Games (Atlantis Software Ltd,1987)
Sport



Altered Beast (Activision Inc,1988)
Arcade Adventure



Alvin and the Chipmunks (Alternative Software Ltd,1993)
Arcade

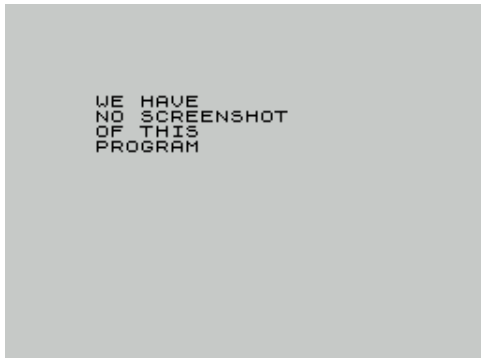

Alphabetter (Macmillan Software Ltd/Sinclair Research Ltd,1985) Educational

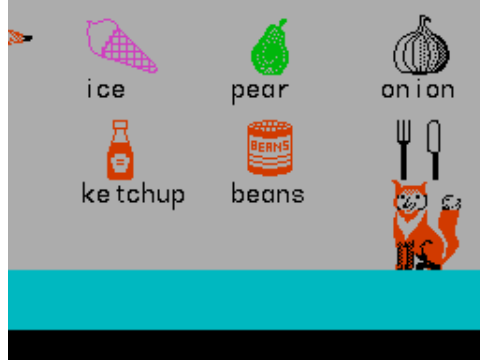

Alpha Graph (Arnold Wheaton Software,1983)
Educational

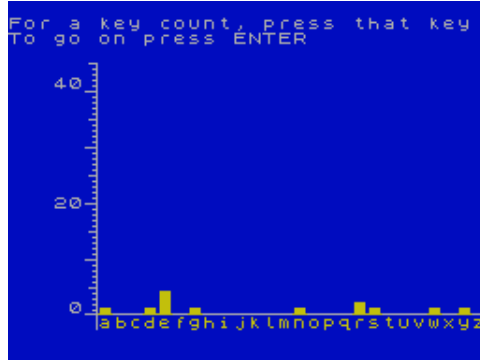

Alstrad (The Guild,1991)
Text Adventure

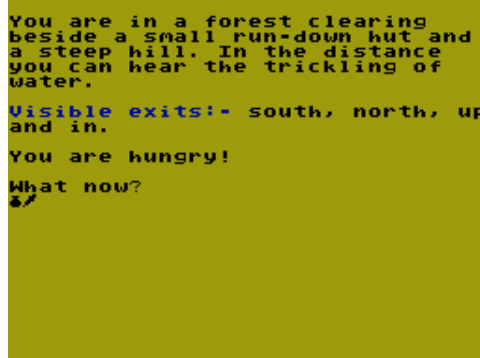

Alternative World Games (Gremlin Graphics Software Ltd,1987) Sport



Always on my Mind (Coolguys Ltd.)
Scene Demo



Alphabet Zoo (Spinnaker Software Corporation,1984)
Educational

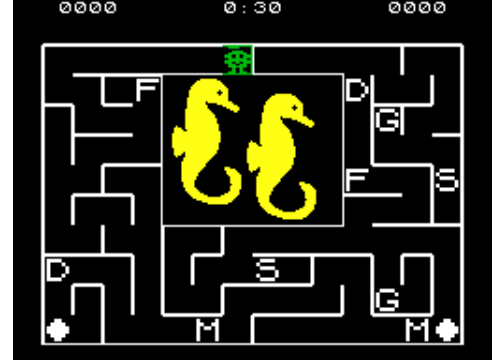

Alpha-Raid (Video Showcase,1984)
Arcade



Alter-Earth (Double Play Adventures,1984)
Text Adventure



Alunizer (Software Editores,1986)
Arcade



Amadeus (Individual Software,1987)
Utility



Amaurote (Mastertronic Added Dimension,1987)
Arcade

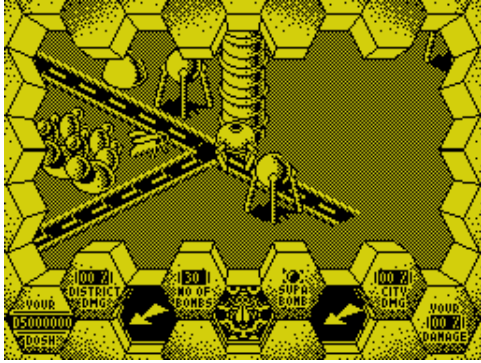

Amazing! (Phipps Associates,1982)
Arcade



Amazing Rocketeer, The (John Fotou,2007)
Arcade



American Football (Audiogenic Software Ltd.)
Sport



American Tag Team Wrestling (Zeppelin Games Ltd,1992)
Arcade

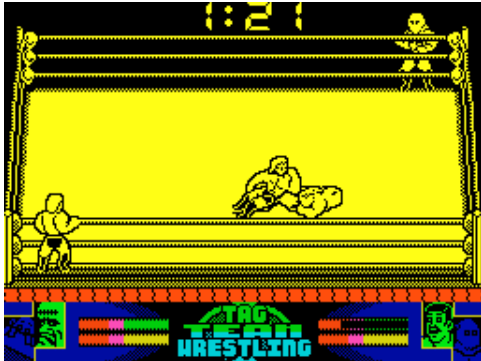

Amaze (Bytesize,1983)
Arcade

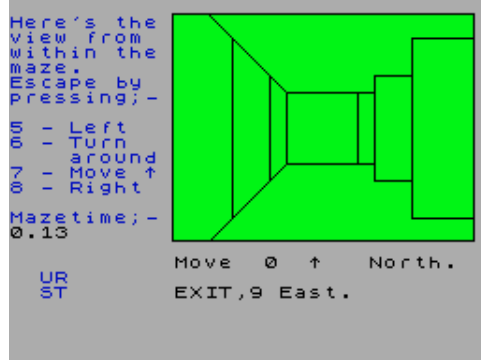

Amazing Maze, The (Peekay Software,1983)
Arcade



America (Adventuresoft UK Ltd,1987)
Text Adventure



American Football (Mind Games,1984)
Sport

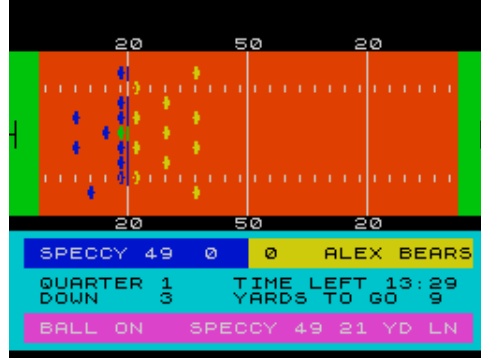

American Turbo King (Virgin Mastertronic Ltd,1989)
Arcade



A-Maze (K'Soft Ltd,1986)
Arcade

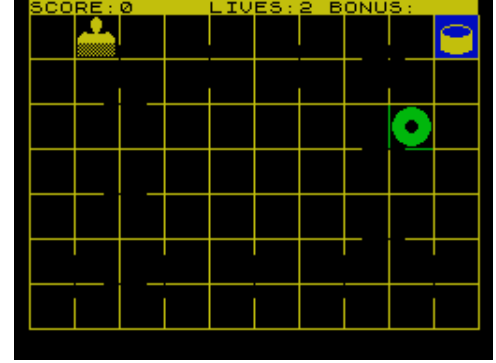

Amazing Ollie (Storm Software [1],1983)
Educational

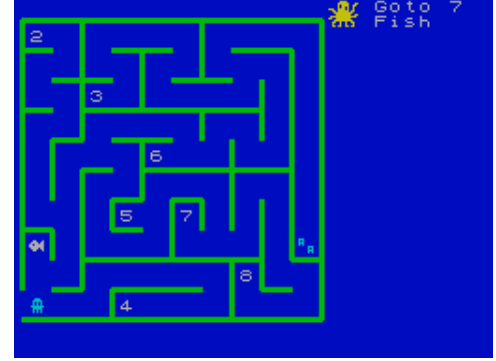

American 3D Pool (Zeppelin Games Ltd,1992)
Arcade



American Football (Softstone Ltd,1985)
Simulation



America's Agent (KHP Soft,1984)
Text Adventure



America's Cup, The (US Gold Ltd,) Sport



Amiga World (Oscar & Spielberg,) Scene Demo



Amo del Mundo (Positive,1990) Arcade



Amstrad Compilation Disk Spectrum+3 (Amstrad,1987) Compilation

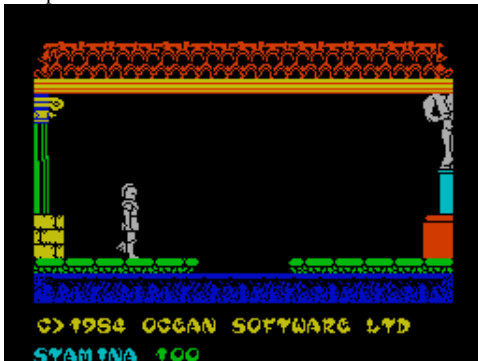

Amulet, The (Sentient Software Ltd,1985) Text Adventure

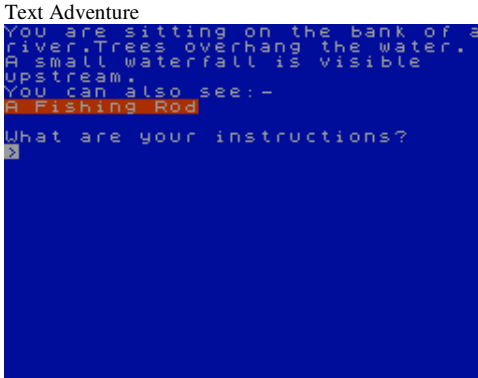

Amiga Advert (.) Text Adventure

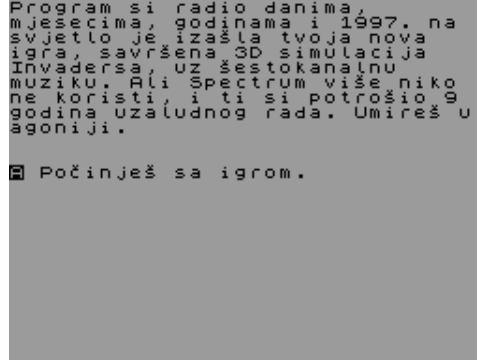

Amity's Vile (Michael Bailey,1987) Text Adventure

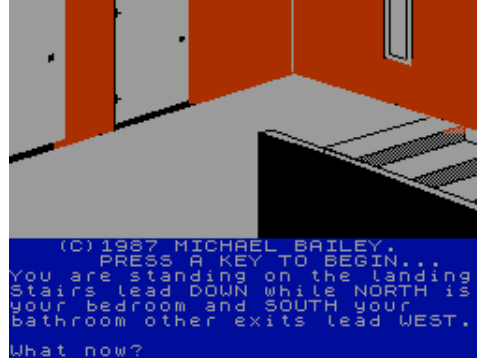

Amoto's Puf (SPE,1988) Arcade

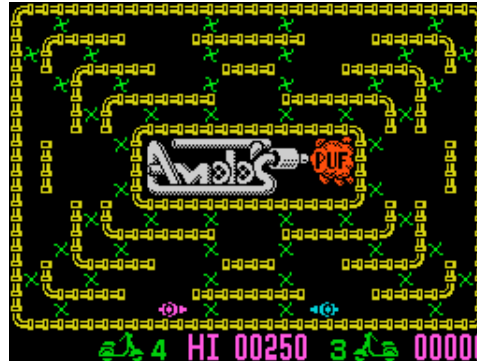

Amtrak Rail Pass (Ashley Greenup,1989) Simulation

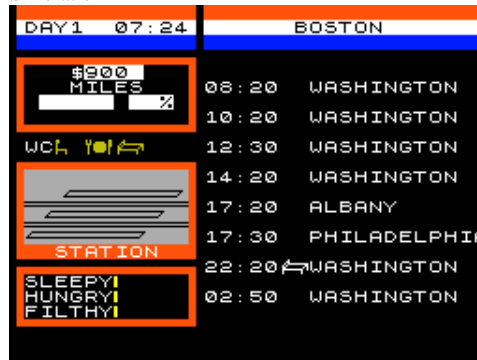

Amunt la Informatica. Cassette n. 2 (Centre Divulgador de la Informatica,) Compilation

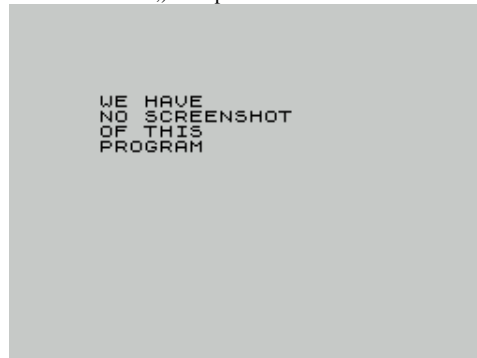

Amiga Demo (.) Scene Demo

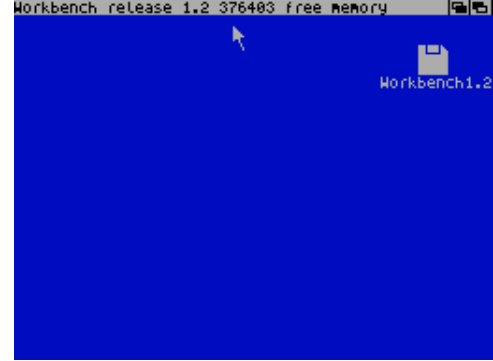

Ammytris (Navigator,1995) Arcade

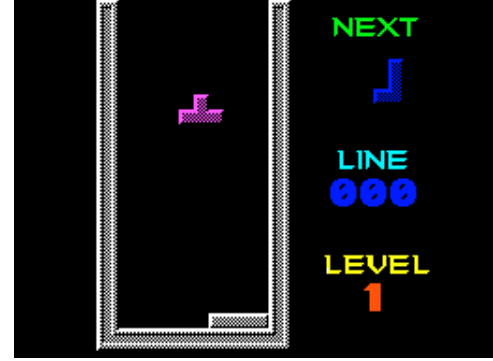

Amplifier Simulation (16/48 Tape Magazine,1983) Utility: Electronics



Amulet of Darath, The (Zenobi Software,1992) Text Adventure

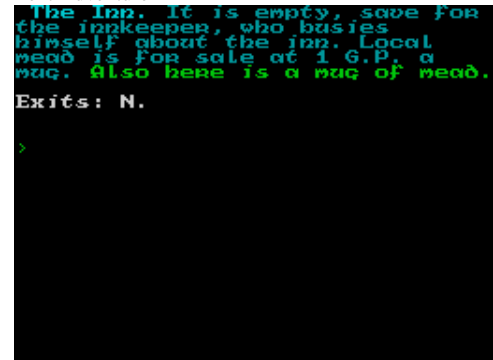

Amusement Park 4000 (Jonathan Cauldwell,2003) Strategy

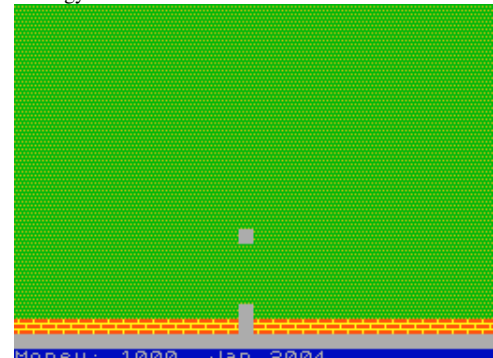

AMX Art (Advanced Memory Systems Ltd,1985)

Utility: Drawing

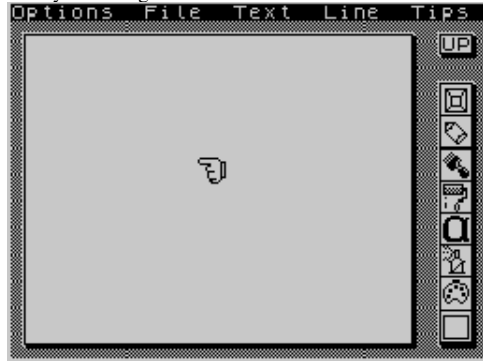

Anagrams (.)

Educational



Anagrams + Xo-Word (Azed Software,1986)

Compilation



Anarchy (Rack-It,1987)

Arcade

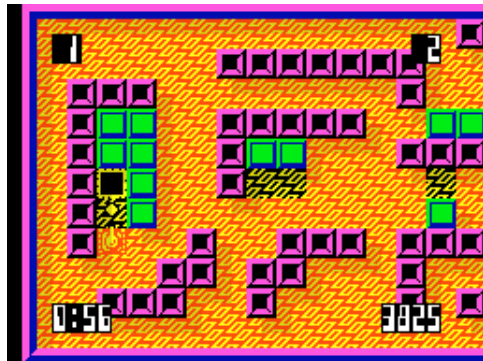

Andre's Night Off (C&VG,1984)

Arcade



Anaconda (Software Projects Ltd.)

Arcade



Anagrams (Azed Software,1986)

Board/Card Game



Anagrams against the Clock (Shiva Publishing Ltd,1983)

Arcade



Ancient Quests (Mirrorsoft Ltd,1985)

Compilation

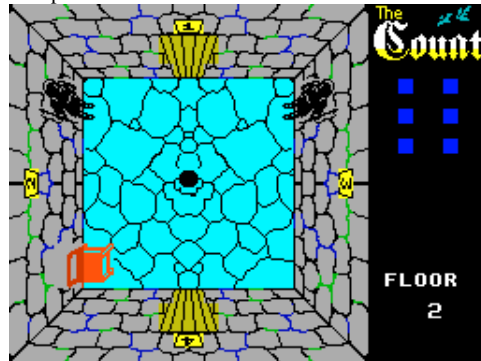

Android 1: The Reactor Run (Vortex Software,1983)

Arcade



Anagrammery (Garry Rowland,1993)

Utility

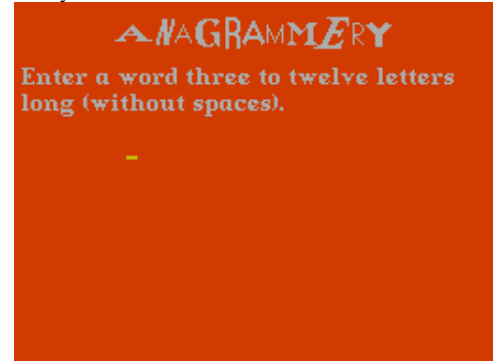

Anagrams (Ian J. Rogers.)

Board/Card Game

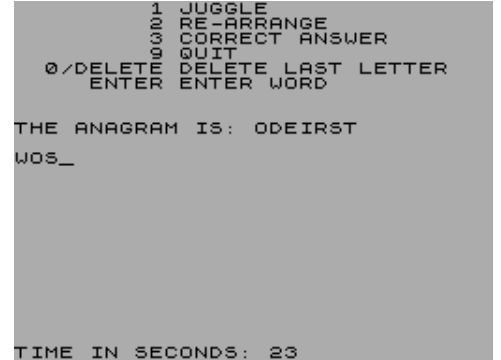

TIME IN SECONDS: 23

Anamagon's Temple, The (Mediandroid,1988)

Text Adventure



Andeskydning (.)

Arcade

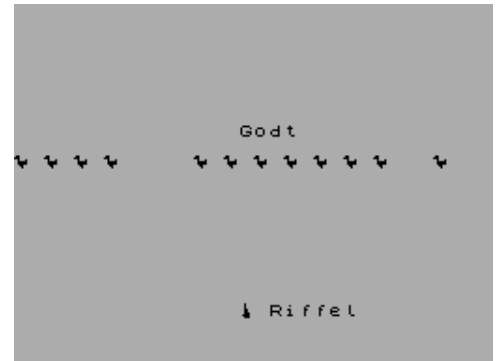

Android 2 (Vortex Software,1983)

Arcade



Androide (ERE Informatique,1984)
Arcade

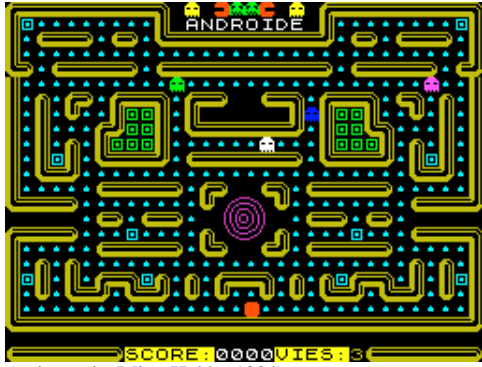

Andromeda (MicroHobby,1984)
Arcade



Andromeda Thropy (Finsbury Software,1984)
Arcade

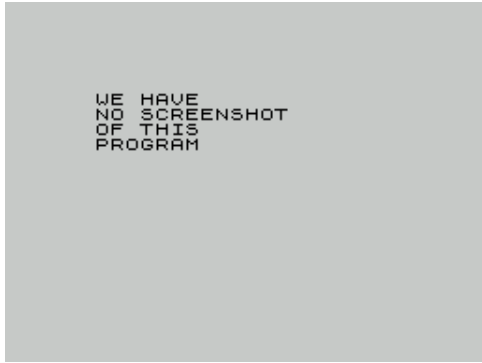

Anekdotas 3 Kilodemo (Golden Disk Corp,1994)
Scene Demo



Angel Nieto Pole 500cc (Opera Soft S.A.,1991)
Arcade



Android Pit Rescue (Abacus Programs,1982)
Arcade

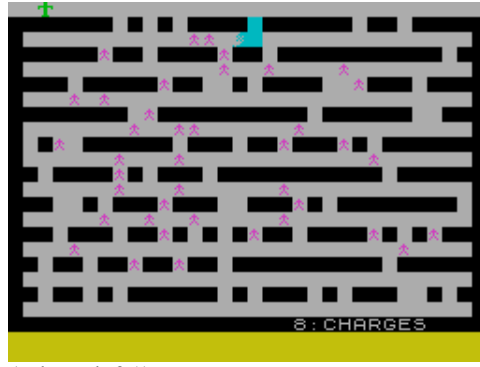

Andromeda 3 (.)
Text Adventure



Andy Capp (Mirrorsoft Ltd,1988)
Arcade Adventure

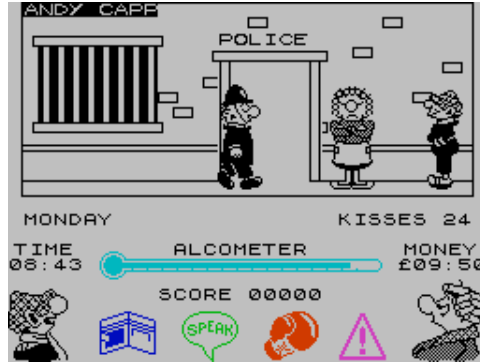

Anfractuus (Players Software,1987)
Arcade

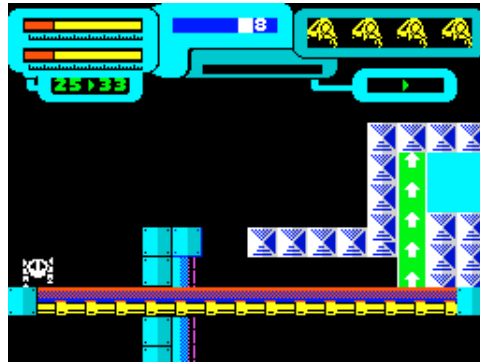

Angle (Chalksoft Ltd,1984)
Educational



Androids (Sunshine Books,1983)
Arcade

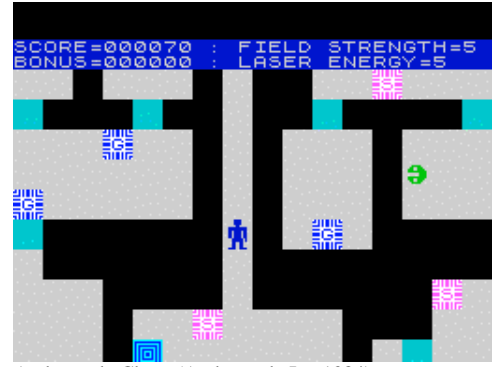

Andromeda Chess (Andromeda Inc,1984)
Board/Card Game



Anekdotas 2.75 (Golden Disk Corp,1994)
Scene Demo



Angel, El (MicroHobby,1985)
Arcade



Angleball (Mastertronic Added Dimension,1987)
Sport



Angler (Virgin Games Ltd,1983)
Arcade

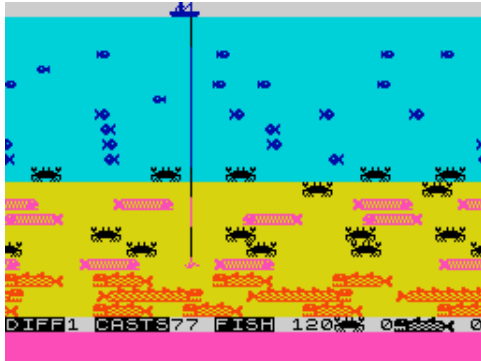

Anglia Rover (Dee-Kay Systems,1988)
Simulation

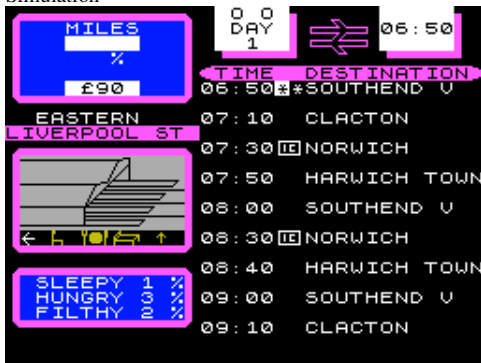

Anglina 4 (Peter Machala,1989)
Educational

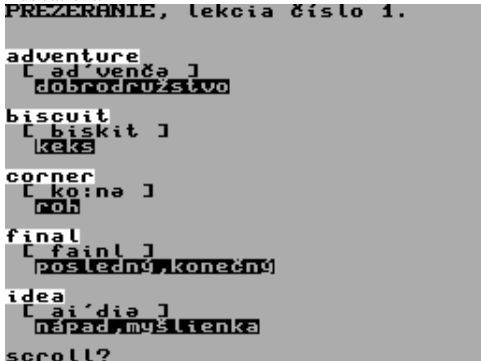

Aniditor (Marwin Freutel,)
Utility

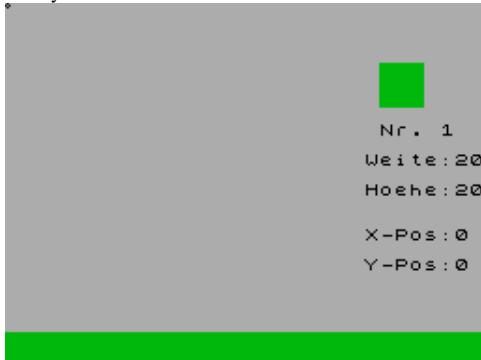

Anillos del Poder (MicroHobby,1986)
Text Adventure



Angles (Contrast Software,1983)
Educational

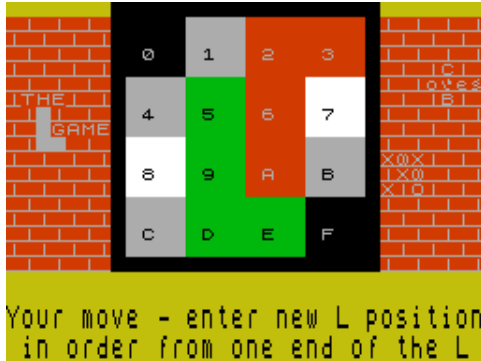

Anglictina 1 (VD Program,1989)
Educational

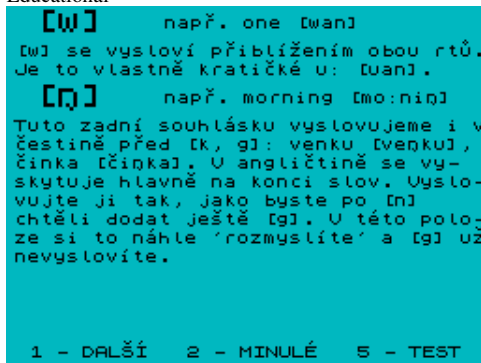

Anglo Scot (Dee-Kay Systems,)
Simulation

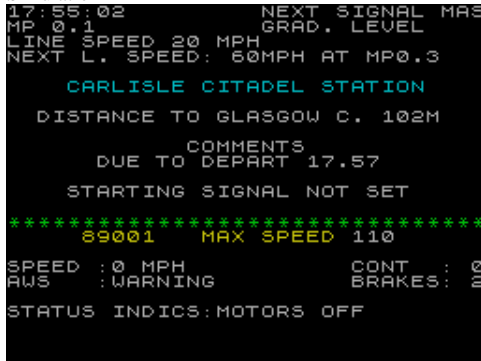

Anikman (Anik Microsystems,1984)
Arcade



Anillos, Los (MicroHobby,1985)
Arcade



Angle Turner (Arnold Wheaton Software,1984)
Educational

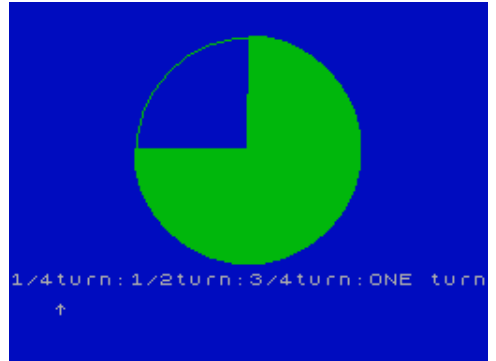

Anglina 1 (Peter Machala,1989)
Educational

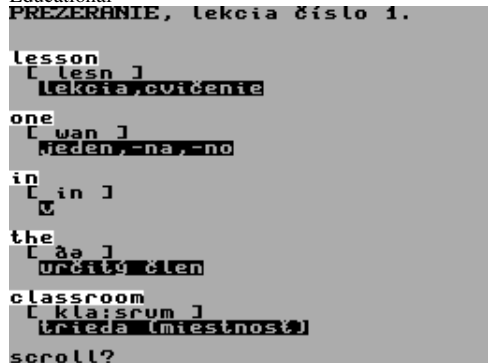

Anhk Morpork (,)
Text Adventure



Anillo, El (Juan Antonio Paz Salgado,1989)
Text Adventure

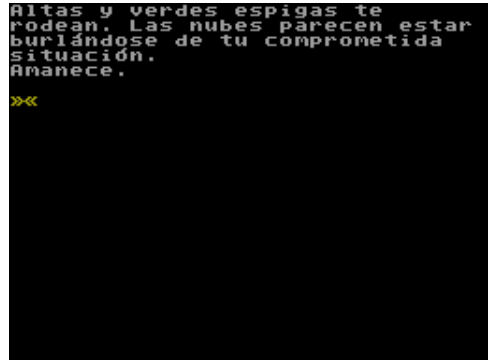

Animal, Vegetable, Mineral (Arnold Wheaton Software,)
Educational



Animaniacs (Anestis Koutsoudis,1998)
Scene Demo



Animation Demo (Anestis Koutsoudis,1998)
Scene Demo

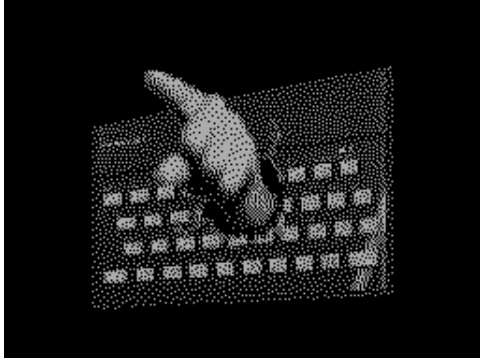

Animator (16/48 Tape Magazine,1985)
Utility: Screen Manipulation



Animator Rotacija (SAM Svoj Majdtor,1984)
Utility: Screen Manipulation

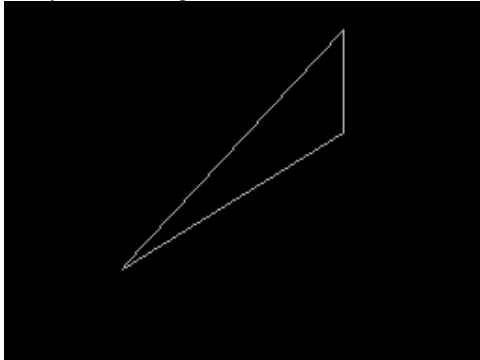

Ankebergsaventyret (Stefan Andersson,1986)
Text Adventure



Animated Action! (Popular Computing Weekly,1983)
Arcade

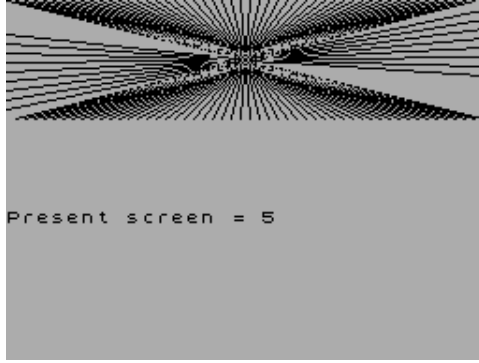

Animation Screen (Klaus Jahn,)
Utility: Screen Manipulation

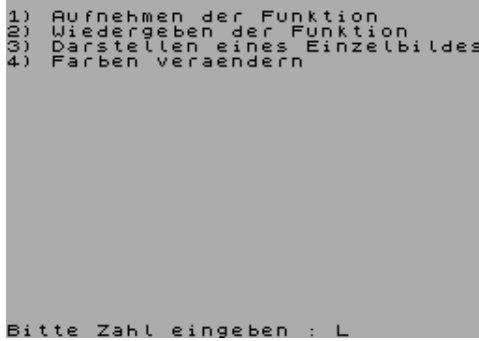

Animator (Klaus Jahn,1987)
Utility: Screen Manipulation



Anime Manga (Speccy fun FOREVA !i!,2007)
Simulation



Annals of Rome (PSS,1986)
Strategy



Animated Strip Poker (Knightsoft,1985)
Board/Card Game

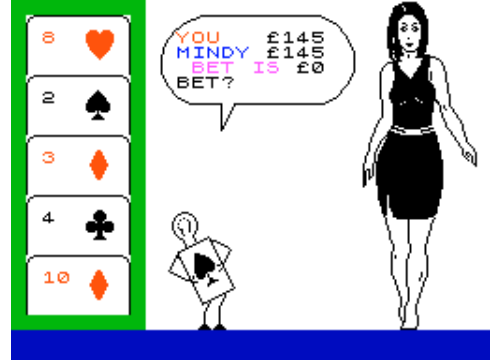

Animator (.)
Utility: Screen Manipulation

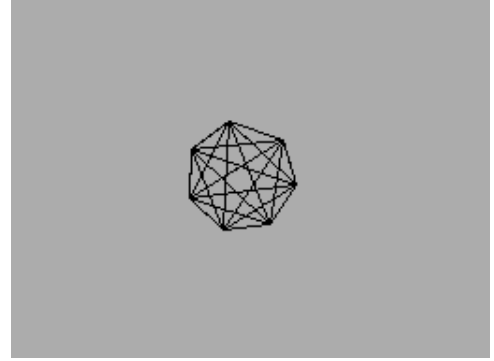

Animator1 (Softcat Micros,1986)
Utility: Screen Manipulation



Animator (Outlet Microdrive Magazine,)
Scene Demo



Ano Gaia (Your Sinclair,1992)
Arcade

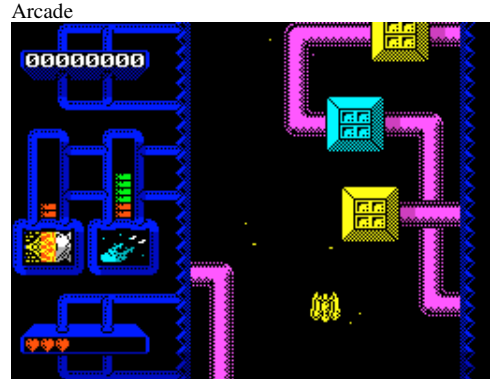

Anoms (MicroHobby,1986)
Arcade



Another Brick on the Wall (Miguel A. Garcia Prada,2004)
Arcade



Answer Back Factfile 500 Arithmetic (Kosmos Software Ltd,1991) Educational

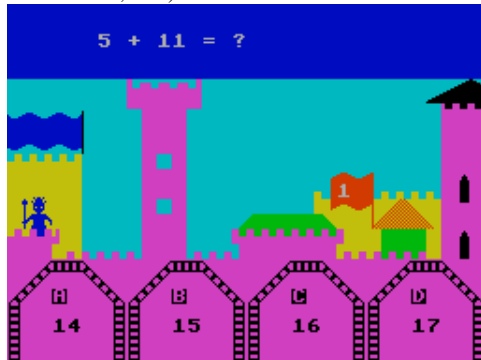

Antarctic Diamonds (Tweety Soft Ltd,1985)
Arcade



Antares II AY And Beep Demo (Profsoft,1993)
Scene Demo



Another Big Disk (Zenobi Software,)
Compilation



Another Brick on the Wall 2 (Compiler Software,2005)
Arcade

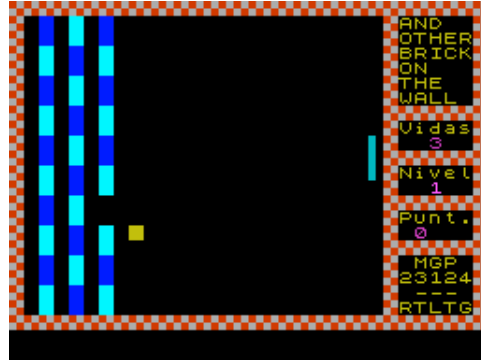

Answer Back Junior (Kosmos Software Ltd,1991)
Educational

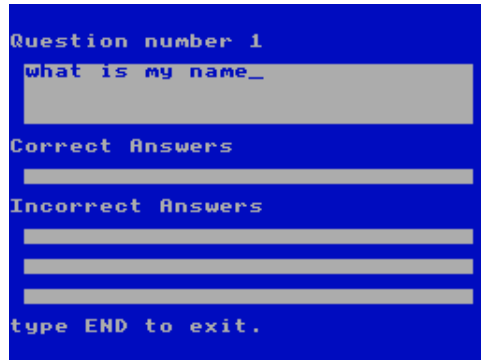

Antares (Dro Soft,1987)
Arcade



Ant Attack (JRS Software Ltd,1983)
Arcade



Another Brick (Geppone Software,)
Arcade



Answer (Code Busters,1994)
Scene Demo



Antagonists, The (Addison-Wesley Productions,1985)
Text Adventure

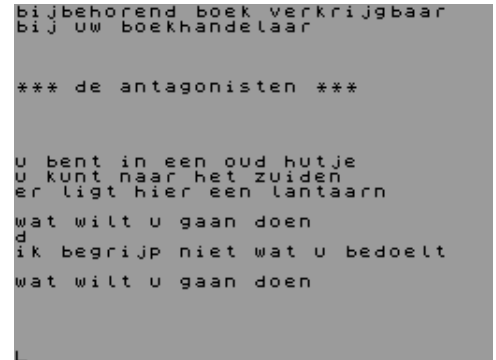

Antares (MicroHobby,1985)
Arcade

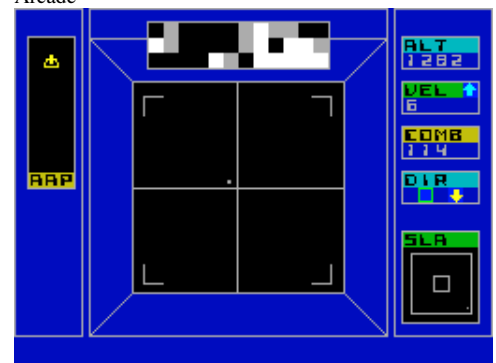

Ant Attack (Macronics Systems Ltd,1983)
Arcade



Ant Attack (Quicksilver Ltd,1983)
Arcade



Anti-Misil (Video Spectrum,1984)

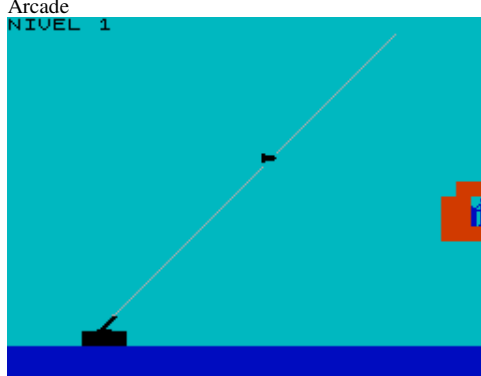

Ant KO (.)
Arcade

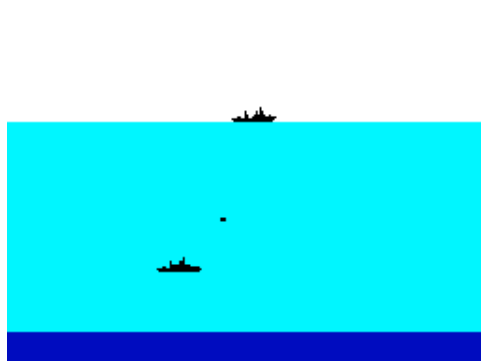

Anteroo (Central Solutions,1985)
Arcade



Anyove (.)
Utility: BASIC Related

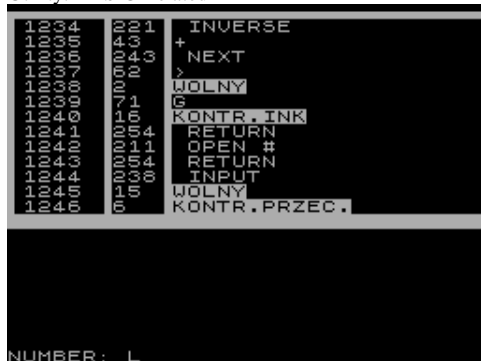

Anteny (Amisin,1985)
Utility: Mathematics



Anti-Missile Defence (Sinclair Programs,1983)
Arcade

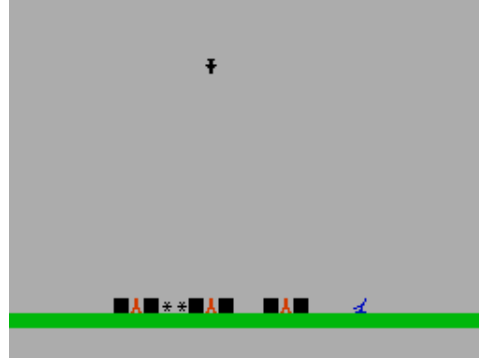

Anto Aereo (.)
Arcade



Anteroo + Prelude (Central Solutions,1986)
Compilation



Any Tank (Optical Brothers,1998)
Arcade

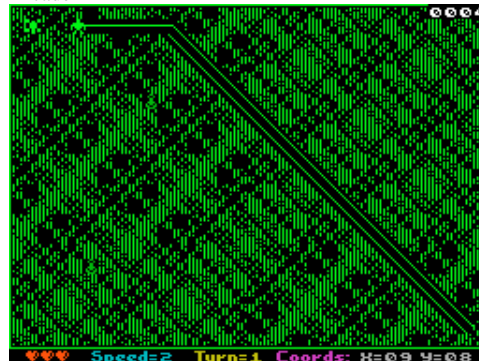

Antics (Bug-Byte Software Ltd,1983)
Arcade

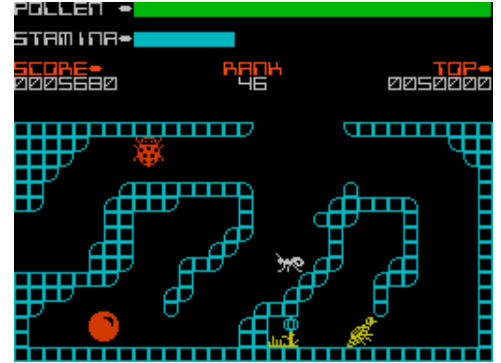

Antirun (MicroHobby,1985)
Utility



Antony and Cleopatra (Akadimias Software,1984)
Educational



Anttilis Mission, The (Compass Software,1992)
Text Adventure



Apache Raid!! (Pirate Software Ltd,1987)
Arcade



Apanage (Mr. Incognito.)
Scene Demo



Apocalypse (Red Shift Ltd,1983)
Strategy



Apocalypse Expansion Volume 2 - Chapter 2 (Red Shift Ltd,1984) Strategy



Apollo 2 (Darkstar,1983)
Arcade



Apple I Emulator (Thomas Goering,2007)
Simulation

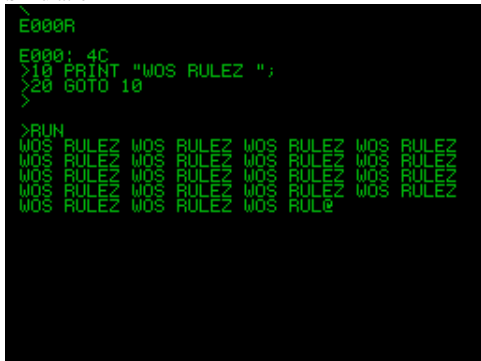

APB (Domark Ltd,1989)
Arcade



Apocalypse Expansion Volume 1 (Red Shift Ltd,1984) Strategy



Apollo (Jocker Soft,1996)
Text Adventure

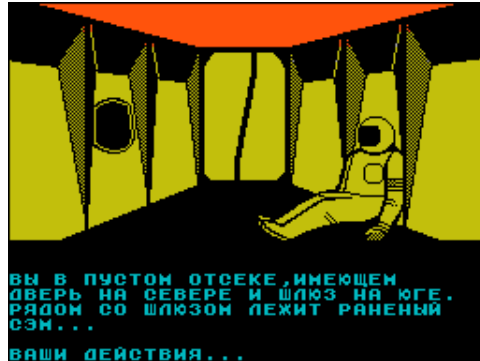

Apostrophe, The (Sinclair Research Ltd,1983)
Educational

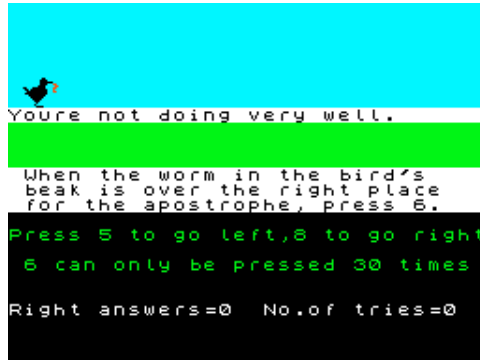

Apple Jam (DK'Tronics Ltd,1984)
Arcade

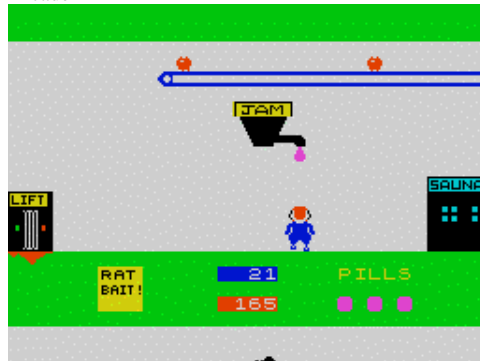

Apfel-Kobold (Happy-Computer,1983)
Arcade

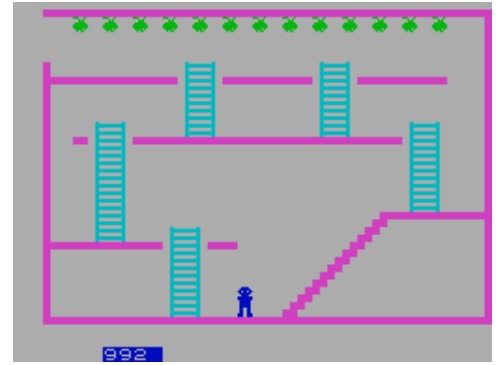

Apocalypse Expansion Volume 2 - Chapter 1 (Red Shift Ltd,1984) Strategy

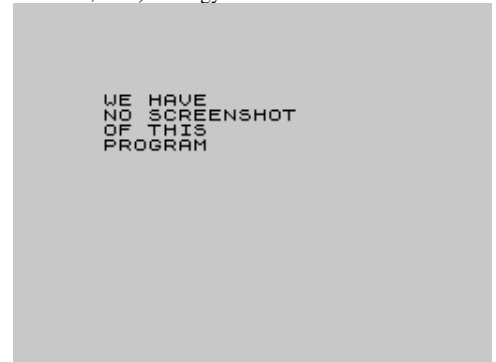

Apollo 11 (Darkstar,1983)
Arcade



Appel Vanger (R. Morgan,)
Arcade



Apple Movie, The (The Lords,1989)
Scene Demo



Apple Thief (Sinclair Programs,1983)



Appleton, The (Walter Pooley,1995)



Appointments (Sinclair Programs,1983)

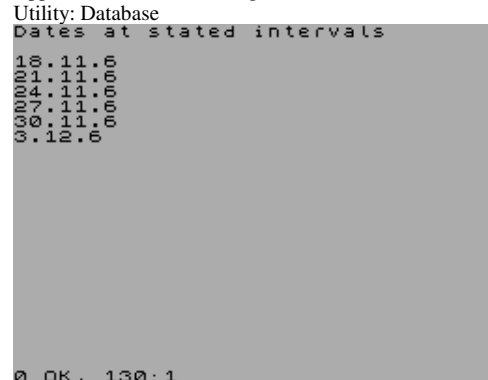

Apprentice (Rainbow Arts,)



Apprentice, The (Zenobi Software,1993)



April 7th (Zenobi Software,1992)

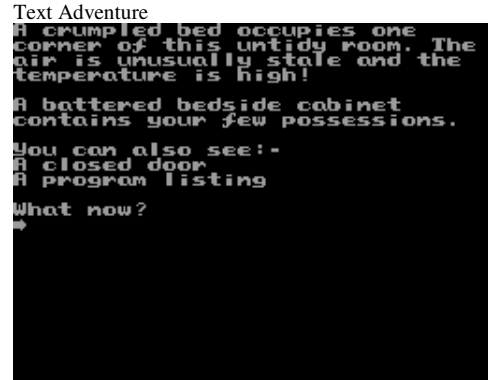

AprSkw (Polbrit International,1984)

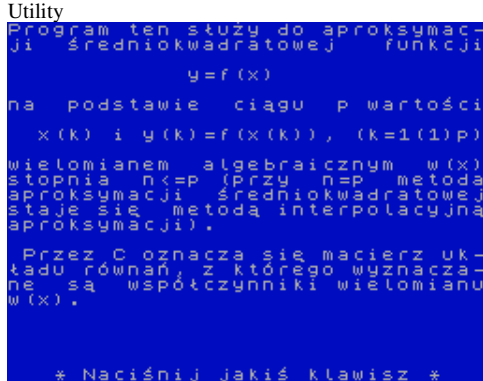

Aquaplane (Quicksilva Ltd,1983)



Aquarius (Bug-Byte Software Ltd,1983)



Aquasquad (Atlantis Software Ltd,1988)

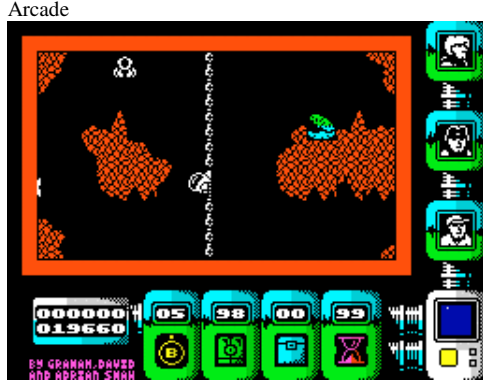

Arabescos (Microparadise Software,1984)



Arachno Joe (minigame) (Dinu Cristian Mircea,2003)

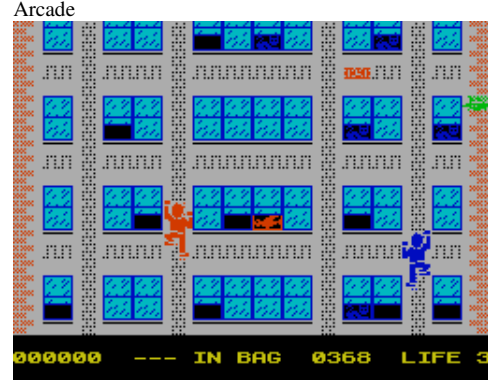

Arachnophobia (Titus,)

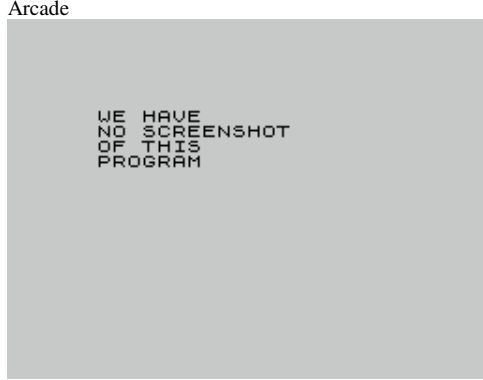

Aracnav (Mariano Chiaverano,2006)



Aracnidos (Andromeda Inc,1984)

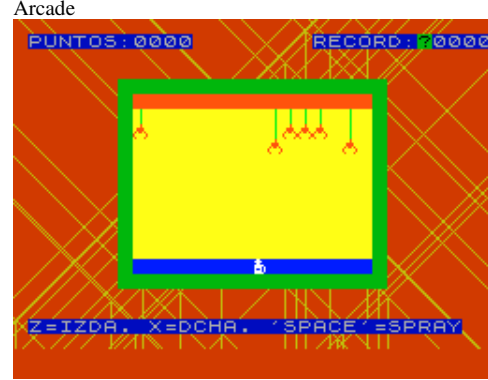

Arana, La (Year Zero Software,1990)
Text Adventure



Arantxa Sanchez Vicario Tennis (Gonzalo Suarez,)
Arcade



Arcade Classics (Silverbird Software Ltd,1988)
Compilation



Arcade Flight Simulator (Code Masters Ltd,1989)
Arcade

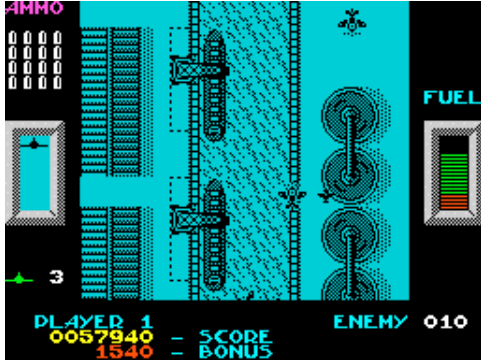

Arcade Hall of Fame (US Gold Ltd,1985)
Compilation



Aranus (MicroHobby,1985)
Arcade

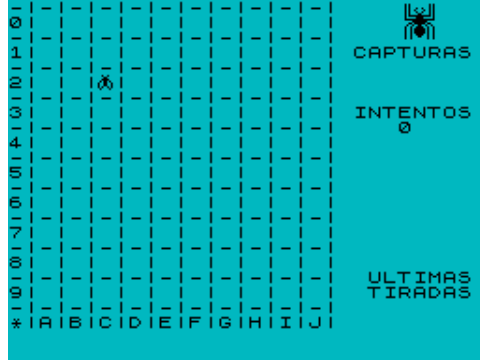

Arany Pince (NyitraiSOFT,2003)
Arcade

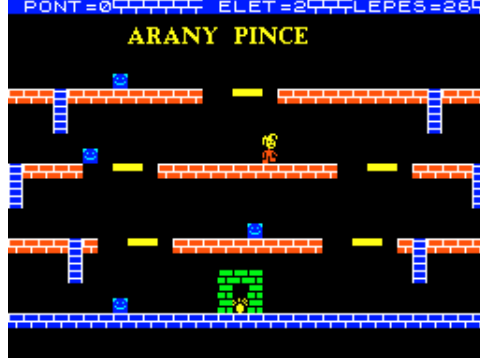

Arcade Creator (Argus Press Software Ltd,1986)
Arcade Game Development Tool

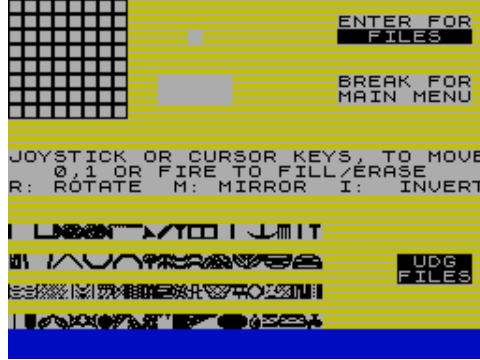

Arcade Force Four (US Gold Ltd,1988)
Compilation

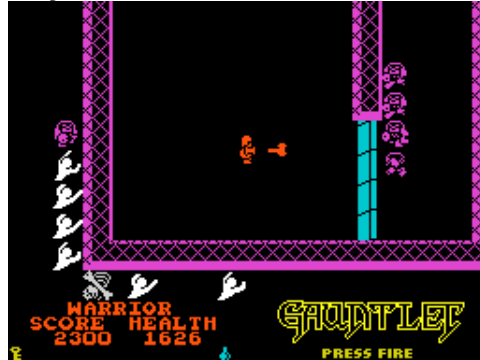

Arcade Hits - 2 In 1 (Elite Systems Ltd,1985)
Compilation



Aranha (Year Zero Software,1990)
Text Adventure



Arbatax (.)
Simulation



Arcade Extravaganza (Alternative Software Ltd,1988)
Compilation



Arcade Fruit Machine (Zeppelin Games Ltd,1990)
Arcade



Arcade Hot Shots 2 (,1986)
Compilation



Arcade Muscle (US Gold Ltd,1989)
Compilation



Arcade Volleyball (Rome'r Software,1997)
Arcade



Arcadia (Ocean Software Ltd,1989)
Compilation



Arcanoid (Phantom Family Corp,2001)
Arcade

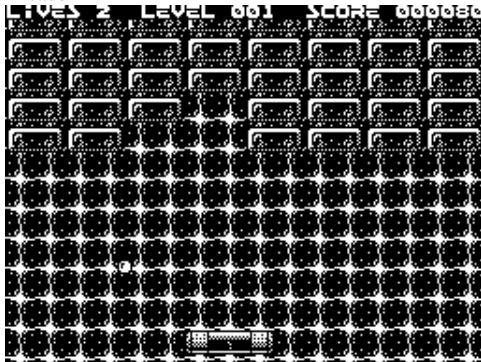

Archeo (Proxima Software,)
Arcade Adventure



Arcade Trivia Quiz (Zeppelin Games Ltd,1989)
Board/Card Game



Arcade Wizard (US Gold Ltd,)
Arcade

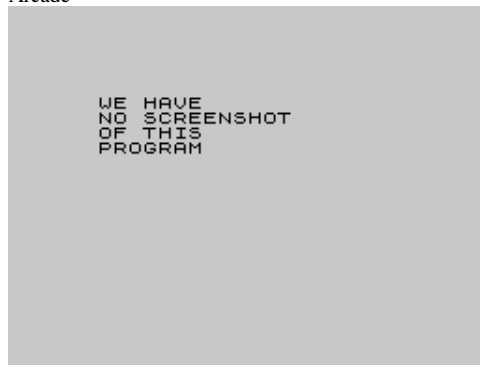

Arcadian, The (J.K. Greye Enterprises Ltd,1982)
Compilation



Archaeologist, The (Spectrum Computing,1985)
Arcade



Archers, The (Mosaic Publishing Ltd,1987)
Text Adventure



Arcade Trivia Quiz Question Creator (Zeppelin Games Ltd,1989) Arcade

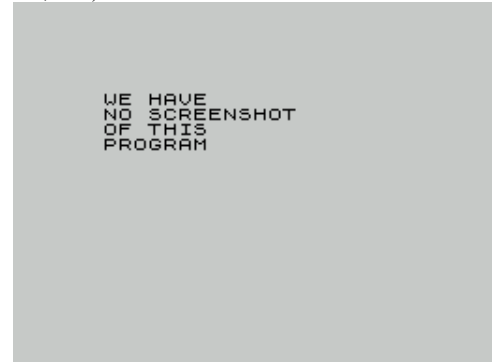

Arcadia (Imagine Software Ltd,1982)
Arcade



Arcane Quest (Kayde Software Ltd,1983)
Text Adventure



Archaic (Spectraxe Tape Magazine,1988)
Arcade

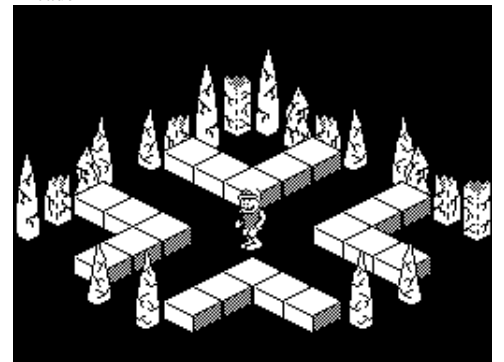

Archimedes' Screw (Applications Software Specialities,1983) Text Adventure



Archiv (Omega-Soft,1984)
Utility: Database



Archivo de Datos en Clave 2 (MicroHobby,1985)
Utility



Archon Collection, The (Electronic Arts,1989)
Compilation



Arctic Antics (Spectrum Computing,1985)
Arcade

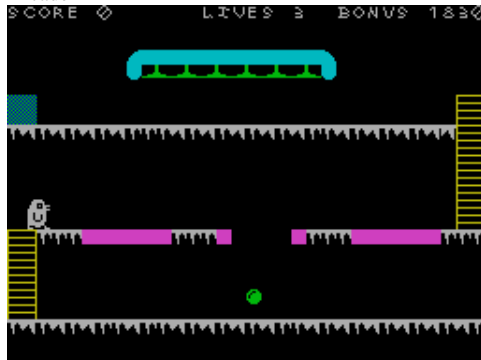

Arcturus (Visions Software Factory,1984)
Arcade



Archivo de Cintas (Microparadise Software,1984)
Utility

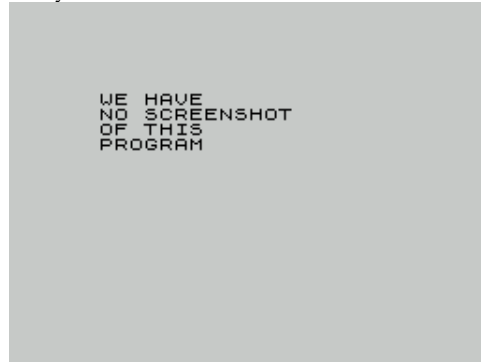

Archon (Ariolasoft UK Ltd,1985)
Arcade



Archon II: Adept (Electronic Arts,1989)
Arcade



Arcticfox (Electronic Arts,1988)
Arcade

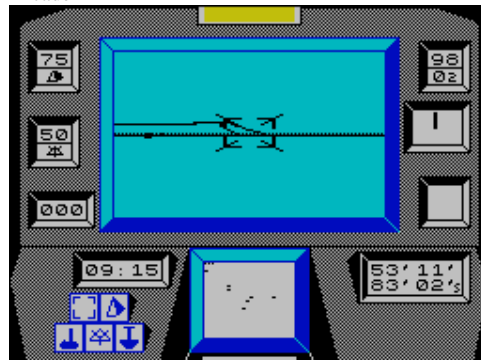

Ardennes (Tk Computerware,1985)
Strategy



Archivo de Datos en Clave 1 (MicroHobby,1985)
Utility

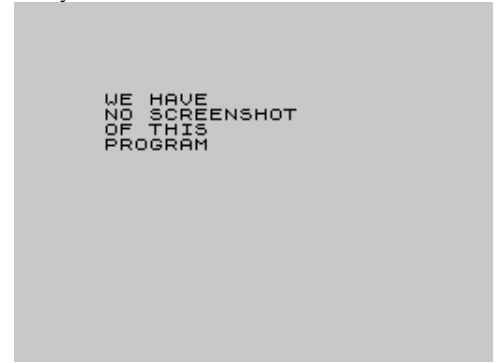

Archon (The RamJam Corporation,1983)
Board/Card Game



Arc of Yesod, The (Thor Computer Software,1985)
Arcade



Arcturan Saga, The (.)
Arcade



Ardonicus 3 (8th Day Software,.)
Text Adventure



Area 51 (Jonathan Cauldwell,2005)
Arcade



A. Remic's 4 Pack (Remsoft Arcade Designs Ltd,1989)
Compilation



A.R.E.N.A. (Vonsoft,1986)
Text Adventure



Argent Warrior (Games Workshop,1984)
Text Adventure



Argonautica (Realtime Games Software Ltd.)
Arcade Adventure

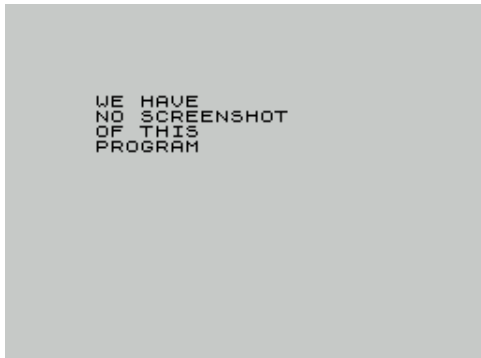

Areas (.)
Utility: Mathematics

SOLUCION: $Area = -21.991149cm^2$ $\pi \times (R^2 - r^2)$

FORMULA:

DATOS: $\pi = 3.141592$

Rad. cir. ma. = 3cm $R = R. c. ma.$

Rad. cir. me. = 4cm $r = R. c. me.$

Area = $-21.991149cm^2$

Deseas otro calculo? (S/N) "L"

Arena (MC Lothlorien Ltd,1985)
Arcade



Arena 3000 (Microdeal,1984)
Arcade



Argo (Bosoft,1984)
Arcade

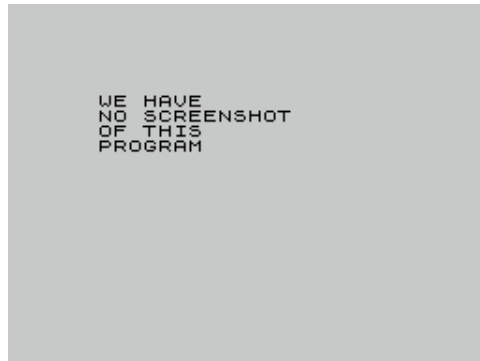

Areas de Figuras Planas (Ediciones y Textos S.A.,1985)
Utility: Mathematics



Arena! (Titan Programs,1983)
Arcade



Ares (MicroHobby,1990)
Arcade Adventure

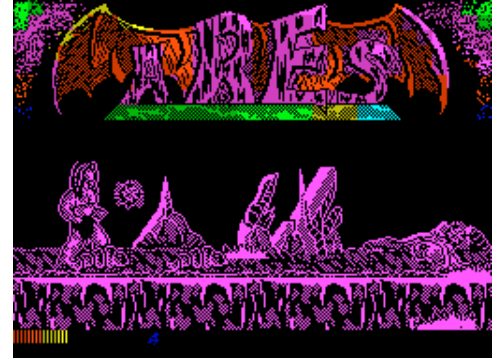

Argon (Grupo de Trabajo Software S.A.,1987)
Arcade



Ari (.)
Utility



Arithmetic - 7-10 Yrs (Micro-De-Bug Consultancy,1984)
Educational



Arithmetic Tutor (.)
Educational

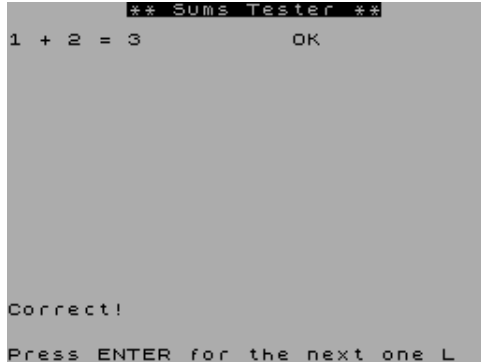

Aritmemori (MicroHobby,1984)
Utility: Spreadsheet

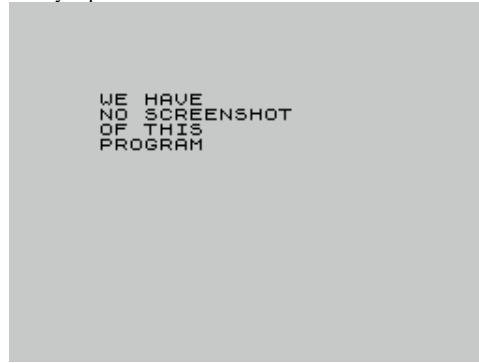

Aritmeticas Basicas (Investronica S.A.,1984)
Educational

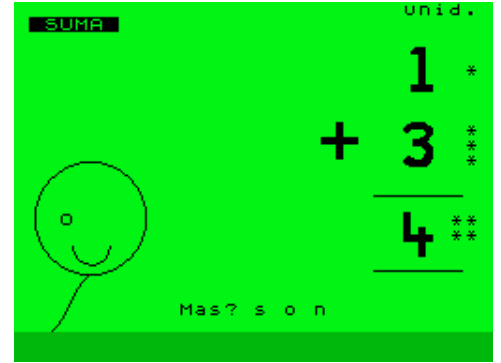

Arkanods (.)
Arcade

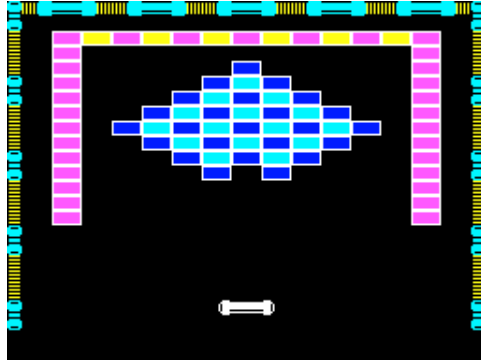

Arkanoid (Imagine Software Ltd,1987)
Arcade



Arkanoid Editor (Mark Alexander,1987)
Arcade Game Development Tool

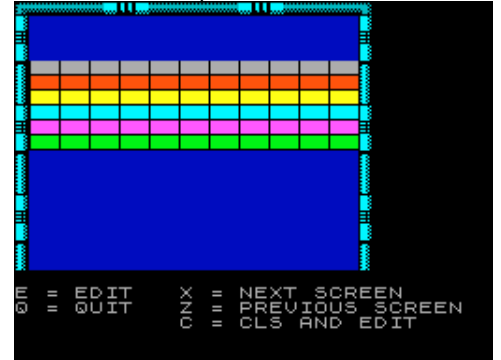

Arkanoid - Revenge of Doh (Imagine Software Ltd,1988)
Arcade

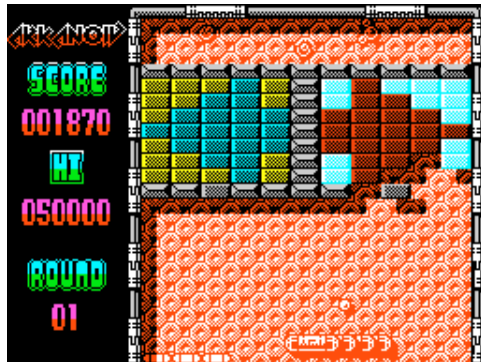

Arkarum (Ultrasoft,1990)
Arcade



Arkos (Zigurat Software,1988)
Arcade



Arlene (The Guild,1991)
Text Adventure



Armageddon (Fashionsoft,1983)
Arcade



Armageddon (Ocean Software Ltd,1983)
Arcade

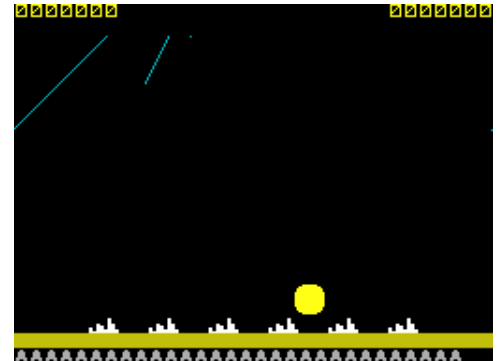

Armageddon (Silversoft Ltd,1983)
Arcade



Armageddon Man, The (Martech Games Ltd,1987)
Arcade

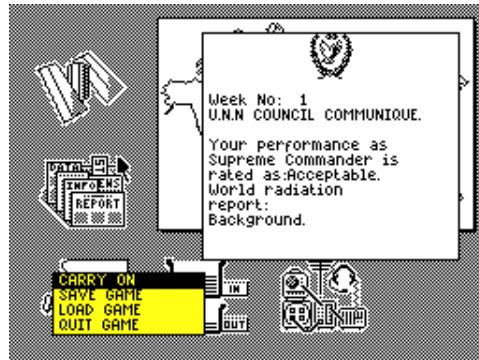

Armalyte (Thalamus Ltd.)
Arcade



Army Moves (Dinamic Software,1986)
Arcade



Arnold (Static Soft,1988)
Text Adventure



Arnold the Adventurer II (Zenobi Software,1992)
Text Adventure



Arrgghh (Go-It-Alone Software,1987)
Arcade



Artcon (Format,1989)
Utility

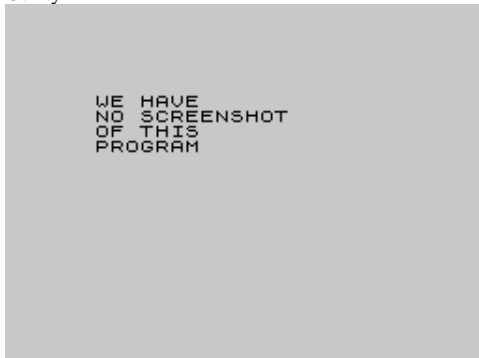

Arnal & Drak (Torasoftware,1991)
Text Adventure

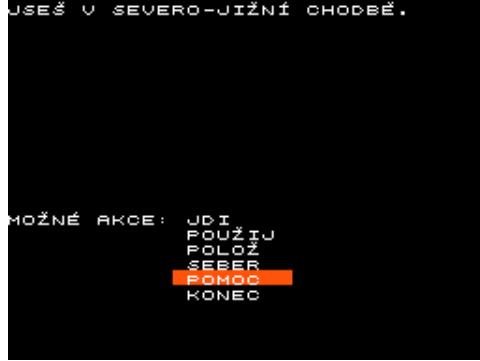

Arnold the Adventurer (Zenobi Software,1990)
Text Adventure



Arnold the Adventurer III (Zenobi Software,1992)
Text Adventure

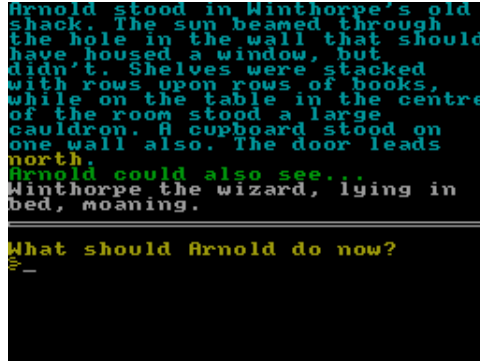

Arrow of Death Part 1 (Digital Fantasia,1983)
Text Adventure



Art Experience Preview (KID Software,1995)
Scene Demo



Arnhem (CCS,1985)
Strategy



Arnold the Adventurer 1 + 2 (Zenobi Software,)
Compilation



Arquimedes XXI (Dinamic Software,1986)
Text Adventure



Arrow of Death Part 2 (Digital Fantasia,1983)
Text Adventure



Artic Assembler (Artic Computing Ltd,1982)
Utility: Assembler/Disassembler/Monitor

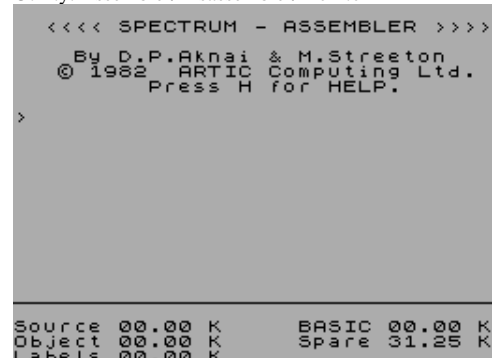

Artillery (Bernhard Lutz,1984)
Simulation



Artist II, The (Softtechnics,1986)
Utility: Drawing



Art of Scrunk, The (The Lords,1987)
Scene Demo



Art Studio, The (Rainbird Software Ltd,1985)
Utility: Drawing



Artworx (The Power House,1986)
Utility: Drawing



Artist (Dinamic Software,1984)
Utility: Drawing

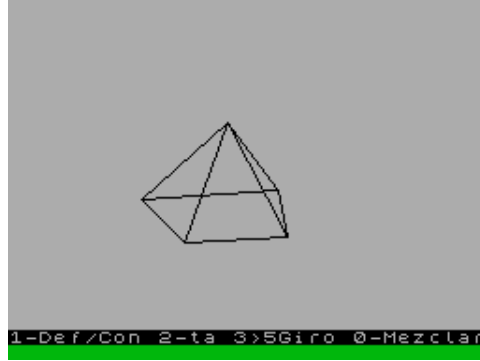

Artist, The (Softtechnics,1985)
Utility: Drawing



Art-o-Matic (Print'n'Plotter Productions,1986)
Utility: Screen Manipulation

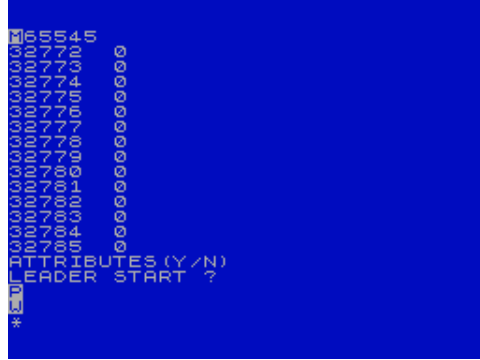

Artura (Gremlin Graphics Software Ltd,1989)
Arcade



Arty (Spartan Software,1984)
Utility: Drawing

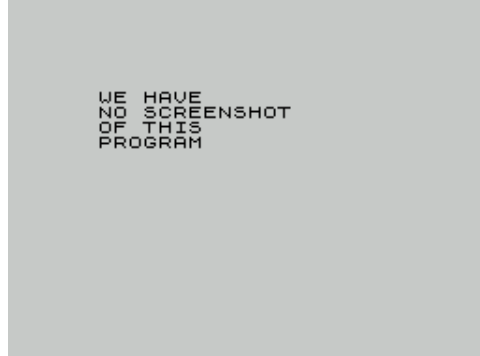

Artist 2K4 (Mauricio Munoz Lucero,2004)
Arcade



Art Master (Summit Software,1986)
Utility: Drawing

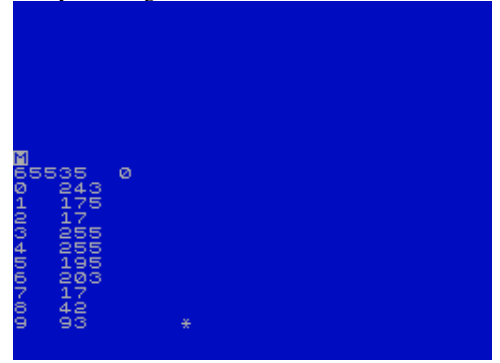

Art Studio (Michael Ferguson,1987)
Utility: Drawing



Artwork Editor (Greg Fox,1997)
Utility: Drawing

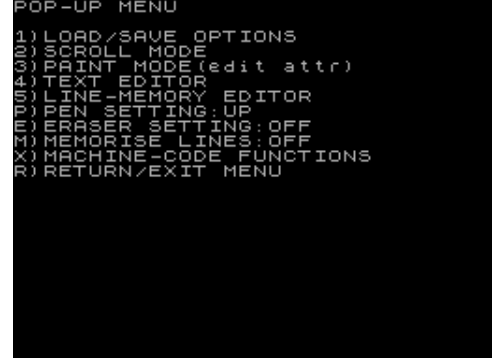

Asaroth - Angel of Death (Hewson Consultants Ltd.)
Arcade Adventure



ASC (Tiger's Claw,1996)
Scene Demo

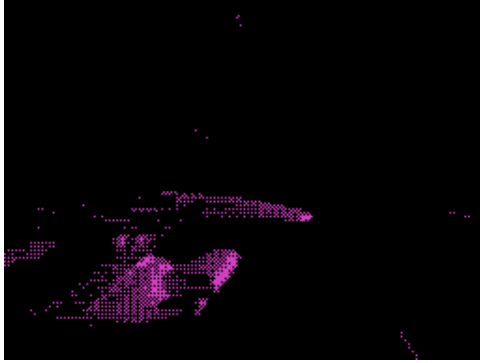

Ascot (Valuesoft,1983)
Arcade



Ashkeron (Mirrorsoft Ltd,1985)
Text Adventure



Aspar GP Master (Dinamic Software,1988)
Arcade



Assassin's Guild, The (The Adventure Workshop,1995)
Text Adventure



Ascensor, El (MicroHobby,1985)
Arcade



Ascot (Virgin Books,1983)
Arcade

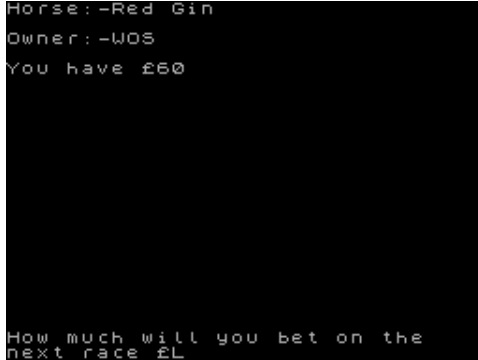

Asiento (Interceptor Micros Software,1987)
Text Adventure



Aspect (Bug-Byte Software Ltd,1982)
Utility: Assembler/Disassembler/Monitor



Assault Course (Players Premier Software,1990)
Arcade



Ascot (Silicon Joy,1984)
Arcade



Ashes, The (Pulsonic,1984)
Simulation

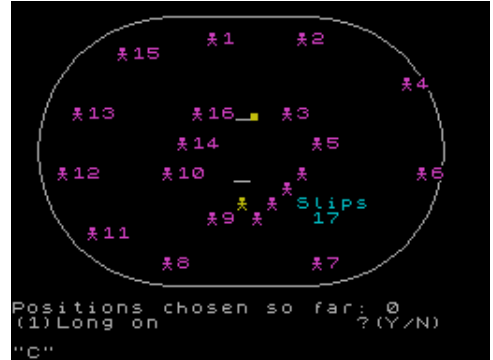

Asirus Settler, The (Asirus Software,1986)
Simulation

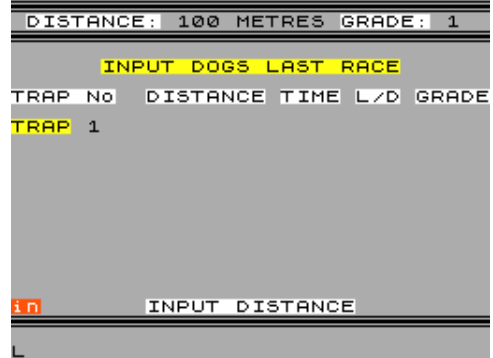

Assassin (Psychaedelic Hedgehog Software,1990)
Arcade Adventure

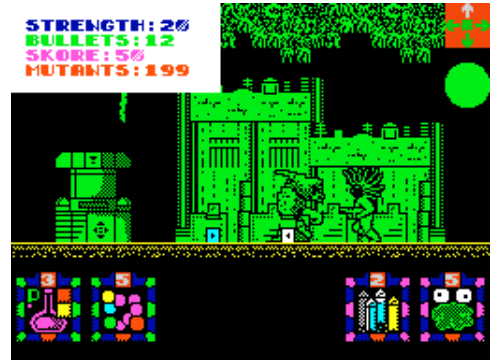

Assault of the Ogroids (Sinclair User,1987)
Board/Card Game



Assemblage (Artic Computing Ltd,1986)
Compilation



Assembler (Enigma Software Developments,1992)
Utility: Assembler/Disassembler/Monitor



Assembler and Machine Code Debugger (Roybot,1984)
Utility: Programming



Assorty Megademo (Dream Makers Software,1994)
Scene Demo



Asteroids (Abbe Electronics,1983)
Arcade



Assembler (.)
Utility: Assembler/Disassembler/Monitor

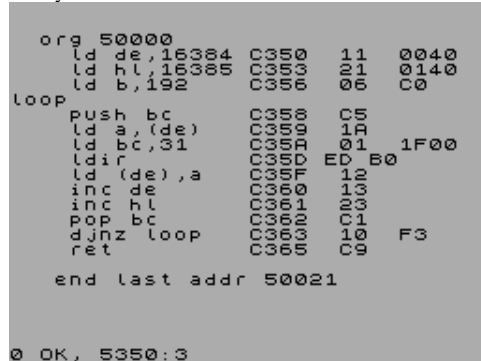

Assembler (MicroHobby,1986)
Utility: Assembler/Disassembler/Monitor



Assembler Sources (.)
Utility: Assembler/Disassembler/Monitor



Asterix and the Magic Cauldron (Melbourne House,1986)
Arcade



Asteroids (Fontana Publishing,1982)
Arcade

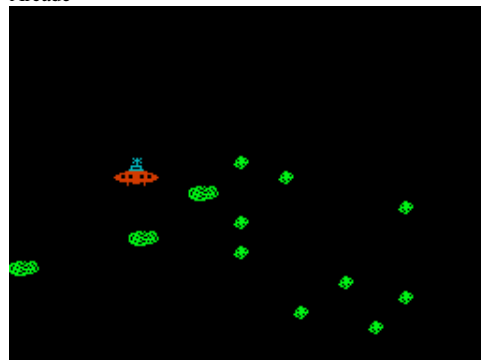

Assembler (Add-On Electronics Ltd,1983)
Utility: Assembler/Disassembler/Monitor



Assembler (Pi Software,1983)
Utility: Assembler/Disassembler/Monitor



Assignment East Berlin (Sterling Software,1985)
Text Adventure

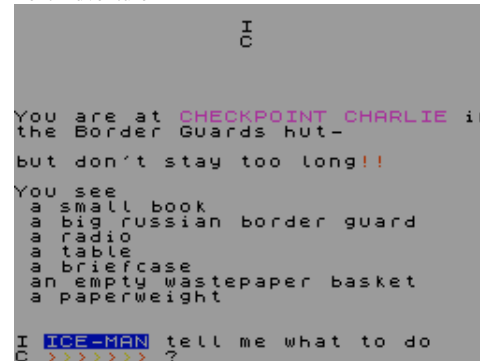

Asteroids (Microparadise Software,1984)
Arcade



Asteroids (Your Computer,1985)
Arcade



Asteroids Ahead (Anco Software Ltd,1983)
Arcade



Asteroids Ahead! (ZX Computing,1983)
Arcade

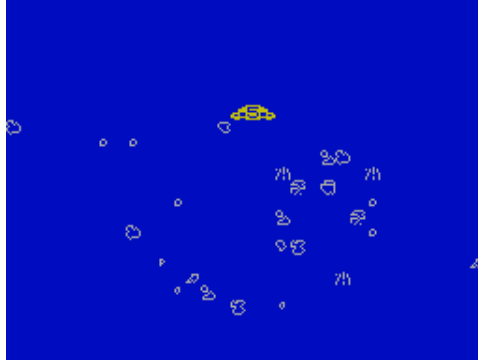

Astra (Grupo de Trabajo Software S.A.,1987)
Arcade



Astro (MicroHobby,1985)
Arcade

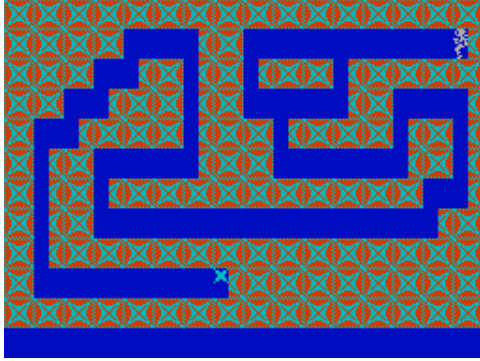

Astro 1 (MicroHobby,1985)
Arcade



Astroball (Digital Reality [1],1992)
Arcade

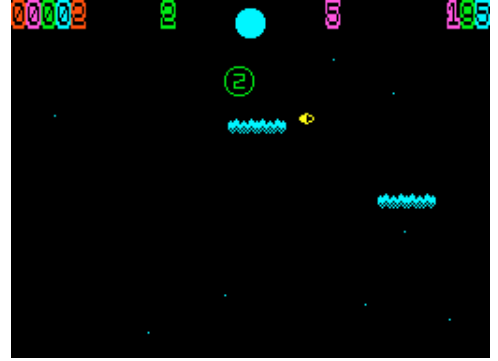

Astro Blaster (Quicksilva Ltd,1983)
Arcade

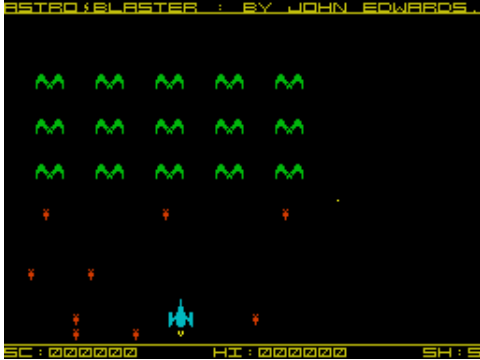

Astrocade (Data Design Systems,1986)
Compilation



Astrocalc (Astrocalc,1983)
Educational



Astroclone (Hewson Consultants Ltd,1985)
Arcade



Astrocode (Finsbury Software,1984)
Board/Card Game



Astrodata 3000 issue 1 (Creativos Editoriales S.A.,1985)
Covertape



Astrodata 3000 issue 2 (Creativos Editoriales S.A.,1985)
Covertape



Astrodata 3000 issue 3 (Creativos Editoriales S.A.,1985)
Covertape



Astrolabe (Eclipse Software,1985)
Utility



Astrologia (MicroHobby,1985)
Simulation



Astro Maths (Scisoft,1984)
Educational



Astronomer (CP Software,1984)
Utility: Astronomy/Astrology



Astronomia II (Software Editores.)
Utility: Astronomy/Astrology



Astronomy (Scisoft,1985)
Educational



Astrologia (Multisoft Informatica Ltda,1985)
Utility: Astronomy/Astrology

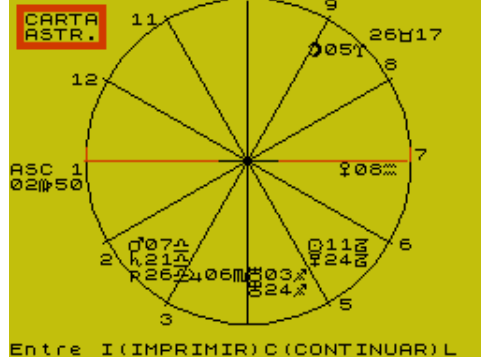

Astron (DKTronics Ltd,1983)
Utility: Assembler/Disassembler/Monitor
ASTRON 48 © DKTRONICS 1983

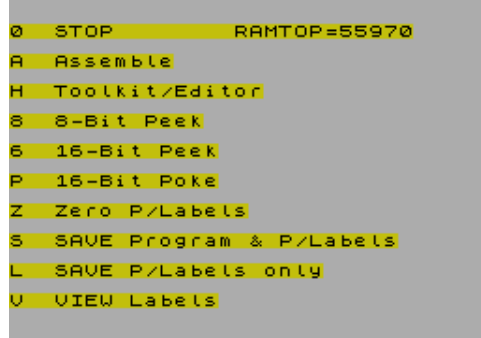

Astronomer II (CP Software,1985)
Utility: Astronomy/Astrology

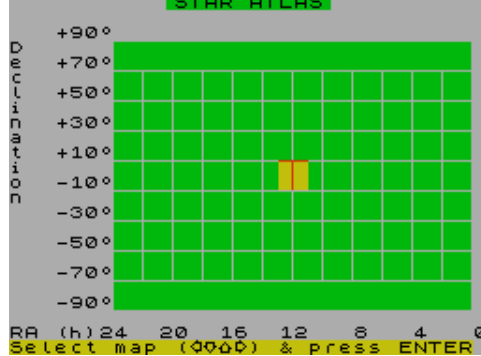

Astronomy (Macmillan Software Ltd,1985)
Educational



Astronomy Compilation (Skysoft,1985)
Educational



Astro Marine Corps (Dinamic Software,1989)
Arcade

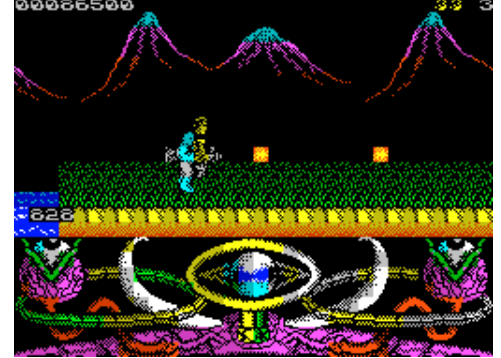

Astronaut (.)
Simulation

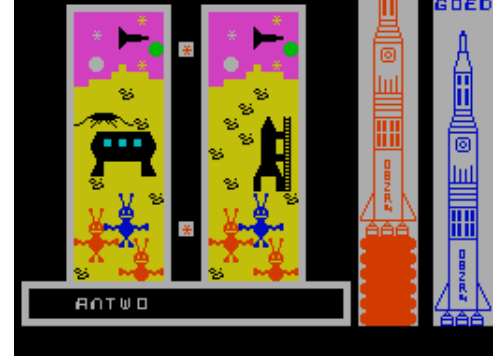

Astronomia (Jaime Olivella.)
Educational



Astronomy (Piper Books Ltd,1984)
Utility



Astronut (Software Projects Ltd,1984)
Arcade



Astroplaner (Romik Software,1984)
Arcade



Astro Scramble + Tax Man (C-Tech,1983)
Compilation



Astrum+ (Bradway Software,1988)
Utility: Programming



Ataque a la Flota (Sound On Sound,1985)
Board/Card Game



Atari Future 1, The (Heep Soft,1989)
Scene Demo



Astro Scramble (C-Tech,1983)
Arcade



Astrotutor (Astrocalc,1987)
Educational



A.T.A.C. (Gadtek Games,1987)
Arcade



Ataque de Naves (MicroHobby,1985)
Arcade



Atari Future 2, The (Heep Soft,1989)
Scene Demo



Astro-Scramble (R. Bhattacharya,1983)
Arcade



Astro-Wars (Precision Software Engineering,1983)
Arcade



Ataque a la Ciudad (Microparadise Software,1984)
Arcade



Ataque paracaidista (Micromania [2],1985)
Arcade



A-Team, The (Zafiro Software Division,1989)
Arcade

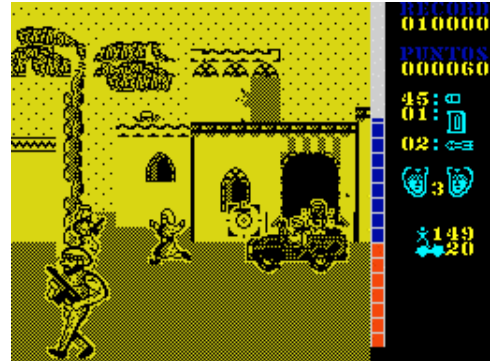

Atenas (EP Software,) Arcade

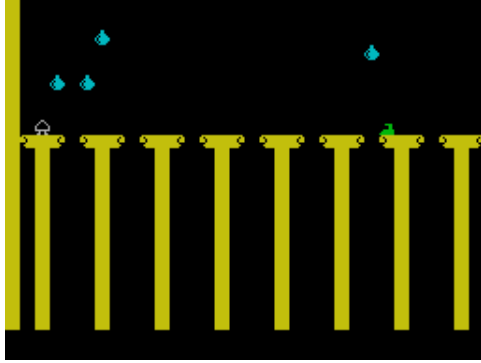

Aterrizaje en Saturno (MicroHobby,1985) Arcade

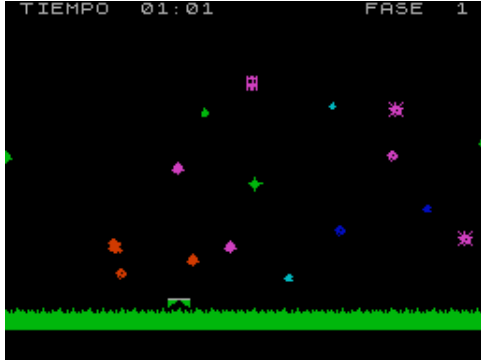

Athlete (Buffer Micro Ltd,1984) Arcade

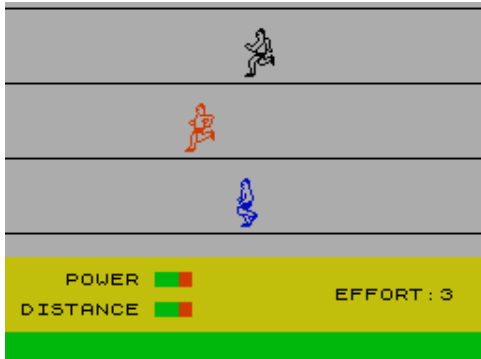

Atlantis (M&J Software,1984) Text Adventure

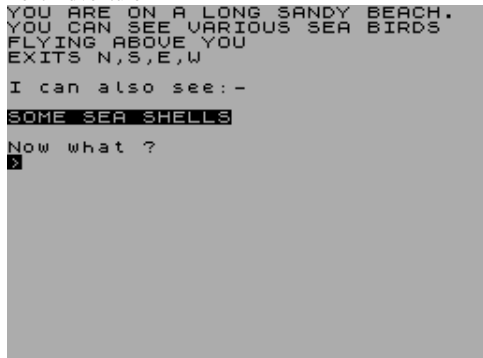

Atomic Robo-Kid (Activision Inc.) Arcade



Atentado (MicroHobby,1985) Arcade

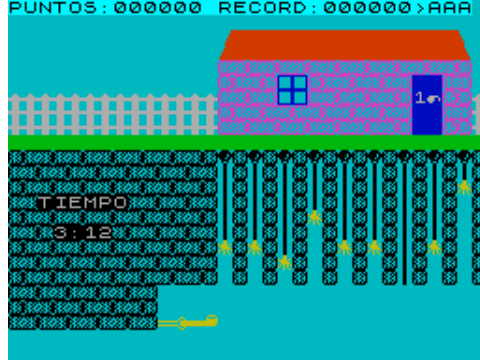

ATF (Digital Integration,1988) Simulation

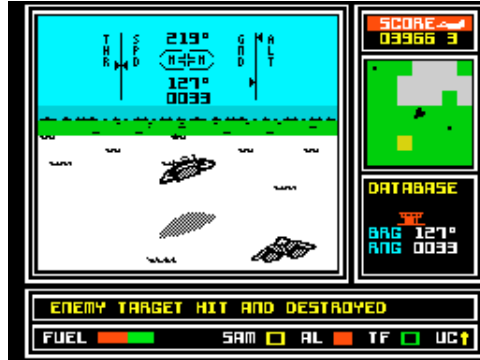

Atic Atac (Ultimate Play The Game,1983) Arcade

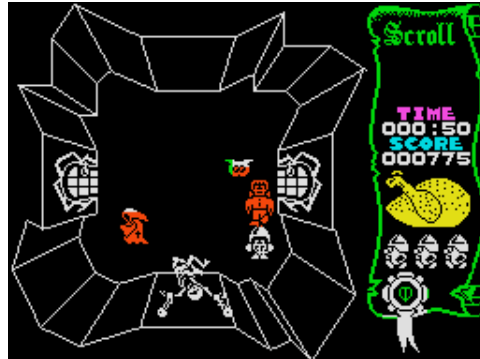

Atlas Assignment, The (Virgin Games Ltd,1983) Text Adventure

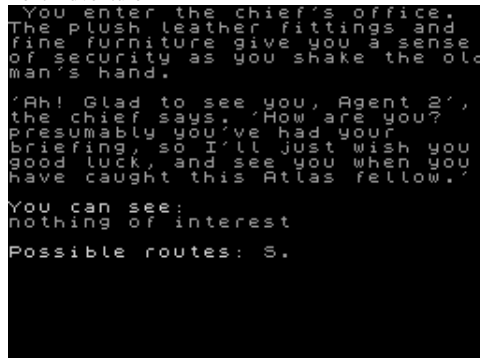

Atomix (Ultrasoft,1990) Arcade

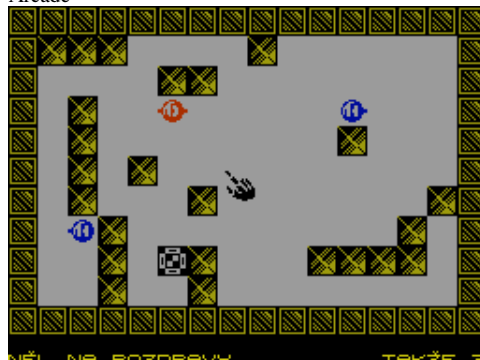

Aterrizo como Puestas (MicroHobby,1984) Arcade



Athena (Imagine Software Ltd,1987) Arcade

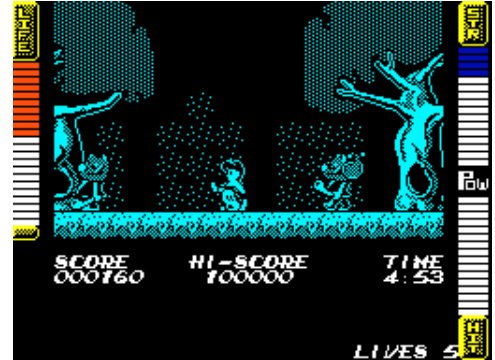

Atlantis (Anirog Software,1985) Arcade



Atom Ant (Hi-Tec Software Ltd,1990) Arcade

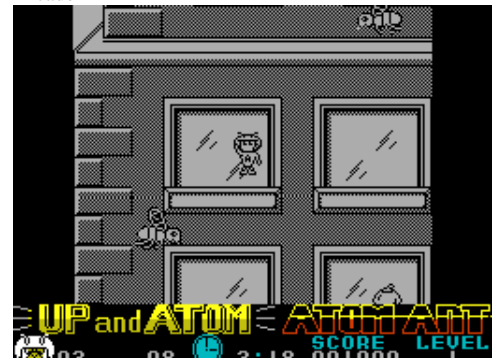

Atomix (US Gold Ltd.) Simulation



Atomix II: Hexagonia (Proxima Software,1991)
Arcade

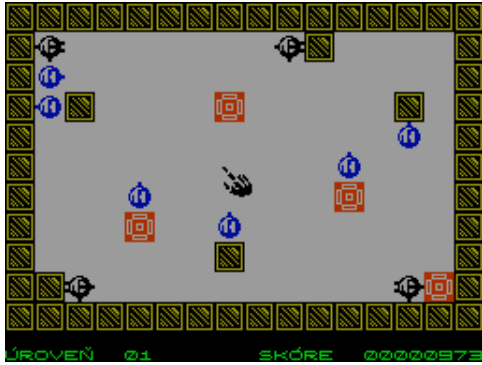

Atoms (Sonic Software,1982)
Arcade



A To Snad Ne ?! (.)
Text Adventure

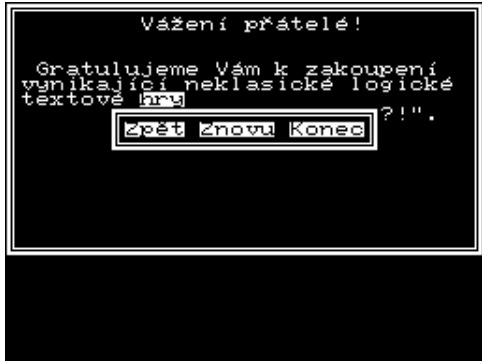

Atracador, El (MicroHobby,1985)
Arcade



Attack of the Alien Waters (Green Fish Software Enterprise,1985) Arcade



Atomreaktor (MS Software,1984)
Simulation

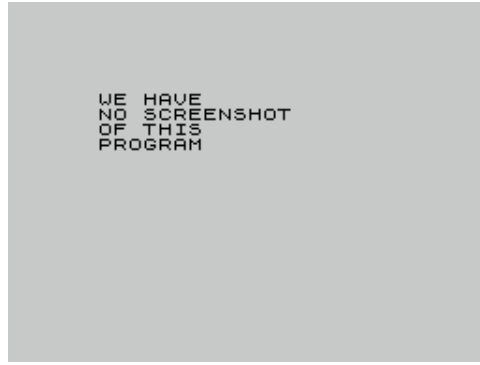

Atoms (Taurus Computer Design,1982)
Arcade



A to Z (IEC Software,1986)
Educational



ATRAM (Websters Software,1984)
Simulation

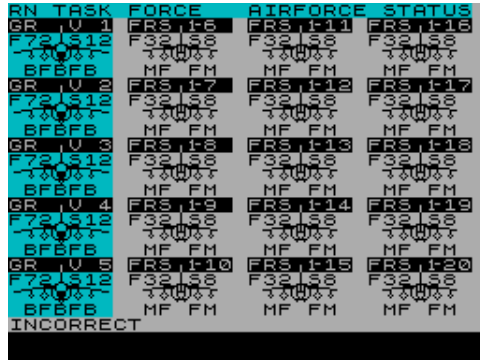

Attack of the Empire (Chibur,1985)
Arcade



Atoms (Cornhill Services,1983)
Arcade



Atoms and Moles (Griffin Software,1984)
Educational

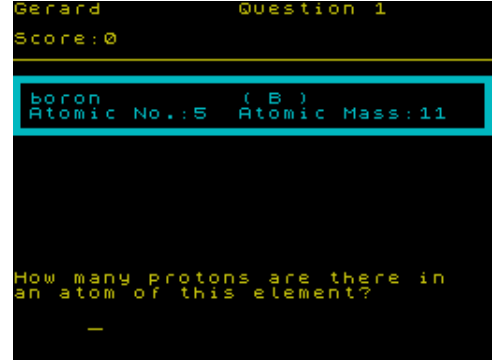

ATP Tour Simulator (Proxima Software,1990)
Sport

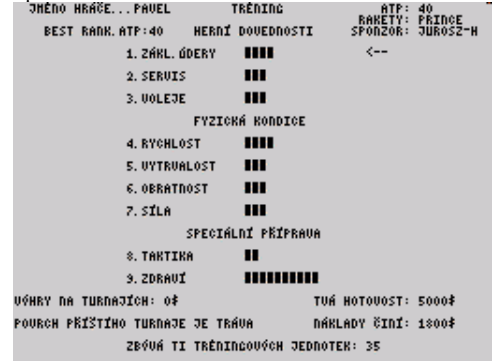

Atrog (Zafiro Software Division,1988)
Arcade



Attack of the Killer Tomatoes (Global Software,1986)
Arcade



Attack of the Mushroom People (Global Software,1985)
Arcade Adventure



Attack of the Mutant Zombie Flesh Eating Chickens from Mars (Software Projects Ltd.) Arcade



Attack on New York (Fry Software,1983)
Arcade



Attactics (East London Robotics Ltd,1983)
Arcade

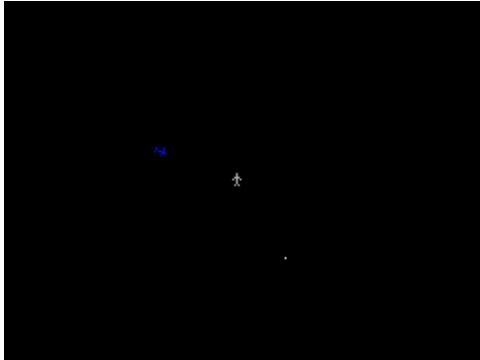

At the Tapes (Lambourne Games,1984)
Strategy

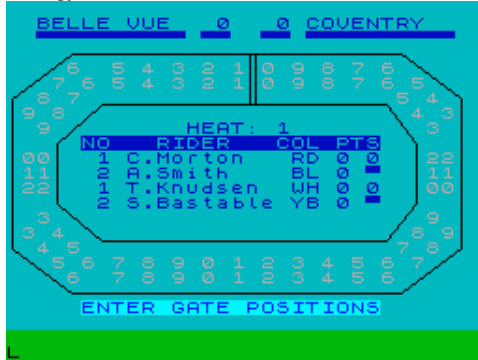

Attribute Twiddler (Spectrum Computing,1984)
Utility: BASIC Related



ATV - Amateur Television (R.E. Stephens,1983)
Utility

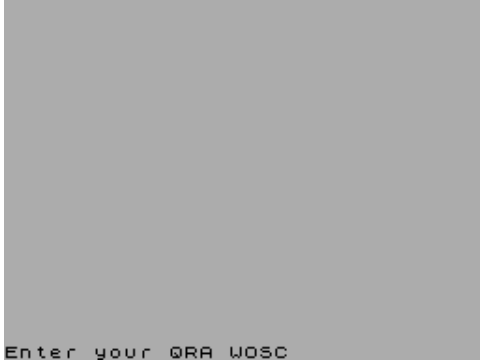

ATV Simulator (Code Masters Ltd,1987)
Arcade



Audio Frequency Analyser (MBC/Atlantic Soft,)
Utility: Sound Manipulation

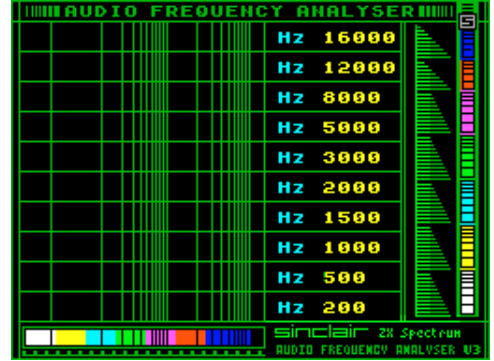

Audio Frequency Generator (W. Janowsky,1989)
Utility: Sound Manipulation

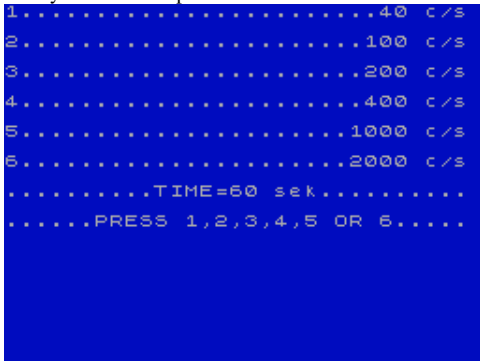

Audio Spectrum issue 1 (Audio Spectrum,)
Covertape



Audio Spectrum issue 2 (Audio Spectrum,1987)
Covertape



Audio Spectrum issue 3 (Audio Spectrum,)
Covertape



Audio Spectrum issue 4 (Audio Spectrum,)
Covertape



Audio Spectrum issue 5 (Audio Spectrum,)
Covertape



Audio Spectrum issue 6 (Audio Spectrum,)
Covertape



Audio Spectrum issue 7 (Audio Spectrum,)
Covertape



Auf Wiedersehen Monty (Gremlin Graphics Software Ltd,1987)
Arcade



Auf Wiedersehen Monty (The Creative Technology Institute,) Scene Demo



Auf Wiedersehen Pet (Tynesoft,1984)
Arcade

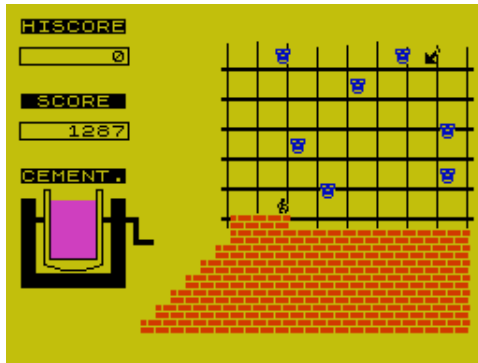

Aunt Velma's Coming to Tea! (Delbert the Hamster Software,1991) Text Adventure



Aural Quest (Star Dreams,1984)
Text Adventure



Aurascope (Zenobi Software,1992)
Text Adventure



Au Sinclair de la Lune (De Wit Productions Ltd,1985)
Scene Demo

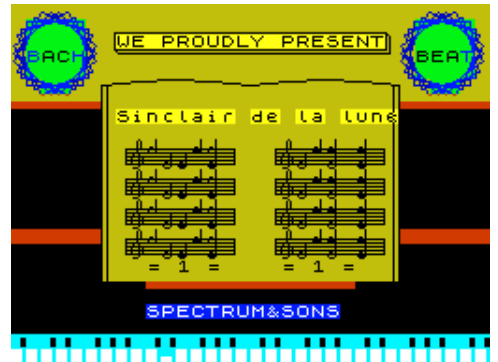

Austerlitz (KW Software,1985)
Strategy



Austerlitz 1805 (CCS,1989)
Strategy



Australian Games (US Gold Ltd,1990)
Sport



Australian Rules Football (Again Again,1989)
Arcade



Autobahn (H. Schiehl,1983)
Arcade

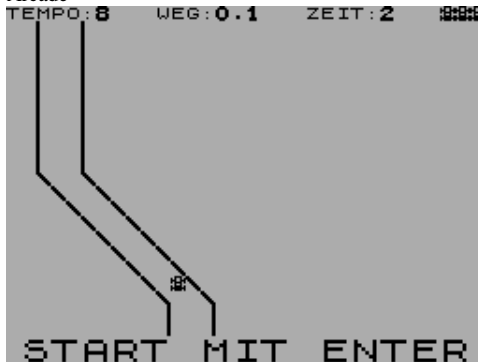

Autobus, El (Micromania [2],1985)
Arcade



Auto Chef (CCS,1982)
Simulation

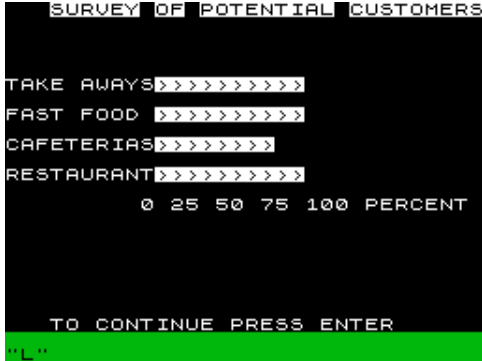

Auto Data (ERC Computer Services,1984)
Utility



Auto Kursiv (Klaus Jahn,1987)
Utility: Font/UDGs



Automania (Mikro-Gen Ltd,1984)
Arcade

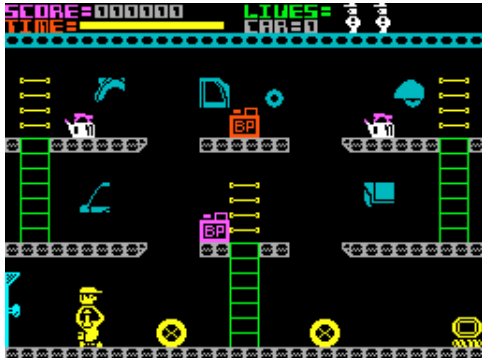

Automatic Muse (Your Sinclair,1992)
Utility: Music Creation

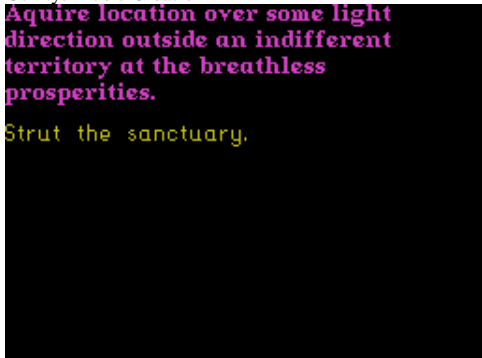

Auto Concentration (Scene+,1994)
Board/Card Game

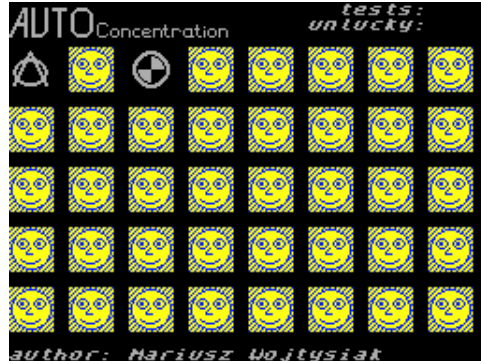

Autofade (JK.)
Utility: Screen Manipulation

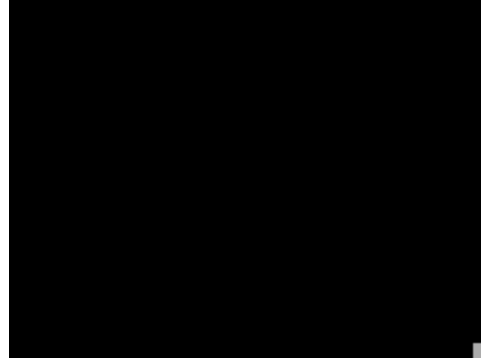

Auto Line Number Routine (.)
Utility: BASIC Related

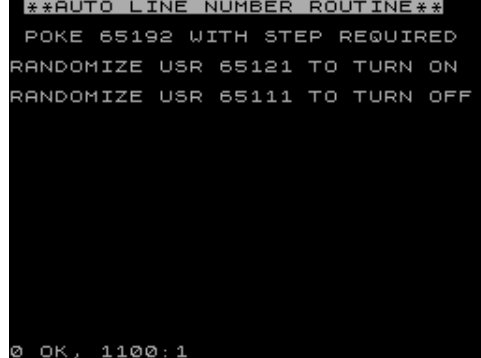

Automaticky Bubenik (Daniel Rodny,1986)
Utility: Music Creation

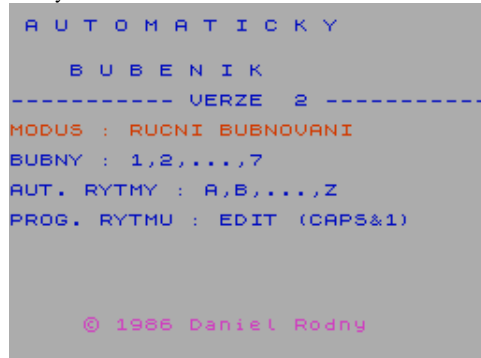

Automonopoli (Automata UK Ltd,1983)
Board/Card Game



Autocrash (Zigurat Software,1991)
Arcade

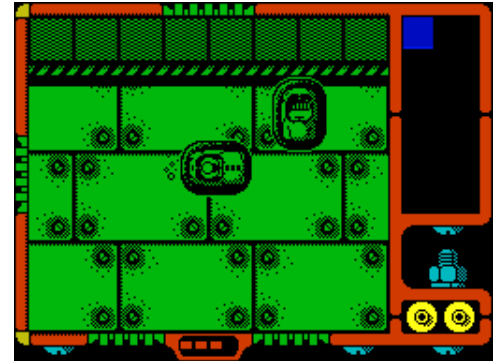

Autokopy 3 (Tidd,1983)
Utility: Copier

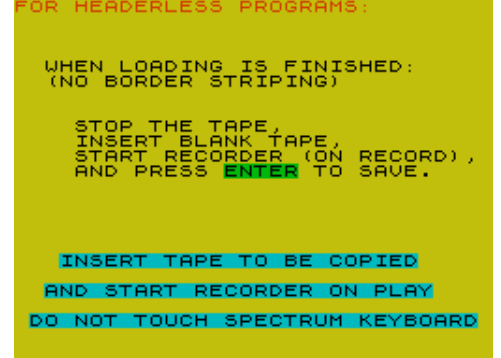

Autoload (Alchemist Research,)
Utility



Automatic Morse (Shiva Publishing Ltd,1983)
Utility



Autorennen (EMM Software,1983)
Arcade

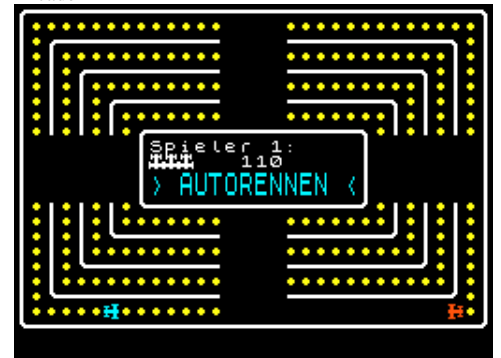

Auto-Sonics (Buttercraft Software,1984)

Utility: Sound Manipulation

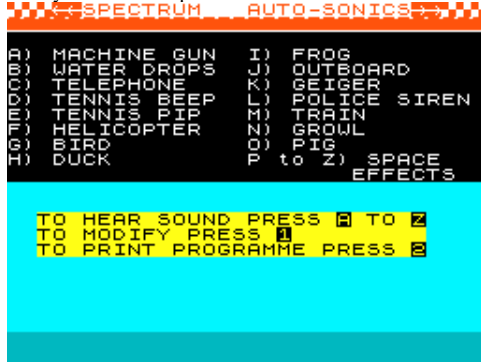

Avalon (Hewson Consultants Ltd,1984)

Arcade Adventure



Aven (Proxima Software,1993)

Arcade



Aventura (.,1989)

Text Adventure



Aventura del Hacker, La (Juan Alonso Exposito

Escrig,1989)

Text Adventure



Autostopista Galactico (Ventamatic,1984)

Arcade



Avalon + Dragontorc (Hewson Consultants Ltd,)

Compilation



Avenger (Abacus Programs,1982)

Arcade



Aventura Brutal, La (Rock'n'Soft,1994)

Text Adventure



Aventura Espacial, La (Aventuras AD S.A.,1990)

Text Adventure



Avalanche (CCS,1991)

Strategy



Avatar, El (MicroHobby,1984)

Arcade



Avenger (Gremlin Graphics Software Ltd,1986)

Arcade Adventure

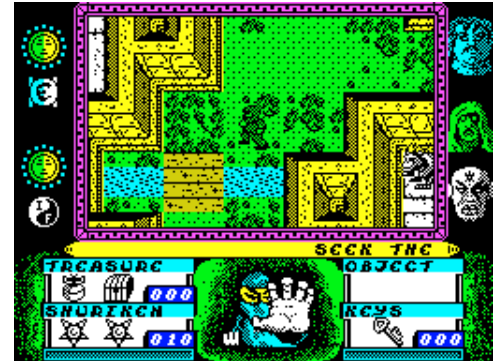

Aventura del Dragon, La (Pepsi Soft,1991)

Text Adventure



Aventura Original, La (Aventuras AD S.A.,1989)

Text Adventure



Aventura Spectrum (Kak,2006)

Text Adventure

Raudos cual SpeedLock, os dirigis hacia casa para montar el spectrum. Lo desempaquetais no muy cuidadosamente y conectais todos los cables. Demonios! Quien se aclara con esto del ear y el mic? En fin, que ya estais dispuestos a dar los primeros pasos.

- 1 - Cargar el manic miner
- 2 - Mirarse el manual

Averages (Spartan Sport Association,1986)

Utility

SELECT ROUTINE: (s=stop:v=save)

- E = ENTER NAMES OF PLAYERS
- 1 = ENTER BATTING DETAILS
- 2 = ENTER BOWLING DETAILS
- 3 = LIST NAMES OF PLAYERS
- 4 = SORT ALPHABETICALLY
- 5 = SORT BATTING/BOWLING
- 7 = FILE AVERAGES ONTO TAPE
- 8 = VIEW BAT AVS (UNSORTED)
- 9 = VIEW BOWL AVS (UNSORTED)
- C = VIEW CATCHES TAKEN

Averages (Hobby Software,1985)

Sport

WE HAVE NO SCREENSHOT OF THIS PROGRAM

Averno (Procin Soft Line,1989)

Arcade

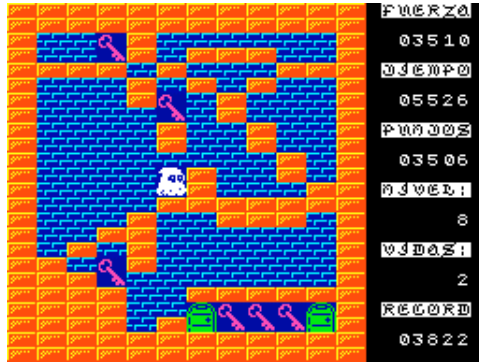

Aviatak (Slogger Software,1985)

Arcade



Avoir (Balsoft Designs,1985)

Text Adventure

You are inside your space craft. Visible exits are: down

Objects in view
the jet buggy
The onboard computer turned off

What now ?

WOS

Avon (Topologika,1989)

Text Adventure



Awaken (Rage Tech/Army,1999)

Strategy



Awari (ERE Informatique,1983)

Board/Card Game

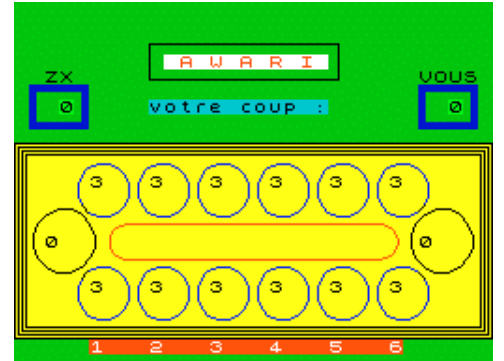

Awari (Orbis Publishing Ltd,1985)

Board/Card Game



Awari (Sinclair Programs,1983)

Board/Card Game



Awari + Rescate del Tesoro (Investronica S.A.,)

Compilation



AX.25 Packet Radio (HA5DI/HA5OB,1987)

Utility



Axe (Top Ten Software,1987)

Text Adventure



Axe of Kolt, The (FSF Adventures,1990)

Text Adventure

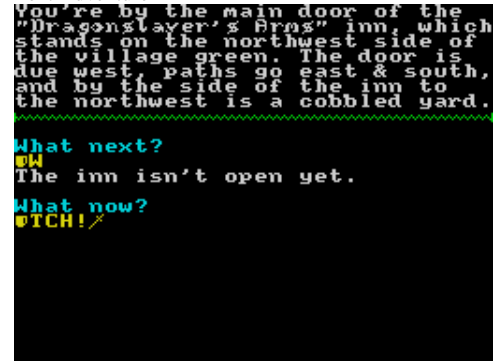

Axons (Software Saur,1991)
Arcade



AY Driver (Softhouse Ltd,1992)
Utility: Music Creation



Azatoth (MicroHobby,1985)
Arcade



Aztec: Hunt for the Sun-God (Hill MacGibbon,1984)
Arcade Adventure

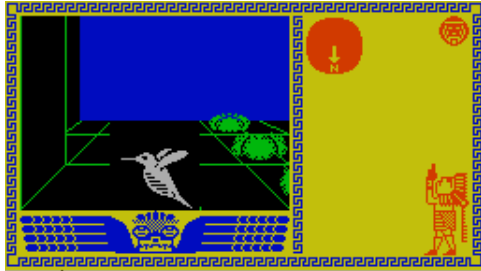

into the east.
WHAT IS HERE?
I'm Hwee-Tsee. I've been sent to help you. While you were in the forest evil

Babaliba (Dinamic Software,1985)
Arcade



AY 3-8910 Demo (John Dalthon,1988)
Scene Demo



Ayforia Kingdom (Silva Soft,1990)
Text Adventure

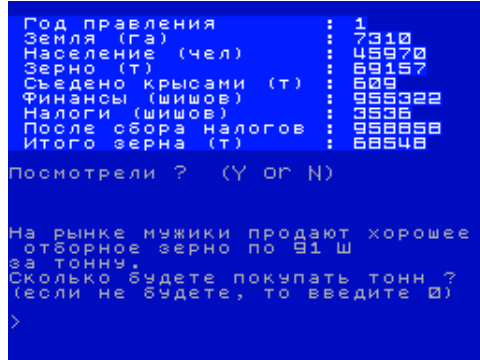

Azimuth Head Alignment Kit (Interceptor Micros Software,1989) Utility



Aztec Assault (Zenobi Software,1992)
Text Adventure



Babbage issue 00 (Producciones Cicero S.A.,)
Covertape



AY 3 Demo (Trash Soft,1992)
Scene Demo



A.Y. Tracker (Jonathan Cauldwell,1992)
Utility

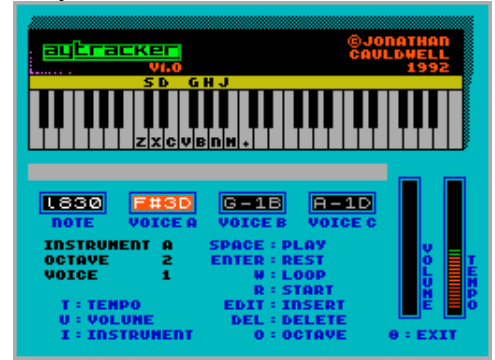

Aztec (Luca Bordini,1986)
Arcade Adventure

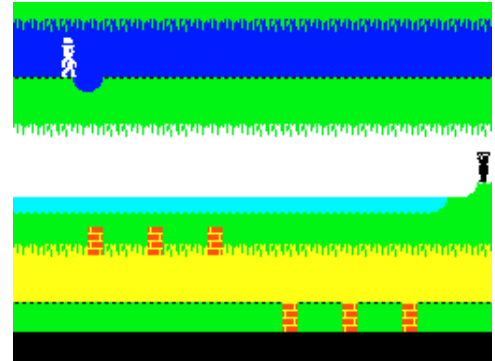

Baand-Katalog II (MD,1983)
Utility



Babszem Jatek (Laszlo Nyitrai,1998)
Board/Card Game

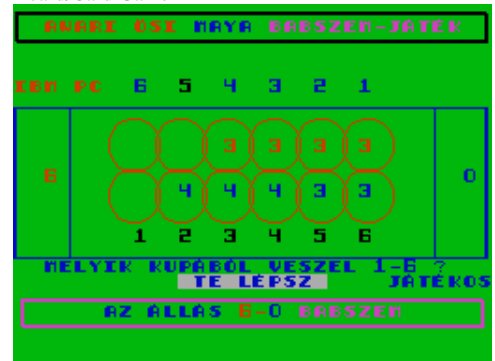

Baby Frog (MicroHobby,1985)
Arcade

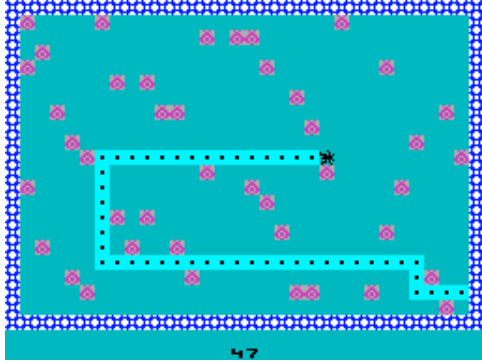

Backer (Andrew Giles,1983)

Utility: Copier

BACKER V 2.0

© 1983 Andrew Giles

Warning: the use of this program
may be an offence.

Select:
1 LOAD
2 SAVE
3 VERIFY
4 END

Backgammon (Hewson Consultants Ltd,1983)

Board/Card Game

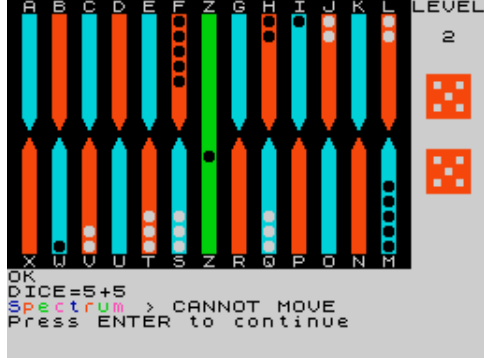

Backgammon (Microparadise Software,1984)

Board/Card Game



Backgammon (Pi Software,1983)

Board/Card Game

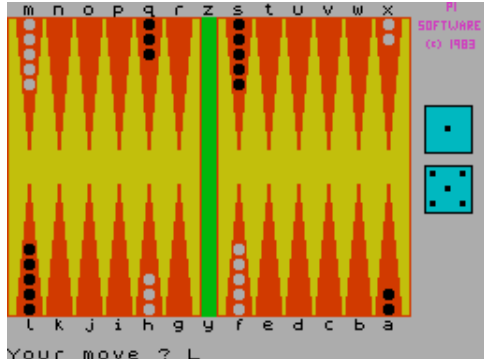

Babylon 5 (Trolls,1999)

Text Adventure

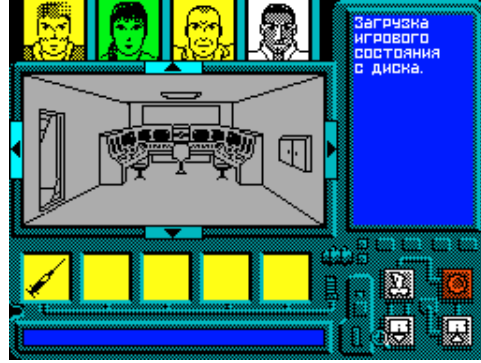

Backgammon (16/48 Tape Magazine,1985)

Board/Card Game

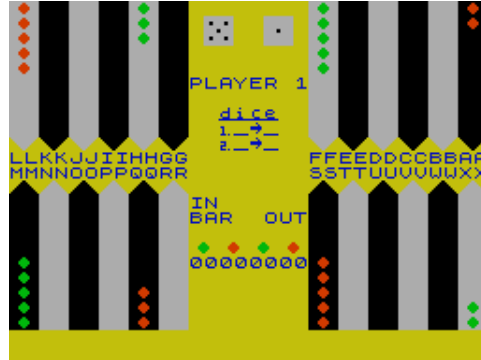

Backgammon (K. Archer,1982)

Board/Card Game



Backgammon (Microware,1983)

Board/Card Game



Backgammon (Sinclair Research Ltd,1983)

Board/Card Game

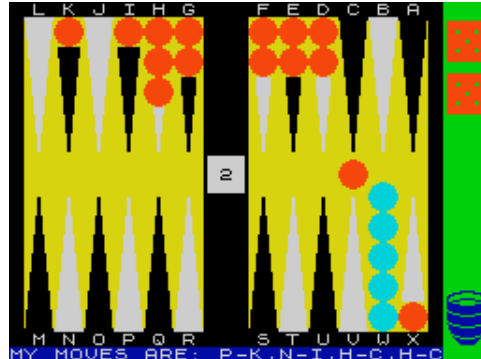

Back Boogie (Your Computer,1985)

Utility: Music Creation



Backgammon (CDS Microsystems,1988)

Board/Card Game

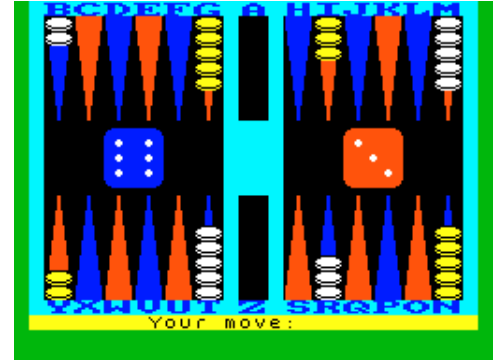

Backgammon (Memotronic,1984)

Board/Card Game



Backgammon (Oasis Software,1984)

Board/Card Game

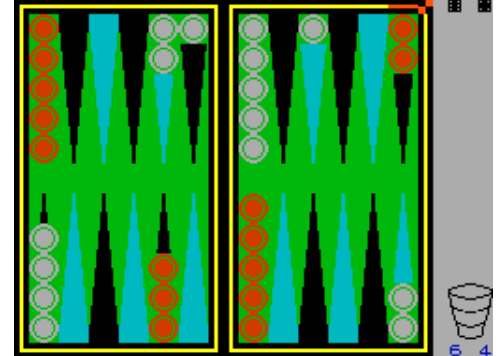

Backgammon (Spartan Software,1984)

Board/Card Game



Back on the Burple! (XFAWORLD Software,2006)
Arcade



Back to the Future (Electric Dreams Software,1985)
Arcade Adventure



Back to the Future Part III (Image Works,1991)
Arcade



Backup Para el Interface Beta (MicroHobby,1986)
Utility



Bac-Pac (Camel Micros,1984)
Arcade

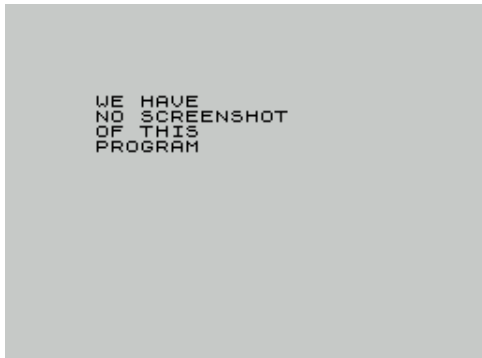

Backpackers Guide to the Universe (Fantasy Software [1],1984)
Arcade



Back to the Future Part 2 + 3 (Image Works,1991)
Compilation



Backup (Technology Research Ltd.)
Utility: Copier



Backup Para el Interface Beta V3.0 (MicroHobby,1986)
Utility

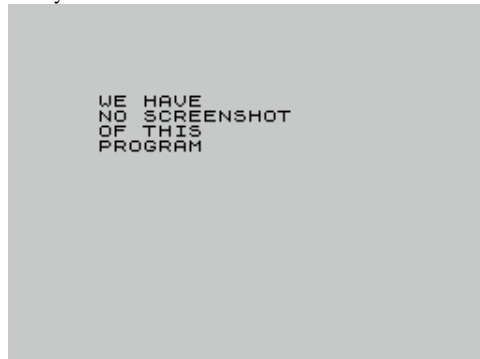

Bad Job (Pavel Nikitin,1992)
Scene Demo

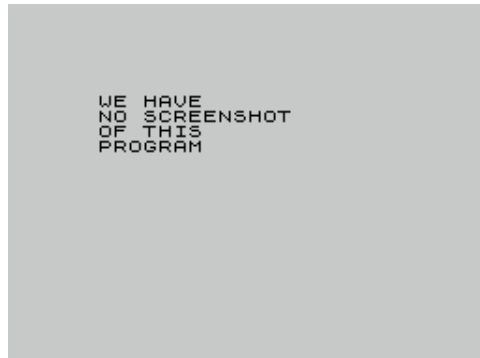

Back to Skool (Microsphere,1985)
Arcade



Back to the Future Part II (Image Works,1990)
Arcade



Backup MF1 (Trident Software,1990)
Utility: Copier

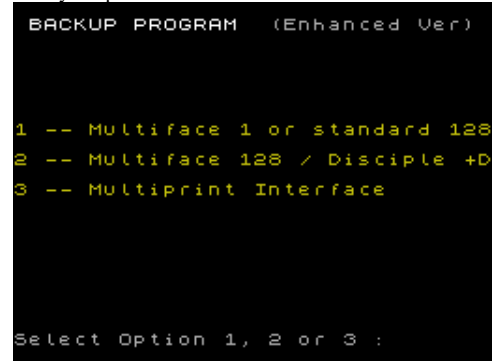

Backupz (Patman,1988)
Utility: Copier

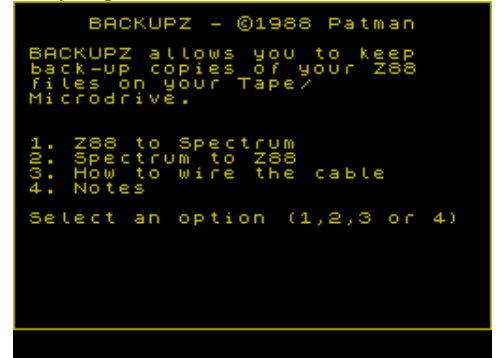

Badlands (Domark Ltd,1990)
Arcade



Bad Night (Palas,1987)
Text Adventure

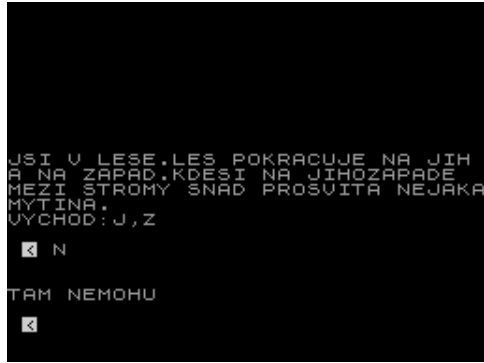

Balistica (MicroHobby,1985)
Utility



Ball Breaker (CRL Group PLC,1987)
Arcade

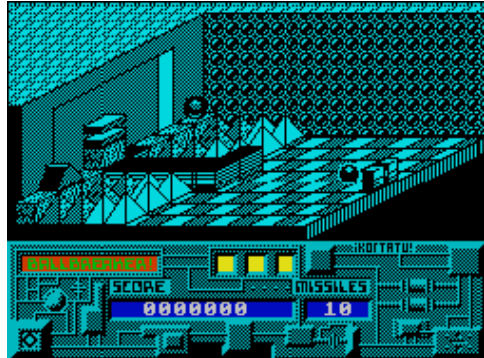

Ball Crazy (Mastertronic Added Dimension,1987)
Arcade

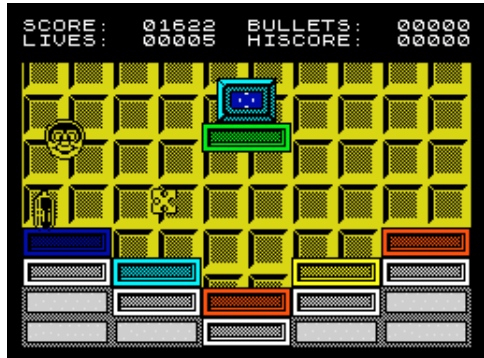

Ballista (16/48 Tape Magazine,1983)
Arcade

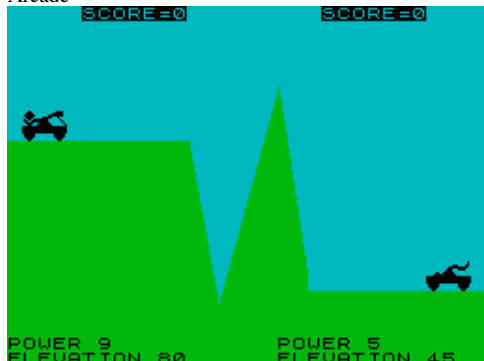

Baile de los Numeros, El (MicroHobby,1984)
Board/Card Game

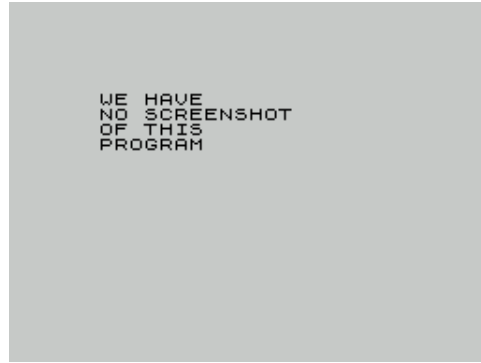

Ballade du Lutin, La (Loriciels,1984)
Arcade Adventure



Ball Breaker II (CRL Group PLC,1988)
Arcade

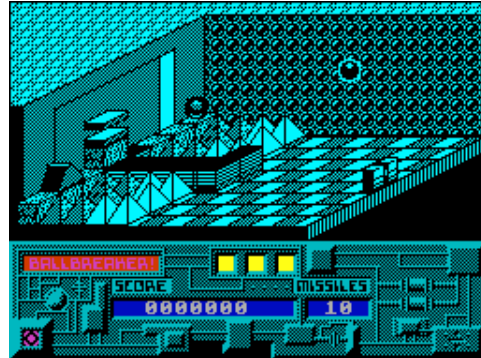

Ball Dreams 1 (Flash Inc,1994)
Scene Demo



Ballistik (.)
Utility

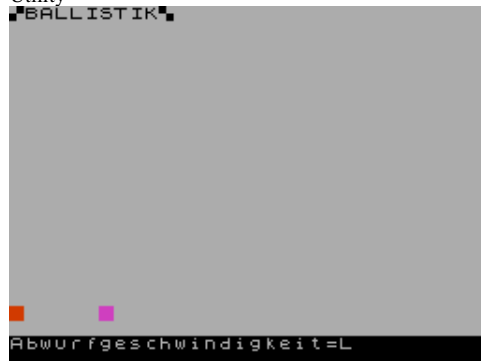

Bajke (Xenon,1985)
Text Adventure



Ballblazer (Activision Inc,1986)
Simulation



Ball by Ball (Video Software Ltd,1983)
Arcade

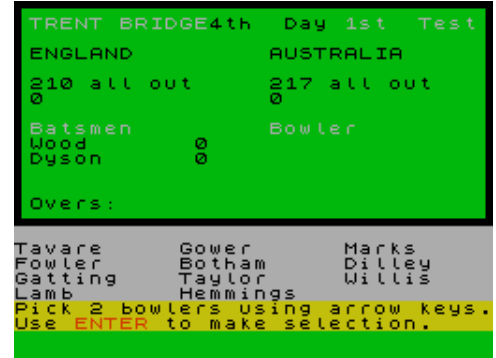

Ball Dreams 2 (Flash Inc.)
Scene Demo



Balloon Hopper (Your Computer,1983)
Arcade



Ballooning (Heinemann,1984)



Balls Demo Part One (Miker,1992)

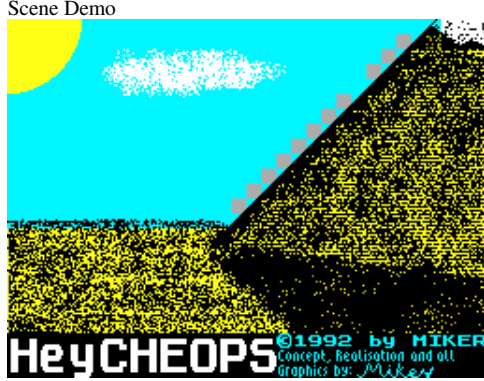

Balrog and the Cat, The (Zenobi Software,1988)



Balrog's Big Four (Zenobi Software,)



Baltic Patrol (East Midland Software,1983)



Balloons (.)

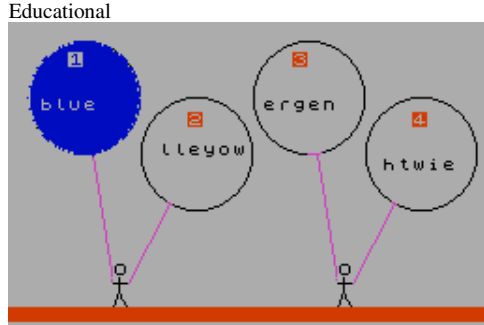

Which word is in balloon 2 ?
type word "WOSL"

Ball, The (Futuresoft,1990)



Balrogian Trilogy, The (Zenobi Software,1990)



Balrog's Box of Delights (Zenobi Software,1996)

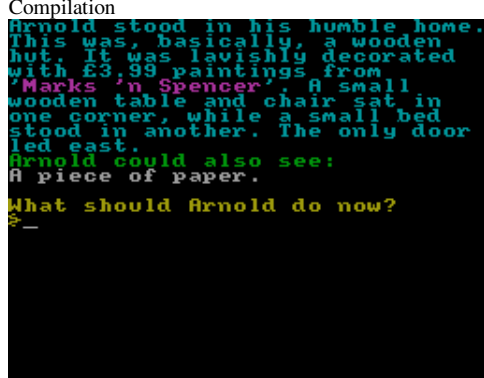

Ballpoint Adventure System (Ballpoint.)



Ball, The (J. Semancik,)

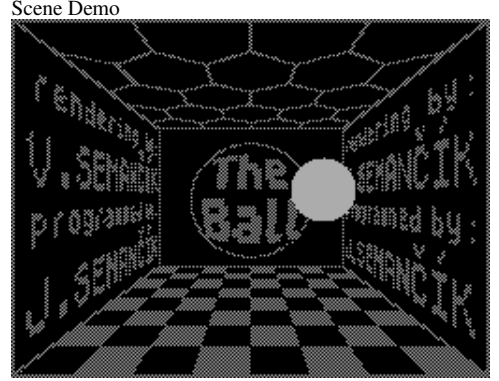

Balrog's Big Disk (Zenobi Software,)



Balrog's Day Out + Elfin Wars, The (Zenobi Software,1995)



Bananablip and Spacemanblip (Le Lu/Lu's,1987)



Bananaby (Wasp Software,1986)



Bananas (Micromania [2],1985)
Arcade

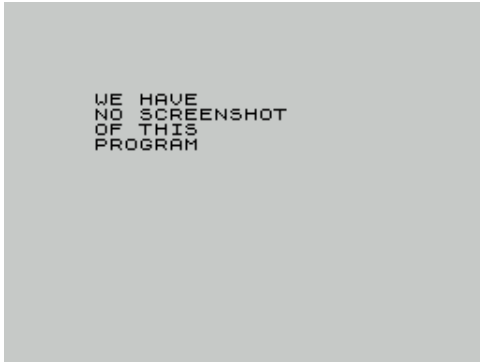

Banco, El (MicroHobby,1985)
Arcade



Bandera (MicroHobby,1985)
Arcade

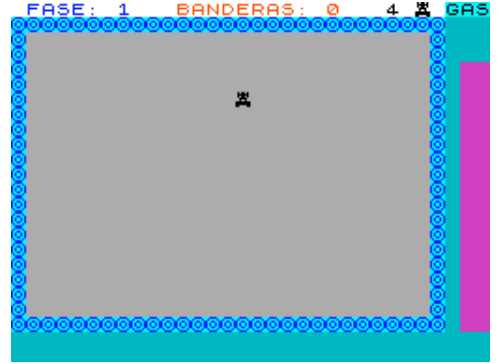

Bandersnatch (Imagine Software Ltd.)
Arcade



Bandit (.)
Simulation

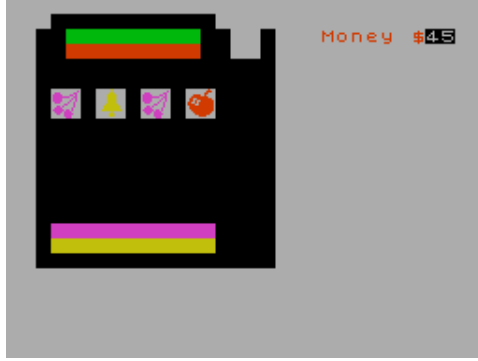

Bandit (K. Deakes,1984)
Simulation

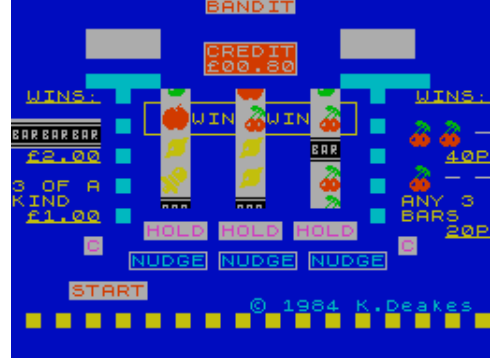

Bandit (Spectrum Computing,1984)
Simulation



Banger Racer (Cult Games,1990)
Simulation



Bangers & Mash (Alternative Software Ltd,1992)
Arcade Adventure

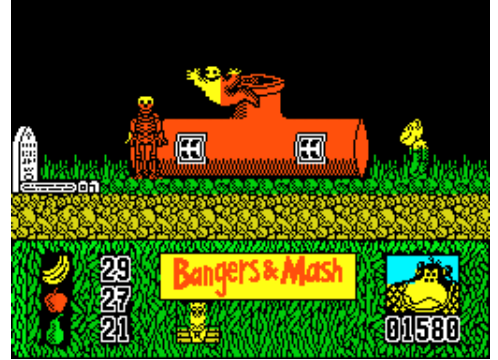

Bangkok Knights (System 3 Software Ltd.)
Arcade



Bank Account (SD Micro Systems,1984)
Utility

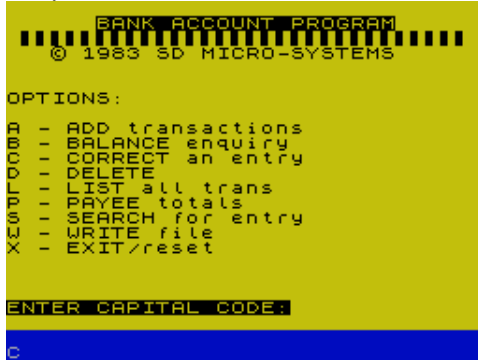

Bank Account System (K.J. Gouldstone,1983)
Utility



Banker (Andic Software,1985)
Utility



Banner Generator (Spectrum Computing,1985)
Utility



Barbarian (Melbourne House,1988)
Arcade Adventure



Barbarian (Palace Software,1987)
Arcade



Bar Chart (16/48 Tape Magazine,1984)
Utility: Mathematics



Bardic Rites, The (Zenobi Software,1994)
Text Adventure

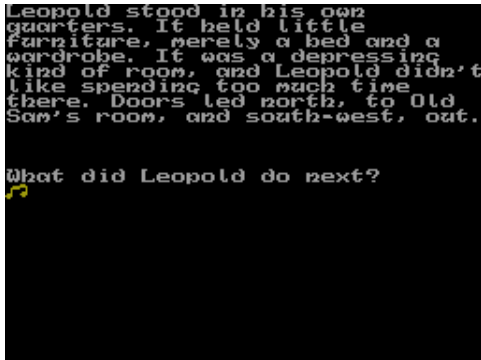

Barf the Barbarian (8th Day Software,)
Text Adventure



Barmy Burgers (Blaby Computer Games,1983)
Arcade



Barbarian II: The Dungeon of Drax (Palace Software,1988)
Arcade



Bar Chart (MiCROL,1982)
Utility: Mathematics

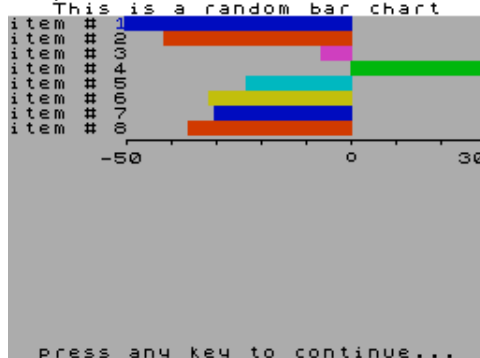

Bard's Tale, The (Electronic Arts,1988)
Arcade Adventure



Bargain Basement (Creative Sparks,1986)
Arcade



Baron (Temptation Software,1983)
Arcade

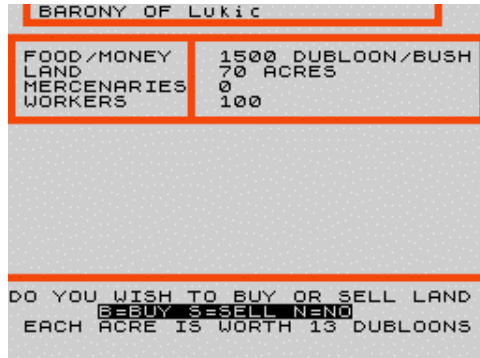

Bar Billiards (Meow Micros,1983)
Arcade



Barchou (Central Solutions,1984)
Arcade



B.A.R.F. (Dinu Cristian Mircea,2004)
Arcade



Barman, El (MicroHobby,1985)
Arcade



Baron Rojo (MicroHobby,1985)
Arcade



Baron, The (R.D. Foord Software,)
Strategy

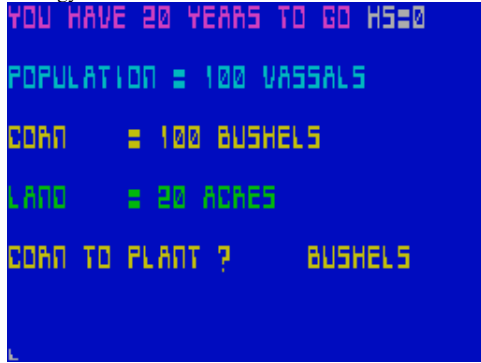

Barrels and Ladders (D. Millington,1983)
Arcade

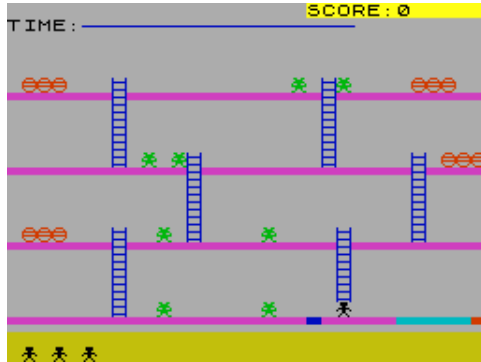

Barry McGuigan World Championship Boxing (Gamestar,1985)
Sport



Base (D. Paltusov/V. Kutin,1992)
Strategy



Base de Datos Para el Sistema MDS de Pin-Soft (MicroHobby,1985) Utility

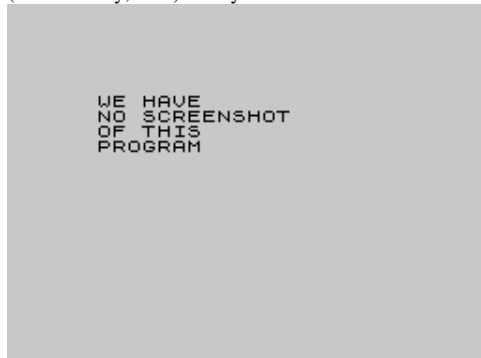

Barquitos (MicroHobby,1985)
Board/Card Game

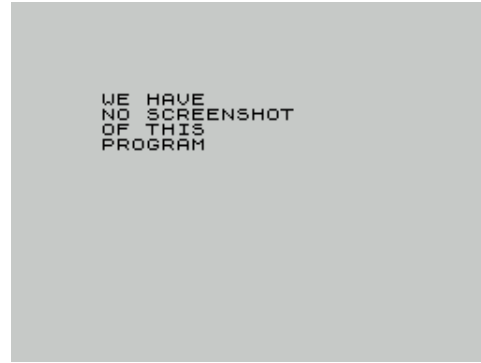

Barriles (Investronica S.A.,)
Arcade



Bart Bear (Zenobi Software,)
Compilation

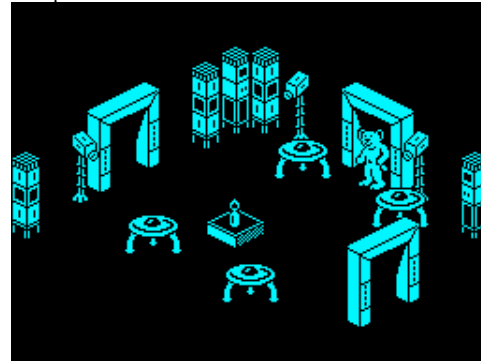

Baseball (Marco V.,)
Arcade



Base Invaders (Magination Software,1984)
Arcade

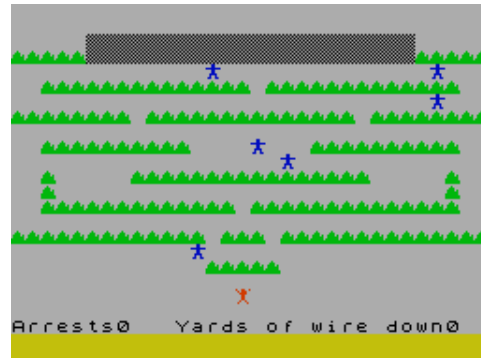

Barreldrop (Games Machine Ltd,1983)
Arcade

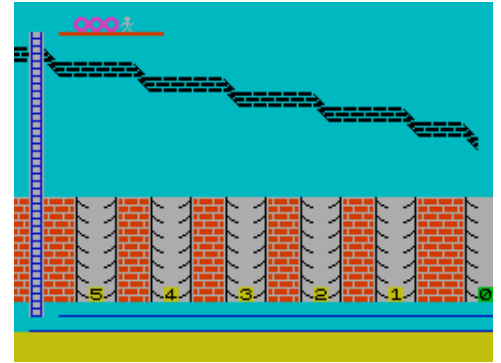

Barrow Quest (CCS,1984)
Arcade Adventure



Bart Simpson Demo (,)
Scene Demo

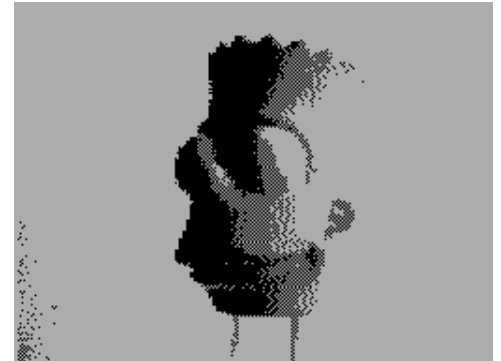

Base de Datos (Investronica S.A.,1986)
Utility: Database

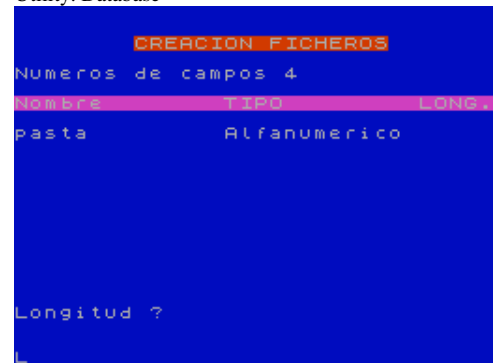

Base Invaders (Work Force,1983)
Arcade

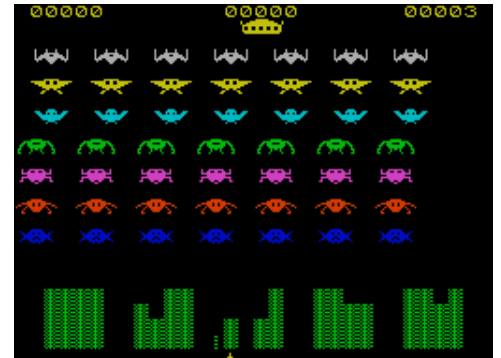

Base Invaders + Scramble + High Noon (Work Force,1983)
Compilation

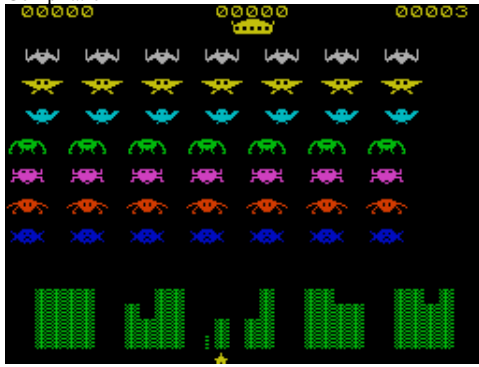

BASIC+ (Data Design Systems,1986)
Utility: Programming



Basic Arithmetic (Tawny Software,1983)
Educational

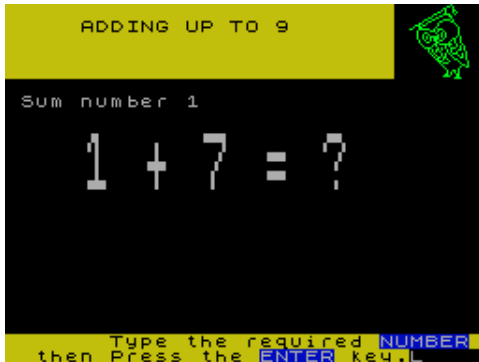

Basic Mathematics (Scetlander,1988)
Educational



Basicode 3 (J. Bredenbeek,1984)

Utility
BASICODE-3 LOAD & SAVE PROGRAM V1.0
Options:
*L: LOAD BASICODE program
*T: Translate BASICODE program
*K: LIST BASICODE program
*C: Convert program to BASICODE
*W: SAVE program in BASICODE
*S: SAVE translated program
*B: Backup translation program
<ENTER>: Back to BASIC
>

Bases (Scisoft,1984)
Educational

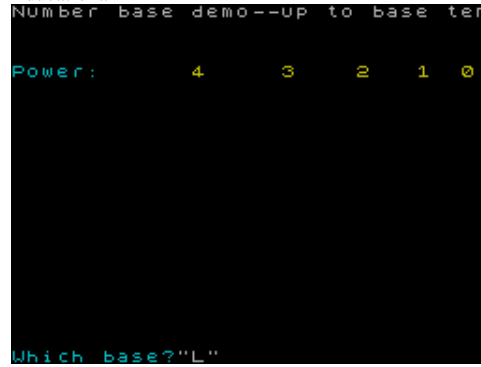

Basic 64 (.)
Utility: Font/UDGs

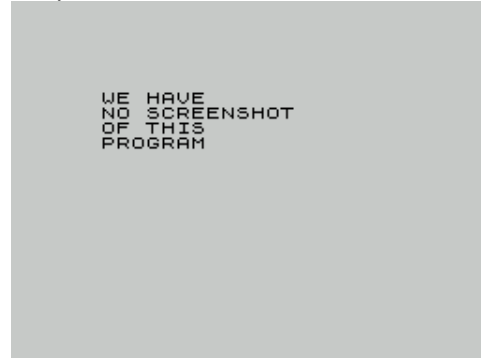

Basic CM (MicroHobby,1986)
Educational



Basicode 2 (NOS Hobbyscoop,)
Utility

HJ Koevoets
Heer Danielstr 116a
3073 DG Rotterdam

BASICODE-2 VERSIE 5.1
inlees+vertaal routine.
zie manual, aan vragen bij:
NOS HOBBYSLOOP
postbus 1200
Hilversum

>> assembled by ASSEMBLER-82.8
0 OK, 9085:1

Basic Print Compiler (Green Fish Software Enterprise,1986)

Utility: Programming
Basic Print Compiler
By S A J Broad © 1986
START:30000 LENGTH:
NOW COMPILING PRINT statement 3

Base, The (The Guild,1988)
Text Adventure

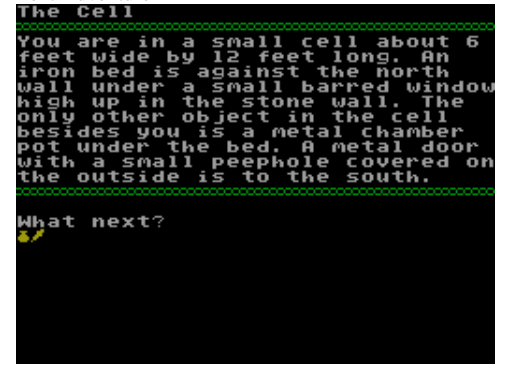

Basically Speaking: Programming for Everybody (Computer Publications,1986)
Utility: Programming



Basic List (Johnny EJS,)
Utility: BASIC Related



Basicode 2+ (NOS Hobbyscoop,1984)
Utility

THE CHIP SHOP BBC RADIO 4

BASICODE 2+ ©NOS HILVERSUM

SINCLAIR 48K SPECTRUM
Press the appropriate key:
<1> Load a BASICODE program.
<2> Translate and modify.
<3> Translate the program.
Program by Dr.I.Logan July 1984

Basic Rally (Masters Games,2005)
Arcade

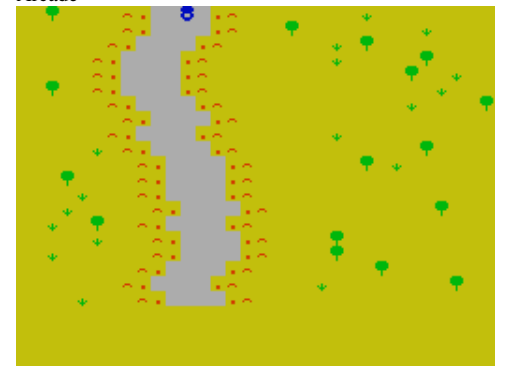

Basic Traducible (MicroHobby,1986)
Utility: Programming



Basic Tutor (Kamasoft,1987)
Educational

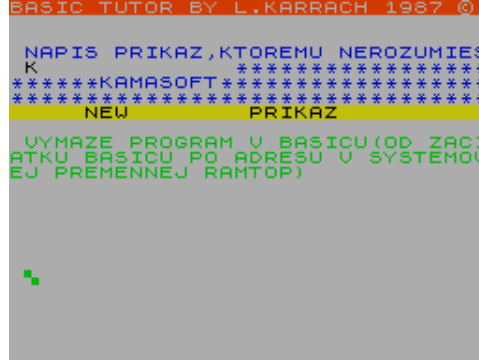

BASIC Utilities (Jaysoft,1984)
Utility: Programming



Basil the Great Mouse Detective (Gremlin Graphics Software Ltd,1987) Arcade

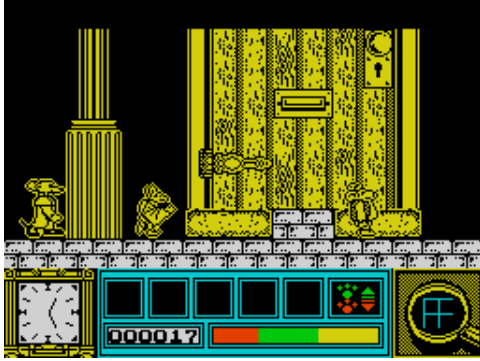

Basket (MicroHobby,1985)
Arcade

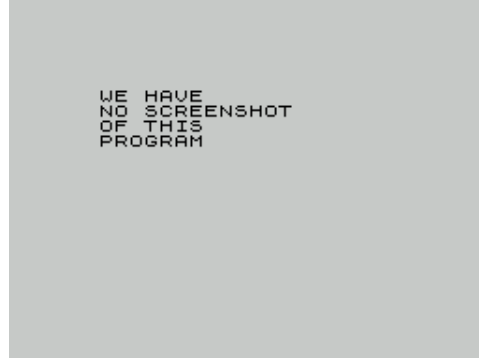

Basketball (Zafiro Software Division,)
Sport



Basketbear (Hipocrates Soft.)
Arcade



Basque Terrorists Loose in Dartford (Infected Software,1987) Text Adventure

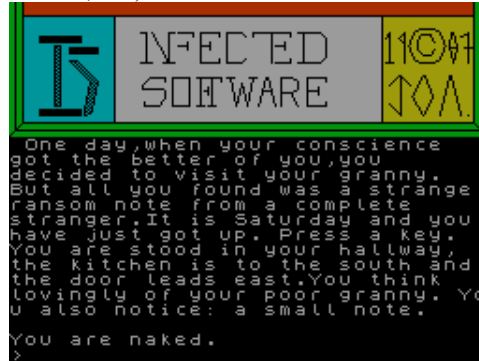

Basurero (Micromania [2],1985)
Arcade



Batalla Naval (Paraninfo Soft S.A.,)
Board/Card Game



Batalla Naval (Taller de Aplicaciones Informaticas,1983)
Strategy



Bat Attack, 3D (Cheetahtsoft Ltd,1984)
Arcade



Batcode (MicroHobby,1986)
Strategy



Batman (Ocean Software Ltd,1986)
Arcade

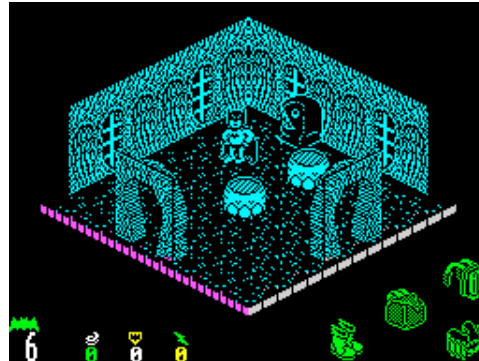

Batman Demo Music (THD,)
Scene Demo



Batman the Caped Crusader (Ocean Software Ltd,1988)
Arcade Adventure

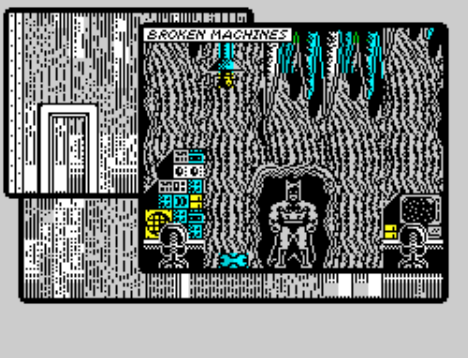

Batman - The Movie (Ocean Software Ltd,1989)
Arcade

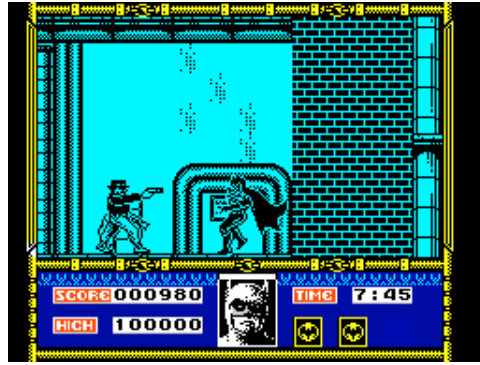

Batman - The Puaj Edition (Micro House,1989)
Arcade

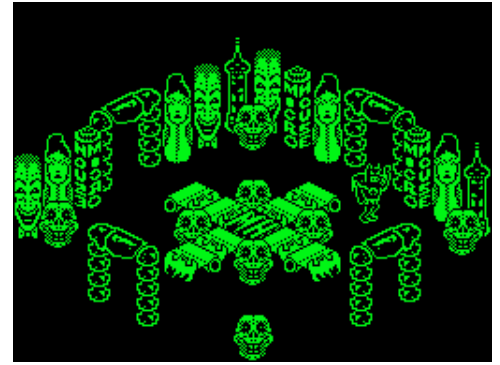

Battle (Abacus Programs,1982)
Simulation



Battle 1917 (CCS,1984)
Board/Card Game



Battle Axe (Scott Johnston,1987)
Strategy



Battlecars (Darryl LeCount,1993)
Arcade

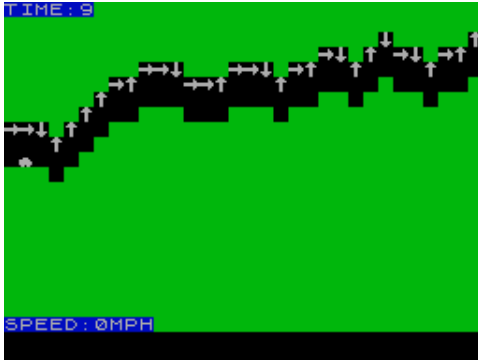

Battlecars (Games Workshop,1984)
Arcade

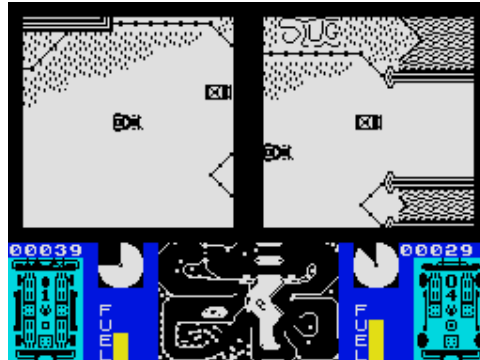

Battle City (A. Makushin,1993)
Arcade



Battle City (Flash Inc,1995)
Arcade

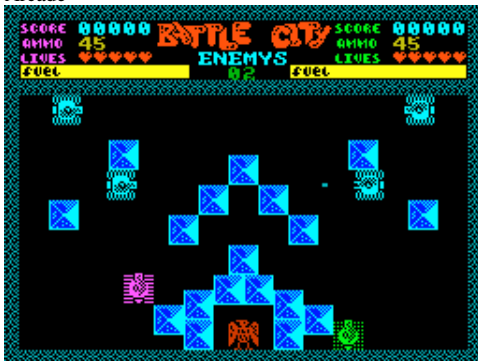

Battle City (Scorpion Software,1995)
Arcade



Battle Command (Ocean Software Ltd,1990)
Arcade

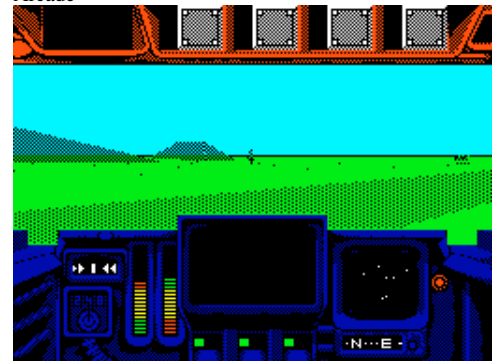

Battle Command Realtime 3D Tank Simulator (.)
Scene Demo



Battle Creator (Argus Press Software Ltd,1986)
Utility



Battlecruiser (DLT Games,1984)
Text Adventure



Battle Field (Atlantis Software Ltd,1988)
Arcade

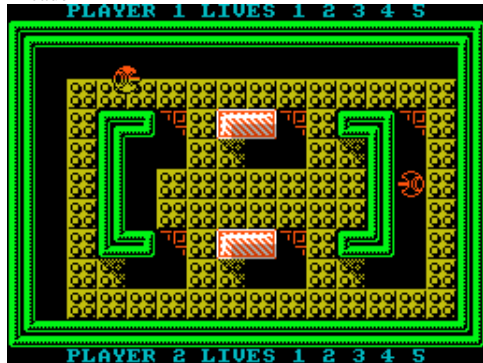

Battleforce (,1994)
Text Adventure



Battle of Britain (Microgame Simulations,1982)
Arcade

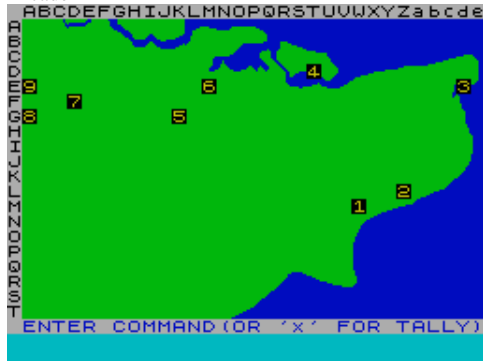

Battle of the Bulge (CCS,1990)
Strategy



Battle of the Toothpaste Tubes (K-Tel Productions,1983)
Arcade

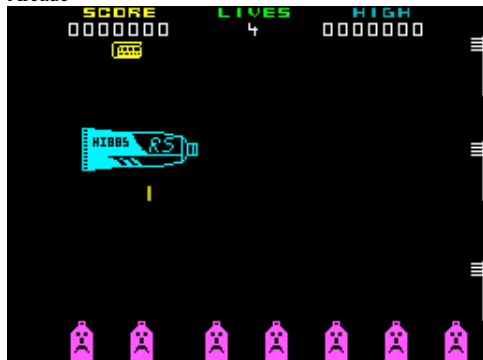

Battle Field (SAM Style,2002)
Arcade

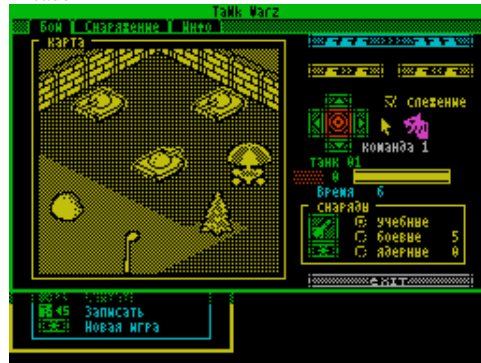

Battle for Midway, The (PSS,1985)
Strategy

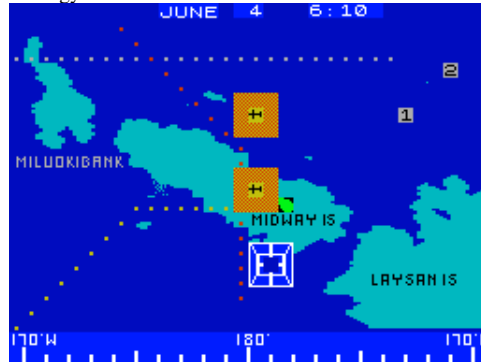

Battle of Britain (PSS,1986)
Strategy



Battle of the Bulge (Chameleon,1984)
Strategy



Battle on Hoth (Your Computer,1983)
Arcade



Battlefield Germany (PSS,1987)
Strategy



Battleground (Brian Fitton,1985)
Arcade



Battle of Broken Bridge, The (5D Software,1984)
Arcade



Battle of the Planets (Mikro-Gen Ltd,1986)
Arcade

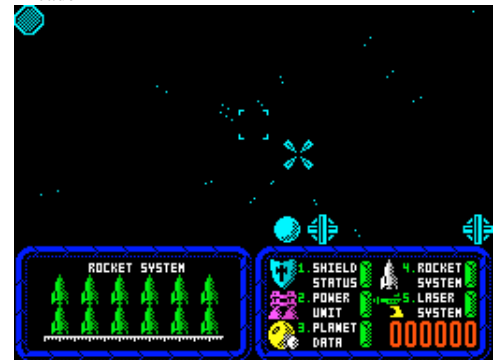

Battleships (Century Communications Ltd,1983)
Strategy

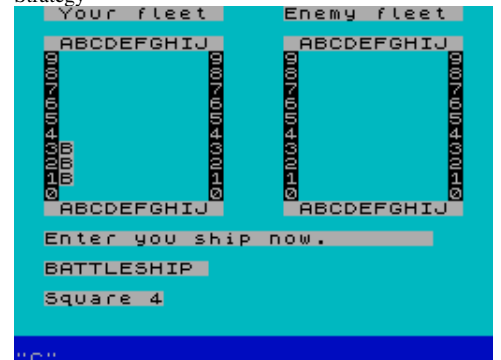

Battle Ships (Encore,1988)
Board/Card Game

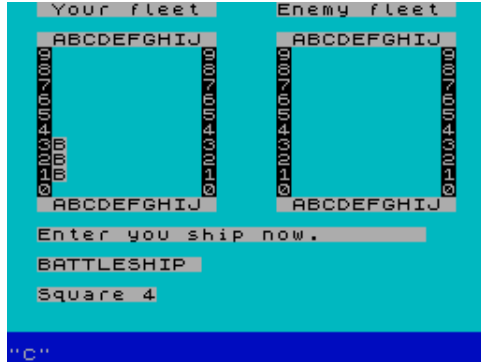

Battleships (Sinclair Research Ltd,1982)
Arcade



Battle Valley (Rack-It,1988)
Arcade



Baudcopy (Michael Bayer,1984)
Utility: Copier

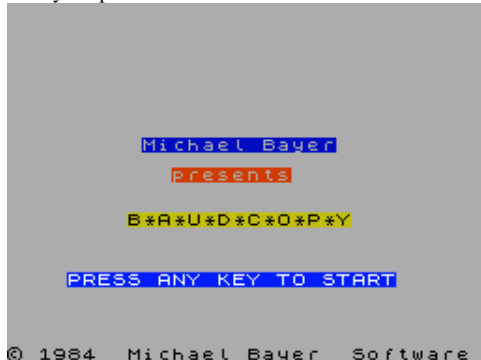

BBC Mastermind (Mirrorsoft Ltd,1984)
Board/Card Game



Battleships (Meow Micros,1983)
Board/Card Game

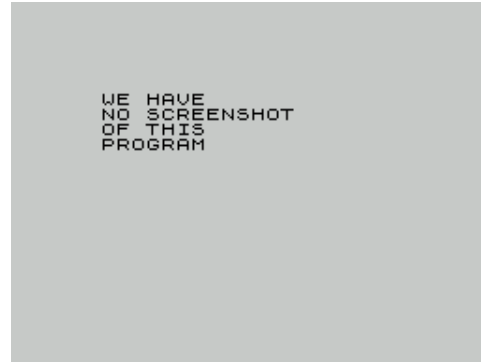

Battle Stations (Anik Microsystems,1984)
Arcade

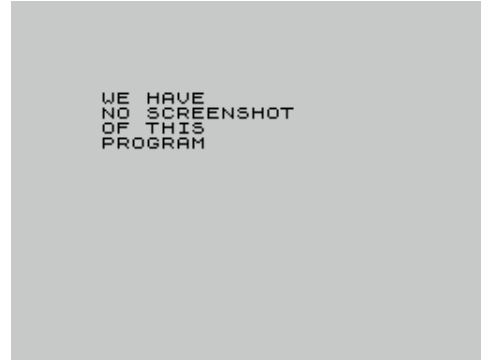

Battlezone (Quicksilva Ltd,1984)
Arcade

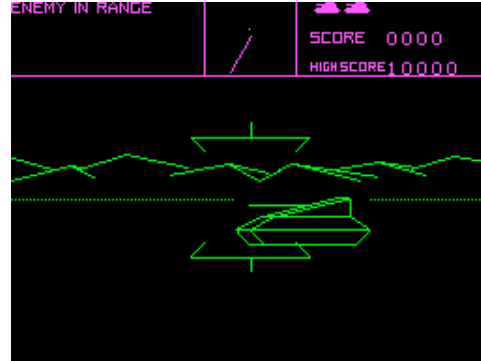

Bazam (Alan Firminger,1985)
Arcade

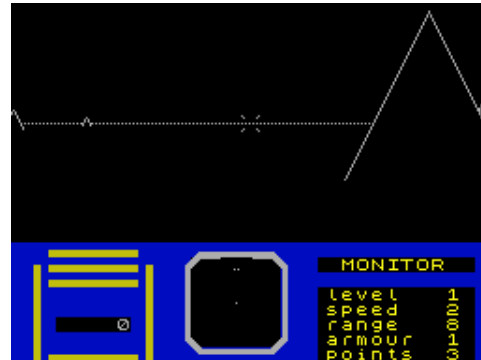

BBC Mastermind Quizmaster (Mirrorsoft Ltd,1984)
Board/Card Game

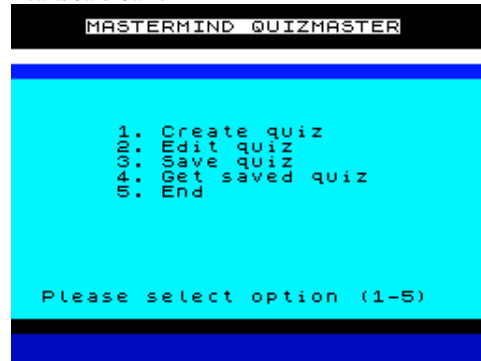

Battleships (Precision Software Engineering,1983)
Arcade



Battle Stations (Ocean Software Ltd.)
Compilation

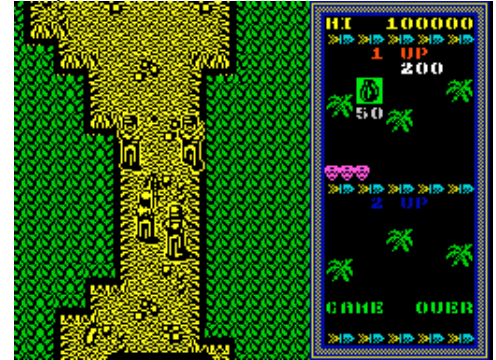

Batty (Hit-Pak,1987)
Arcade



Bazooka Bill (Melbourne House,1986)
Arcade

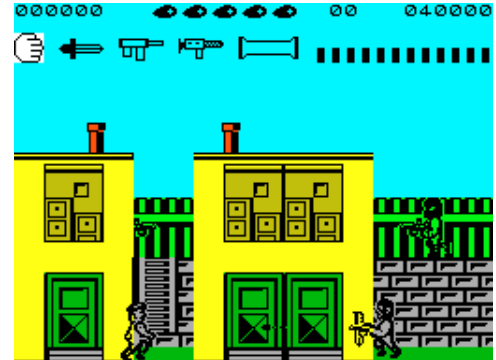

BC2: Grog's Revenge (US Gold Ltd.)
Arcade



B.C. Bill (Imagine Software Ltd,1984)
Arcade



Beach-Head (US Gold Ltd,1984)
Arcade



Beacon Adventure (Sinclair User,1984)
Text Adventure

```
Program: ADVENTURE
YOU ARE IN THE WEST END OF A
MEADOW

EXITS:
EAST
SOUTH
YOU ARE SURROUNDED BY WOLVES
WHO WILL NOT LETYOU MOVE.
YOU ARE SURROUNDED BY WOLVES
WHO WILL NOT LETYOU MOVE.
I DON'T UNDERSTAND TRY AGAIN.
I DON'T UNDERSTAND TRY AGAIN.

WHAT NEXT ?"L"
```

BeamingAnim (LCD.)
Scene Demo



Bear a Grudge (Sinclair User,1988)
Arcade

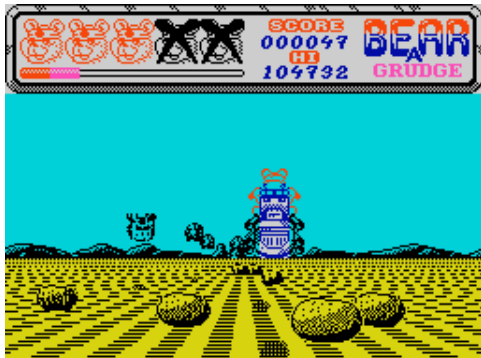

BC's Quest for Tires (Software Projects Ltd,1983)
Arcade



Beach-Head II (US Gold Ltd,1985)
Arcade



Beakers (16/48 Tape Magazine,1984)
Simulation

```
WE HAVE
NO SCREENSHOT
OF THIS
PROGRAM
```

Beamrider (Activision Inc,1984)
Arcade



Bear Bovver (Artic Computing Ltd,1983)
Arcade



Beach Buggy Simulator (Silverbird Software Ltd,1988)
Arcade



Beach Volley (Ocean Software Ltd,1989)
Sport

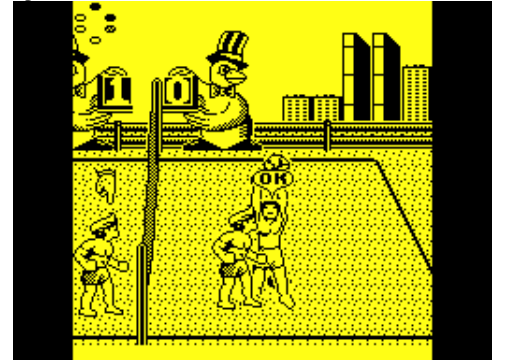

Beaky and the Egg Snatchers (Fantasy Software [1],1984)
Arcade



Beamscan (Beamscan,1983)
Utility

```
WE HAVE
NO SCREENSHOT
OF THIS
PROGRAM
```

Bear Island (Gilsoft International,1982)
Arcade



Beast Enders (Piranha.)
Text Adventure



Beast, The (Marlin Games,1988)
Text Adventure

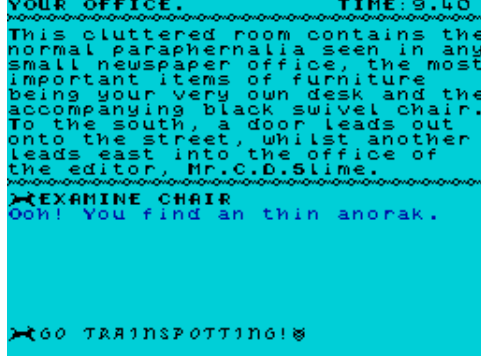

Beagle Quest (Number 9 Software,1985)
Text Adventure

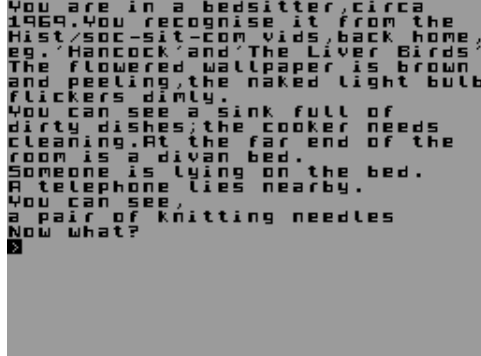

Beat the Clock (Arnold Wheaton Software,1983)
Educational

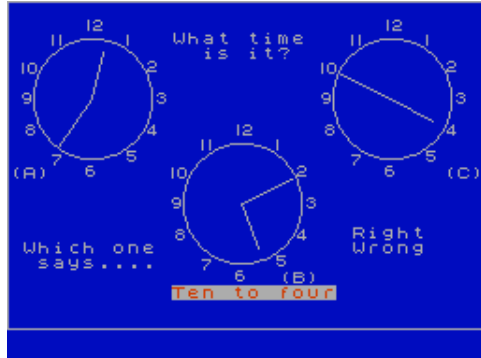

Bedlam (AWA Software,1983)
Arcade

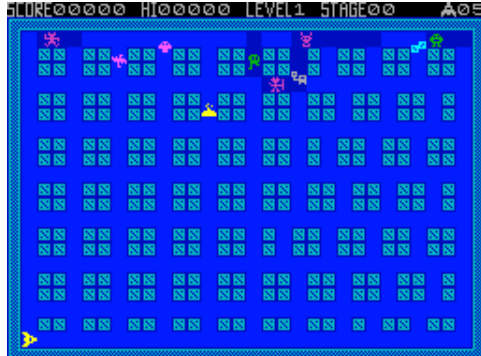

Beastie Feastie (Beyker Soft,2005)
Arcade



Beatcha (Romik Software,1984)
Arcade



Beatles: A Hard Day Night (Max Iwamoto,1993)
Scene Demo



Beautiful Dreamer (Spectrum Adventure Exch Club,1986)
Text Adventure

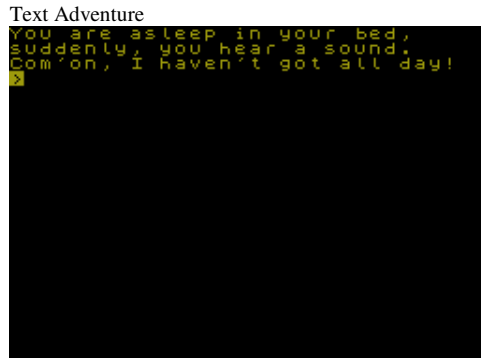

Bedlam (Go!,1988)
Arcade



Beasts on the Steps (Shiva Publishing Ltd,1983)
Board/Card Game



Beat Em & Eat Em (Silver Fox Comm Ltd,1983)
Board/Card Game



Beatles Remix, The (Sgt. Pepper,1989)
Scene Demo



Beaver Bob in Dam Trouble (Gremlin Graphics Software Ltd.) Arcade



Beebul (Scorpio Gamesworld,1984)
Arcade



Beer Hunter, The (Global Software,1986)
Text Adventure



Beetle (ZX Computing,1983)
Board/Card Game

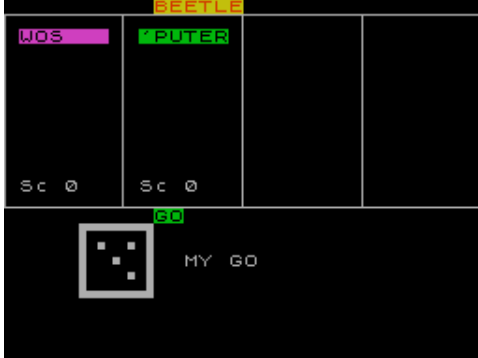

Begin 5: Multiple Choice Tester (.)
Educational

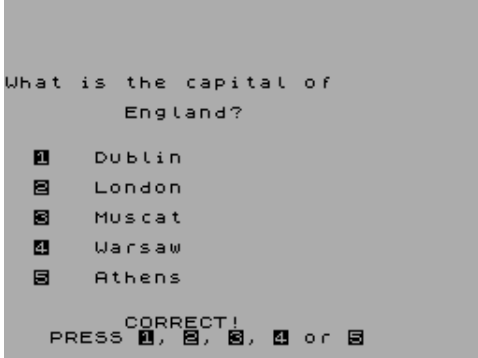

Beginning of the End (Zenobi Software,1992)
Text Adventure

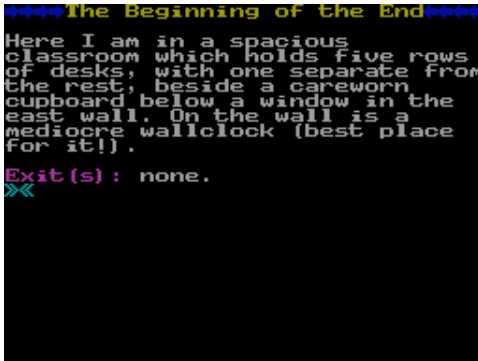

Behind Closed Doors 2: The Sequel (Zenobi Software,1988)
Text Adventure

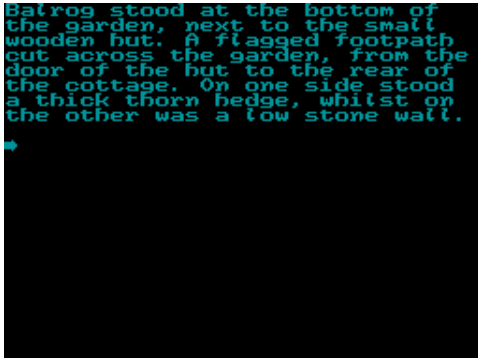

Beerland (Proxima Software,1991)
Text Adventure

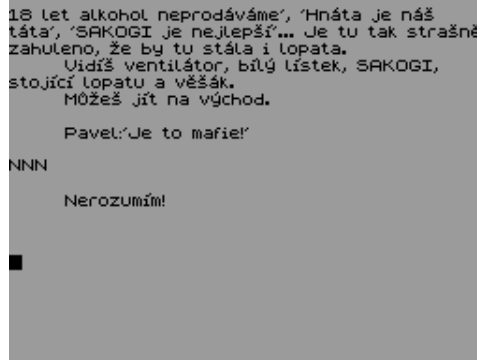

Beets 'n' Eggs (Mesoft,1986)
Strategy

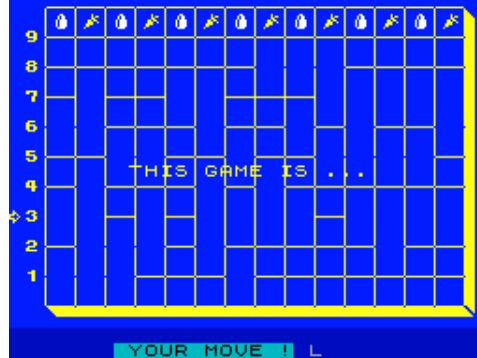

Beginners BASIC for the Spectrum (Glentop Publishers Ltd,1983) Utility: Programming

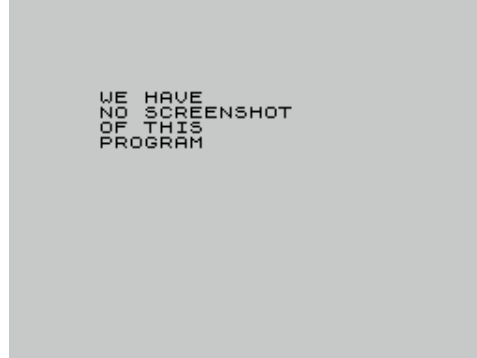

Begstvo na Harhan (Air,1998)
Arcade Adventure

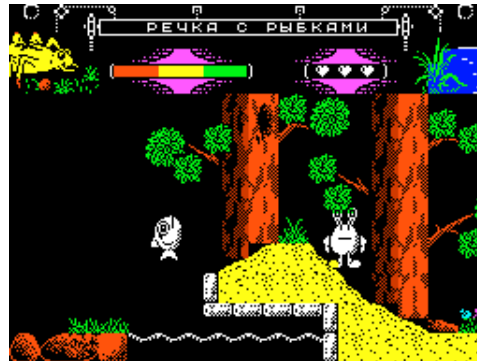

Behind Closed Doors 3: Revenge of the Ants (Zenobi Software,1989) Text Adventure



Beethoven's Arrangement (Maiolino)
Music

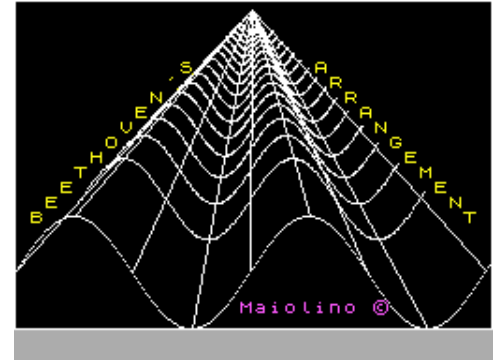

Begin: Noughts and Crosses (16/48 Tape Magazine,1985)
Board/Card Game

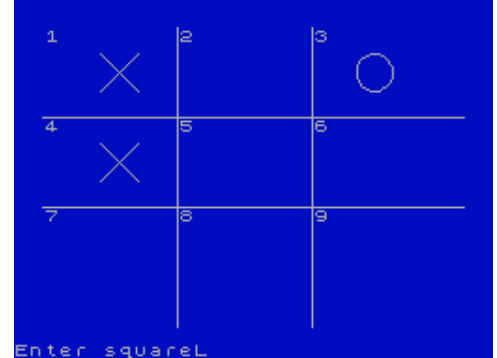

Beginner's Corner (16/48 Tape Magazine,1985)
Educational



Behind Closed Doors (Zenobi Software,1988)
Text Adventure

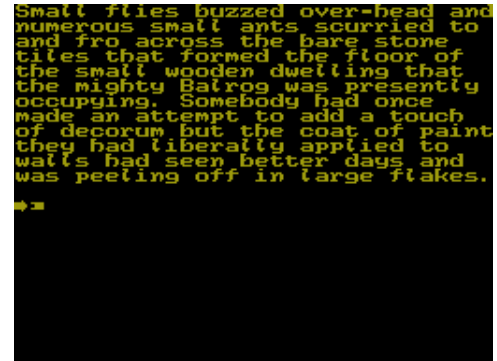

Behind Closed Doors 4: Balrog's Day Out (Zenobi Software,1989) Text Adventure



Behind Closed Doors ... The Saga (Zenobi Software,1989)



Belagerung (.) Arcade

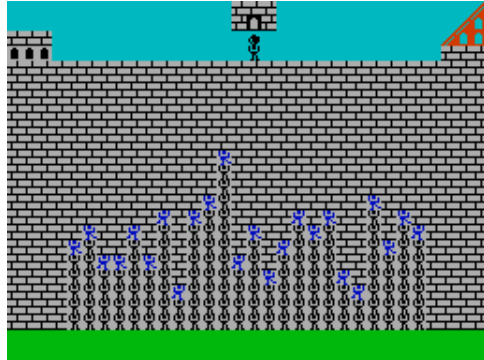

Beliy Oriyel: Tovarish Izvesten (Fatality,1998) Arcade



Benny Hill's Madcap Chase! (DK'Tronics Ltd,1985) Arcade Adventure



Bermuda Triangle, The (Zenobi Software,1991) Text Adventure

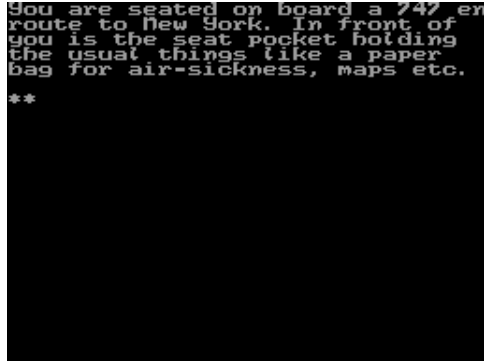

Best Hits of M&Z Musics, The (M&Z,1987)

Behind the Lines (The Guild,1991) Text Adventure

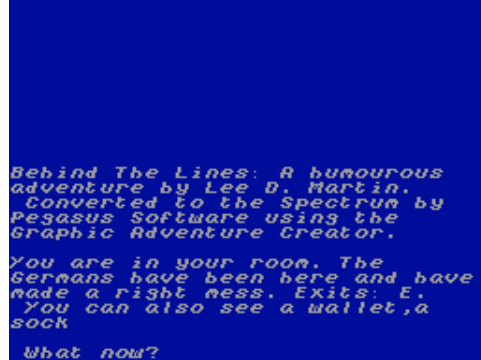

BelBase/BelChem/BelGen/BelGraph (Bel Tech,1984) Utility



Beneath Folly (The Fiend,1991) Text Adventure

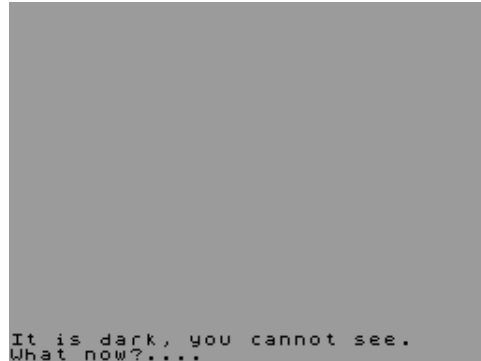

Bergwacht (.) Simulation

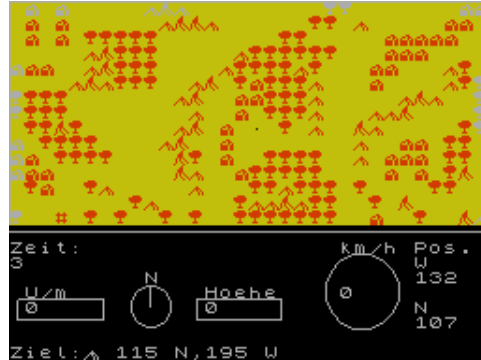

Beruska - The Lady Bird (Kingfisher's Movie Studio,1990) Scene Demo

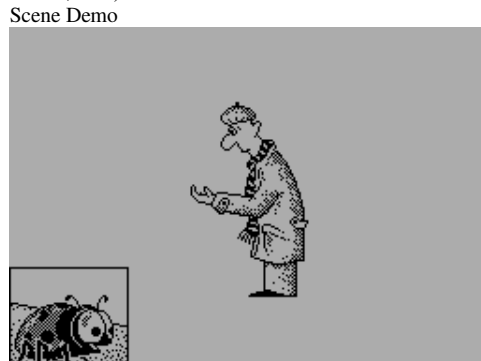

Bestial Warrior (Dinamic Software,1989)

Behold Atlantis (Zenobi Software,1991) Text Adventure

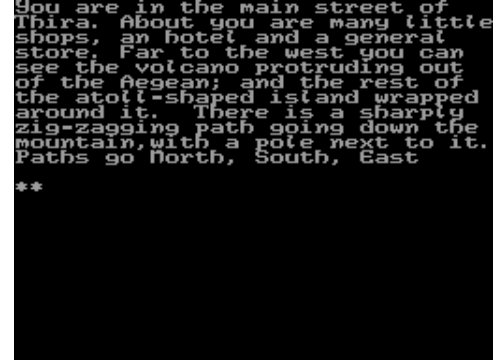

Belegost (Cybexlab Software,1989) Text Adventure

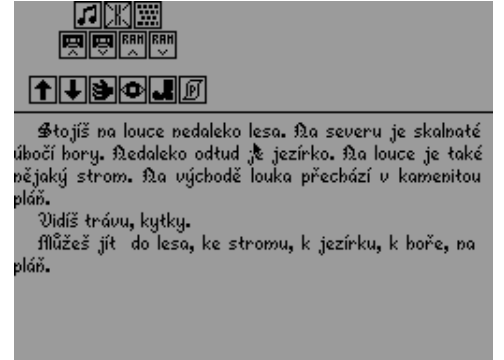

Bennie the Burglar (MB/APG Software,1987) Arcade



Bermuda Triangle (Procom Software,1984) Arcade



Best Demo Music (THD/Alex Boy,1993) Scene Demo



Best Music Demo 1 (THD/Alex Boy,1993)

Scene Demo



Best Music Demo 2 (THD/Alex Boy,1993)
Scene Demo



Best of 3D, The (Vortex Software,1987)
Compilation

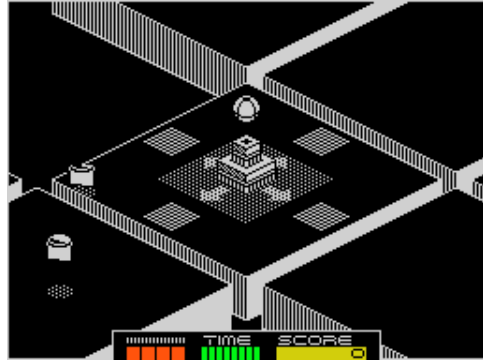

Best of Elite Vol 1 (Hit-Pak,1988)
Compilation



Best of Speedway, The (Lambourne Games,1993)
Simulation

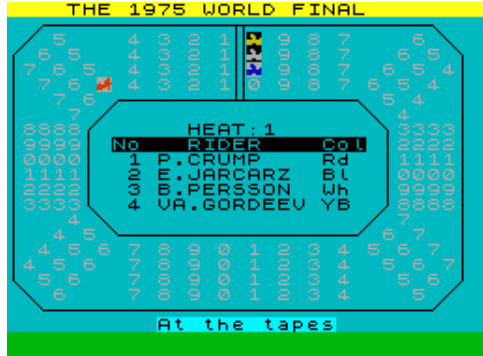

Arcade Adventure



Best Music Demo 3 (THD/Alex Boy,1993)
Scene Demo

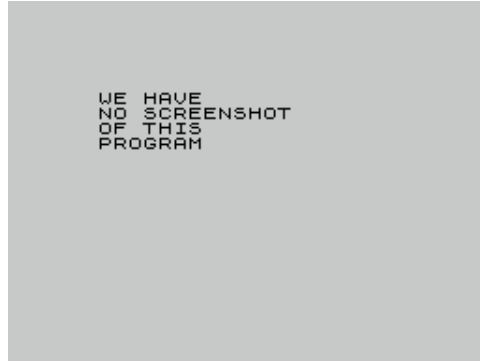

Best of Beyond, The (Beyond Software,1986)
Compilation



Best of Elite Vol 2 (Hit-Pak,1988)
Compilation



Best of the Indies Vol 1 (Zenobi Software,1991)
Compilation



Scene Demo

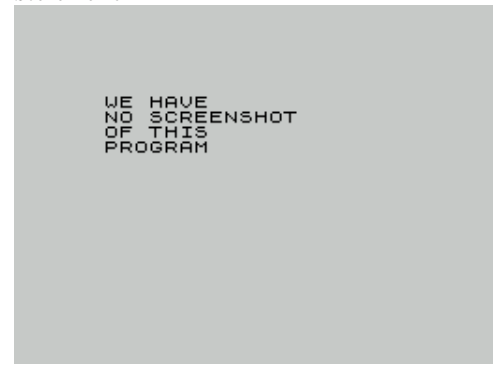

Best Music Demo 5 (THD/Alex Boy,1993)
Scene Demo



Best of Clive and Les, The (Zenobi Software,1991)
Compilation



Best of PCW - Software for the Spectrum (Century Software [1],1983)
Compilation



Best of the Indies Vol 2 (Zenobi Software,1991)
Compilation



Beszed (Voicesoft,1985)

Utility: Sound Manipulation

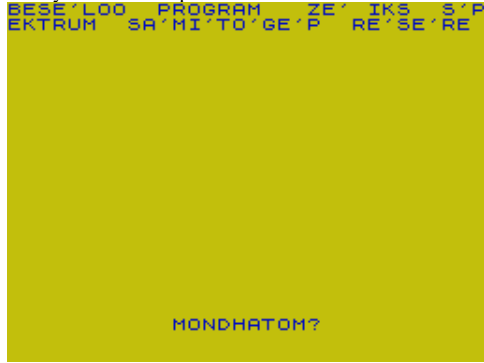

Beta Basic (Betasoft,1983)

Utility: BASIC Related

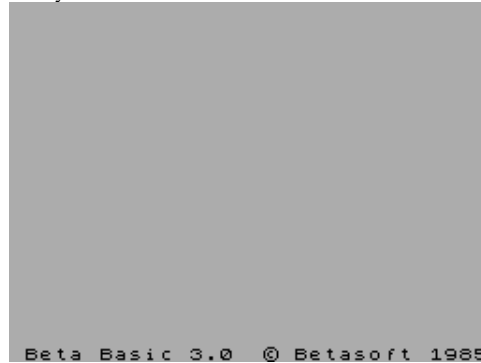

Beta Dos (Format,)

Utility



Beta Dos - BB3 (.)

Utility



Beta-Pack (Individual Software,1985)

Utility



Beta ROM (.)

Utility: Assembler/Disassembler/Monitor



Beta ROM 2 (.)

Utility: Assembler/Disassembler/Monitor



Betrayal (Rainbird Software Ltd,)

Strategy



Better Bytes Utility Disc (Betterbytes Software,1990)

Utility



Betu 2005 (NyitraiSOFT,2005)

Board/Card Game

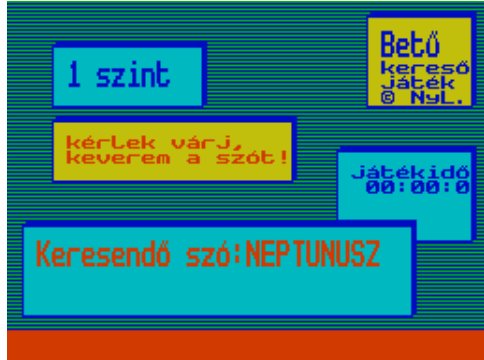

Beverly Hills Cop (Tynesoft,1990)

Arcade

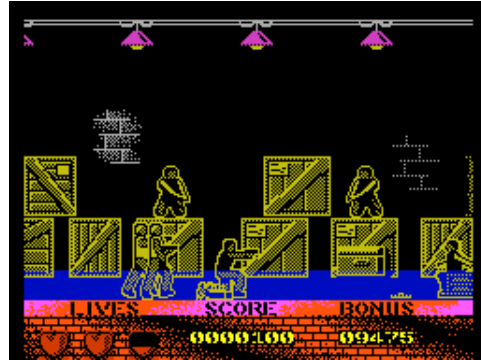

Beware Collaborators (.)

Text Adventure

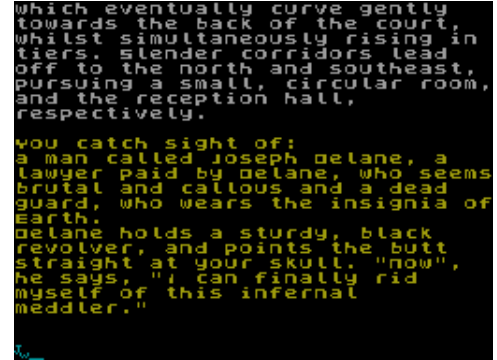

Bewarehouse, The (Positive Image,1984)

Arcade

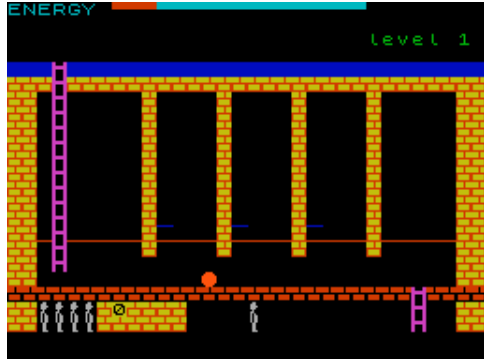

Beyond BASIC (Sinclair Research Ltd,1984)

Educational



Beyond El Dorado (Zenobi Software,1995)

Text Adventure

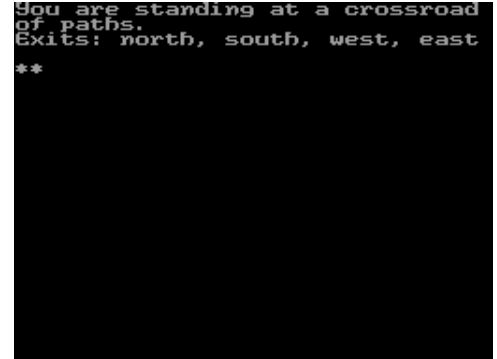

Beyond Horizons (East London Robotics Ltd,1984)
Educational



Biblia del "Hacker" 4, La (MicroHobby,1986)
Educational



Biblioteca (Paraninfo Soft S.A.,)
Utility

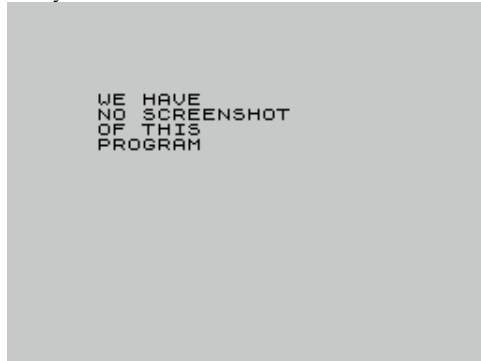

Bien y el Mal, El (Software Home,1991)
Arcade



Big 4 (Durell Software Ltd,1986)
Compilation

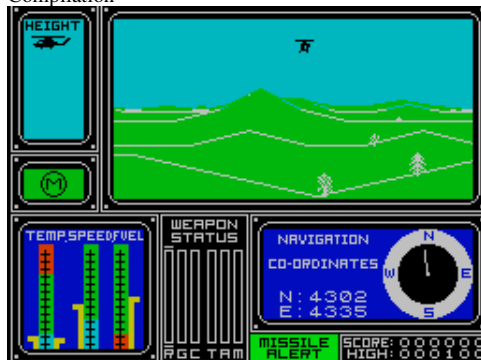

Beyond the Ice Palace (Elite Systems Ltd,1988)
Arcade Adventure



Biblia del "Hacker", La (MicroHobby,1986)
Educational



Biblioteca (Software Editores,1986)
Utility: Database



Biff (Beyond Belief,1992)
Arcade Adventure



Big 4 Vol II (Durell Software Ltd,1986)
Compilation



BFX-1 (16/48 Tape Magazine,1985)
Arcade

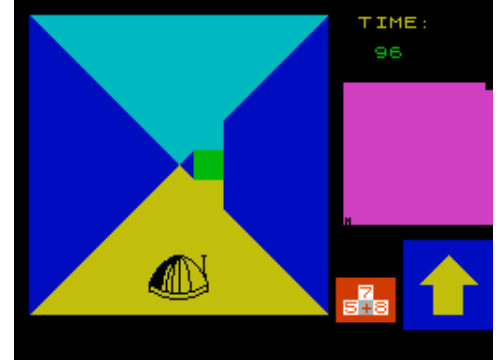

Biblia del "Hacker" XIV, La (MicroHobby,1986)
Educational



Bicie (Your Sinclair,1993)
Scene Demo

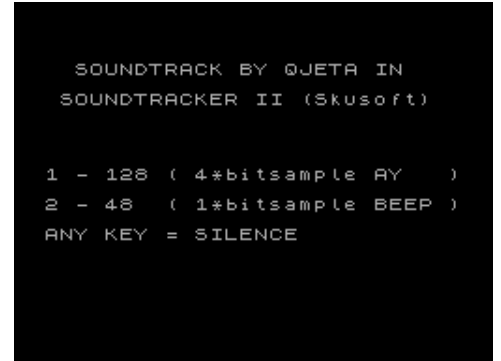

Biff 2 (Beyond Belief,)
Arcade Adventure



Big Bad John (Tynesoft,1986)
Arcade Adventure

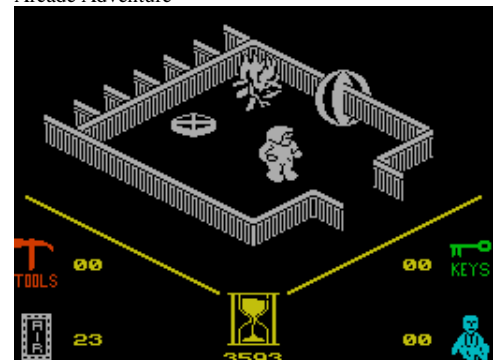

Big Bang (The Lords,)
Scene Demo



Big Fish 5 (DMJ,1992)
Scene Demo



Biggles (Mirrorsoft Ltd,1986)
Arcade



Big Match Soccer (Wintersoft,1983)
Sport



Big Print (Janusz Gajewicz,1983)
Utility: BASIC Related



Big Ben Strikes Again (Artic Computing Ltd,1985)
Arcade Adventure



Bigfoot (Code Masters Ltd,1988)
Arcade



Big Joy (Naffsoft,2002)
Compilation



Big Nose's American Adventure (Code Masters Ltd,1992)
Arcade



Bigprint Revisited (16/48 Tape Magazine,1985)
Utility: Font/UDGs



Big Box (Beau-Jolly Ltd,1991)
Compilation



Big Game Safari (Stack Computer Services Ltd,1983)
Arcade



Big K Spectrum Graphics (Big K,1984)
Utility

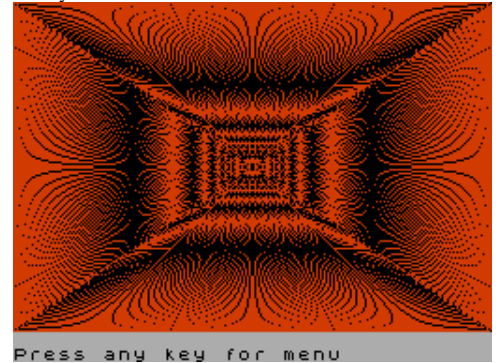

Bigprint (16/48 Tape Magazine,1983)
Utility: Font/UDGs



Big Railway Adventure (Mark Gipson,)
Text Adventure



Big Run (Storm Software [2],1991)
Arcade



Big Ten Super Games Pack (Lasersound Ltd,1983)
Compilation



Biljard (Birger Larsson,1987)
Sport



Billy Bluebottle (Power Software,1984)
Arcade



Bim-Bam (Tanod.)
Scene Demo

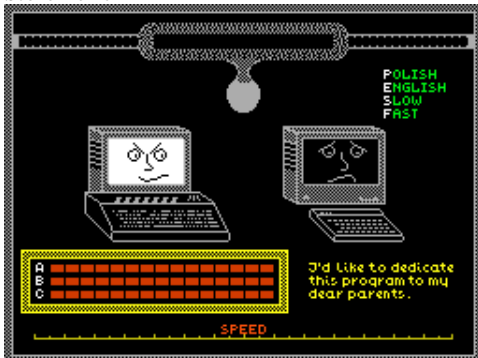

Big Shit (Hacker Chris,1987)
Scene Demo

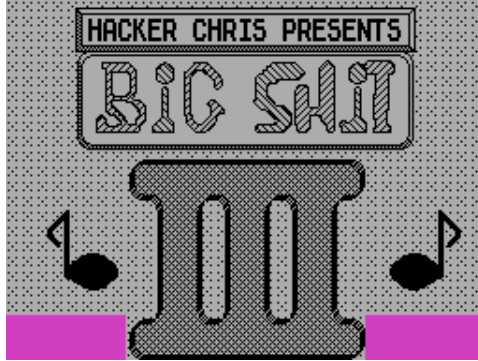

Bigtime (Mushroomsoft,1984)
Simulation



Billardo (Oxford Computer Publishing.)
Arcade



Billy Bong (MC Lothlorien Ltd,1984)
Arcade



Bimbles, The (Intech,1986)
Text Adventure

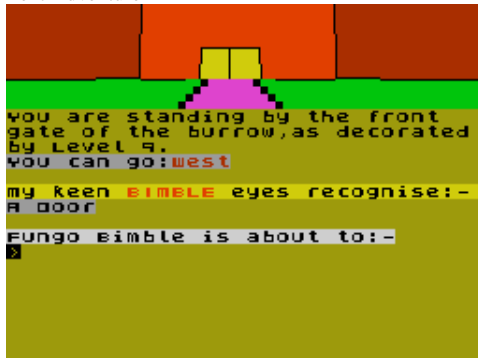

Big Sleaze, The (Piranha,1987)
Text Adventure



Big Trouble in Little China (Electric Dreams Software,1986) Arcade

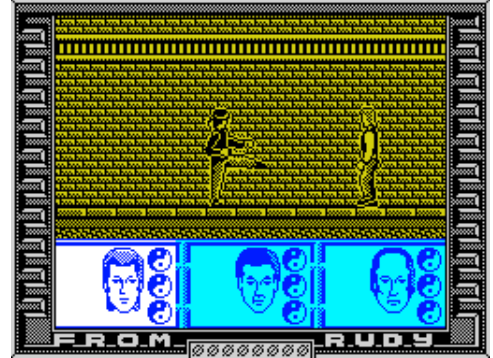

Billboard (Orange Enterprises,1984)
Utility



Billy the Kid (Virgin Mastertronic Ltd,1989)
Arcade

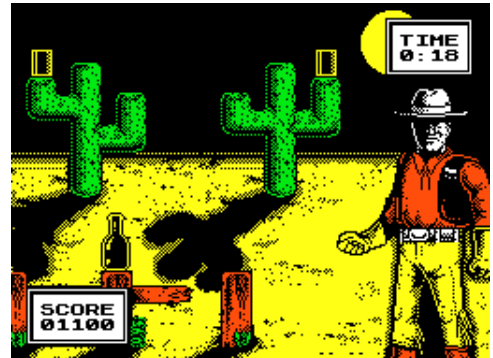

Bimbo (Joe the Lion,1983)
Arcade



Binary Love (Digital Reality [2],1997)
Scene Demo



Bingo (M.D. Bradley,1986)
Board/Card Game



Bingo (The Computer Partnership Ltd,1987)
Board/Card Game



Bin/Hex Tutor (Honeyfold Software,)
Educational

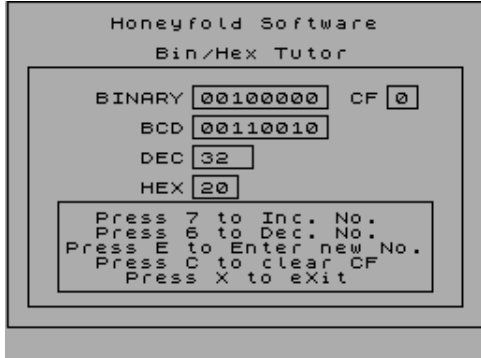

Biology (Collins Educational,1985)
Educational

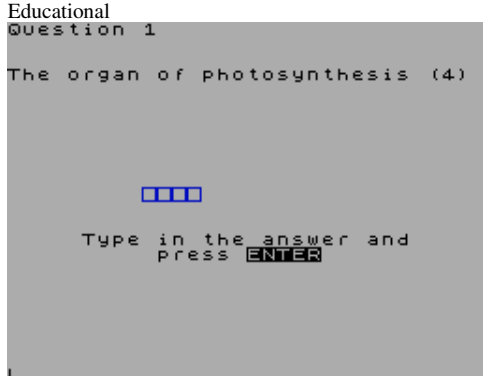

Bingo (.)
Board/Card Game

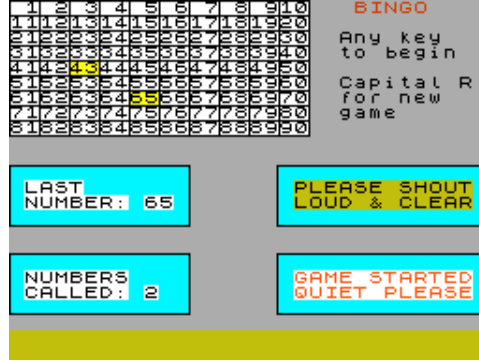

Bingo (MicroHobby,1985)
Board/Card Game

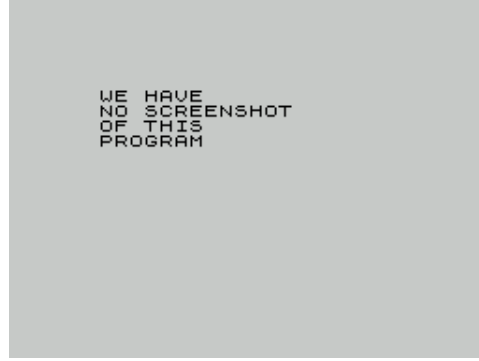

Bingo (Tynesoft,1984)
Board/Card Game



Binky (MicroHobby,1985)
Arcade



Biology (Disney Software,1987)
Educational



Bingo (J.L. del Rio Moreno,1983)
Board/Card Game

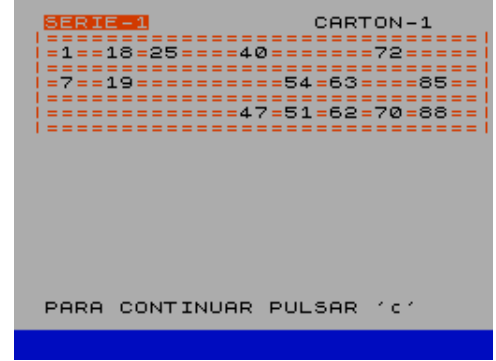

Bingo (Paraninfo Soft S.A.,)
Board/Card Game



Bingsete (Cibercomp S.A.,1984)
Board/Card Game



Biology (Charles Letts & Co,1985)
Educational



Biology (Hill MacGibbon,1986)
Educational

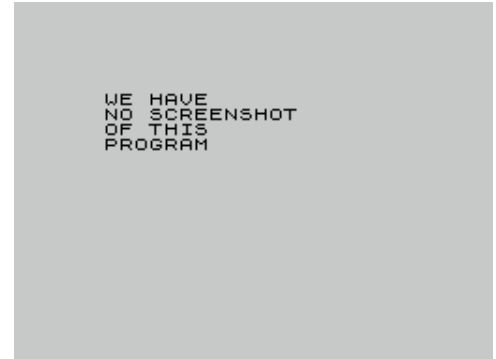

Biology (Longman Software,1984)
Educational

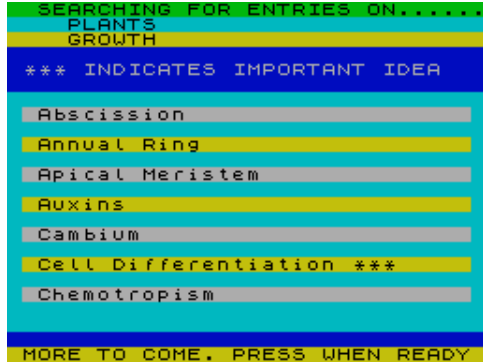

Biology - O'Level & CSE (Micro-De-Bug
Consultancy,1984)
Educational

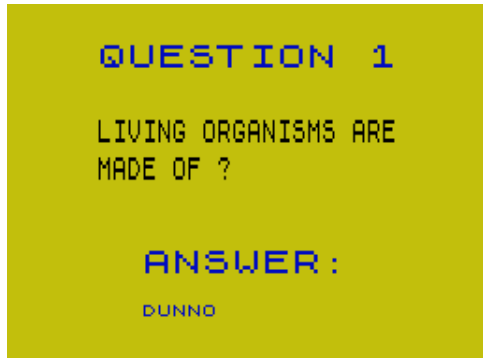

Bio-Rhythm (.)
Utility

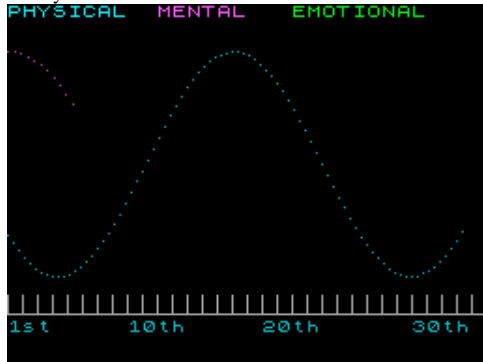

Biorhythms (Sinclair Research Ltd,1982)
Educational

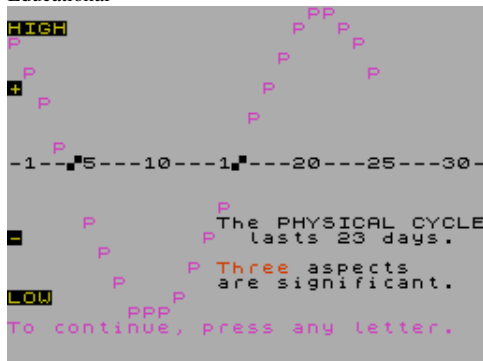

Bioritam (FV,1984)
Utility

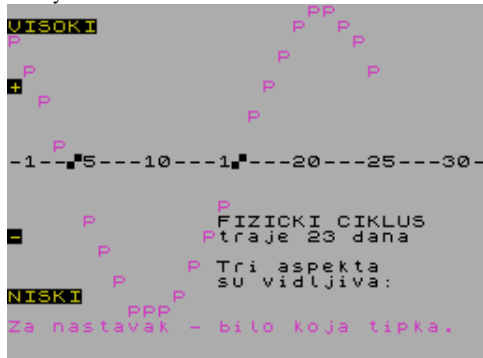

Biology - Examination Practice & Tests O Level
(Sphere Software.) Educational

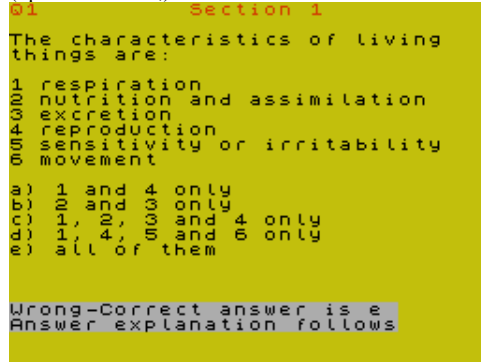

Bionic Commando (Go!,1988)
Arcade



Bio-Rhythm (Outlet Microdrive Magazine.)
Utility

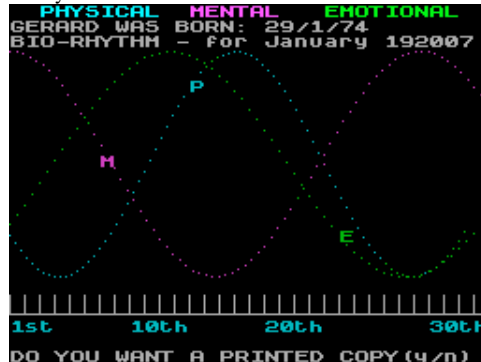

Biorhythms (Spectrum Computing,1985)
Utility



Bioritmus (Laszlo Nyitrai.)
Educational



Biology 'O' Level (Calisto,1983)
Educational

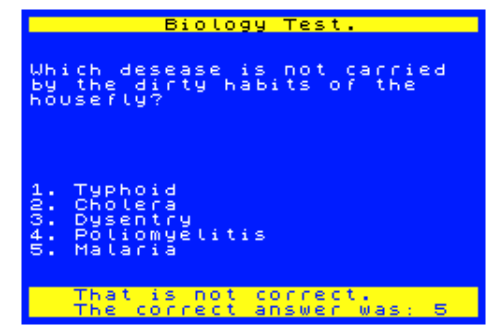

Bionic Ninja (Zeppelin Games Ltd,1989)
Arcade



Bio-Rhythms (Sinclair Programs,1982)
Utility

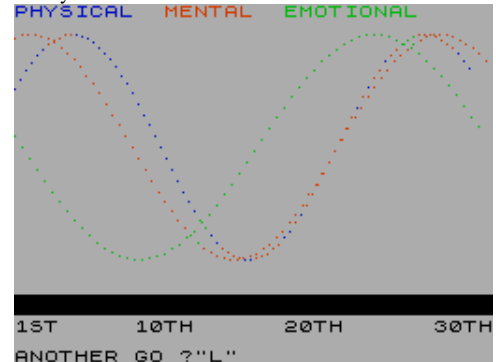

Biorhythmus (Juergen Gerdes,1984)
Utility

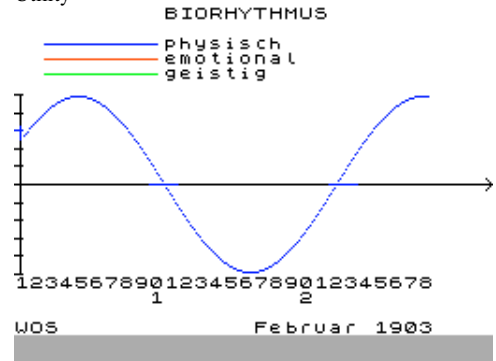

Biorritmos (MicroHobby,1984)
Utility



Biorritmos (Velez Software,1988)

Utility



Birds and the Bees, The (Bug-Byte Software Ltd,1983)

Arcade



Birdy (Your Computer,1985)

Arcade

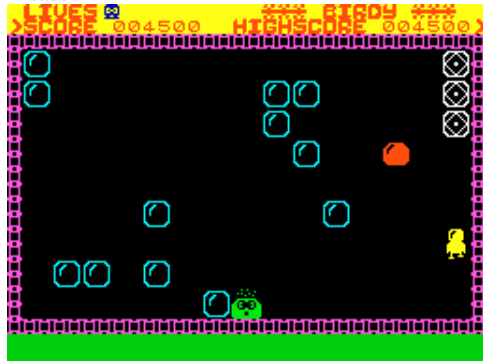

Bismarck (MicroHobby,1985)

Arcade



Bit Copy (Real Roth,1984)

Utility: Copier



Biorythmus (.)

Utility



Birds of Britain (Teacher's Pet Software,1988)

Educational



Birthday Surprise (The Guild,1992)

Text Adventure

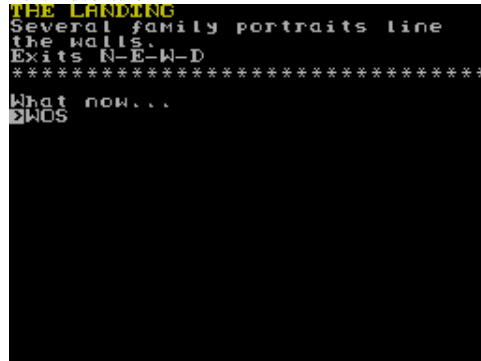

Bismarck (PSS,1987)

Strategy

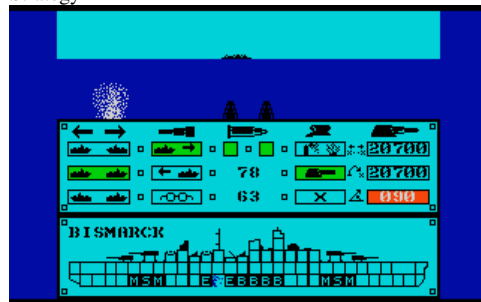

Bite the Dust (Crash,1988)

Arcade

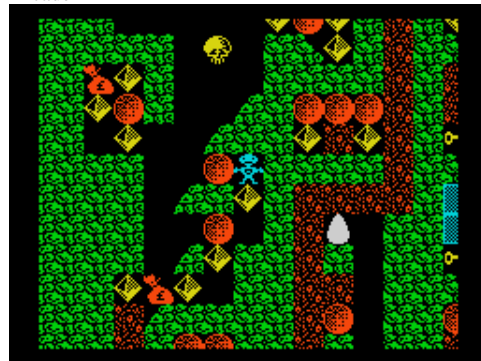

Birds (Piper Books Ltd,1984)

Educational

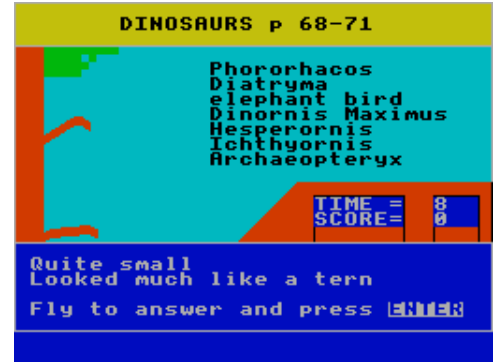

Birds, The (Rabbit Software Ltd,1983)

Arcade



Bismarck (.)

Strategy

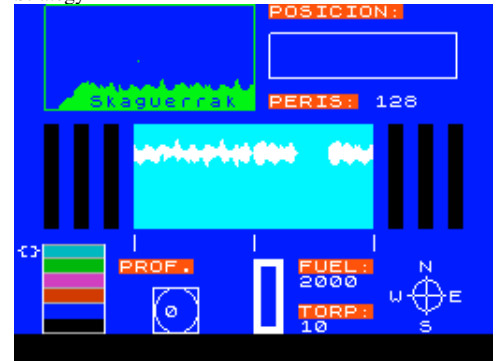

Bismarck (ASP Software Ltd,1983)

Strategy



Bitman (Spectrum Computing,1984)

Arcade



Bitwa o Wyspe II (.)
Strategy

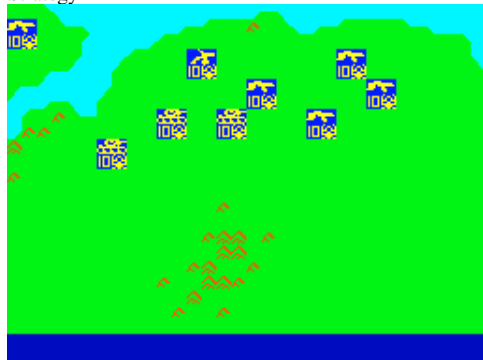

Biz, The (Ocean Software Ltd,1990)
Compilation

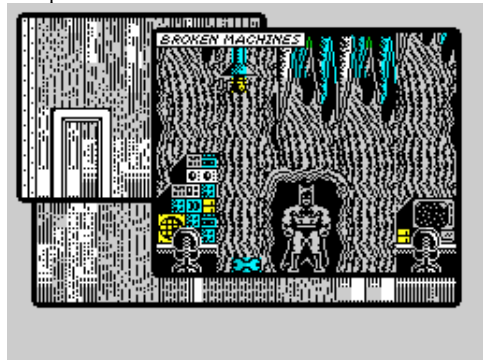

Black Arrow (Uros Justin,1986)
Arcade



Black Crypt (.1992)
Text Adventure



Black Friday (EMM Software,1983)
Simulation

```
* BULL market *
Jahr 1 2
+/- $ $$ 1 2
HIB 0000 1000 00 00
XTPP 0000 1000 00 00
SDPP 0000 1000 00 00
M 0000 1000 00 00
SD 0000 1000 00 00
KBT 0000 1000 00 00
KBA 0000 1000 00 00
BNE 0000 1000 00 00
BP 0000 1000 00 00
Dividenden: 0 0
Geld: 5000 5000
Gesamt: 5000 5000
Spieler 1, kaufen?
```

Bizarre Construction (Extreme,1997)
Scene Demo



Biz, The (Virgin Games Ltd,1984)
Simulation

```
"THE BIZ" STATUS IN WEEK 48 1985
ARTIST = Partibrejk
FROM A SUBURB IN BELFAST
RECORD LABEL = DECCA
CURRENT SINGLE = Hits1
MUSICAL DIRECTION = M.O.R.
RECORDS IN STOCK = UNLIMITED
THIS WEEKS SALES = 8389
TOTAL SALES... = 8389
WEEKS IN CHART.. = 1
HIGHEST POSITION = 46
THIS WEEKS CHART POSITION = 46 ↑
BAND TIGHTNESS = 100 %
STAGE PRESENCE = 43 %
VISUAL IMPACT = 0 %
SONG QUALITY = 89 %
FAN FOLLOWING = 42 %
DRIVE AMBITION = 73 %
OVERALL STAR RATING = 55 %
WEEKLY TAKING $ = £ 1527
MONEY IN THE BANK = £ 15090
PRESS 'X' TO CONTINUE "THE BIZ"
```

Blackbeard (Topo Soft,1988)
Arcade

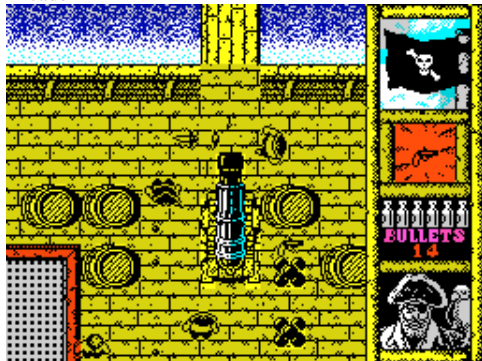

Black Crystal (Carnell Software,1982)
Arcade Adventure



Black Hawk (Creative Sparks,1984)
Arcade



Bizmiller (The RamJam Corporation,1987)
Arcade

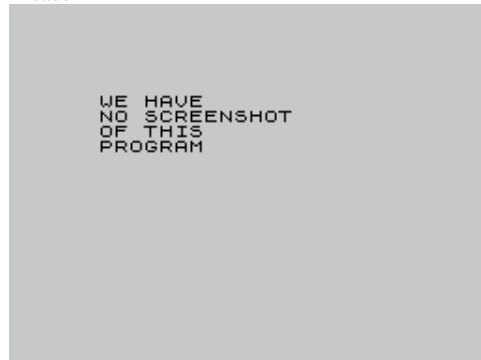

Bizzicom (Merlin Software [1],1985)
Utility

```
STOCK RECORDING 19/11/89
1. DISPLAY MODE (deletions,
   changes, transactions)
2. INSERT NEW ITEM(s)
3. PRINT VALUATION REPORT
   (on screen or printer)
4. QUICKLIST (just item,
   description, and stock)
5. SAVE FILE & END SESSION
6. INOPERATIVE
7. ERASE AND START A NEW FILE
ENTER NO. OF REQUIRED ACTIVITY
```

Blackbird (.)
Arcade

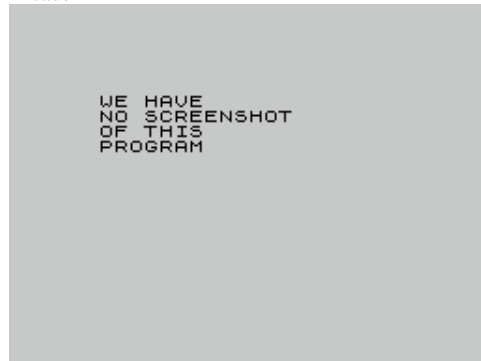

Black Dwarfs Lair, The (Newssoft Products,1982)
Text Adventure

```
WARNING..
I can hear MONEY rattling!
Tunnels lead to
30 33 36 39
You are currently in
Chamber 42
Lock,Move or Scry?(l,m,s)
```

Black Hole, The (Quest Microsoftware,1983)
Arcade



Black House (Atlantic Soft,1989)
Text Adventure

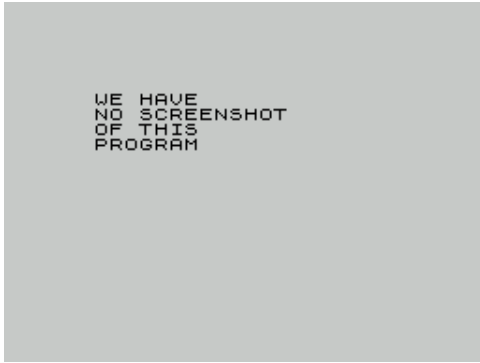

Blackjack (Chipmunk,1984)
Board/Card Game



Blackjack (James Hutchby,1984)
Board/Card Game

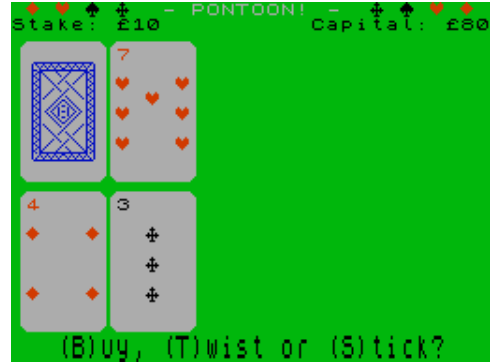

Blackjack (Keyword Software,1982)
Board/Card Game

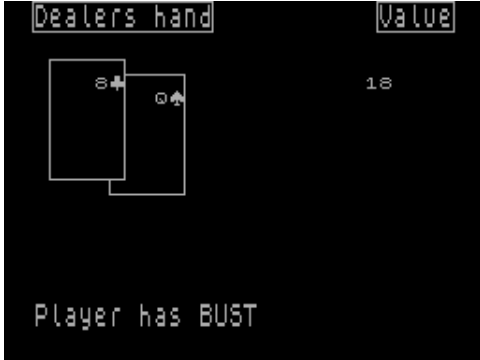

Blackjack (Micromega,1983)
Board/Card Game

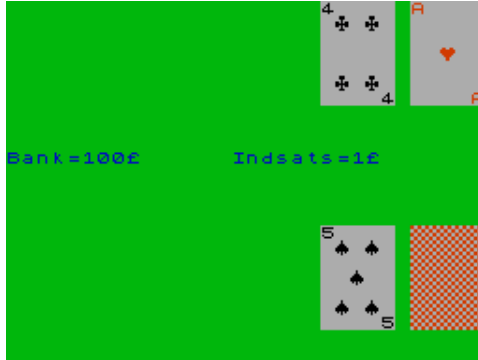

Black Jack (ZX Data.)
Board/Card Game

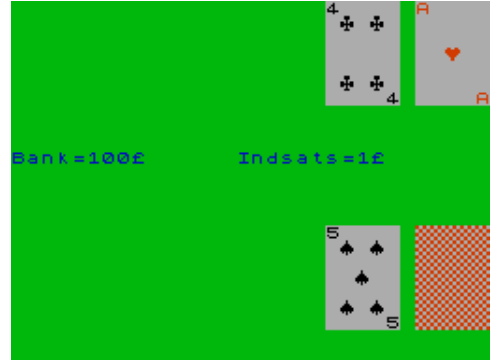

Black Jack [1] (MicroHobby,1985)
Board/Card Game



Black Jack [2] (MicroHobby,1986)
Arcade



Black Knight Adventure (Atlas Adventure Software,1988)
Text Adventure



Black Lamp (Firebird Software Ltd,1988)
Arcade Adventure

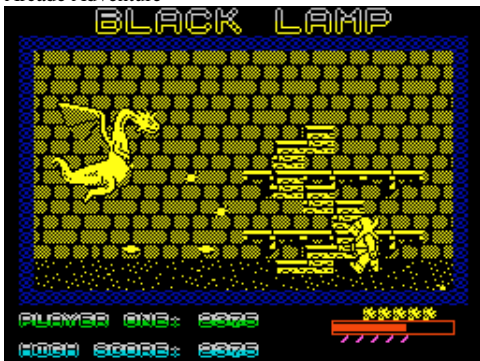

Black Magic (US Gold Ltd,1987)
Arcade Adventure

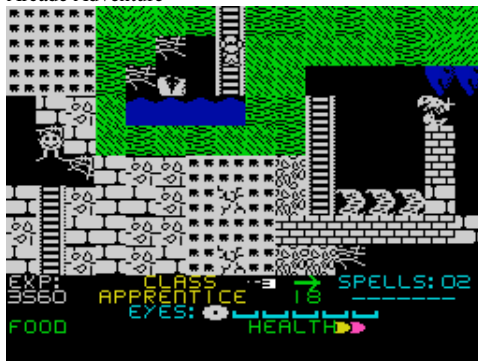

Black Planet (Phipps Associates,1983)
Arcade

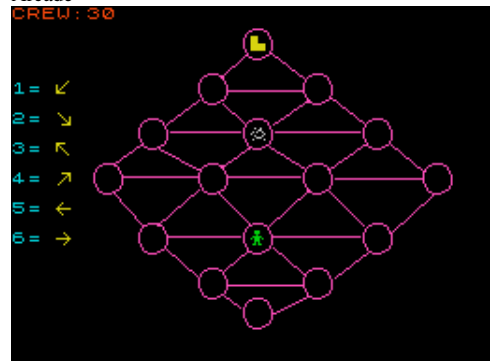

Black Raven 1 (Copper Feet,1997)
Strategy

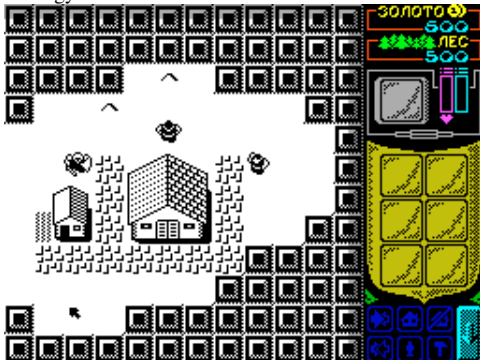

Black Raven 1: New Missions (Copper Feet/Compu-Studio Ltd,1999) Strategy

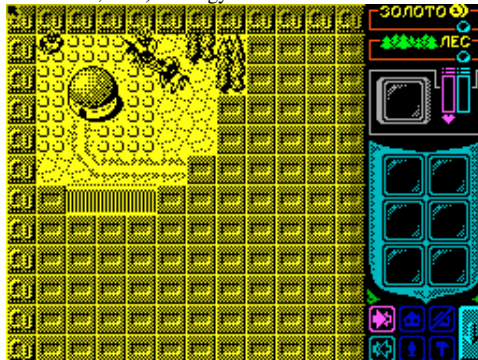

Black Raven 1 Mission editor (Compu-Studio Ltd,1999)
Arcade Game Development Tool

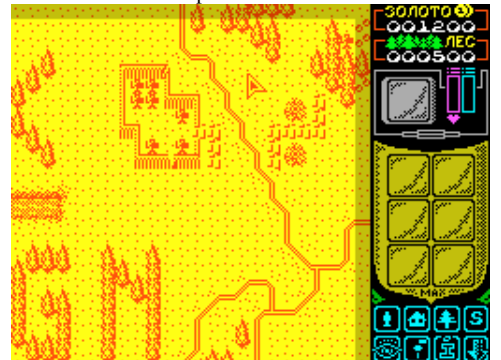

Black Raven 2 (Copper Feet,1988)
Strategy

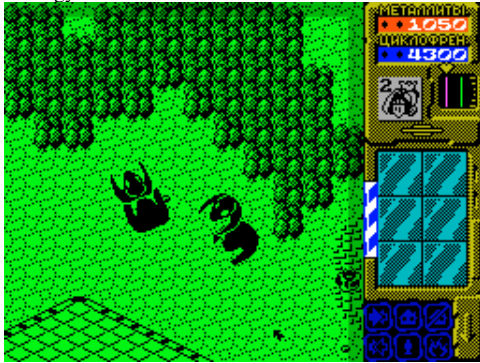

Black Tower (Zenobi Software,1984)
Text Adventure

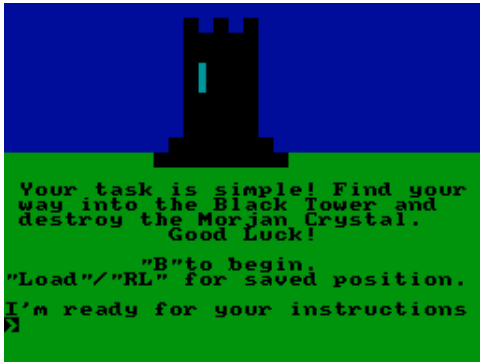

Blade Alley (PSS,1983)
Arcade



Blade Warrior (Code Masters Ltd,1988)
Arcade



Blaster (Ian Collier,1985)
Arcade



Black Swan (Sinclair User,1984)
Arcade



Black Tower 2: A Serpentine Tale (Diane Rice,1993)
Text Adventure

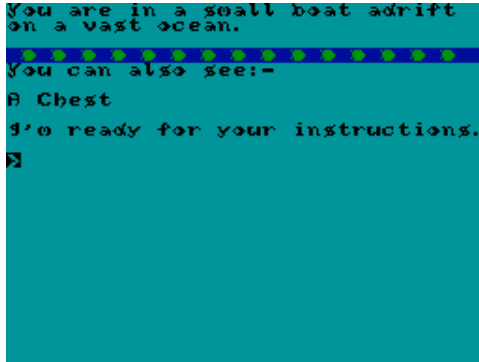

Blade Runner (CRL Group PLC,1985)
Arcade

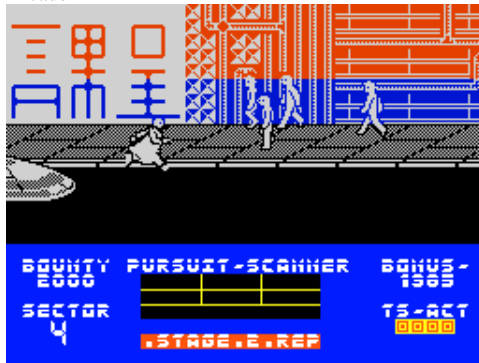

Blake's Seven (Sinclair User,1984)
Arcade



Blastermind (Martech Games Ltd,1983)
Arcade



Black Tiger (Go!,1989)
Arcade

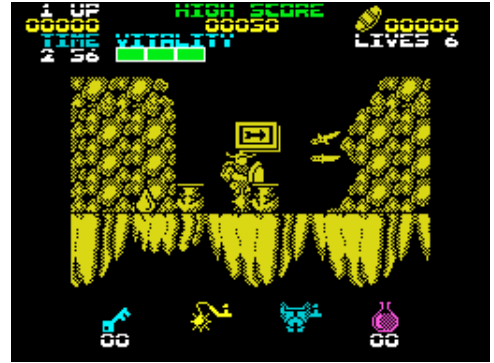

Black Tower, The (Dollarsoft,1984)
Text Adventure

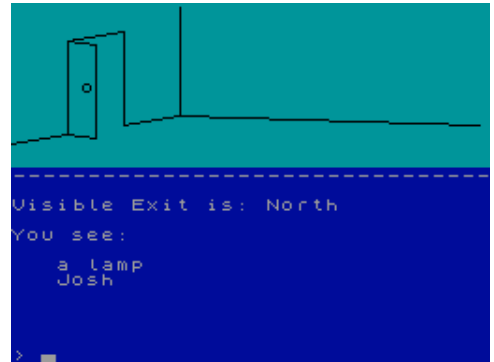

Blade the Warrior (Cable Software,1984)
Text Adventure

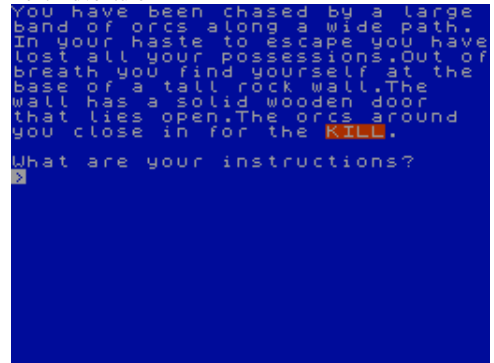

Blast (Oxford Computer Systems,1985)
Utility: Assembler/Disassembler/Monitor



Blasterooids (Image Works,1987)
Arcade



Blava (Sinclair User,1992)
Scene Demo



Blazing Thunder (Hi-Tec Software Ltd,1990)
Arcade



Blink (ZXIF,2003)
Text Adventure

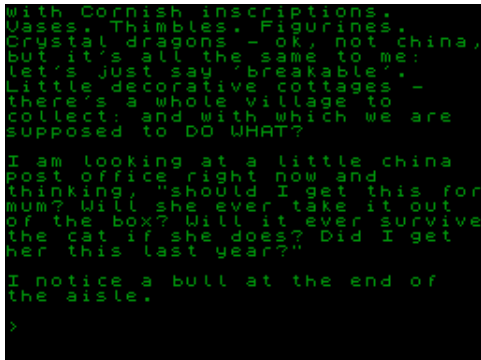

Blip! (Silverbird Software Ltd,1989)
Sport

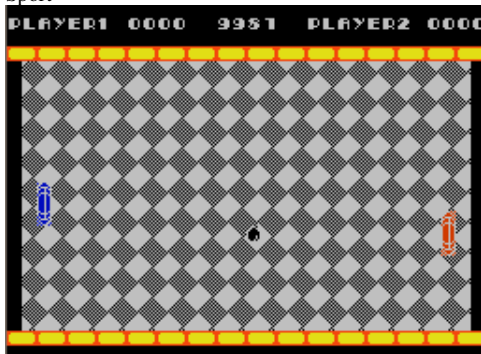

Blitz (WB Software,1983)
Arcade



Blaze (CCS,1984)
Strategy

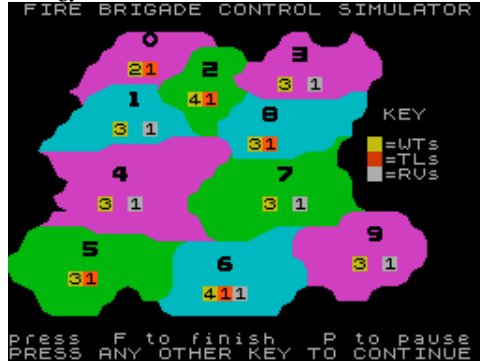

Blind Alley (Sunshine Books,1983)
Arcade



Blinky in America (Zeppelin Games Ltd,)
Arcade

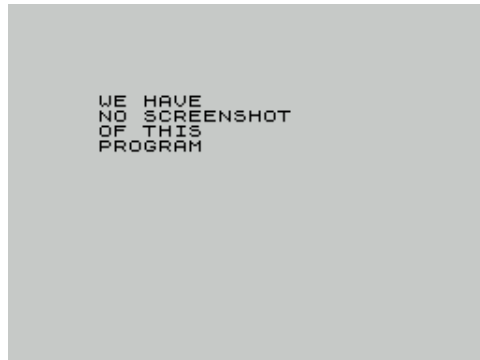

Blip (Wizard Software,1984)
Arcade



Blitz 3D (.)
Arcade



Blaze Out (Ocean Software Ltd,1988)
Compilation

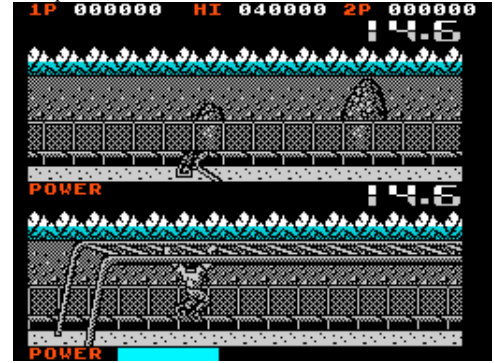

Blind Panic (Your Sinclair,1988)
Arcade



Blinky's Scary School (Zeppelin Games Ltd,1990)
Arcade

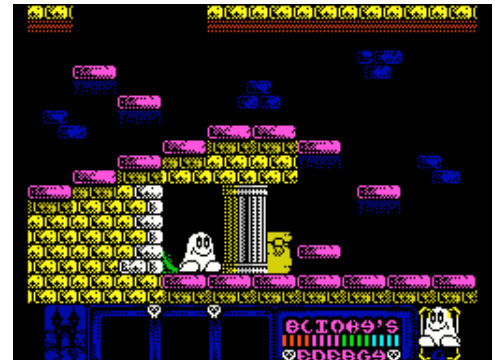

Blip Blop (Mike Dowman,1992)
Arcade Adventure



Blitz and Codebreaker (WB Software,1983)
Compilation



Blitzkrieg (CCS,1988)
Strategy



Blizzard Pass + H.A.R.D. (Tynesoft,1986)
Compilation



Blob, The (16/48 Tape Magazine,1985)
Arcade



Blockade Runner (Thorn Emi Video Ltd,1983)
Arcade



Blockbusters (ErnieWare,1986)
Arcade



Blitzkrieg (Impact Software [1],1983)
Arcade

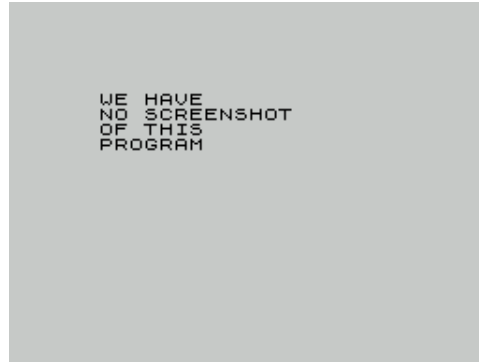

Blizzard's Rift (Jonathan Cauldwell,2007)
Arcade

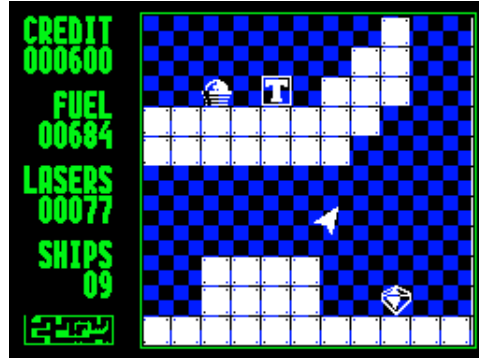

Blob the Cop (Sinclair User,1989)
Arcade



Block-Buster (Compusound,1984)
Board/Card Game



Blockbusters (Macsen Software,1984)
Board/Card Game



Blizzard Pass (Adventuresoft UK Ltd,1986)
Text Adventure



Blob Quest (Richard Swann,1992)
Text Adventure



Block (MicroHobby,1989)
Board/Card Game

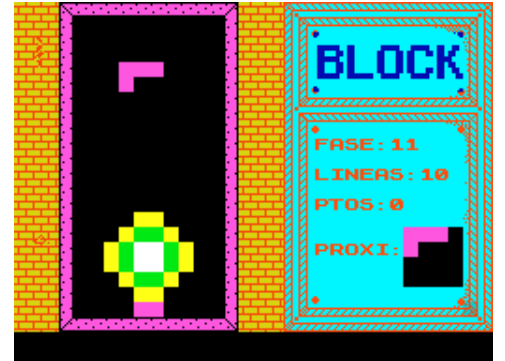

Block Buster (ZX Computing,1985)
Arcade

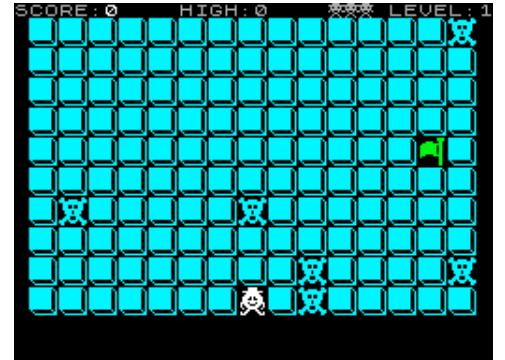

Blockbusters (TV Games,1987)
Board/Card Game



Blockbusters: Gold Run (Macsen Software,1984)
Board/Card Game



Blockfill (Shiva Publishing Ltd,1983)
Utility



Block Tetris (Dimik Soft,1994)
Arcade

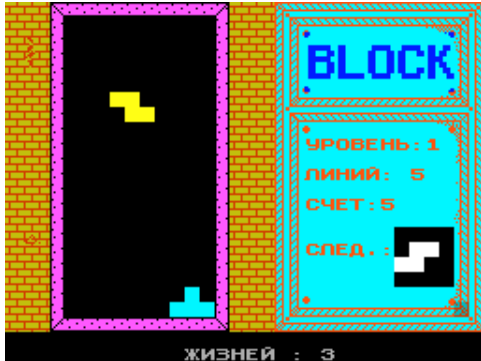

Blokade (Enigma Variations Ltd,1990)
Arcade



Blood Brothers (Gremlin Graphics Software Ltd,1988)
Arcade



Blockbusters Question Master (Macsen Software,1985)
Board/Card Game

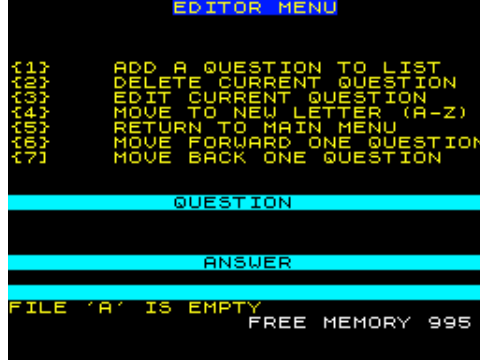

Block Paint (Your Computer,1984)
Arcade



Blockus (Bitmunchers,1995)
Arcade



Blok Load (Z80 Pros,1988)
Utility



Blood & Guts (Quicksilva Ltd,1984)
Arcade



Block-Dizzy (Your Sinclair,1992)
Arcade

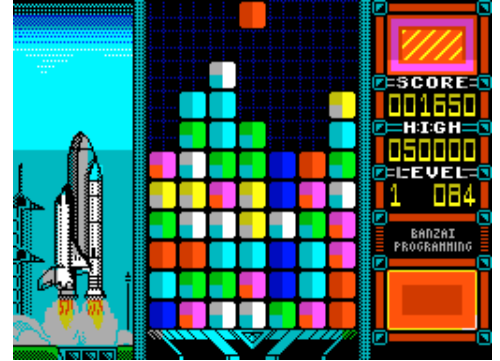

Block Renumber (Shiva Publishing Ltd,1983)
Utility



Block War 3000 AD (Vinsoft,)
Strategy



Blokman (Your Computer,1984)
Arcade

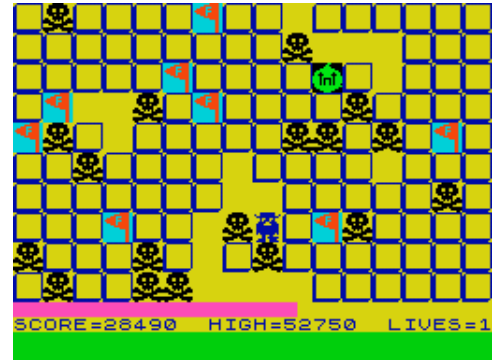

Blood Jack, The (Hacker Jack/Snow Man,1991)
Scene Demo



Blood of Bogmole, The (Compass Software,1986)
Text Adventure



Bloodwych (Image Works,1990)
Arcade Adventure

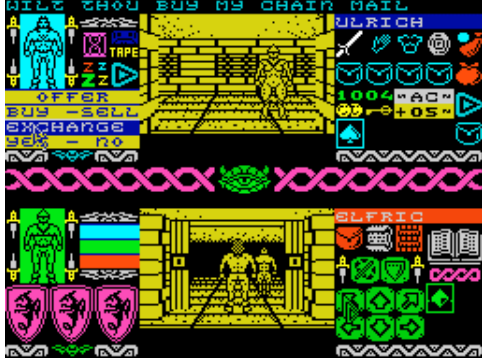

Blue Max (US Gold Ltd,1984)
Arcade



Blue Sky Discoteca (.)
Scene Demo



BMX Freestyle (Code Masters Ltd,1989)
Arcade

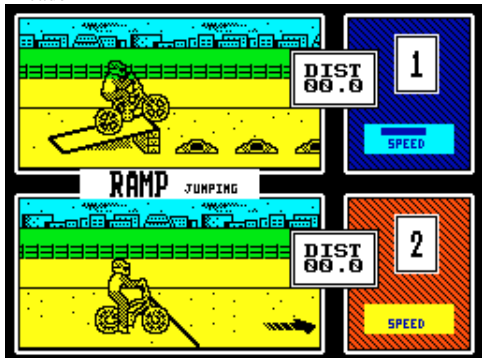

Blood of Smeagol, The (Compass Software,)
Text Adventure

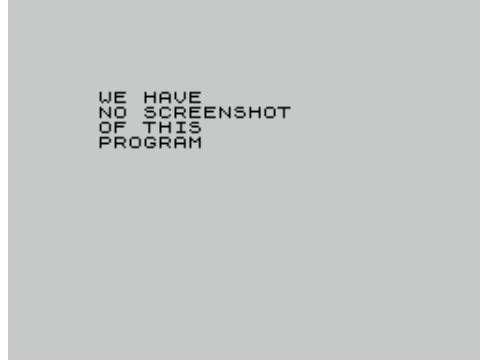

Bloody (Sygran S.A.,1987)
Arcade Adventure



Blue Riband (CCS,1984)
Simulation



Blue Thunder (Richard Wilcox Software,1984)
Arcade



BMX Jungle Bike (Reelax Games,1985)
Arcade



Blood Valley (Gremlin Graphics Software Ltd,1987)
Arcade Adventure



Bloody Paws (G.L.L. Software,1990)
Arcade Adventure



Blues Brothers, The (Rock'n'Soft,1995)
Arcade

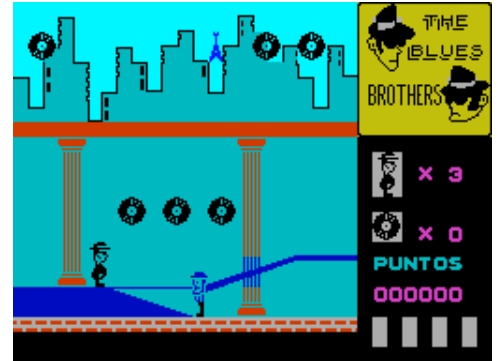

BMD (Brimardon Computer Racing Service,)
Utility



BMX Kidz (Firebird Software Ltd,1988)
Arcade



BMX Ninja (Alternative Software Ltd,1988)
Arcade



BMX Simulator (Code Masters Ltd,1987)
Arcade



Boatit (Phillip Sproston,)
Arcade

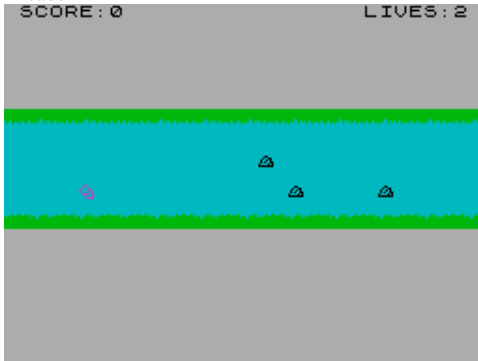

Bobby Charlton's Soccer (Dacc Ltd,1985)
Sport



Bobsleigh (Digital Integration,1987)
Sport



BMX Racers (Mastertronic Ltd,1984)
Arcade

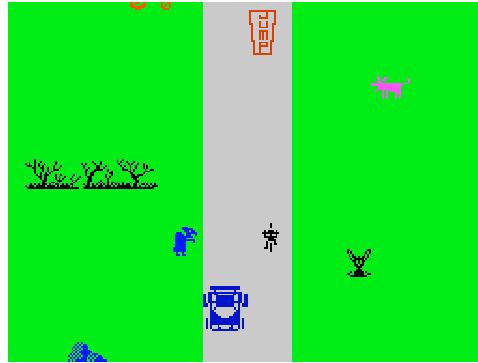

BMX Simulator 2 (Code Masters Ltd,1989)
Arcade

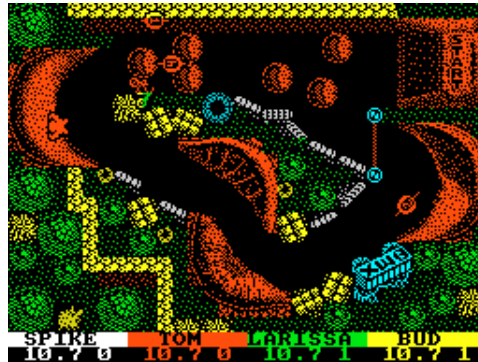

Boat Run (unpublished,1983)
Arcade



Bobby Yazz Show, The (Crash,1991)
Arcade



Bobsleigh (Granada Publishing,1983)
Arcade

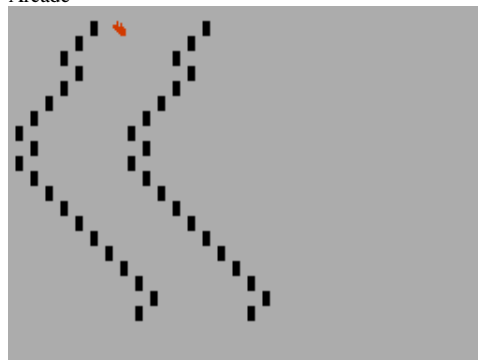

BMX Rider (Sinclair Programs,1984)
Arcade

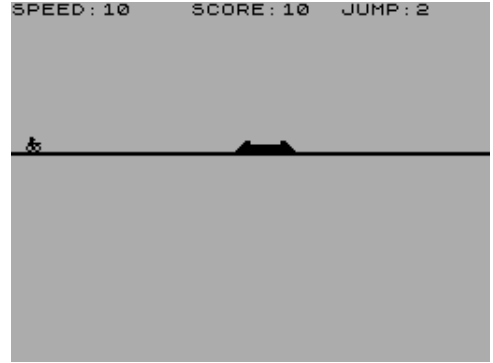

BMX Trials (Llailan Software,1985)
Arcade



Bobby Bearing (The Edge Software,1986)
Arcade

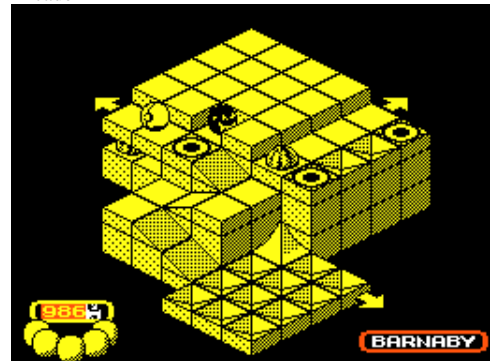

Bob's Full House (Domark Ltd,1988)
Board/Card Game



Bob's Music Collection (Technium 220,1994)
Scene Demo



Bodega, La (MicroHobby,1985)
Arcade



Body Works (Genesis Productions Ltd,1985)
Educational

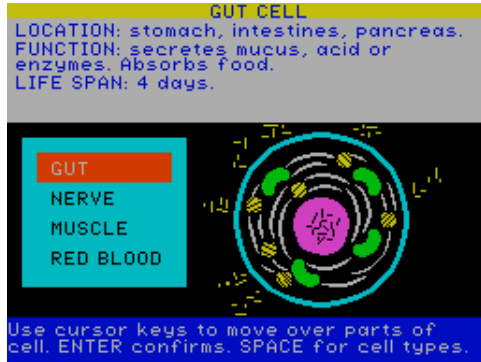

Boggit, The (CRL Group PLC,1986)
Text Adventure



Bogie's Pick 1 (Top Ten Software,1988)
Compilation



Bogie's Pick 4 (Top Ten Software,1988)
Compilation



Bodorrío Real (Beyker Soft,2004)
Arcade



Boekhouding (W.M.J. Schoonenberg,1983)
Utility: Spreadsheet



Boggle (MicroHobby,1985)
Arcade

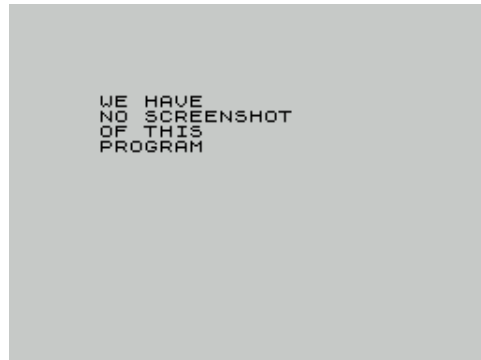

Bogie's Pick 2 (Top Ten Software,1988)
Compilation



Bog of Brit (Stormbringer Software,1990)
Text Adventure



Bodyswop (Macmillan Software Ltd/Sinclair Research Ltd,1985)
Educational



Boer Jansen heeft een Boerderij (Wolters Software,1984)
Educational

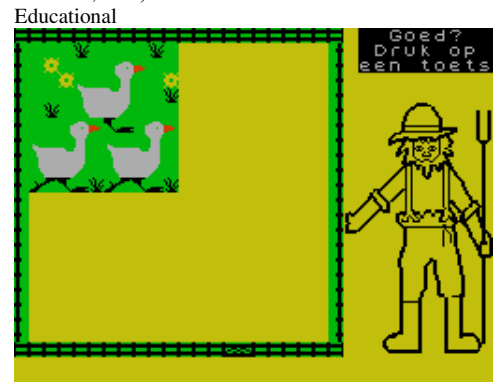

Boggle (Sinclair User,1986)
Board/Card Game

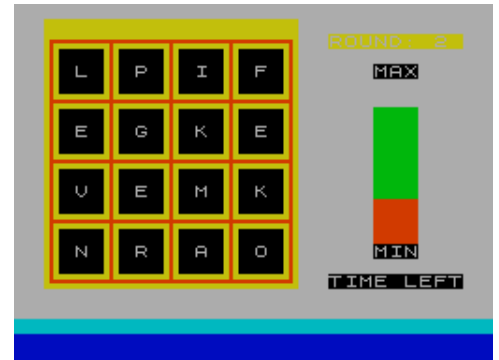

Bogie's Pick 3 (Top Ten Software,1988)
Compilation



Bog of Brit + Menagerie, The (Stormbringer Software,1990)
Compilation



Boid (Gadtek Games,1992)
Arcade



Bolas (MicroHobby,1985)
Arcade



Bolsa (Cloue.)
Simulation

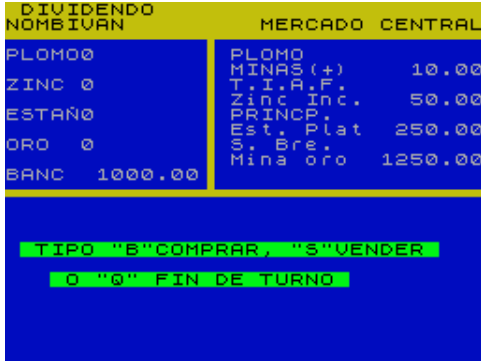

Bombardier (Kamasoft,1987)
Arcade

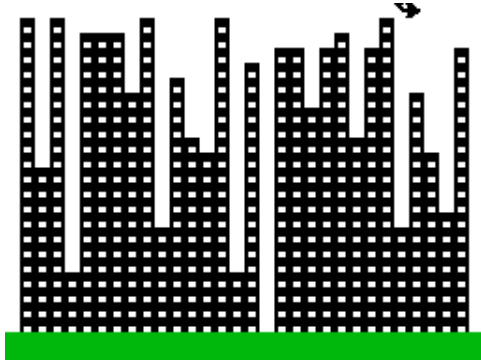

Bomb Ed (Sinclair User,1992)
Arcade



Boiler House (Front Runner,1984)
Arcade

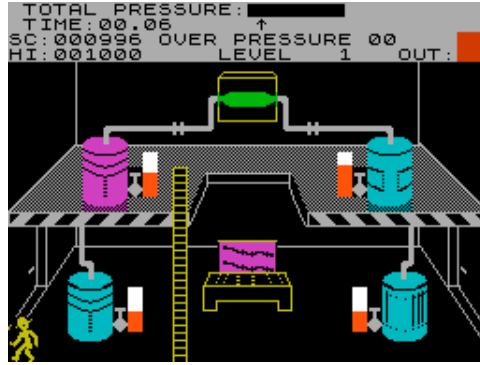

Bolas, Las (MicroHobby,1986)
Arcade



Bomb (Masters Games,)
Board/Card Game

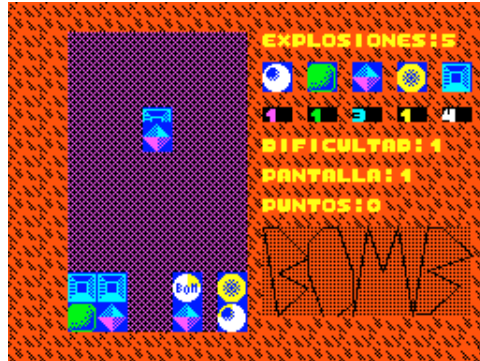

Bombardero (Microparadise Software,1984)
Arcade



Bombed Out (Enigma Variations Ltd,1990)
Arcade



Bolarinto (MicroHobby,1986)
Arcade



Bolera (MicroHobby,1985)
Arcade

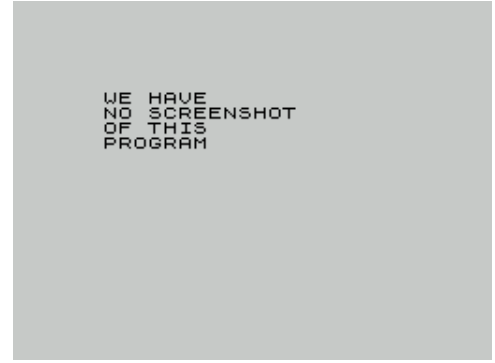

Bomb Alley (Your Computer,1984)
Arcade



Bombardero, El (MicroHobby,1985)
Arcade



Bomber (.)
Arcade



Bomber (Chromasoft,1982)
Arcade



Bomber (Sonic Software,1982)
Arcade



Bomber + Fruit Machine (C-Tech,1982)
Compilation



Bomberman (Hudson Soft,1983)
Arcade

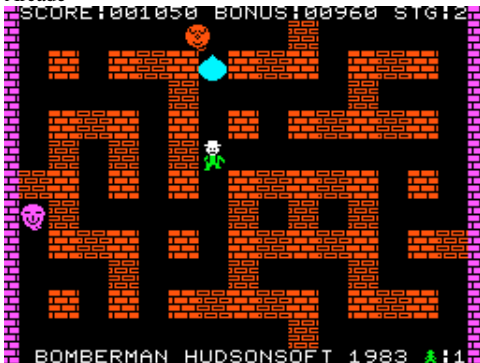

Bombero, El (MicroHobby,1985)
Arcade



Bomber (Excellent Four Software,1995)
Board/Card Game

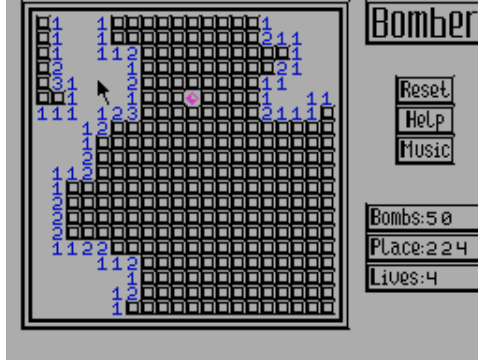

Bomber (Spectrum Computing,1983)
Arcade



Bomber 2 (Valuesoft,1983)
Arcade



Bombermice (XFAWORLD Software,2003)
Arcade



Bombfusion (Mastertronic Ltd,1989)
Arcade



Bomber (Global Games [2],1985)
Arcade

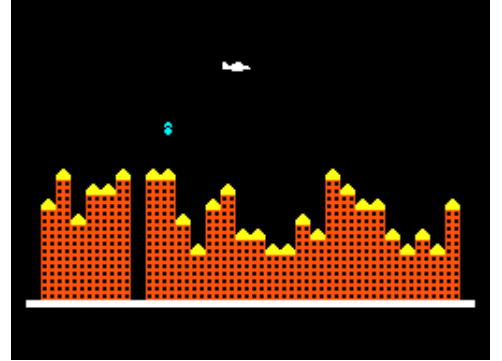

Bomber (ZX Computing,1983)
Arcade

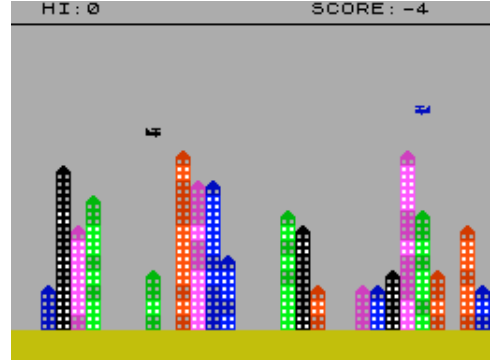

Bomber Bob in Pentagon Capers (Bug-Byte Software Ltd,1985)
Arcade

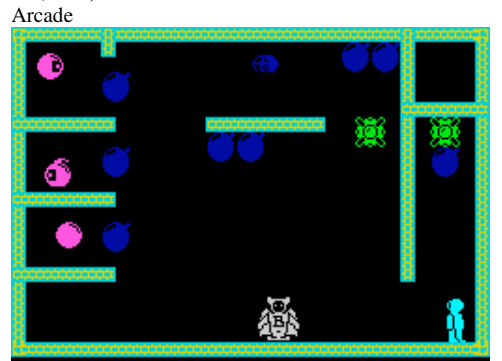

Bombero (Grupo de Trabajo Software S.A.,1987)
Arcade



Bomb Jack (Elite Systems Ltd,1986)
Arcade



Bomb Jack II (Elite Systems Ltd,1987)

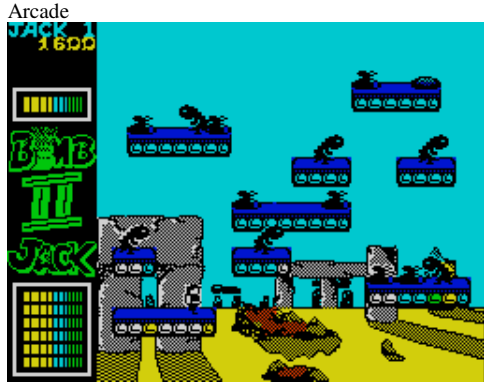

Bombuzal (Thalamus Ltd.)
Simulation



Bond, The (R. Stobbe,1984)
Text Adventure



Bonkers (Procom Software,1983)
Arcade



Booklist for ZX Spectrum (16/48 Tape Magazine,1985)

Utility: Database

APPS, Vince			
Learning is fun! 40 educational games for the Spectrum.			
Granada, 1983.		£5.95	
246 12233 1	(BBIP 1.84)		
BETTS, Steve			
Spectrum magic: your first programming book.(for children).			
Foulsham, 1984.		£4.95	
572 01233 0	(BBIP 1.84)		
DEESON, Eric			
Learning with the Spectrum.			
RVC Software, 1982.		£2	
946369 01 1	(BBIP 1.84)		
DEESON, Eric			
Spectrum in education.			
Shiva, 1983.		£6.50	
906812 29 1	(BBIP 1.84)		

Press SPACE to cont, Q to quit:

Bomb scare (Dollarsoft,1984)



Bonabanner (Outlet Microdrive Magazine,1987)
Utility



Bones (Corporation AS/DS,1991)
Board/Card Game

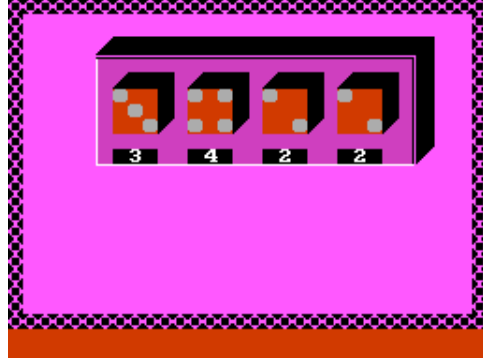

Bonus Game or Dasher (Merlin Software [2],1996)
Arcade

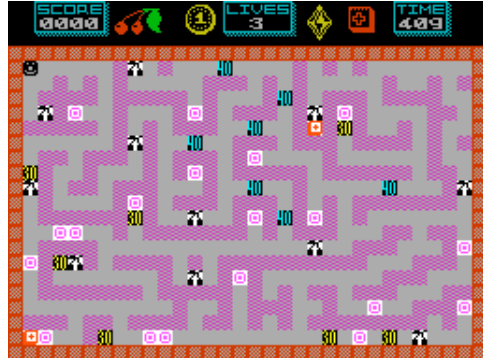

Book of the Dead (Essential Myth,1987)

Text Adventure

You are in a spheroid, swimming in gooey albumen. The sound of someone knocking comes from outside.

Bomb scare (Firebird Software Ltd,1986)

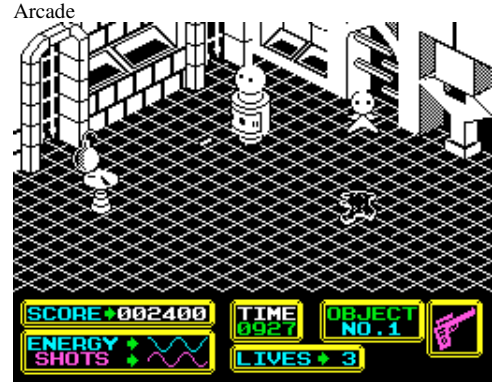

Bonanza Bros. (US Gold Ltd,1991)
Arcade



Bongo (Anirog Software,1984)
Arcade



Bonweshar Uctopur (Fantasy,1994)
Text Adventure

ИЗРУ (1/1) ?
Да.
Фалькорус находится в комнате, освещенной слабым светом факела. В центре комнаты стоит стол.
На столе лежит потрепанная книга из магии.
Единственный проход ведет на север.

Boom Box volume 1 (Digital Design,1987)

Scene Demo

BOOM BOX

1: Axel F
2: The Pink Panther
3: Ghostbusters
4: Topgun

Select tune

Brian
A bunch of tunes we've got for u

Boots Action Pack (Boots,1987)
Compilation



Boovie 2 (E.S.A. Productions,1998)
Arcade



Border Efekti (Radovanovic Aleksandar,1985)
Utility: Screen Manipulation



Borec (.)
Utility: Copier

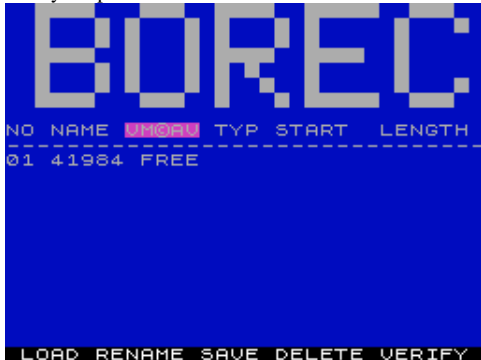

Borrowed Time (.)
Text Adventure



Booty (Firebird Software Ltd,1984)
Arcade



Booze Up (,1992)
Text Adventure

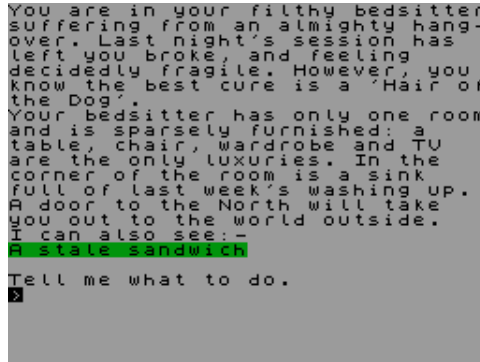

Border Harrier (Sole Solution Software,1986)
Text Adventure



Bored of the Rings (Delta 4 Software,1985)
Text Adventure

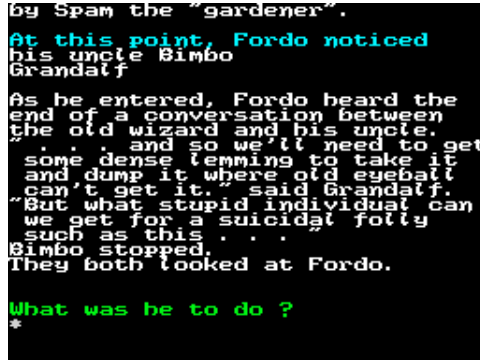

Borzak (Channel 8 Software,1984)
Arcade



Boovie (KVL,1994)
Arcade



Bopper's (Miguel Angel Gonzalez Alvarez,)
Arcade



Border Harrier + Warlord + The Golden Cobra (The Guild,1986) Compilation



Borrador de EPROM (MicroHobby,1985)
Utility



Bosconian '87 (Mastertronic Ltd,1987)
Arcade



Bossman (Avalon Software,1984)
Strategy



Boss, The (Peaksoft,1984)
Simulation



Bothkill (Marian Cascaval,2007)
Arcade



Boulder Dash (Front Runner,1984)
Arcade

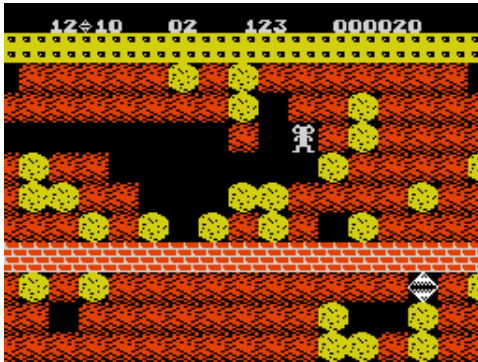

Boulder Dash Construction Kit (Databyte,1988)
Arcade

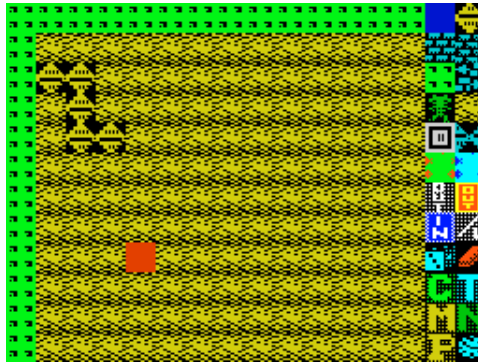

Boulder Dash II: Rockford's Riot (Prism Leisure Corporation PLC,1985)
Arcade

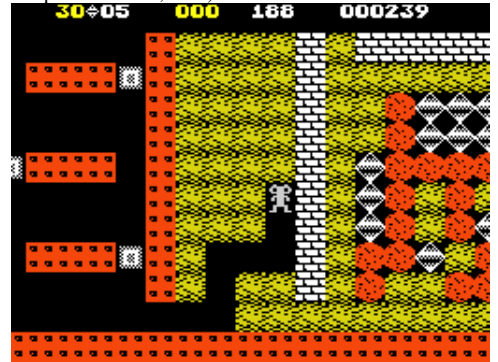

Boulder Dash III (Prism Leisure Corporation PLC,1986)
Arcade

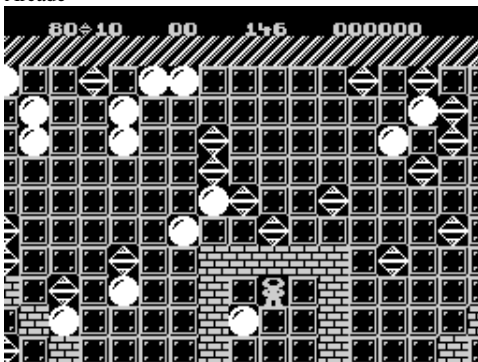

Boulder Dash IV (Hi-Tec Software Ltd,1990)
Arcade

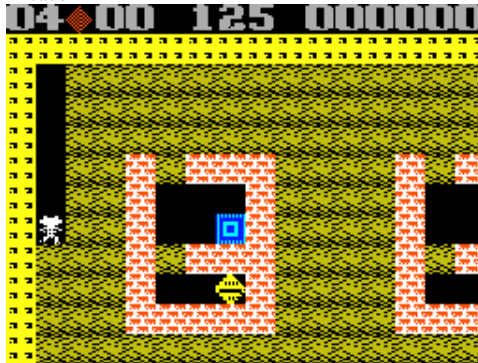

Boulder Mix (Firesoft,)
Arcade Adventure



Bounce Panic (Poppy Soft,1983)
Arcade

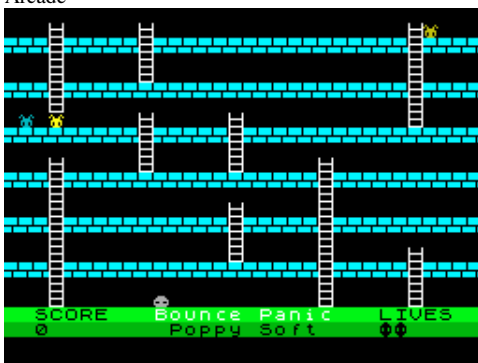

Bouncer (Outlet Microdrive Magazine,)
Scene Demo

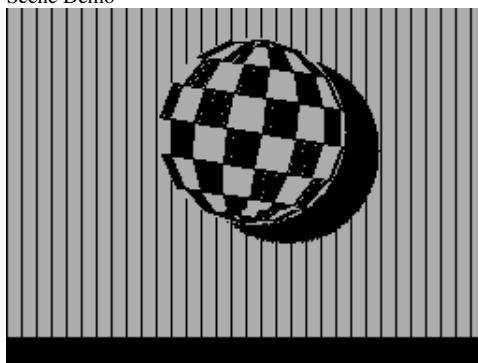

Bounces (Beyond Software,1985)
Arcade

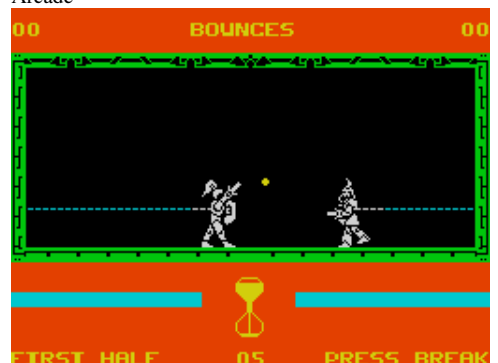

Bouncing Ball (Sinclair Programs,1984)
Arcade

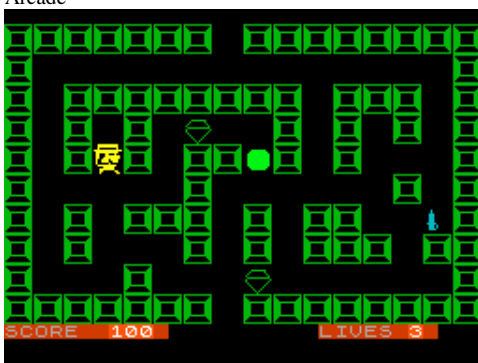

Bouncing Bertie (Power Software,1984)
Arcade



Bouncing Bertie + Eskimo Capers (Power Software,1984)
Compilation



Bounder (Gremlin Graphics Software Ltd,1986)
Arcade



Bounty Hunter, The (River Software,1989)
Text Adventure



Bowling (.)
Arcade

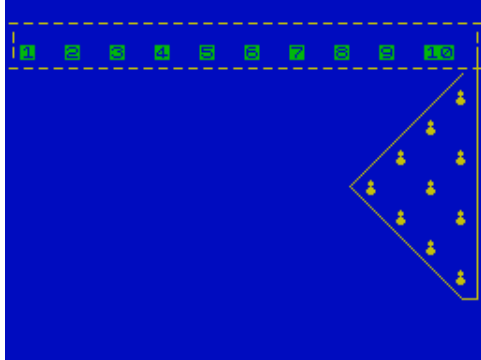

Bow, The (The Power House,1987)
Arcade



Boxeo (Rafael Vico Costa,1992)
Arcade



Bounty Bob Strikes Back (US Gold Ltd,1985)
Arcade



Bounzai (Epsilon Software,1986)
Strategy



Bowling 2000 (Proxima Software,1992)
Sport

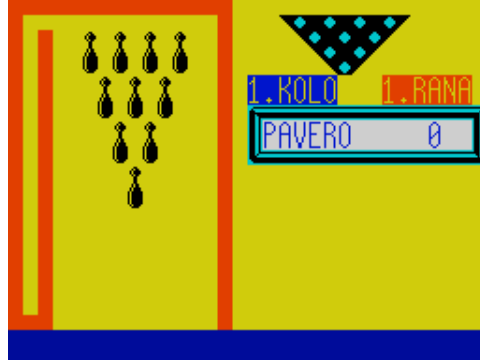

Box (Beyker Soft,2006)
Board/Card Game

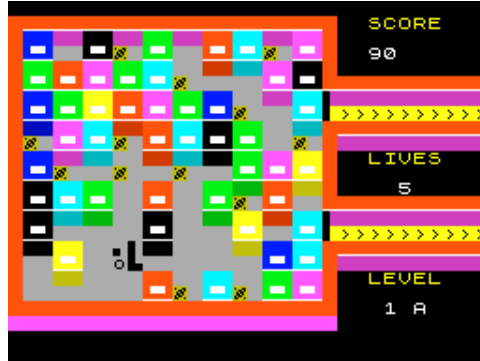

Boxer (MicroHobby,1985)
Sport



Bounty Hunter, The (Code Masters Ltd,1989)
Arcade



Bounzai (Your Spectrum,1985)
Board/Card Game

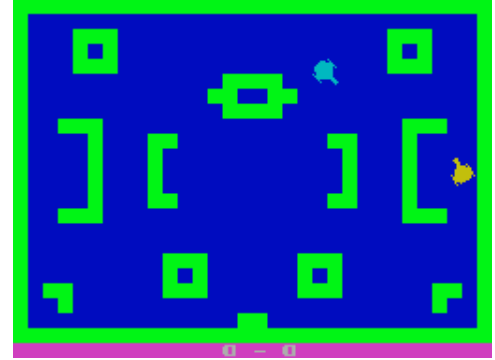

Bowls (Lotus-Soft,1984)
Sport

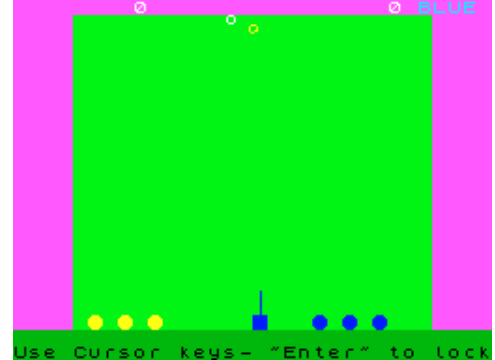

Box Bounce (Virgin Books,1983)
Arcade



Boxer, The (Cult Games,1990)
Simulation



Boxform (Boxoft,1988)
Simulation

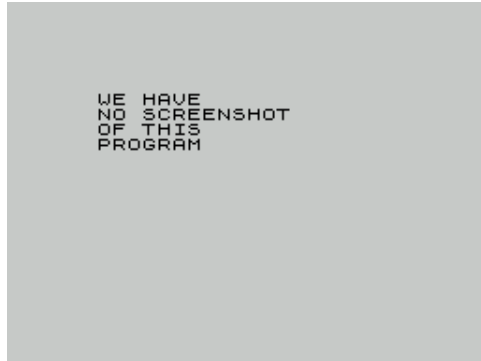

Boxing (Silicon Joy,1984)
Sport

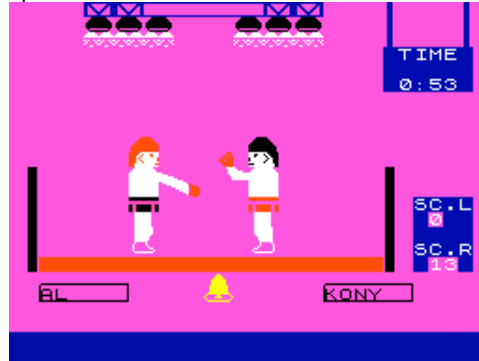

Boxing Manager (Willysoft UK,1987)
Simulation

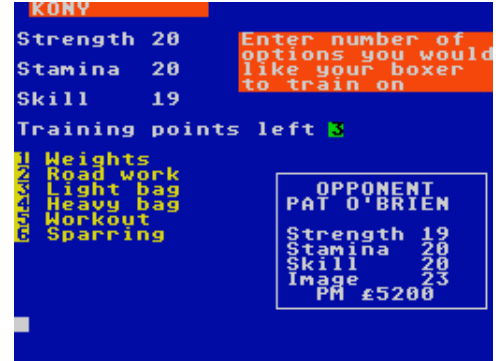

Boxing Manager 2 (D&H Games,1988)
Simulation



Boyd File, The (Zenobi Software,1990)
Text Adventure

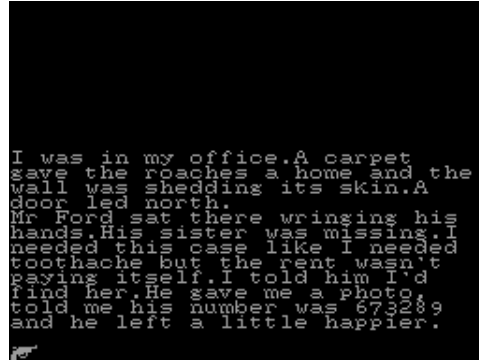

Boyerland (MicroHobby,1985)
Arcade



Bozy-Boa (CDS Microsystems,1983)
Arcade

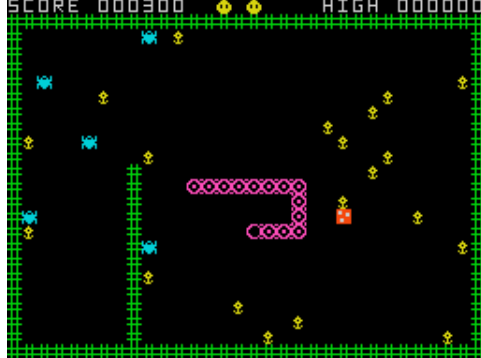

Brad Blasts the Galactic Barbarians (Express Software [1],1983) Arcade

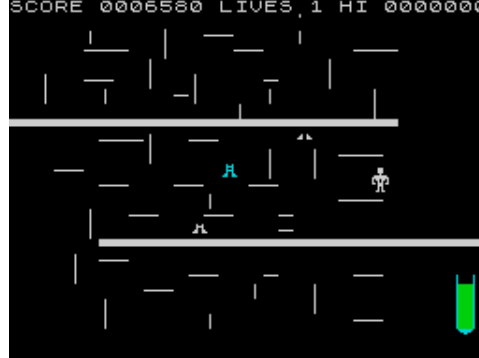

Brag (Dream Makers Software,1994)
Scene Demo



Brainache (Code Masters Ltd,1987)
Arcade



Brain Crash Demo (Progress Software Makers Team,1996)
Scene Demo



Brain Damage (Silversoft Ltd,1983)
Arcade



Brain Pressure Inside (Last Masters Group,1999)
Board/Card Game



Brain Sport (Your Sinclair,1991)
Strategy

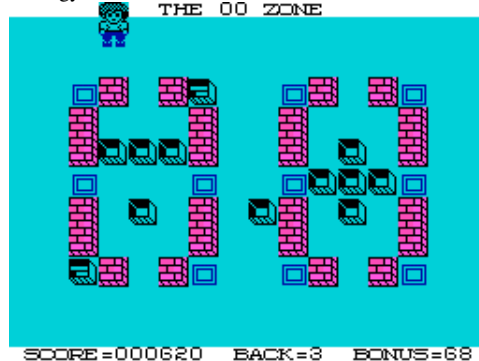

Brainstorm (Bubblebus Software,1985)
Arcade

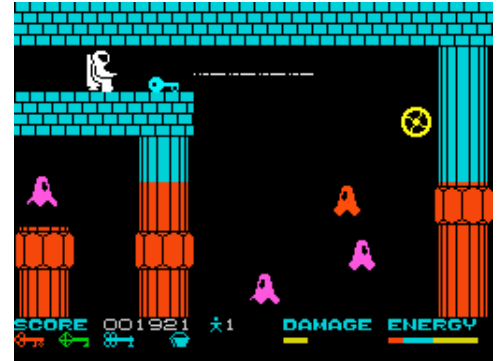

Brainstorm (Firebird Software Ltd,1987)
Arcade

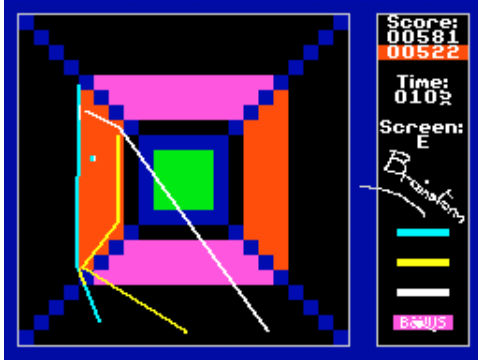

Brain Train, The (Camel Micros,1984)
Educational



Branch of Mind Demo (Pentagram,1993)
Scene Demo



BraveStarr (Go!,1987)
Arcade



Breaker (Racunari,1984)

Utility: Copier

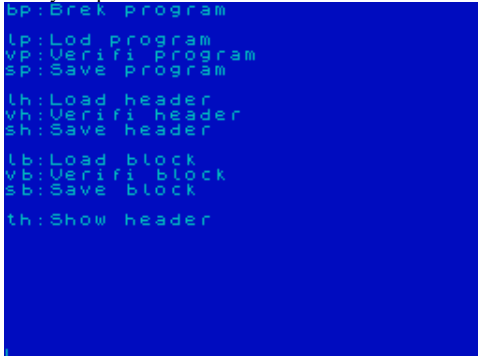

Brainstorm (Micromega,1983)
Board/Card Game

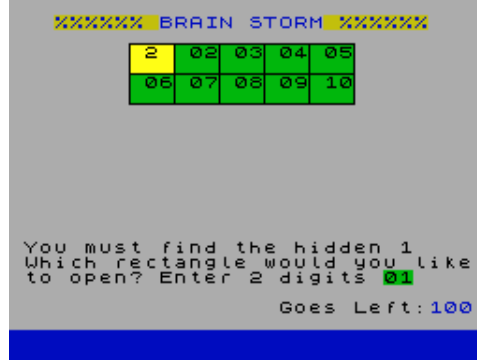

Brainwaves (.)
Simulation



Brat Attack (Sinclair User,1988)
Arcade



Braxx Bluff (Micromega,1984)
Arcade

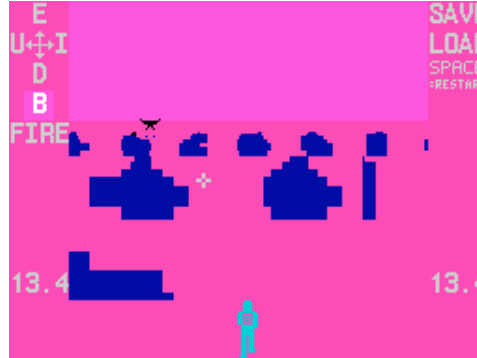

Breaker (Wizard Software,1983)

Arcade



Brain Surgery (Dream Makers Software,1997)
Scene Demo



Brainzoff (A. Walter,1985)
Board/Card Game



Brautrydjandinn (Mjukvara sf,1985)
Arcade

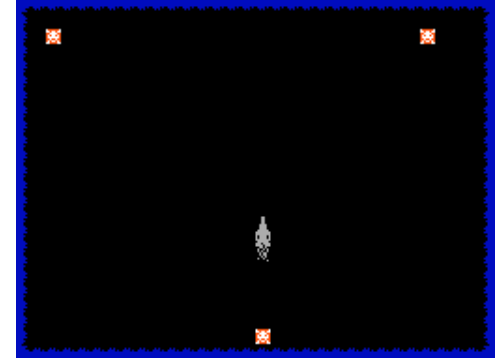

Break-Away (Procom Software,1983)
Arcade

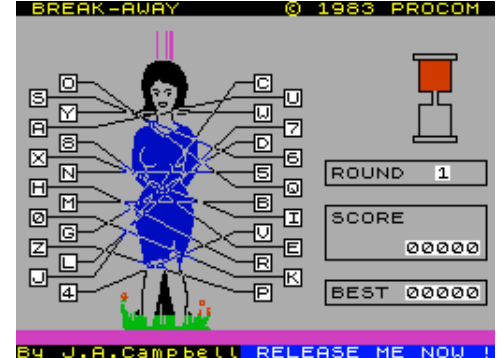

Breakless (16/48 Tape Magazine,1984)

Utility: BASIC Related



Break Neck (Lucitania,1990)
Arcade

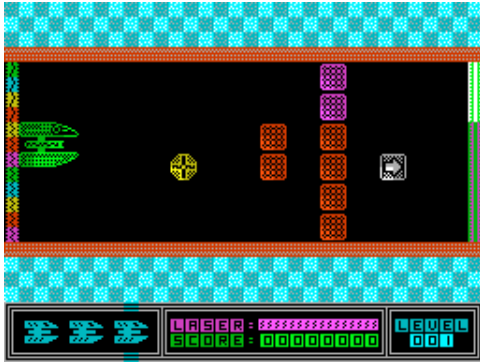

Break Out (Romik Software,1983)
Arcade



Brewery (CCS,1983)
Simulation



Brian Bloodaxe (The Edge Software,1985)
Arcade



Brickbat (Shiva Publishing Ltd,1983)
Arcade



Breakout (,)
Arcade

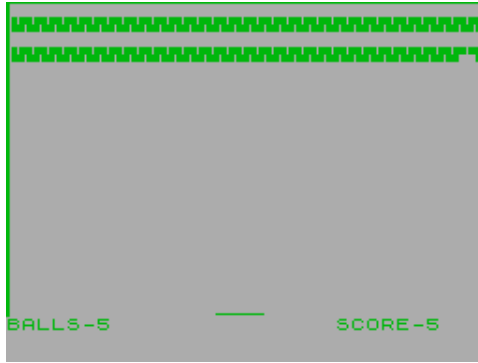

Breakout (Virgin Books,1983)
Arcade

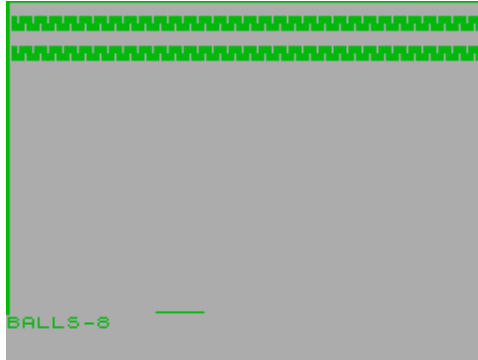

Brian: The Novice Barbarian (Zenobi Software,1994)
Text Adventure



Brian Clough's Football Fortunes (CDS Microsystems,1987)
Simulation

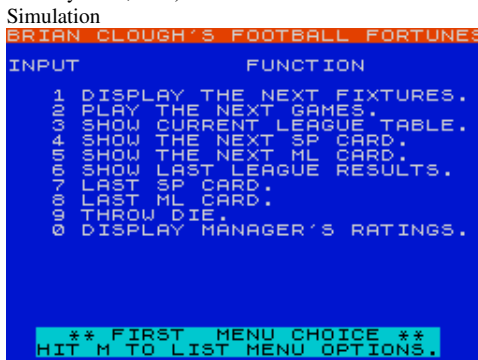

Brick Braker (,)
Arcade



Breakout (C-Tech,1982)
Arcade

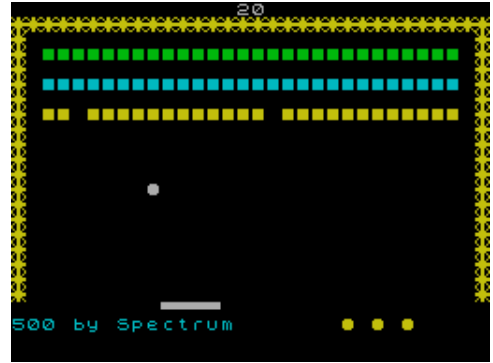

Breakthru (US Gold Ltd,1986)
Strategy



Brian and the Dishonest Politician (Delbert the Hamster Software,1992)
Text Adventure



Brian Jacks Superstar Challenge (Martech Games Ltd,1985)
Sport



Brick Breaker (Dro Soft,1987)
Arcade

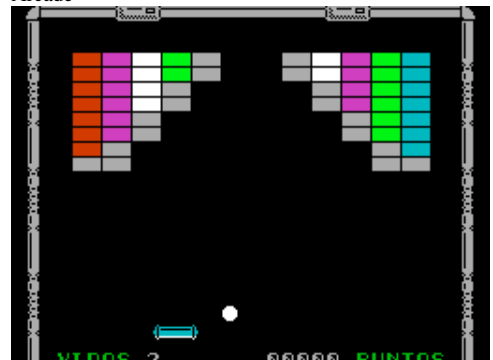

Brick Bucket (Sinclair User,1983)
Arcade

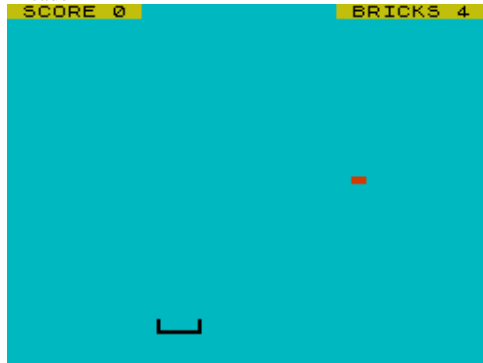

Brick, The (Delta Software,1989)
Arcade

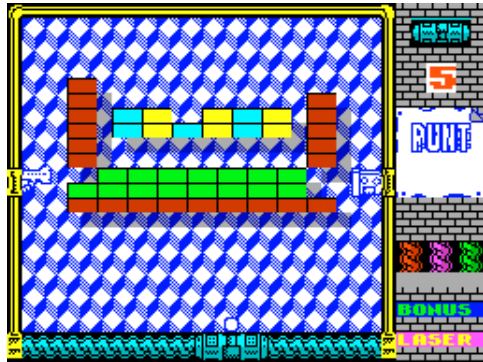

Bride of Frankenstein (39 Steps,1988)
Arcade Adventure



Bridge Player (CP Software,1983)
Board/Card Game

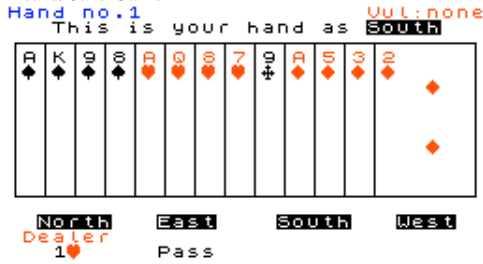

Bridge Player Galactica (CP Software,1989)
Board/Card Game



Bricker (Fontana Publishing,1984)
Arcade

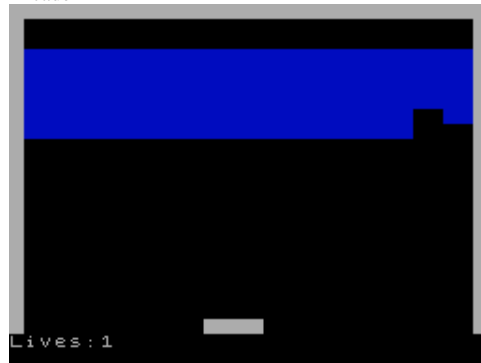

Brick-Yard Bill (ZX Computing,1984)
Arcade

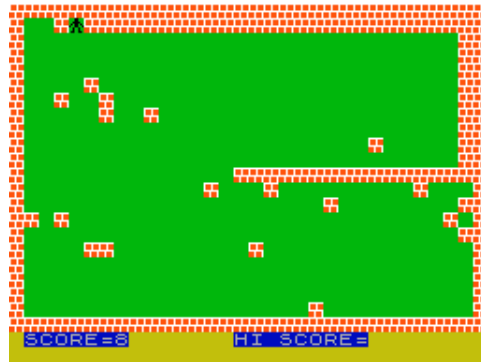

Bridge (ZX Sas,1983)
Board/Card Game



Bridge Player 2 (CP Software,1984)
Board/Card Game



Bridge Tutor Advanced (CP Software,1983)
Board/Card Game

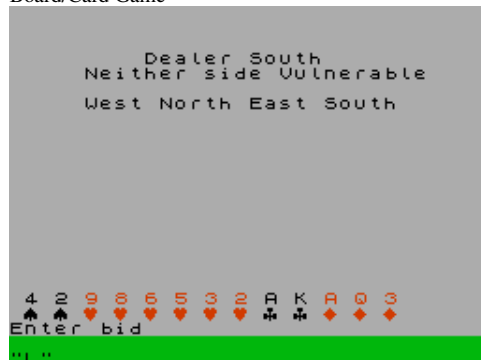

Bricklayer 1 (Pricing Building Works,1984)
Utility

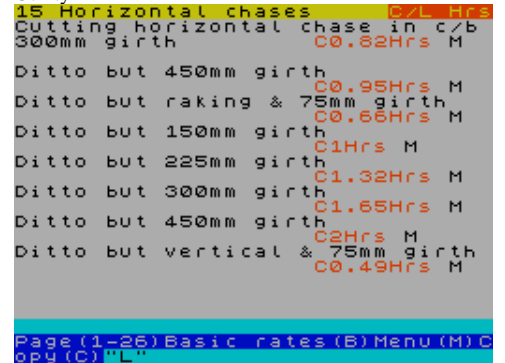

Bricky Micky (Procom Software,1984)
Arcade



Bridge Master (Serin Software,1983)
Board/Card Game

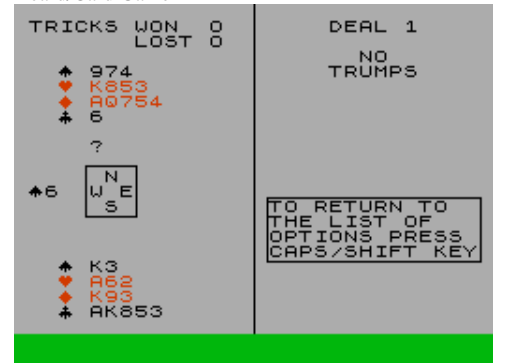

Bridge Player 3 (CP Software,1986)
Board/Card Game

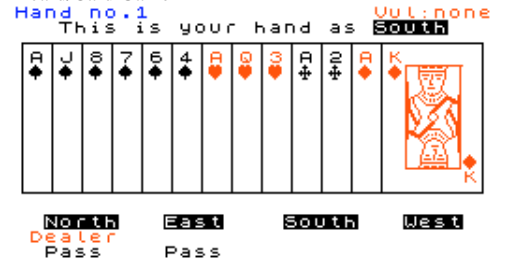

Bridge Tutor Beginners (CP Software,1983)
Board/Card Game

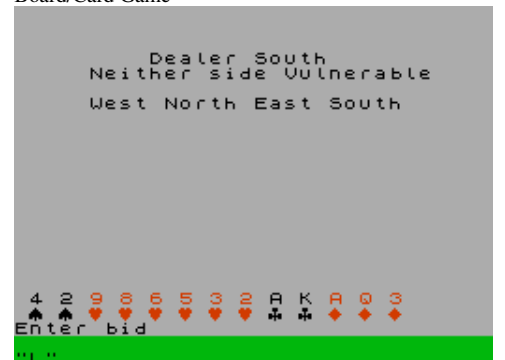

Bright Demo (Big Man/Cat Man,) Scene Demo



Brisca [1] (MicroHobby,1985) Board/Card Game

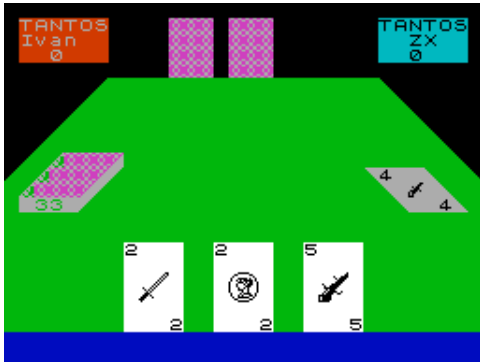

Briscola (.) Board/Card Game

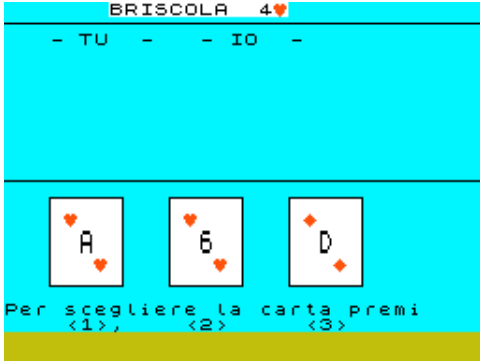

Britain Invaded! (Tk Computerware,1985) Strategy



British Super League (Cult Games,1989) Simulation



Brimardon Formula, The (Brimardon Computer Racing Service,1985) Utility

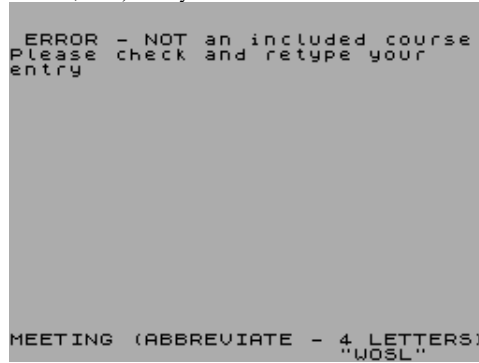

Brisca [2] (MicroHobby,1985) Board/Card Game



Bristles (Statesoft,1984) Arcade

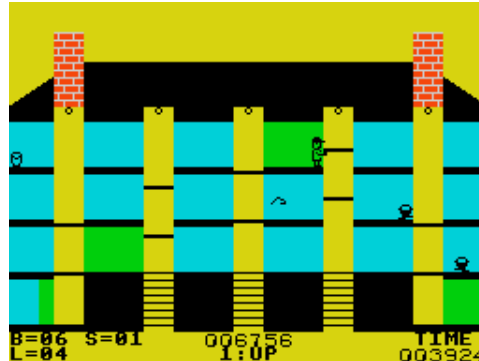

British Battle-Tracker (Technium 220,1996) Scene Demo

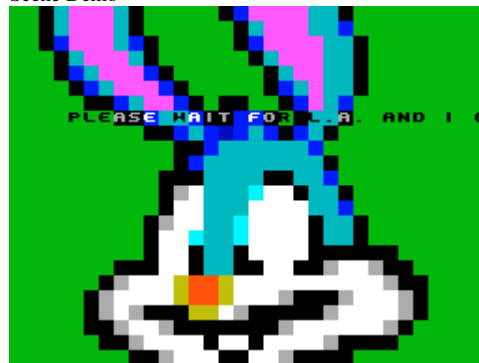

Brix (.) Arcade



Brisca + Cinquillo (Investronica S.A.,) Compilation



Brisca [3] (MicroHobby,1986) Board/Card Game



Bristol Temple Meads Powerbox (Ashley Greenup,1992) Simulation

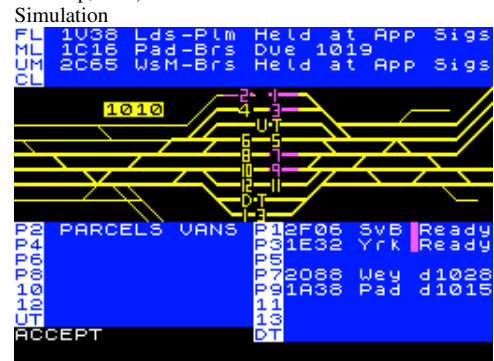

British Lowland (CCS,1983) Strategy

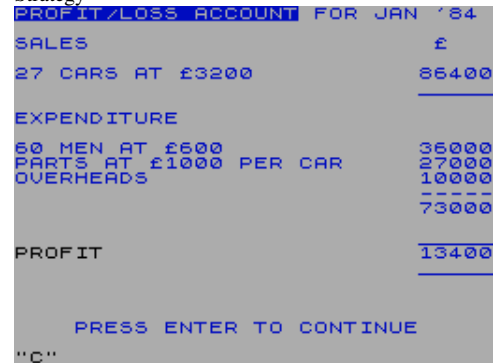

Brojke i Slova (Nikola Alivojvodic,1998) Board/Card Game



Broken Heart (Phantom Family Corp,1997)
Board/Card Game

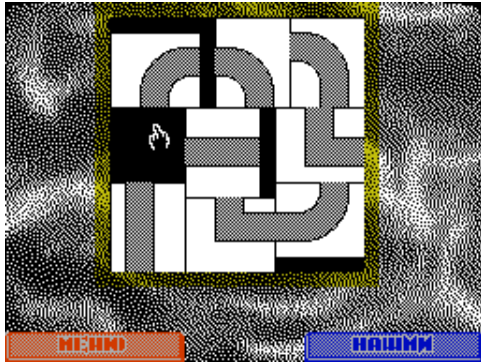

Bronx Street Cop (Virgin Mastertronic Ltd,1989)
Arcade

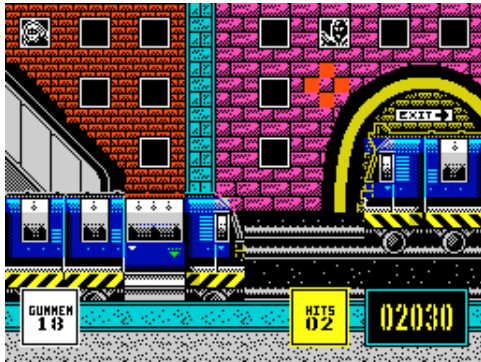

Bruce Lee (US Gold Ltd,1984)
Arcade



Brum-Brum (Astor Software,1984)
Simulation



BS Copy (Busy Software,1988)



Broke Out (CIR,1990)
Arcade

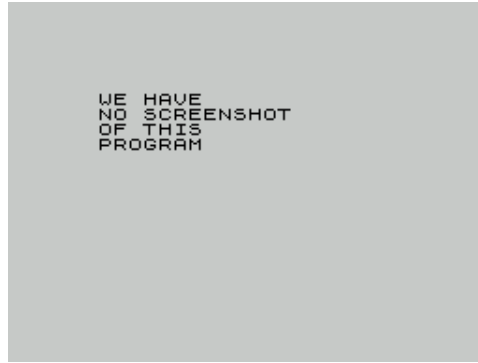

Broodslayer (CCS,1984)
Arcade Adventure



Bruce Tulloh's Marathon Training Program (Earlgate Computers,1983) Simulation

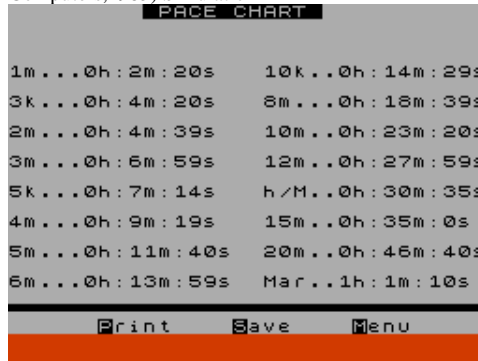

Brutal Worms (NOP,1994)
Arcade

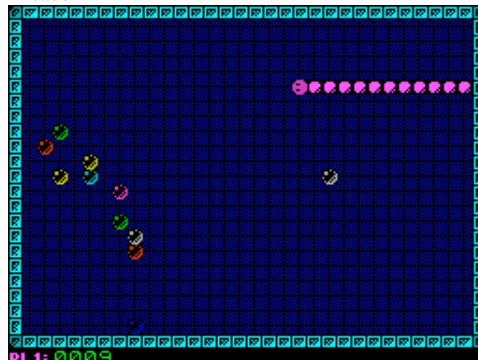

BS Copy (Will,1991)

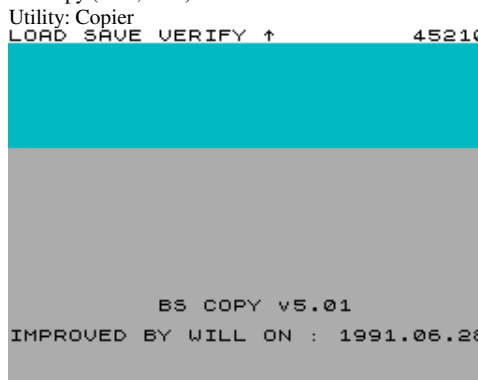

Bronx (Animagic S.A.,1990)
Arcade



Brook the Barbarian (Richard Silfverberg,1986)
Text Adventure

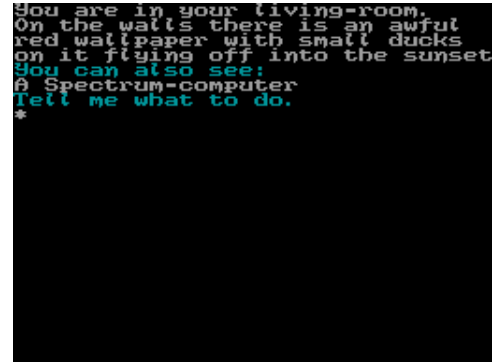

Bruchrechnen-Training (,) Educational

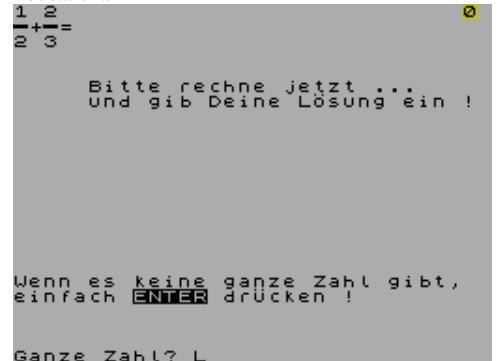

Bryan Robson's Super League (Paul Lamond,1985)
Simulation



BS Mix (Busy Software,1988)

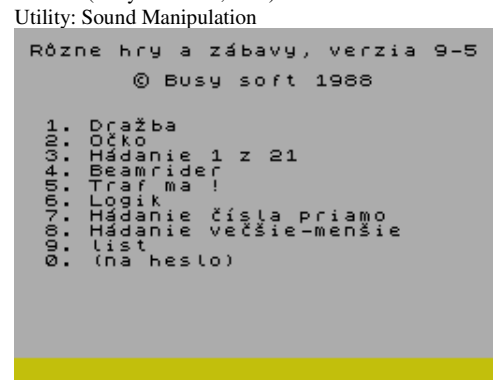

BS Speedyload (Busy Software,1988)

Utility: Copier

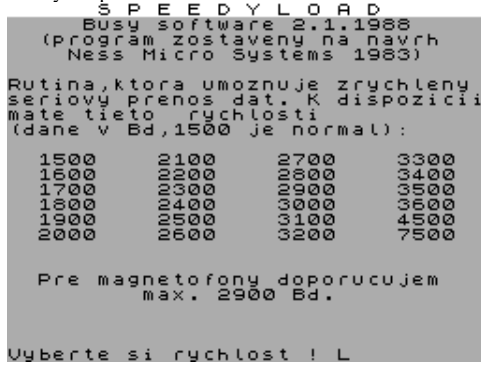

Bubble Bobble (Firebird Software Ltd,1987)

Arcade

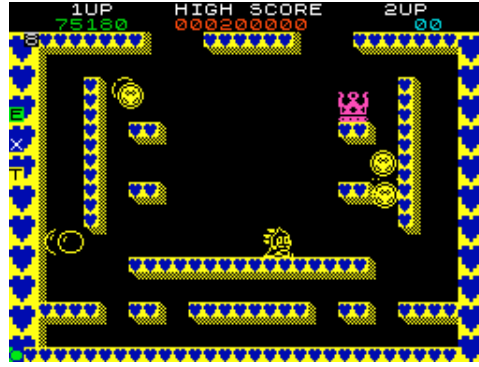

Bubble Bobble - The Adventure (AP's Adventures,1993)

Text Adventure

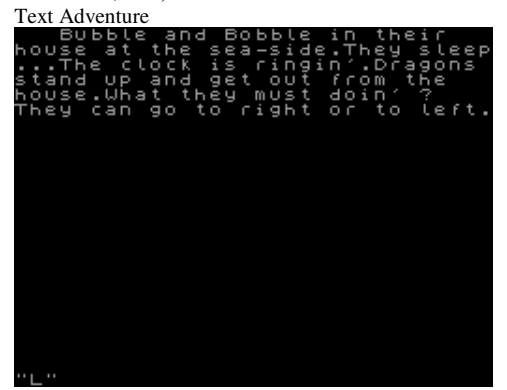

Bubble Buster (Sinclair Research Ltd,1983)

Arcade

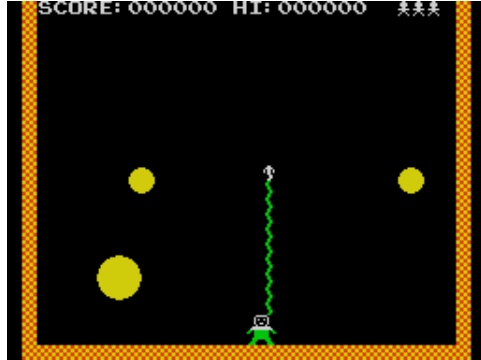

Bubble Demo (Jacek Michalak,1990)

Scene Demo



Bubble Dizzy (Code Masters Ltd,1991)

Arcade



Bubbler (Ultimate Play The Game,1987)

Arcade



Bubble Run (Tynesoft,1986)

Arcade



Bubble Sort (Keith Norton,1986)

Utility



Bubblesort (Sinclair Research Ltd,1982)

Educational



Bubble Trouble (Arcade Software,1982)

Arcade

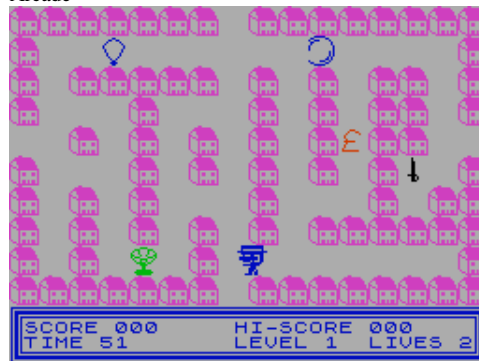

Bubble Trouble (Your Sinclair,1986)

Arcade



Buccaneer (Firebird Software Ltd,1985)

Arcade



Buccaneers (Mar Entertainment,)

Arcade



Buckaroo Banzai (Adventure International,1987)

Text Adventure

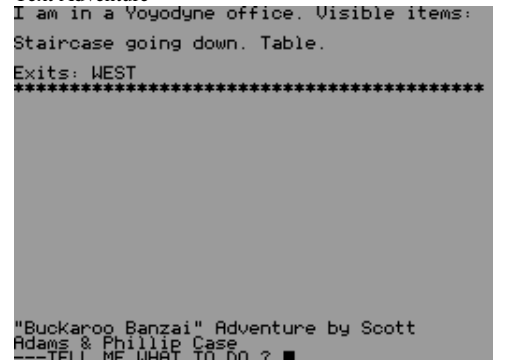

Buck Rogers: Planet of Zoom (US Gold Ltd,1985)
Arcade



Buergermeister (Dieter Asbrock,1984)
Simulation

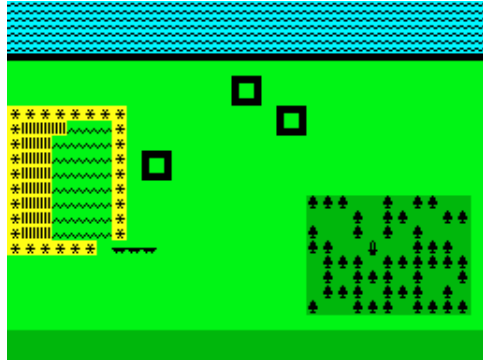

Bug (Secundus,1992)
Arcade



Bug Eyes (.)
Arcade

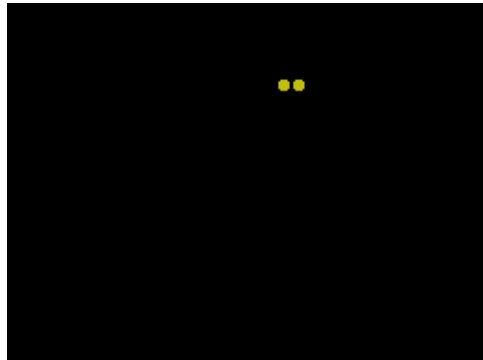

Buggy Blast (Firebird Software Ltd,1985)
Arcade



Budget Account (.)
Utility

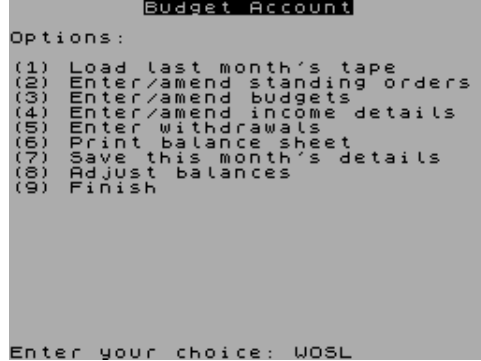

Buffalo Bill's Wild West Show (Tynesoft,1989)
Arcade



Bug Blaster (Crystal Computing,1984)
Arcade



Bug-Eyes (Icon Software Ltd,1985)
Arcade

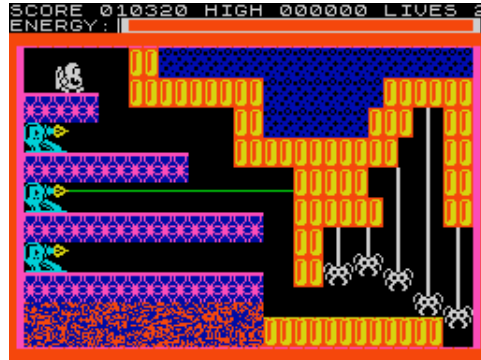

Buggy Boy (Elite Systems Ltd,1988)
Arcade



Budokan: The Martial Spirit (Dro Soft,1991)
Arcade



Buffer Adventure (Buffer Micro Ltd,1984)
Text Adventure



Buget Manager (Phipps Associates,1982)
Utility: Spreadsheet

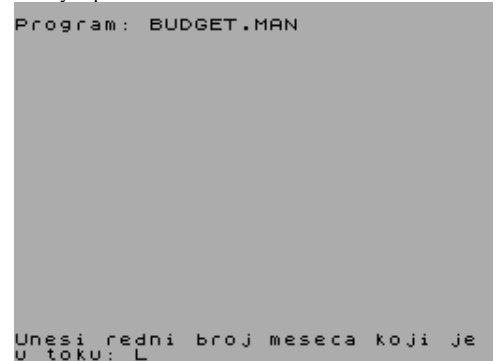

Buggy (unpublished,1983)
Arcade



Buggy Ranger (Dinamic Software,1991)
Arcade



Bugout (Turtle Software,1985)
Arcade

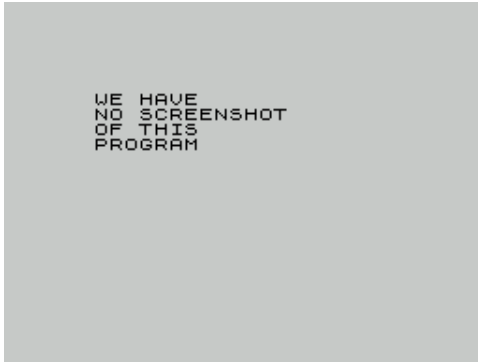

Bugs Bunny (.)
Arcade



Build a City (Aqua Soft,1983)
Arcade

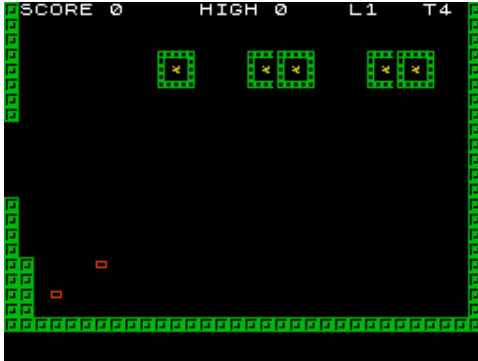

Bulbo and the Lizard-King (Zenobi Software,1987)
Text Adventure

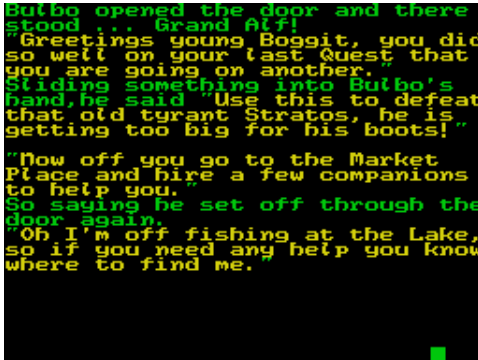

Bullion Raider (16/48 Tape Magazine,1985)
Arcade

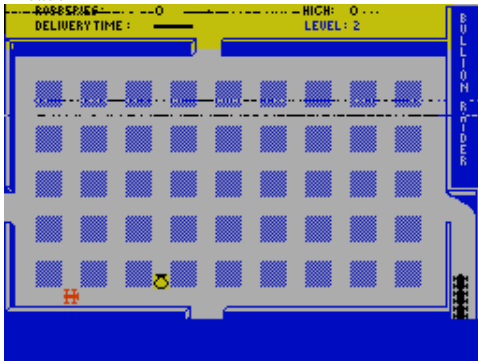

Bug Race (Airline Software,1989)
Arcade



Bugsy (CRL Group PLC,1986)
Text Adventure

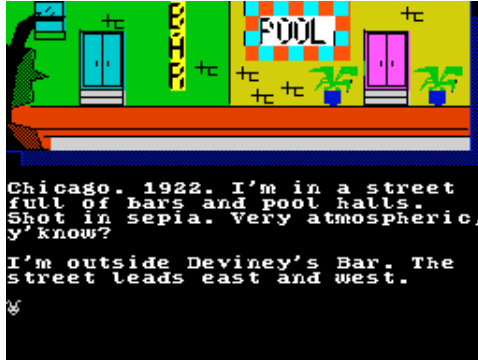

Builder (Sinclair Programs,1984)
Arcade



Bulge, The (MC Lothlorien Ltd,1985)
Strategy



Bull Run (Phipps Associates,1984)
Arcade

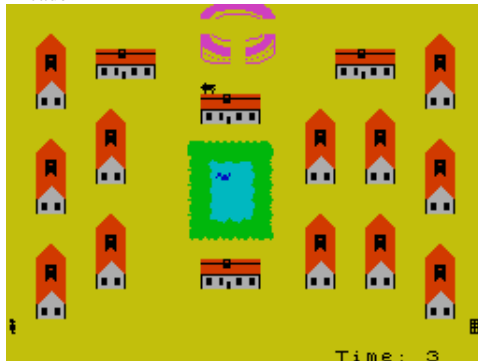

Bug Run (Home Computing Weekly,1984)
Arcade

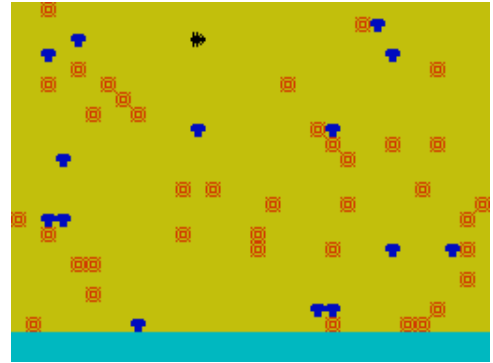

Buho, El (MicroHobby,1985)
Arcade



Builder, The (Unique,1984)
Simulation



Bulldog (Gremlin Graphics Software Ltd.)
Arcade



Bulls and Bears (Sinclair User,1985)
Strategy

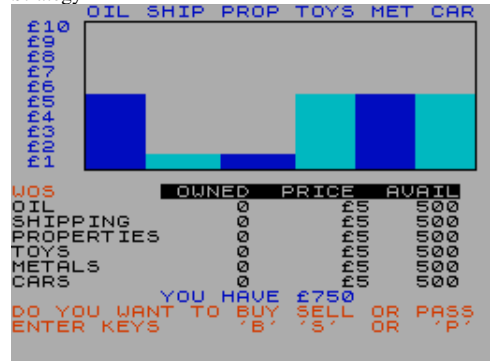

Bulls and Bears (The Stock Exchange,1986)
Strategy



Bulls-Cows (WIN,1987)
Arcade

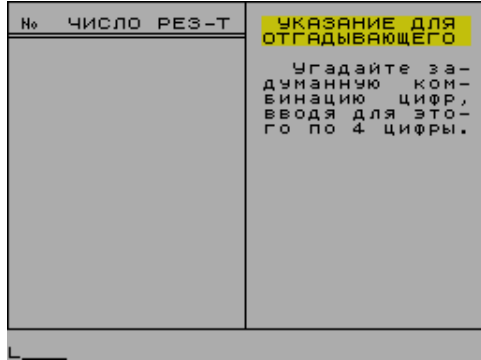

Bully Embassy (Robert Frostdick,)
Arcade

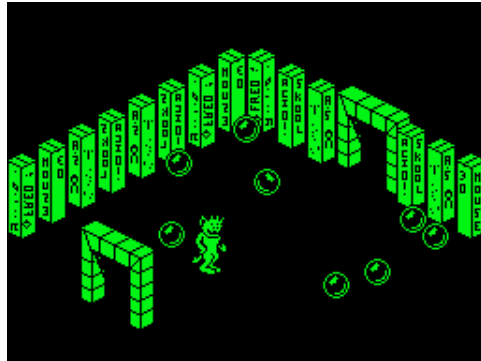

Bumper Pack (Woolworths,)
Compilation



Bunch of Arse (Icabod,1999)
Scene Demo



Bulls and Cows (Spectrum Computing,1985)
Board/Card Game

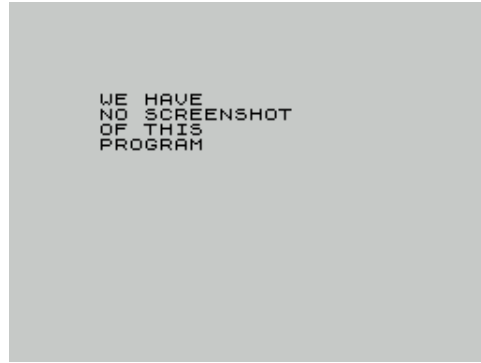

Bulls Eye (Macsen Software,1984)
Sport



Bully's Sporting Darts (Alternative Software Ltd,1992)
Sport

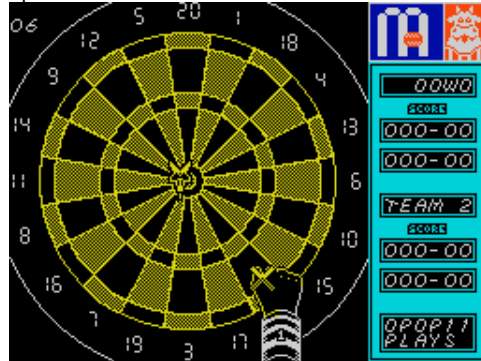

Bump, Set, Spike! (Entertainment USA,1986)
Arcade

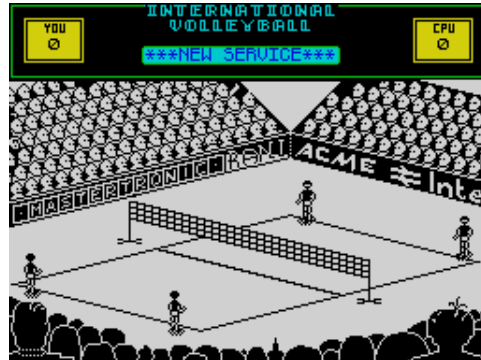

Bundesliga (Chip-Special,)
Simulation

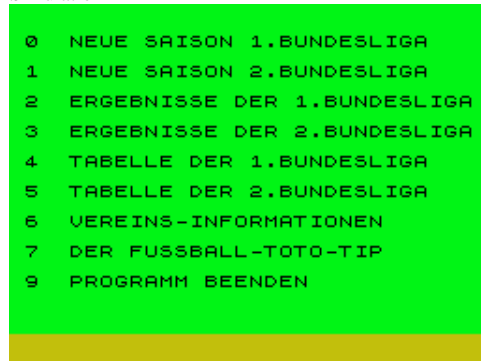

Bulls and Cows (Virt Group,1995)
Board/Card Game

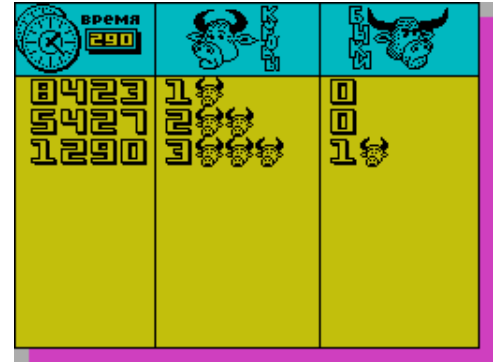

Bull Tables (Lotus-Soft,1984)
Educational



Bumper Boogie Pack (Jonathan Cauldwell,1993)
Compilation



Bumpy (Loriciels,1989)
Arcade



Bundeswehr Nein Danke (A. Henrich,1986)
Text Adventure



Bungo's Quest For Gold (Gary Stimson,1987)
Text Adventure

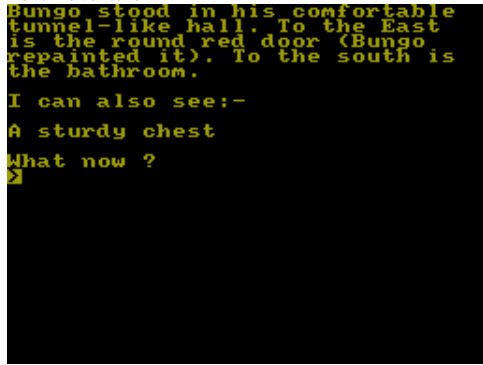

Bunker Swamp (Green Fish Software Enterprise,1985)
Text Adventure

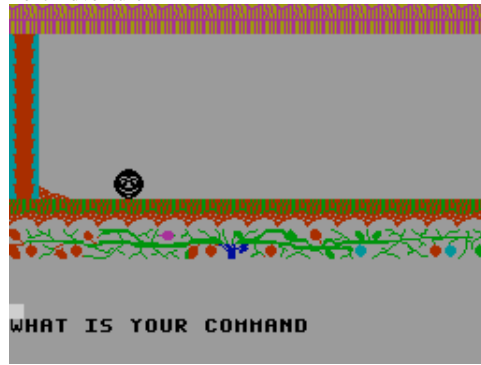

Bunny (Automata UK Ltd,1983)
Arcade

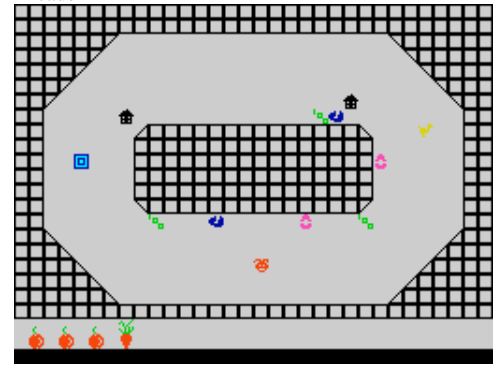

Bunny + ETa (Automata UK Ltd,1983)
Compilation

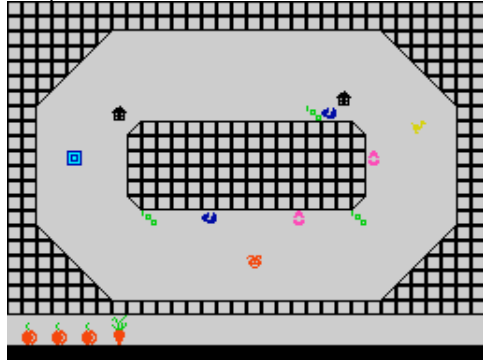

Bura (Hokus Pokes Megademo) (Flash Inc.)
Scene Demo



Buran (OMK Software S.L.,1990)
Arcade

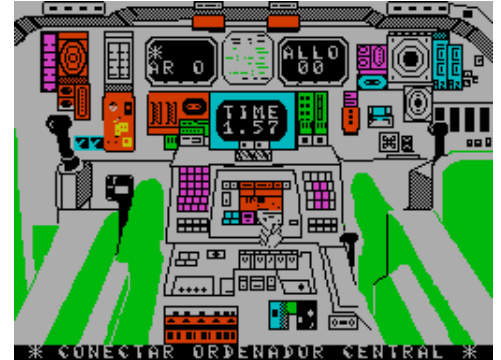

Burdenome Dream (K3L Corp,1997)
Scene Demo

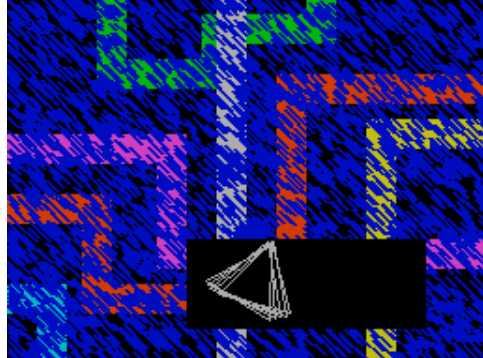

Burger Attack (Xenon Software,1984)
Arcade



Burger Bar (Sinclair Programs,1984)
Arcade

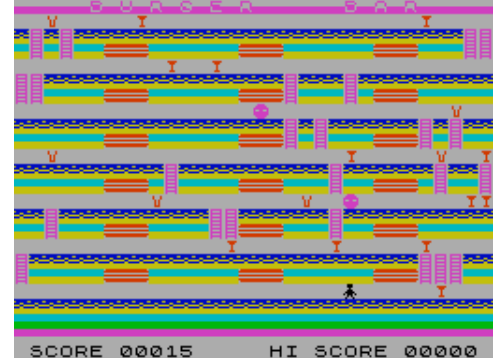

Burger Time (ALEAssoft,2003)
Arcade

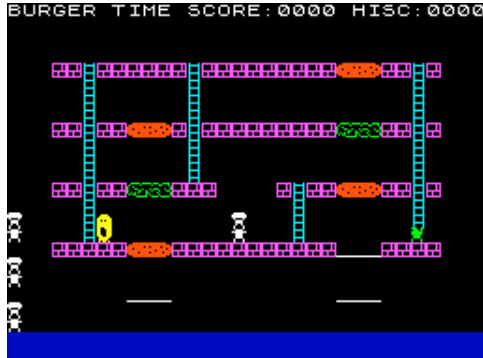

Buriabeast (Kerian UK Ltd,1984)
Strategy

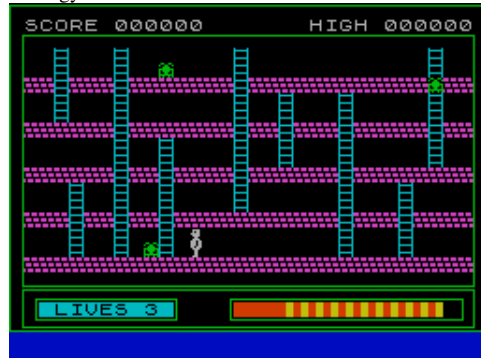

Burladero (MicroHobby,1986)
Educational



Burning Rubber (CRL Group PLC,1990)
Compilation



Buscapar (MicroHobby,1985)
Arcade



Bushido Warrior (Reaktor,1988)
Arcade

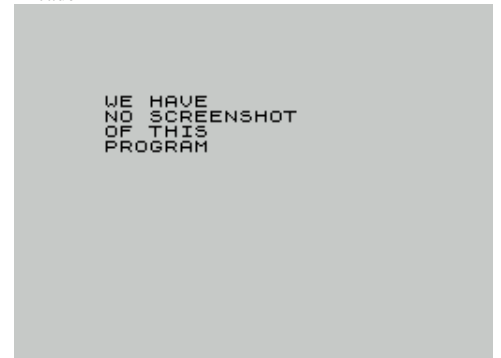

Business (Max Hueber Verlag,1984)

Educational

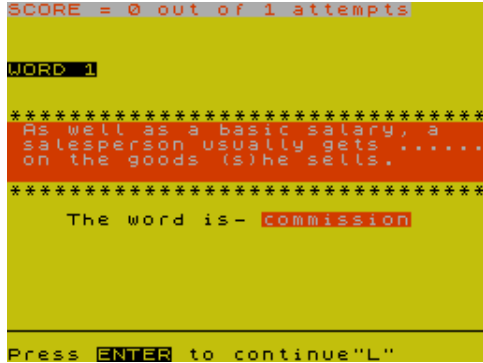

Busqueda en la Mina Maldita (Ventamatic,1983)

Arcade



Busyman (,1985)

Utility: Spreadsheet

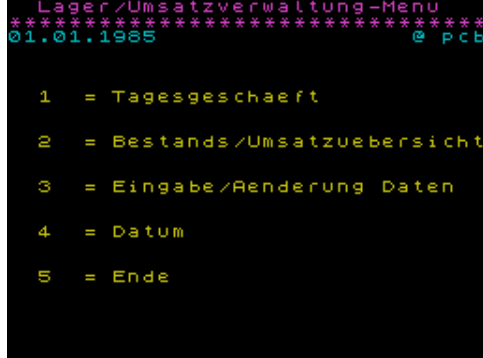

Butterfly (Pulsonic,1984)

Arcade

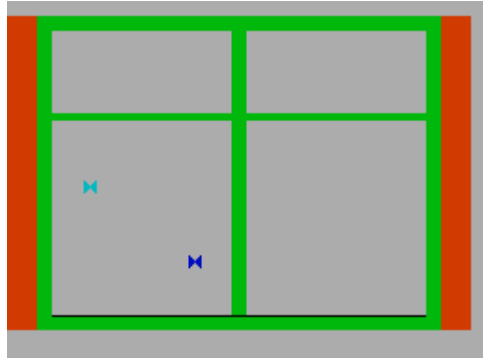

Buzz Off! (Electric Software,1984)

Arcade

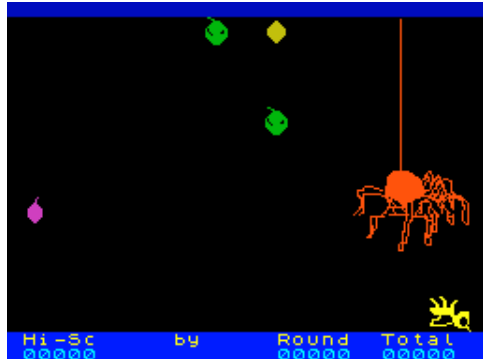

Business Cartridge (Sinclair Research Ltd,1983)

Compilation

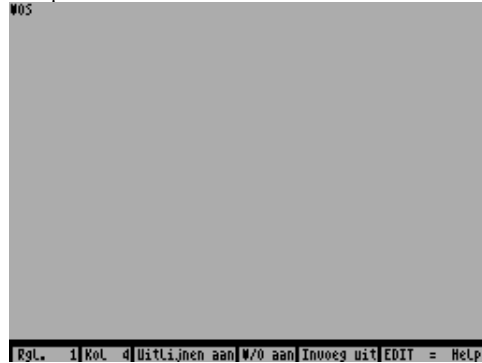

Bustout (Amstrad,1986)

Arcade

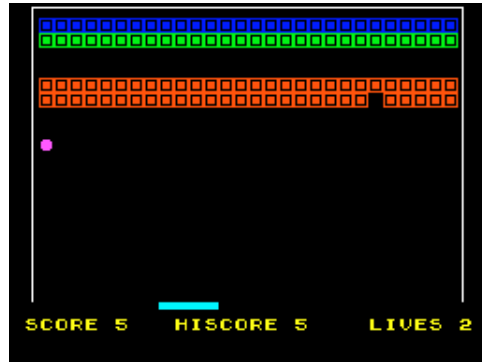

Butcher Hill (Gremlin Graphics Software Ltd,1988)

Arcade



Buying and Selling (AVP Computing,1986)

Educational



Bye Bye (Mr. Incognito,1996)

Scene Demo

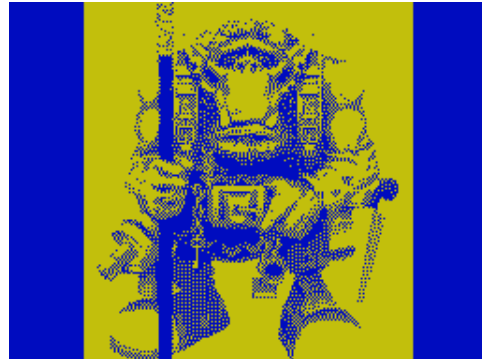

Business Pack (Transform Ltd,1985)

Compilation



Busygraph (,)

Utility: Spreadsheet



Butch - Hard Guy (Advance Software Ltd,1987)

Arcade

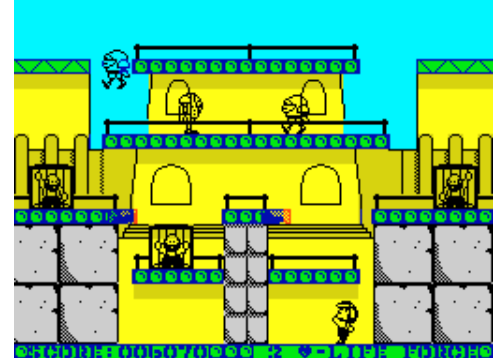

Buzo, El (MicroHobby,1985)

Arcade



By Fair Means...or Foul (Superior Software Ltd,1989)

Arcade



By Right of Birth (Adventure Probe Software,2002)
Text Adventure

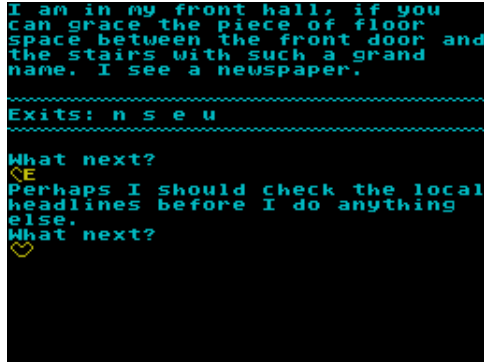

Byte, The (CCS,1983)
Text Adventure

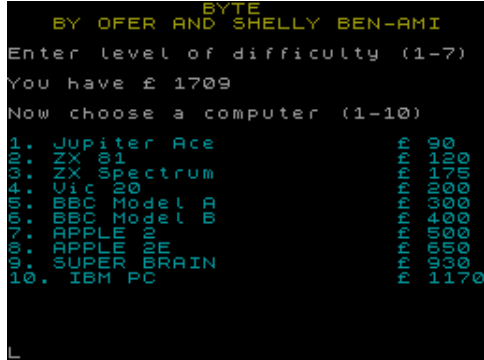

C5 Clive (Scorpio Gamesworld,1985)
Arcade



Cactuar Racing (XFAWORLD Software,2001)
Simulation

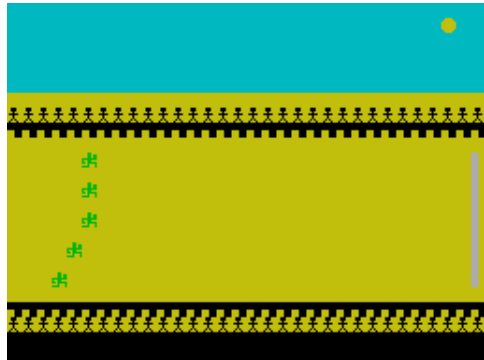

CAD - Computer Aided Designer (Dream Software Ltd,1984)
Utility



Byte Bitten (Firebird Software Ltd,1984)
Arcade

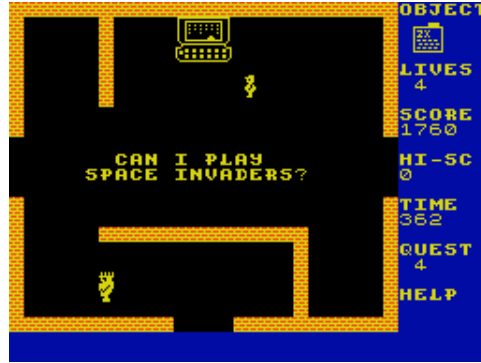

C (GCE Tutoring,1984)
Educational



Cabal (Ocean Software Ltd,1988)
Arcade



Cactuar Racing 3 (XFAWORLD Software,2003)
Simulation



CAD-Master Light Pen (Trojan Products,1985)
Utility: Screen Manipulation



Byte Me! (Icabod,2007)
Scene Demo



C5 Challenge (Sinclair User,1985)
Arcade



Cabman (Micro Power Ltd,1983)
Arcade

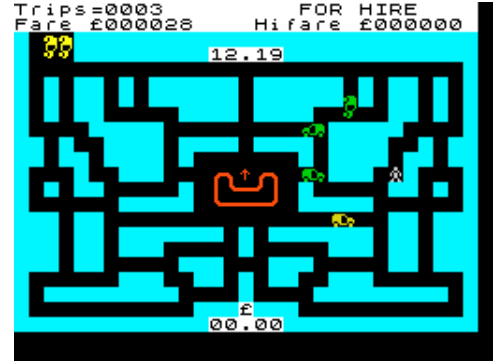

Cactuar Racing Extreme (XFAWORLD Software,2001)
Simulation

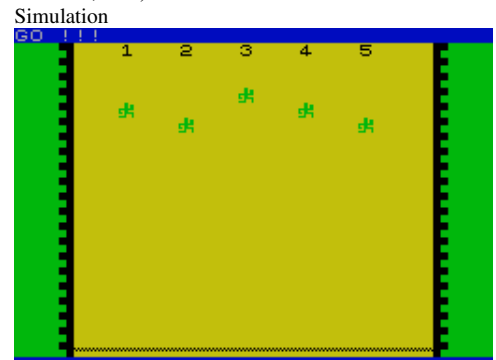

Caesar's Travels (Mirrorsoft Ltd,1985)
Arcade



Caesar the Cat (Mirrorsoft Ltd,1984)
Arcade



Cage Match (Entertainment USA,1988)



Caja Magica, La (System 4.)
Compilation



Calculadora por Interrupciones (MicroHobby,1985)
Utility



Calculo de Vigas (Belltons Informatica,1983)

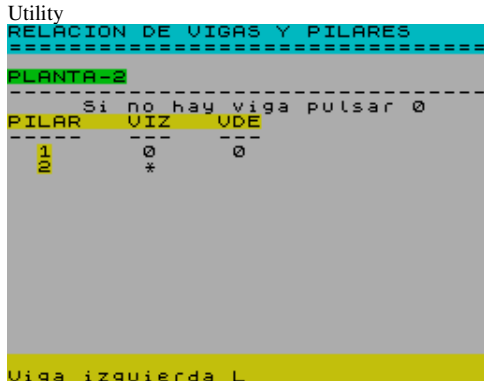

Viga izquierda L

Cagara (Players Software,1986)
Arcade



Caja Fuerte, La (Aitor Gomez Garcia,2006)
Board/Card Game

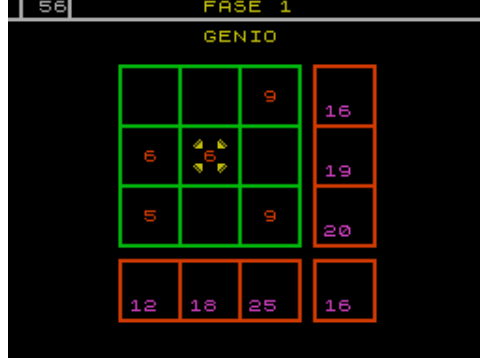

Cajas de Sol, Las (System 4.)
Compilation



Calculator (Ediciones y Textos S.A.,1985)
Utility: Mathematics



Caleidoscopio (MicroHobby,1985)



CAGD (Omikron Software [1],1986)
Utility: Drawing



Caja Fuerte, La (MicroHobby,1985)
Arcade



Calculadora (MicroHobby,1985)
Arcade



Calculo de Porticos (Belltons Informatica,1983)
Utility

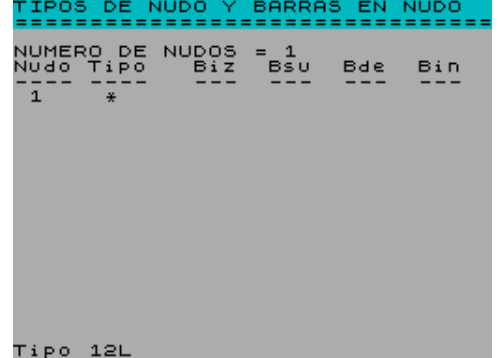

Tipo 12L
Caleidoscopio (Stars,1984)

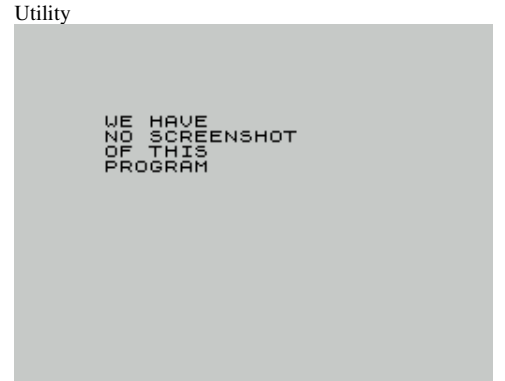

Calendario Perpetuo (MicroHobby,1985)
Utility

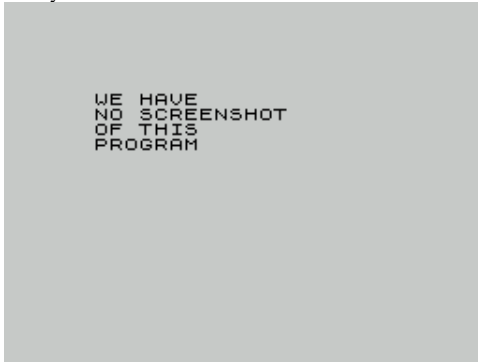

Calling, The (Visual Dimensions,1987)
Text Adventure



Calpac Learning Series Volume 1 (Calpac Educational Software,1983) Compilation



Camara Secreta (Monser S.A.,1985)
Arcade



Camelot (CCS,1983)
Text Adventure

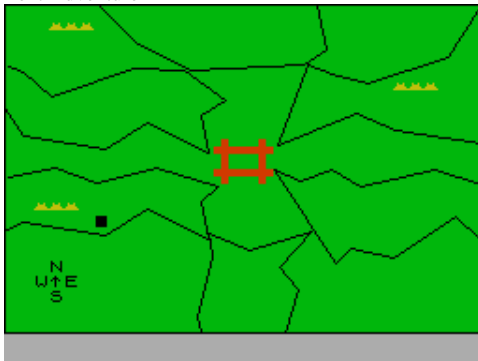

California Games (US Gold Ltd,1987)
Sport

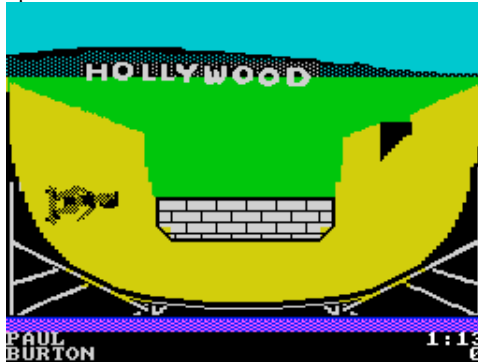

Call Me Psycho (Pirate Software Ltd,1987)
Arcade



Calpac Learning Series Volume 2 (Calpac Educational Software,1983) Compilation



Cambridge Colour Collection, The (Richard Francis Altwasser,1982) Compilation



Camelot Warriors (Dinamic Software,1986)
Arcade



Calipse (.)
Arcade

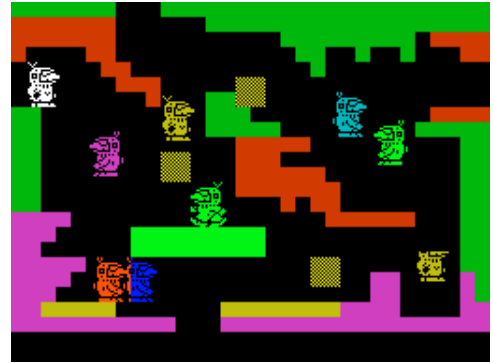

Calorie Controller (SD Micro Systems,1984)
Utility



Calpac Learning Series Volume 3 (Calpac Educational Software,1983) Compilation



Cambridge Intelligent Joystick (Cambridge Computing Research,1983) Utility

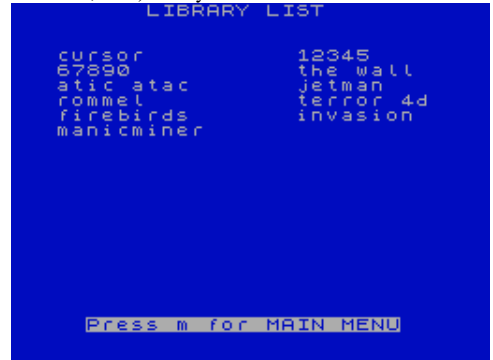

Camionero, El (MicroHobby,1985)
Arcade

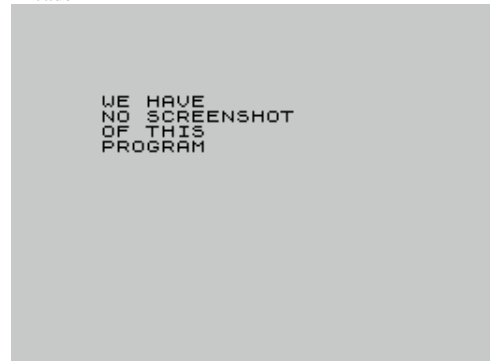

Cammac One (Micro Zeighty,1986)
Utility: Programming



Campos de Energia (MicroHobby,1985)
Arcade



Canibales (MicroHobby,1986)
Arcade



Cannon Ball (Hudson Soft,1983)
Arcade

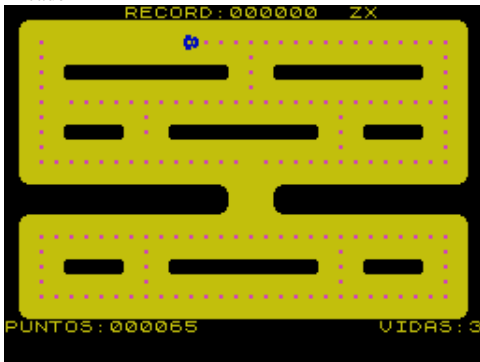

Canyon Warrior (Mastertronic Plus,1989)
Arcade



Campion the Spreadsheet (Campion Software,1991)
Utility: Spreadsheet



Canasto Rebellion, The (Trevor Taylor,1988)
Text Adventure

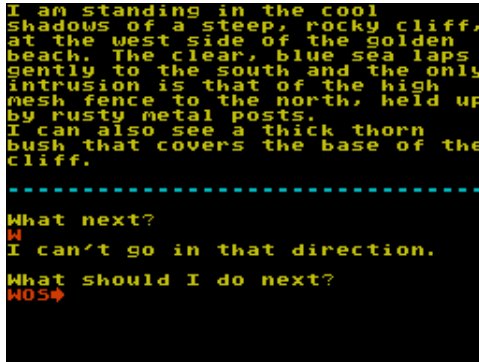

Cannibal Island (Live-Wire Software,1986)
Arcade



Cannonball (MicroHobby,1985)
Arcade

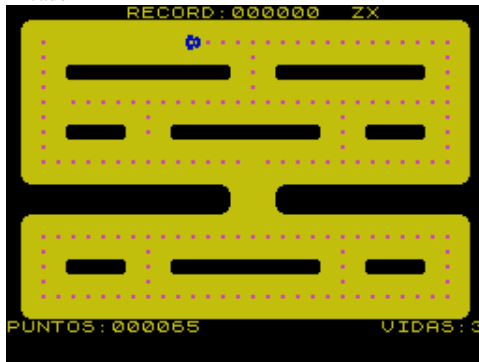

Caos de Historia (MicroHobby,1986)
Simulation



Campo de Minas + Speakeasy (Investronica S.A.,1983)
Compilation



Candy Girl (.)
Scene Demo



Cannibals (Alternative Software Ltd,1987)
Arcade Adventure



Cannon Bubble (Computer Emuzone,2007)
Arcade

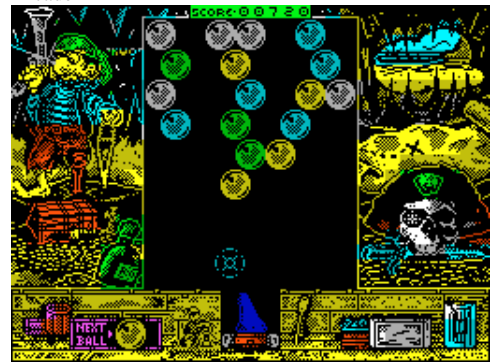

Capa (Laszlo Nyitrai,1998)
Arcade



Capcom Collection (US Gold Ltd,1991)
Compilation



Capitals (Chalksoft Ltd,1984)
Educational



Capman (Your Computer,1983)
Arcade



Captain Blood (Exxos,1988)
Arcade

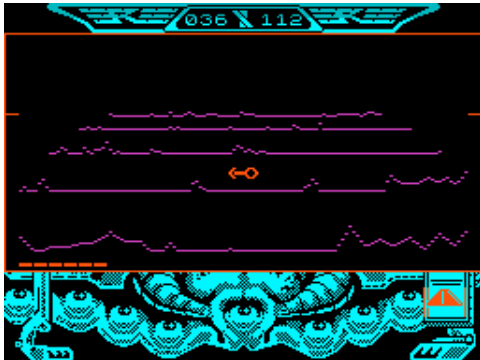

Captain Kelly (Quicksilva Ltd,1986)
Arcade



Capitales del Mundo (ABC Soft,)
Educational



Capitan Sevilla (Dinamic Software,1988)
Arcade Adventure



Capricornio 2 (Load 'n' Run [Ita],1985)
Arcade

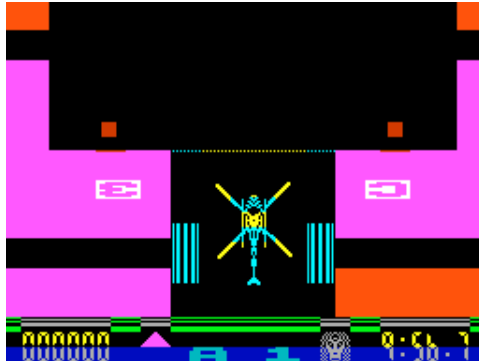

Captain Dynamo (Code Masters Ltd,1992)
Arcade



Captain Kook (Essential Myth,1989)
Text Adventure

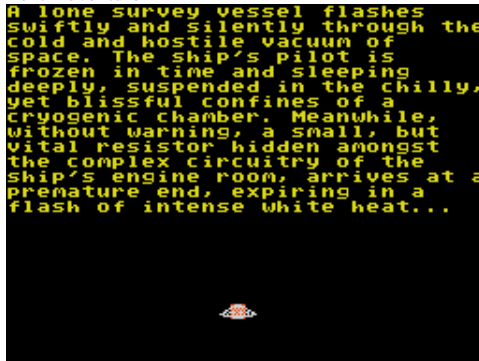

Capital Letters (Sinclair Research Ltd,1983)
Educational



Capitan Trueno (Dinamic Software,1989)
Arcade



Captain America (Go!,1988)
Arcade



Captain Fizz (Psyclipse,1989)
Arcade

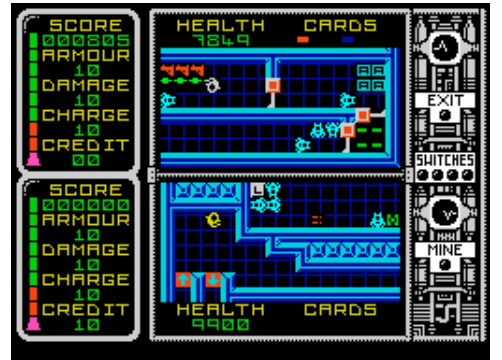

Captain Planet (Mindscape International Inc,1991)
Arcade



Captain Poke's Music Sampler (Sinclair User,1991)
Utility: Sound Manipulation

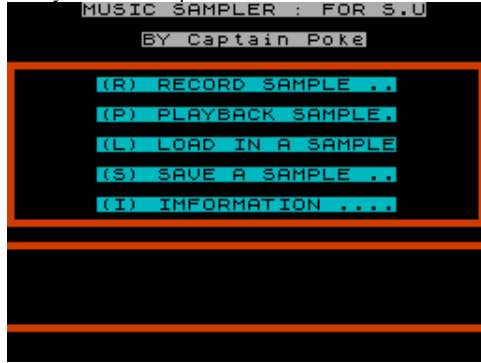

Capture the Quark (Granada Publishing,1983)
Arcade

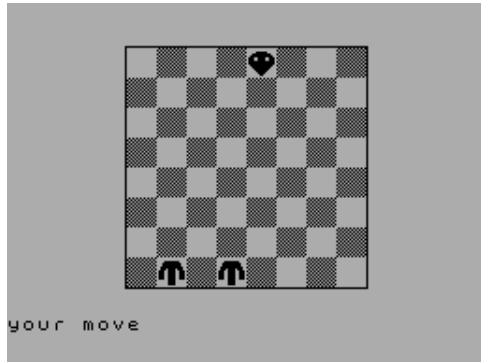

Caramelos + Batalla Naval (Investronica S.A.)
Compilation



Card Games (Buffer Micro Ltd,1984)
Board/Card Game



Cards of Fate (D.C. Jackson,1985)
Board/Card Game



Captain Pytron (Sinclair User,1990)
Arcade



Caracteres (MicroHobby,1986)
Utility: Font/UDGs



Car Chase (Simon Micro-Soft,1982)
Arcade

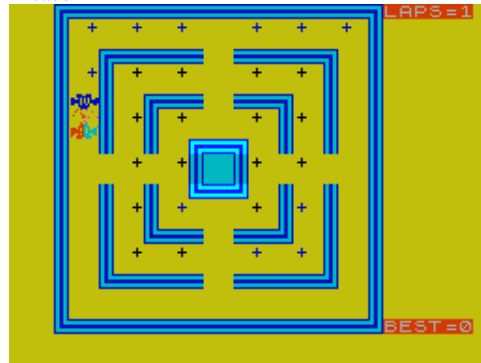

Cards (.)
Board/Card Game

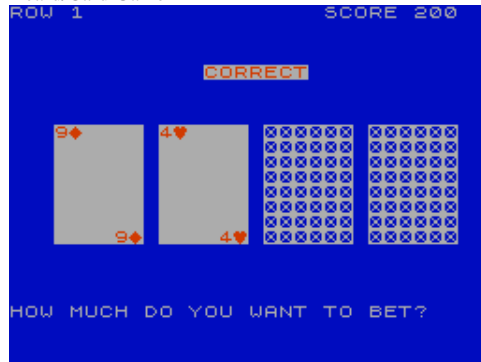

Card's Show (Judesoftware,1988)
Board/Card Game

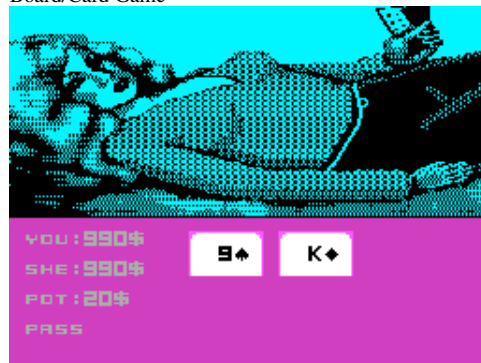

Captain Slog (Alpha-Omega Software,1986)
Arcade



Caramelos (Investronica S.A.,1984)
Board/Card Game



Car Cure (Simtron,1985)
Utility

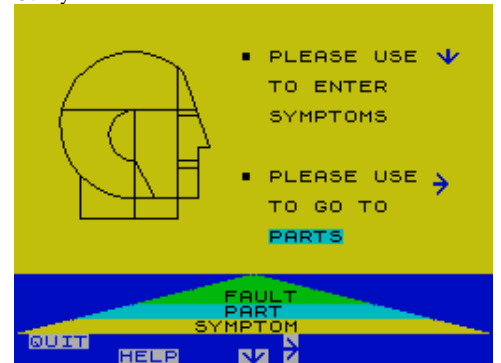

Cards (16/48 Tape Magazine,1984)
Board/Card Game



Carga de Velocidad Variable (MicroHobby,1986)
Utility



Cargador (MicroHobby,1985)
Utility: Assembler/Disassembler/Monitor

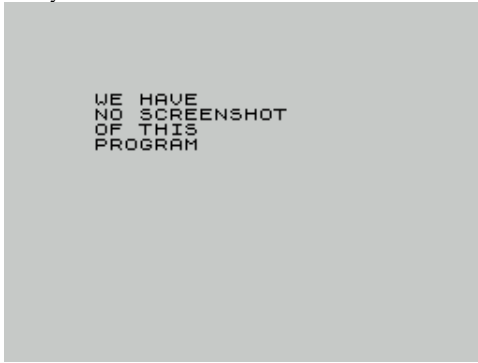

Cargador Universal de Codigo Maquina (C.U.C.M.) (MicroHobby,1986) Utility



Caribe (Alien Software,1994)
Text Adventure



Carlos Sainz (Zigurat Software,1991)
Arcade



Carnevale (Gamesoft [2],1985)
Arcade



Cargador Rutinas (MicroHobby,1985)
Utility: Assembler/Disassembler/Monitor

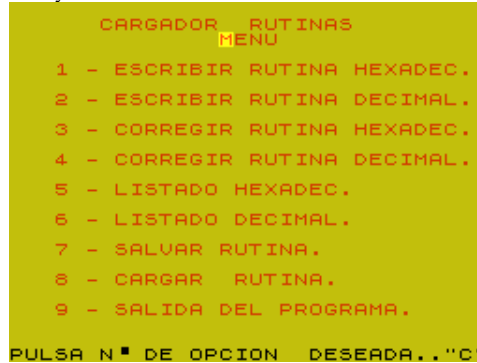

Cargo (Macmillan Software Ltd/Sinclair Research Ltd,1985)
Simulation

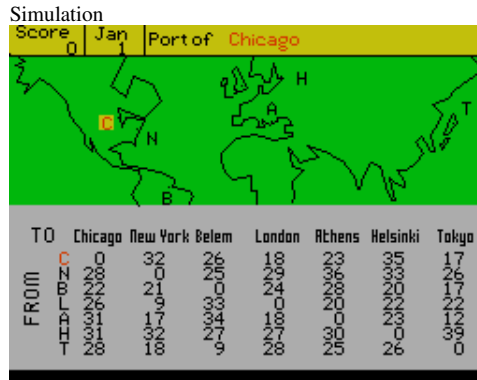

Car Journey (Heinemann/Hill MacGibbon,1983)
Simulation

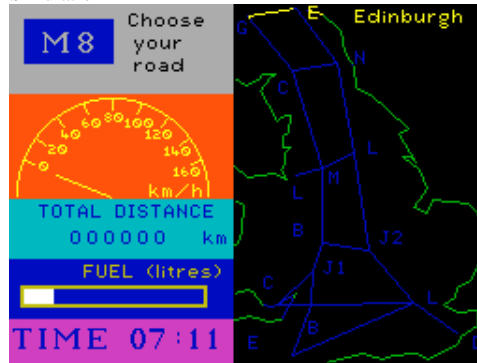

Carl Young's Adventure (.)
Text Adventure

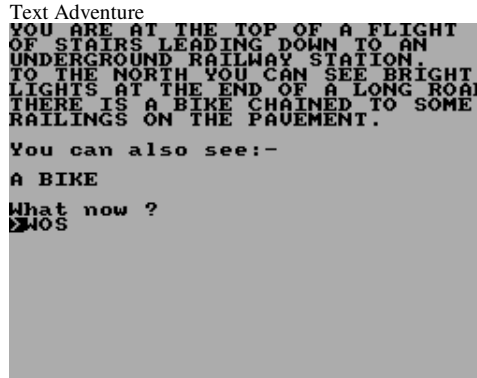

Carnival (Eclipse Software,1984)
Arcade



Cargador Universal de Codigo Maquina +3 (MicroHobby,1990)
Utility



Caribbean Trader (East Midland Software,1983)
Strategy



Carlisle Powerbox (Ashley Greenup,1990)
Simulation

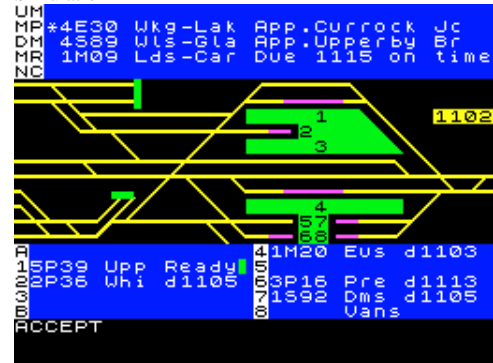

Carmania (Video Software Ltd,1984)
Arcade

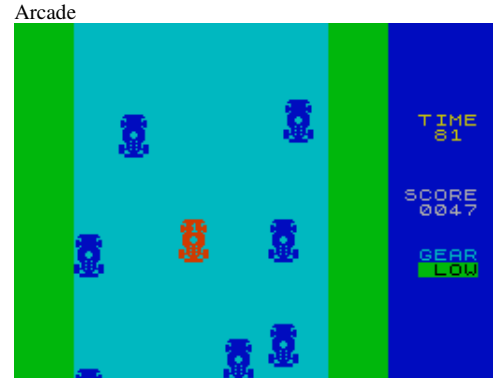

Carols (R.D. Foord Software,1986)
Music



Carpet Capers (Terminal Software,1984)



Carrier Command (Rainbird Software Ltd,1989)

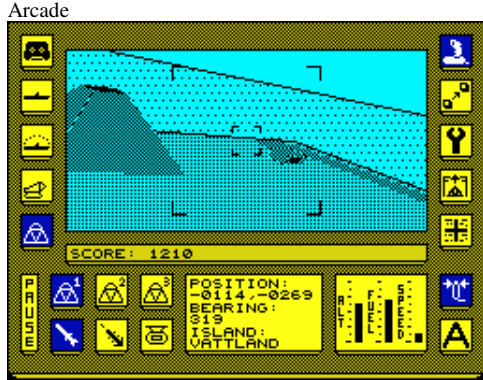

Car-Slide-Race (Supersoft [3]/Prospek Computing Cooperation,1983) Arcade

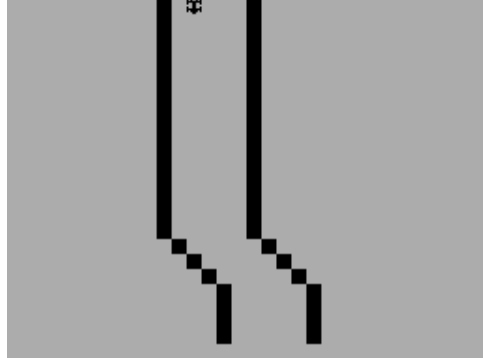

Cartoon Capers (Alternative Software Ltd,1988) Compilation

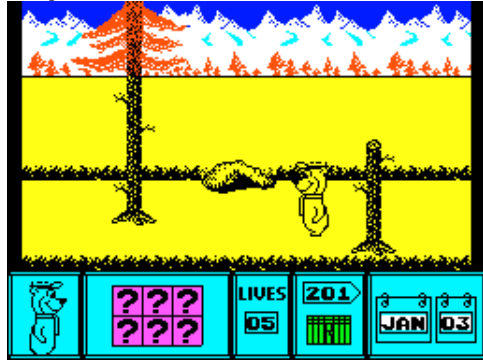

Cartoon Demo (The Unbelievables,1995) Scene Demo

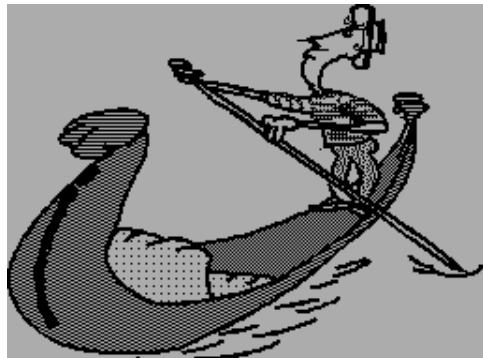

Car Race (Wintersoft,1983)



Carriers at Midway (Specsim,1985)



Cars Out! (Defun Projects,2004) Arcade

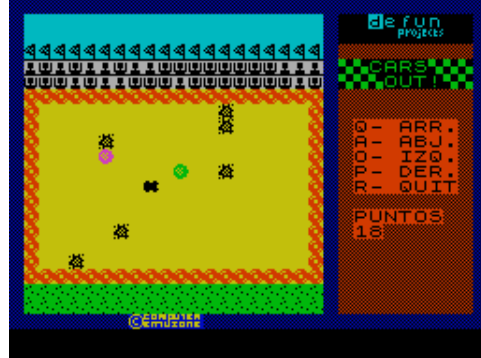

Cartoon Character Collection (Hi-Tec Software Ltd,1992) Compilation



Cartridge Header (.) Utility

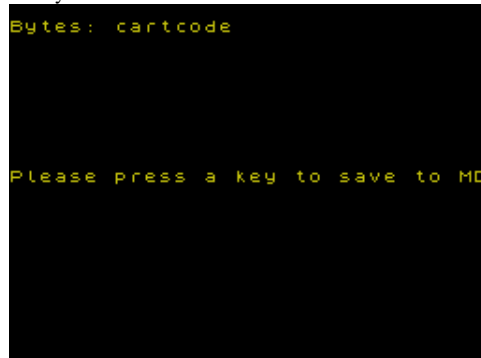

Carrera Mortal (Microparadise Software,1984)



Car Seating Arrangement Designer (JA Software,1991) Utility



Cartoon Animation (Fowler Software,1984) Utility



Cartoon Collection (Code Masters Ltd,1992) Compilation



Casa Encantada, La (Editorial Plesa.) Text Adventure

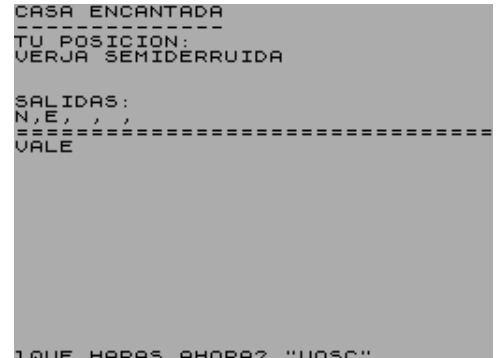

Casanova (Iber Software,1988)
Arcade Adventure

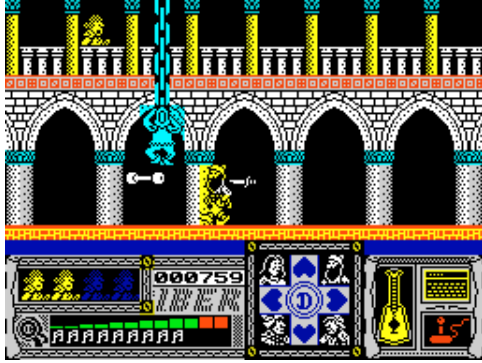

Case of the Mixed-Up Shymer, The (Atlas Adventure Software,1987) Text Adventure

THE CASE OF THE MIXED-UP SHYMER
(c) 1987 Sandra Sharkey
Written with the GAC
You are walking along a road that leads east, west and south with an open gate to the north
>n
In the graveyard. A door leads east into the church. A gate stands open to the south. You notice Lucy Locket playing here
>look
In the graveyard. A door leads east into the church. A gate stands open to the south. You notice Lucy Locket playing here
>WOS

Casey Jones (Blaby Computer Games,1984)
Arcade



Cash Book (Supersoft,1988)
Utility

>No.	Name	CD	Dat
>	0 Initial Balance		00:00

Enter Initial Balance
Input Credit or Debit :

Cashcalc (Wizard Supersoft,1983)
Utility

WE HAVE
NO SCREENSHOT
OF THIS
PROGRAM

Cascade (Paul Howard,1994)
Strategy



Case of the Obscene Mural, The (Encief Routines,1986)
Text Adventure

You are in a room which has a door to the south, a cupboard to the north, and bookcases on the east and west walls. The books range from
BIGGLES COMBS HIS HAIR
and
ETHEL THE AARDVAARK GOES QUANTITY SURVEYING
to
THE KARMA SUTRA FOR GERBILS (ENLARGED PRINT)
Hardly an inspiring collection.
As you enter a huge penguin drops from the ceiling and starts to eat a packed lunch, blocking the south door. You cannot leave that way!
What will you do now?
WOS

Cash Book (Hestacrest Business Software,1984)
Utility

WE HAVE
NO SCREENSHOT
OF THIS
PROGRAM

Cash Book Accounting (Gemini Marketing Ltd,1984)
Utility: Spreadsheet

CASHBOOK MENU

00-0000000000000000
111111111111111111
-+X+M 33333333

ENTER OPTION

Cash Controller (Richard Shepherd Software Ltd,1983)
Utility: Spreadsheet

BUDGET OPTIONS

- 1 Enter new budgets
- 2 Update budgets
- 3 Print budgets and variances
- 4 Breakdown budget actual
- 5 Clear all budget details and enter new budgets
- 6 Return to master menu

© Richard Shepherd 1983

Cascamuelas (Beyker Soft,2004)
Arcade

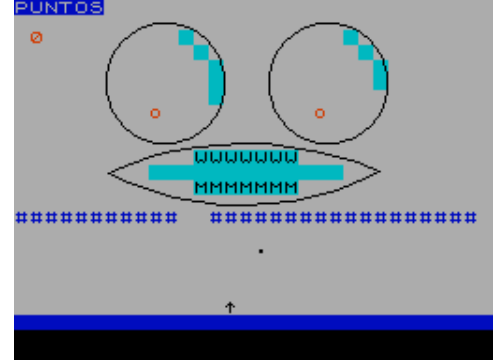

Casete de Juegos (Tu Micro,1985)
Compilation

WE HAVE
NO SCREENSHOT
OF THIS
PROGRAM

Cash Book (Sinclair User,1992)
Utility

WE HAVE
NO SCREENSHOT
OF THIS
PROGRAM

Cashcade (Fastback,1990)
Board/Card Game

CASHCADE

LIVES 02 SCORE 0000

AT WHICH OLYMPIC GAMES DID ALAN WELLS WIN THE 100 METRES GOLD?

TIHER: []

- 1 LOS ANGELES
- 2 MOSCOW
- 3 ROHE

SPORT [X]

Cashdash (Tynesoft,)
Arcade



Cash-Planner DeLuxe (Dr. Gonza Software,1984)
Utility



Casino (Hilton Computer Services Ltd.)
Arcade



Casino 1 (J.P. Gibbons,1983)
Arcade

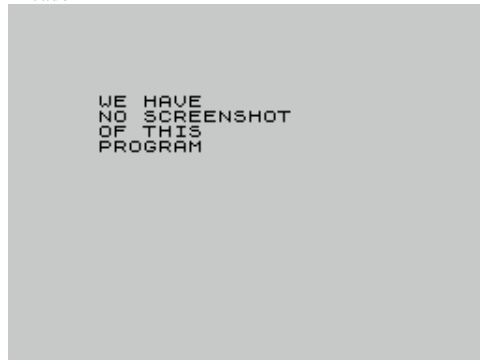

Casino Royal (Oxford Computer Publishing,1984)
Board/Card Game



Cassette 1 (Silicon Software,1982)
Simulation



Cassette 4 - Vol 1 (Cascade Games Ltd,1984)
Compilation

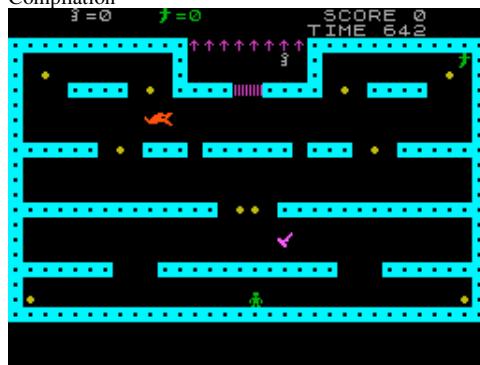

Cassette 50 (Cascade Games Ltd,1983)
Compilation



Cassette A (Orwin Software,1984)
Compilation



Cassini's Division (Eclipse [2],1989)
Arcade

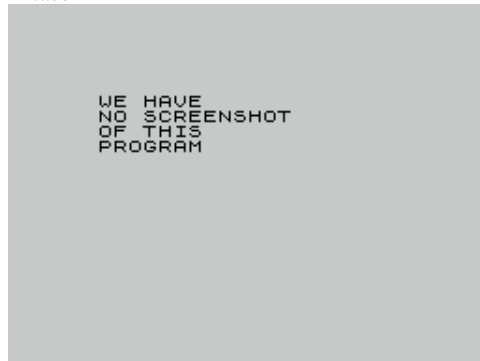

Castillo Embrujado, El (MicroHobby,1986)
Arcade

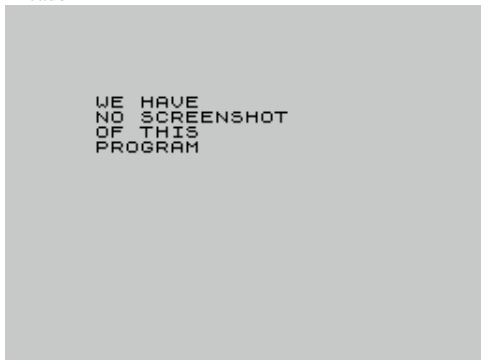

Castillo Maldito (Beyker Soft,2003)
Arcade

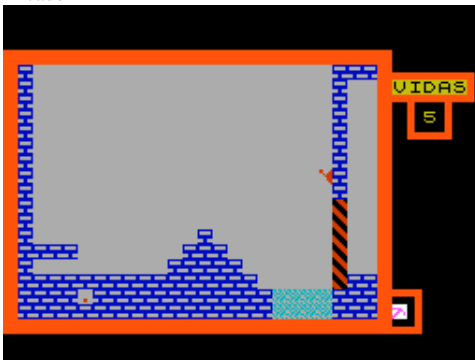

Castillo Maldito (MicroHobby,1985)
Text Adventure



Castle (L'Ensouleiado Software,1984)
Educational



Castle Adventure (G.I. Games,1990)
Text Adventure

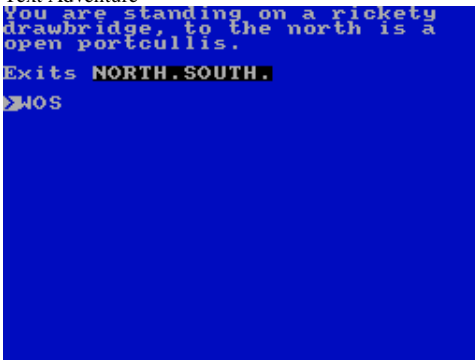

Castle Blackstar (SCR Adventures,1984)
Text Adventure

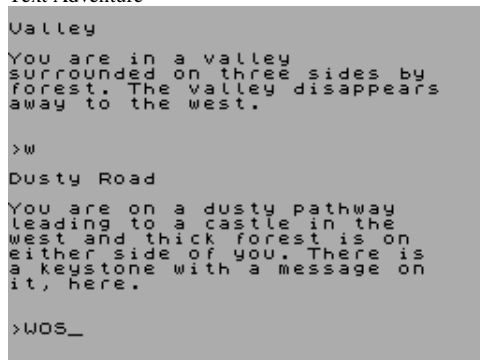

Castle Colditz (Felix Software,1984)
Text Adventure

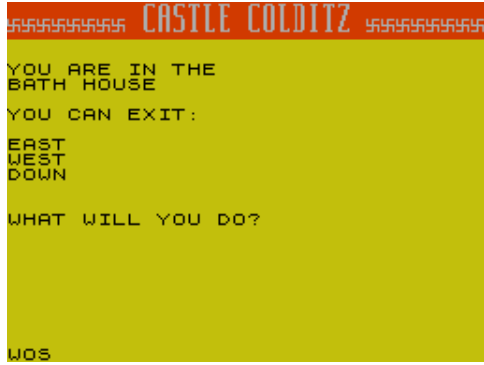

Castle Colditz + Battle of the Toothpaste Tubes (K-Tel Productions,1984) Compilation

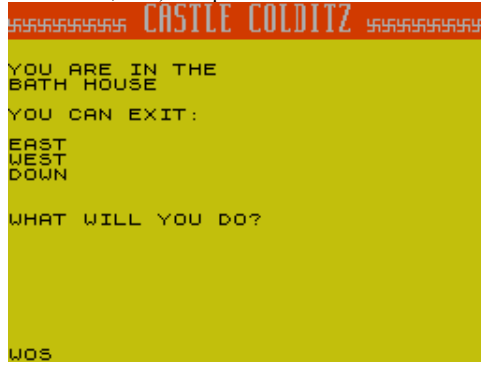

Castle Eerie (Tartan Software,1987)
Text Adventure

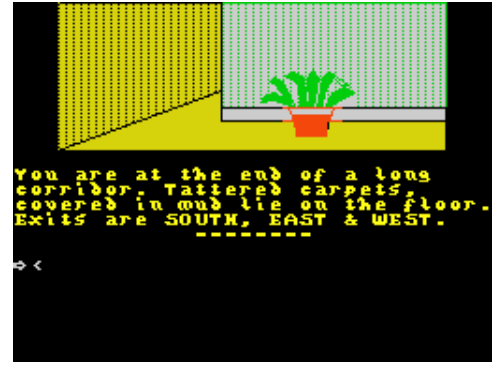

Castle Master (Incentive Software Ltd,1990)
Arcade



Castle Master + Castle Master II: The Crypt (Incentive Software Ltd,1990) Compilation



Castle Master II: The Crypt (Incentive Software Ltd,1990)
Arcade

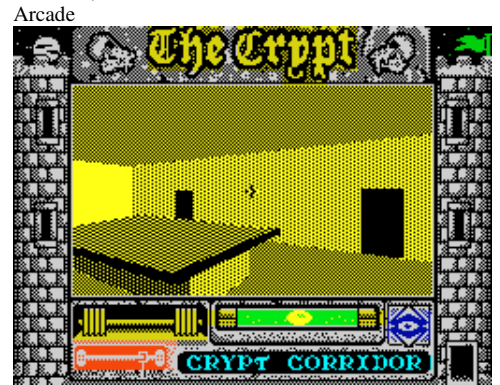

Castlemaze Adventure (Duckworth Educational Computing,1984) Text Adventure

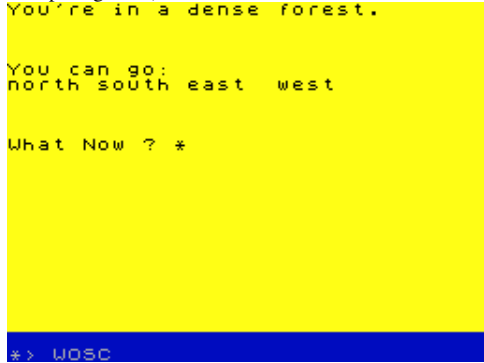

Castle Morcan (Simon Wood,1989)
Text Adventure



Castle of Death (Video Force,)
Text Adventure



Castle of Doom, The (Fantasy Software [2],1989)
Text Adventure



Castle of Dreams (Widgit Software Ltd,1984)
Text Adventure



Castle of Mydor (Mountain Valley Software,)
Text Adventure



Castle of Terror (,1984)
Text Adventure



Castle of the Skull Lord (Samurai Software,1984)
Text Adventure

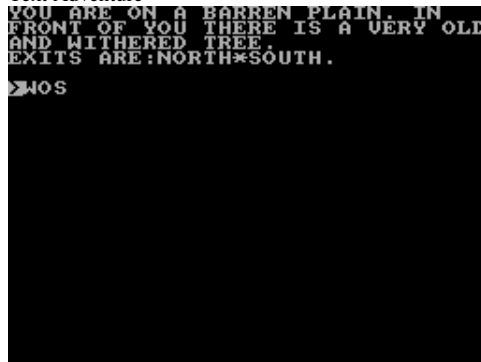

Castle Quest (Scorpio Gamesworld,1984)
Arcade Adventure



Castle Quest (Wildest Dreams,1984)

Adventure

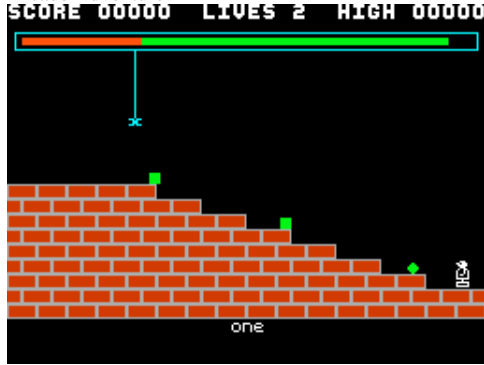

Castle Thade (Spectrum Adventure Exch Club,1986)

Text Adventure

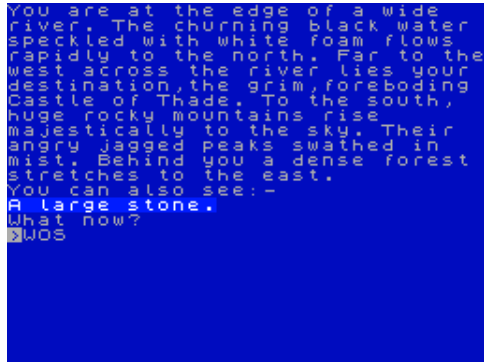

Castle, The (Dan B. Nielsen,)

Text Adventure



Castor Intro 10: Auf Wiedersehen (Castor Cracking Group,1988) Scene Demo



Castor Intro 4: Balls (Castor Cracking Group,1987)

Scene Demo



Castles and Clowns (Macmillan Software Ltd,1985)

Educational

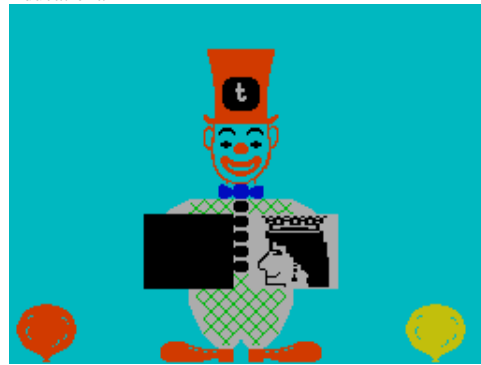

Castle Thade Revisited (Spectrum Adventure Exch Club,1987)

Text Adventure

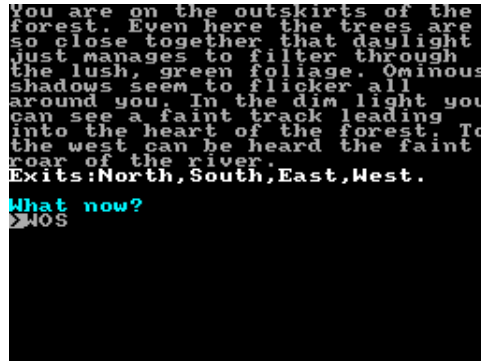

Castle Walls (Phipps Associates,1982)

Adventure

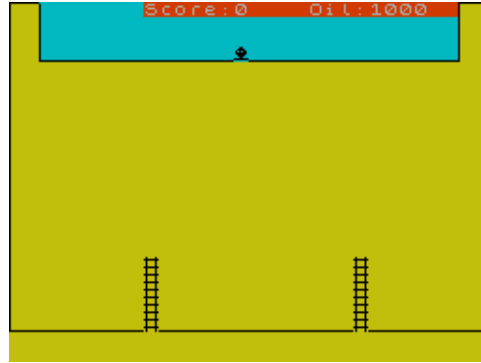

Castor Intro 2: Trap Door (Castor Cracking Group,1987)

Scene Demo



Castor Intro 5: Boing Boomchack (Castor Cracking Group,1987) Scene Demo



Castle Spellerous (Sinclair Research Ltd,1983)

Educational



Castle, The (Bug-Byte Software Ltd,1983)

Text Adventure

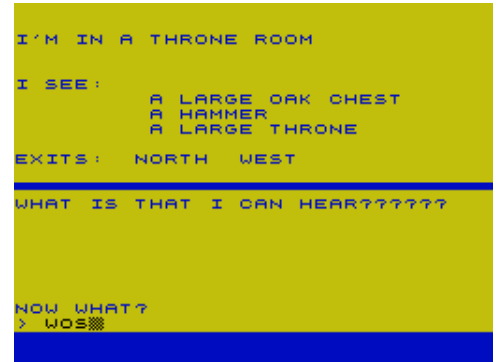

Castle Warlock (Adventure Probe Software,1991)

Text Adventure

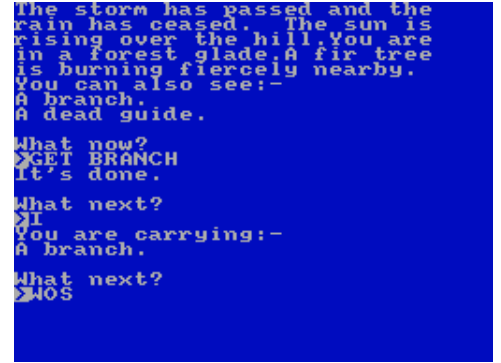

Castor Intro 3: Ocean (Castor Cracking Group,1987) Scene Demo



Castor Intro 6: Monster Banquet (Castor Cracking Group,1987) Scene Demo



Castor Intro 8: Dan There (Castor Cracking Group,1987)
Scene Demo



Catastrophic Holiday, A (NE-AD Software,1987)
Text Adventure

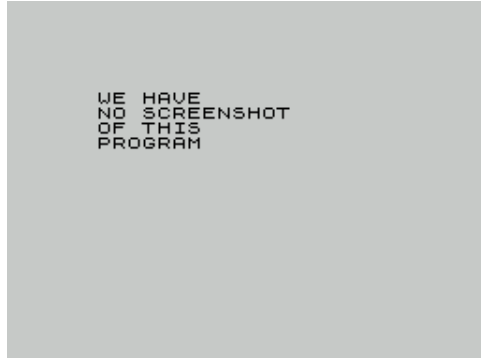

Catch 23 (Martech Games Ltd,1987)
Arcade Adventure

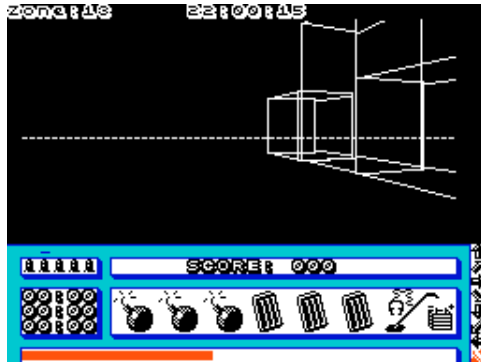

Caterpillar (CDS Microsystems,1983)
Arcade



Cat 'n Mouse (Video Productions,1983)
Arcade

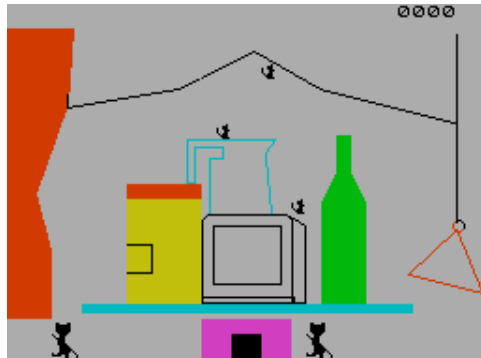

Castor Intro 9: Move That Army (Castor Cracking Group,1987) Scene Demo



Catastrophic Holiday, A + Catastrophies at School (NE-AD Software,1987) Compilation



Catchman (Sinclair User,1985)
Arcade



Cathouse Blues (Silver Fox Comm Ltd,1983)
Board/Card Game



Cat-Swap (Shiva Publishing Ltd,1983)
Board/Card Game



Catalogger (Pawel Mackow,1984)
Utility



Catastrophies at School (NE-AD Software,1987)
Text Adventure



Caterpilla (Spectrum Games Ltd,1984)
Strategy



Catloader (Outlet Microdrive Magazine,1986)
Utility



Cattapiller Crunch (Elektra Personal Computer Software,1982) Arcade



Cattell IQ Test (Sinclair Research Ltd,1983)

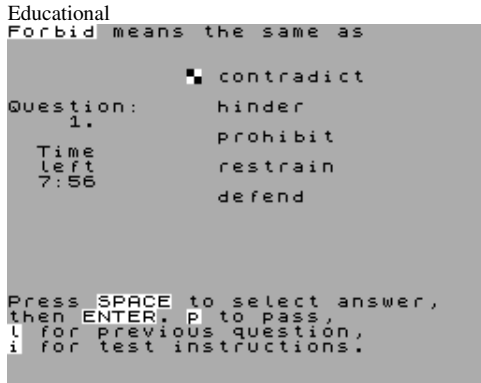

Cauldron II: The Pumpkin Strikes Back (Palace Software,1986) Arcade



Cave-Fighter (.) Arcade

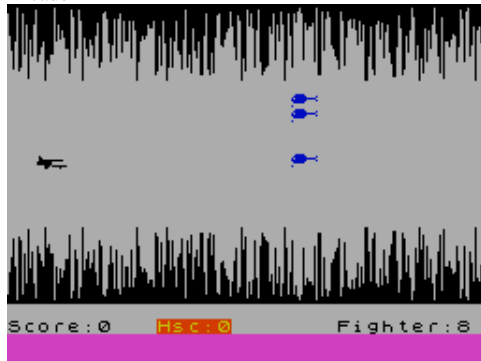

Caveman (CRL Group PLC,1983) Arcade



Caverna del Dragon de Bronce, La (Danisoft.) Text Adventure



Catwalk (Power Software,1984) Arcade



Cauldron I & II (Hi-Tec Software Ltd,1990) Compilation



Cave Flyer (.) Arcade



Caveman Capers (Icon Software Ltd.) Arcade



Caverna Infernal, La (Digital Launch,1988) Text Adventure



Cauldron (Palace Software,1985) Arcade



Cave Attack (Machinecraft,1982) Arcade



Cavelon (Ocean Software Ltd,1984) Arcade



Cavemania (Atlantis Software Ltd,1990) Arcade Adventure



Cavernas (Jorge Perez Barreiro,1985) Arcade



Cavernas (MicroHobby,1986)
Arcade



Cavern Fighter (Bug-Byte Software Ltd,1983)
Arcade



Cavern, The (Popular Computing Weekly,1983)
Arcade



Caves of Skull, The (Dream World Adventures,1995)
Text Adventure



Ca y Est (Individual Software Service/Hueber Software,1984) Educational



Cavern Chaos (5D Software,1985)
Text Adventure

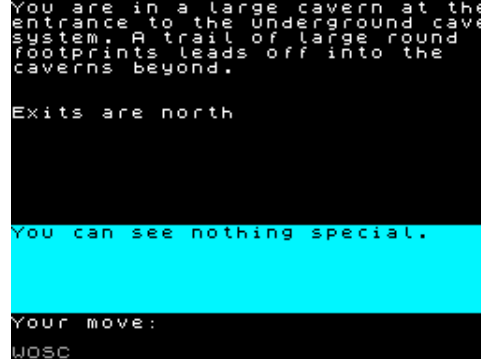

Cavernon (EP Software,)
Arcade



Caves of Death (Siberian Group,2003)
Arcade

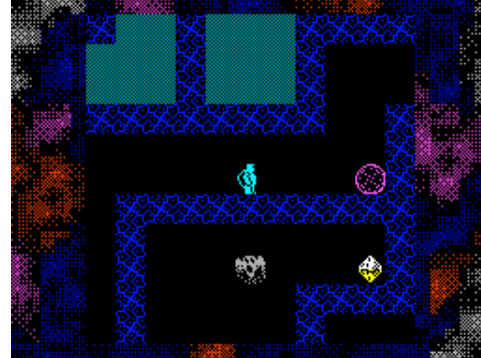

Caves of the Spiders (Fontana Publishing,1984)
Arcade



Caza del Homo Sapiens, La (Alien Software,1990)
Arcade

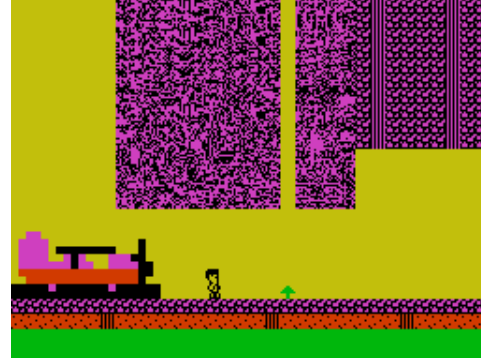

Cavern Chaos + Ptarmigan (5D Software,1985)
Compilation

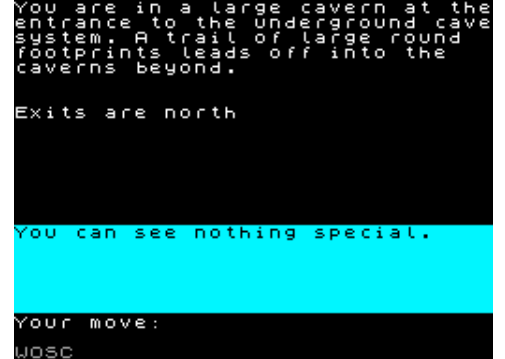

Caverns of Kontonia (Atlantis Software Ltd,1986)
Arcade Adventure



Caves of Doom, The (Mastertronic Ltd,1985)
Arcade



Cavrljanje (Radio Ventilator 202,1984)
Utility: Sound Manipulation

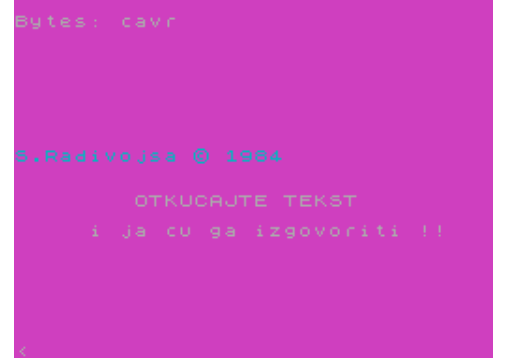

Cazafantomas (MicroHobby,1985)
Arcade



Caza Menor (MicroHobby,1985)

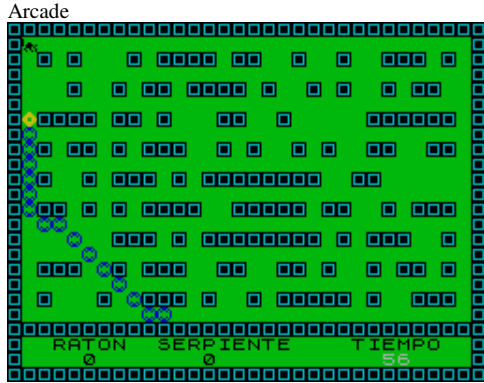

C Compiler (Kamasoft,1988)

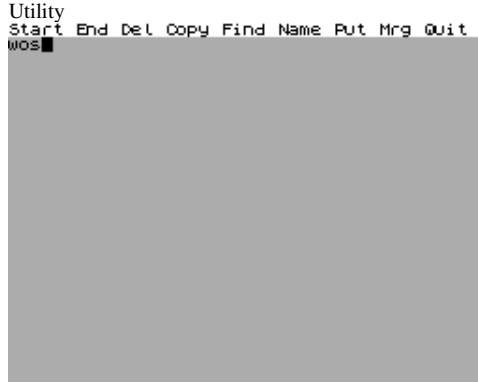

CD Games Pack, The (Code Masters Ltd,1989) Compilation



CD-Player (Players Software,1988)



Ceasefire (Sinclair User,1991)



Ceasefire 2: Night Run (Sinclair User,1992)



Cecco's Collection (Hewson Consultants Ltd,1990)

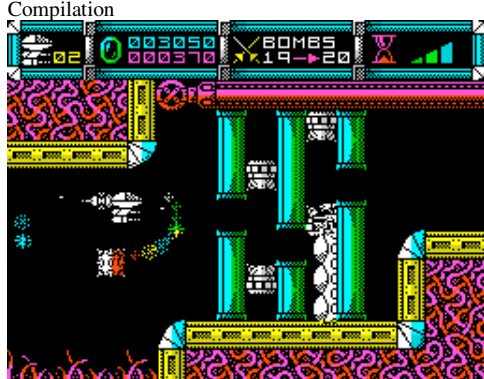

Cederick (Data-Skip Software,1985)



Celestino (Ediciones y Textos S.A.,1985)



Cell Growth (Scetlander,1988)



Cell of the Ridges (.)



Cells and Serpents (ASP Software Ltd,1983)



Celtic Carnage (Zenobi Software,1993)



Centauri Challenge (Data-Skip Software,1985)



Centi-Bug (DK'Tronics Ltd,1983)

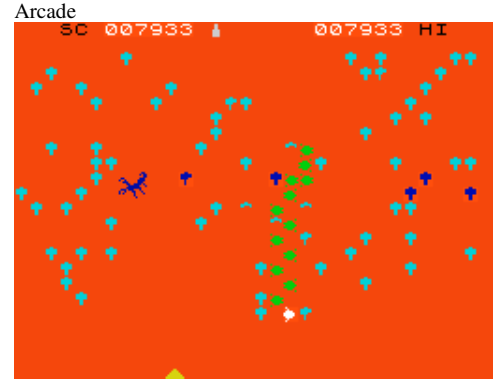

Centimunch (TNT Software,1983)
Arcade



Centipede (Sinclair User,1983)
Arcade



Centipede + Painter (C-Tech,1983)
Compilation



Centipoid Plus 3 (Orwin Software,1984)
Arcade



Centronics Printer Software (Datel Electronics,1983)
Utility

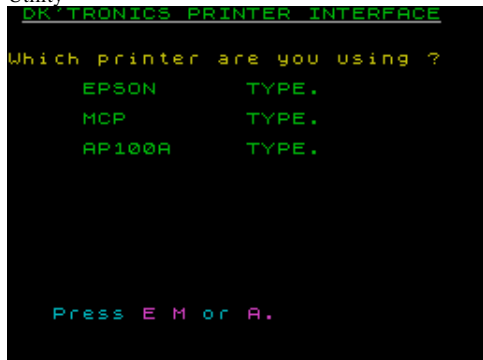

Centipede (DK'Tronics Ltd,1982)
Arcade



Centipede (Vectis Software,1983)
Arcade



Centipedes (EMM Software,1983)
Arcade

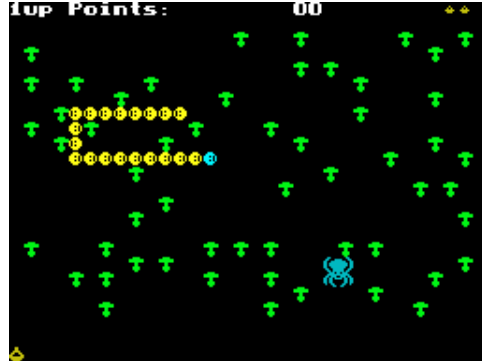

Centre Graphics, The (Jacek Michalak,)
Scene Demo

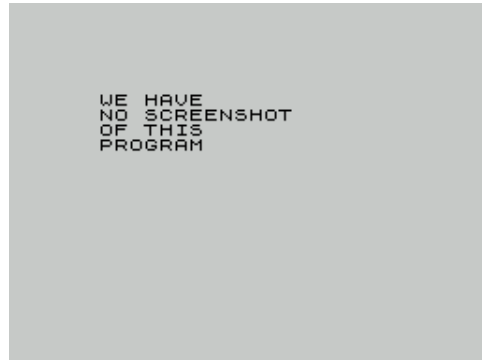

Centronics Printer Software (DK'Tronics Ltd,1985)
Utility

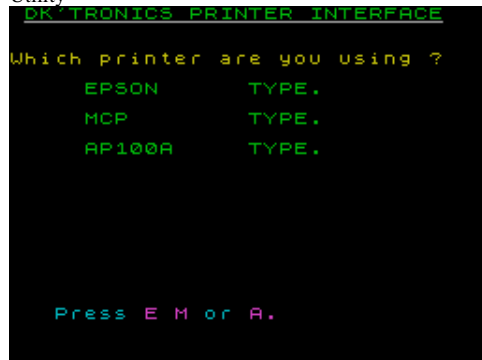

Centipede (R. Bhattacharya,1983)
Arcade

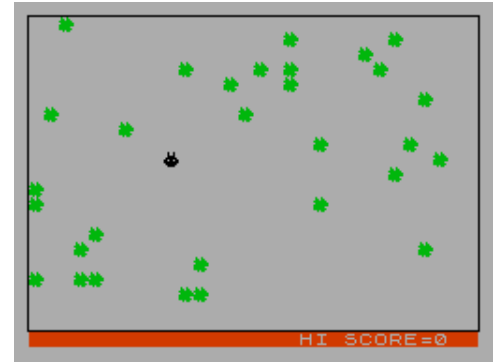

Centipede + Galaxions (Mikro-Gen Ltd,)
Compilation



Centipod (Challenge Software,1990)
Arcade

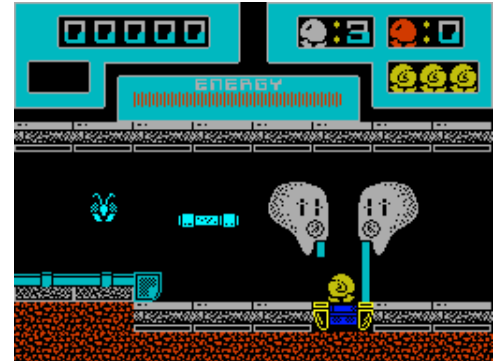

Centronics Interface Software (Kempston Micro
Electronics Ltd,1983) Utility

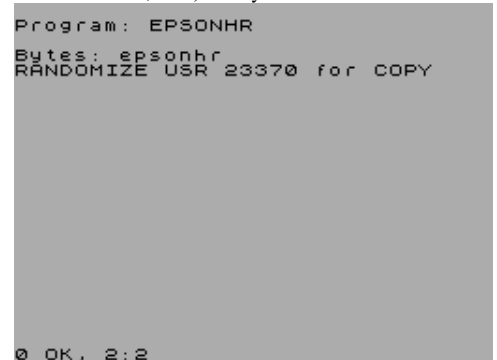

Centronics-Schnittstelle (HWG,1986)
Utility

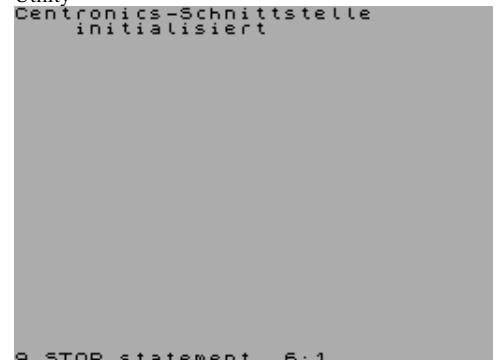

Centropods (Rabbit Software Ltd,1983)
Strategy



Cerius (Atlantis Software Ltd,1988)
Arcade



Cesped (Micromania [2],1985)
Arcade



Chainick: Horror in Flat (Optical Brothers,1999)
Text Adventure



Chaldon (.)
Arcade



Centurions (Reaktor,1987)
Arcade



Cerius II: Interalia (Atlantis Software Ltd,1991)
Arcade

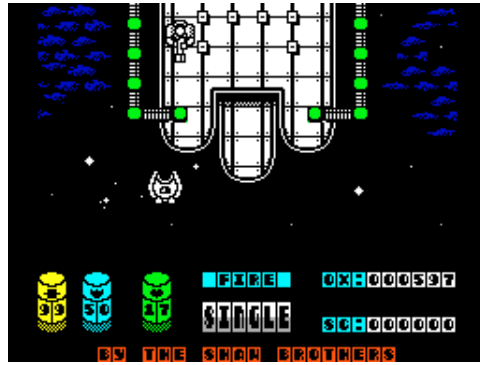

Cesta Bojovnika (Ultrasoft,1992)
Arcade



Chain Reaction (Durell Software Ltd,1987)
Arcade Adventure

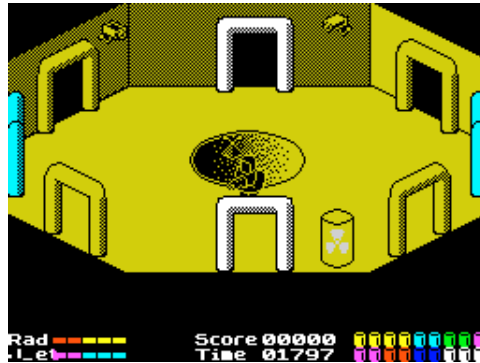

Challenge (Azed Software,1986)
Board/Card Game

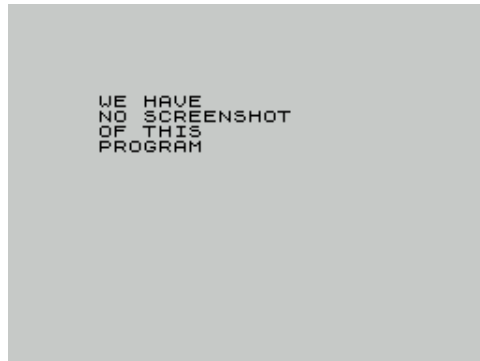

Cerebral (The United Minds,1995)
Scene Demo



C.E.S. (Scisoft.)
Educational

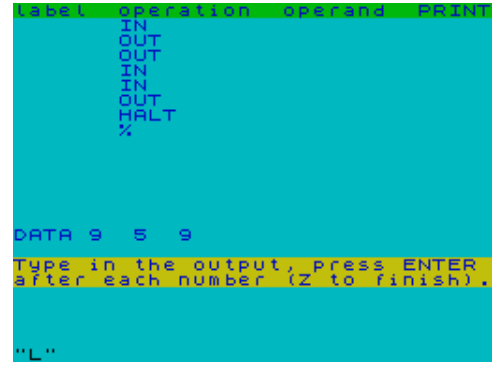

Cezar, The (Action,1999)
Strategy

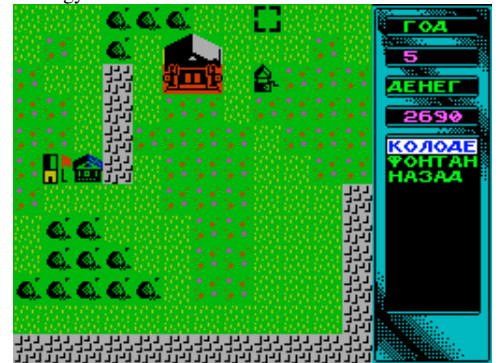

Chain, The (W. Heap,1991)
Arcade

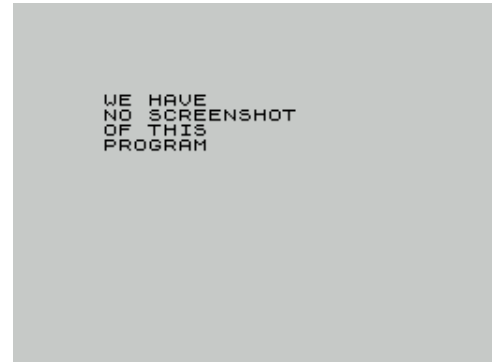

Challenge (Temptation Software,1983)
Board/Card Game

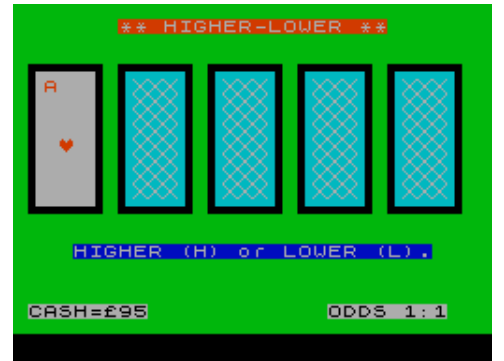

Challenge + Davy Jones Locker, The (River Software,1987)

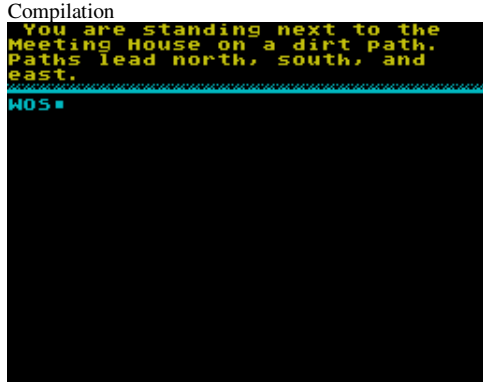

Challenge of Iythus, The (Creative Juices,1988)



Challenge of the Gobots (Reaktor,1987)



Challengers (Ubi Soft Ltd,1991)

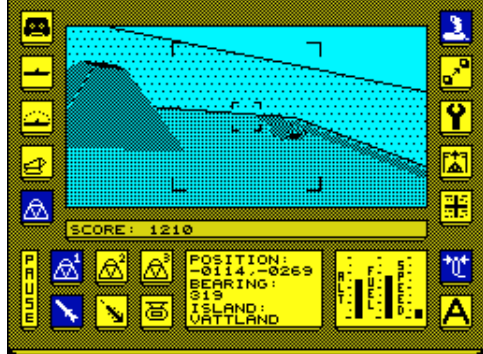

Challenge, The (River Software,1987)



Chambers of Death (Automata UK Ltd,1984)



Chambers of Horrors (Omega Software Ltd,1984)



Chameleon Key, The (Dream World Adventures,1994)

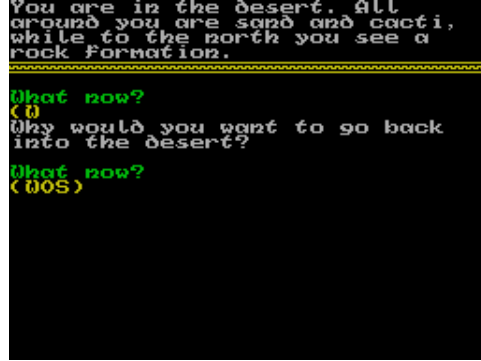

Champ (PSS/The Home Computer Advanced Course,1984)

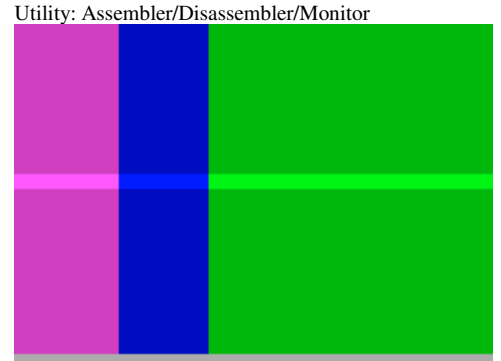

Champions (Hobby Software,1985)



Champions (Krisalis Software Ltd,1991)

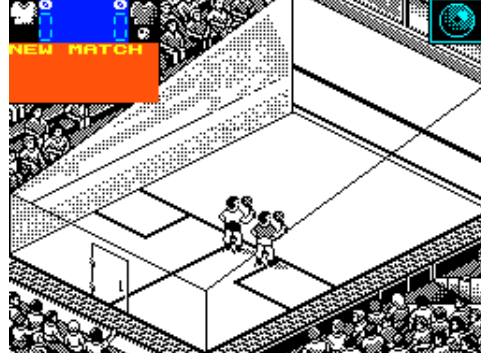

Champions (Peaksoft,1983)



Championship 3D Snooker (Zeppelin Games Ltd,1992)



Championship Baseball (Gamestar,1987)



Championship Boxing (Lambourne Games,1991)

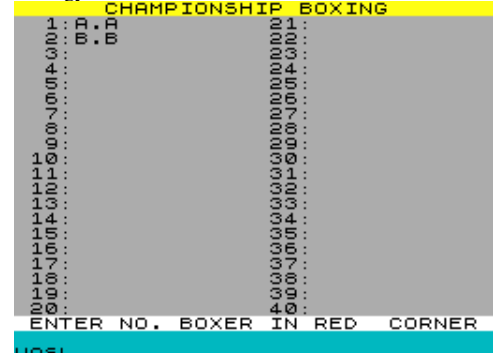

Championship Darts (Shadow Software,1983)
Sport

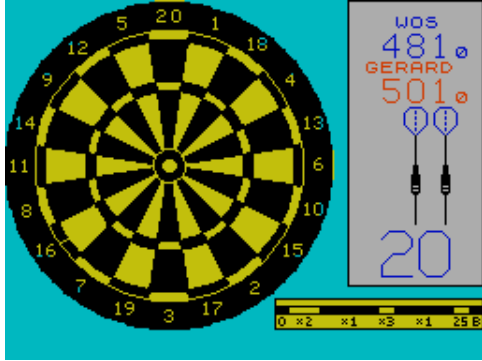

Championship Run (Impulze,1991)
Arcade



Champions of Cricket + World Cup Cricket - 2 To 6
Version (Lambourne Games,1991) Simulation



Champions of Cricket + World Cup Cricket - Data
Cassette 1992 (Lambourne Games,1992) Simulation



Champions of Cricket - 2 to 6 Version Mod
(Lambourne Games,1991) Simulation



Championship Golf (D&H Games,1988)
Sport



Championship Soccer (STD Software,1989)
Simulation



Champions of Cricket + World Cup Cricket - All Time
Greats (Lambourne Games,1991) Simulation

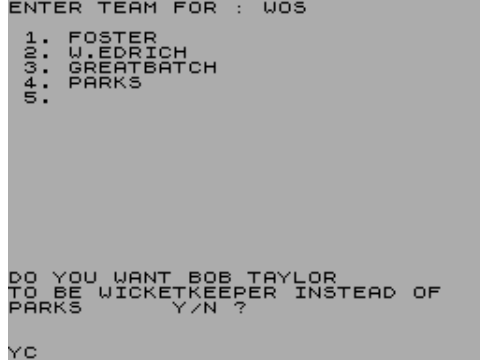

Champions of Cricket + World Cup Cricket - Data
Cassette 1993 (Lambourne Games,1993) Simulation



Champions of Cricket - Body Line Series (Lambourne
Games,1991) Simulation

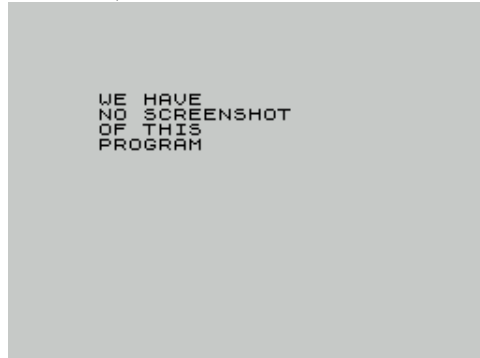

Championship Jet Ski Simulator (Code Masters
Ltd,1989)
Sport



Championship Sprint (Electric Dreams Software,1988)
Arcade

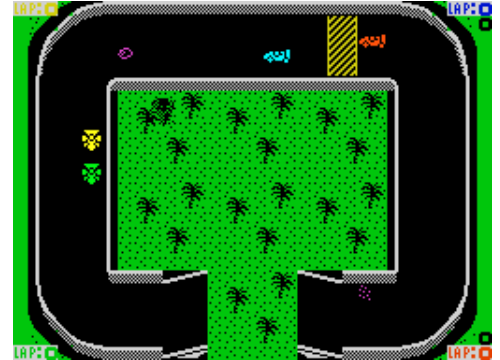

Champions of Cricket + World Cup Cricket - Data
Cassette 1991 (Lambourne Games,1991) Simulation



Champions of Cricket + World Cup Cricket - Data
Cassette 1994 (Lambourne Games,1994) Simulation



Champions of Cricket - Expanded Version (Lambourne
Games,1991) Simulation



Champions of Cricket - Extended Version (Lambourne Games,1991) Simulation

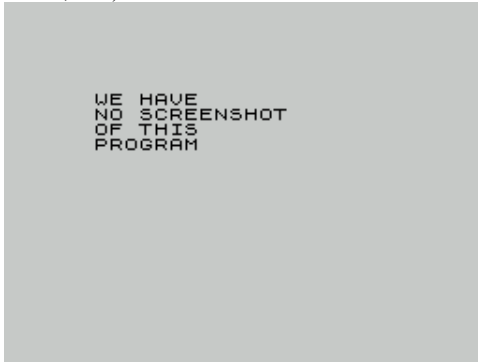

Champions of Cricket - Special (Lambourne Games,) Simulation



Champ, The (Linel Software,1991) Arcade

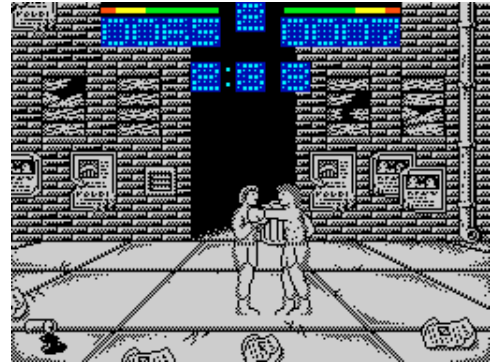

Change It! (Weird Science Software,1995) Arcade

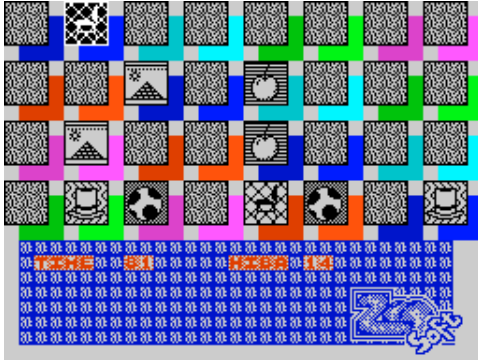

Changeling, The (M.J. Gearing,1984) Text Adventure

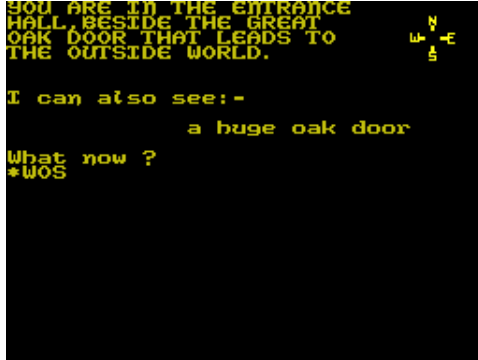

Chaos (Games Workshop,1985) Arcade



Chaos (Illusion Group,) Scene Demo



Chaos (Shiva Publishing Ltd,1983) Simulation



Chaos Editor (Your Sinclair,1991) Cheat

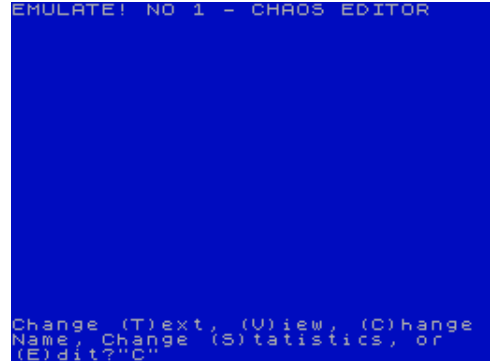

Chaossr (Pera Putnik,1985) Scene Demo



Chaotic Caverns (Silicon Joy,1984) Arcade

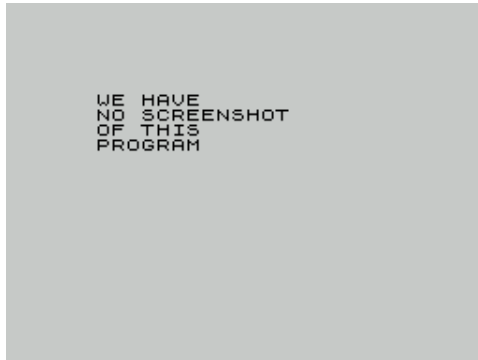

Character Builder (Shiva Publishing Ltd,1983) Utility: Font/UDGs



Character Designer (Gap Software,1986) Utility: Font/UDGs

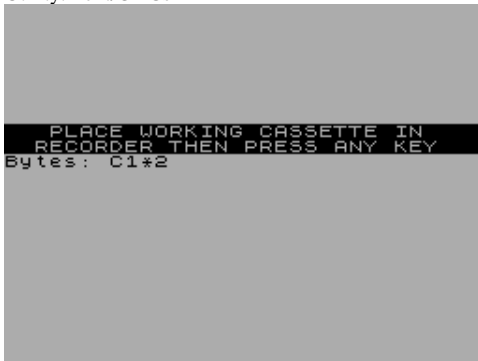

Character Designer (Procom Software,1983) Utility: Font/UDGs



Character Designer (Spectrum Computing,1986) Utility: Font/UDGs



Character Editor 2 (Jury Nikolskiy,1987)

Utility: Font/UDGs

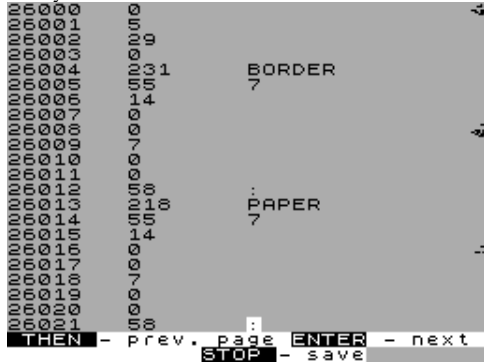

Character Generator (Malan Associates,1984)

Utility: Font/UDGs



Character Generator & Animator (Peker Computers Ltd,1985)

Utility: Font/UDGs

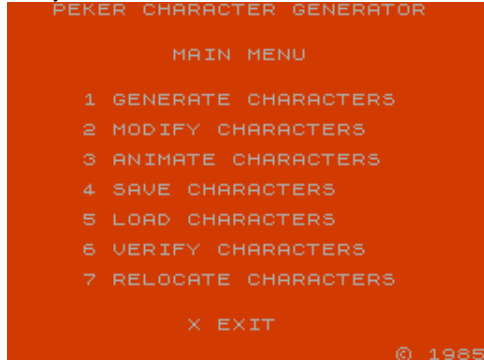

Characters (Gilsoft International,1987)

Utility: Font/UDGs



Charca, La (MicroHobby,1984)

Board/Card Game



Character Enlarger (Turtle Software,1985)

Utility: Font/UDGs



Character Generator (Sinclair Research Ltd,1982)

Utility: Font/UDGs



Character Generator, The (Interactive Software People,1984)

Utility: Font/UDGs



Character Set (CP Software,)

Utility: Font/UDGs

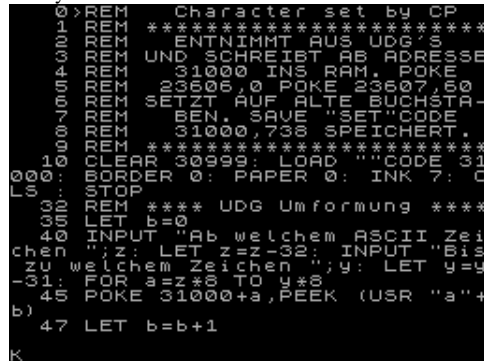

Charge Master (Dentron Computers,1985)

Utility



Character Generator (Gloster Software,)

Utility: Font/UDGs



Character Generator (Triffid Software Research,1983)

Arcade Game Development Tool



Character Invader (Sar Investment Properties,1983)

Arcade



Character Set (Purv,1989)

Utility: Font/UDGs



Charge of the Teddybear (Virgin Books,1983)

Arcade

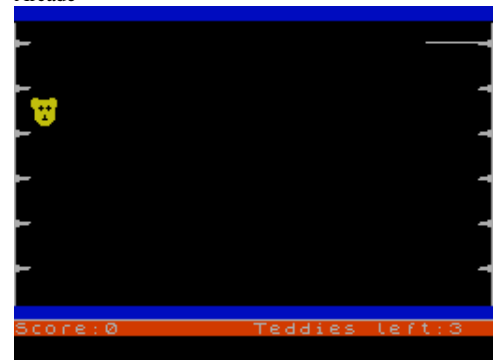

Charlie and the Chocolate Factory (Hill MacGibbon,1985)
Arcade Adventure

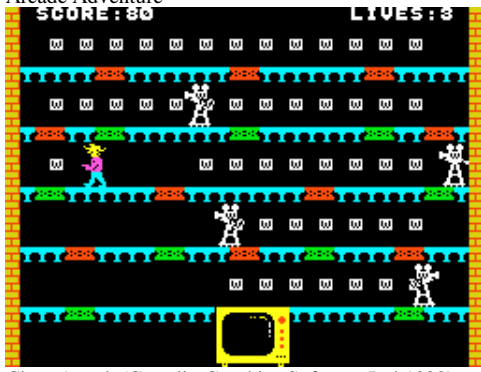
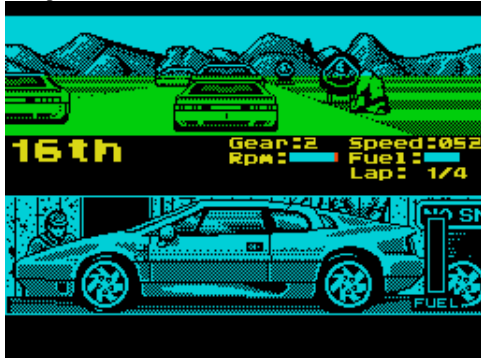

Chart Attack (Gremlin Graphics Software Ltd,1992)
Compilation



Char-Wallah (Keyword Software,1982)
Utility: Font/UDGs



Chase H.Q. II: Special Criminal Investigation (Ocean Software Ltd,1990) Arcade



Cheekah's Exploits (Your Computer,1986)
Arcade



Charset Collection (Stephan Slabihoud,1986)
Utility: Font/UDGs



Chartbusters (Ocean Software Ltd.)
Compilation



Chase (Abacus Programs,1984)
Arcade

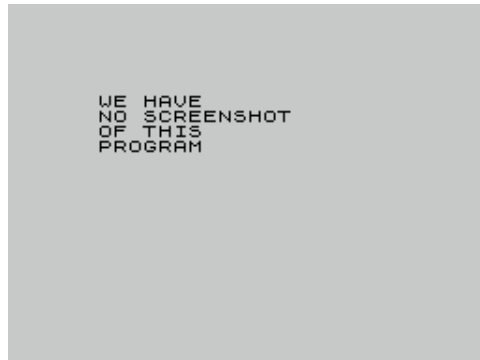

Chaser (Your Computer,1983)
Arcade

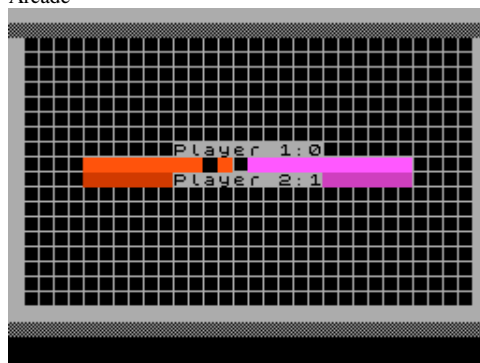

Cheese Thief (Sinclair Programs,1984)
Arcade



Charsize (SJS Software,1984)
Utility: Font/UDGs

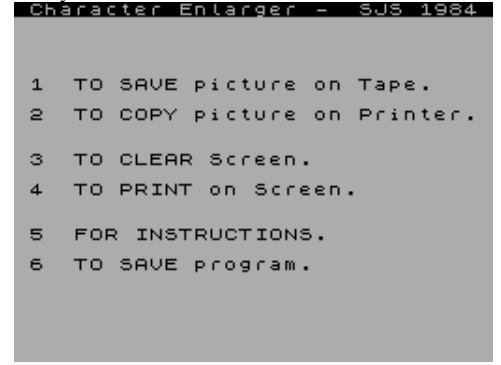
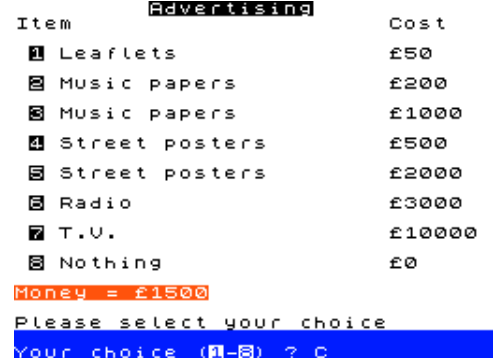

Chart Topper (.)
Simulation



Chase H.Q. (Ocean Software Ltd,1989)
Arcade



Chatbox (Cheetah Marketing Ltd,1983)
Simulation



Cheetah MIDI Interface (Cheetahsoft Ltd,1987)
Utility: Music Creation

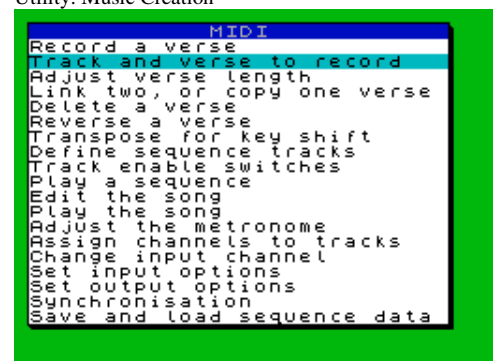

Chefs Mate 2 (Dominic Morris,1991)
Arcade

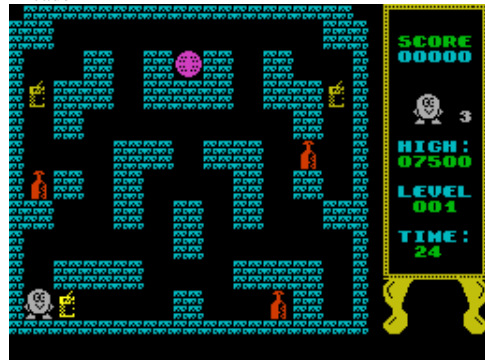

Chemie (Gerd Konig,1983)
Educational

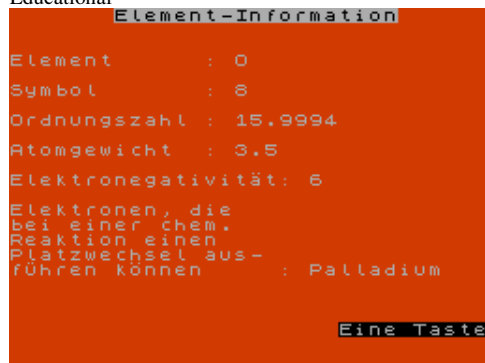

Chemistry (Collins Educational,1985)
Educational

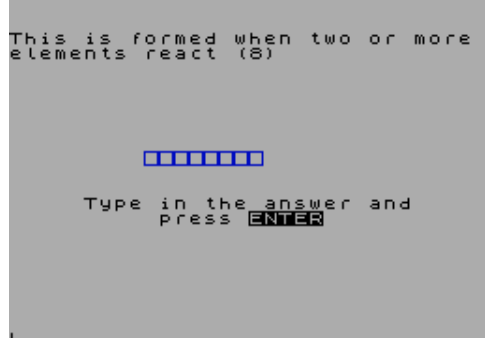

Chemistry (Visions Software Factory,1988)
Educational



Chemistry 'O' Level (Calisto,1983)
Educational

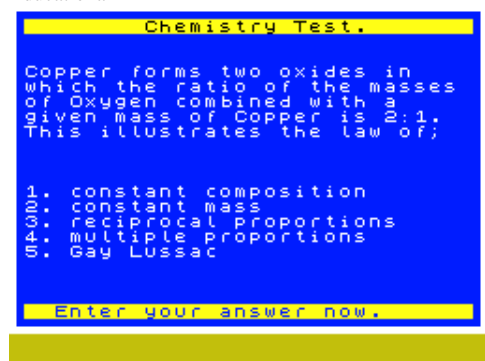

Chemal (Camel Micros,1983)
Educational



Chemistry (Charles Letts & Co,1985)
Educational

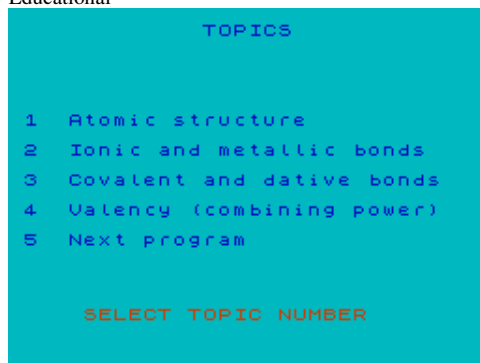

Chemistry (Hill MacGibbon,1986)
Educational

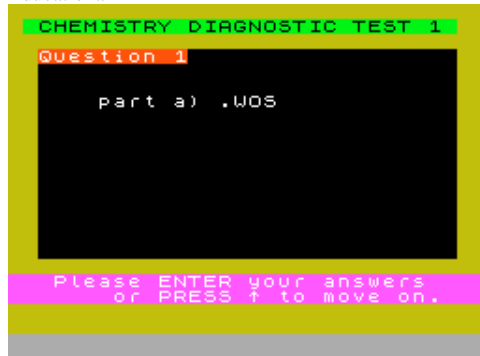

Chemistry 1 (Think Tank Educational Software,1983)
Educational

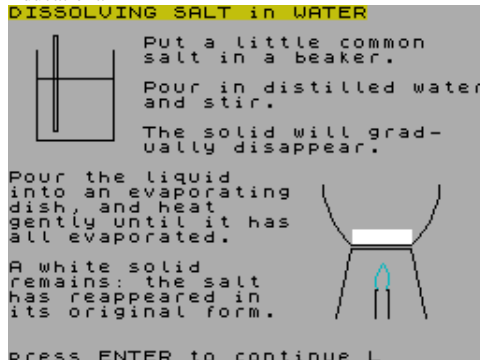

Chemistry Series O Level Vol 1 (Calpac Educational Software,1982)
Educational

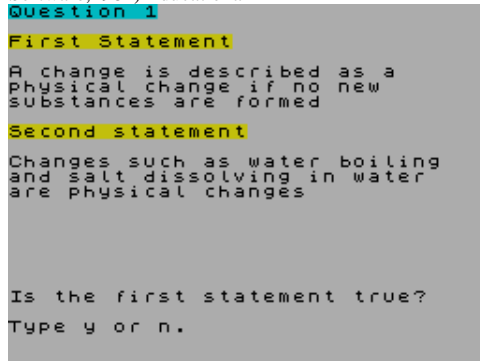

Chemical Formulae (Eclipse Software,1986)
Educational



Chemistry (Cloud 9 Software,1985)
Educational



Chemistry (Longman Software,1984)
Educational

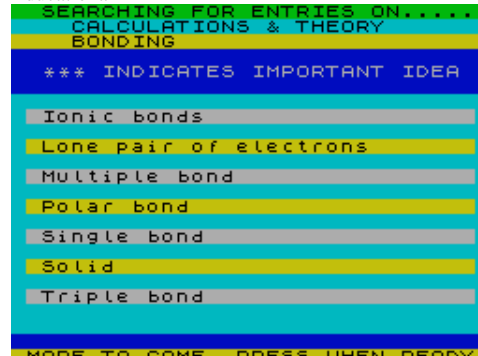

Chemistry - Examination Practice & Tests O Level (Sphere Software,) Educational

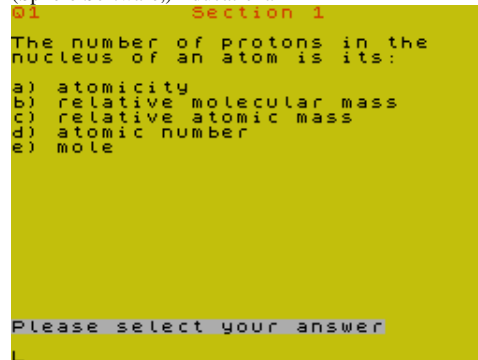

Chequeo (MicroHobby,1985)
Utility



Chequered Flag (Sinclair Research Ltd,1983)
Arcade



Chess, 3D (Bill Bennett,1983)
Board/Card Game

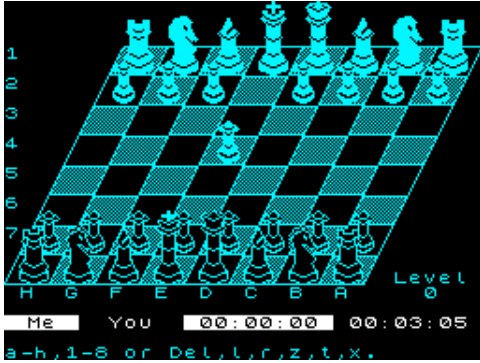

Chessfire (16/48 Tape Magazine,1983)
Board/Card Game



Chess Nuts (Paul T. Cimatti,1987)
Board/Card Game



Chess Tutor (Artic Computing Ltd,1983)
Board/Card Game

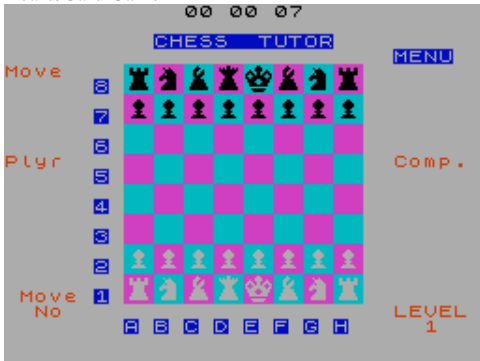

Chernobil (Startgame,1990)
Arcade Adventure



Chessboard (Spectrum Computing,1983)
Board/Card Game

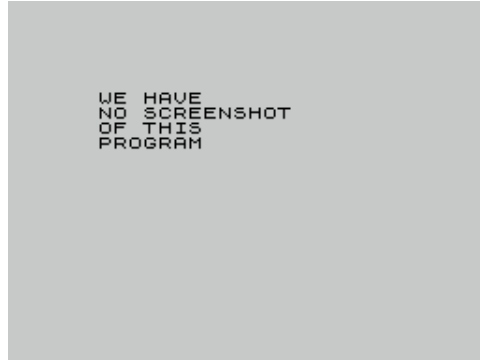

Chess Master (Serin Software,1984)
Board/Card Game

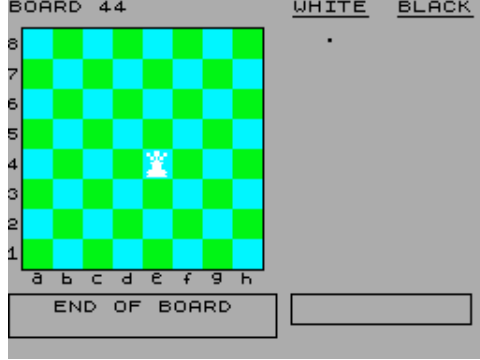

Chess Player, The (Quicksilva Ltd,1982)
Board/Card Game

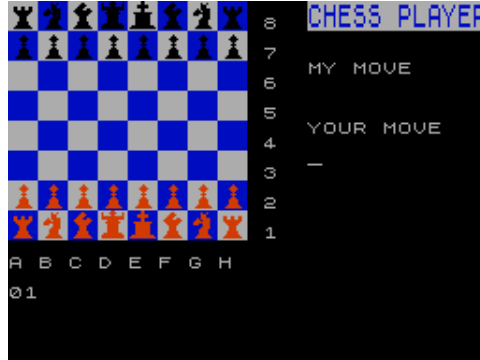

Chess Tutor 1 (Sinclair Research Ltd,1983)
Board/Card Game

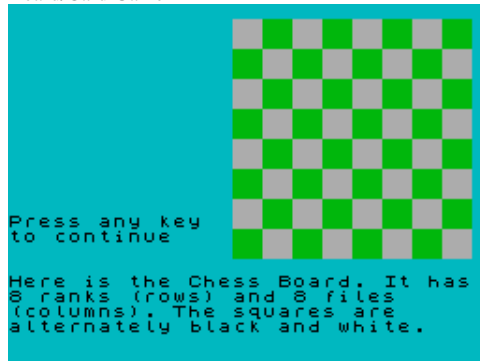

Chess (Sinclair Research Ltd,1983)
Board/Card Game



Chess Fig (.)
Board/Card Game



Chessmaster 2000, The (Dro Soft,1990)
Board/Card Game



Chess - The Turk (Oxford Computer Publishing,1982)
Board/Card Game



Chevy Chase (Hi-Tec Software Ltd,1991)
Arcade



Chicago (.)
Board/Card Game

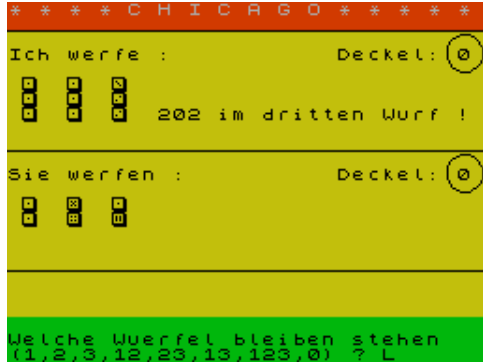

Chicago 30's + Coliseum (Topo Soft,1988)
Compilation

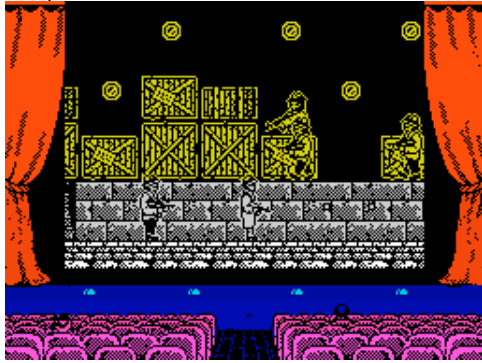

Chicken (XFAWORLD Software,2005)
Arcade

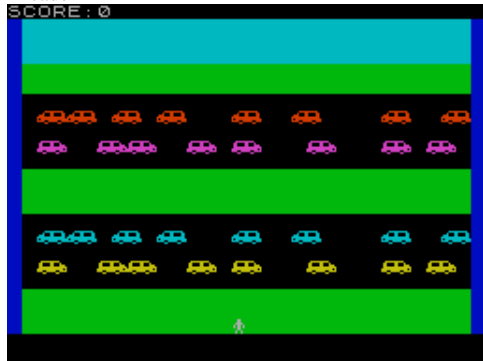

Children's Hour, The (King Dice,1984)
Demo

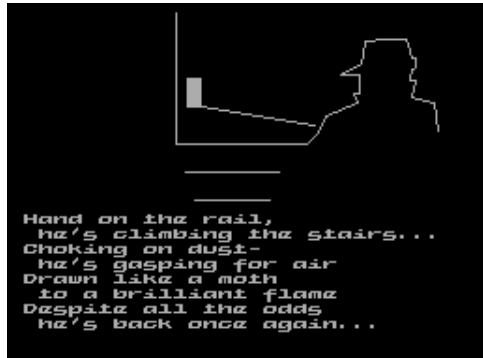

Chinatown (Zeppelin Games Ltd.)
Arcade



Chicago (Activision Inc,1987)
Text Adventure

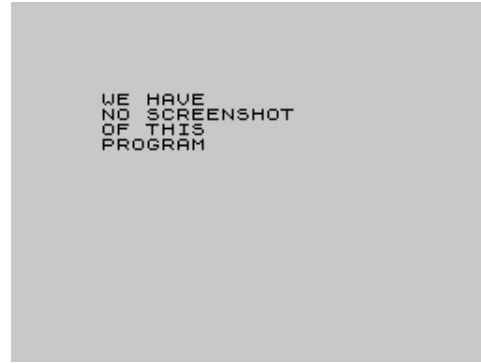

Chicane (Kempston Micro Electronics Ltd,1985)
Simulation



Chickin Chase (Firebird Software Ltd,1985)
Arcade



Chiller (Mastertronic Ltd,1985)
Arcade



Chinese Juggler, The (Ocean Software Ltd,1984)
Arcade



Chicago 30's (Topo Soft,1988)
Arcade

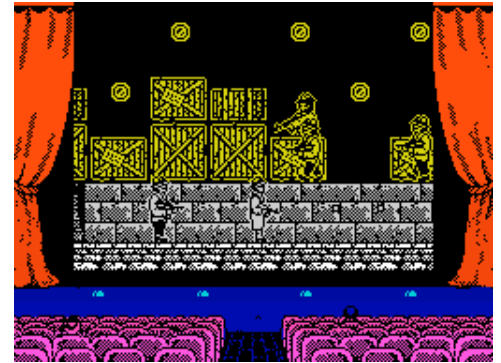

Chichen Itza (Aventuras AD S.A.,1992)
Text Adventure



Chieftan (Fontana Publishing,1984)
Arcade



Chimera (Firebird Software Ltd,1985)
Arcade



Chinese Patience (Atlantis Software Ltd,1985)
Board/Card Game

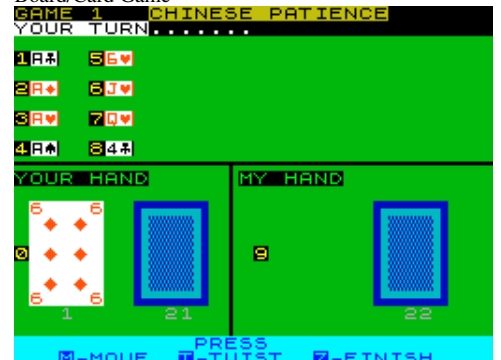

Chinos [1] (MicroHobby,1985)
Arcade

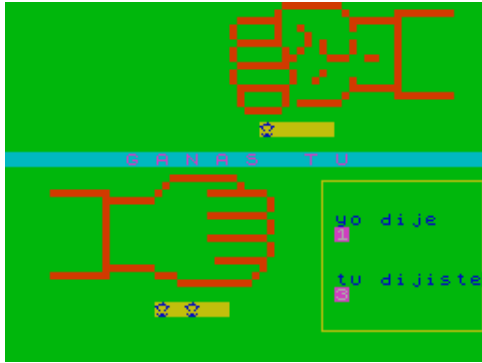

Chip Chat (Your Spectrum,1984)
Utility

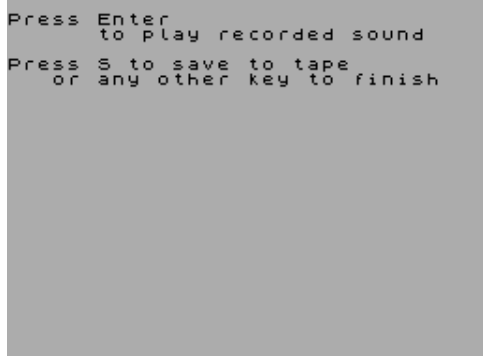

Chip Run (Carl Clayton,)
Arcade



Chip's Valley (MicroHobby,1985)
Arcade

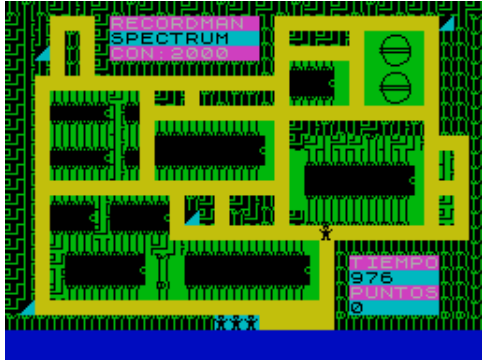

Chocolate Demo (The United Minds,1995)
Scene Demo



Chinos [2] (MicroHobby,1985)
Arcade

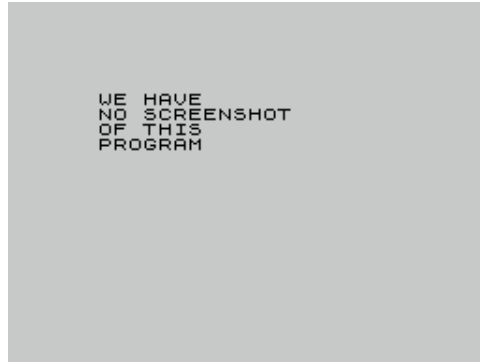

Chip Chek (Delta Research Ltd,1983)
Utility



Chips Are Forever (Futuresoft,1989)
Text Adventure



Chiron (Crash,1988)
Arcade

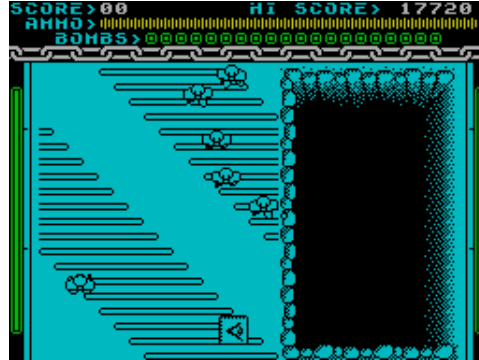

Choki (Max Hedrom,1987)
Scene Demo



Chip (,1985)
Arcade

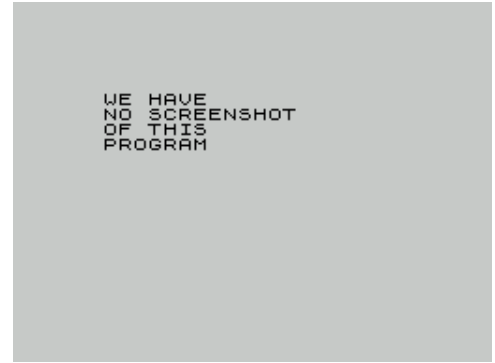

Chip, Der (Unicorn Soft,1986)
Text Adventure



Chip's Challenge (US Gold Ltd,1990)
Arcade

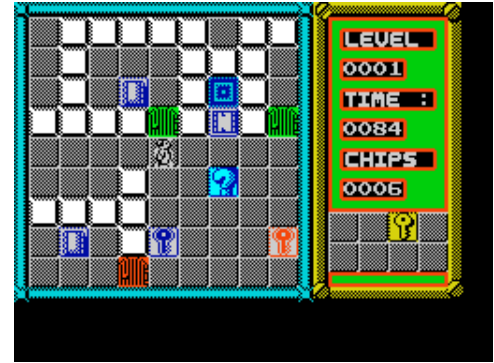

Chockman (Hyperion Software,1983)
Arcade

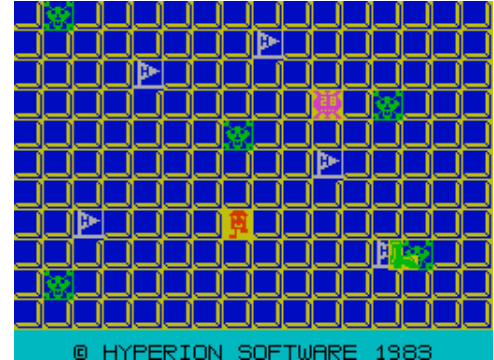

Cholo (Firebird Software Ltd,1987)
Arcade



Chomp! (Flowchart Ltd,1984)



Chopper Chase (Spectrum Computing,1984)



Chopper Rescue (Blaby Computer Games,1983)

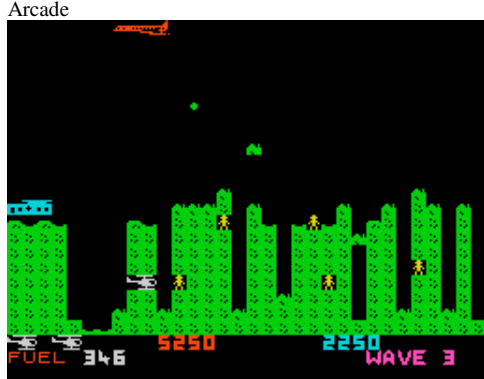

Chord Master (16/48 Tape Magazine,1985)



Christmas Collection (Hewson Consultants Ltd,1989)



Chomper (ZX Computing,1983)

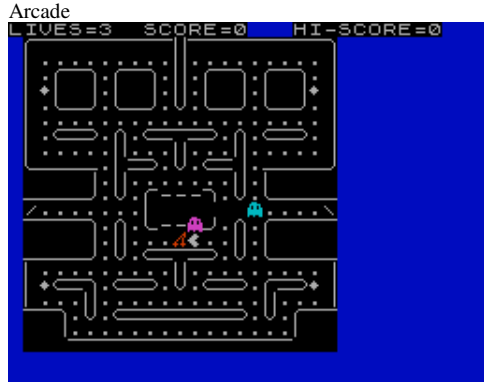

Chopper Duel (Star Group of Prestige,1997)



Chopper X-1 (R&R Software Ltd,1983)



Choy-Lee-Fut Kung-Fu Warrior (Positive,1990)

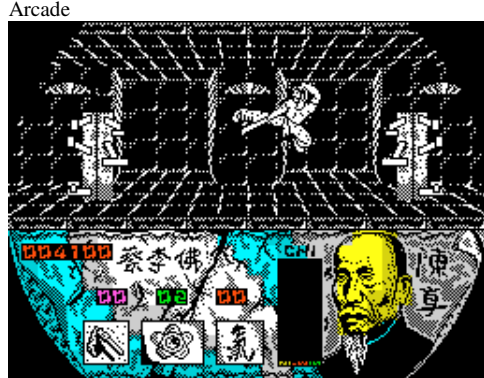

Christmas Demo (Hacker Chris,1989)



Chopper Attack (Fontana Publishing,1984)



Chopper Mission (Your Sinclair,1986)

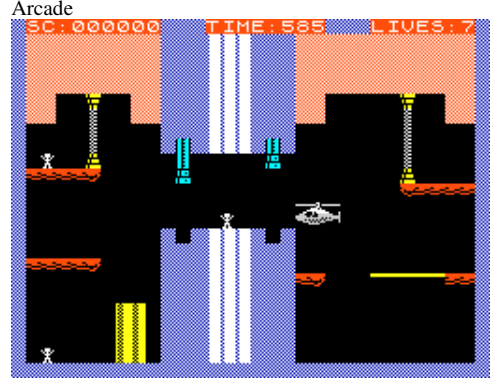

Choques (MicroHobby,1986)



Christmas128K Songs (NyitraiSOFT,2004)



Christmas Megapack (Code Masters Ltd,1991)

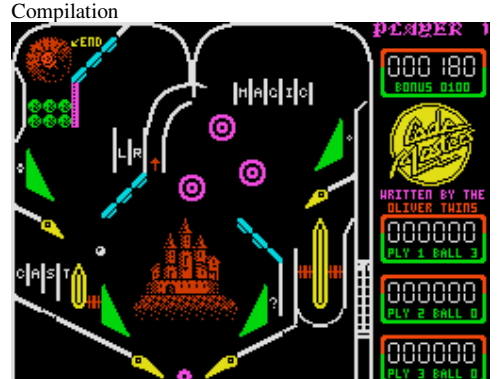

Christmas - New Year - Demo (Hooy-Program,1998)
Scene Demo

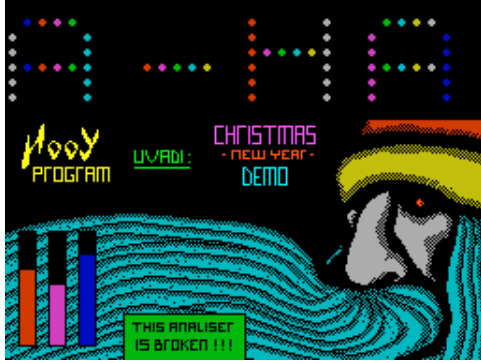

Chrobak Truhlik (Ultrasoft,1991)
Text Adventure



Chrysalis (Icon Software Ltd.)
Arcade



Chuckie Egg (A'n'F Software,1984)
Arcade

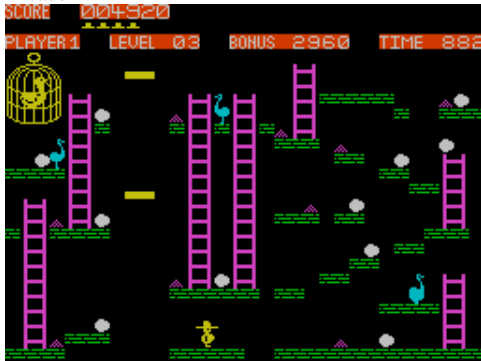

Chuckman (Custom Cables International Ltd,1983)
Arcade



Christmas Trivia Quiz, The (16/48 Tape Magazine,1986)
Simulation

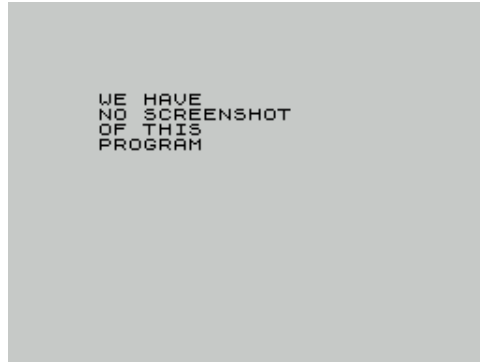

Chrom (MicroHobby,1985)
Utility: Font/UDGs



Chubby Gristle (Grandslam Entertainments Ltd,1988)
Arcade



Chuckie Egg 2 (A'n'F Software,1985)
Arcade



Chuck Yeager's Advanced Flight Trainer (Electronic Arts,1989) Arcade

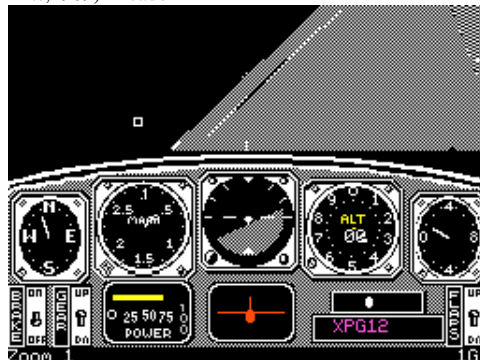

Christmas Tunes (Your Sinclair,1992)
Scene Demo

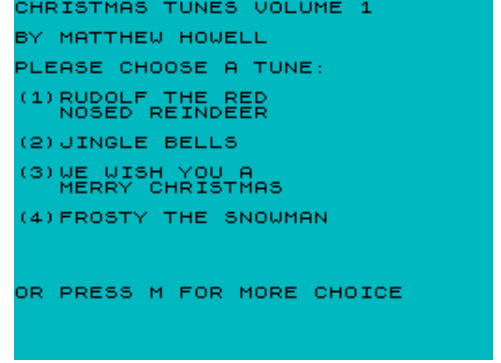

Chronos: A Tapestry of Time (Mastertronic Ltd,1987)
Arcade



Chuckie Designer (P&M Software,1984)
Arcade Game Development Tool



Chuckie Egg Editor (Mercury Software,1985)
Arcade Game Development Tool

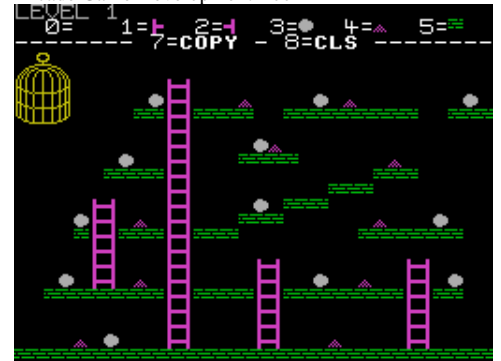

Church of Death (Sinclair User,1992)
Text Adventure



Cicibanova Abeceda (Davor Bonacic,1984)
Arcade

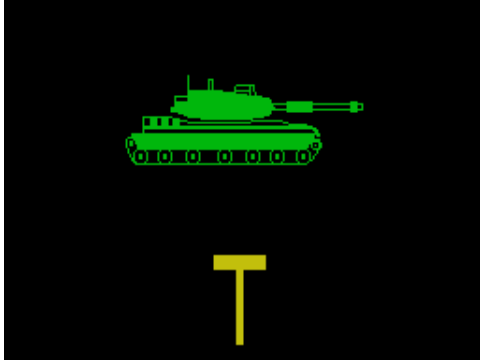

Cintas Locas (MicroHobby,1985)
Arcade

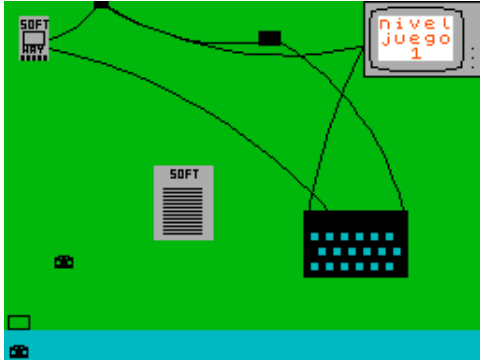

Circlelusions (Specky Boyz,1998)
Scene Demo



Circuit Diagrams (C. Grant Dixon,1988)

Utility
x=20 y=140

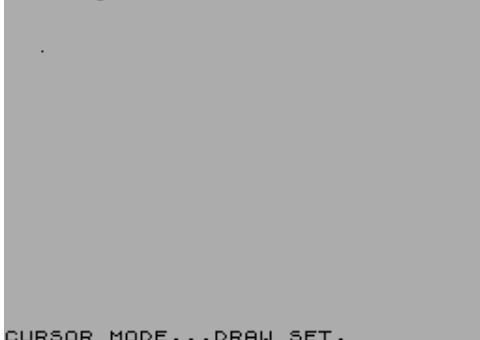

Circus (Digital Fantasia,1983)

Text Adventure
I'm by a maintenance wagon
Things I can see:
Door -
Exits: EAST

Roll up! Roll up!
The CIRCUS is in town!
WHAT NOW ?
WHAT NOW ? W
O.k.
WHAT NOW ? LOOK
I see
Nothing special
WHAT NOW ? NOS

Cid, El (Dro Soft,1988)
Arcade Adventure

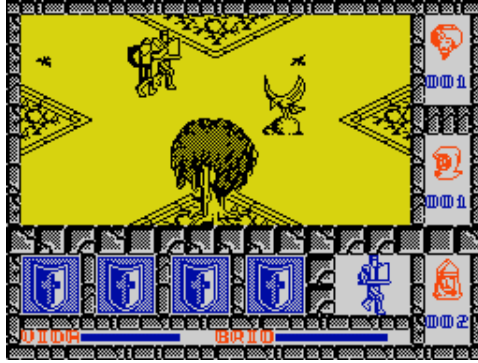

CIRC (Outlet Microdrive Magazine,1990)
Utility

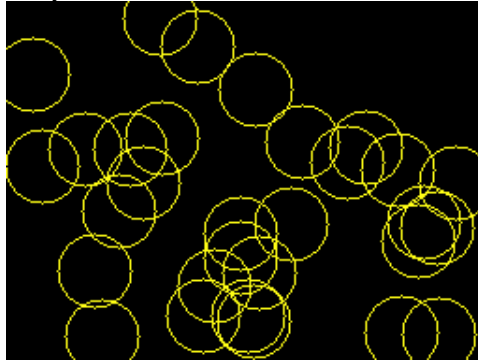

Circles (Sinclair User,1984)
Utility: BASIC Related

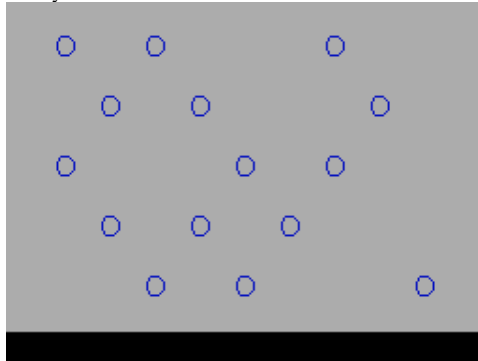

Circuitos Electricos [1] (MicroHobby,1985)

Utility: Electronics



Cimmerjan (Sindicato del Software,1993)
Text Adventure



Circle in the Sand (Coolguys Ltd.)
Scene Demo



Circles, The (Jacek Michalak,1991)
Scene Demo

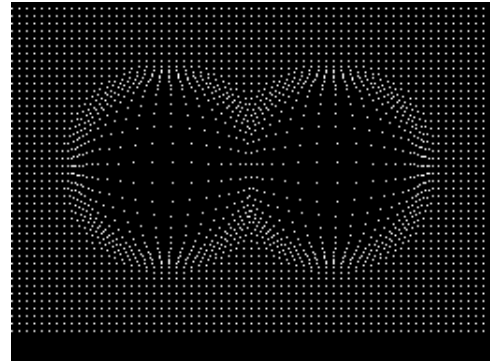

Circuitos Electricos [2] (MicroHobby,1985)

Utility: Electronics



Circus Circus (Martech Games Ltd,1989)

Arcade



Circus Games (Tynesoft,1988)
Arcade

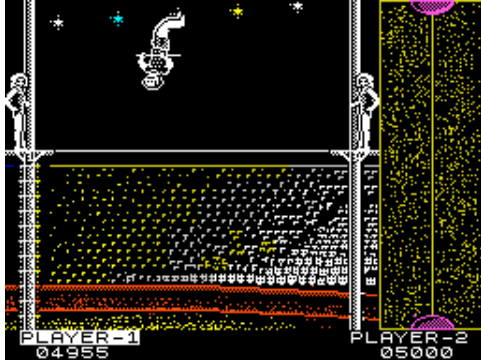

CIR-Demo 1 (CIR,1991)
Scene Demo

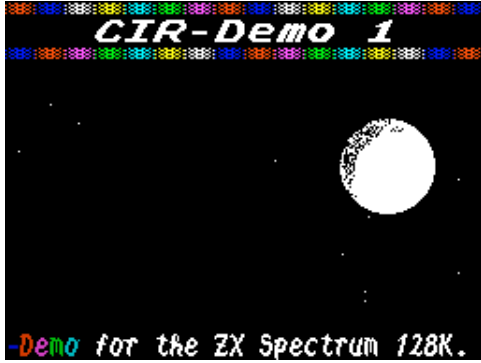

CIR-Demo IV (CIR,1991)
Scene Demo



Citadel (Stalker,1996)
Arcade

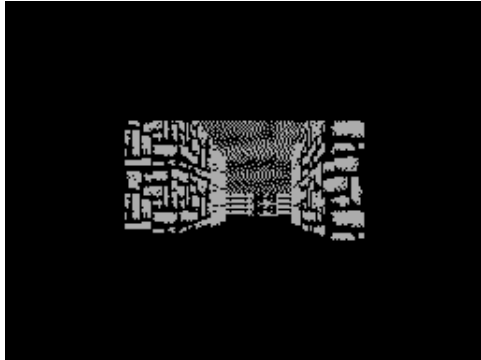

City (Terminal Software,1983)
Arcade

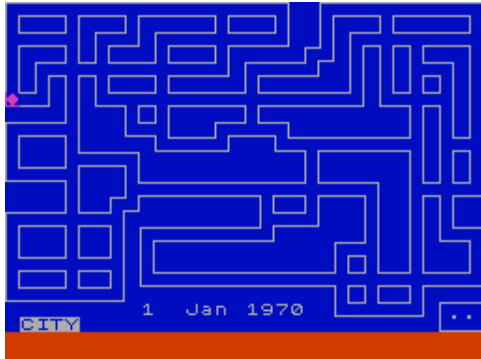

Circus, Le (16/48 Tape Magazine,1986)
Arcade



CIR-Demo 2 (CIR,1991)
Scene Demo

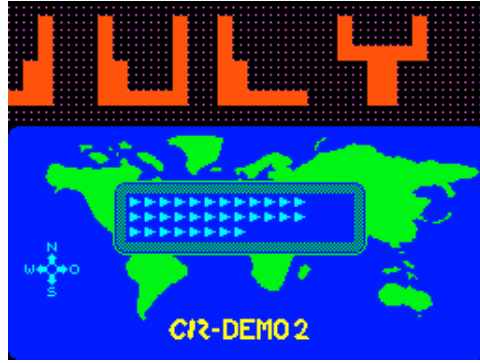

Cisco Heat (Image Works,1991)
Arcade



Citadel of Chaos, The (Puffin Books,1984)
Text Adventure



City-Bomb (H. Ziehms,1985)
Arcade

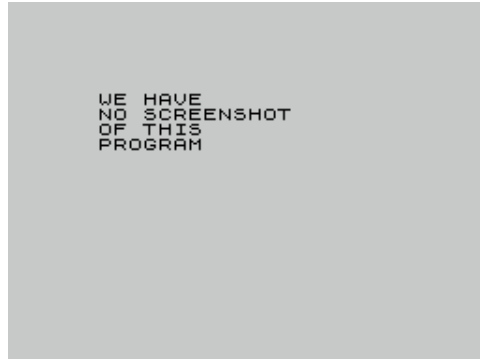

Circus Maximus (MC Lothlorien Ltd.)
Strategy



CIR-Demo III (CIR,1991)
Scene Demo

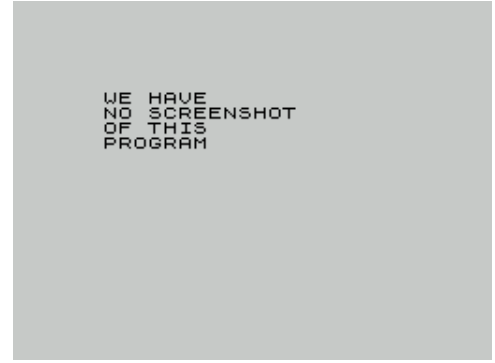

Citadel (Mike Dowman,1991)
Arcade

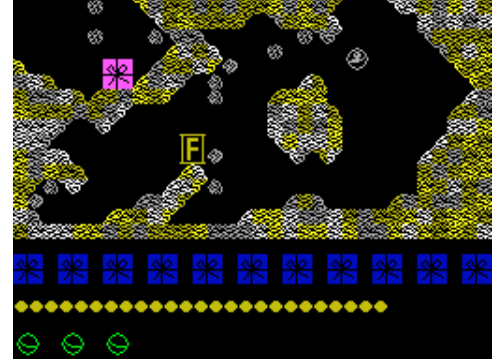

Citadel, The (Zenobi Software,1997)
Text Adventure



City Bomber (Anco Software Ltd,1983)
Arcade



City Bomber (C-Tech,1982)
Arcade



City Bomber (Llamasoft,1982)
Arcade



City Bomber (Sinclair Programs,1982)
Arcade



City Bomber (Stephen Smith,)
Arcade

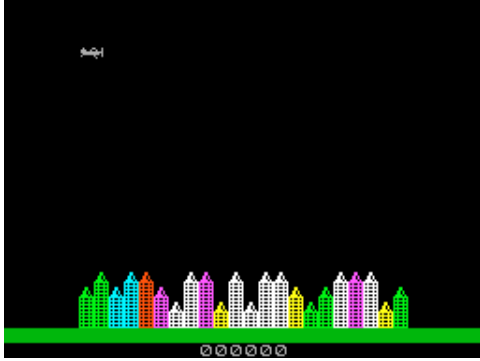

City Cobra (,1988)
Arcade



City Connection (Manuel Lemos,)
Arcade



City Defence (Hansesoft GmbH,1985)
Arcade



City Fighter (Choice Software Ltd,1984)
Arcade



City Lander (Sinclair User,1983)
Arcade

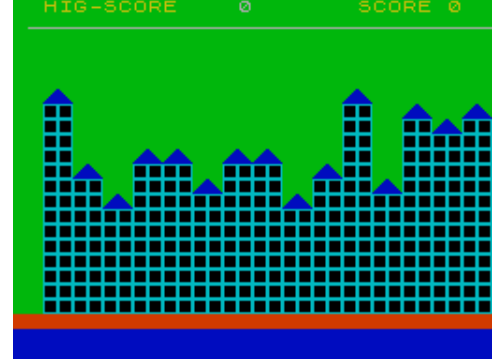

City of Death (Red Shift Ltd,1985)
Arcade



City of Ehdollah, The (Dorling Kindersley
Software,1984)

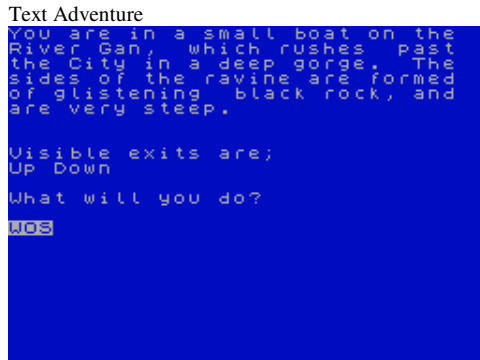

City Slicker (Hewson Consultants Ltd,1986)
Arcade

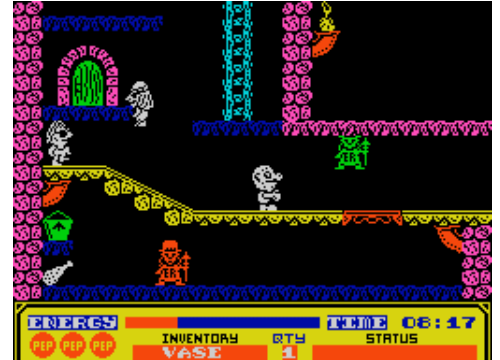

City, The (King Software,1984)
Arcade



Ciudadela (U.S.W.,1984)
Arcade

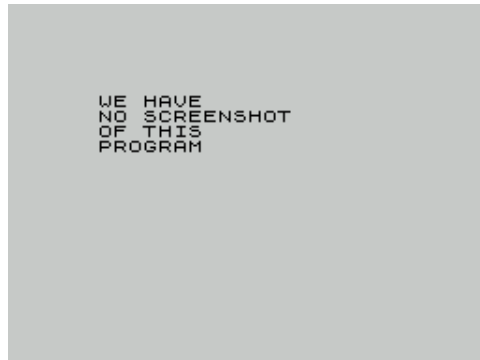

Civilization (Vitaly Kubeckin,1997)
Strategy



Civil Service (Zenobi Software,1994)
Text Adventure

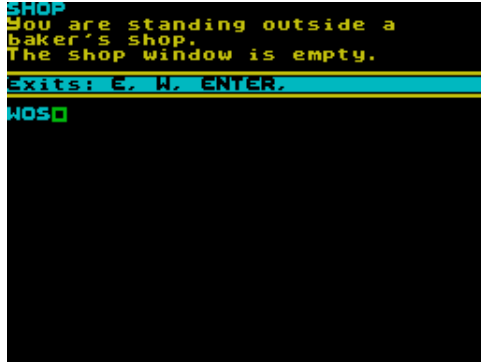

Civil Service II (Zenobi Software,1994)
Text Adventure

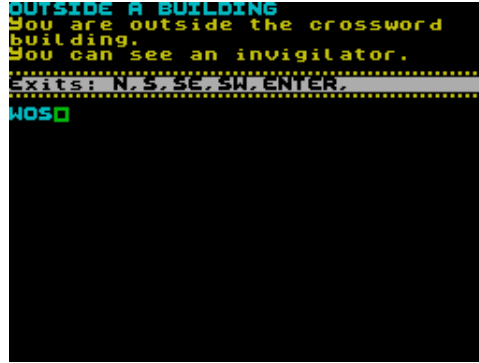

CJ in Space (Code Masters Ltd.)
Arcade

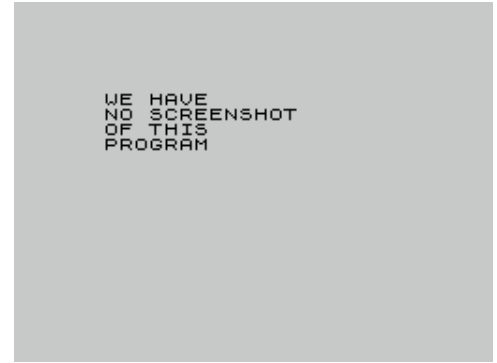

CJ in the USA (Code Masters Ltd,1991)
Arcade

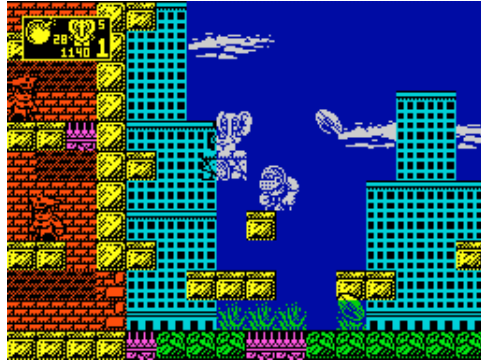

CJ's Elephant Antics (Code Masters Ltd,1991)
Arcade



Clash of the Princes - the Warlock'S (F & F Software,1986)
Text Adventure



Clash of the Princes - the Warrior W (F & F Software,1986)
Text Adventure

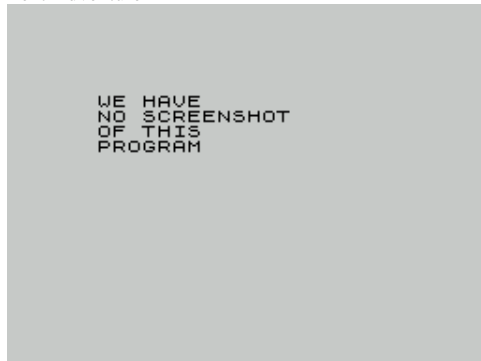

Class 50 Fleet Manager (Dee-Kay Systems.)
Simulation

Status report
(End of allocated working)

Loco	Dep	Fuel mls	Since A	exam B	Travl mls
500001	LA	0	0	170	0
500005	LA	0	0	113	0
500010	LA	135	30	199	0
500018	LA	0	0	184	0
500018	LA	305	44	102	0
500021	OC	135	39	97	0
500024	OC	305	16	2037	0
500027	LA	80	47	2005	0
500032	OC	0	7	600	0
500033	OC	0	52	1400	0
500037	OC	0	0	2100	0
500040	OC	305	11	600	0
500042	LA	0	27	2400	0
500050	LA	0	2	0	0
500050	LA	100	4	160	0

Press enter L

Class 50 Rover (Dee-Kay Systems,1988)
Simulation

MON 0517

MILEAGE : 0 POSITION
POINTS : 0 PLYMOUTH
CLASS 50s USED TO DATE: 0

NEXT TRAIN: 0610
0005 1C02 PADDINGTON-PENZANCE

INFORMATION

Loco	Reported At	Time	Duration
5000021	AT SY	-	01:05HRS
5000041	AT RG	-	04:00HRS
5000015	AT OC	-	02:20HRS
5000015	AT OC	-	01:15HRS
5000015	AT OC	-	00:15HRS
5000021	AT OC	-	04:00HRS
5000021	AT LA	-	05:00HRS
500011	REPORTED AT LA	-	05:10HRS

Classic Arcadia (Alternative Software Ltd,1990)
Compilation



Classic Arcadia 2 (Alternative Software Ltd,1992)
Compilation

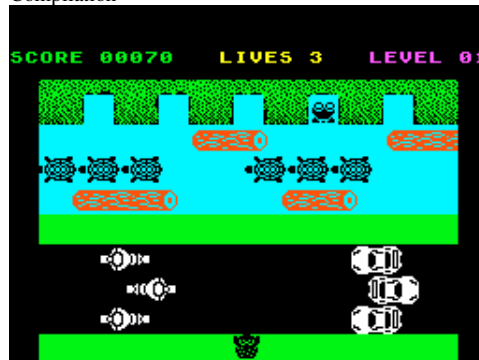

Classic Arcadia 3 (Alternative Software Ltd,1992)
Compilation

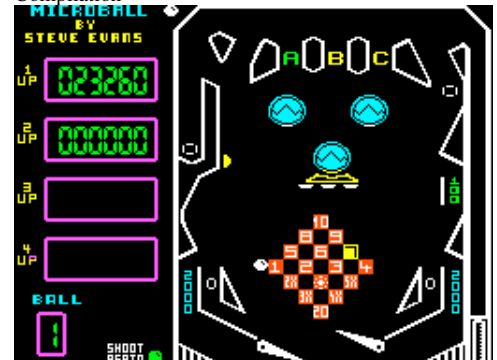

Classic Axien (Bubblebus Software,1988)
Arcade



Classic Bookkeeping (Manx Tapes,1985)
Utility



Classic Collection 1 (Mikro-Gen Ltd,1987)
Compilation

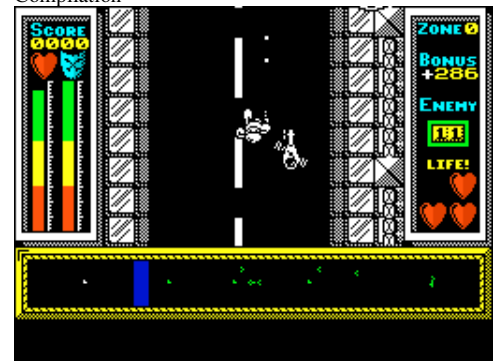

Classic Games 1 (System 4,1990)



Classic Invaders (Alternative Software Ltd,1990)
Arcade



Classic Punter (GTI Software,1989)
Simulation



Classic Trainer II (GTI Software,1990)
Simulation



Claws of Despair, The (Players Software,1986)

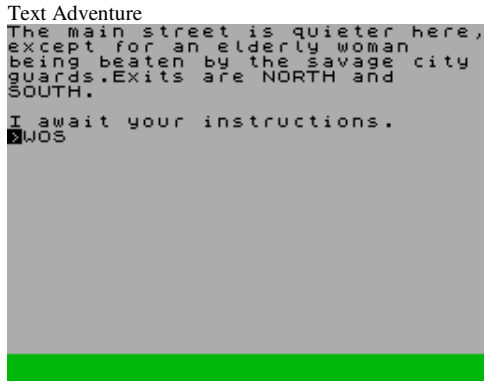

Classic Games 2 (System 4,1990)

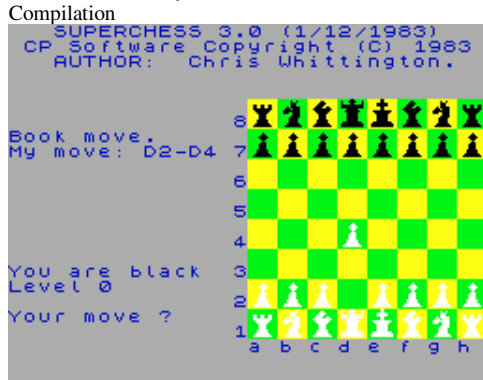

Classic Muncher (Bubblebus Software,1987)
Arcade



Classic Racing (Lambourne Games,1993)
Strategy



Classix 1 (The Edge Software,1987)
Compilation

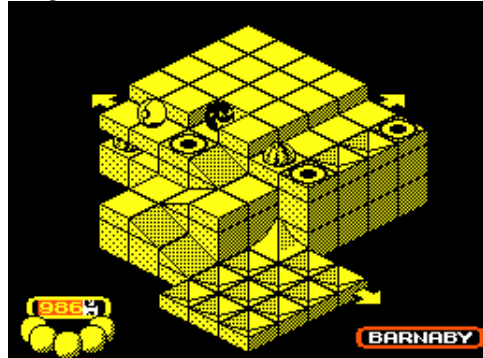

Clef (Hacker Chris,1989)
Scene Demo

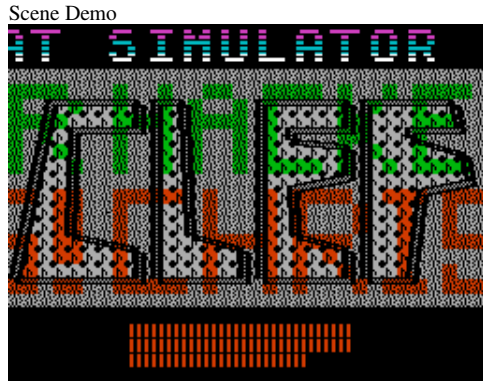

Classic Games 4 (CP Software,1989)

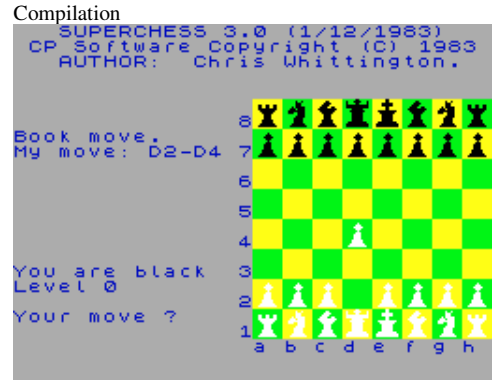

Classic Pattern Writer (Terry Mason,1987)
Utility



Classic Trainer (GTI Software,1989)
Simulation



Classroom Chaos (Central Solutions,1986)
Text Adventure

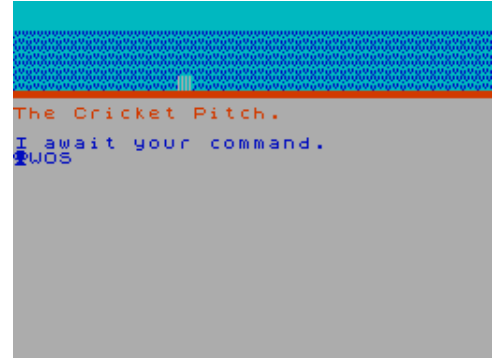

Clerics Quest (Global Games [1],1989)

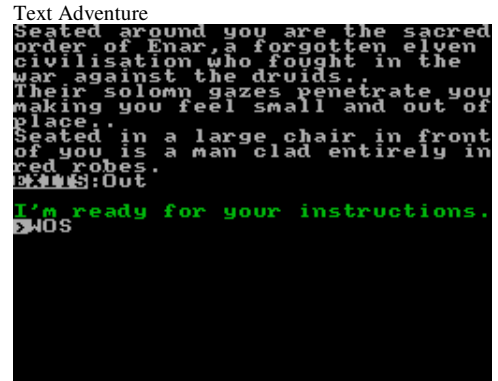

Clerky (Unique,1984)
Arcade

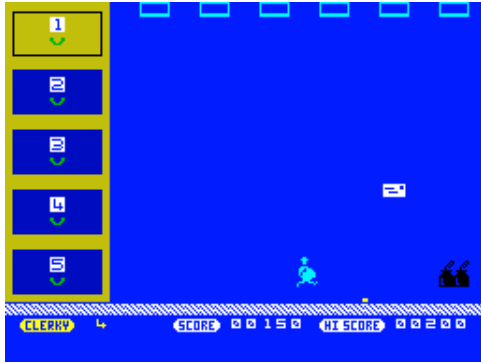

Clever Clogs - Blockbuster (Computer Tutor,1984)
Educational

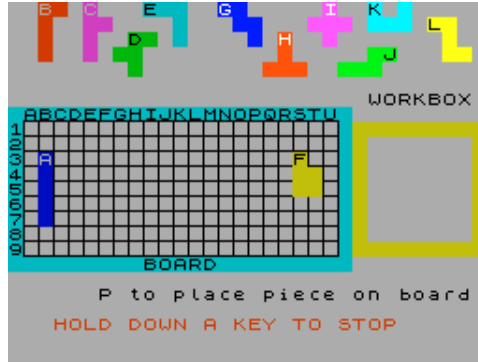

Clever Clogs - General Knowledge (Computer Tutor,1984)
Educational



Clever Clogs - History Mystery (Computer Tutor,1985)
Educational



Clever Clogs - Jungle Jumble (Computer Tutor,1983)
Educational



Clever Clogs - Melody Maker (Computer Tutor,1984)
Educational



Clever Clogs - Music (Computer Tutor,1985)
Educational



Clever Clogs - Party-Time (Computer Tutor,1983)
Educational



Clever Clogs - Sam Safety (Computer Tutor,1984)
Educational



Clever Clogs - Science (Computer Tutor,1985)
Educational



Clever Clogs - Shipshapes (Computer Tutor,1984)
Educational



Clever Clogs - Star Trucker (Computer Tutor,1984)
Educational

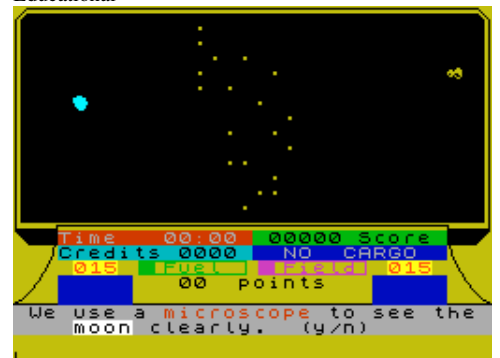

Clever Clogs - Supplementary Knowledge Pack (Computer Tutor,1984) Educational



Clever Clogs - The Arts (Computer Tutor,1984)
Educational



Clever Clogs - Whizz Quiz (Computer Tutor,1984)
Educational

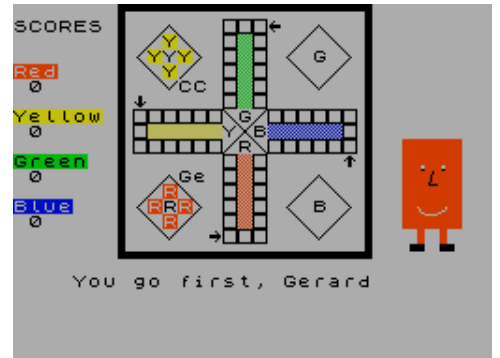

Clever & Smart (Magic Bytes,1988)
Arcade Adventure

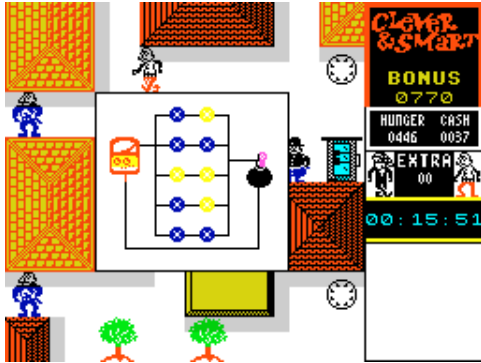

Cliff Hanger (New Generation Software,1986)
Arcade

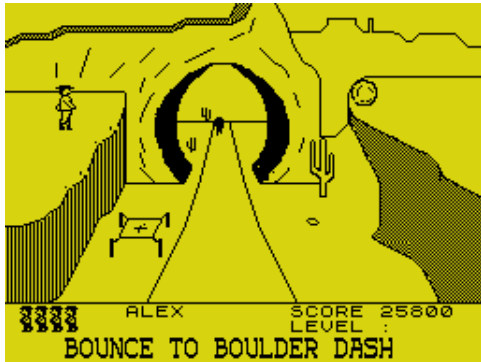

Clive Wink (Half Eaten - Warm Circuit,2003)
Utility



Clock Chess '89 (CP Software,1989)
Board/Card Game



Clone-it (ASP Software Ltd,1983)
Utility: Copier

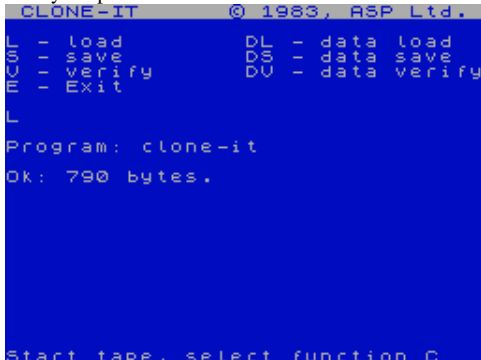

Clickmania (Optical Brothers,1999)
Board/Card Game



Clive Copier (Andrew Pennell,1983)
Utility: Copier



Clobber Castle (Sinclair Programs,1983)
Arcade

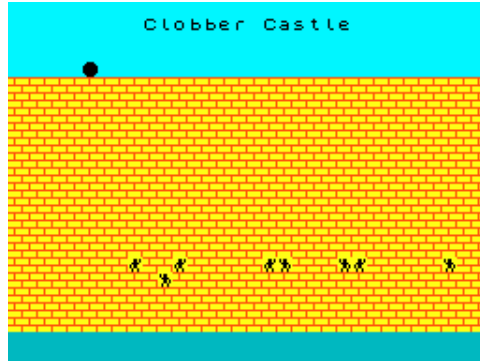

Clock Man (Sinclair Programs,1982)
Arcade

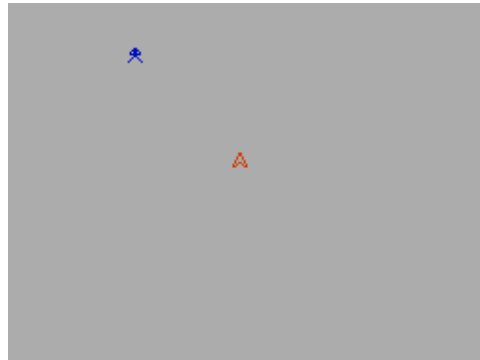

Clone, The (Your Computer,1984)
Utility: Copier

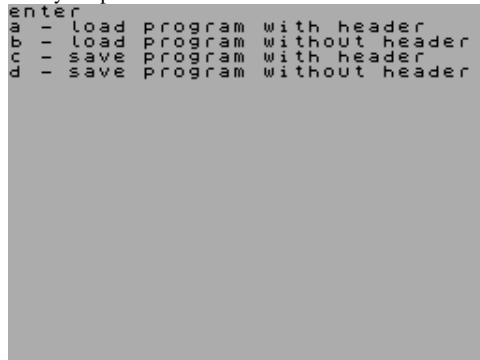

Cliff Demo (Cliffy T,1995)
Scene Demo



Clive in Exile (Illusion Software,1986)
Arcade



Clock (INPUT,)

Utility: Assembler/Disassembler/Monitor

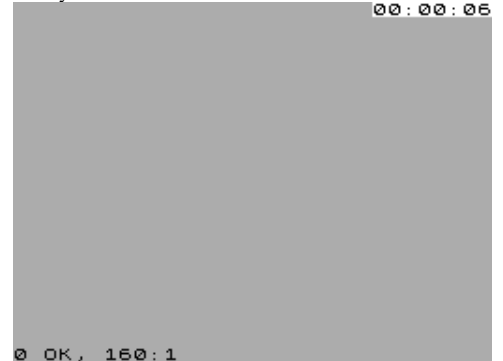

Clocks Head Cracker (Omega Hackers
Group/Partizans,1999)
Board/Card Game

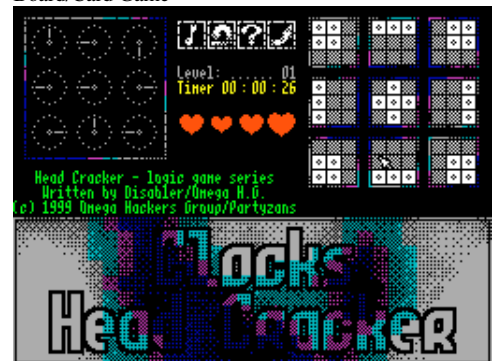

Close-In (Pulsonic,1983)
Arcade

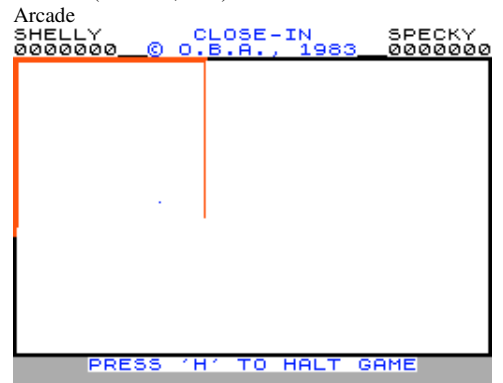

Clot 4K (Image Crew,1998)
Scene Demo

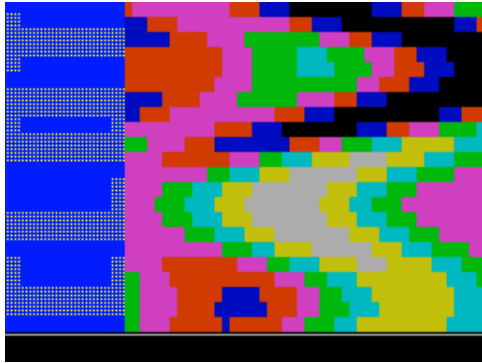

Clown (Englefield Software,1985)
Educational



Clues'o' (Imperial Software,1985)
Text Adventure



Cobble 2 (V. Cheprasov,1999)
Board/Card Game



Cobra's Arc (Dinamic Software,1986)
Text Adventure



Cloud 99 (Marlin Games,1988)
Text Adventure



Club Record Controller (Sinclair Research Ltd,1982)
Utility: Database

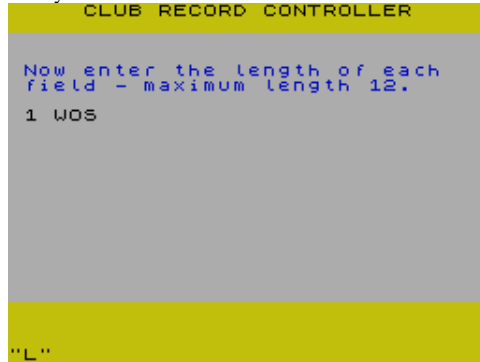

Clutches of the Balrog (.)
Text Adventure



Cobra (Ocean Software Ltd,1986)
Arcade



Coches Locos, Los (MicroHobby,1984)
Arcade

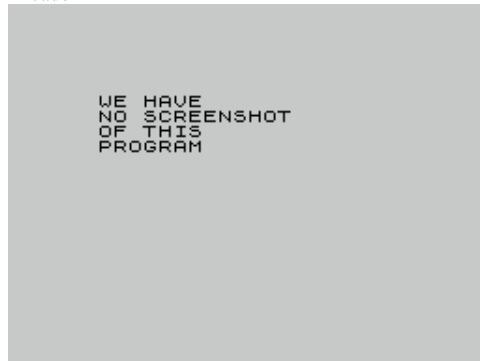

Clovek (Noro Hard&Soft,1991)
Scene Demo



Cluedo (Leisure Genius,1985)
Board/Card Game



Coal Collector (Sinclair Programs,1984)
Text Adventure



Cobra Force (Players Premier Software,1989)
Arcade



Cock Attack (Rikta Software,1985)
Arcade

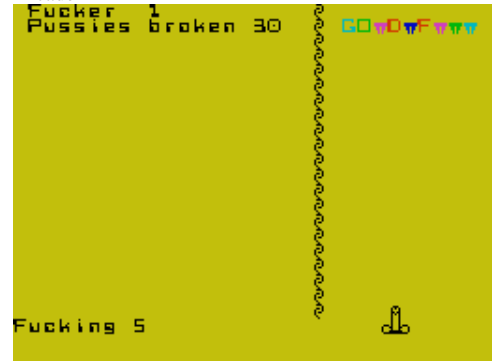

Cockshaw Demo (Theo Devil,)
Scene Demo



Codebook Caper (Scorpio Gamesworld,1984)
Text Adventure



Codebreaker (Spectrum Computing,1985)
Arcade



Code Compressor 1 (Lerm Software,1986)
Utility

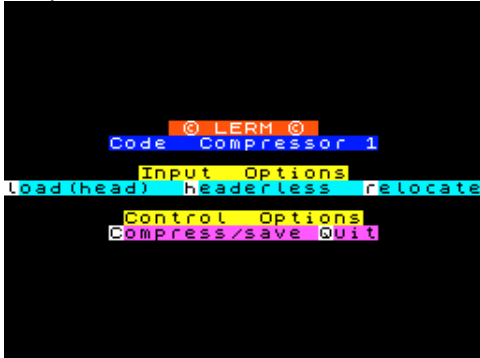

Code Machine, The (Discovery Software,1986)
Compilation

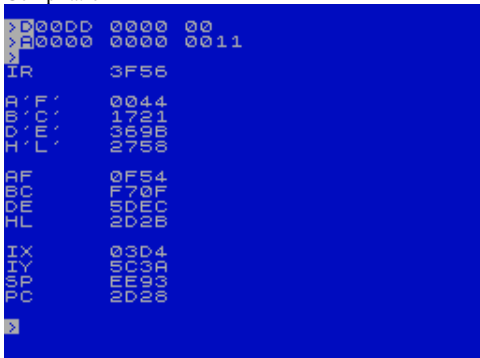

Coco-nut (Purple Studios,2006)
Arcade



Code Breaker (D. McLellan,1983)
Board/Card Game

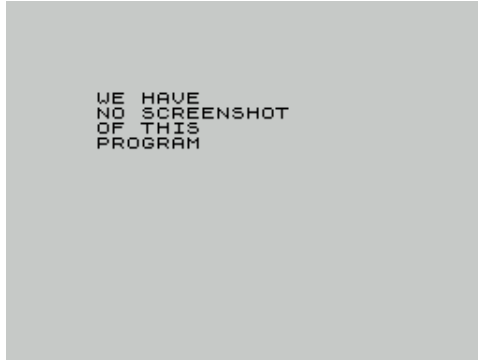

Codebreaker (WB Software,1983)
Arcade

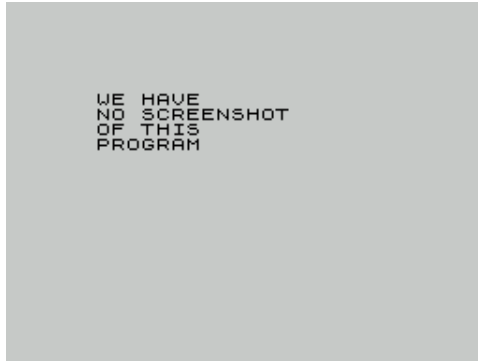

Code Investigator (Kobrahsft,)
Utility



Codemaster (Viking Software,)
Arcade



Coconuts (Sinclair Programs,1984)
Arcade



Codebreaker (Shiva Publishing Ltd,1983)
Utility



CodeBreker (Richard Lander,1989)
Board/Card Game

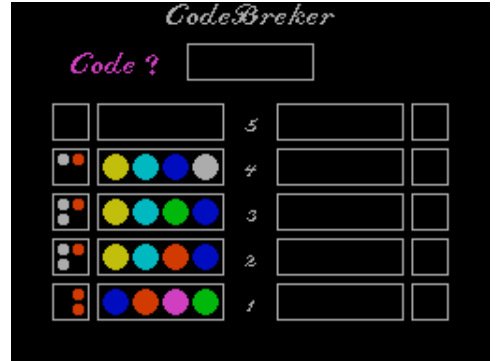

Code Machine 2068 (Andrew Dansby,1987)
Utility

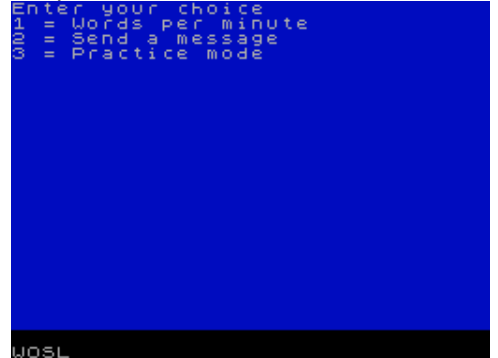

Codename Mat (Micromega,1984)
Arcade



Codename Mat II (Domark Ltd,1984)
Arcade



Code Slicer 2 (Foraits Software,1985)
Utility



Codigo Secreto Lucybel: Cryogenic (Josep Coletas Caubet,2005) Text Adventure

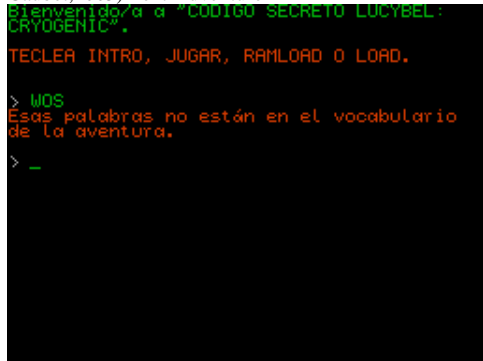

Cofre Magico, El (MicroHobby,1985)
Arcade



Coin-Op Connexion (US Gold Ltd,1987)
Compilation



Codesect 1.1 (MicroHobby,1985)
Utility: BASIC Related



Code, The (Soft Concern Ltd,1984)
Text Adventure

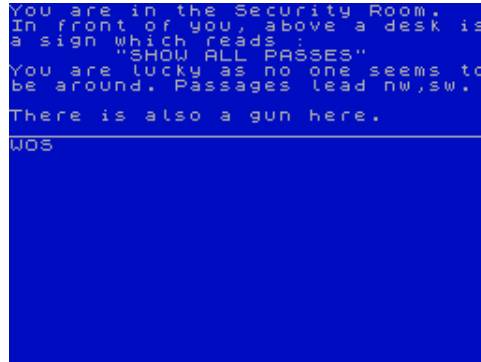

Codigo Secreto Lucybel: Evolution (Josep Coletas Caubet,2007) Text Adventure



Coingame (Ceran Software,)
Board/Card Game



Coin-Op Hits (US Gold Ltd,1990)
Compilation



Code Slicer (Foraits Software,1985)
Utility: Copier

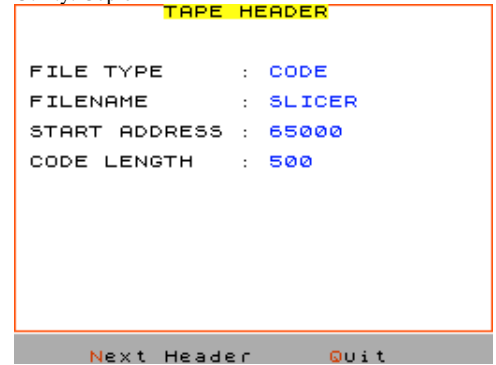

Codigo Secreto Lucybel: Apocalypse (Josep Coletas Caubet,2007) Text Adventure

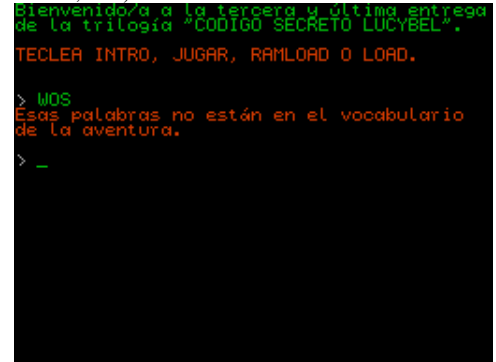

Codigo Secreto Lucybel: TRILOGY (Josep Coletas Caubet,2007) Compilation

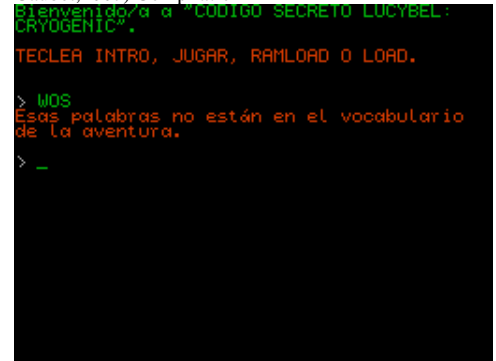

Coin It (J. Lydon,1986)
Simulation



Coin-Op Hits II (US Gold Ltd,1991)
Compilation



Colditz Castle (Phipps Associates,1983)

Text Adventure

This is the Chapel of Rest.
 There are some old worn stone steps by the eastern wall.
 A rope hangs down from the roof where it disappears into a dark attic high above my head.
 Passages lead east and down.

There is also:
 - A Holy candle
 What shall I do now?

WOSC

Coleccion de Exitos Dinamic (Dinamic Software,1988)
Compilation

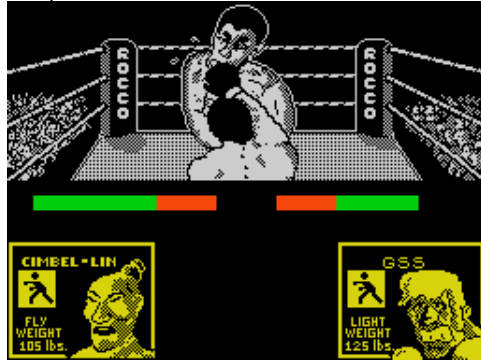

Colin the Cleaner + Big Ben Strikes Again (Tynesoft,1987)
Compilation



Collected Works (The Lords,1989)

Scene Demo



Colliery, The (5D Software,1984)

Arcade



Colditz Escape (PsychoSoft,1985)

Arcade

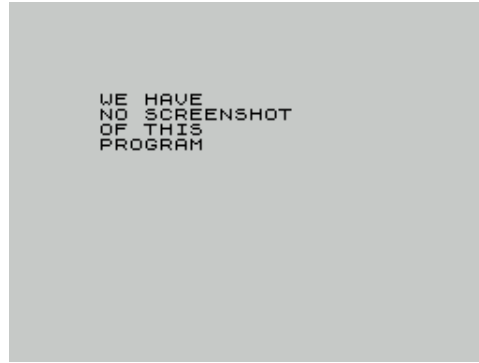

Coleccion Dinamic-90 (Dinamic Software,)

Compilation



Colin the Cleaner + Who Said That? (Tynesoft,1987)

Compilation



Collector's Pack (Sinclair Research Ltd,1982)

Utility: Database

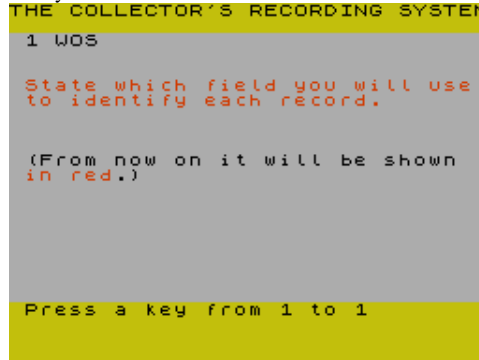

Collision Course (Sinclair User,1987)

Arcade

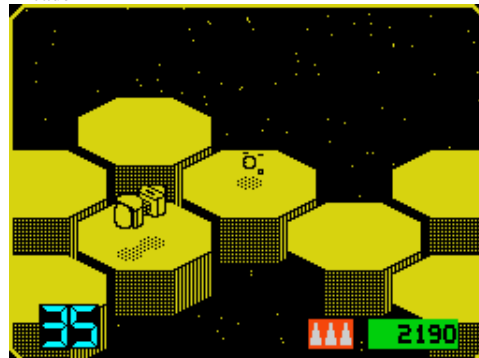

Colditz Story, The (Atlantis Software Ltd,1987)

Arcade Adventure

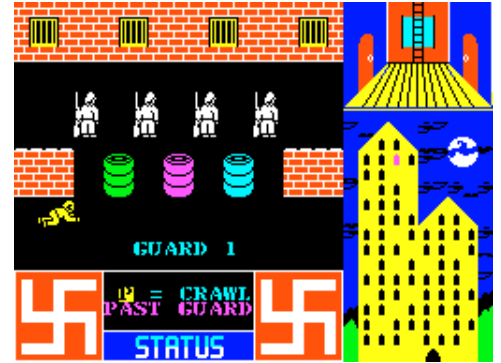

Colin the Cleaner (Tynesoft,1987)

Arcade



Coliseum (Topo Soft,1988)

Arcade

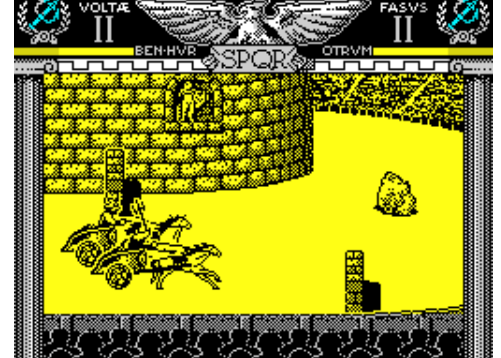

Colliery + The Scrapyard, The (5D Software,1984)

Compilation



Collwobbles (H. Ziehms,1985)

Text Adventure



Collywobbles (Pirate Software Ltd,1987)
Arcade

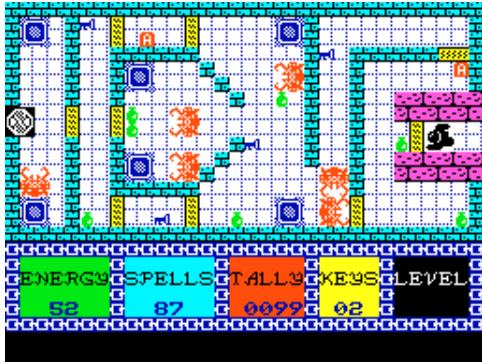

Colony (Softek Software International Ltd,1982)
Board/Card Game



Coloris (WoMo-Team,1990)
Arcade

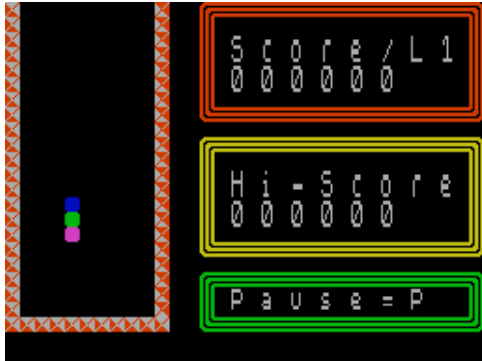

Color Lines (Grepan,1994)
Board/Card Game

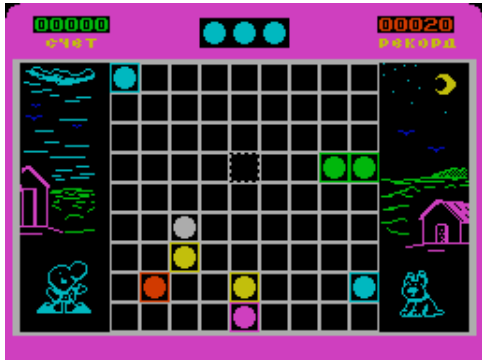

Color Lines (Virtual Reality,1995)
Board/Card Game

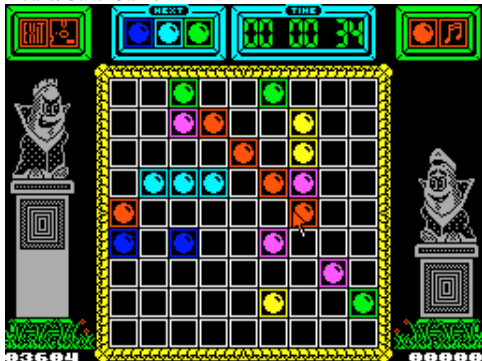

Colon 1492 (Imperial Soft,1992)
Text Adventure



Colorado Bill (,1987)
Arcade



Color Lines (.)
Board/Card Game

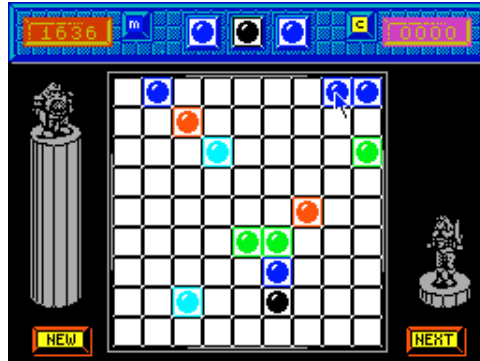

Color Lines (Random Science Crew,1995)
Board/Card Game

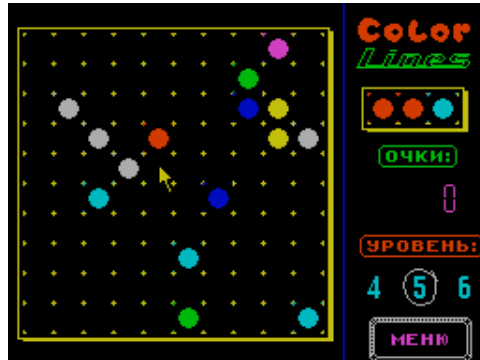

Color Lines 2 (Entire Group,1996)
Arcade

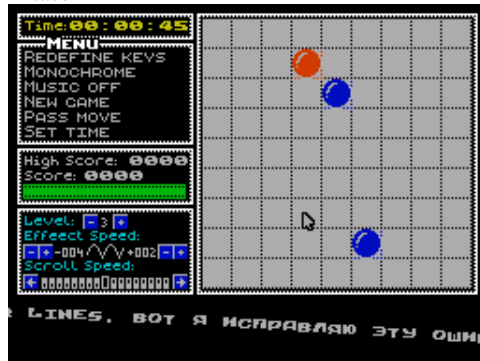

Colony (Bulldog,1987)
Arcade



Color Draw (Ultrasoft/Sintech,1995)
Utility: Drawing



Color Lines (Computer Work Company,1996)
Arcade



Color Lines (Surdakar Group,1994)
Arcade



Color Lines 2 (Yurochka,1997)
Arcade

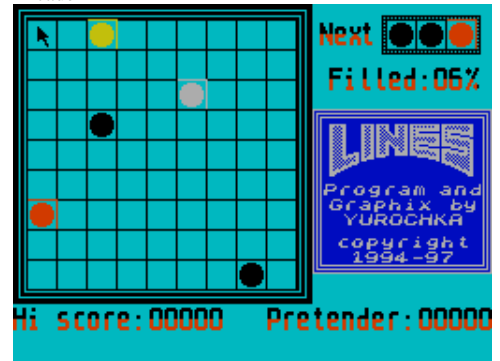

Color Tower (Dimik Soft/SSA,1997)
Board/Card Game

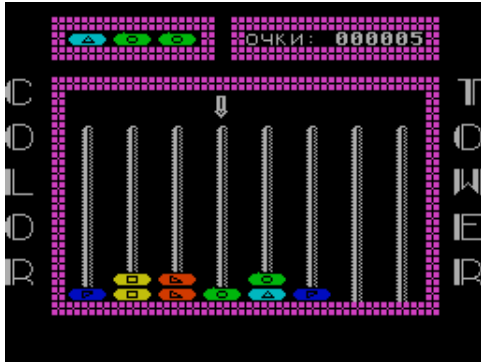

Colossus 4 Bridge (CDS Microsystems,1986)
Board/Card Game



Colour Clash (Romik Software,1983)
Arcade

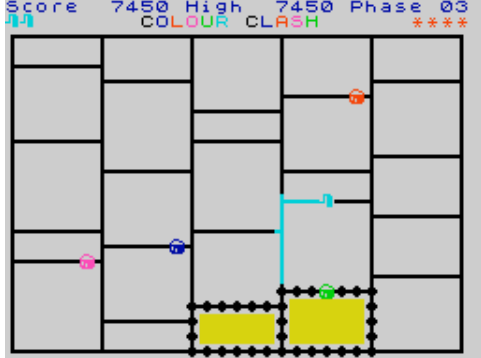

Colour Mixer (Sinclair Programs,1983)
Utility: Screen Manipulation

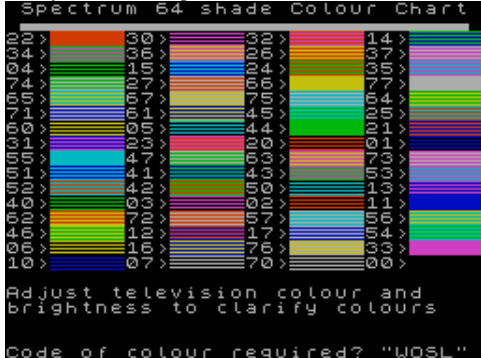

Colourthello 02 (.)
Board/Card Game

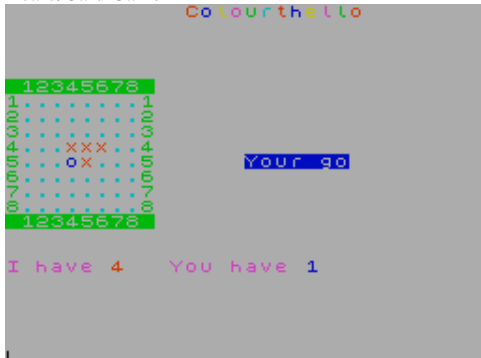

Colossal Adventure (Level 9 Computing Ltd,1983)
Text Adventure

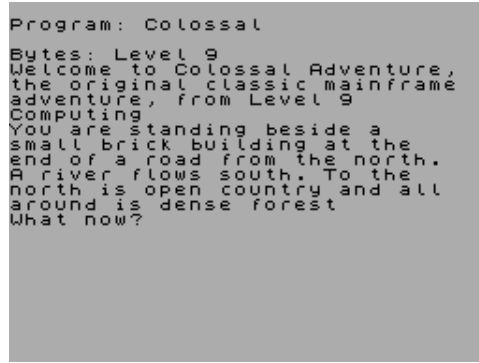

Colossus 4 Chess (CDS Microsystems,1986)
Board/Card Game



Colourcross (Laszlo Nyitrai,2003)
Board/Card Game



Colour of Magic, The (Piranha,1986)
Text Adventure



Columns (Computer Emuzone,2005)
Arcade



Colossal Cave Adventure (Anubis Software,1985)
Text Adventure

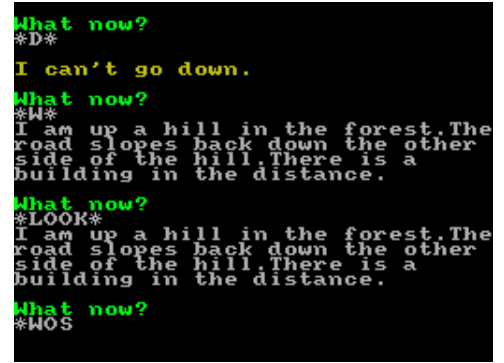

Colourbind (Daton Software,1989)
Strategy



Colour Master (16/48 Tape Magazine,1984)
Utility



Colourthello (ZX Computing,1982)
Board/Card Game



Columns (Piter Ltd,1991)
Board/Card Game

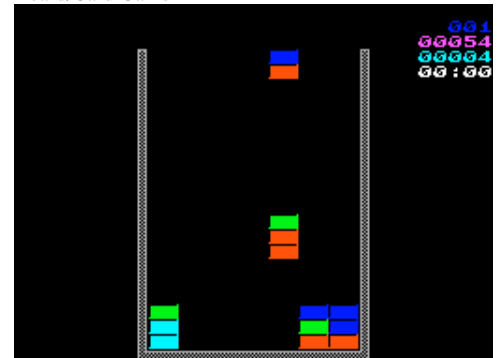

Comal 1.00 (FK. Soft,1984)
Utility: BASIC Related
hello

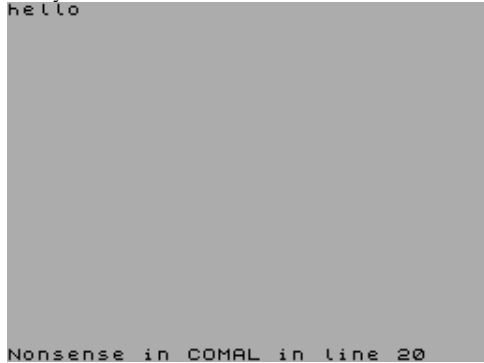

Nonsense in COMAL in line 20
Comando Tracer (Dinamic Software,1989)
Arcade



Combat School (Ocean Software Ltd,1987)
Arcade

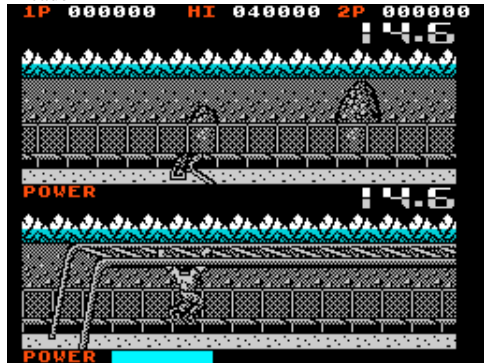

Combiloto (Software Editores,1986)
Board/Card Game



Combinatoria [2] (MicroHobby,1986)
Educational



Comal 2.0 (J.J. Computing,1985)
Utility: BASIC Related



Combat Lynx (Durell Software Ltd,1984)
Simulation

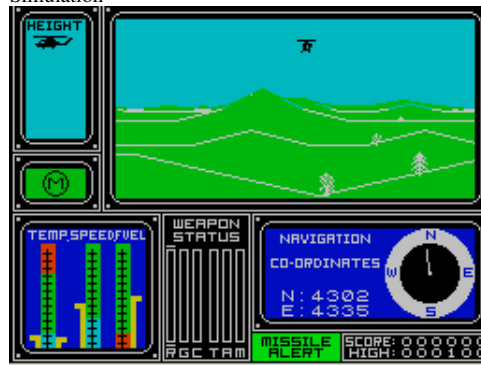

Combat Zone (Alternative Software Ltd,1988)
Arcade

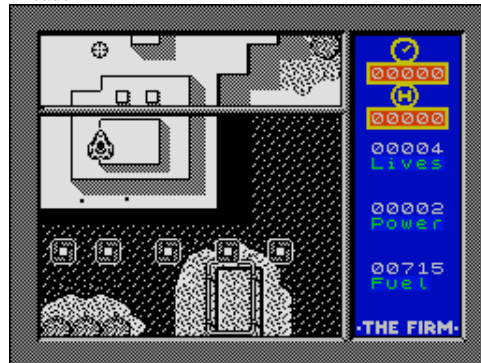

Combinatoria (MicroHobby,1985)
Utility



Combinatoria [3] (MicroHobby,1986)
Educational



Comando Quatro (Zigurat Software,1989)
Arcade

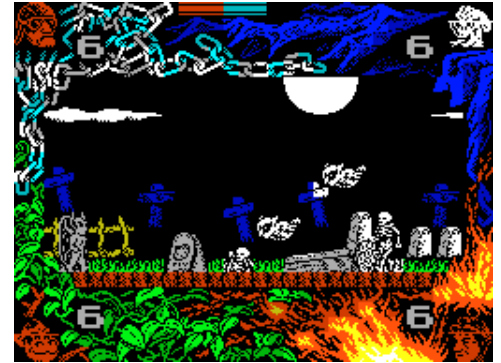

Combat - Pack 3 (Zeppelin Games Ltd,1992)
Compilation



Combat Zone, 3D (Artic Computing Ltd,1983)
Arcade

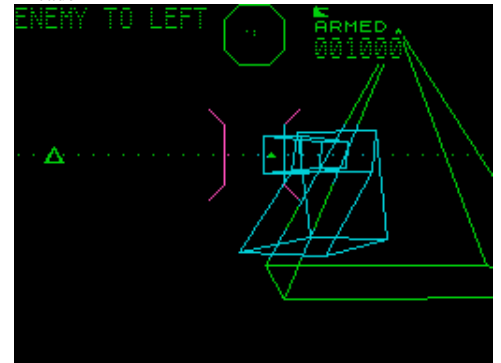

Combinatoria [1] (MicroHobby,1986)
Educational



Comecocos (Microparadise Software,1984)
Arcade



Comecocos + Froggy (Indescomp S.A.)

Compilation

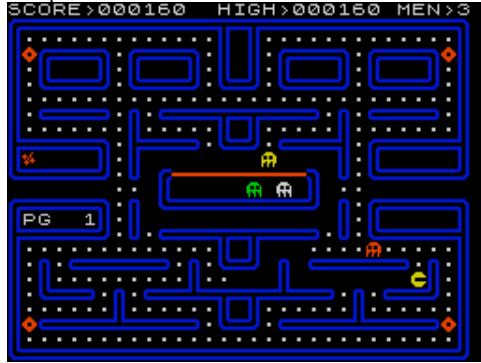

Come Estrellas (MicroHobby,1985)

Arcade



Comet Encounter (Live-Wire Software,1986)

Arcade



Comic, Arcade & Aventura (Dro Soft,)

Compilation



Comipini (,)

Arcade

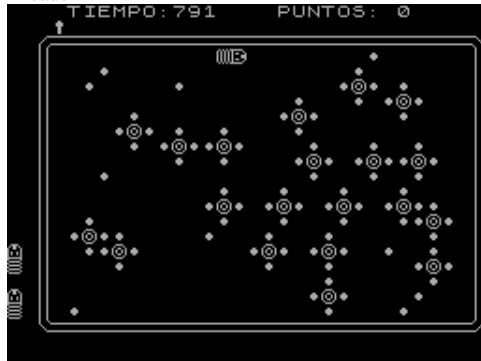

Comecocos 3D (MicroHobby,1989)

Arcade



Comeme (MicroHobby,1986)

Arcade



Comet Game, The (Firebird Software Ltd,1986)

Arcade

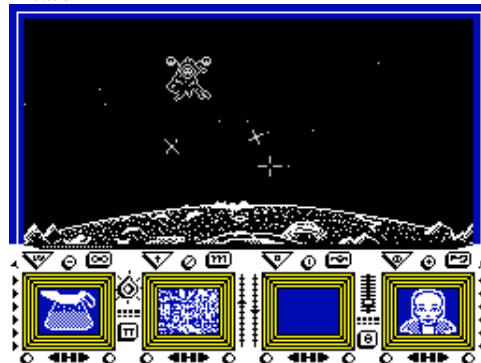

Comic Bakery (Imagine Software Ltd,)

Arcade



Commando (Double Play Adventures,1984)

Text Adventure

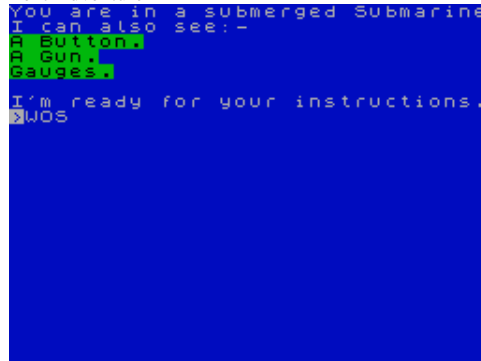

Comecoquitos (MicroHobby,1985)

Arcade

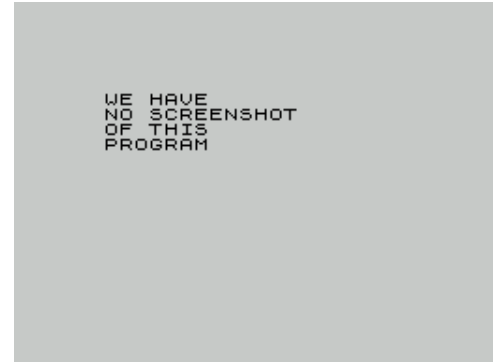

Cometa Halley (Ediciones y Textos S.A.,1985)

Educational



Comets (MacDonald,1986)

Compilation



Comilon (Microparadise Software,1984)

Arcade

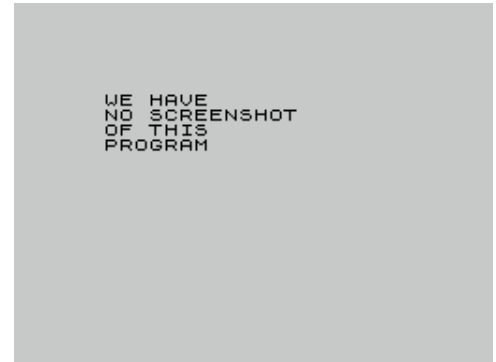

Commando (Elite Systems Ltd,1985)

Arcade



Commando (Loricels,1984)
Arcade Adventure



Command Performance (US Gold Ltd,1989)
Compilation

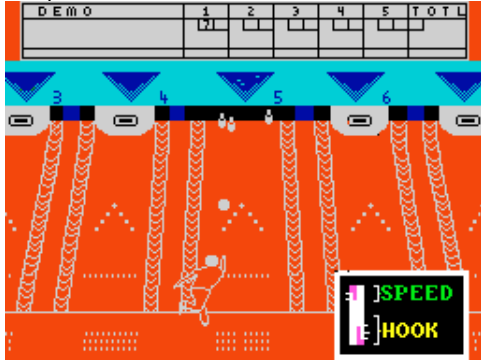

Como se Construye un Programa Comercial III (MicroHobby,1986) Educational



Compact Office (Robtek,1986)
Compilation



Compendium (Dymond Software,1983)
Compilation



Commando + Scooby Doo (Elite Systems Ltd,1989)
Compilation



Commercial Accounts Program (Gemini Marketing Ltd,1982)
Utility: Spreadsheet

VAT OUTPUT SUMMARY

No.	Amount	VAT	Total
1	86.96	13.04	100.00
5	17.38	2.61	19.99

VAT Total - 15.65
Any key for main menu

Como Usar los Colores y los Graficos en el Spectrum (Paraninfo Soft S.A.,1984) Compilation



Compass Collection 1 (Compass Software,1992)
Compilation



Compendium (Gremlin Graphics Software Ltd,1987)
Compilation

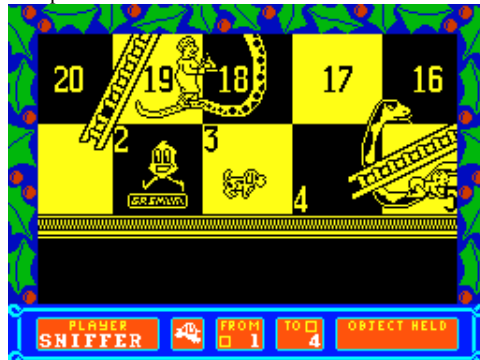

Commando Jump (Granada Publishing,1983)
Arcade

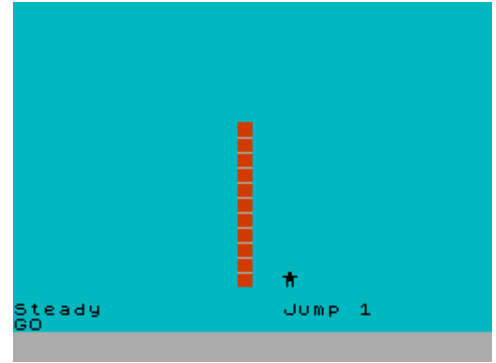

Como la Vida Misma (O Parecido) (Burga's Adventure,1990)
Text Adventure



Compact (Your Computer,1985)
Utility: BASIC Related

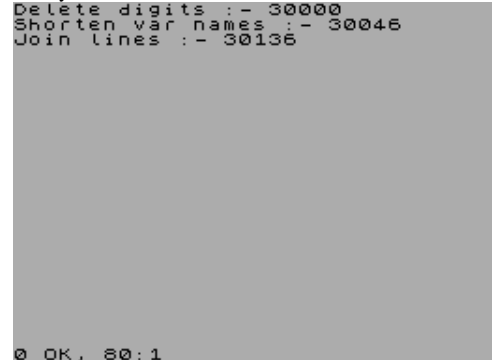

Compass Collection 2 (Compass Software,1992)
Compilation

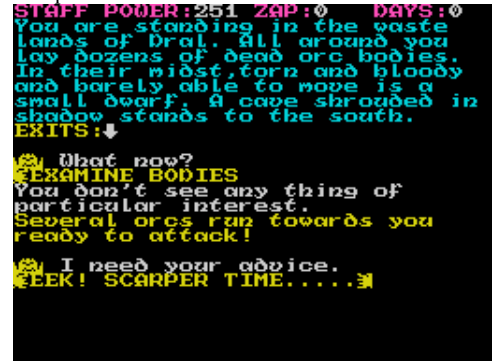

Compilador de Textos (MicroHobby,1985)
Utility



Compiler (A. Mehmood,1985)
Utility: Programming



Complete Home Entertainment Centre, The (CDS Microsystems,1988) Compilation



Complete Machine Code Tutor, The (New Generation Software,1984) Utility:
Assembler/Disassembler/Monitor

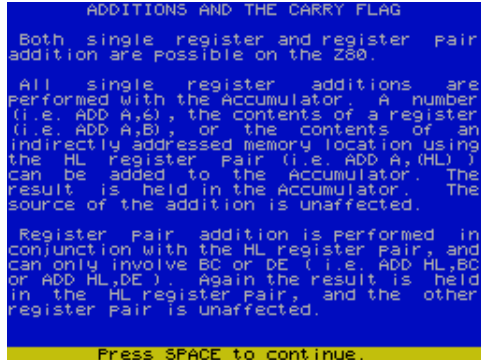

Composer (William Stuart Systems Ltd,1982)
Utility

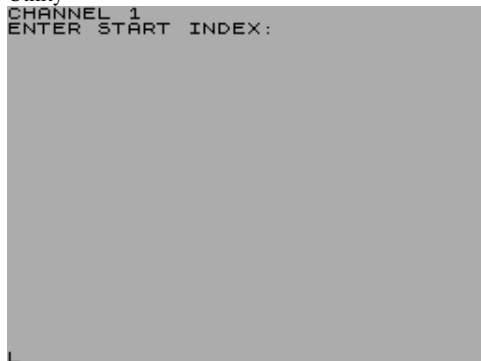

Compress Copy (Dinosoft,1988)
Utility: Copier



Complete Guide to Medicine, The (Eastmead Computer Systems,1984) Educational

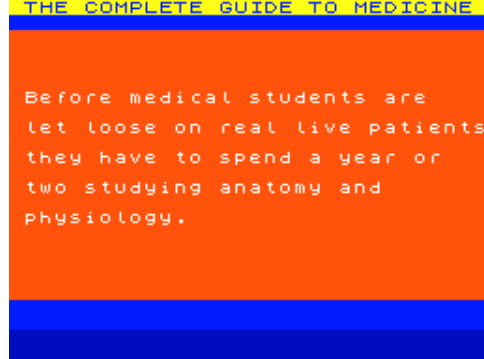

Complete Machine Code Package (Roybot,1987)
Utility: Assembler/Disassembler/Monitor



Composer (.)

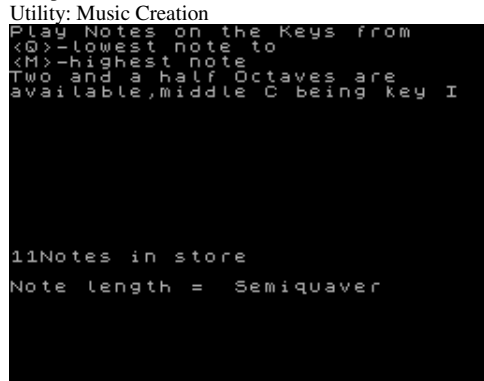

Compresor de Pantallas (MicroHobby,1985)
Utility



Compuchord (Tectrics,1987)
Utility



Complete Home Entertainment Centre 128K, The (CDS Microsystems,1988) Compilation



Complete Machine Code Programmer, The (Softtek Software International Ltd,1983) Utility: Programming



Composer (Contrast Software,1984)
Utility

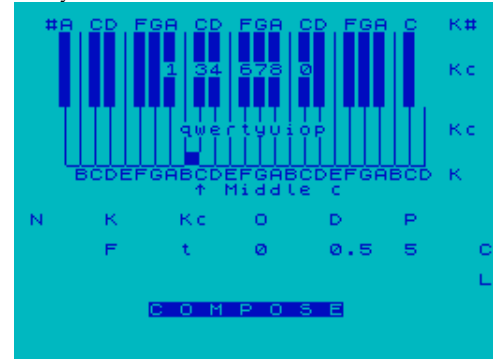

Compresor de Programas (MicroHobby,1986)
Utility



Compufile (Jaysoft,1983)
Utility



Comp-U-Share (Micromega,1983)
Utility: Database

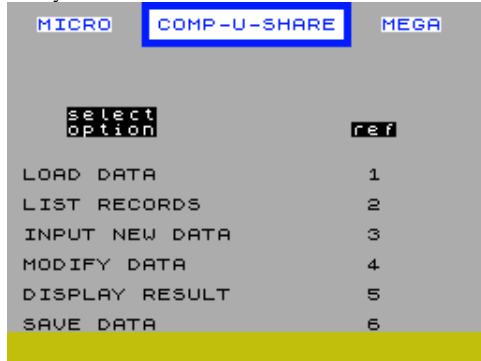

Comp-U-Tax (Micromega,1983)
Utility

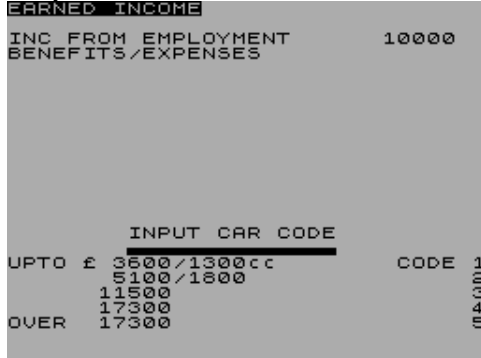

Computer Bridge (Melbourne House,1983)
Board/Card Game



Computer Christmas Card (Virgin Games Ltd,1985)
Simulation

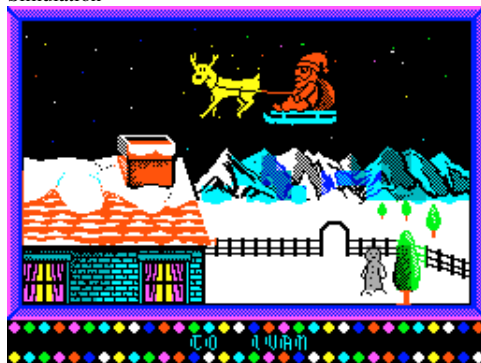

Computer Maniac's 1989 Diary (Domark Ltd,1989)
Simulation



Computacalc ZX (Silicon Tricks,1984)
Utility



Computer (Dolphin Software,1987)
Text Adventure

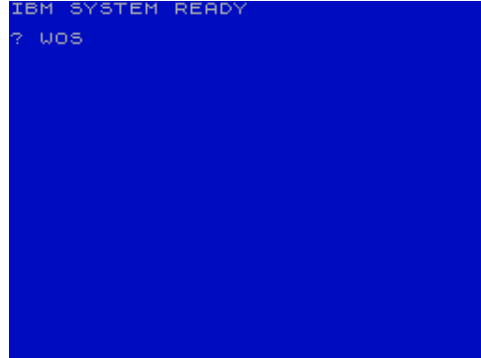

Computer Challenge (Malan Associates,1984)
Arcade

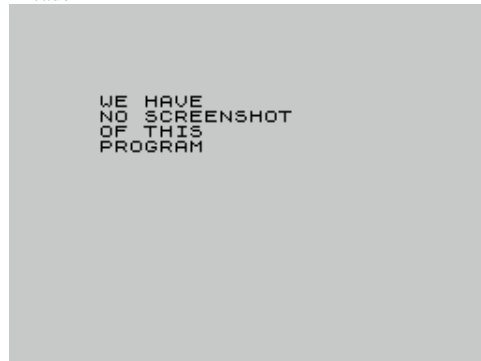

Computer Classics (Beau-Jolly Ltd,1987)
Compilation



Computer Salesman's Phrase Book, The (Spectrum Computing,1985) Demo



Computaword (Work Force,1984)
Simulation



Computer Brag (T. Lebon,1983)
Board/Card Game

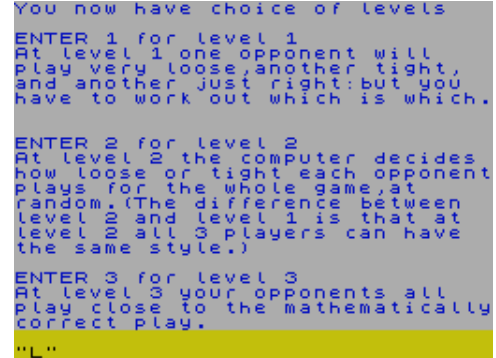

Computer Challenge - The Business Game (BBC Software,1986)
Simulation

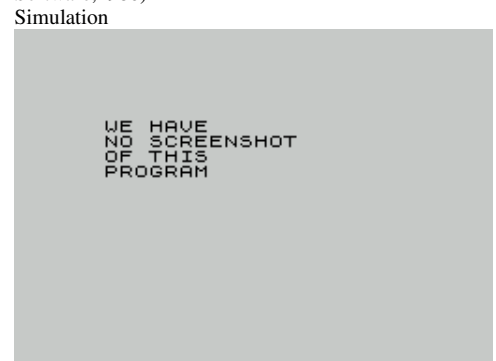

Computer Cook Book, The (Bug-Byte Software Ltd,1984)
Utility

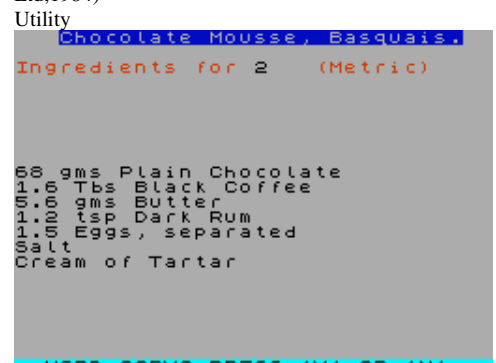

Computer Science (Disney Software,1987)
Educational



Computer Scrabble (Sinclair Research Ltd,1983)
Board/Card Game



MOVE CURSOR ←→→→ THEN PRESS
A-across OR D-down TO PLACE WORD
(Press SYMBOL-SHIFT for OPTIONS)

Computer Studies (Longman Software,1984)

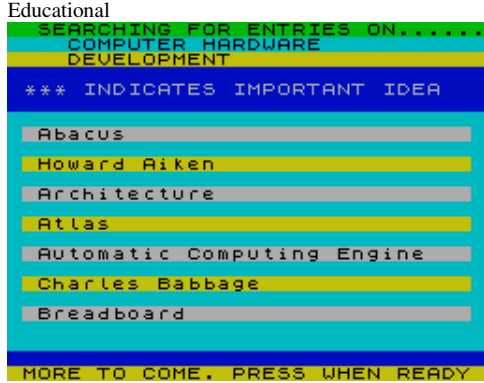

Computer Word-Search (Ashbourne Way,1986)

Board/Card Game



Concentration (Sinclair Programs,1984)

Board/Card Game

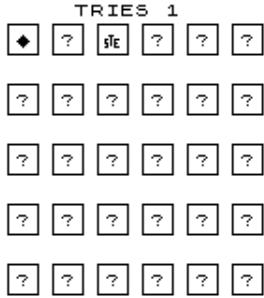

Concon issue 3 (Sift,1984)

Covertape



Computer Studies (Charles Letts & Co,1985)

Educational

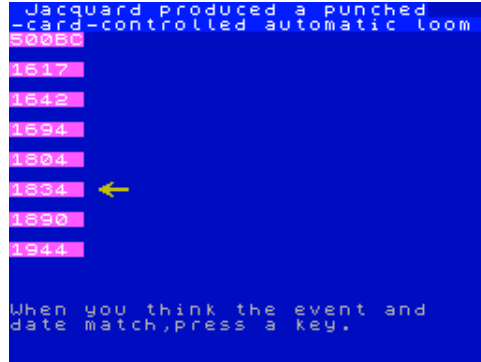

Computer Studies (Scisoft,1984)

Educational

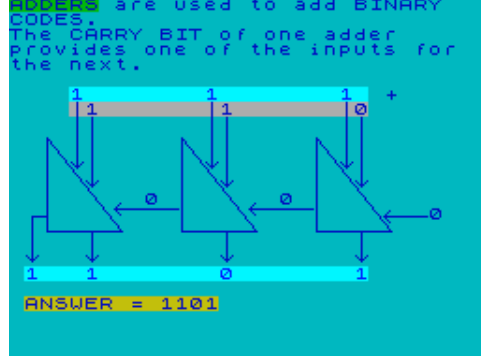

Computer Wordsearch (Softfirm,1985)

Utility



Concon issue 1 (Sift,)

Covertape



Concon issue 4 (Sift,1984)

Covertape



Computer Studies (Collins Educational,1984)

Educational

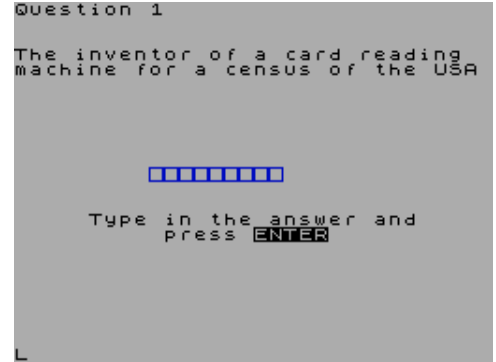

Computer Studies - O'Level & CSE (Micro-De-Bug Consultancy,1984)

Educational



Conan I (UV Software,1991)

Text Adventure

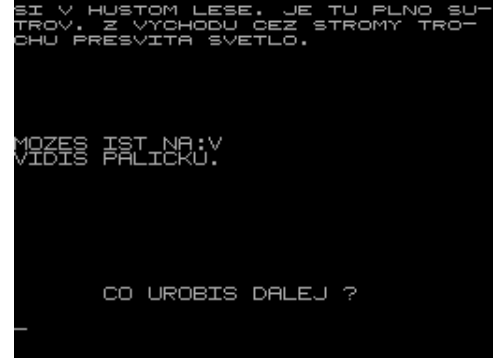

Concon issue 2 (Sift,)

Covertape



Conductor Nocturno (Microparadise Software,1984)

Arcade



Conductor Novato (Microparadise Software,1984)
Arcade



Conflict Command (Ocean Software Ltd,1988)
Compilation



Confrontation (MC Lothlorien Ltd,1983)
Strategy



Confused (Crash,1991)
Arcade

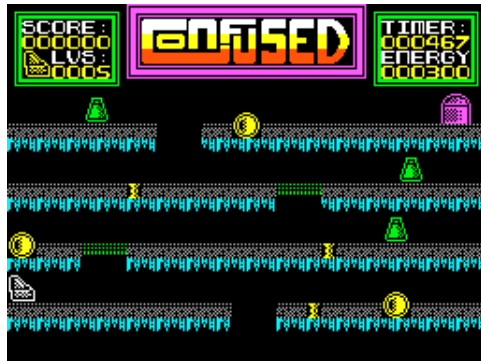

Congo Bongo (US Gold Ltd.)
Arcade



Confidential (Radar Games,1985)
Text Adventure

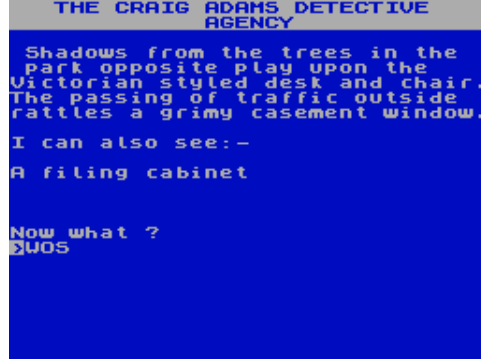

Conflicts 1 (PSS,1987)
Compilation



Confrontation Scenarios volume 1 (MC Lothlorien Ltd,1984)
Strategy



Confusion (Blaby Computer Games,1983)
Arcade



Conman the Barbaric (Elven Adventurers,1991)
Text Adventure



Conflict (Martech Games Ltd,1982)
Strategy



Conflicts 2 (PSS,1987)
Compilation



Confrontation Scenarios volume 2 (MC Lothlorien Ltd,1985)
Strategy



Confuzion (Incentive Software Ltd,1985)
Arcade

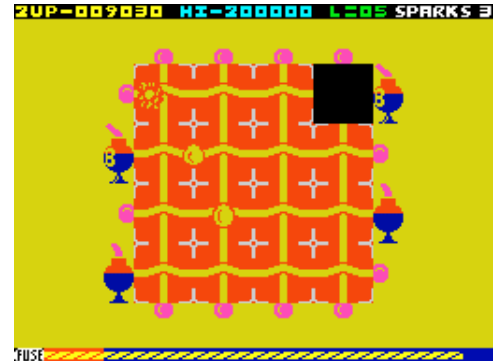

Connect 4 (.)
Board/Card Game

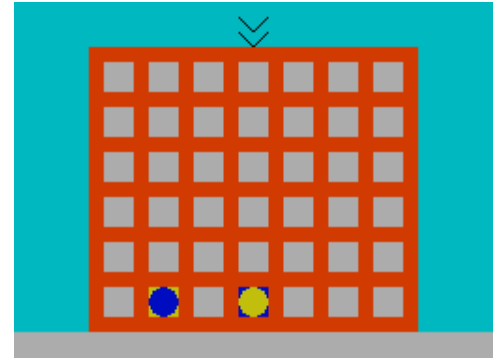

Connect 4 (Atlantis Software Ltd,1984)
Board/Card Game

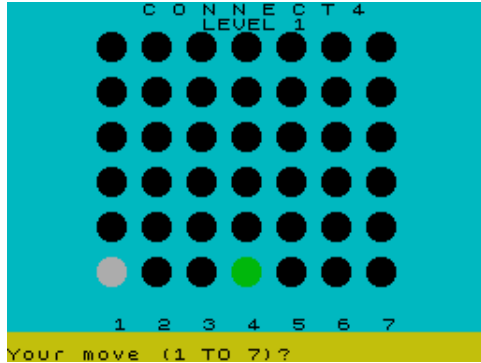

Conquerors of Space (Duncan Games,1984)
Board/Card Game

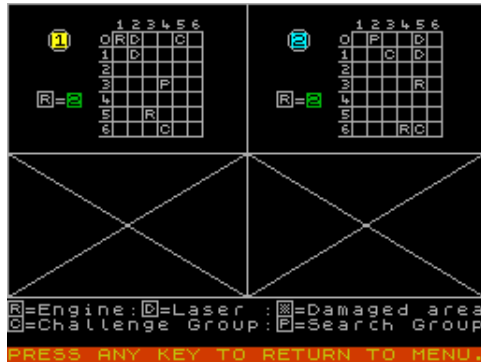

Constelaciones (Juan Jose Samper Marquez,1985)

Utility: Astronomy/Astrology
 AQUILA (AGUILA) AqL E-O
 RR: 18h 40m - 20h 35m Dec: 8 - 12

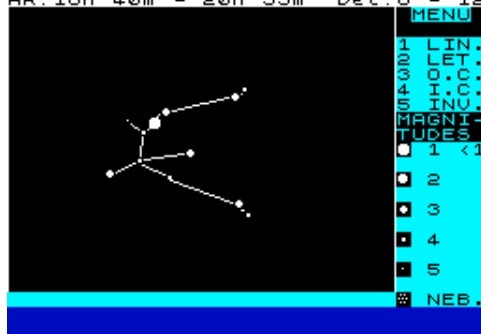

Constructor, El (Ventamatic,1984)
Arcade



Contabilidad (Paraninfo Soft S.A.,1985)
Utility

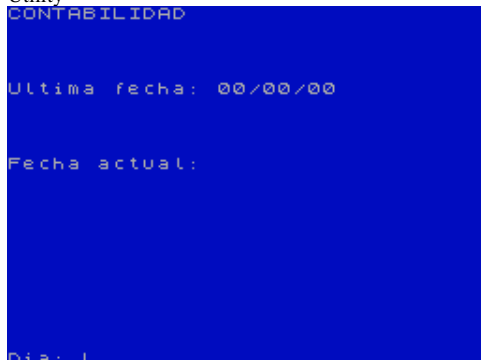

Connect 4 (John Westhead,1994)
Board/Card Game

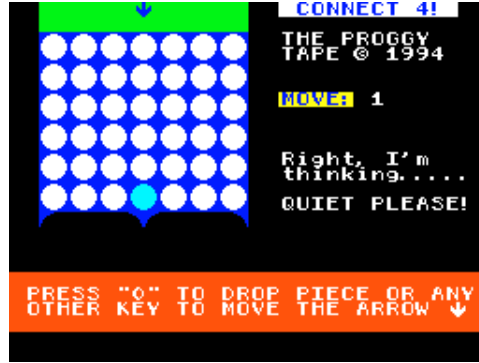

Conquest (Cheetahsoft Ltd,1984)
Strategy



Constellation (J. Rogers/J. Hodgson,1982)
Educational

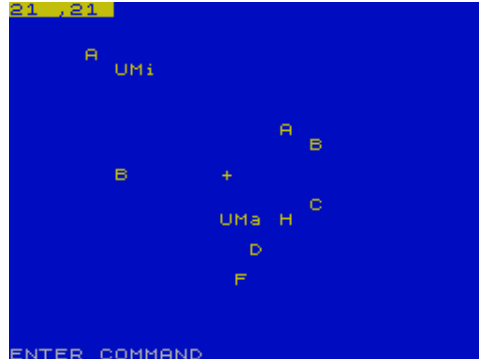

Contabilidad (MicroHobby,1985)
Utility



Contabilidad Casera (MicroHobby,1985)
Utility: Spreadsheet



Conquering Everest (ASP Software Ltd,1983)
Text Adventure



Con-Quest (Mastertronic Added Dimension,1986)
Arcade Adventure



Constitucion Espanola, La (Investronica S.A.,)
Educational

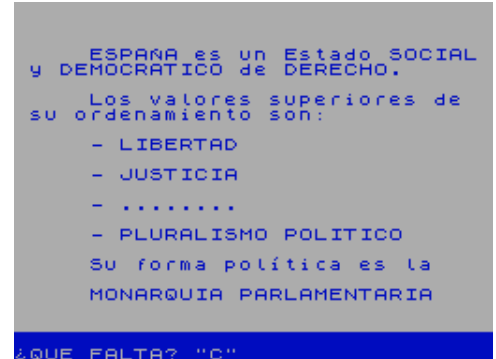

Contabilidad (Micro World,1984)
Utility



Contabilidad Domestica (DIMENSIONNEW/Ideologic S.A.,1984)
Utility



Contabilidad Domestica (Investronica S.A.,1984)
Utility

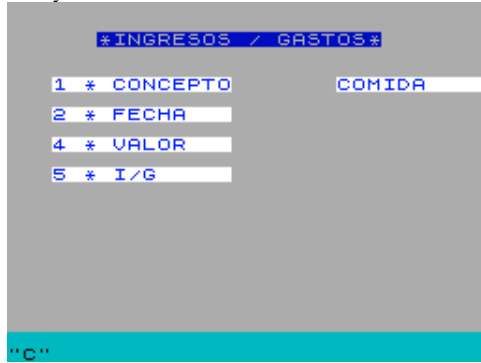

Contabilidad Domestica (Microparadise Software,1985)
Utility



Contabilidad Domestica + Minitextos + Fichero (Investronica S.A.,1984) Compilation



Contabilidad Espanola (ABC Soft,1984)
Utility

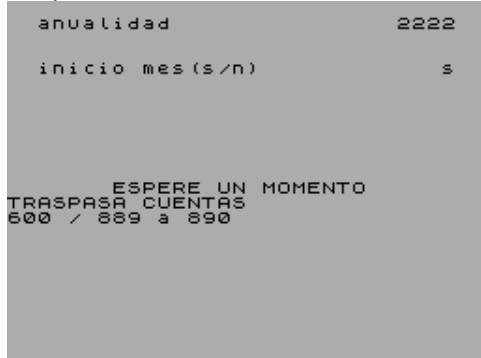

Contabilidad General (Investronica S.A.,1983)
Utility

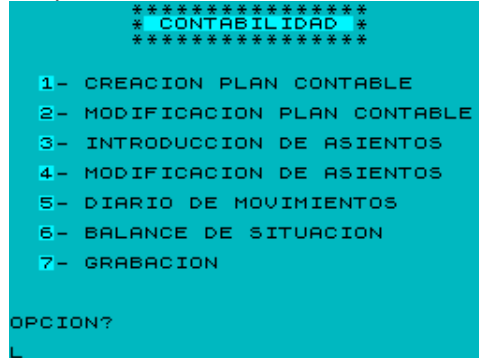

Contabilidad General para Microdrives (Investronica S.A.,1984) Utility



Contabilidad Personal V:6 (Ventamatic,1983)
Utility



Contact Sam Cruise (Microsphere,1986)
Arcade



Context Plus (Ventamatic,1985)
Utility

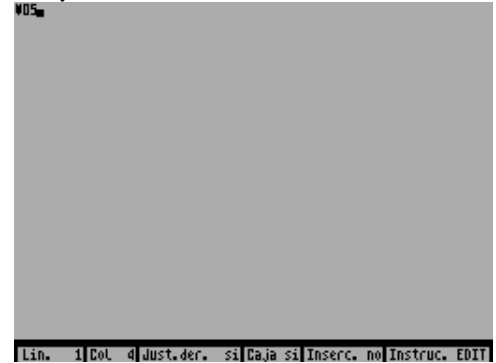

Context Seikosha SP/800 (Dirac Pin,)
Utility



Context V:6 (Ventamatic,1984)
Utility

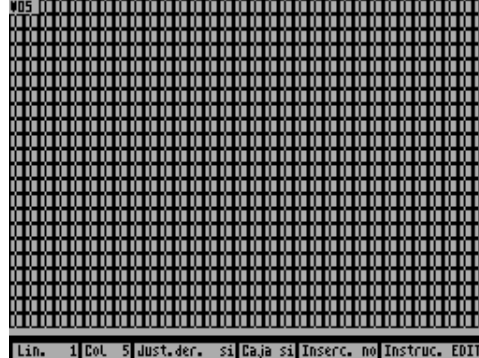

Continental Circus (Virgin Mastertronic Ltd,1989)
Sport



Contour (MicroHobby,1984)
Utility: Drawing



Contours (Sinclair Programs,1983)
Utility: BASIC Related

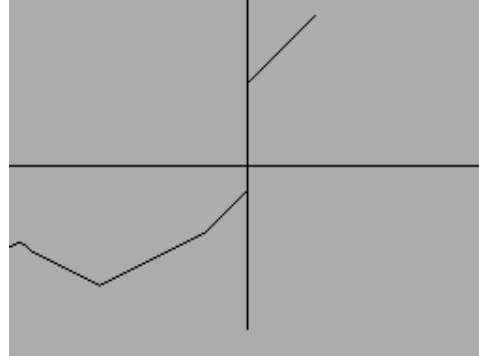

Contract Bridge (Highlight Software,1984)
Board/Card Game



Contraption (Icon Software Ltd.)
Arcade

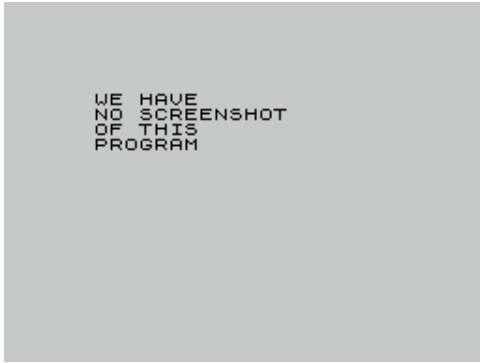

Control de Stock (Paraninfo Soft S.A.)
Utility



Control de Stocks (DIMensionNEW/Ideologic S.A.,1984)
Utility

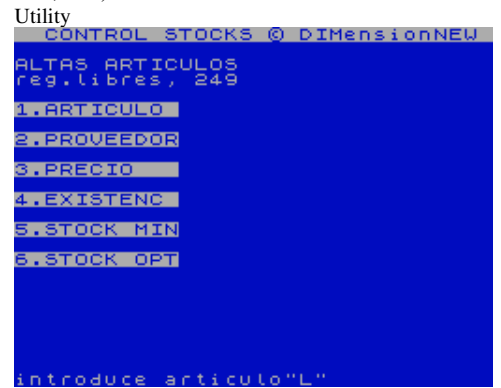

Control de Stocks (Microparadise Software,1984)
Utility



Conversion de Base (Microparadise Software,1984)
Utility



Conversion de Unidades (MicroHobby,1985)
Utility



Conversor 2.0 (Cesar Hernandez Bano,1997)
Utility

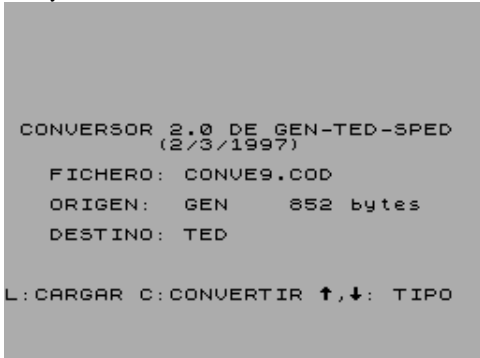

Conversor Hexa-decimal (MicroHobby,1984)
Utility



Convert (MiCROL,1982)
Utility: Mathematics

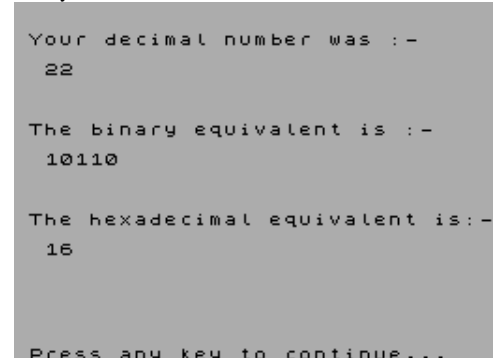

Conveyor-Belt Capers (Spectrum Computing,1984)
Arcade



Convoy (Budgie Budget Software,1985)
Strategy



Convoy (Hipocrates Soft,1982)
Arcade



Convoy (Spectrum Computing,1984)
Arcade



Convoy Raider (Gremlin Graphics Software Ltd,1987)
Arcade



Cookie (Ultimate Play The Game,1983)
Arcade

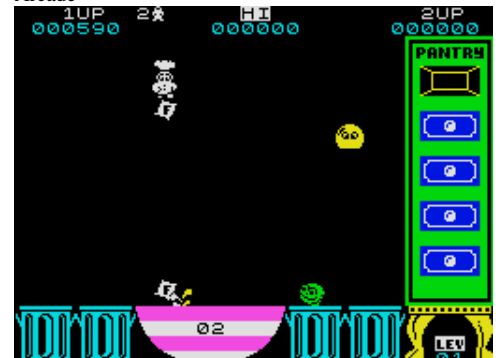

Cool Cliff (Cliffy T,1995)
Scene Demo

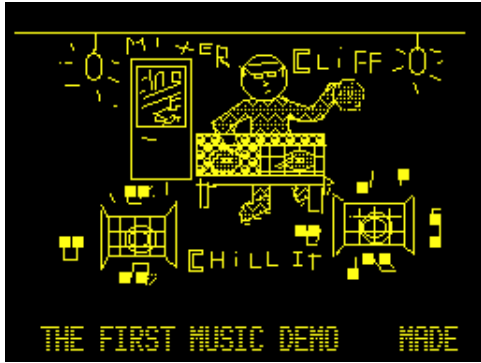

Copier (Sinclair Research Ltd,1984)
Utility: Copier



Copion (Ignacio Diaz,1984)
Utility

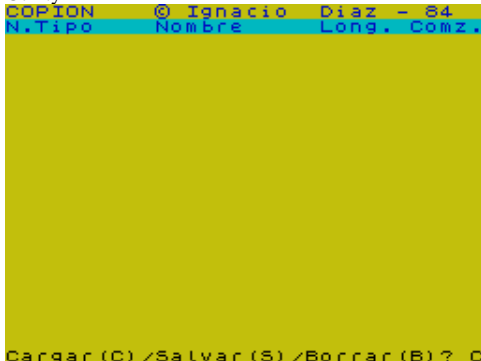

Copper Hopper (ESP Software,1985)
Arcade

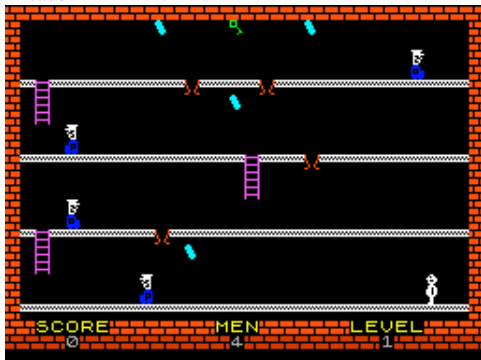

Copy (.)
Utility: Copier

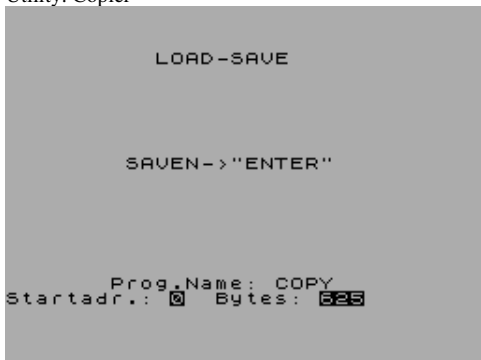

Copiodor (Microparadise Software,1984)
Utility



Copier (TRC Software,1986)
Utility: Copier

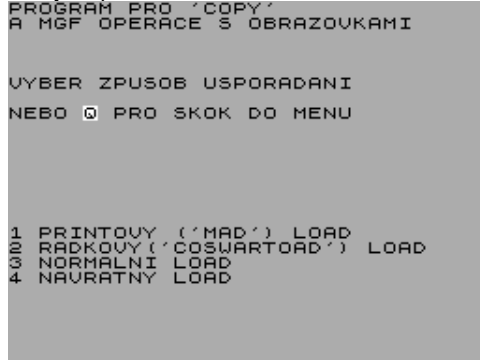

Cop-Out (Mikro-Gen Ltd,1986)
Arcade



Copter (16/48 Tape Magazine,1983)
Arcade

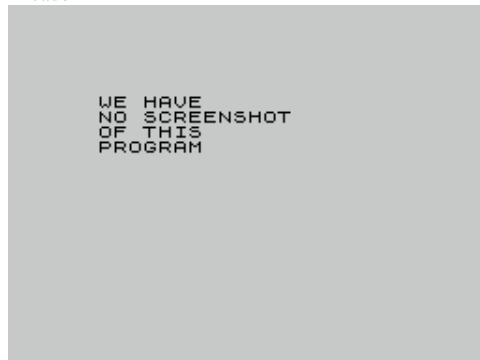

Copy (Anwi PJP TLS,1984)
Utility: Copier



Copier (Alchemist Software.)
Utility: Copier



Copier FM3 (.)
Utility: Copier



Copper (Vectis Software,1983)
Arcade

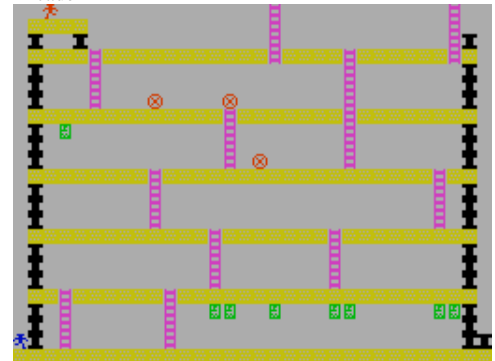

Copter (Omega Software Ltd,1984)
Arcade



Copy 24000 (Stephan Slabihoud,1986)
Utility: Copier

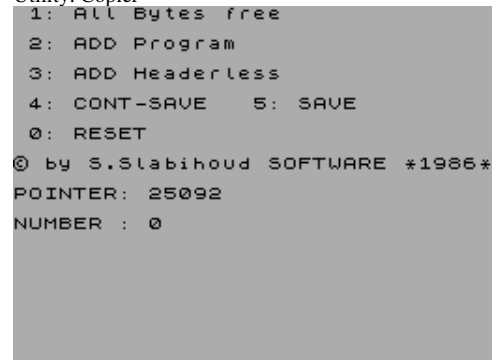

Copy 86M (.)
Utility: Copier

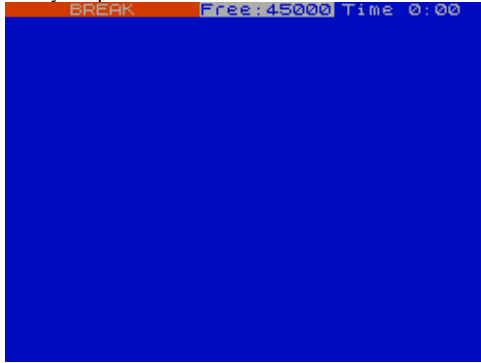

Copy Four (Euroelectronics,1984)
Utility

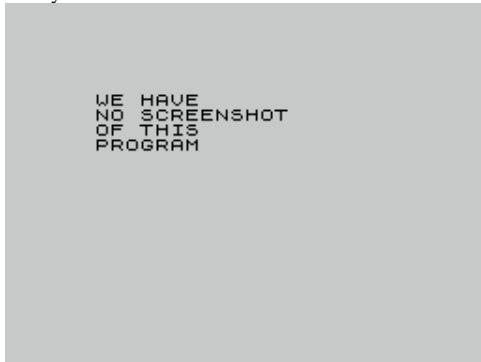

Copyline (MicroHobby,1984)
Utility



Copyupi (MicroHobby,1985)
Utility



CORE (A'n'F Software,1986)
Arcade



Copy Cats + Spell Cats (Keysoft,1987)
Compilation

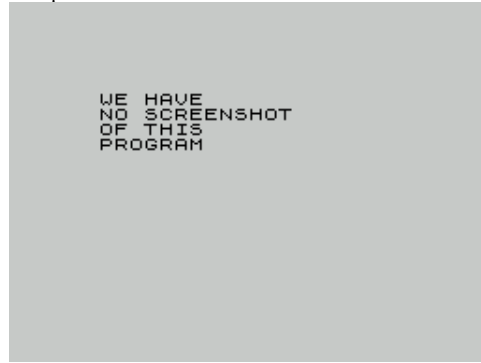

Copy Gap (Fabian Frich,.)
Utility: Copier

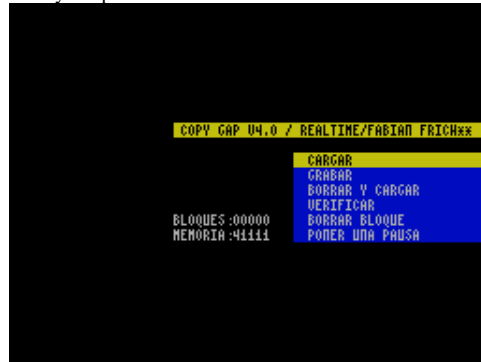

Copyline (Simplificado) (MicroHobby,1984)
Utility



Copy W (.)
Utility: Copier



Corn Cropper (CCS,1983)
Simulation



Copy de Luxe (Jeremic Nebojsa,1984)
Utility: Copier

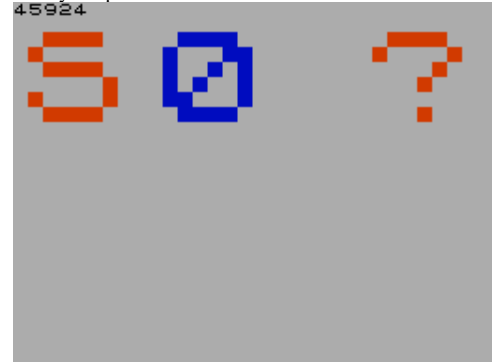

Copy It (.)
Utility: Copier

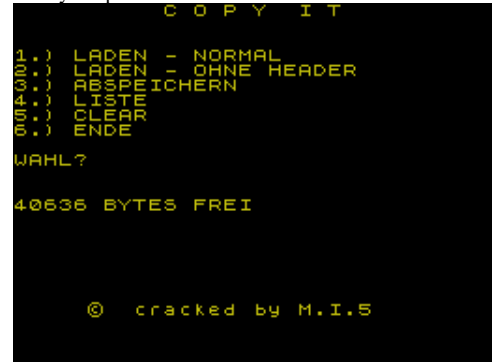

Copy-Plus (Dakrasoft,1983)
Utility: Copier



Corazon del Angel, El (Year Zero Software,1990)
Text Adventure

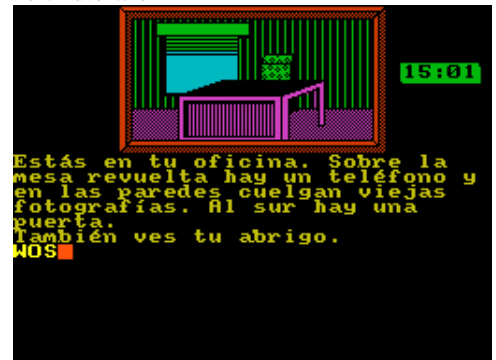

Cornelius (Bismilla,1987)
Text Adventure



Cornish Riviera (Dee-Kay Systems,1984)
Simulation



Corona Magica, La (OMK Software S.L.,1990)
Arcade Adventure



Corporation, The (Activision Inc,1988)
Simulation

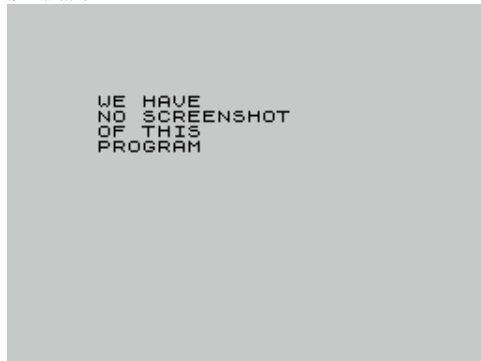

Corridors of Genon (New Generation Software,1983)
Arcade



Corruption (Omega Software Ltd,1984)
Arcade

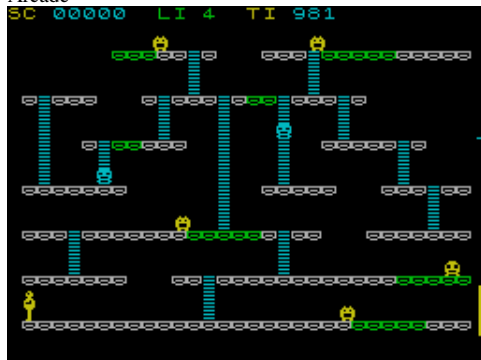

Cornish Venturer (Dee-Kay Systems,)
Simulation

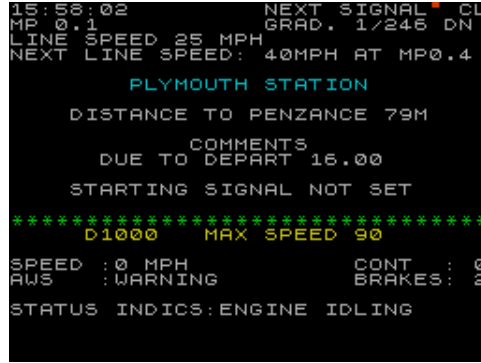

Corplan (Understanding Ltd,1983)
Educational



Corredor, El (MicroHobby,1985)
Sport



Corrupt (G.LL. Software,1990)
Text Adventure

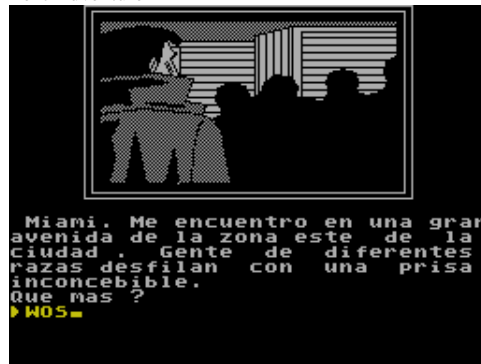

Corruption (Rainbird Software Ltd,1988)
Arcade

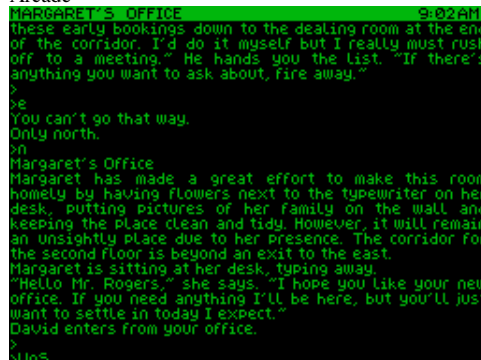

Corona, La (SPE,1988)
Text Adventure



Corporal Stone (Zenobi Software,1992)
Text Adventure



Corrida, La (MicroHobby,1985)
Arcade



Corruption (Breadhill,1984)
Arcade

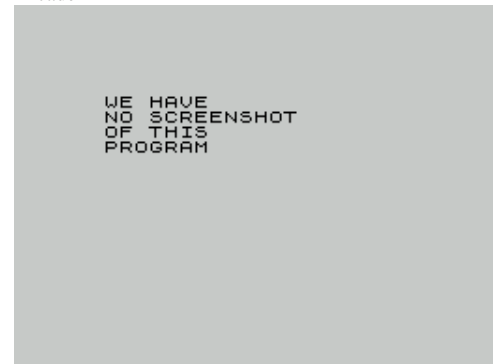

Corsarios (Opera Soft S.A.,1989)
Arcade



Cortes (L'Ensouleiado Software,1984)
Educational



Cosecha, La (MicroHobby,1985)
Arcade



Cosme (.)
Arcade



Cosmic Chaos (Crash,1990)
Arcade



Cosmic Guerilla (Crystal Computing,1983)
Arcade



Corya the Warrior Sage (The Guild,1992)
Text Adventure

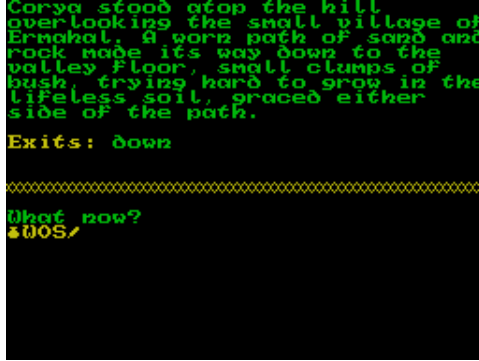

Cosmanoids (Add-On Electronics Ltd,1983)
Arcade

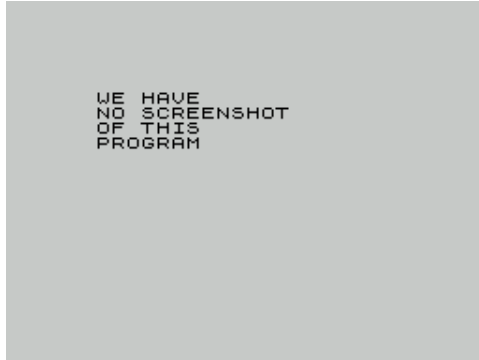

Cosme y los Alienigenas (MicroHobby,1985)
Arcade



Cosmic Cruiser (Imagine Software Ltd,1984)
Arcade

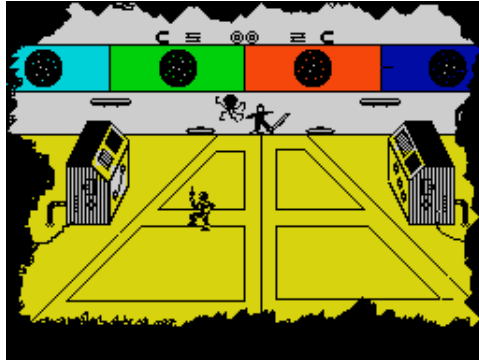

Cosmic Intruders (Spectrum Games Ltd,1983)
Arcade

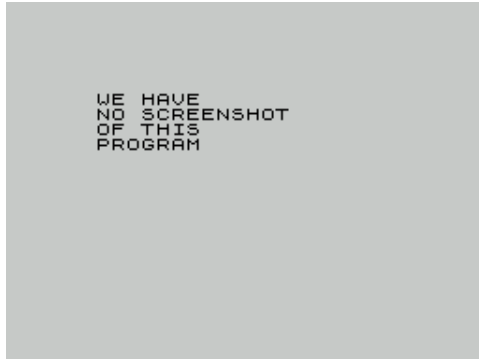

Cosa Nostra (Opera Soft S.A.,1986)
Arcade

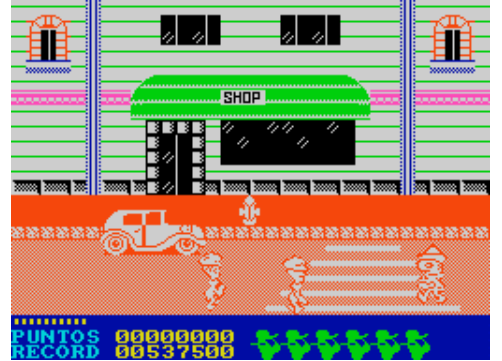

Cosmazoigs (Your Computer,1984)
Arcade



Cosmic Attack (Anik Microsystems,1984)
Arcade



Cosmic Debris (Artic Computing Ltd,1983)
Arcade

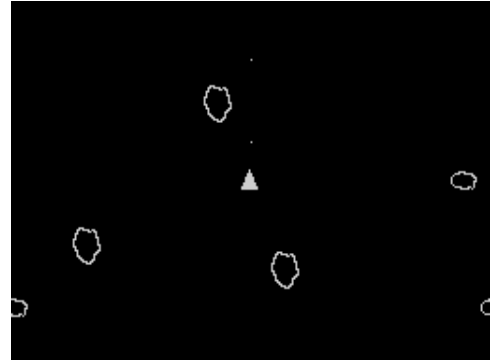

Cosmic Pirate (Byte Back,1989)
Arcade

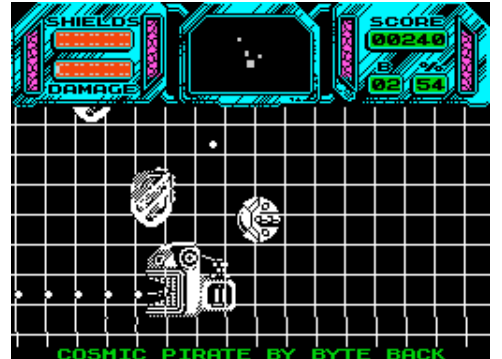

Cosmic Raiders (Mikro-Gen Ltd,1983)
Arcade



Cosmic Swarm (Softtek Software International Ltd,1983)
Arcade



Cosmos (Futuresoft,1989)
Text Adventure

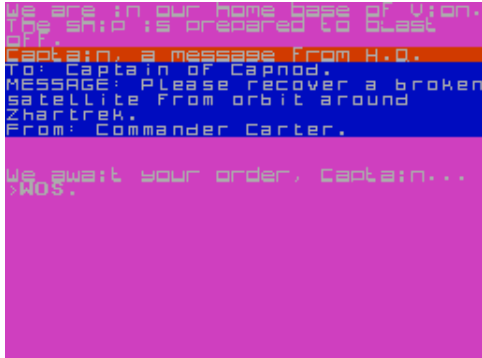

Cotavilidad (Ruben Garcinuno,)
Utility



Count and Add (Lander,1992)
Educational

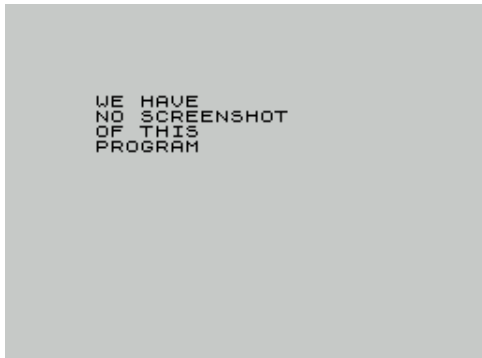

Cosmic Sheriff (Dinamic Software,1989)
Arcade

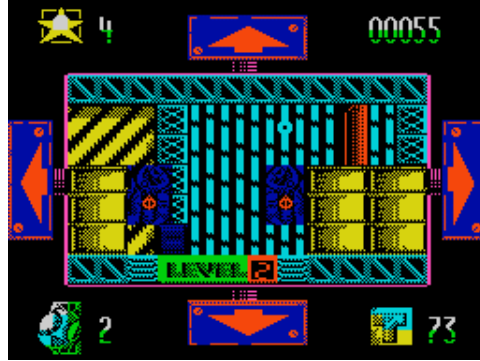

Cosmic Wartoad (Ocean Software Ltd,1985)
Board/Card Game



Cosmos, The (Eclipse Software,1985)
Educational

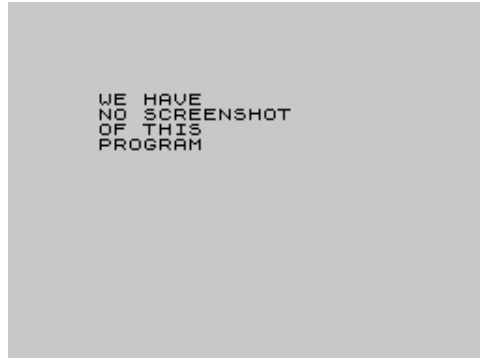

Cotton ZX (Javier Vispe Mur,2003)
Arcade



Countdown (Central Solutions,1986)
Text Adventure

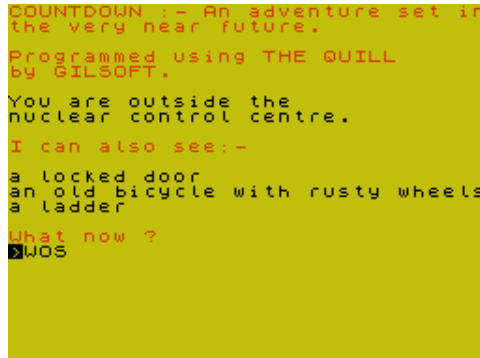

Cosmic Shock Absorber (Martech Games Ltd,1986)
Arcade



Cosmos (Abbex Electronics,1982)
Arcade



Costa Capers (Firebird Software Ltd,1985)
Arcade Adventure



Countabout (Longman Software,1983)
Educational

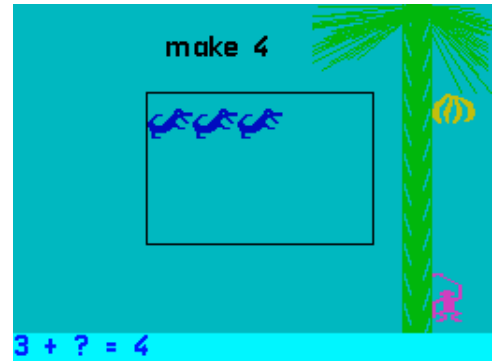

Countdown (Infected Software,)
Text Adventure



Countdown (Macsen Software,1986)
Board/Card Game



Count Duckula (Alternative Software Ltd,1989)
Arcade Adventure

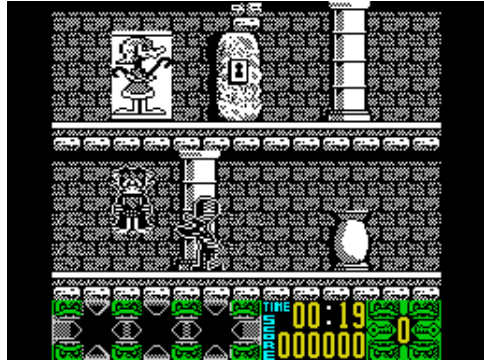

Counting Cats (Sinclair User,1984)
Educational

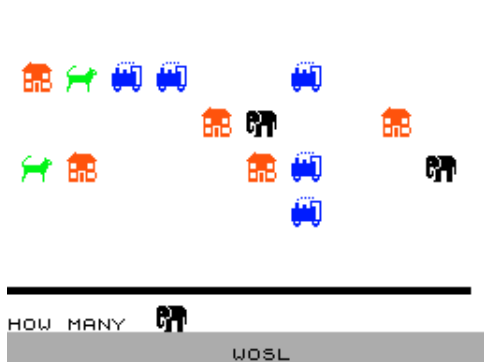

Country Cottages (Sterling Software,1984)
Strategy



Count with Oliver (Mirrorsoft Ltd,1987)
Educational



Countdown to Doom (Topologika,1988)
Text Adventure

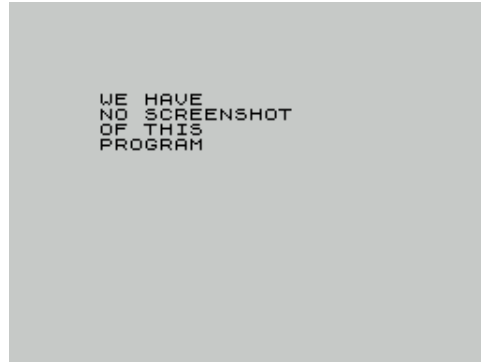

Count Duckula 2 (Alternative Software Ltd,1992)
Arcade Adventure

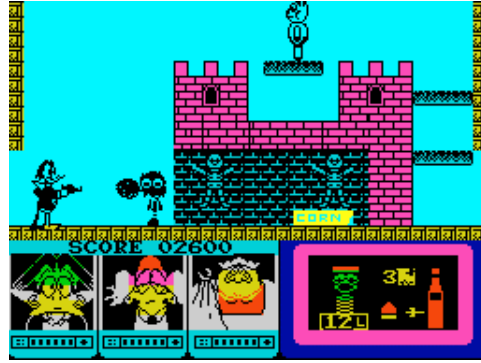

Countries and Capitals (Teacher's Pet Software,1988)
Educational

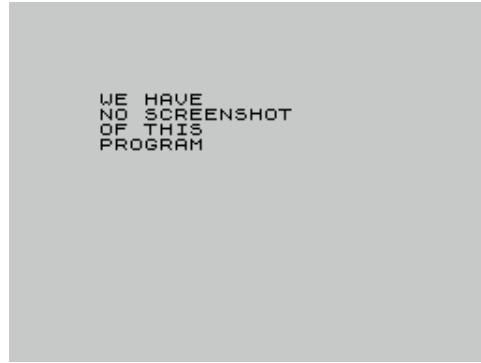

Count, The (Adventure International,1984)
Text Adventure



County Cricket (D&H Games,1989)
Strategy



Countdown to the Death (Crash,1990)
Board/Card Game

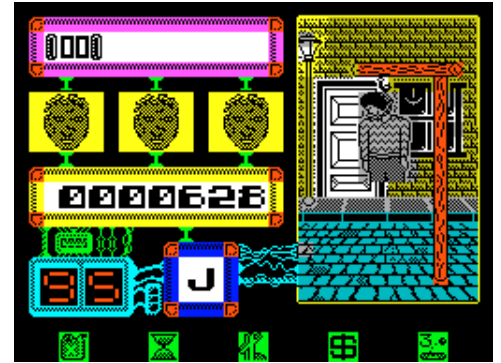

Counting (Widgit Software Ltd,1983)
Educational

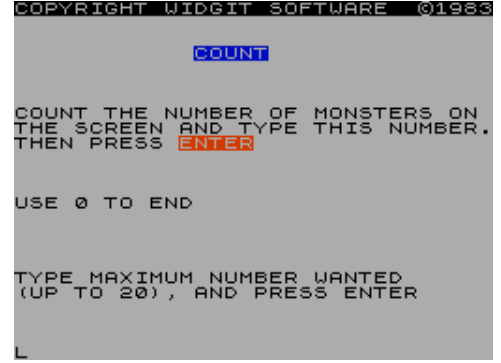

Countries of the World (Hewson Consultants Ltd,1982)
Educational



Count, The (Mirrorsoft Ltd,1985)
Arcade

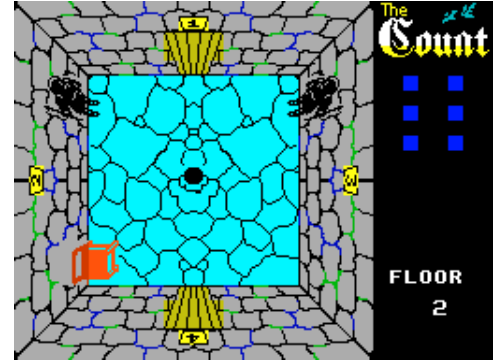

Courier 2 (Perspective Group,2002)
Arcade



Coursemaster (Intraset Ltd,1991)
Simulation

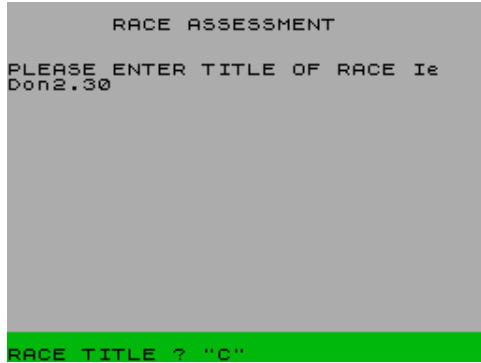

Covenant, The (PSS,1985)
Arcade



Cover Up! (R'n'H Microtec,1987)
Arcade

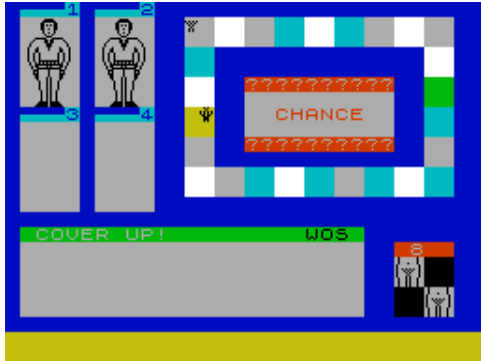

Cowboy Duel (D.J. Stepanenko,1990)
Arcade

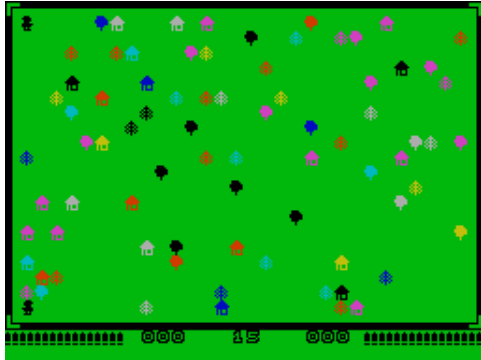

Cowboy Shootout (Micro Power Ltd,1983)
Arcade



Course Winner (Selec Software,1984)
Utility



Covergirl Poker (Sales Curve Ltd,1992)
Board/Card Game

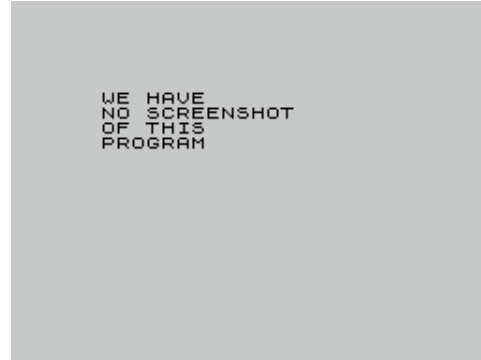

Cow Boy (MicroHobby,1985)
Arcade



Cowboy Kidz (Byte Back,1989)
Arcade

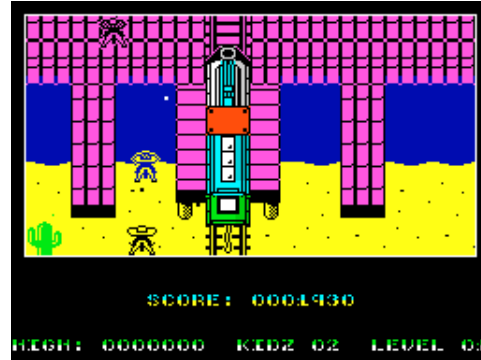

Cowl Index (Cowl Systems,1988)
Compilation



Coven (Piranha,)
Arcade Adventure

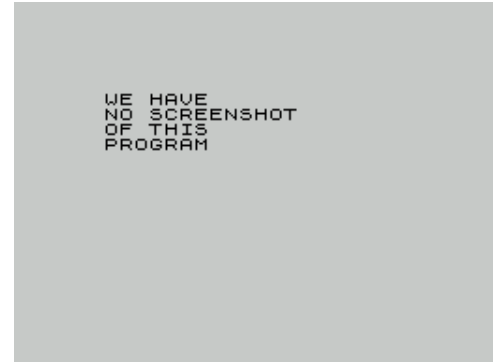

Coverprinter (.)
Utility



Cowboy (Spectrum Computing,1984)
Arcade



Cowboy Shoot Out (16/48 Tape Magazine,1984)
Arcade



Coxsoft Header Reader, The (Coxsoft,1987)
Utility

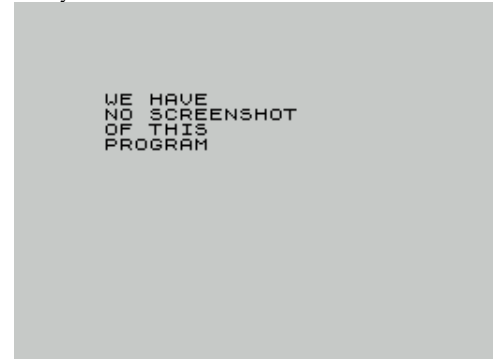

Cozumel (Aventuras AD S.A.,1990)

Text Adventure



Cracker (D.J. Stepanenko,1990)

Utility: Copier



Crack Music Demo (Oscar & Spielberg)

Scene Demo



Crappest Demo (Phantom,)

Scene Demo

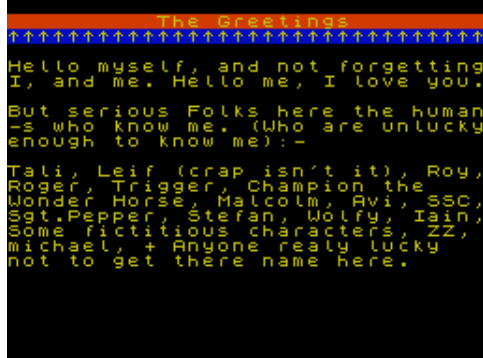

Crash (The Guild,)

Text Adventure



Crabs (JRS Software Ltd,1982)

Arcade



Cracker (Studak Software,1989)

Text Adventure

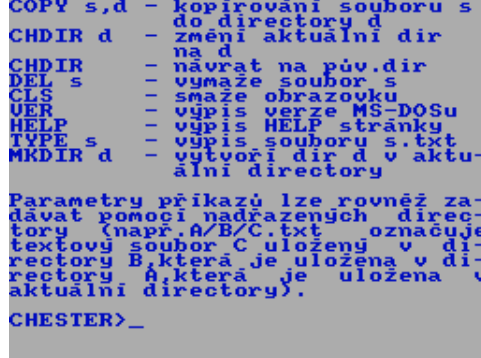

Crack-Up (Atlantis Software Ltd,1991)

Arcade

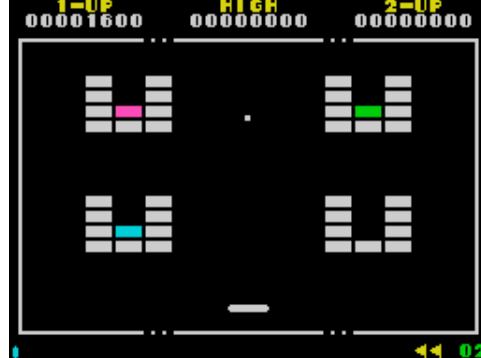

Craps (Micromega,1983)

Board/Card Game

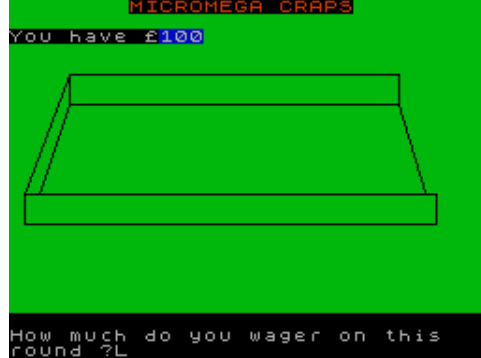

Crash Collection Vol 1, The (US Gold Ltd,1989)

Compilation



Crack Down (US Gold Ltd,1990)

Arcade

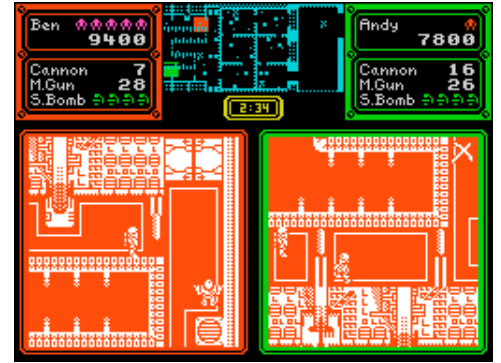

Crack It! Towers (Mirrorsoft Ltd,1986)

Simulation

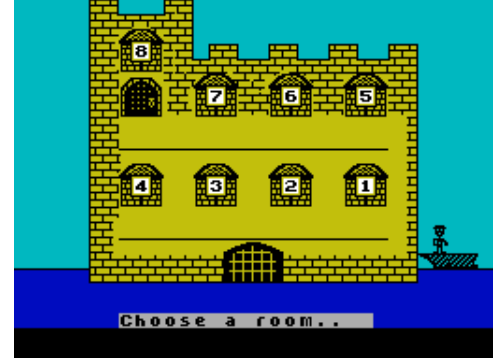

Craft Cruiser (Load 'n' Run [Spa],1985)

Arcade



Crash (Mogul Communications Ltd,1983)

Arcade



Crash issue 45: Sampler (Crash,1987)

Covertape



Crash issue 54: Sneak Preview 1 (Crash,1988)
Covertape

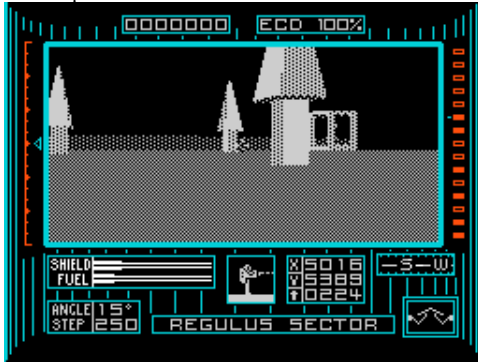

Crash issue 60: Sneak Preview 4 (Crash,1989)
Covertape

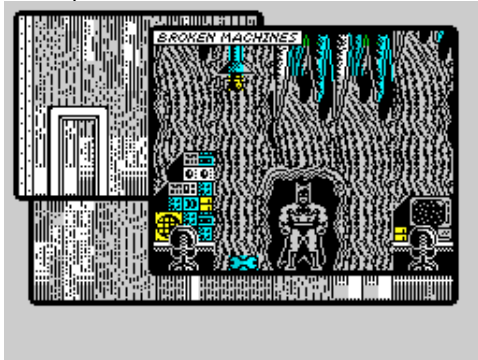

Crash issue 66: Presents 2 (Crash,1989)
Covertape



Crash issue 69: Presents 5 (Crash,1989)
Covertape



Crash issue 72: Presents 8 (Crash,1990)
Covertape



Crash issue 58: Sneak Preview 2 (Crash,1988)
Covertape



Crash issue 63: Crucial (Crash,1989)
Covertape



Crash issue 67: Presents 3 (Crash,1989)
Covertape



Crash issue 70: Presents 6 (Crash,1989)
Covertape



Crash issue 73: Presents 9 (Crash,1990)
Covertape

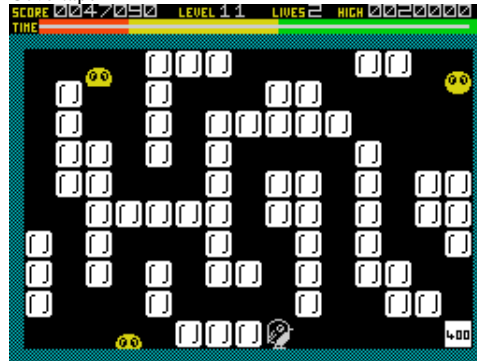

Crash issue 59: Sneak Preview 3 (Crash,1988)
Covertape

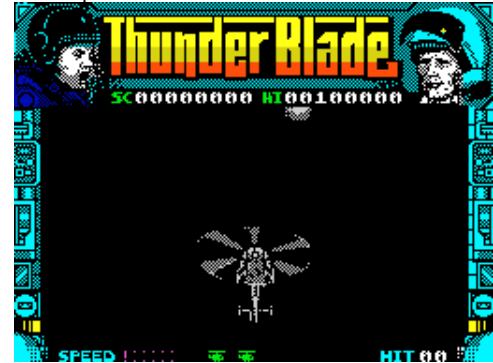

Crash issue 65: Presents 1 (Crash,1989)
Covertape



Crash issue 68: Presents 4 (Crash,1989)
Covertape



Crash issue 71: Presents 7 (Crash,1989)
Covertape



Crash issue 74: Presents 10 (Crash,1990)
Covertape



Crash issue 75: Presents 11 (Crash,1990)
Covertape

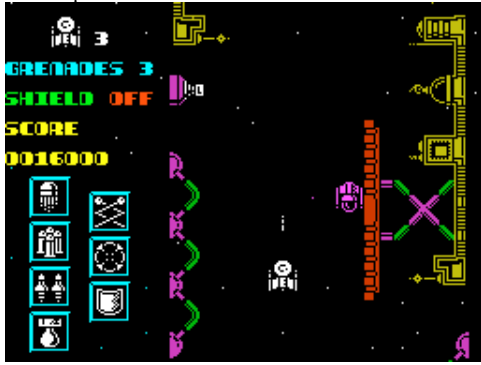

Crash issue 78: Presents 14 (Crash,1990)
Covertape



Crash issue 81: Presents 17 (Crash,1990)
Covertape



Crash issue 84: Presents 20 (Crash,1991)
Covertape

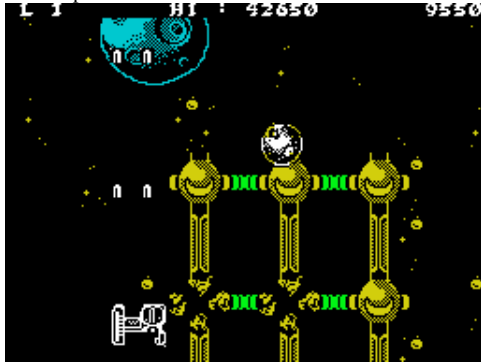

Crash issue 87: Presents 23 (Crash,1991)
Covertape



Crash issue 76: Presents 12 (Crash,1990)
Covertape

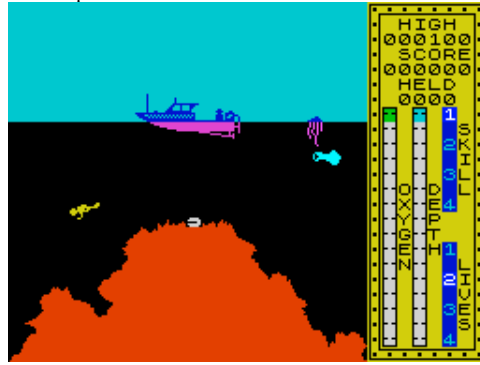

Crash issue 79: Presents 15 (Crash,1990)
Covertape

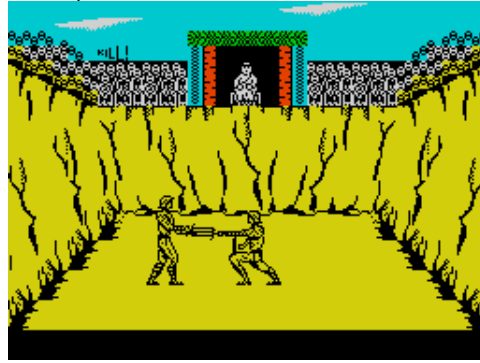

Crash issue 82: Presents 18 (Crash,1990)
Covertape



Crash issue 85: Presents 21 (Crash,1991)
Covertape



Crash issue 88: Presents 24 (Crash,1991)
Covertape



Crash issue 77: Presents 13 (Crash,1990)
Covertape

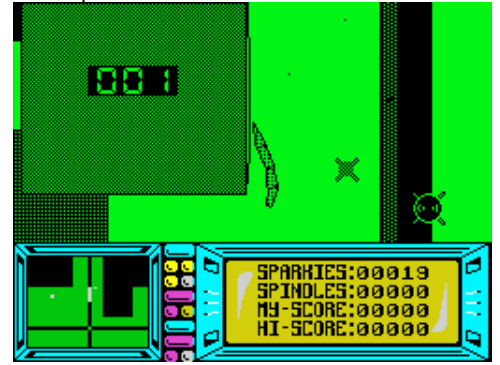

Crash issue 80: Presents 16 (Crash,1990)
Covertape



Crash issue 83: Presents 19 (Crash,1990)
Covertape



Crash issue 86: Presents 22 (Crash,1991)
Covertape



Crash issue 89: Presents 25 (Crash,1991)
Covertape



Crash issue 90: Presents 26 (Crash,1991)
Covertape



Crash issue 93: Presents 29 (Crash,1991)
Covertape



Crash issue 96: Presents 32 (Crash,1992)
Covertape



Crash It (.)
Arcade



Crashout (Digital Image,1987)
Arcade

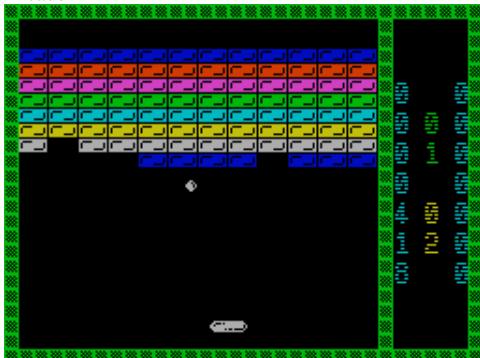

Crash issue 91: Presents 27 (Crash,1991)
Covertape



Crash issue 94: Presents 30 (Crash,1991)
Covertape

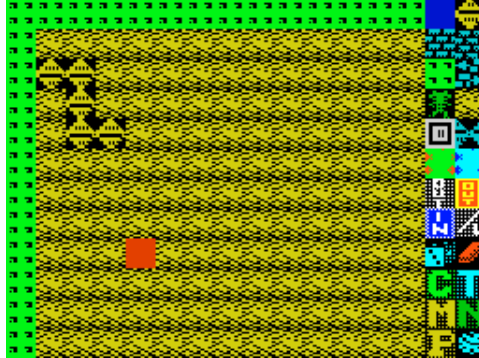

Crash issue 97: Presents 33 (Crash,1992)
Covertape

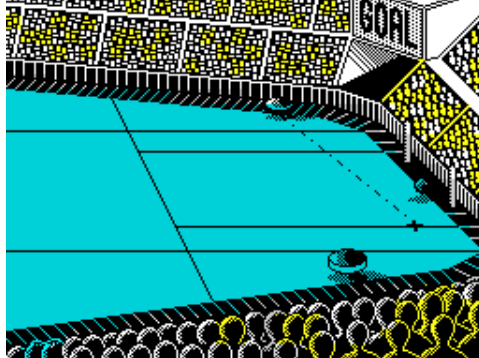

Crash Landing (The Guild,1986)
Text Adventure



Crash Review Index 1984 (Crash,1984)
Simulation



Crash issue 92: Presents 28 (Crash,1991)
Covertape



Crash issue 95: Presents 31 (Crash,1992)
Covertape

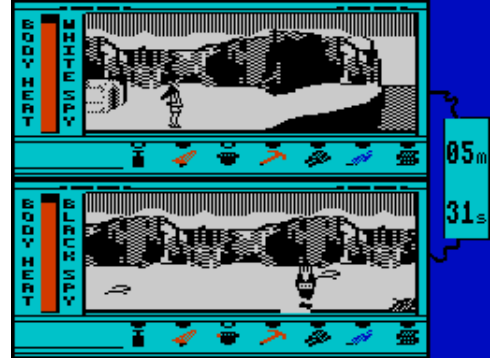

Crash issue 98: Presents 34 (Crash,1992)
Covertape



Crash Landing + Journey to Death (The Guild,1986)
Compilation

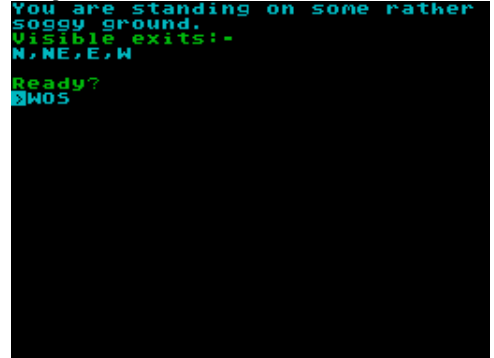

Crash Tech Tape (Crash,1988)
Compilation



Crawler (CRL Group PLC,1983)

Arcade



Crazy Billiards (Gonzalo Suarez,)

Arcade



Crazy Cars (JB Software,1985)

Arcade



Crazy Castles (Automata UK Ltd,1985)

Arcade

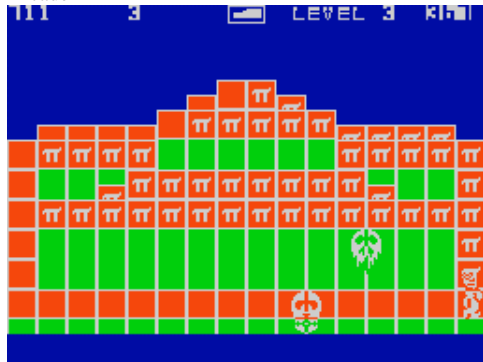

Crazy Crane (Voyager Software,1984)

Arcade

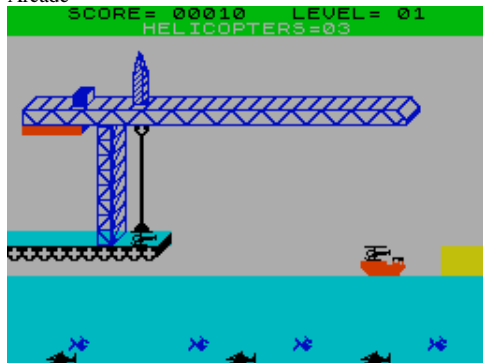

Crawling Horror, The (Year Zero Software,1990)

Text Adventure

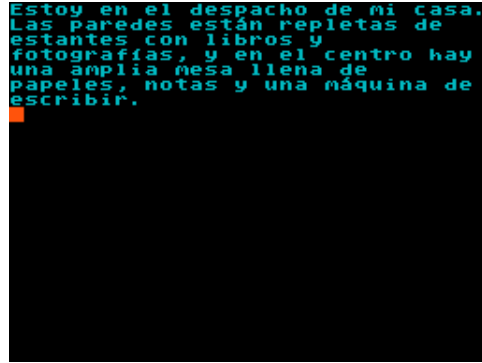

Crazy Bugs! (AWA Software,1983)

Arcade

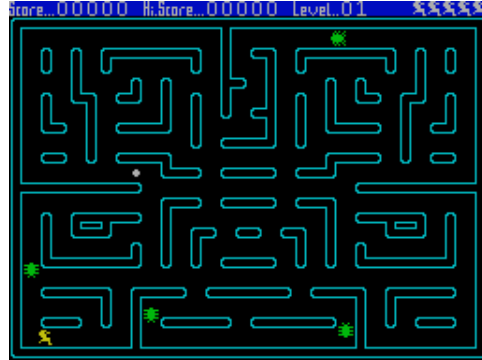

Crazy Cars (Titus,1988)

Arcade



Crazy Caverns (Firebird Software Ltd,1984)

Arcade



Crazy Demo, The (The Mad Guys,1991)

Scene Demo



Crazy Balloons (A'n'F Software,1983)

Arcade

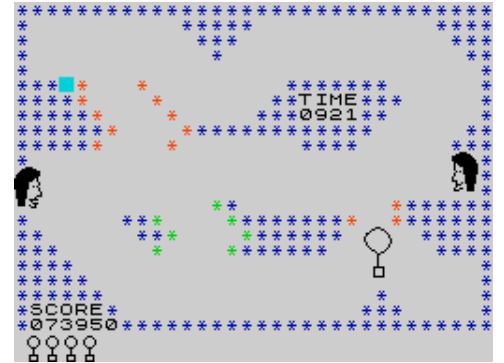

Crazy Butor (Flash Inc,1994)

Scene Demo



Crazy Cars II (Titus,1988)

Arcade



Crazy Chef (Astro Software,1983)

Arcade



Crazy Er*Bert (Alternative Software Ltd,1992)

Arcade

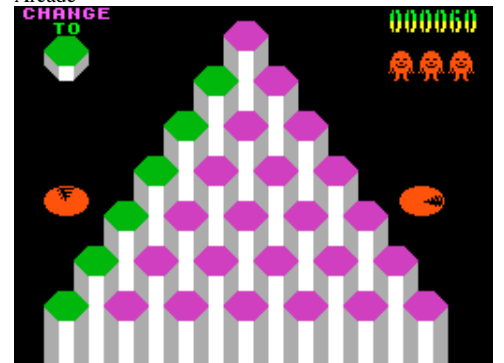

Crazy Golf (Jonathan Cauldwell,1993)

Sport

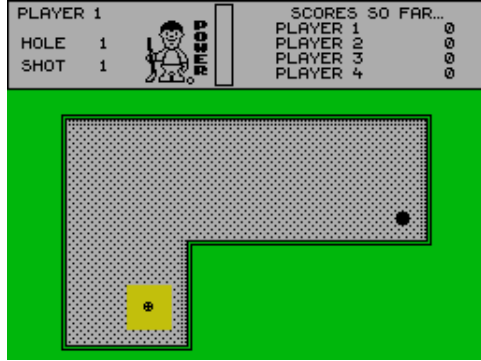

Crazy Kong (16/48 Tape Magazine,1984)

Arcade



Crazy Painter (Eduardo Mena Nieto,2006)

Arcade

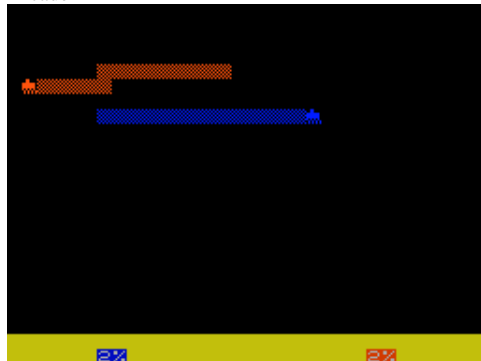

Crazy Race (C-Tech,1982)

Arcade



Crazy Sound Analyser (MRSoft,1991)

Scene Demo

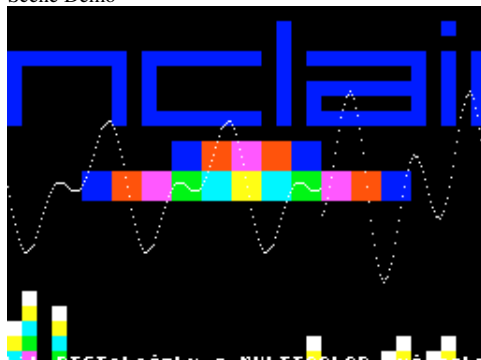

Crazy Golf (Mr. Micro Ltd,1983)

Sport

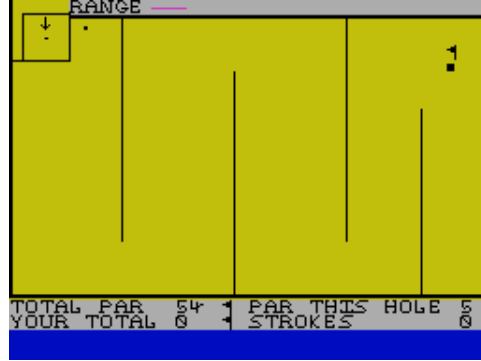

Crazy Kong (Roland G. Hulsmann,1983)

Arcade



Crazy Painter (Sinclair Programs,1984)

Arcade

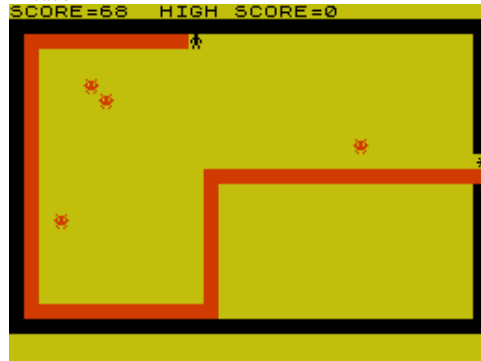

Crazy Sample II (The Lords,1989)

Scene Demo



Creador de Pantallas de Juegos (MicroHobby,1986)

Utility



Crazy House (Bulldog Software,1990)

Arcade



Crazy Love (Power Group,1998)

Scene Demo



Crazy Pingoïn (Magic Team,1986)

Arcade

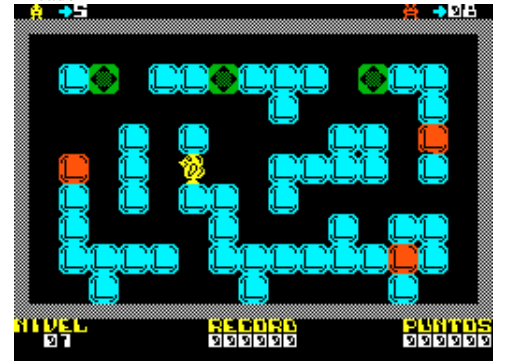

Crazy Shit (Flash Inc.)

Scene Demo

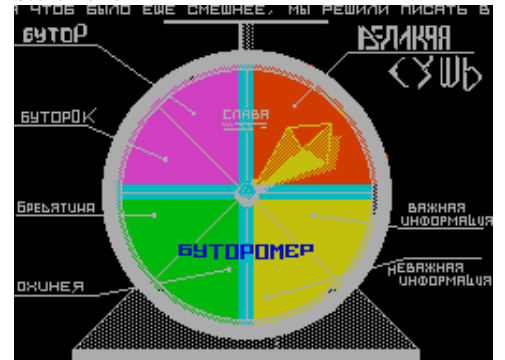

Creador Musical II (CoMAD Soft,1990)

Utility: Music Creation



Creatures (Thalamus Ltd.)
Arcade



Creepy Dungeons (Automata UK Ltd,1985)
Arcade



Crevasse (Microsphere,1982)
Arcade



Cribbage (16/48 Tape Magazine,1985)
Board/Card Game



Cribbage (Spectrum Computing,1985)
Board/Card Game

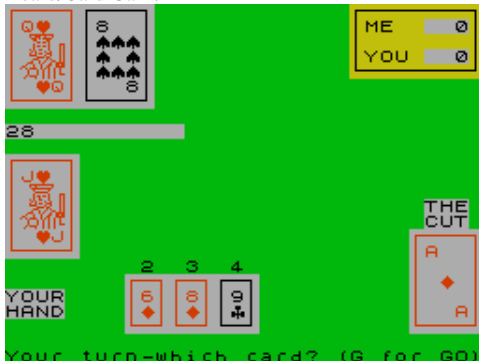

Cred Breaks Out (TSB,1986)
Arcade



Creta (MicroHobby,1985)
Arcade



Crevasse + Hotfoot (Microsphere,1982)
Compilation



Cribbage (Contrast Software,1983)
Board/Card Game



Cribb, The (Norman Wallace,1984)
Board/Card Game



Creepy Crawler (Mikro-Gen Ltd,1983)
Arcade



Crete 1941 (CCS,1991)
Strategy



Crewe Powerbox (Ashley Greenup,1992)
Simulation

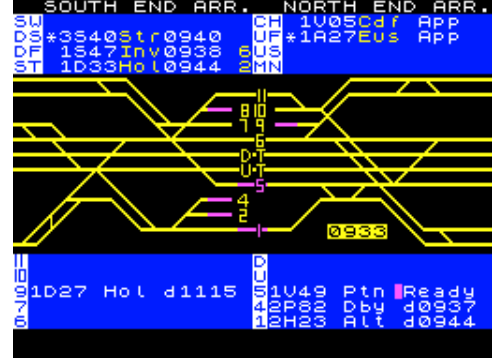

Cribbage (Gamma Software,1984)
Board/Card Game

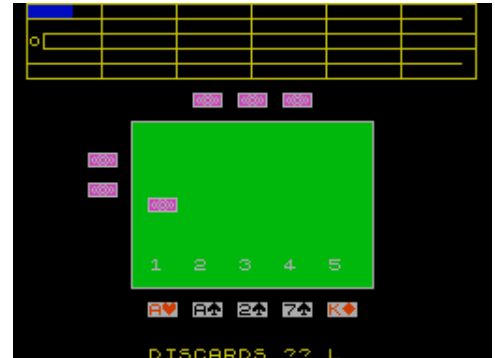

Cricket (Cambridge Microcomputer,1983)
Sport



Cricket (Sinclair Programs,1983)
Arcade

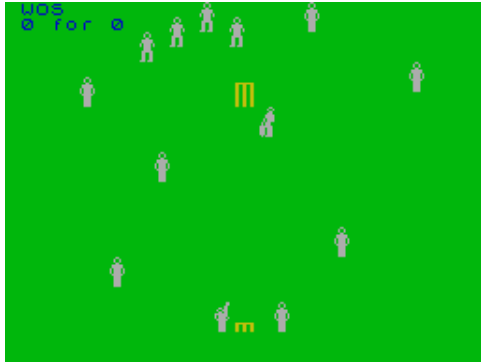

Cricket Averages (Hobby Software,)
Sport

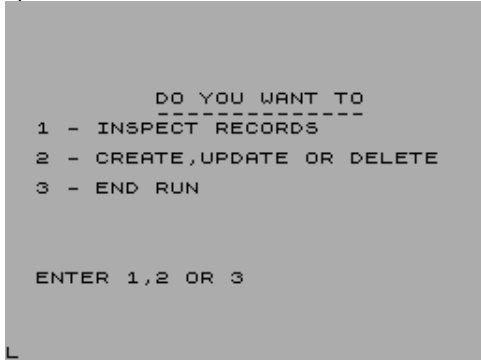

Cricket Captain (D&H Games,1988)
Simulation



Cricket Coach (Crash,1988)
Sport

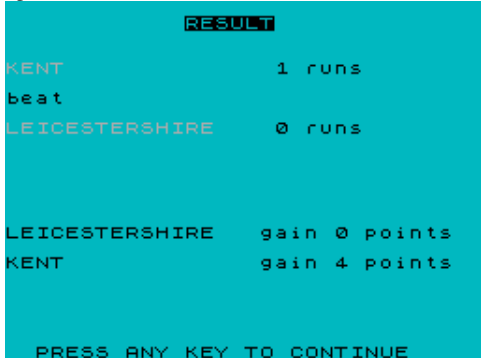

Cricket Player Data Cassette 1960s (Lambourne Games,1994)
Strategy



Cricket (Spartan Sport Association,1986)
Simulation



Cricket Averages (South Coast,1984)
Sport

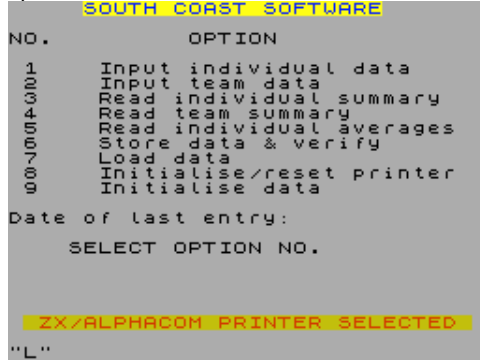

Cricket Captain (Hi-Tec Software Ltd,1990)
Sport



Cricket-Crazy (The Dreaming Djinn,1988)
Text Adventure

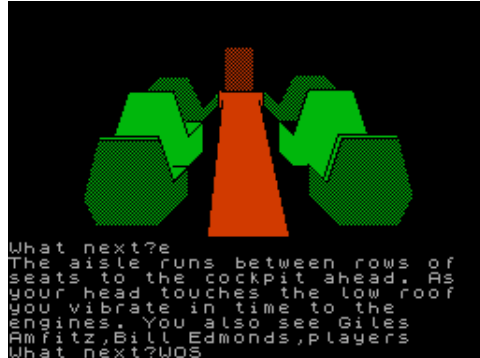

Cricket Player Data Cassette 1991 (Lambourne Games,1991)
Strategy



Cricket (T.J. Owen,1983)
Sport

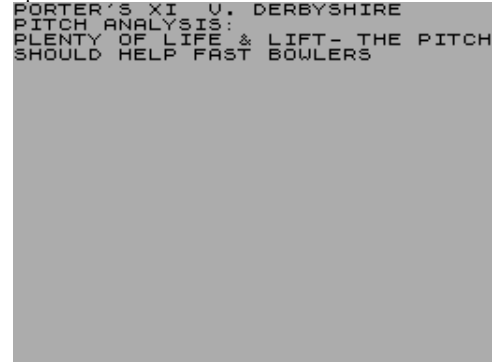

Cricket Captain (Allanson Computing,1984)
Simulation

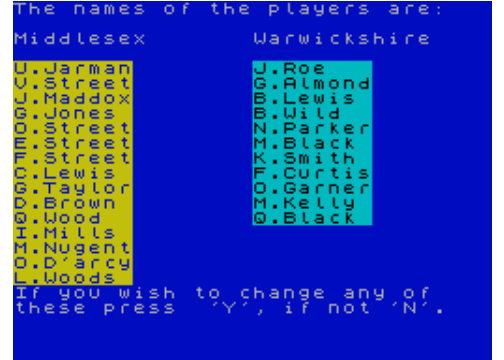

Cricket Challenge (Tanglewood Software,1987)
Sport



Cricket Master (E&J Software,1987)
Sport



Cricket Player Data Cassette 1994 (Lambourne Games,1994)
Strategy



Cricket Player Data Cassette All Time Greats 1
(Lambourne Games,1993) Strategy



Cricket Player Data Cassette All Time Greats 2
(Lambourne Games,1993) Strategy



Crime Busters (Players Software,1988)
Arcade

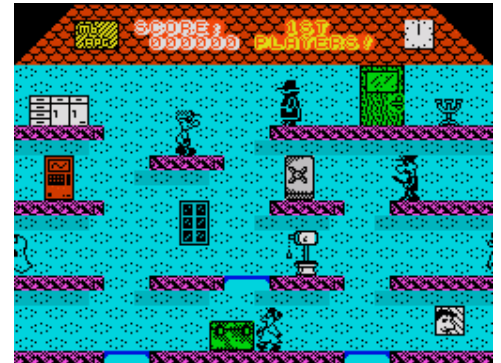

Crime Busters (Strobe,1986)
Arcade Adventure



Crimen Perfecto (MicroHobby,1986)
Text Adventure

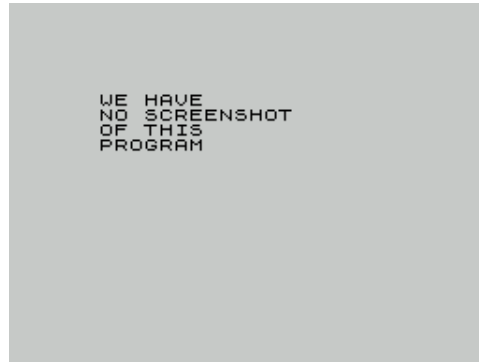

Crime Santa Clause (ETC Group,1996)
Arcade



Crime Santa Clause: Deja Vu (BrokImSoft/Rush
I.S.P.A.,1997) Arcade Adventure



Crime Santa Clause 2 (ETC Group,1996)
Arcade Adventure



Cristal Oscuro (MicroHobby,1986)
Arcade



Critical Mass (Durell Software Ltd,1985)
Arcade

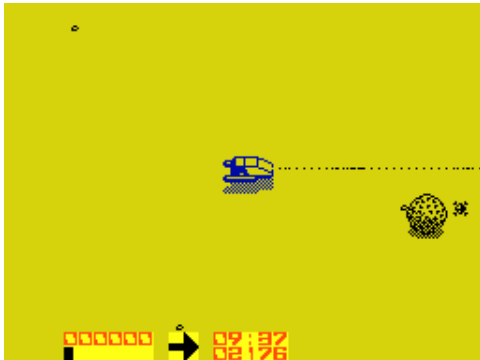

Critical Path Analysis (Hilderbay Ltd,1984)
Utility



Crocket's Theme (Technium 220.)
Scene Demo



Crockett's Theme (Coolguys Ltd,1999)
Scene Demo



Crokatile Walz (Romik Software,)
Arcade



Crom (Celerysoft,1987)
Text Adventure

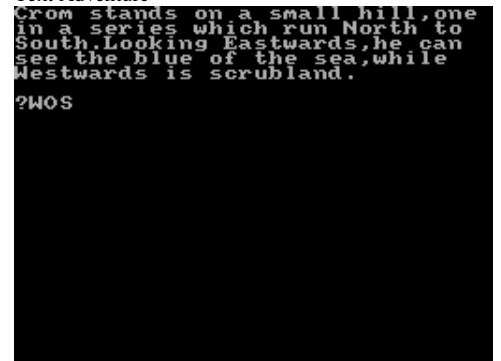

Cromwell at War 1642-1645 (CCS,1991)
Strategy



Cross (Compulogical S.A.,1987)
Sport



Crossfire (Atlantis Software Ltd,1991)
Arcade



Crossword (Phantom Ltd,1995)
Board/Card Game

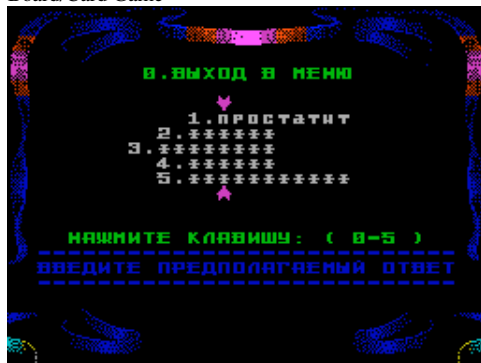

Crossword Puzzler (National Extension College Trust Ltd,1983) Utility

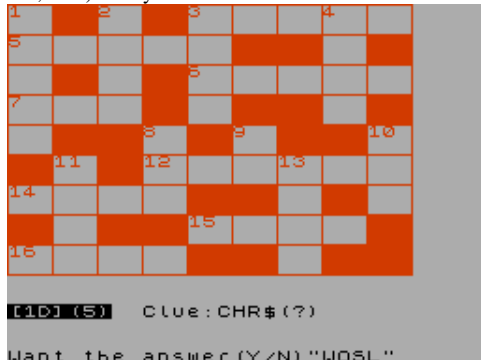

Cronos (Alfonso Fernandez Borro,)
Arcade

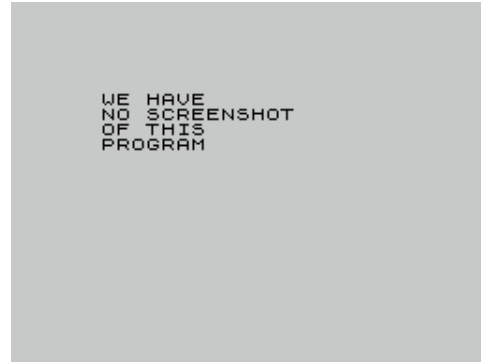

Crossbow (R. Gorman,)
Arcade

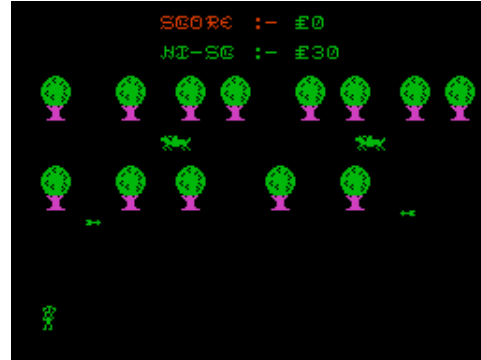

Crossfire (Your Computer,1985)
Arcade



Crossword (Razzlers,1998)
Board/Card Game

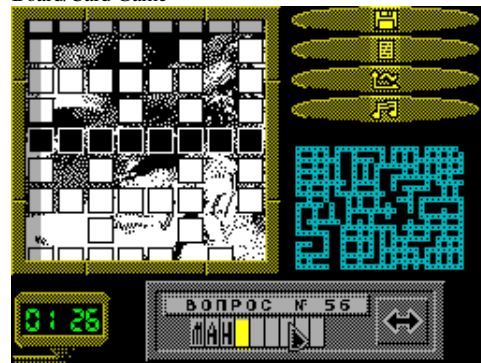

Crotabin (XFAWORLD Software,2005)
Arcade

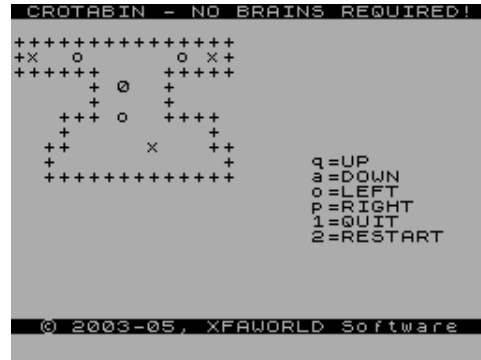

Crooked Adventure (Widgit Software Ltd,1984)
Arcade

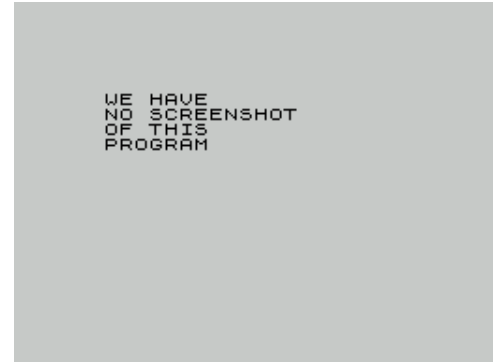

Crossbow - Legend of William Tell (Screen 7 Ltd,1989)
Arcade



Crosswise (Firebird Software Ltd,1988)
Arcade



Crossword Compiler (Byron Software,1985)
Board/Card Game



Crown Jackpot (Multisoft,1986)
Simulation

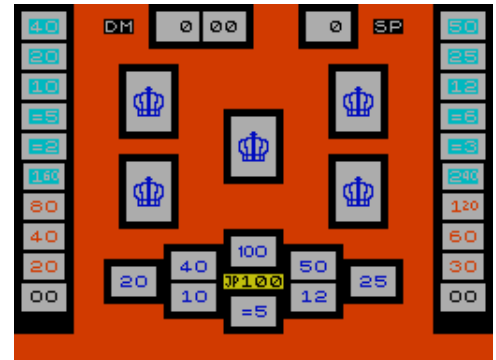

Crown Jewels, The (The Guild),
Text Adventure

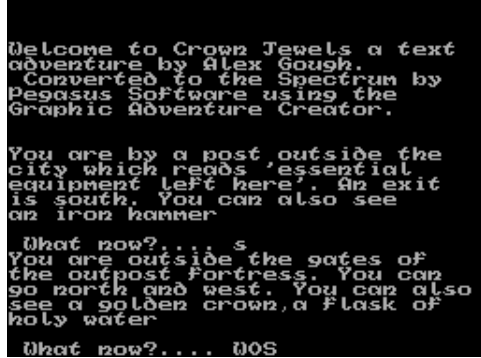

Crown of Ramhotep, The (Tartan Software,1987)
Text Adventure



Cruisaid (Eric Hutchinson,1985)
Utility



Cruising on Broadway (Solarsoft,1983)
Arcade

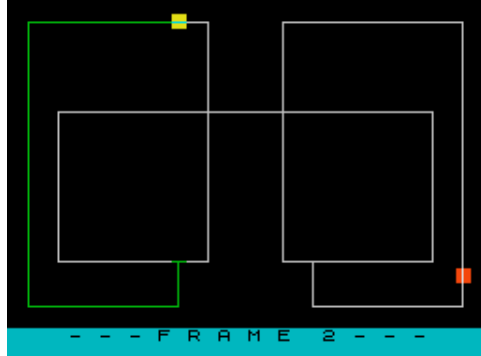

Crusher (Playgear Company,1996)
Arcade

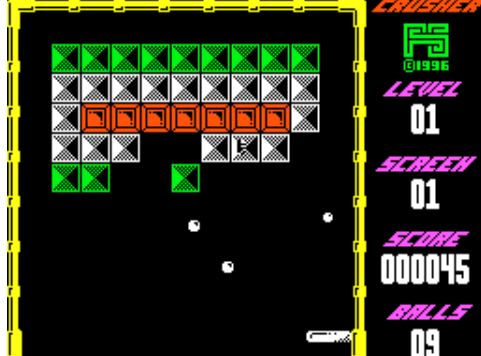

Crown - Journey, The (Wrightchoice Software,1987)
Text Adventure

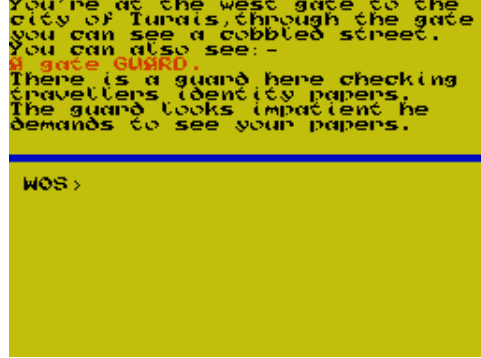

Crow Shoot (Stack Computer Services Ltd,1983)
Arcade



Cruise Attack (Mikro-Gen Ltd,1983)
Arcade

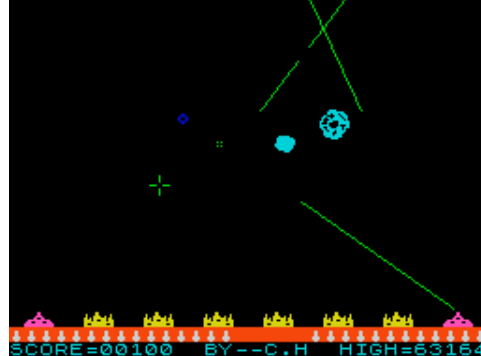

Crusade (Jade Software,1990)
Arcade



Crusoe (Automata UK Ltd,1984)
Arcade Adventure



Crown of Ramhotep + The Prospector, The (Tartan Software,1987) Compilation



Crozet (MicroHobby,1989)
Arcade



Cruise On (Mushroomsoft,1984)
Arcade



Crusader (SPE,1988)
Arcade Adventure

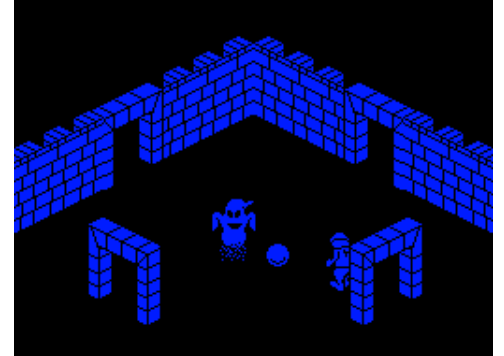

Crux 92 (Ultrasoft,1992)
Arcade

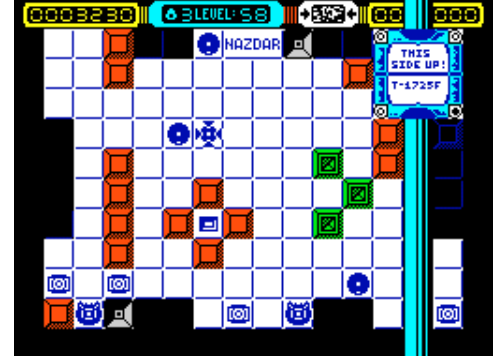

Cruz (MicroHobby,1985)
Board/Card Game

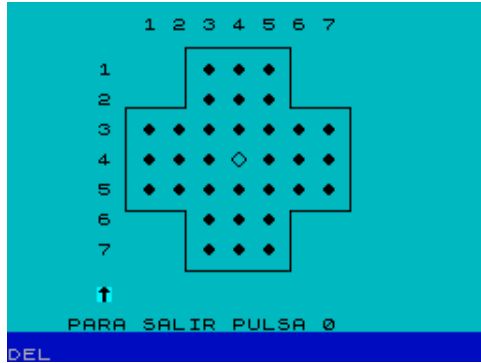

Crypt, The (Carnell Software,1984)
Arcade Adventure



Crystal Cavern (Dream Software Ltd,1984)
Text Adventure

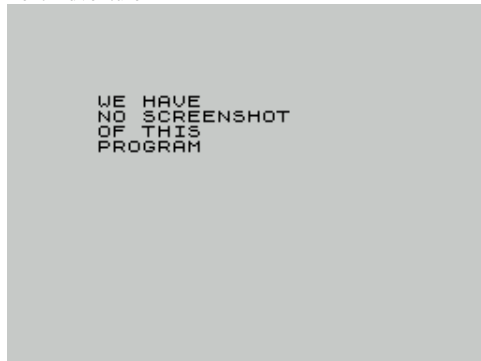

Crystal Frog, The (Kerian UK Ltd,1984)
Text Adventure



Crystal of Chantie, The (Pelagon Software,1987)
Text Adventure



Cruzado, El (Nuevo Software Espanol,1987)
Text Adventure

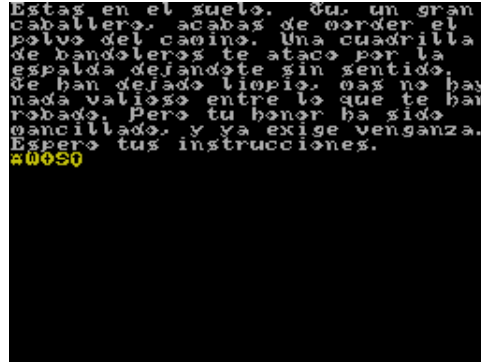

Crypt, The (Kuma Computers Ltd,1983)
Text Adventure



Crystal Cavern, The (Handasoft,1988)
Text Adventure

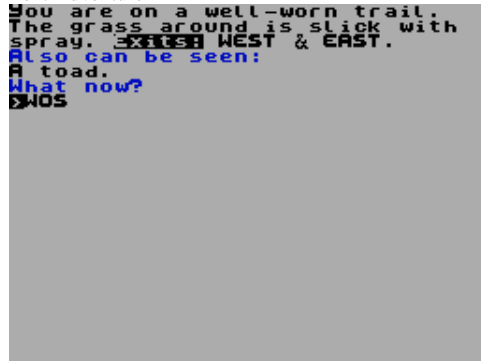

Crystal Kilodemo, The (Zack,1993)
Scene Demo



Crystal of Power, The (Fantasy Software [2],1989)
Text Adventure



Cruz, La (MicroHobby,1985)
Arcade

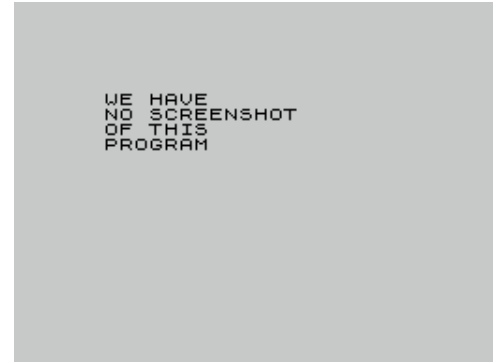

Crystal Castles (US Gold Ltd,1986)
Arcade

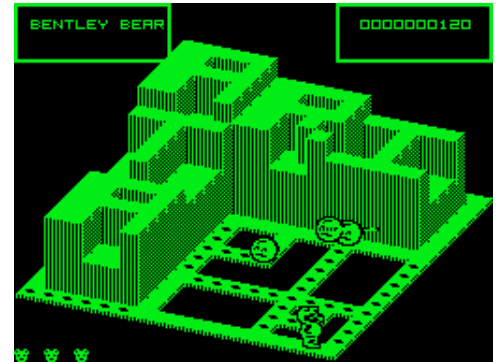

Crystal Dream Members in East Ukrainian State University (Crystal Dream,1996) Text Adventure

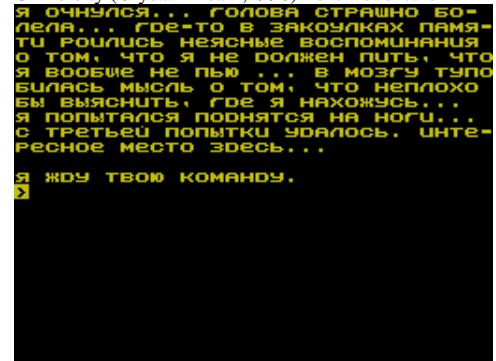

Crystal Kingdom Dizzy (Code Masters Ltd,1992)
Arcade

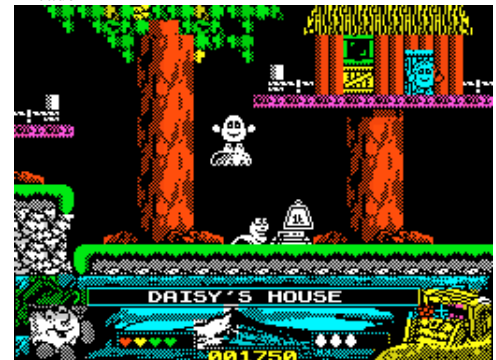

Crystal Quest (Chris Chadwick,1988)
Text Adventure



Crystal Quest (Keith Burnard,1984)

Arcade Adventure



Crystals of Doom (Time Assassin,1985)

Text Adventure

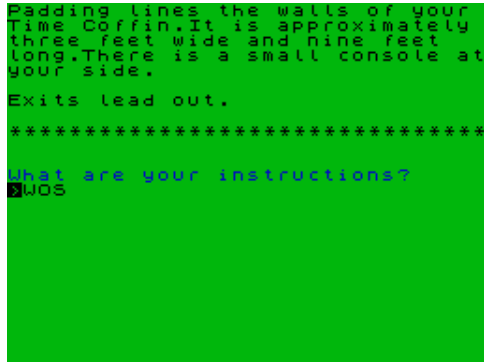

Cuatreros del Espacio, Los (MicroHobby,1985)

Arcade



Cuatro en Raya, Las (MicroHobby,1985)

Board/Card Game



Cube (CCS,1984)

Board/Card Game

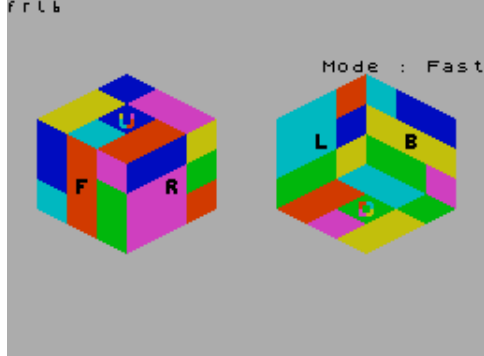

Crystal Quest (Pocket Money Software,1985)

Text Adventure

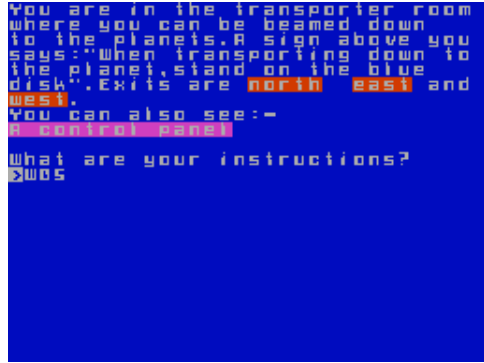

Crystals of Kings (Zenobi Software,1993)

Text Adventure



Cuatro en Raya + Rescate del Tesoro, Las (Investronica S.A.,1984) Compilation



Cuban Mission (BCL,1990)

Text Adventure



Cube, 3D (Spectrum Computing,1985)

Utility



Crystals (Yodasoft,1984)

Arcade



Cry Wolf (Custom Cables International Ltd,1983)

Text Adventure

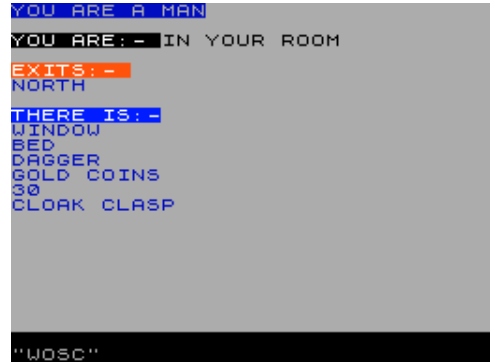

Cuatro en Raya, Las (Investronica S.A.,1984)

Board/Card Game



Cube (A. Pachler,1984)

Board/Card Game

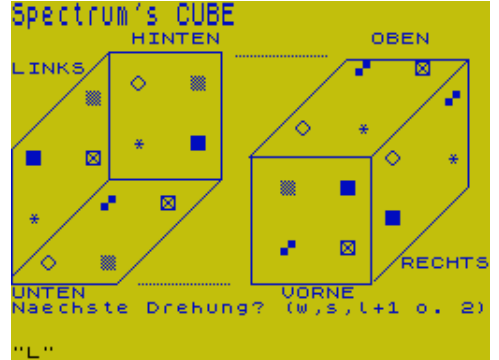

Cube, The (TGM Crew,1997)

Scene Demo

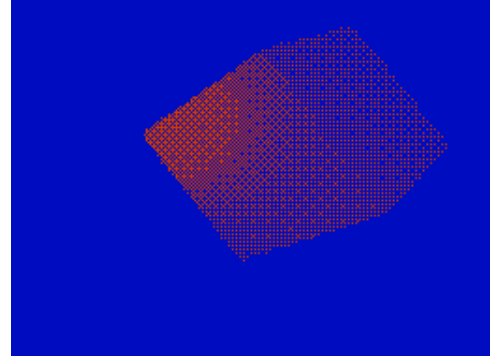

Cubeword (Mushroomsoft,1984)
Board/Card Game

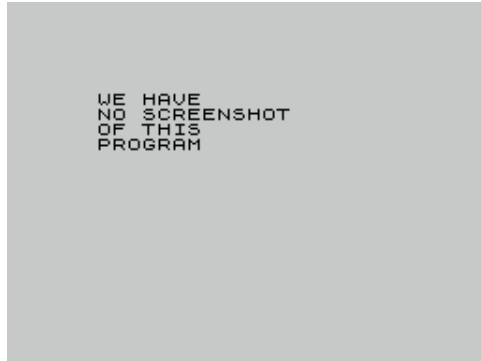

Cubey (Chad Software,1984)
Arcade



Cubo Rubik (MicroHobby,1985)
Board/Card Game



Cub Scout Pack (Nevis Records Ltd,1985)
Utility

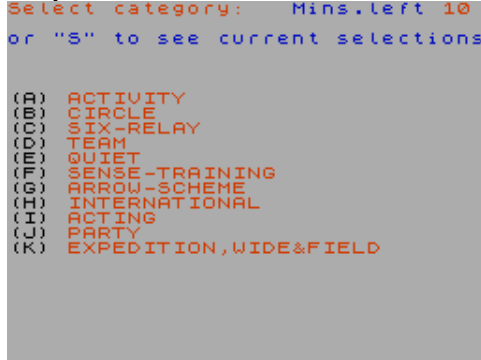

Cuddles (8th Day Software,1984)
Text Adventure

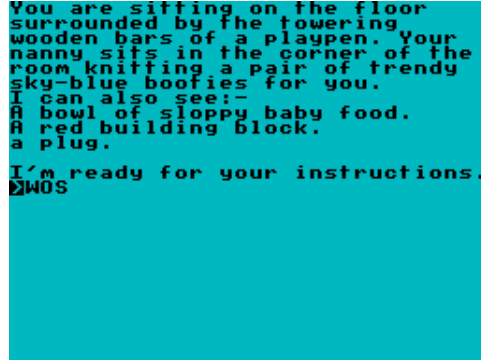

Cuddly Cuburt (Interceptor Micros Software,1983)
Arcade



Cudesni Mac (Colin,1985)
Arcade



Cue Boy (Code Masters Ltd,1992)
Arcade



Cuentas Bancarias (Computer Software,1983)
Utility



Cuerpo Humano (,)
Educational

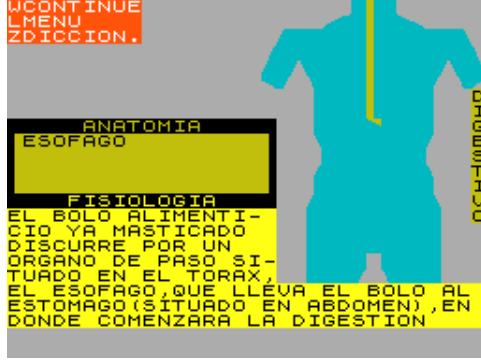

Cueva de Naulen, La (Palamar Software,2005)
Arcade

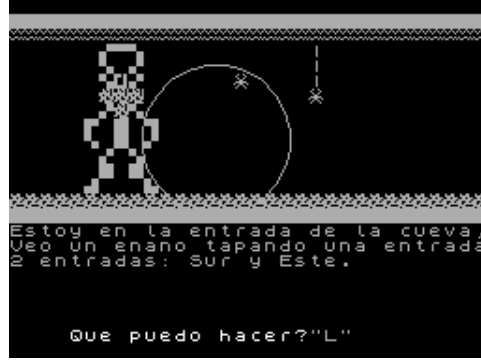

Cuevas de Snake, Las (MicroHobby,1986)
Arcade



Cup and Bowl (Griffin Software,1984)
Educational

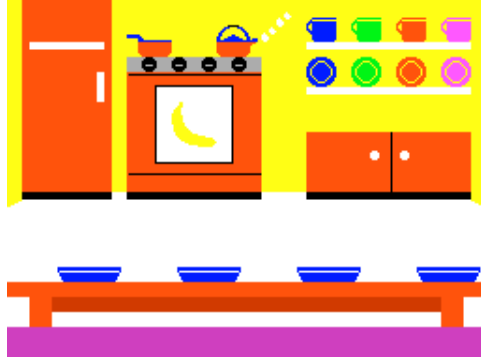

Cup Football (Cult Games,1988)
Simulation

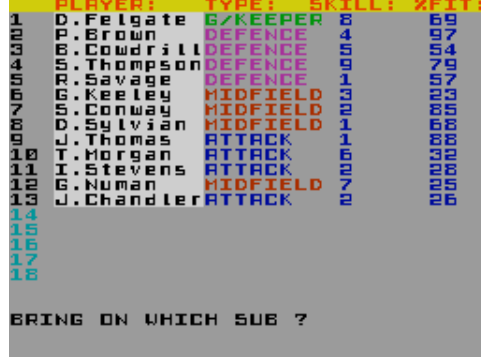

Cup Manager (GTI Software,1990)
Strategy



Cup, The (River Software,1987)
Text Adventure

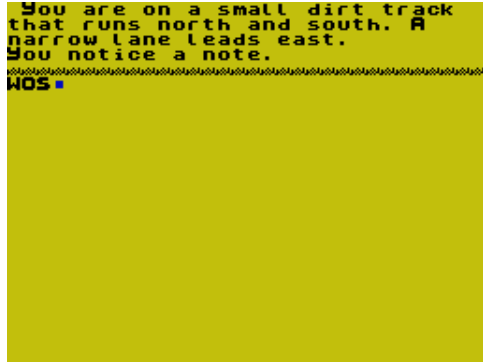

Curro Jimenez (Zigurat Software,1989)
Arcade



Curse of Nimue (Zenobi Software,1995)
Text Adventure

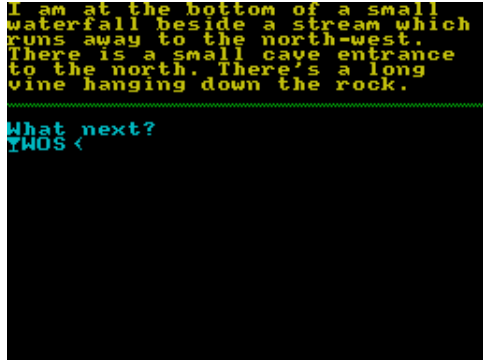

Curse of Sherwood, The (Mastertronic Ltd,1987)
Arcade Adventure



Curse of the Mushroom People, The (Global Software,1986)
Text Adventure



Currah MicroSpeech (Currah Computer Components Ltd,1983)
Utility

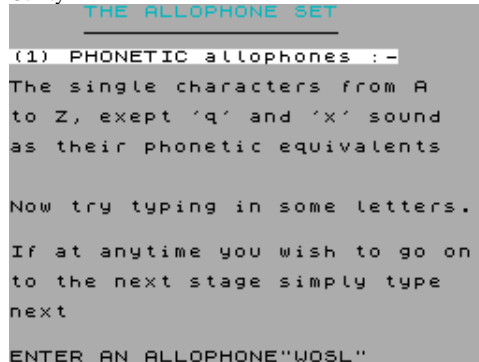

Curse by the City (Incantation,1986)
Text Adventure



Curse of Shaleth + Desperado (Central Solutions,1986)
Compilation



Curse of the Crown (Bubblebus Software,1988)
Text Adventure



Curse of the Serpent's Eye (Martin Freemantle,1993)
Text Adventure

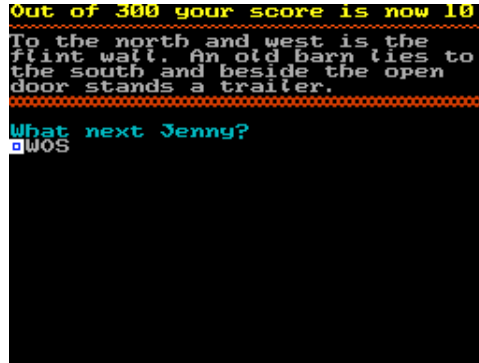

Current Contenders Cassette - As at 28-02-90 (Lambourne Games,1990) Simulation



Curse of Calutha (Zenobi Software,1991)
Text Adventure

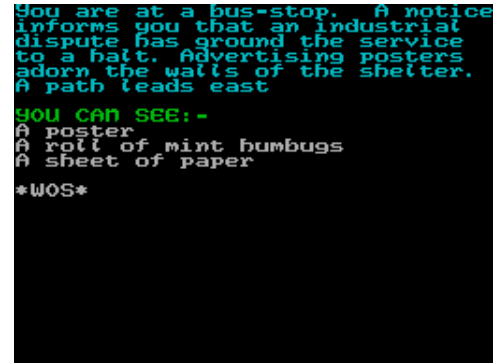

Curse of Shaleth, The (Central Solutions,1985)
Text Adventure



Curse of the Flying Pigmies (Electric Abacus,1984)
Arcade



Curse of the Seven Faces (Artic Computing Ltd,1985)
Text Adventure

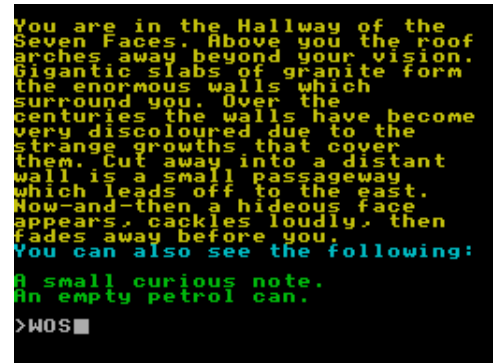

Curse of Xeen (Concern Chaos,1999)
Arcade

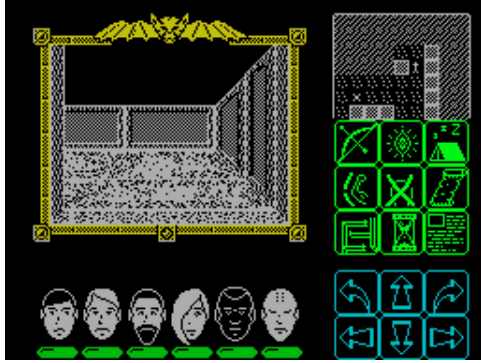

Cursorspel (.)
Arcade

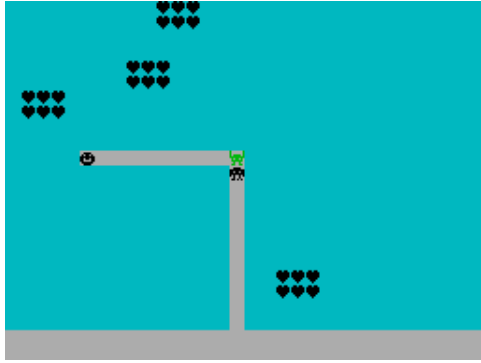

Custard Kid, The (The New Generation Software,1985)
Arcade Adventure



Custodian (Hewson Consultants Ltd.)
Arcade



CW (Pearsons Computing,1987)
Utility



Curse, The (Gilsoft International,1983)
Text Adventure

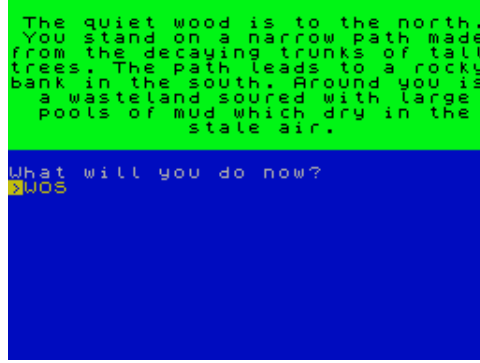

Cursos Educativos - Matematicas (Monser S.A.,1985)
Educational

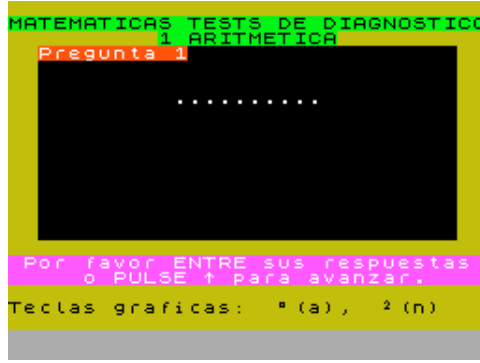

Custard Pie (16/48 Tape Magazine,1985)
Educational



Cut Your Heating Bills (Brane Software,1984)
Utility



CW QSO (Pearsons Computing,1987)
Utility



Cursor Draw (Man Software,1994)
Utility: Drawing



Curvas Hipocicloides (MicroHobby,1985)
Utility



Custer's Quest (The Power House,1986)
Text Adventure



CVG Rockfall (C&VG (Gamebook),1985)
Arcade



Cyberball (Domark Ltd,1990)
Arcade



Cyberbig (Animagic S.A.,1989)
Arcade



Cybermoid (Hewson Consultants Ltd,1988)

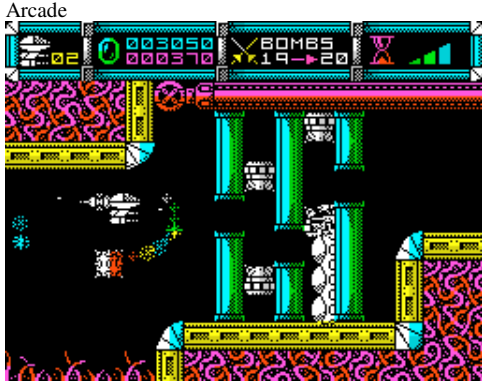

Cybertanks (Star Dreams,1984)

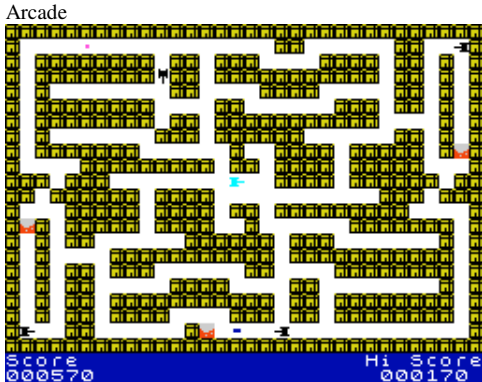

Cybox (Pirate Software Ltd,1987)

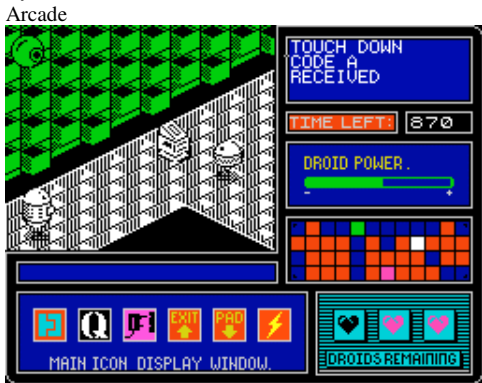

Cybo Run + Super Gran (Dixons,1985)

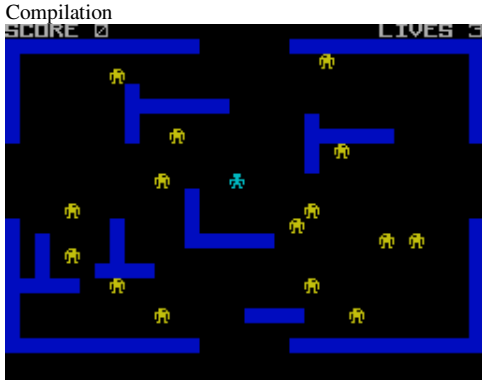

Cyberknights (CRL Group PLC,1988)
Arcade

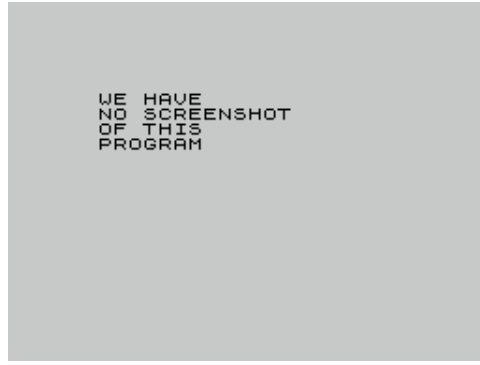

Cybermoid II: The Revenge (Hewson Consultants Ltd,1988) Arcade

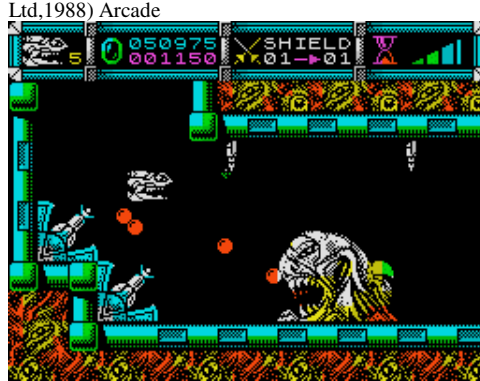

Cyberun (Ultimate Play The Game,1986)



Cyborg (CRL Group PLC.)



Cybotron (Micromania,1983)



Cybernation (Players Software,1989)
Arcade Adventure

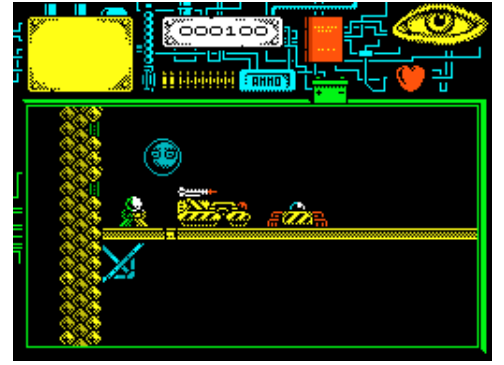

Cyber Rats (Silversoft Ltd,1982)

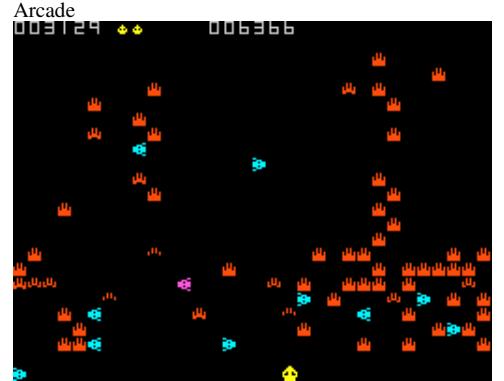

Cyber Zone (Crystal Computing,1984)



Cybo Run (Calisto,1984)

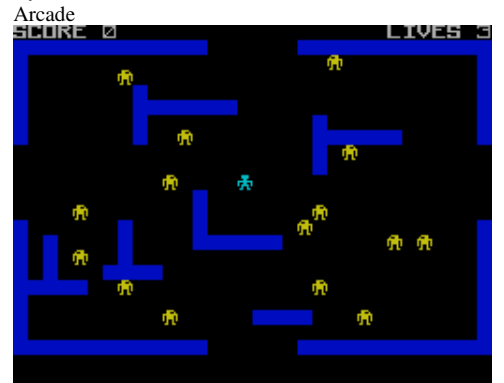

Cycle Planner/Growth Tracker (Medidata,1983)



Cycles, The (Accolade Inc,1989)
Arcade



Cyclone (Vortex Software,1985)
Arcade



Cyrox (The Power House,1986)
Arcade



Cytologie (Future Design,1985)
Simulation

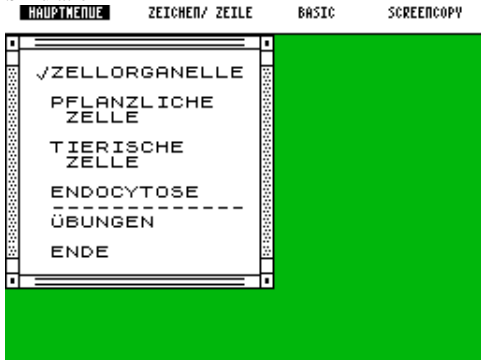

DA-1 (new) (Claus Jahn,1987)
Utility: Assembler/Disassembler/Monitor



Cycle Trap (N. Stewart/P. Walker,1986)
Arcade

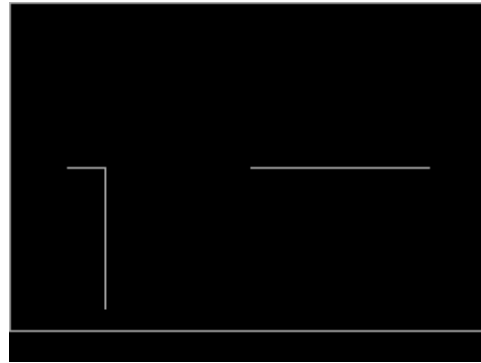

Cylu (Firebird Software Ltd,1985)
Arcade



Cyrus II (Alligata Software Ltd,1986)
Board/Card Game



CZ101 Editor (XRI Systems,1987)
Utility

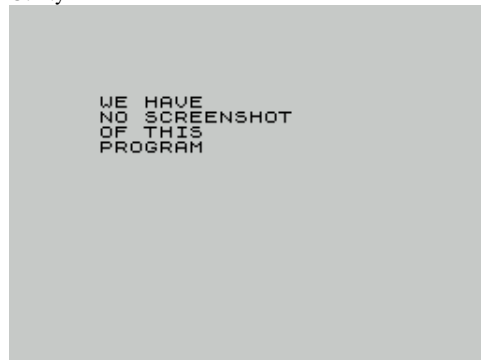

DA-1 (old) (Claus Jahn,1987)
Utility: Assembler/Disassembler/Monitor



Cycling (Scetlander,1988)
Educational

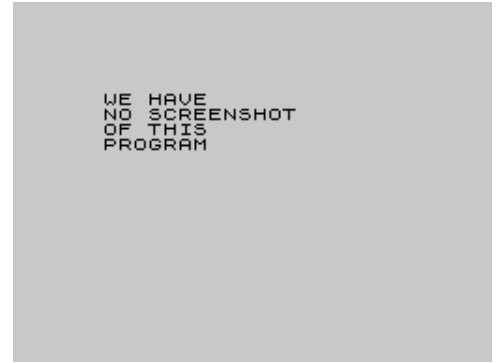

Cypher (,)
Board/Card Game

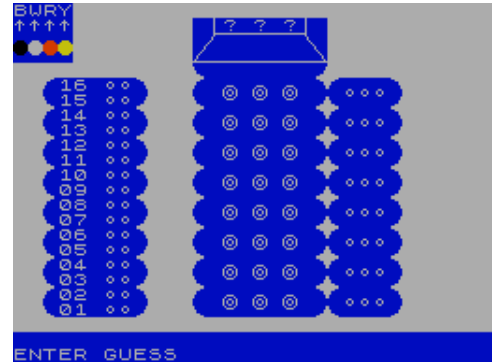

Cyrus IS Chess (Sinclair Research Ltd,1983)
Board/Card Game



D-37 (Beja Soft,)
Text Adventure



DA-2 (Claus Jahn,)
Utility: Assembler/Disassembler/Monitor

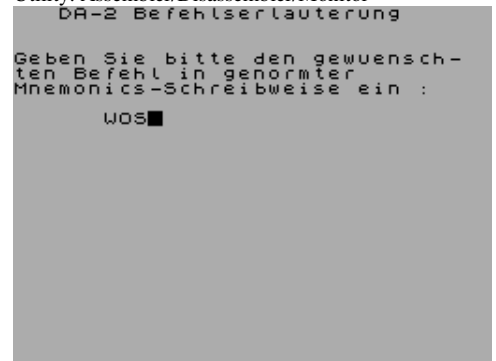

Dack Demo, The (Coolguys Ltd,1988)
Scene Demo



Dados (MicroHobby,1985)
Board/Card Game



Dalek Attack (Alternative Software Ltd,1992)
Arcade Adventure

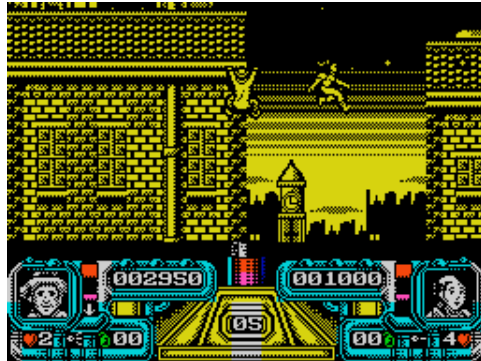

Daley Thompson's Olympic Challenge (Ocean Software Ltd,1988) Sport

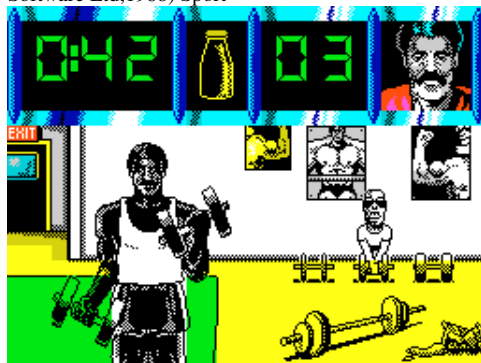

Dama (.)
Board/Card Game



Dada Demo (Busy Software,)
Scene Demo



Daemon (Delta 3 Software,)
Text Adventure



Dalek Dan (Starzone Software,1984)
Arcade



Daley Thompson's Supertest (Ocean Software Ltd,1985)



Dama 2005 (Laszlo Nyitrai,2005)
Board/Card Game

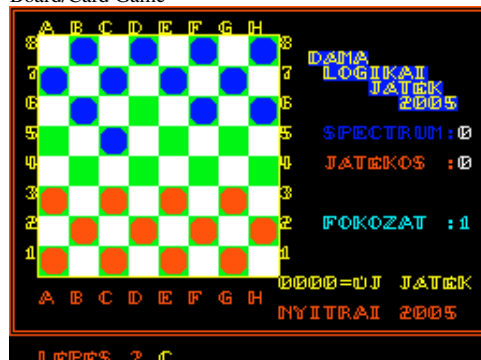

Dados (.)
Arcade



Daffy Duck (Hi-Tec Software Ltd,)
Arcade



Daley Thompson's Decathlon (Ocean Software Ltd,1984)



Dallas (CCS,1982)
Strategy



Damage, Inc (The Power House,)
Arcade



Dam and Blast (IEC Software,1986)
Educational

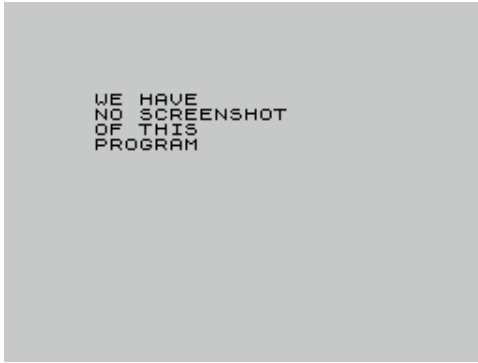

Damas (MicroHobby,1986)
Board/Card Game



Dam Buster (Sinclair User,1983)
Arcade

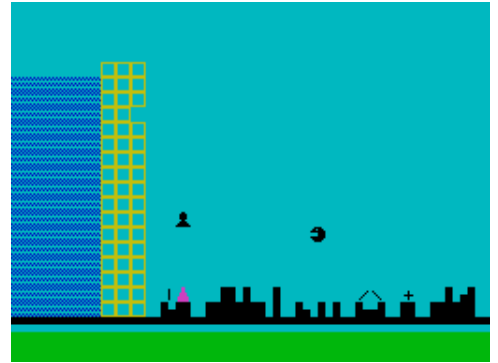

Dam Busters (Professional Software,1984)
Simulation



Dam Busters (Virgin Books,1983)
Arcade

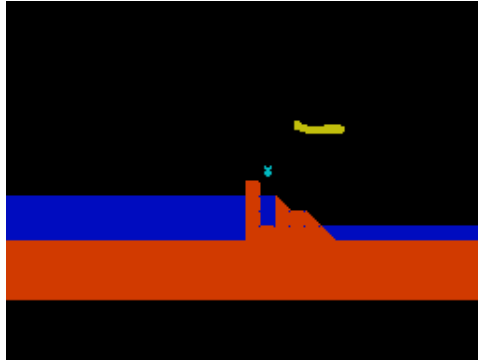

Dam Busters, The (US Gold Ltd,1985)
Simulation

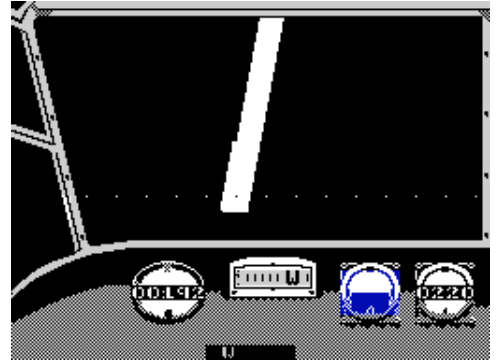

Dame (.)
Board/Card Game

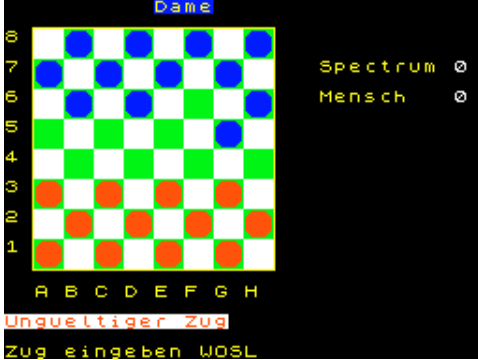

Dame de Monsoreau, La (IKO & RGSof,1987)
Text Adventure

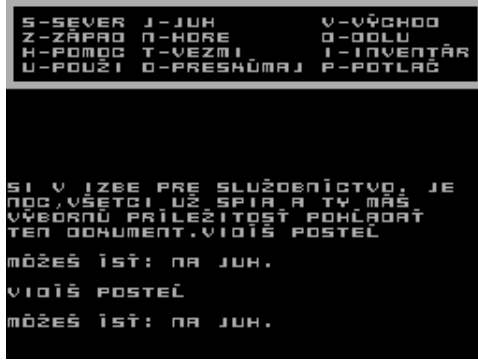

Damero (Ediciones y Textos S.A.,1985)
Board/Card Game



Damn (L.P.G. Nagels,1984)
Board/Card Game



Damned Forest, The (Cult Games,1988)
Text Adventure



Damocles (Novagen Software Ltd.)
Arcade



Dance Fantasy (Fisher-Price Learning Software,1984)
Educational



Dancer, The (Outlet Microdrive Magazine.)
Scene Demo



Dances with Bunny Rabbits (The Adventure Workshop,1993)
Text Adventure

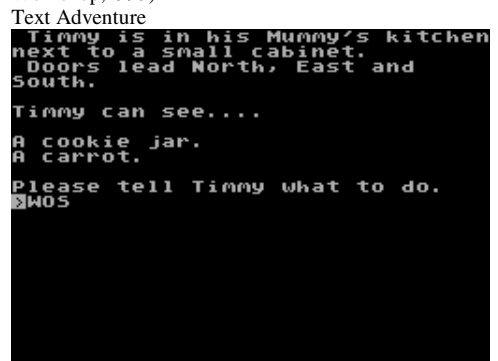

Dancing (Axel Soft,1989)
Scene Demo



Dan Dare II: Mekon's Revenge (Virgin Games Ltd,1988)
Arcade



Dandy (Electric Dreams Software,1986)
Arcade

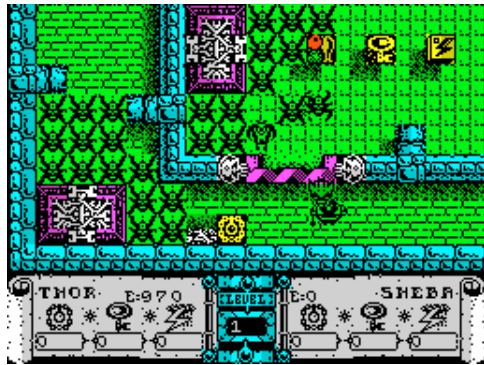

Danger! Adventurer at Work 2 (The Guild,1992)
Text Adventure



Danger Mouse in the Black Forest Chateau (Creative Sparks,1984) Arcade



Dan Dare: Pilot of the Future (Virgin Games Ltd,1986)
Arcade

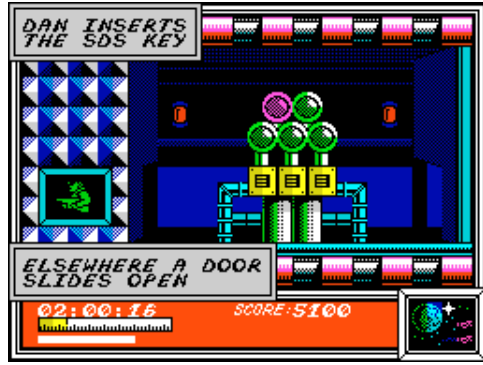

Dan Dare III: The Escape (Virgin Games Ltd,1990)
Arcade

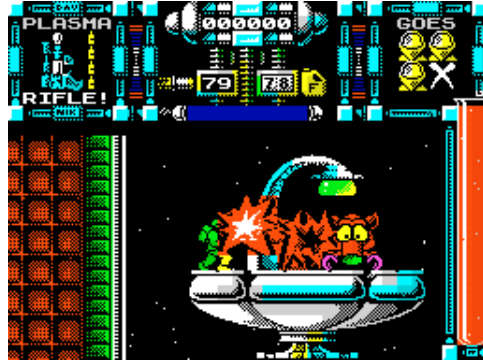

Danger (Jorge Perez Barreiro,1987)
Arcade



Danger Mouse in Double Trouble (Creative Sparks,1984)
Arcade



Dangerous Garden (CV Software,1988)
Arcade



Dan Dare Collection (Dro Soft,)
Compilation



Dan Diamond Trilogy, The (Salamander Software,1984)
Compilation



Danger! Adventurer at Work! (The Guild,1991)
Text Adventure



Danger Mouse in Making Whoopee! (Creative Sparks,1985)
Arcade



Dangerous Gardens (Your Computer,1984)
Arcade



Dangerous Kiss (CIHC,1988)
Arcade



Dan Rodjenja (.)
Utility



Dardos (MicroHobby,1985)
Sport

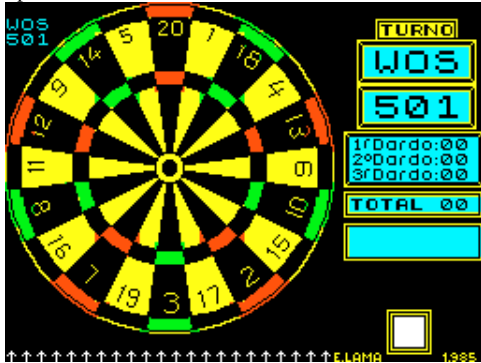

Darius+ (The Edge Software,1990)
Arcade

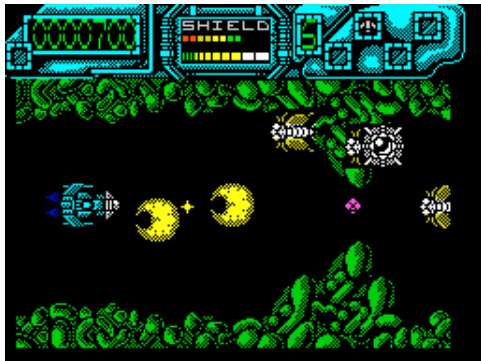

Dark Century (Titus,.)
Arcade

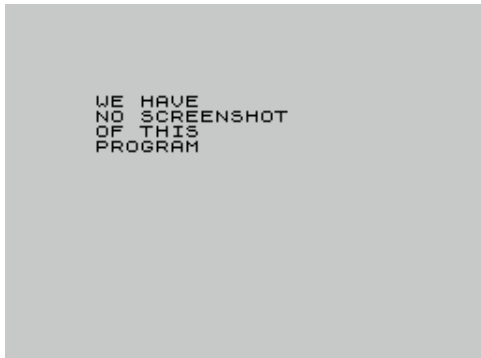

Danger Street (Manuel Soft,1990)
Text Adventure

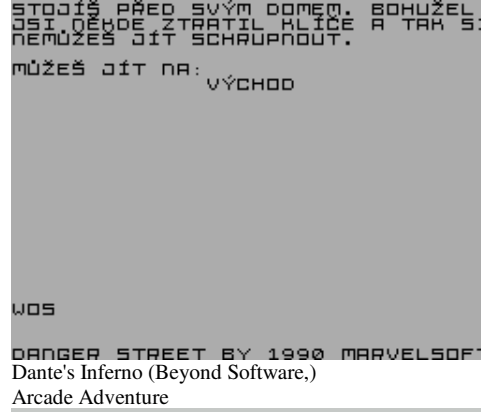

Dargonscrypt (Venom Games,1987)
Text Adventure



Dark Castle (Mark Crumby,1987)
Arcade Adventure

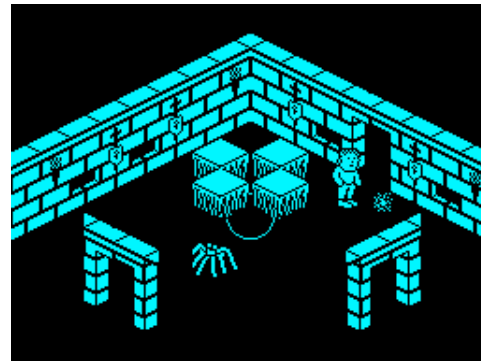

Dark Corridor (Alien Software,1993)
Text Adventure

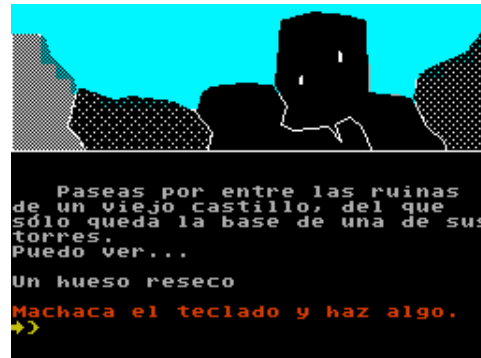

Danny Duster's Dirty Deeds (Flashsoft,.)
Arcade



Danton Trash Cleaner & Destroyer (Danton Studio,1987)
Utility

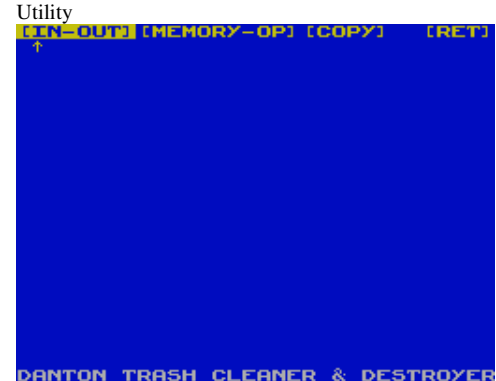

Darion: Child of a Stargazer (Alphabatim,1986)
Arcade

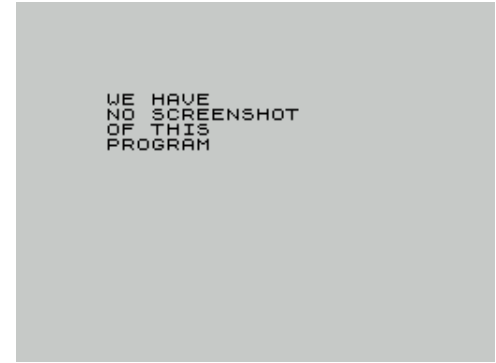

Dark Castle (Mirrorsoft Ltd,.)
Arcade

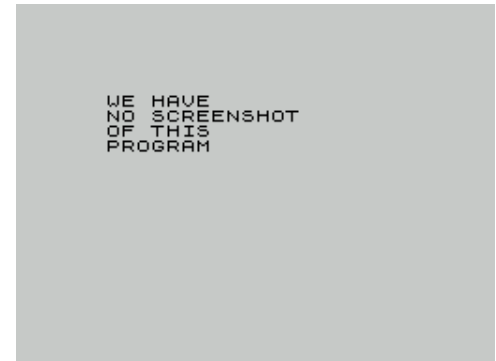

Dark Empire (MC Lothlorien Ltd,1987)
Strategy

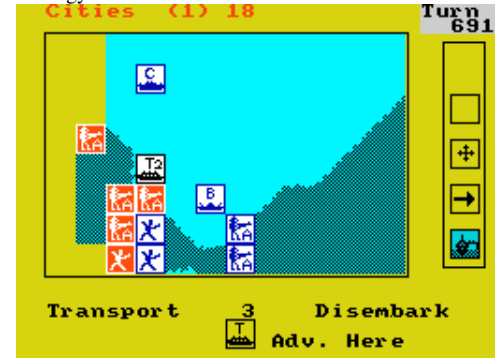

Darkest Road (Zenobi Software,1991)
Text Adventure



Darkest Road 2: 'Twas a Time of Dread (Zenobi Software,1991) Text Adventure



Darkest Road 3: The Unborn One (Zenobi Software,1991)
Text Adventure



Dark Force (Ocean Software Ltd,1990)
Compilation

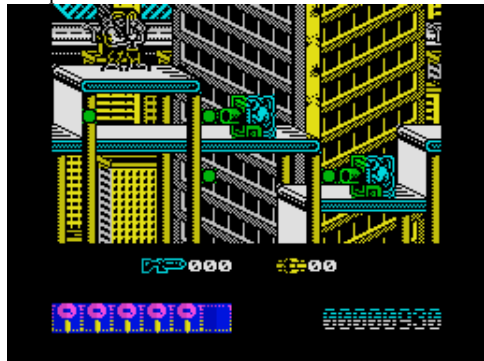

Dark Forest (Sinclair User,1984)
Text Adventure

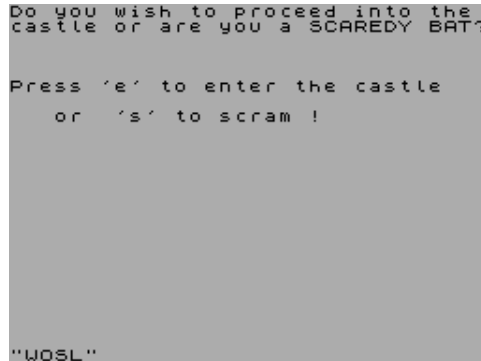

Dark Fusion (Gremlin Graphics Software Ltd,1988)
Arcade

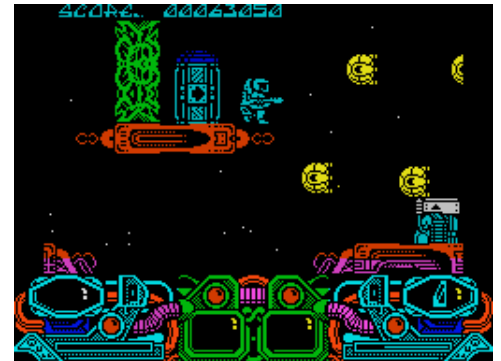

Dark Gladiator, The (FSF Adventures,1993)
Text Adventure



Darkhouse (Arkham Software,1993)
Text Adventure



Dark Lore (8th Day Software,1983)
Text Adventure

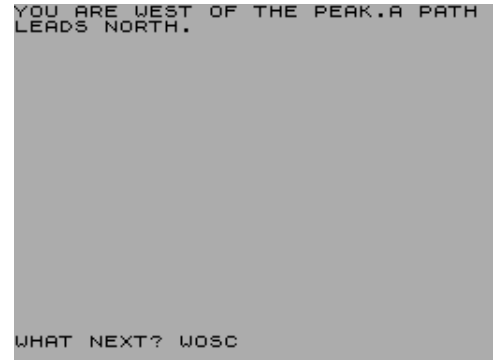

Darkman (Ocean Software Ltd,1991)
Arcade Adventure

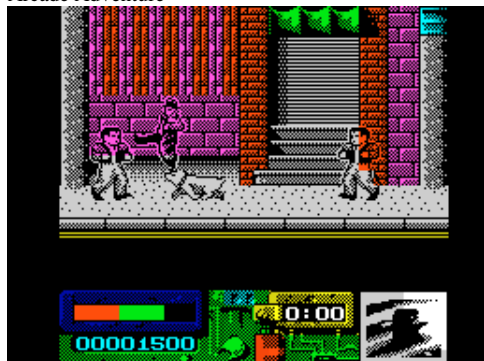

Dark Sceptre (Firebird Software Ltd,1987)
Arcade Adventure



Dark Side (Incentive Software Ltd,1988)
Arcade

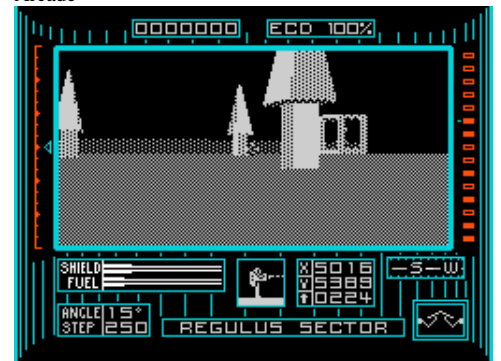

Dark Sky over Paradise (Interactive Technology,1990)
Text Adventure

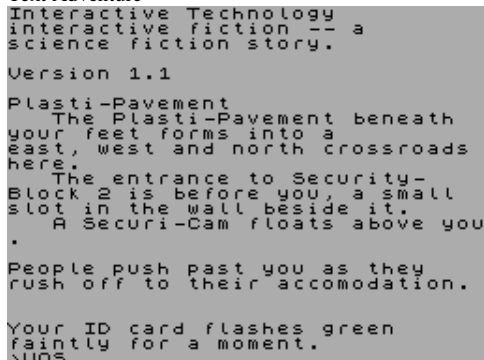

Dark Square (Last Masters Group,1998)
Board/Card Game



Dark Star (Design Design Software,1984)
Arcade



Dark Storm (Global Games [1],1989)

Text Adventure



Dark Tower (River Software,1992)

Text Adventure

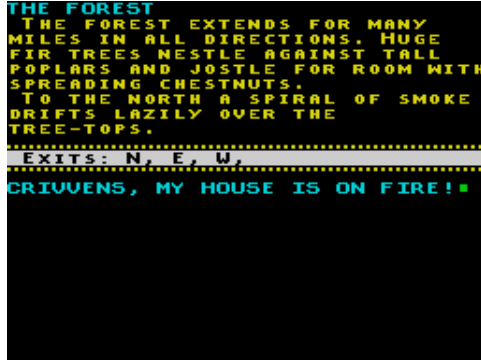

Darts (Sinclair Programs,1985)

Arcade

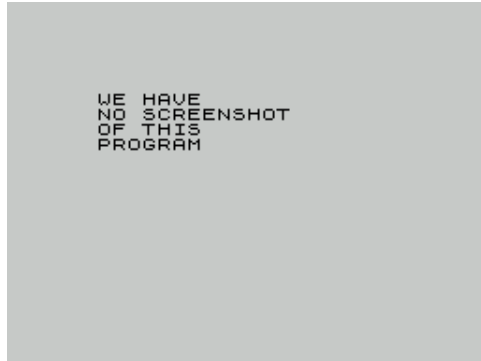

Dartz (Automata UK Ltd,1984)

Sport



Database (Gemini Marketing Ltd,1982)

Utility: Database

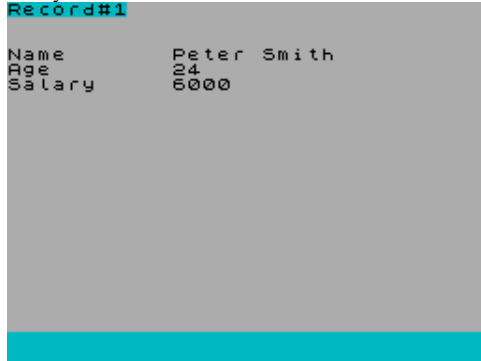

Dark Strengths (Omikron Software [2],1990)

Text Adventure



Darkwing Duck (U99,1999)

Arcade

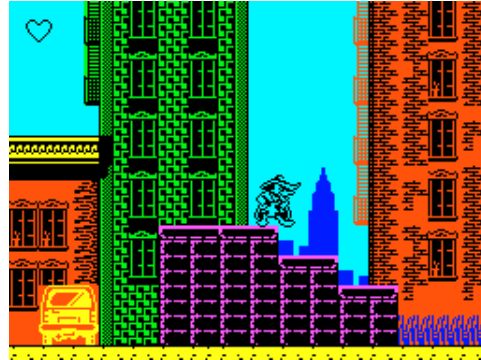

Darts (Soft 2000,1985)

Sport

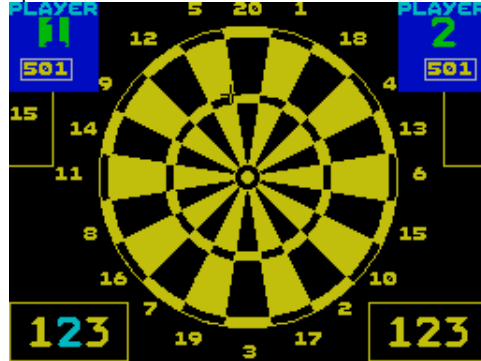

Das Boersenspiel (.)

Utility



Database (Microbyte,)

Utility: Database



Dark, The (Sergey Hanzis,1994)

Arcade

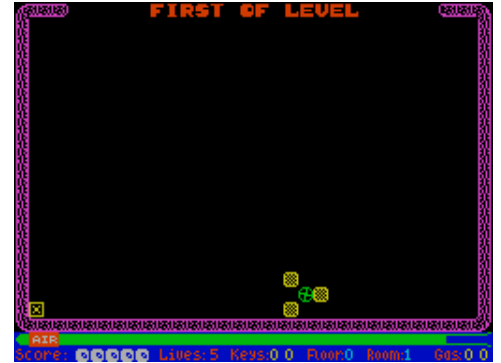

Darts (Mr. Chip Software,1983)

Sport

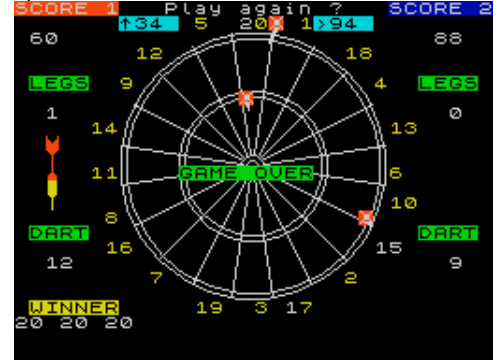

Darts Lord (The Lords,1989)

Scene Demo

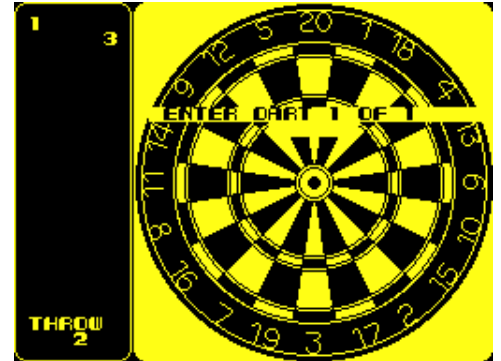

Das Broot (Coo Coo Soft,1994)

Scene Demo

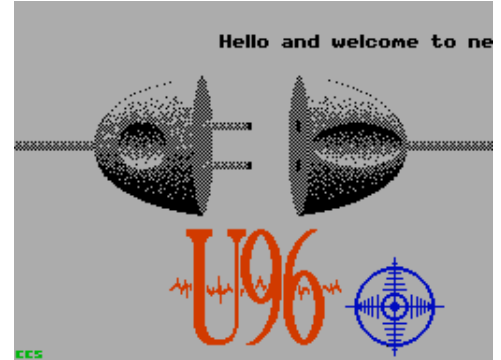

Database (MicroHobby,1985)

Utility: Database



Database (MiCROL,1982)

Utility: Database

```
#W05
123
_ERM
```

Database II (Foraits Software,1987)

Utility: Database

```
WE HAVE
NO SCREENSHOT
OF THIS
PROGRAM
```

Data East's Arcade Alley (US Gold Ltd,1988)

Compilation



Data Graph (Microtechnica,1987)

Utility

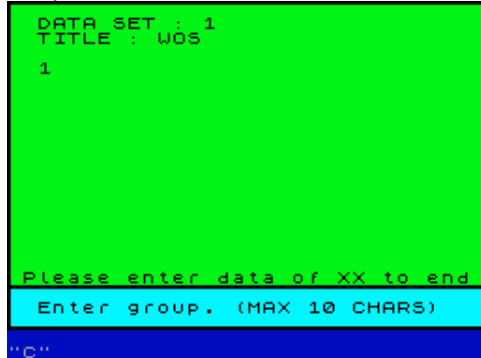

Datalog 2 Turbo (Ultrasoft,1992)

Utility: Database

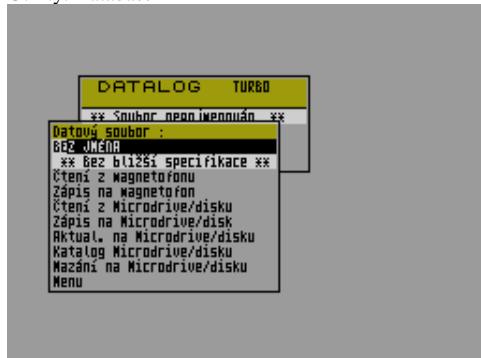

Data-Base (R.E. Stephens,)

Utility: Database

```
Radio Amateur Data Base
There are five sections
1 Enter new callsign
2 Change the details
3 Search Routines
4 Print entire record
5 Save the program

Enter your option
```

Data Display (Shiva Publishing Ltd,1983)

Utility: BASIC Related



Data File (Sinclair User,1983)

Utility: Database



Datahits (Mupados,1986)

Utility

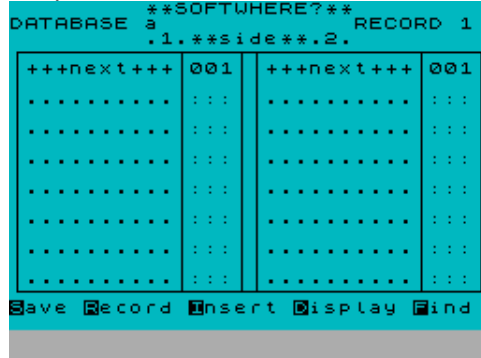

Datamaker (Spectrum Computing,1985)

Utility



Data-Base + Morse (R.E. Stephens,)

Compilation



Datador (MicroHobby,1985)

Utility: Database



Data Genie (Audiogenic Software Ltd,1984)

Utility: Database



Datakit (Profisoft,1984)

Utility

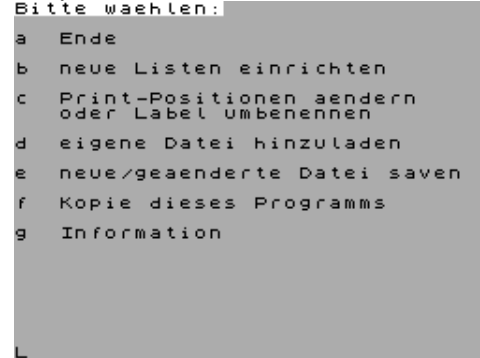

Datamat (Stephan Slabihoud,1986)

Utility: Database



Datasette Legi (JWE Software,) Utility



Daten Manager 84 (MHS Muller Hard & Software,1984) Utility: Database



Dave's Dilemmas 3 (MNL Software,1987) Educational



Davy Jones Locker (River Software,1987) Text Adventure

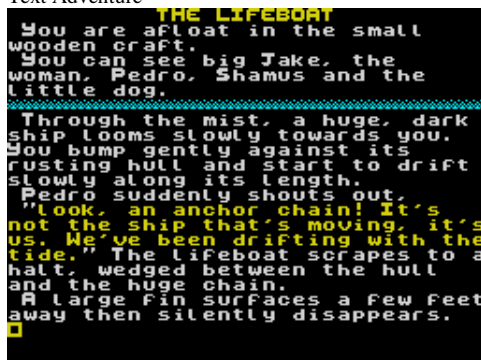

Day at the Seaside, A (Softlee Systems,1985) Educational



Datel Utilities (Datel Electronics,) Compilation



Dave's Dilemmas 1 (MNL Software,1987) Educational



David (Proxima Software,1991) Utility: Copier



Dawnssley (Top Ten Software,1987) Arcade



Dayfinder (Shiva Publishing Ltd,1983) Utility



Datenbank (,) Utility: Database

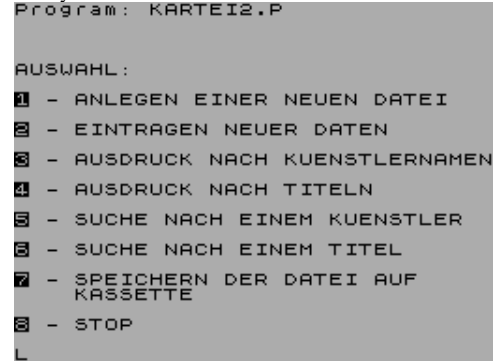

Dave's Dilemmas 2 (MNL Software,1987) Educational

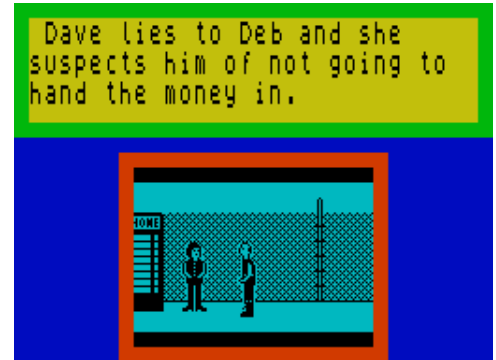

David el Gnomo (Compological S.A.,1986) Board/Card Game



Day at the Races, A (Sinclair User,1983) Arcade



Day in the Life, A (Micromega,1985) Arcade

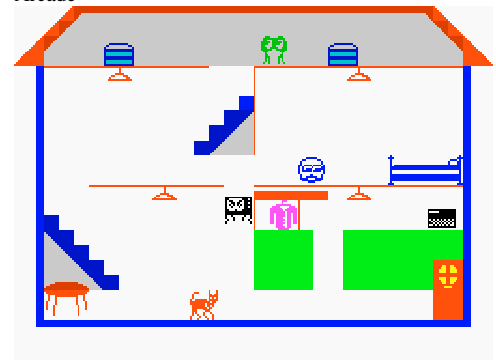

Day in the Life of Arnold, A (Hippo Enterprises,1990)
Arcade

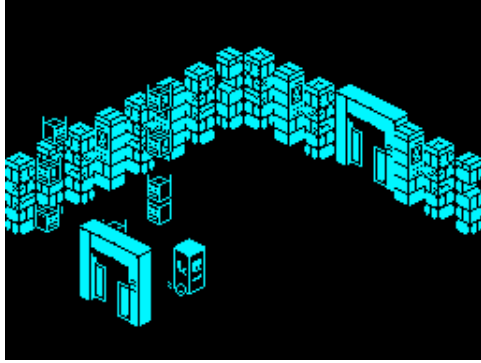

Day in the Life of a Tupperware Salesman, A (The Adventure Workshop,1995) Text Adventure

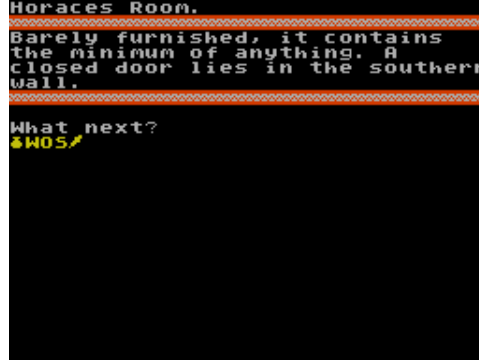

Daylight Robbery (Sinclair Research Ltd,1982)
Arcade



Day of the Match (Video Software Ltd,1984)
Simulation

Arsenal	000	000	110	000	110	000	110	000
Aston Villa	000	000	110	000	110	000	110	000
Birmingham	000	000	110	000	110	000	110	000
Covertry	000	000	110	000	110	000	110	000
Everton	000	000	110	000	110	000	110	000
Ipswich	000	000	110	000	110	000	110	000
Leicester	000	000	110	000	110	000	110	000
Liverpool	000	000	110	000	110	000	110	000
Luton	000	000	110	000	110	000	110	000
Manchester U	000	000	110	000	110	000	110	000
Norwich	000	000	110	000	110	000	110	000
Nottingham F	000	000	110	000	110	000	110	000
Notts County	000	000	110	000	110	000	110	000
O.P.Rangers	000	000	110	000	110	000	110	000
Southampton	000	000	110	000	110	000	110	000
Stoke	000	000	110	000	110	000	110	000
Sunderland	000	000	110	000	110	000	110	000
Tottenham H	000	000	110	000	110	000	110	000
Watford	000	000	110	000	110	000	110	000
West Brom A	000	000	110	000	110	000	110	000
West Ham U	000	000	110	000	110	000	110	000
Wolverhampton	000	000	110	000	110	000	110	000

Days of Thunder (Mindscape International Inc,1990)
Arcade



Day Trip (.)
Text Adventure



DB1 (Kobraisoft,1988)
Utility: Copier



DB2 (Kobraisoft,1989)
Utility: Copier



D.C. (SciCAL Software Ltd,1983)
Educational

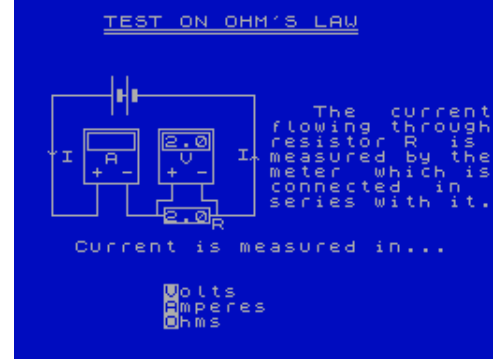

D-Day (Games Workshop,1984)
Strategy



Deactivators (Reaktor,1986)
Arcade

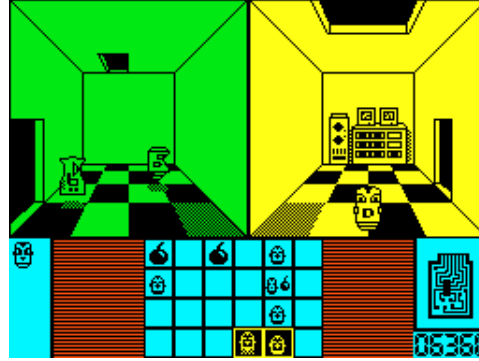

Dead at the Controls (Artic Computing Ltd,1985)
Text Adventure



Dead End (Interactive Technology,1990)
Text Adventure

5.6PM Wednesday, September 15th, 1941

Office

A window behind my desk blinked a neon message for a moment then dulled, the office pausing in darkness only to reappear like a rabbit pulled out of a magicians top hat as the neon blinked again.

Rain battered at the windows noisily.

>

>

>w

(I couldn't do that.)

Thunder boomed through the windows.

>W05

Deadenders (Top Ten Software,1989)
Text Adventure

Copyright...The Dreaming Djinn

Effls flat is cosy and comfortable. All her furniture has been with her for many years and she considers each piece a personal friend. Exits are NE & Up. You can also see Effl,Willies basket

She is very distressed. When questioned about Willie she howls " The last time I saw him he was sniffing round the bins at the back of the caff. I looked again and he was gorn, and now I've lost my Willie." Effl runs from the room, presumably looking for her dog, leaving you to resume your investigations.

What now Guv?

What now Guv?W05

Dead Eyed Dick (Sinclair User,1985)
Arcade

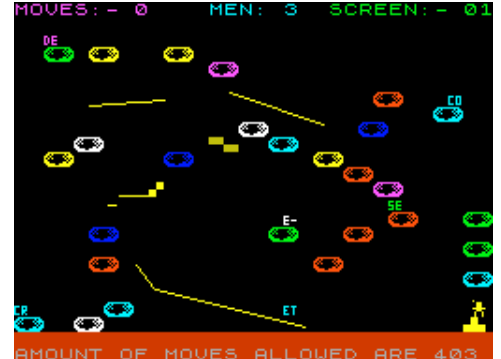

Deadly Evil (Players Premier Software,1990)
Arcade Adventure



Deadly Silence (Elven Adventurers,1991)
Text Adventure



Dead or Alive (Cronosoft,2003)
Arcade



Dea Tenebrarum (System 4,1988)
Arcade

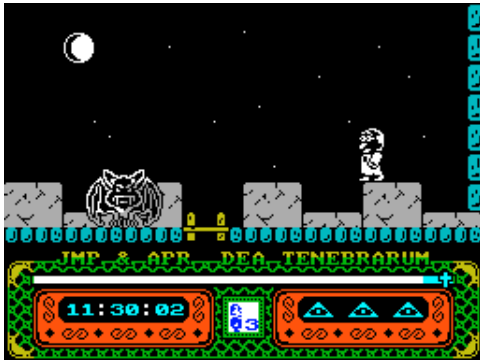

Death Bringer (The Guild.)
Text Adventure

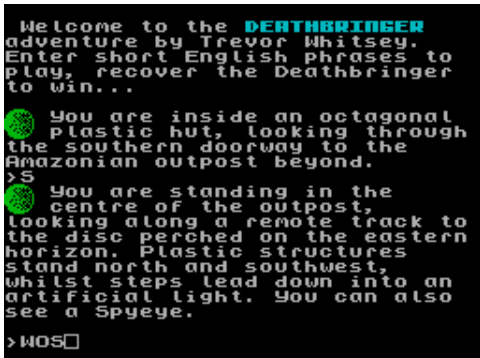

Deadly Mission (John Henry Enterprises,1987)
Text Adventure

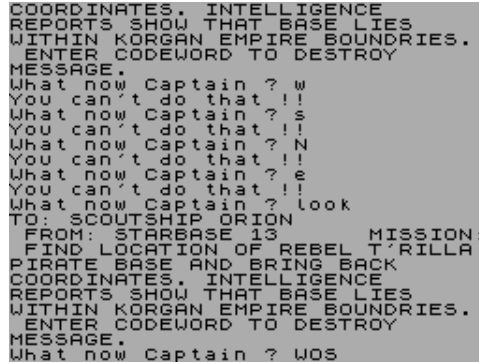

Deadly Skeletons (Prophics Software,1990)
Arcade



Dead Ringer (Reaktor,1987)
Arcade



Deathball 2000 (Alpha-Omega Software,1986)
Arcade



Deathchase (Micromega,1983)
Arcade

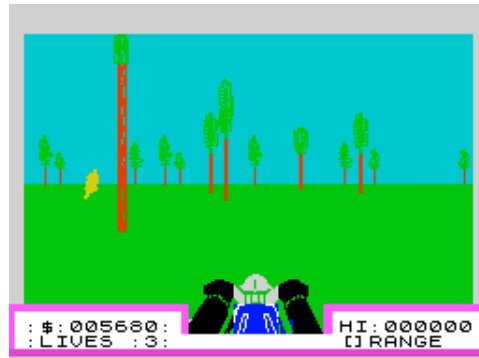

Deadly Mission, The (Computer Gamer,1994)
Text Adventure

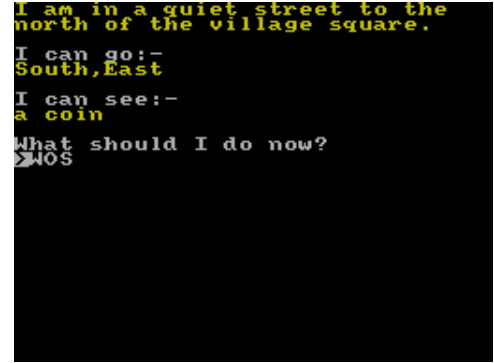

Dead or Alive (Alternative Software Ltd,1987)
Arcade



DeadZone (Alternative Software Ltd.)
Arcade

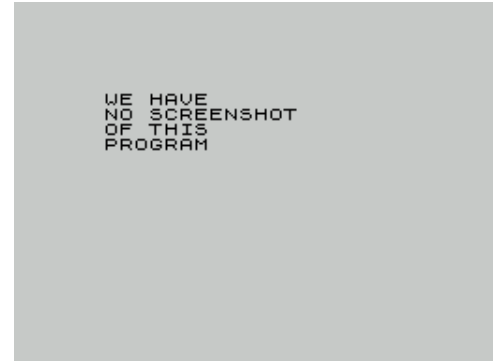

Death Before Dishonour (Alternative Software Ltd,1987)
Arcade



Death Chess 5000 (Artic Computing Ltd,1984)
Board/Card Game



Death Cruiser (Noble House Software,1983)
Arcade

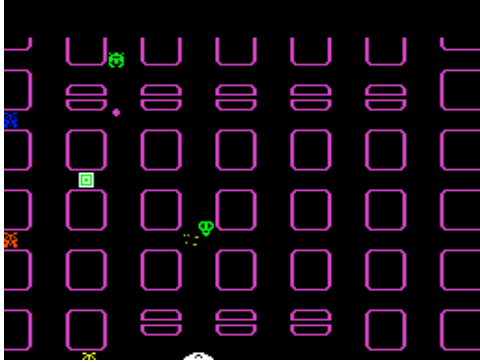

Death in Russia 1941 (MC Lothlorien Ltd,1986)
Strategy



Deathman (Valuesoft,1983)
Arcade



Death Pit (Durell Software Ltd.)
Arcade



Death Reprieve + Time Machine (5D Software,1984)
Compilation



Deathdroid (Mark Schultz,1990)
Arcade



Death in the Snow 1812 (MC Lothlorien Ltd,1986)
Strategy



Death or Glory (CRL Group PLC,1987)
Arcade

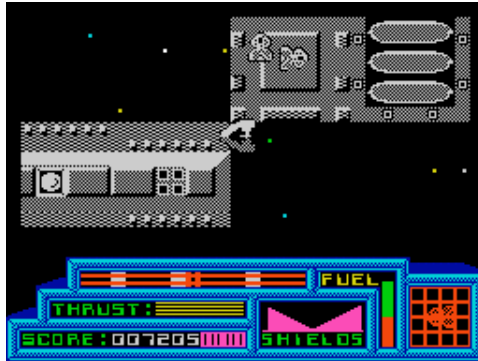

Death Race (Virgin Books,1983)
Arcade



Deathrider (Matt Barber,2007)
Arcade

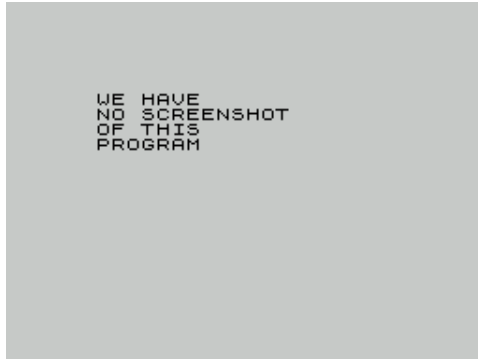

Death Game (Werewolves Graphics,1997)
Board/Card Game



Death Kalah (3T Software,1996)
Board/Card Game



Death or Glory (Dream World Adventures,1993)
Text Adventure

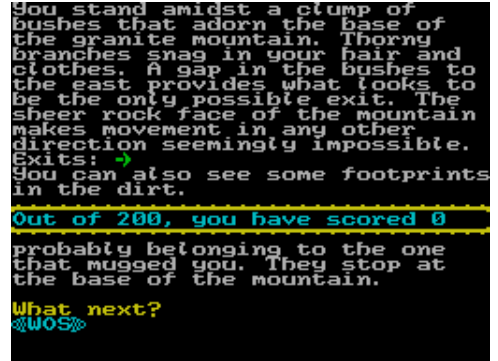

Death Reprieve (5D Software,1984)
Arcade



Deathscape (Starlight Software,1987)
Arcade



Death's Head Hole (Peaksoft,1983)
Text Adventure

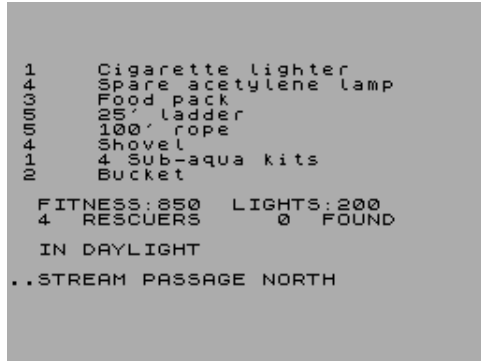

Death Star (Rabbit Software Ltd,1984)
Arcade



Deathtrap Mine (Valuesoft,1983)
Arcade

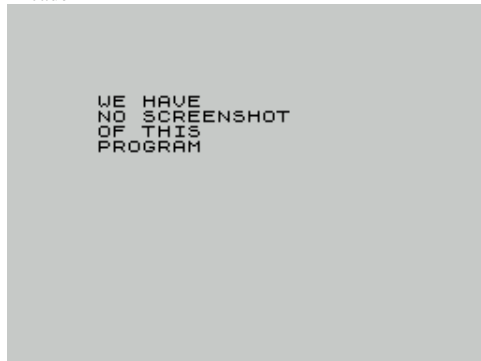

Death Wish 3 (Gremlin Graphics Software Ltd,1986)
Arcade



Debut (Convention,1993)
Scene Demo



Death Stalker (Code Masters Ltd,1989)
Arcade



Death Star Interceptor (System 3 Software Ltd,1985)
Arcade



Death Wake (Quicksilver Ltd,1985)
Arcade

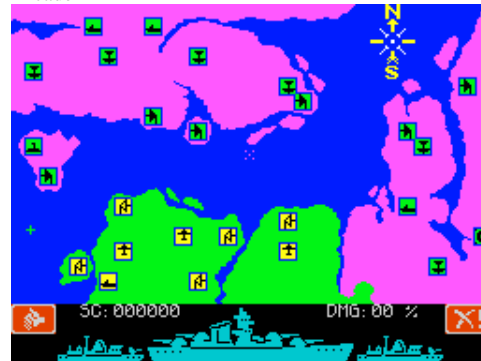

Death Zone (Sinclair User,1989)
Arcade



Decimals (Keysoft,1987)
Educational



Deathstar (Amazing Games,1985)
Arcade



Death Trap (Video Showcase,1984)
Arcade

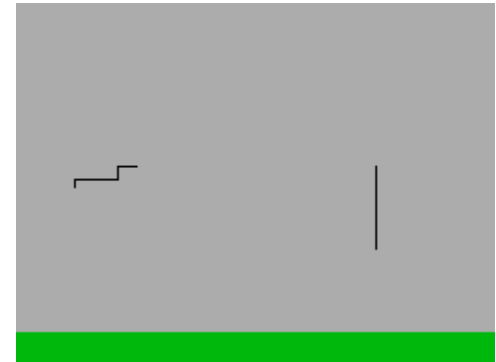

Deathwish (Merlin Software [1],1983)
Arcade

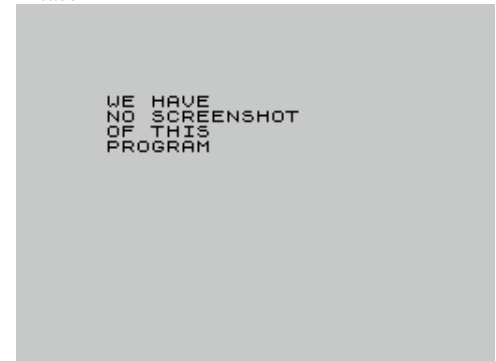

Debug A\$ (Claus Jahn,1987)
Utility: Assembler/Disassembler/Monitor
157



De Cine (Erbe Software S.A.,)
Compilation



Decision Maker (Collins Educational,1985)

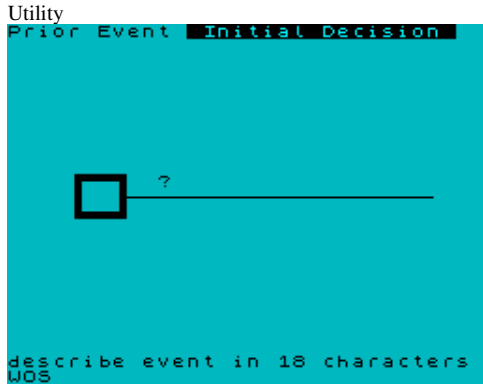

De Copas en Nueva York (MicroHobby,1985)



Deek's Deeds (Bass-On,1991)



Deep Scan (OCTOCOM,2005)



Deep, The (US Gold Ltd,1988)



Decoder (Jochen Merz,1984)



Decor Wreckers (Scorpio Gamesworld,1984)



Deep Probe (Compass Software,1992)



Deep Space (PSS,1984)



Deep Waters 1 (Zenobi Software,1991)



Decodificador de R.T.T.Y. (MicroHobby,1986)



Decsumat Loader (Svet Kompjutera,1987)

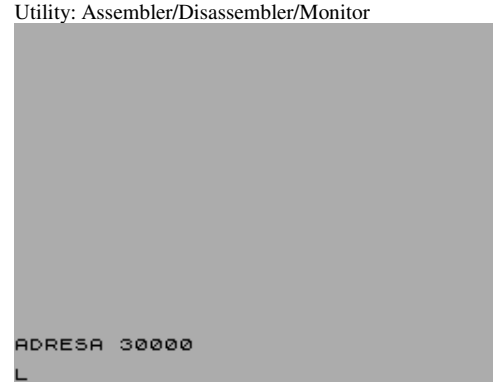

Deep Scan (Beyker Soft,2005)



Deep Strike (Durell Software Ltd,1986)



Deep Waters 2 (Zenobi Software,1991)

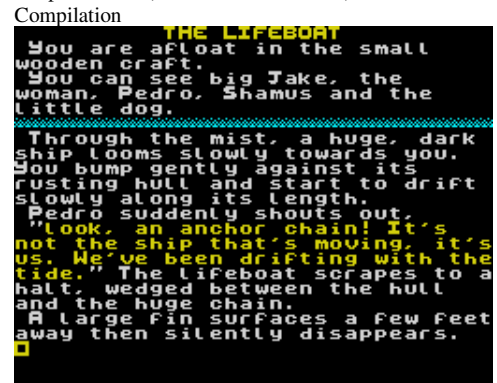

Def. Caracteres (Microparadise Software,1984)
Utility



Defence (Spectrum Computing,1985)
Arcade



Defenda (Interstella Software,1984)
Arcade



Defender (Anco Software Ltd,1983)
Arcade



Defender (MicroHobby,1985)
Arcade



Defcom (Quicksilva Ltd,1986)
Arcade



Defence, 3D (Empire Software,1987)
Arcade



Defenda, 3D (Contrast Software,1983)
Arcade



Defender (Blaby Computer Games,1982)
Arcade

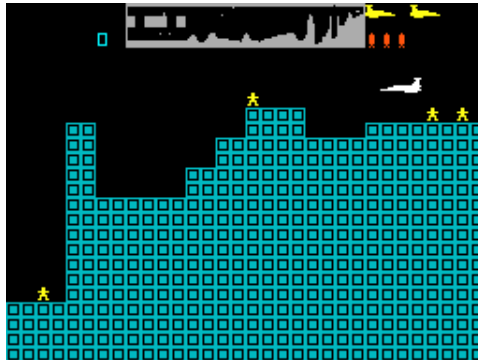

Defender (Popular Computing Weekly,1983)
Arcade



Defcom 1 (Iber Software,1989)
Arcade

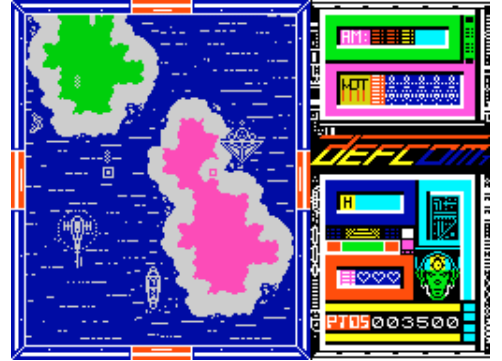

Defence Control (Thomas Busse,)
Arcade



Defendar (Mikro-Gen Ltd,1984)
Arcade



Defender (CPL Computing,1982)
Arcade



Defender (Precision Software Engineering,1983)
Arcade



Defender (Sinclair Programs,1983)



Defenders of the Earth (Enigma Variations Ltd,1990)

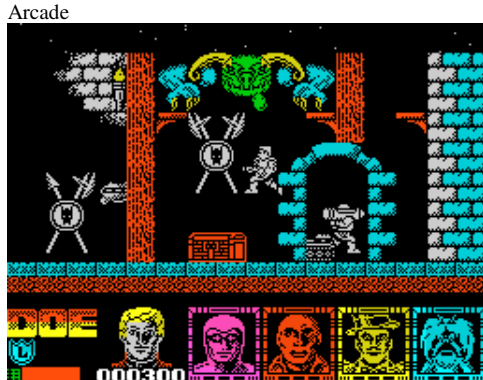

Deflektor (Gremlin Graphics Software Ltd,1987)



Defusion + Worms (K-Tel Productions,1984)

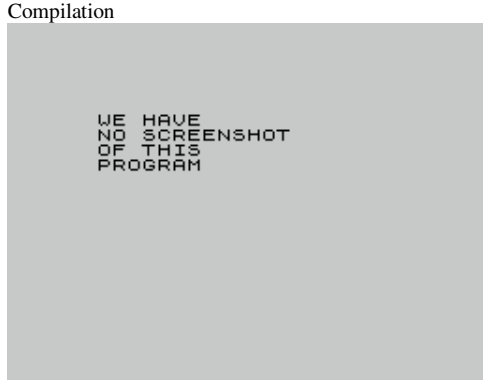

Deja Vu: The Remix (Crash,1990)

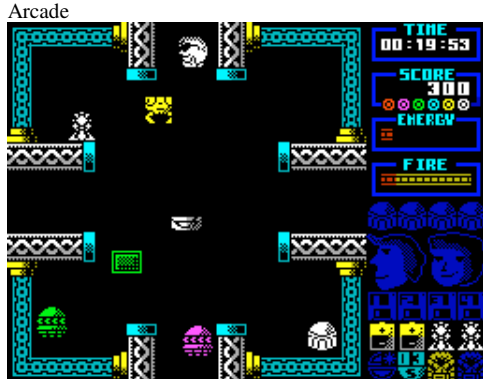

Defender Light Gun (Cheetah Marketing Ltd,1989)

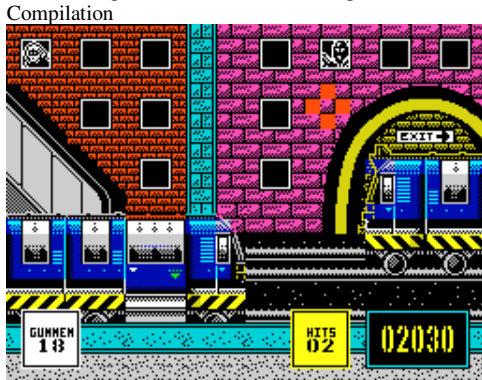

Defiende Tu Castillo (.)



De-Fusion (Lyndenhurst Ltd,1983)

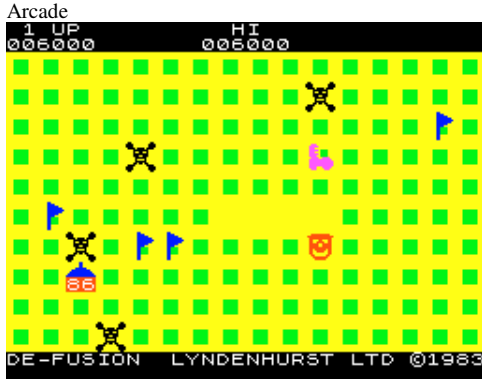

De-Jarre-Vu (Icabod,1995)



Dekorating Blues (Alpha-Omega Software,1986)

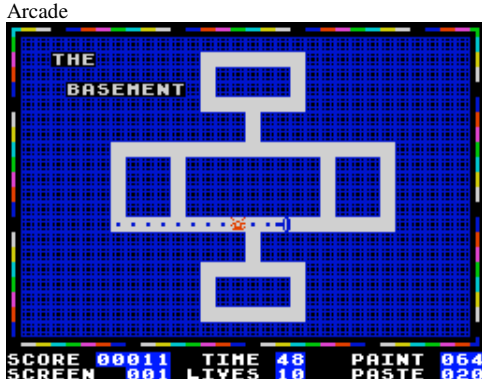

Defender of the Crown (The Cat,1989)

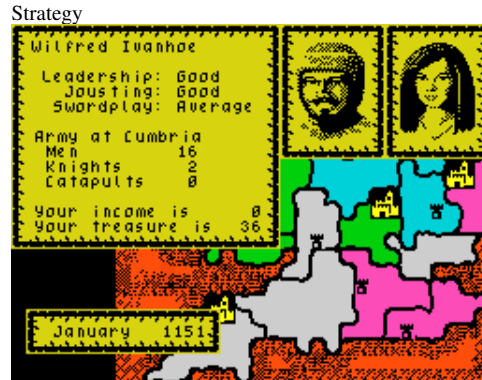

Deflator (Garry Rowland,.)



Defusion (Your Sinclair,1986)

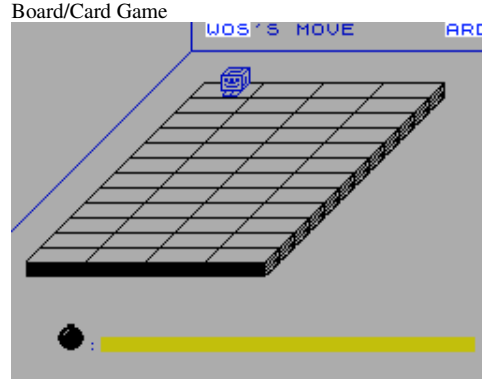

Deja Vu (Crash,1989)

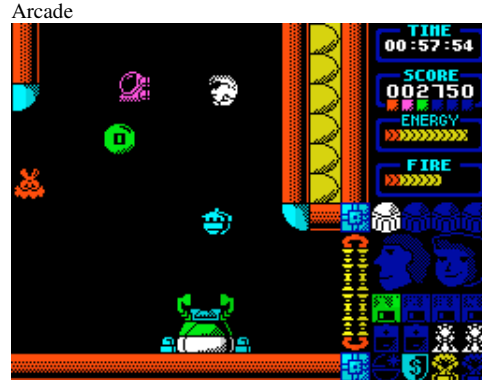

Delaila (Software of Sweden,1985)



Delbert's Hamster-Wheel of Fortune! (Delbert the Hamster Software,1992) Compilation



Deliverer 2: Escape to Eskelos (Brian Parks,1987) Text Adventure



Delta Wing (Creative Sparks,1984) Simulation



Demi-God (Softel Software,1989) Text Adventure



Demo 7 (Spectec,1993) Scene Demo



Delfox (Dinamic Software,1988) Arcade



Delta Charge (Thalamus Ltd,1990) Arcade



Deltic Fleet Manager (Dee-Kay Systems,1986) Simulation



Demi-God + Micro Drivin' (Softel Software,1989) Compilation

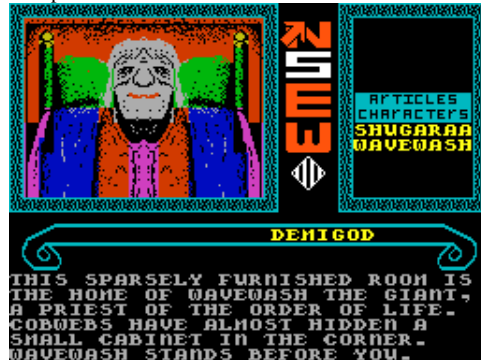

Demobit '96 Invitation Intro (7 Gods,1996) Scene Demo



Delirio Mind (Illusion Group,1996) Scene Demo

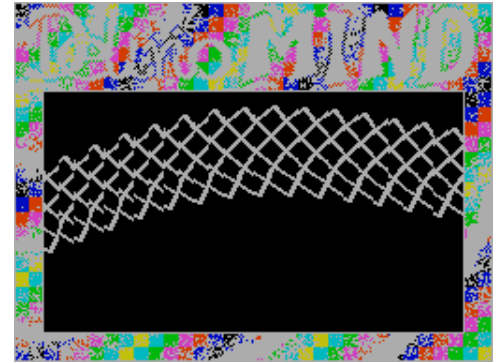

Deltana (,1988) Arcade



Demagogia (Omega,1992) Scene Demo



Demo 3: World of Speccy (Spectec,1992) Scene Demo



Demo by MR Jones (Mark R. Jones,1986) Demo



Demo Cartridge (Sinclair Research Ltd,1983)
Compilation



Demolition (C&VG,1984)

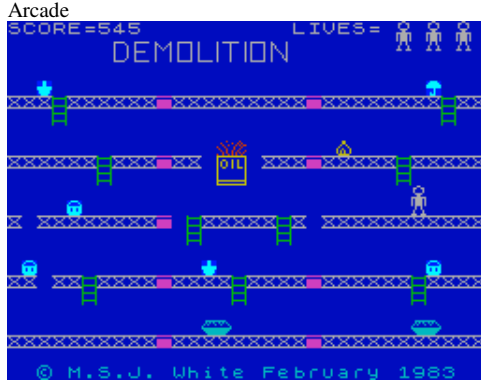

Demolition (Sinclair Programs,1983)

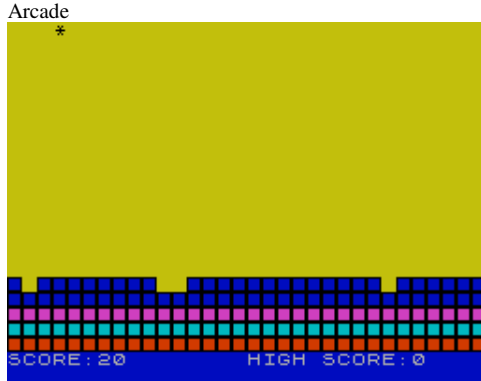

Demolition + Crazy Golf (Jonathan Cauldwell,1994)
Compilation

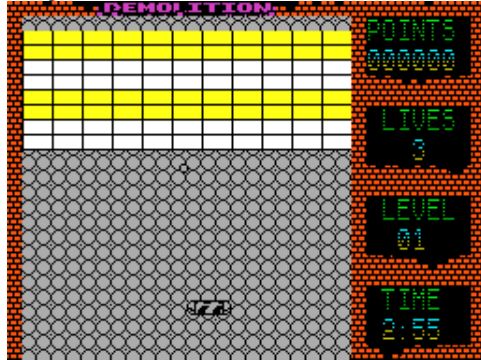

Demon (.)



Demo C's (Datasoft,1993)
Scene Demo

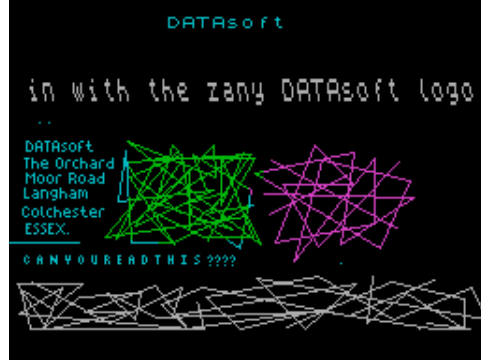

Demolition (Dorling Kindersley Software,1984)

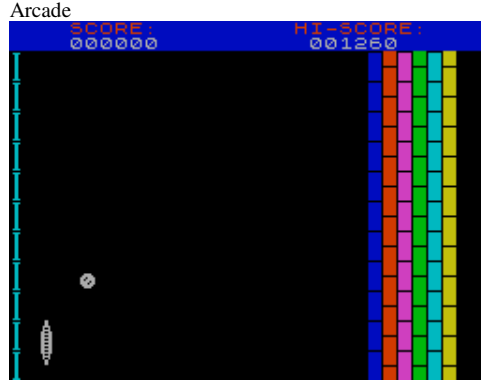

Demo-losion (Tiger's Claw,1993)

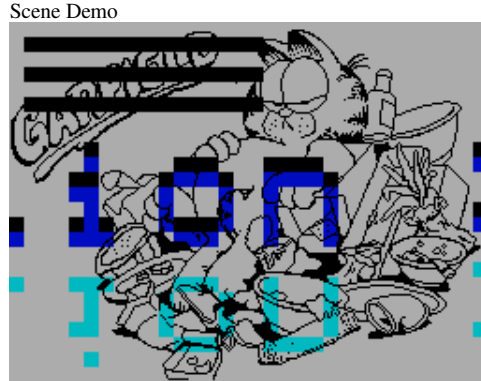

Demomaker (Poxoft,1992)
Scene Demo



Demon (EP Software,)

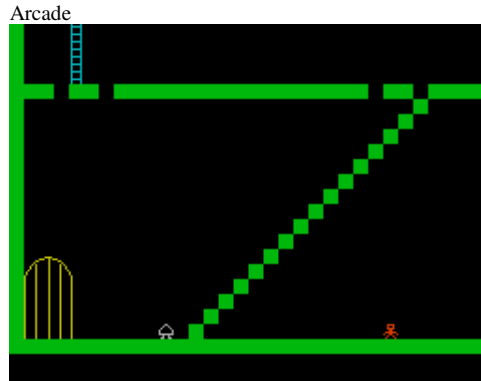

Demo for FPD Team (The United Minds,1995)
Scene Demo



Demolition (Jonathan Cauldwell,1993)

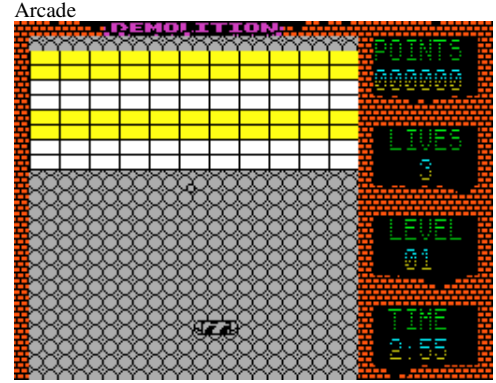

Demolition (ZX Computing,1983)

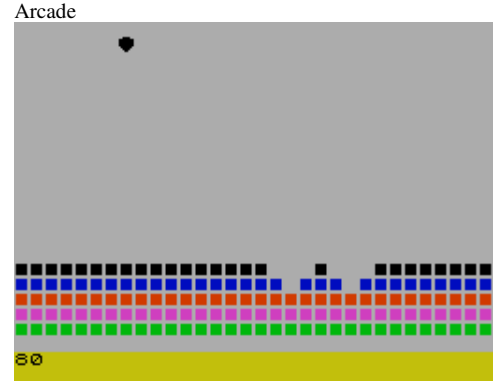

Demo Music, 3D (THD,1993)
Scene Demo



Demon Chase (Mansfield Computers & Electronics,1983)

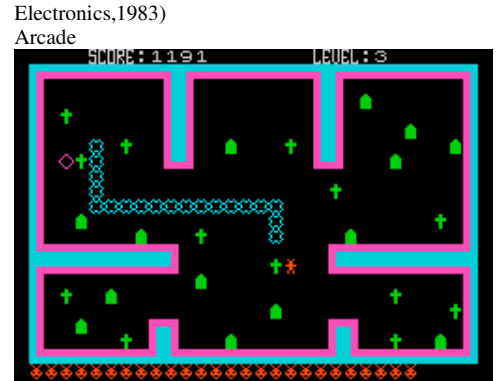

Demon-Driver (Swap,1983)
Arcade

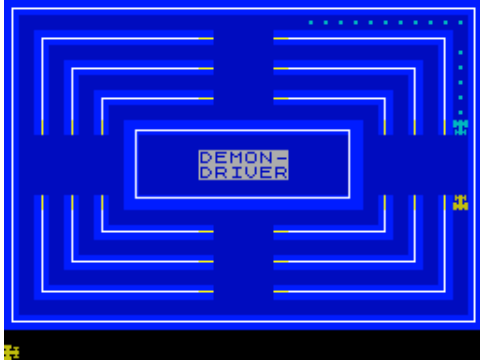

Demon from the Darkside II: The Golden Mask
(Compass Software,1987) Text Adventure



Demon Lord (Mansfield Computers & Electronics,1984)
Text Adventure



Demon Slayer (Sinclair User,1992)
Arcade



Demo Speech (.)

Utility: Sound Manipulation

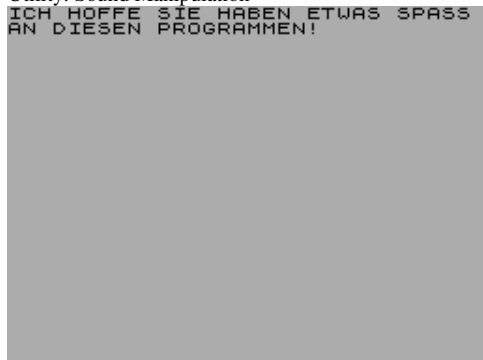

Demon from the Darkside (Compass Software,1986)
Text Adventure



Demoniak (Palace Software,.)

Arcade



Demons & Drivers (US Gold Ltd.)
Compilation



Demon's Revenge (Firebird Software Ltd,1988)
Arcade Adventure



Demo That Doesn't Begin With R (The United Minds,1997)

Scene Demo

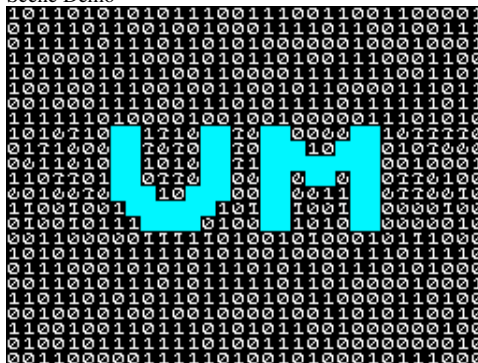

Demon from the Darkside + The Golden Mask
(Compass Software,1987) Compilation



Demon Knight (ASP Software Ltd,1983)

Text Adventure

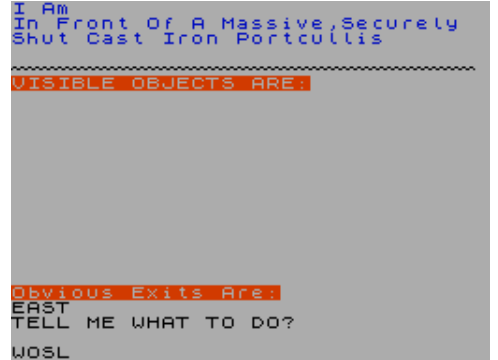

Demon Lord

Demonslair (Gadtek Games,1987)

Arcade Adventure



Demo op de Plee (The Lords,.)

Scene Demo



Dempsey and Makepeace (Britannia Software Ltd,1986)

Text Adventure



Denis (,1984)

Utility

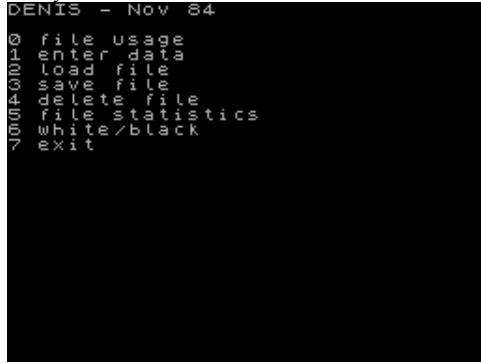

Depart (Jiri Vondracek,1987)

Arcade

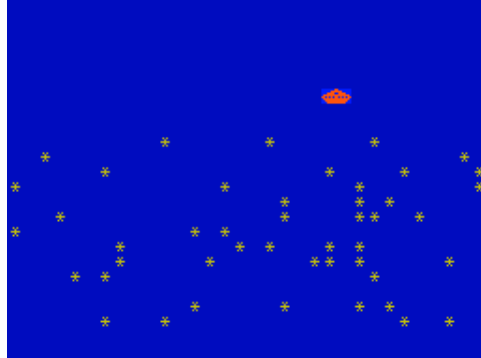

Depot Master Old Oak Common (Ashley Greenup,1989)

Simulation

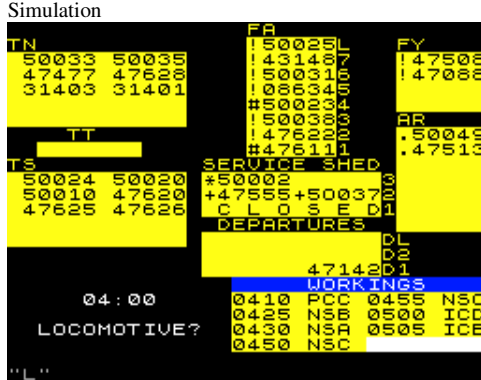

Derby Day (CRL Group PLC,1982)

Simulation



Dervish (The Power House,1987)

Arcade

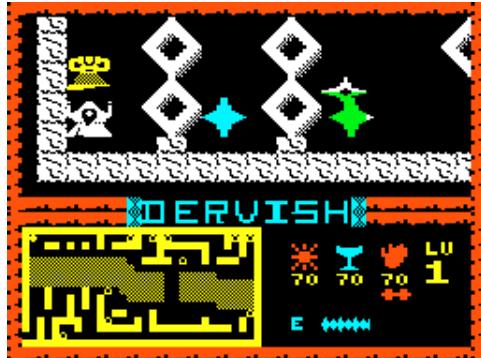

Denis through the Drinking Glass (Applications Software Specialities,1983) Text Adventure

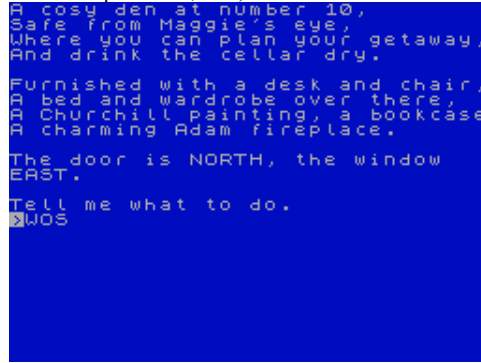

Depeche Mode: The Singles 81->85 (Danish Cracking Department,1988) Scene Demo

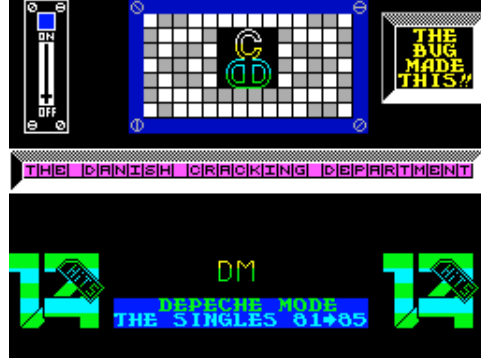

Depth Charge (Spectrum Computing,1984)

Arcade



Derivadas [1] (MicroHobby,1986)

Educational



Desarrollos 1X2 (Microgesa,1984)

Utility



Denizen (Players Software,1988)

Arcade

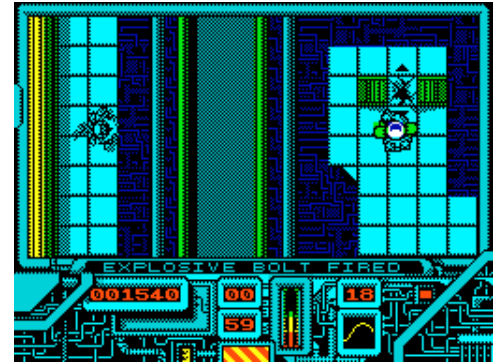

Depot Master Finsbury Park (Ashley Greenup,1989)

Simulation



Depurador de Programas (MicroHobby,1985)

Utility: Programming

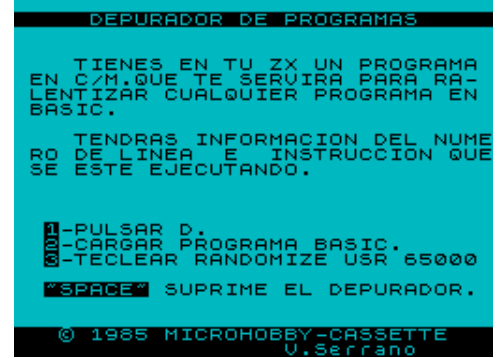

Derivadas [2] (MicroHobby,1985)

Utility



Desarrollos de Taylor (MicroHobby,1986)

Educational



Desassembler (SuperSoft [2],2001)
Utility: Assembler/Disassembler/Monitor



Descolocas (MicroHobby,1986)
Board/Card Game



Desensamblador [2] (MicroHobby,1985)
Utility: Assembler/Disassembler/Monitor



Desert Fox (US Gold Ltd.)
Arcade



Desert Patrol, 3D (CRL Group PLC,1983)
Arcade



Descender (MicroHobby,1985)
Arcade

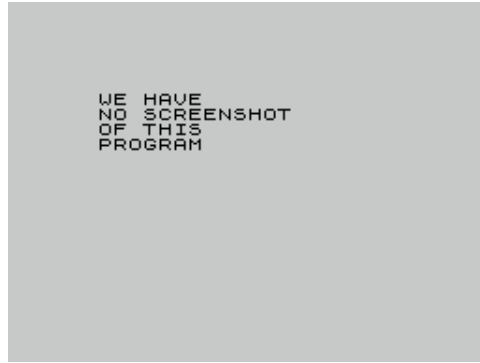

Descompresor de Pantallas (MicroHobby,1985)
Utility



Desensamblador [3] (MicroHobby,1986)
Utility: Assembler/Disassembler/Monitor



Desert Hawk (Players Software,1986)
Arcade



Desert Rats (CCS,1985)
Strategy



Descent (7 Gods,1995)
Arcade



Desensamblador [1] (MicroHobby,1985)
Utility: Assembler/Disassembler/Monitor

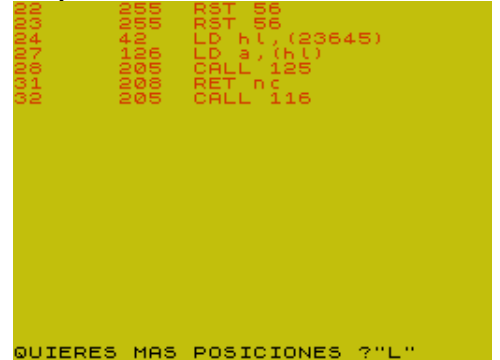

Desert Burner (Sparklers,1985)
Arcade



Desert Island (G.I. Games,1991)
Text Adventure

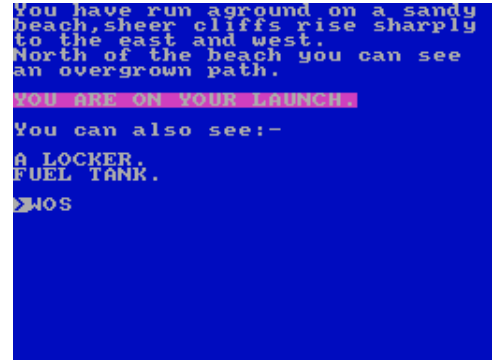

Desert War (Astra Software,1984)
Strategy



Designer (Gap Software,1986)

Utility

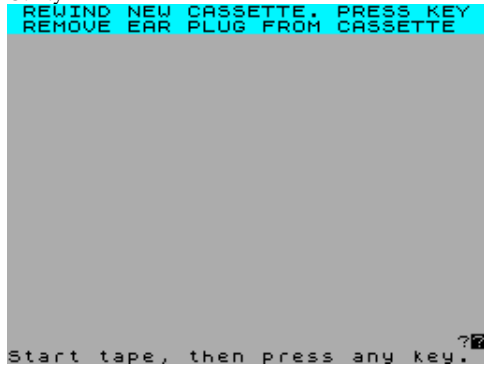

Desktop (Proxima Software,1991)

Utility

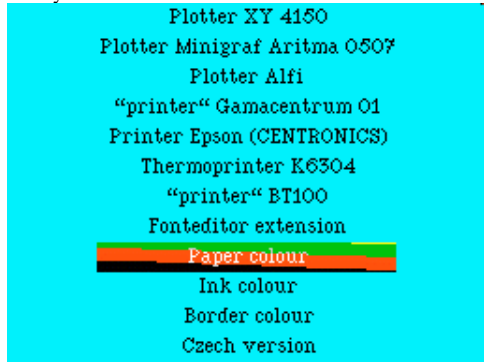

Desmond and Gertrude + Aunt Velma's Coming to Tea! (The Guild,1991) Compilation



Desperado (Central Solutions,1986)

Text Adventure



Destiny Mission (Williams Technology,1990)

Arcade

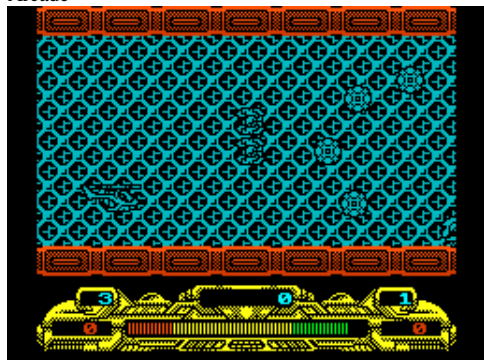

Designers Dream (Spectre Soft,1984)

Utility: Drawing

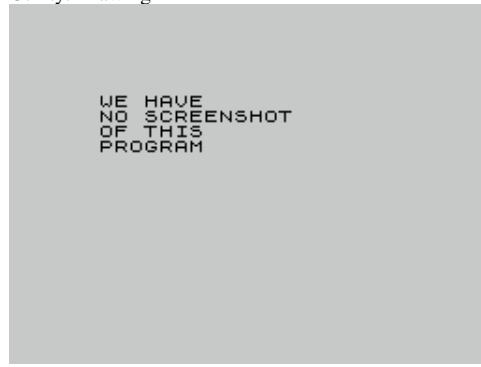

Desktop Convertor (Softhouse Ltd,1993)

Utility: Word Processor



Desolator (US Gold Ltd,1988)

Arcade



Desperado (Topo Soft,1987)

Arcade



Destroyer (Abacus Programs,1983)

Arcade

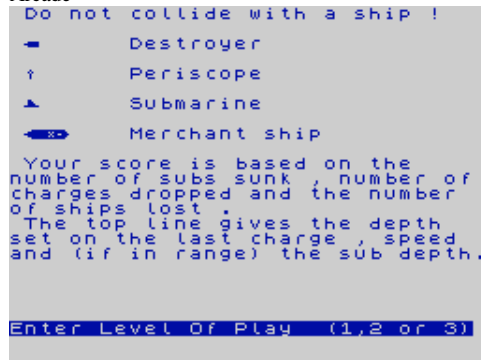

Designer's Pencil, The (Activision Inc,1984)

Utility: Drawing



Desmond and Gertrude (Delbert the Hamster Software,1991)

Text Adventure



Despejar (MicroHobby,1986)

Educational

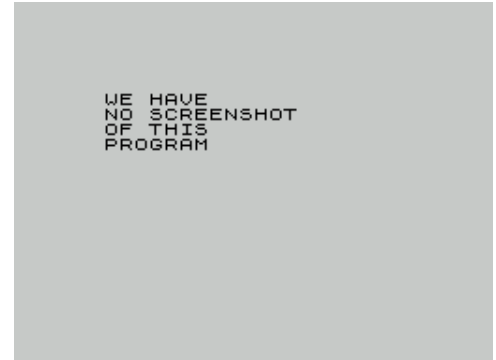

Desperado 2 (Topo Soft,1991)

Arcade

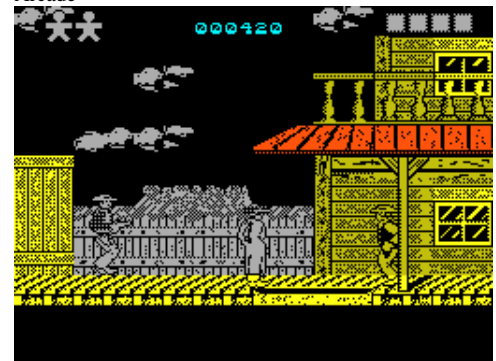

Destroyer (Impact Software [1],1983)

Arcade

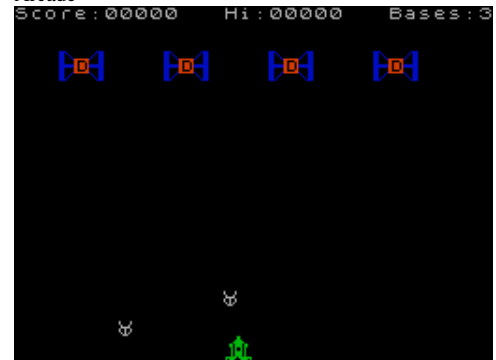

Destroyer (MicroHobby,1985)
Arcade

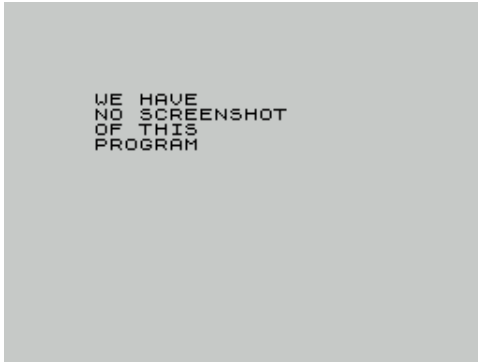

Destroyer (Wintersoft,1983)
Arcade



Destruction de America, La (Conrado Badenas,1989)
Text Adventure



Destruction of the Galactic Empire, The (David Ashton/Grant Wilson,1984) Text Adventure



Destructo (Bulldog,1987)
Arcade



Destructor (Aitor Gomez Garcia,2005)
Arcade



Destructors (Renegade Software,1994)
Strategy



Destrux (Your Sinclair,1990)
Arcade

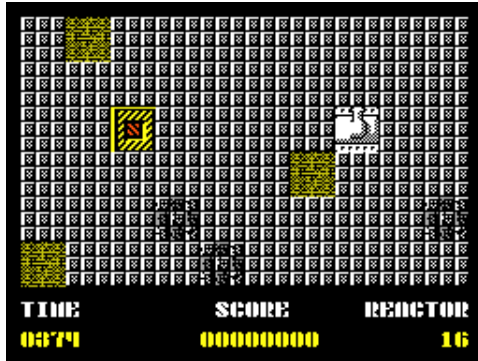

Detective (ASP Software Ltd,1983)
Board/Card Game

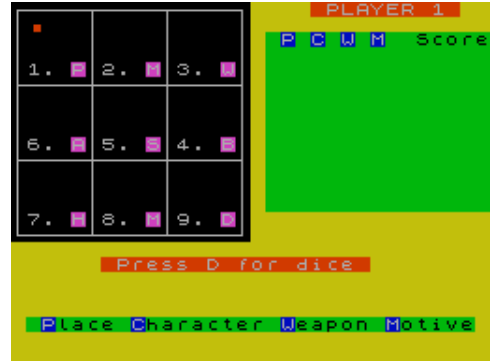

Detective (Your Computer,1983)
Board/Card Game

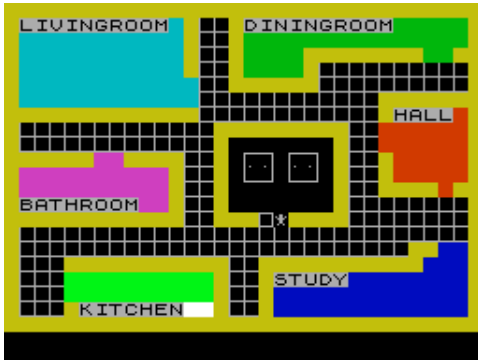

Detective, The (Arcade Software,1983)
Arcade



Detective, The (The Guild,1992)
Text Adventure

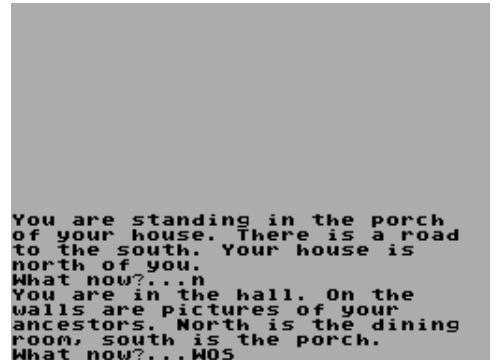

Detector (Petr Novak,)
Text Adventure

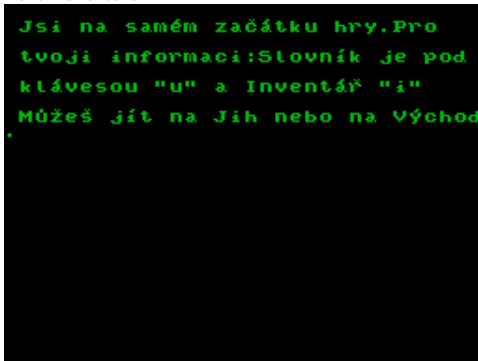

Determinante (Hans-Peter Frings Software,1983)
Utility: Mathematics

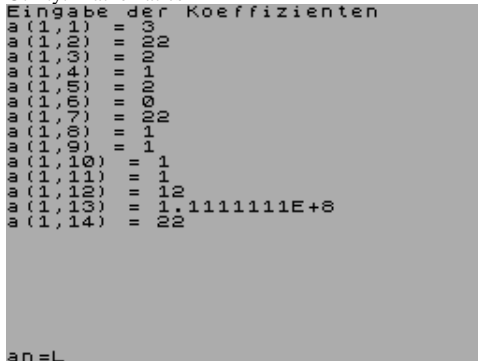

Detomator (Impact Software [3],1988)
Arcade

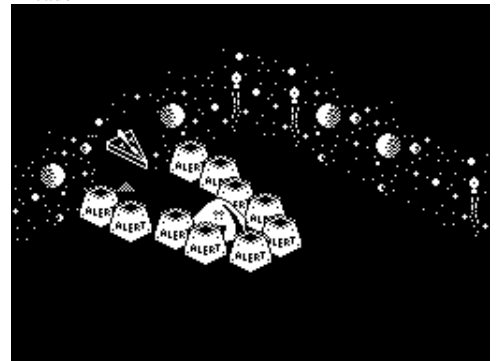

Deus Ex Machina (Automata UK Ltd,1984)
Simulation

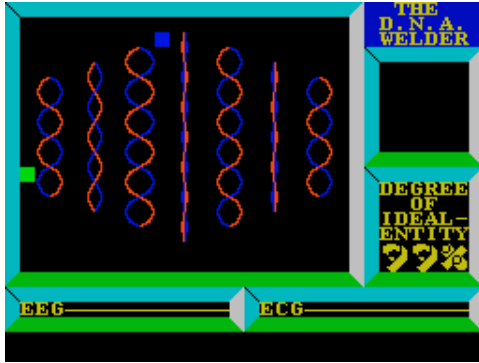

Devil Birds (Macronics Systems Ltd,1983)
Arcade



Devil's Crown, The (Mastertronic Ltd,1985)
Arcade



Devil's Hand + Shadows of the Past, The (Compass Software,1988) Compilation



Devils of the Deep (Richard Shepherd Software Ltd,1983)
Arcade Adventure



Devastating Blow (Beyond Belief,1991)
Arcade



Devil Diver (DK'Tronics Ltd,1984)
Arcade



Devil's Curse (Stellar Company Inc,1998)
Board/Card Game



Devil's Hand, The (Compass Software,1988)
Text Adventure



Devil's Revenge (Work Force,1983)
Arcade



Deviants (Players Software,1987)
Arcade



Devil Rides In, The (Carnell Software,1983)
Arcade

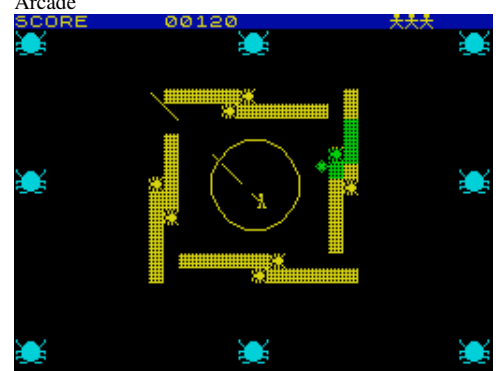

Devil's Descent (Pocket Money Software,1985)
Arcade



Devil's Island (Gilsoft International,1983)
Text Adventure

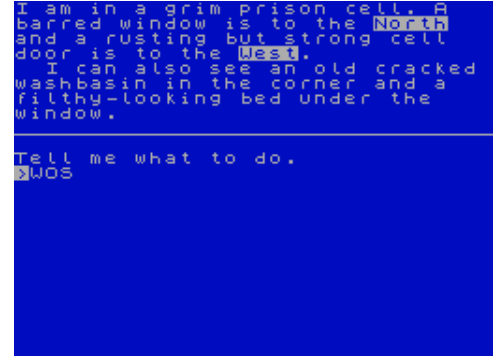

Devils Sceptre (,)
Text Adventure

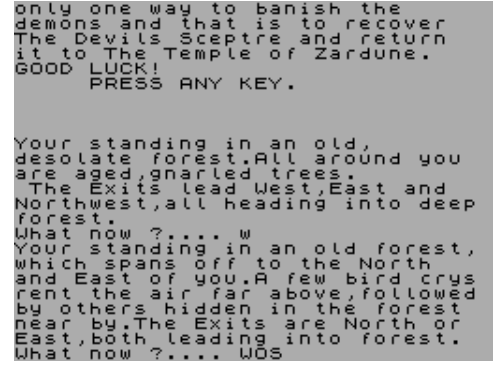

Dez2Binary (Stephan Slabihoud,1986)

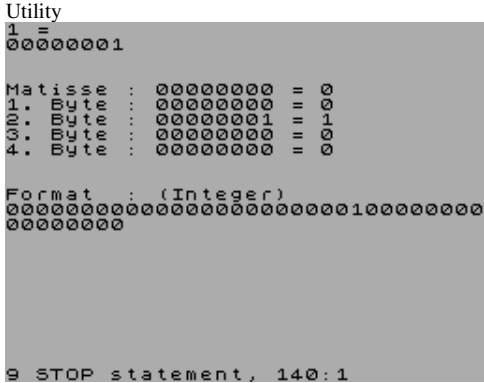

Diablo! (Nebula Design Software,1988)



Dia Despues, El (Bolsoftware Communications Ltd,1989)



Diamond (Destiny Software,1988)



Diamond Dungeon (XFAWORLD Software,2005)

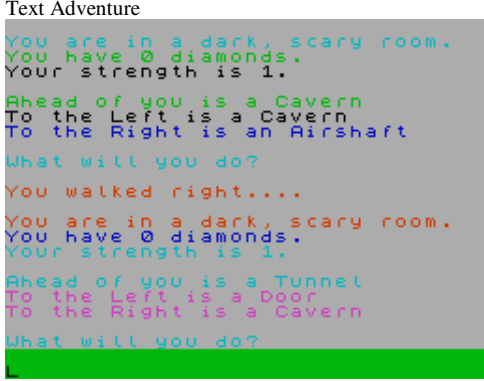

DFM Database (Dialog Software,1984)

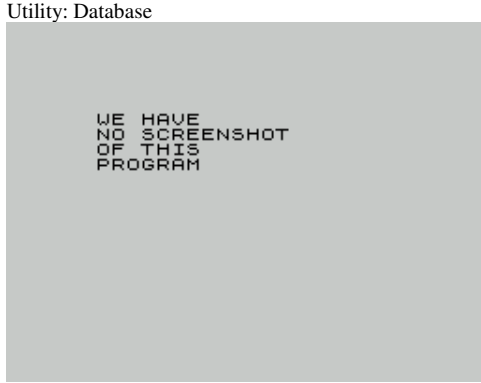

Diablo King (Cibercomp S.A.,1984)



Diagram (Frank Dux,1990)



Diamond (Dr. Laser,1998)

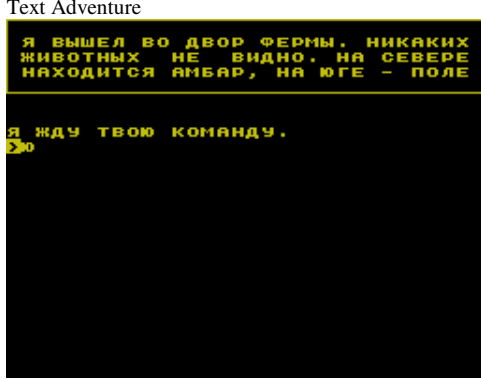

Diamond Mine (Add-On Electronics Ltd,1983)

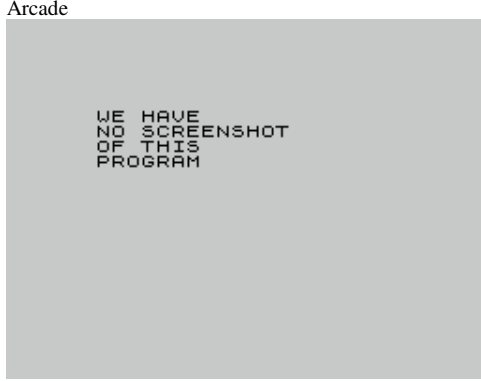

Diabetes (Dunitz Software,1984)

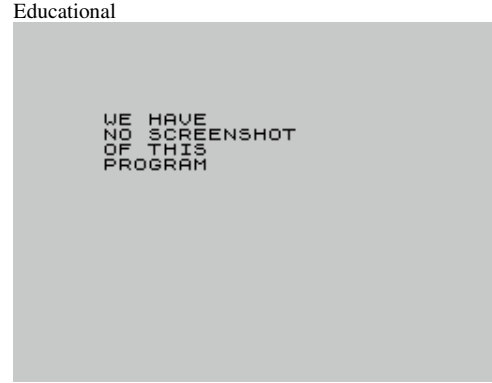

Diablos Great Escape (Graeme Coleman,1991)

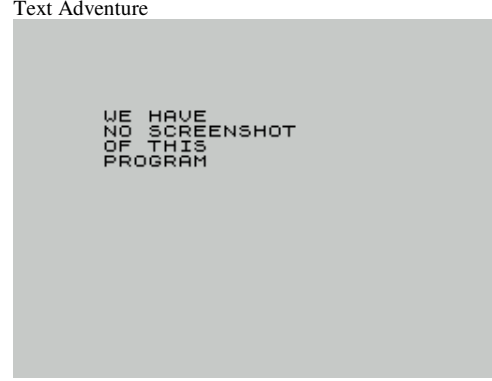
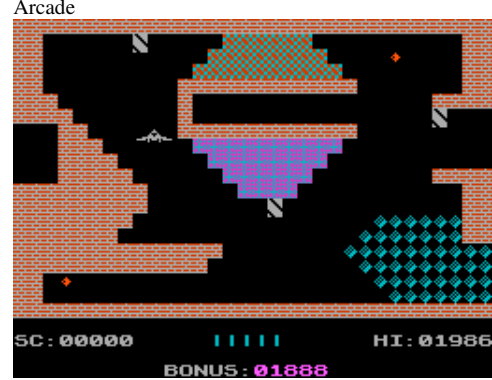

Diagram 1 (Frank Dux,1990)



Diamond Dungeon (Terramare Software,1986)



Diamond Mine (Shuric Program,1997)



Diamond Quest (CCS,1984)

Text Adventure



Diamond Trail (Gilsoft International,1983)

Text Adventure

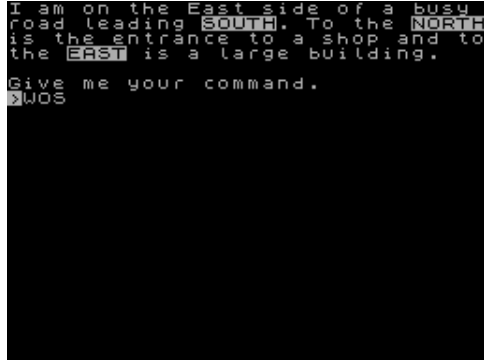

Diatmar (Santiago Marquez Solis,1989)

Text Adventure



Dibujo de Graficos (Hillrise Software,)

Utility: Mathematics

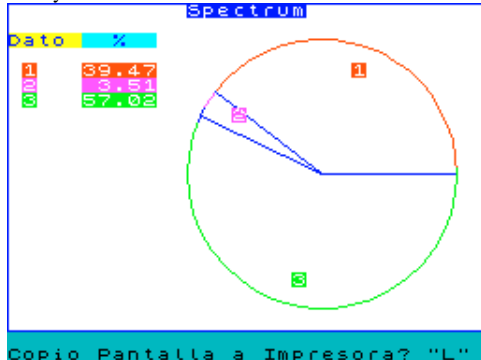

Dice (E.S.A. Productions,1994)

Board/Card Game

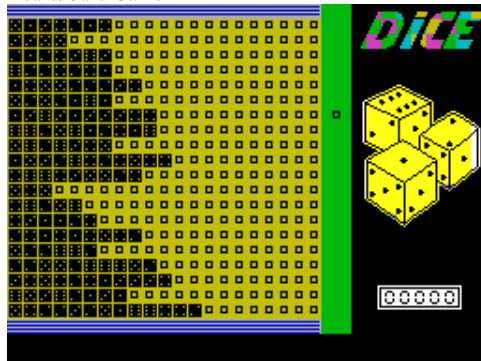

Diamonds (MicroHobby,1985)

Arcade



Diarmid (Zenobi Software,1993)

Text Adventure

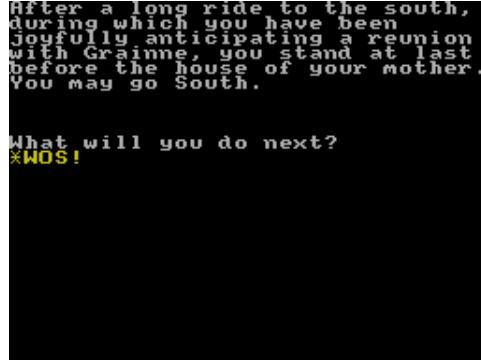

Dibujar en 3D (MicroHobby,1985)

Utility: Drawing



Dibujo Tecnico (MicroHobby,1985)

Utility

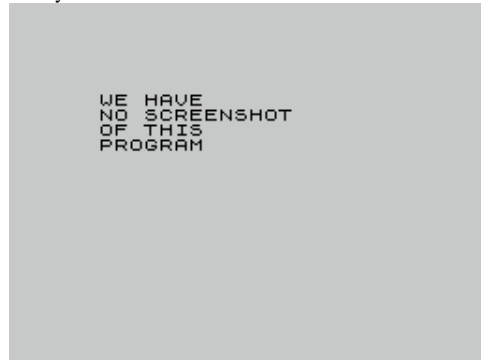

DICE (Kobrahsft,1988)

Utility



Diamonds Downfall (Power Group,1994)

Arcade



Dia Show (.)

Scene Demo

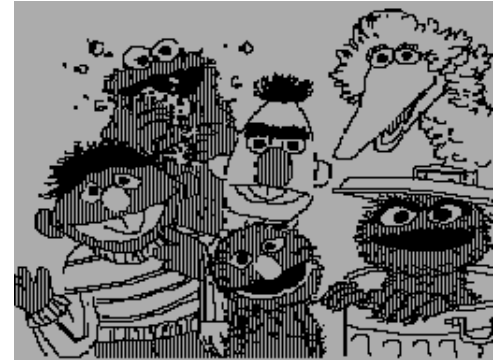

Dibujo (Ediciones y Textos S.A.,1985)

Utility: Drawing



Dice (EMM Software,1983)

Simulation

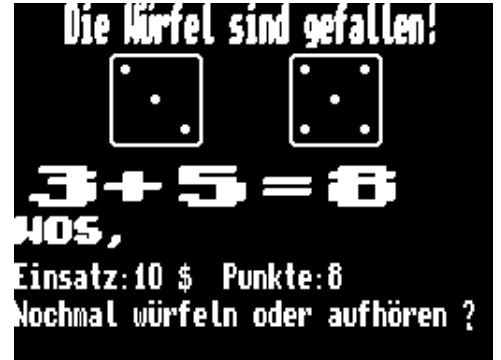

Dickie Diver (Quickbeam Software,1983)

Arcade



Dicks Galore! (Zenobi Software,)
Compilation



Dicky Duck (Beyker Soft,2005)
Arcade



Didaktik M (Ultrasoft,1991)
Utility: Drawing



Diet (DK'Tronics Ltd,1983)
Utility

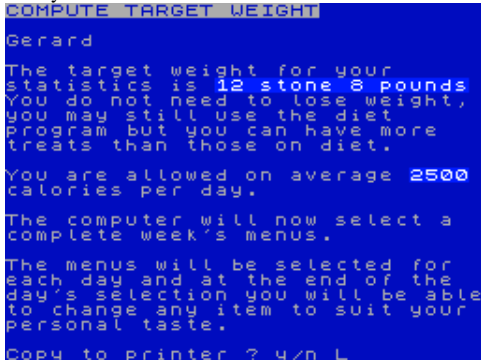

Dietron (CustomData Ltd,1983)
Utility

PERSONAL DAILY REQUIREMENTS		
Max. Weight	185	Pounds
Calories	2600	
Protein	56	grams
Vitamin A	5000	I.U.
Vitamin B1	1.2	milligrams
Vitamin B2	1.5	milligrams
Vitamin B6	2	milligrams
Vitamin B12	3	micrograms
Biotin	225	micrograms
Folic Acid	0.4	milligrams
Niacin	16	milligrams
Pantothenic Acid	7.5	milligrams
Vitamin C	45	milligrams
Vitamin E	10	milligrams
Sodium	4200	milligrams
Calcium	800	milligrams
Iron	10	milligrams

HIT ANY KEY

Dick Tracy (Titus,1990)
Arcade Adventure

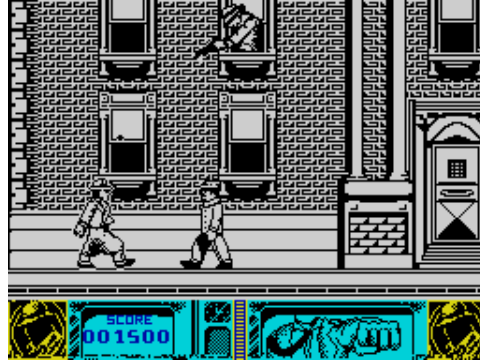

Dictator (DK'Tronics Ltd,1983)
Simulation

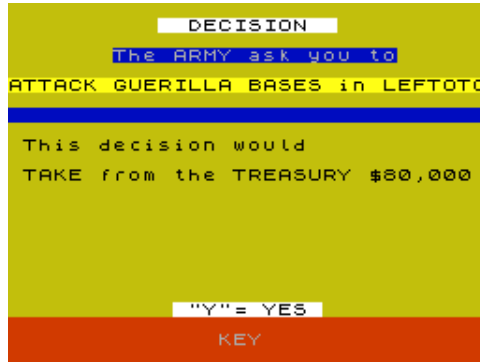

Die Alien Slime (Mastertronic Plus,1989)
Arcade

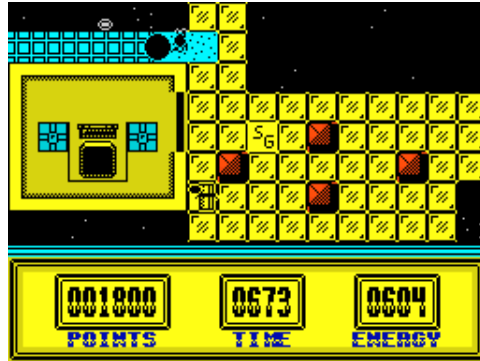

Dietician, The (Keysoft,1984)
Utility



Digestivo (,) Educational

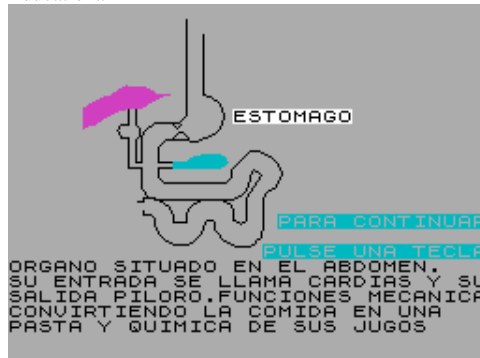

Dick Turpin (B.J. Curtis,1985)
Text Adventure



Dictator 2 (Last Masters Group,) Strategy



Dies Irae (Exodus,1996)
Scene Demo



Diet Master (Delta 7 Software,1983)
Utility



Digger Dan (Ocean Software Ltd,1983)
Arcade

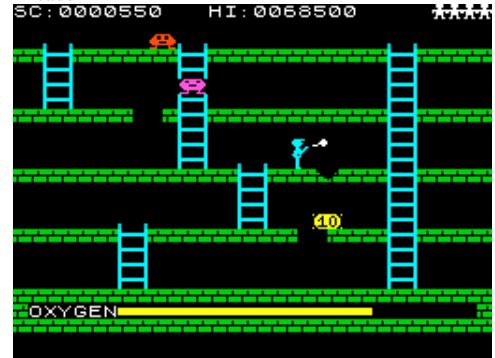

Digilog Basic-Kompilator (Digilog Software,)
Utility: Programming



Digital Arts Fantasy (Digital Arts Group,1996)
Scene Demo



Digital Graffiti (Mikro-Gen Ltd,1987)
Utility



Di-Lithium Lift (Hewson Consultants Ltd,1983)
Arcade

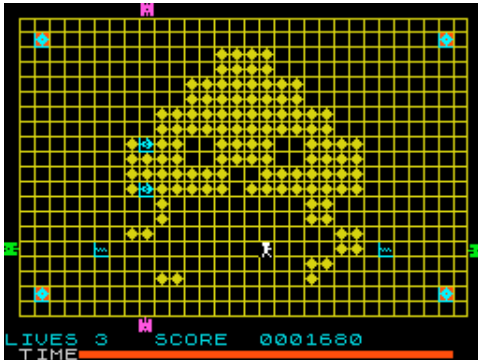

Dimension Omega (Positive,1989)
Arcade



Digi Porno Demo (Knudde,1985)
Scene Demo



Digital Box (TFF Team,)
Scene Demo



Digital X-Word Compiler (N. Darwood,1983)
Arcade



Di-Loader (Work Force,1983)
Utility: Programming



Dina Blaster (Prestige,1995)
Arcade

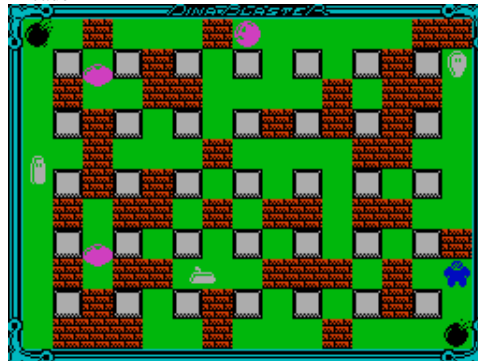

Digi Synth 3 (K3L Corp,1997)
Scene Demo

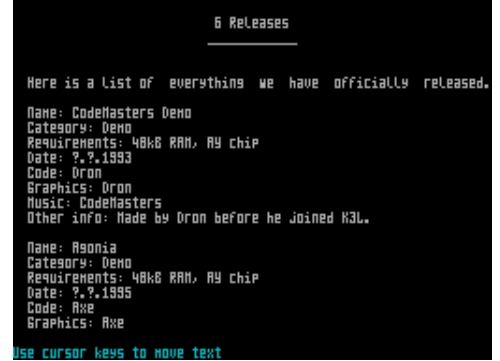

Digitale (ZX Data,1983)
Utility



Dildo and the Dark Lord (R.C.L. Software,1989)
Text Adventure



Dimension Destructors (Artic Computing Ltd,1983)
Arcade



Dinamic 5 Aniversario (Dinamic Software,1989)
Compilation



Dinamic 92 (Dinamic Software,1991)
Compilation



Dinosaurs (Piper Books Ltd,1984)
Educational

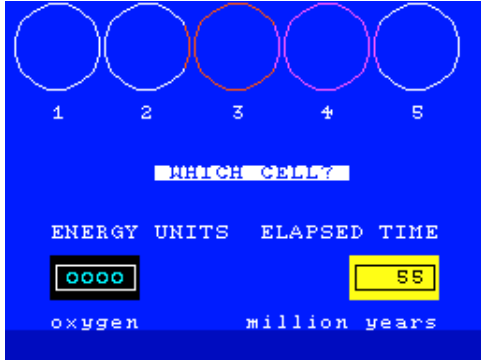

Directory (Leon Mlakar,1986)
Utility

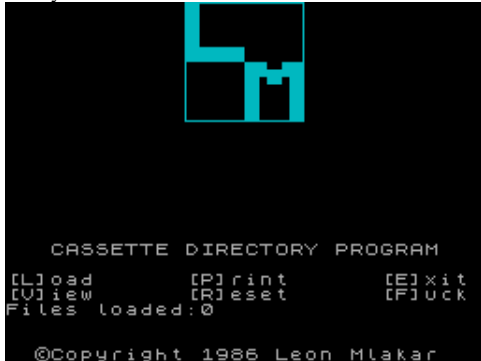

Disappear Balls (Binary Masters,1995)
Board/Card Game

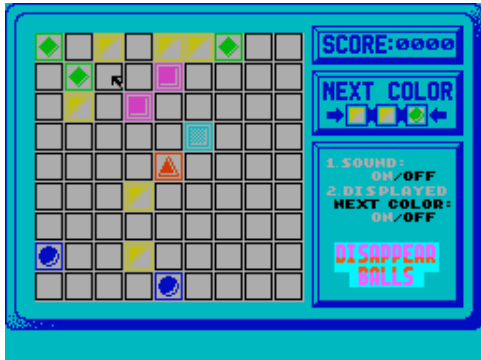

Disassembler (A.K. Fox,1985)
Utility: Assembler/Disassembler/Monitor

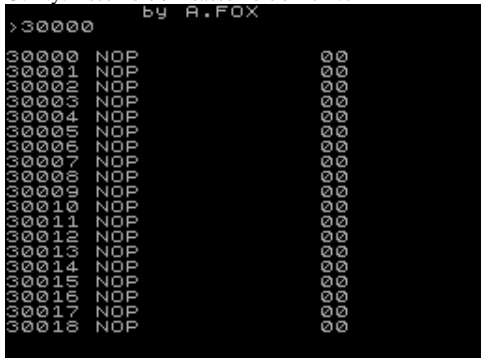

Dining (.)
Text Adventure



Dinosaurs (Sinclair User,1993)
Educational



Dirt Track Racer (Zeppelin Games Ltd,1991)
Arcade

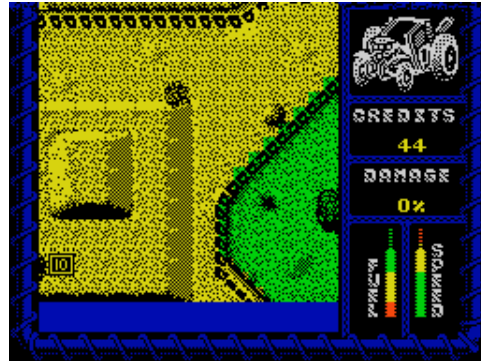

Disassembler (.)
Utility: Assembler/Disassembler/Monitor

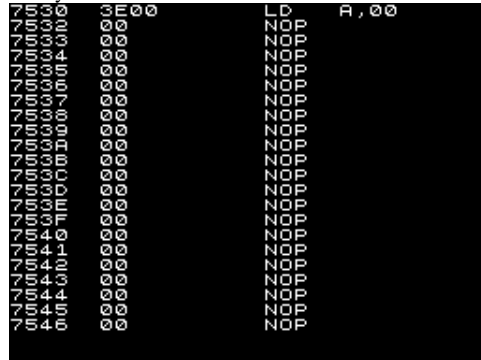

Disassembler (Gary Stimson,1989)
Utility: Assembler/Disassembler/Monitor

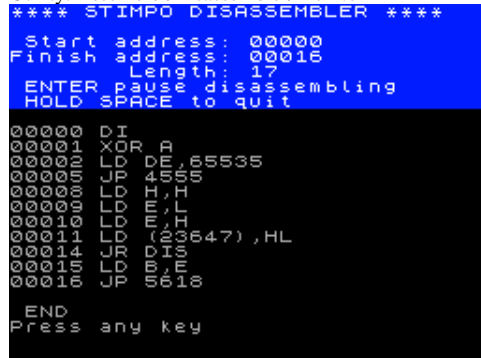

Dinky Digger (Postern,1983)
Arcade

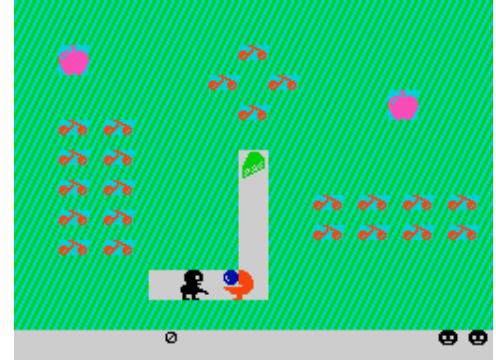

Diox (EP Software,.)
Arcade



Dirty Tricks Demo (Seurasoft,1992)
Demo



Disassembler (Add-On Electronics Ltd,1983)
Utility: Assembler/Disassembler/Monitor



Disassembler (Spectrum Computing,1984)
Utility: Assembler/Disassembler/Monitor



Disassembler (Work Force,1983)
Utility: Programming



Disassembler and Workbase (RDS Software,1993)
Utility: Programming



Disassembler & Editor (Campbell Systems,1982)
Utility: Assembler/Disassembler/Monitor

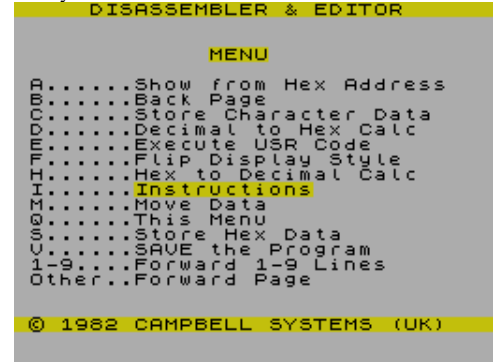

Dis BASIC (.)
Utility: BASIC Related

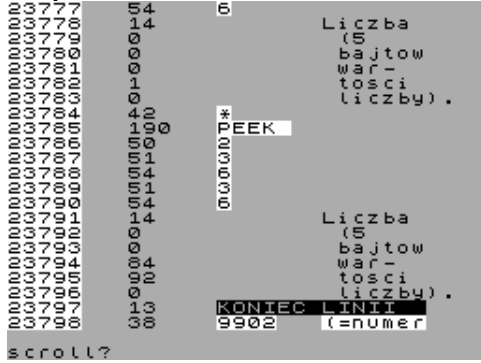

Disc-Doctor (Jochen Merz,1985)
Utility

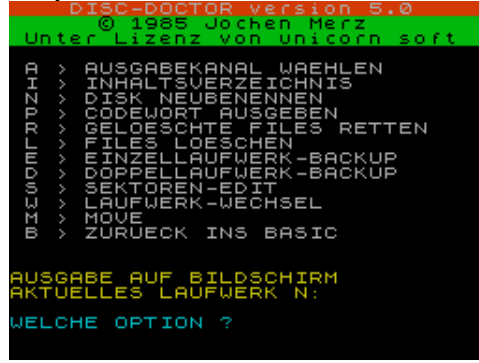

Disciple Disc Manager (Betterbytes Software,1989)
Utility



Disciple DOS (.)
Utility



Disc Manager (Betterbytes Software,1989)
Utility



Disc Manager (Bradway Software,1987)
Utility



Disc-Mate (Betterbytes Software,.)
Utility



Disco Dan (Gem Software,1984)
Arcade



Discology +3 (New Frontier,1988)
Utility

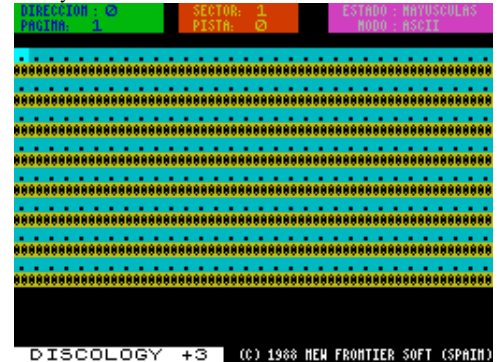

Disco Mania (Smash Soft,.)
Scene Demo



Disco - mk1 (Hektic Software,1985)
Utility

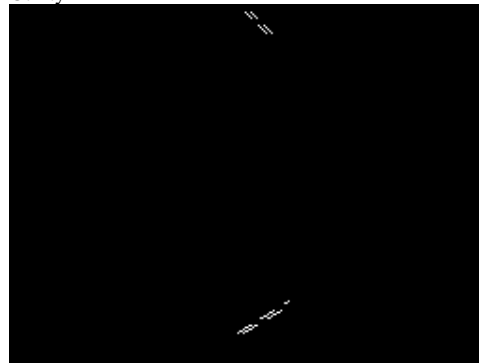

Discopack +3 (New Frontier,1989)
Utility



Disc Organiser (Betterbytes Software,1989)
Utility



Disco Screen (Ash Byproducts,1985)
Utility

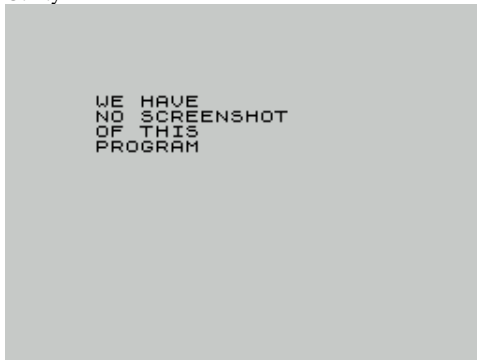

Discoteca (Software Editores,1986)
Utility: Database



Discs of Death (Artic Computing Ltd,1985)
Arcade



Disease Dodgers (Macmillan Software Ltd/Sinclair Research Ltd,1985) Educational



Disfruta con la Geografia (.)
Arcade



Dishmaster (CKS/GST Software,1985)
Arcade

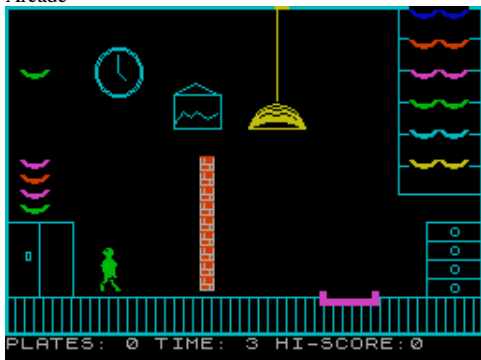

Disk Basic (Duisburger Cracking Service,1985)
Utility: BASIC Related



Diskmate +3 (Miles Gordon Technology,1989)
Utility



Dispel (Radio Student,1984)
Utility: Database



Display (Soft Sell,1983)
Utility: Font/UDGs



Disposable Heroes (The Power House,1987)
Arcade

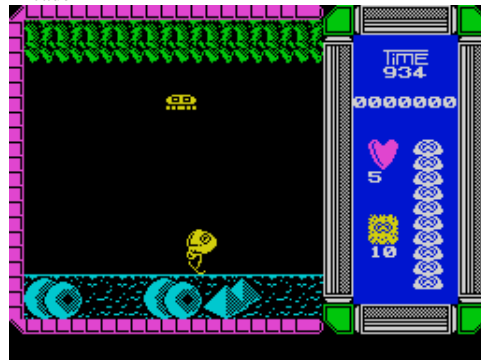

Distron (DK'Tronics Ltd,1983)
Utility: Assembler/Disassembler/Monitor



Divertimentos issue 1 (Creativos Editoriales S.A.,1985)
Covertape



Divertimentos issue 2 (Creativos Editoriales S.A.,1985)
Covertape



Divertimentos issue 3 (Creativos Editoriales S.A.,1985)
Covertape



Di-vision (Softhouse Ltd,1994)
Utility: Screen Manipulation



DIY Puzzles (16/48 Tape Magazine,1985)
Board/Card Game



Dizzy 3 and a Half (Crash,1991)
Arcade

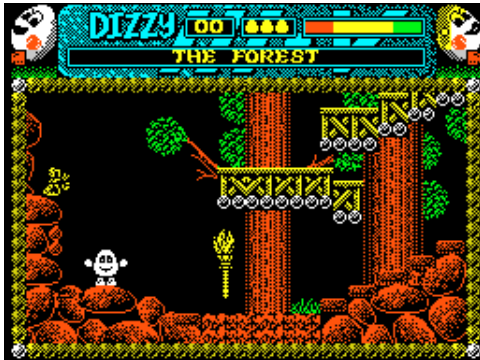

Dizzy 'A' (N-Discovery,2000)
Arcade Adventure



Divertimentos issue 4 (Creativos Editoriales S.A.,1985)
Covertape



Dix Mille (CCS,1984)
Board/Card Game



Dizzy (Code Masters Ltd,1987)
Arcade



Dizzy 4K Intro (Serzhsoft,1998)
Scene Demo

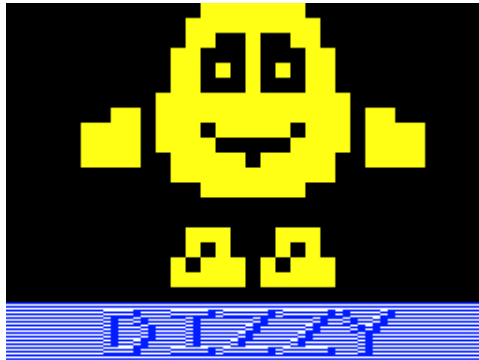

Dizzy 'B': Treasure Island (Yuri Nazarenko,2001)
Arcade Adventure



Divertimentos issue Extra (Creativos Editoriales S.A.,1985)
Covertape



Dixons Premier Collection (Dixons,1988)
Compilation



Dizzy: Return to the Magicland (Soly,1992)
Arcade Adventure



Dizzy 8: Little Joke (Timur Company,1996)
Arcade Adventure

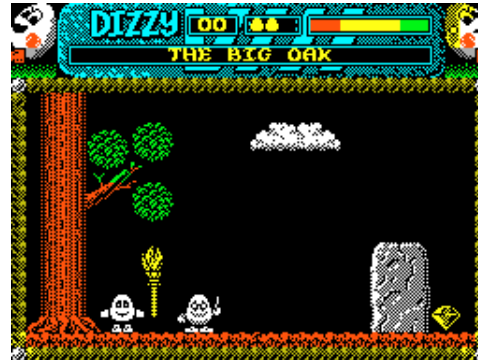

Dizzy Collection (Code Masters Ltd,1991)
Compilation



Dizzy Dice (Players Software,1986)
Board/Card Game

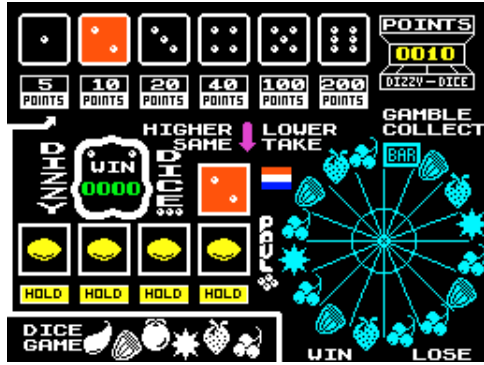

Dizzy Lord (Konczolsoft,1989)
Arcade Adventure



Dizzy Warehouse (Yury Schapov,1996)
Arcade

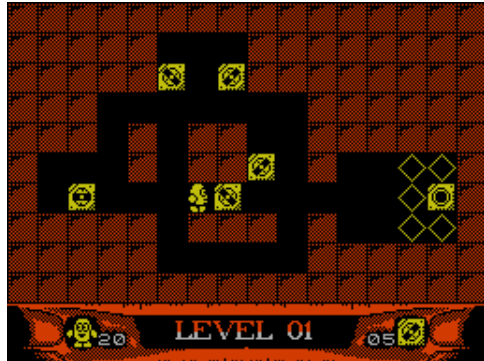

Dizzy XX: Hell in Paradise (Megacode Hackers Group,1996)
Arcade Adventure



DK'Tronics Light Pen MK2/3 (DK'Tronics Ltd,1983)
Utility

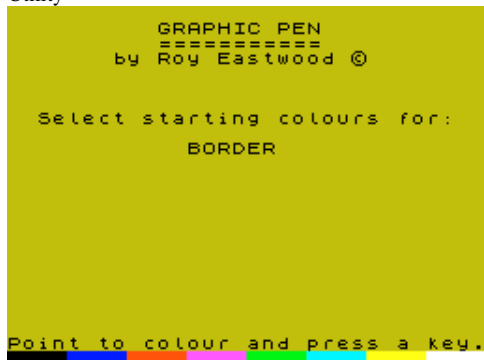

Dizzy Down the Rapids (Code Masters Ltd,1991)
Arcade



Dizzy Music (Rus,1991)
Scene Demo

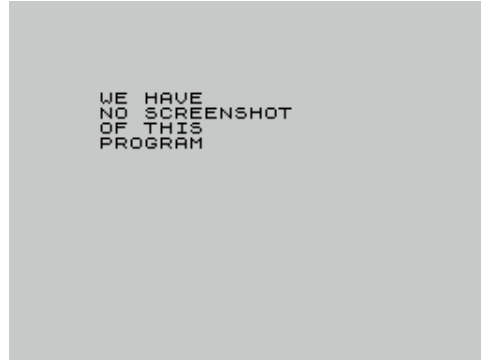

Dizzy X (Speed Code,1995)
Arcade Adventure

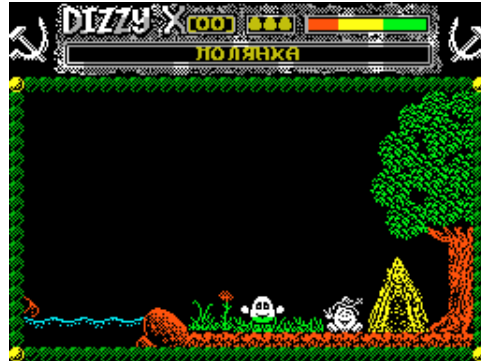

DJ Puff's Volcanic Caper (Code Masters Ltd,1992)
Arcade



DK'Tronics Toolkit (DK'Tronics Ltd,1983)
Utility

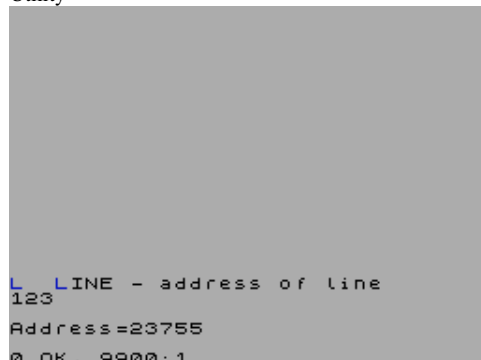

Dizzy Help (Belousov Alexander,1992)
Educational

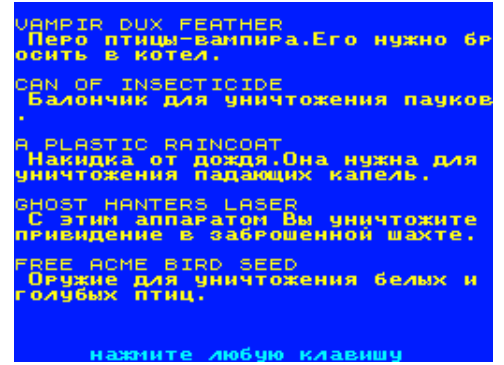

Dizzy's Excellent Adventures (Code Masters Ltd,1991)
Compilation



Dizzy XII: Underground (Gogin,2001)
Arcade Adventure



DK'Tronics Light Pen (DK'Tronics Ltd,1983)
Utility

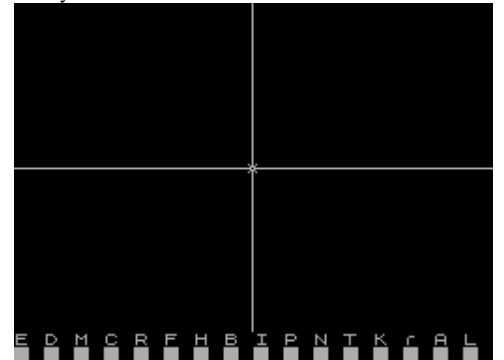

Dlan (Campbell Systems,1983)
Utility: Screen Manipulation

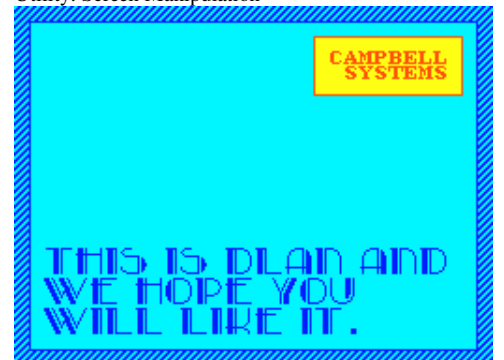

D-Logic (SciCAL Software Ltd,1983)
Educational

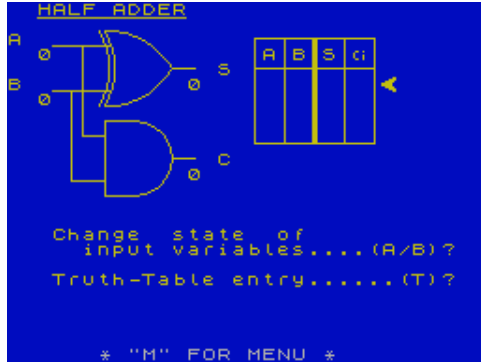

DMS +3 Disc Management System (KobraSoft,)
Utility



Dobyvani Hradu (Antic,1986)
Text Adventure

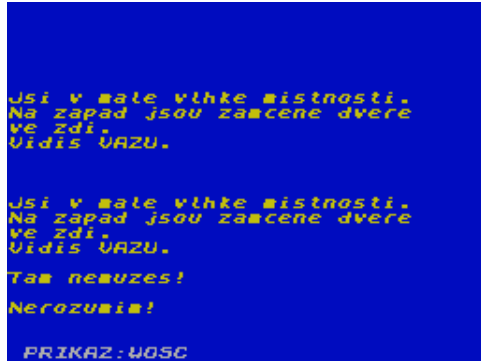

Docking (Your Computer,1984)
Simulation

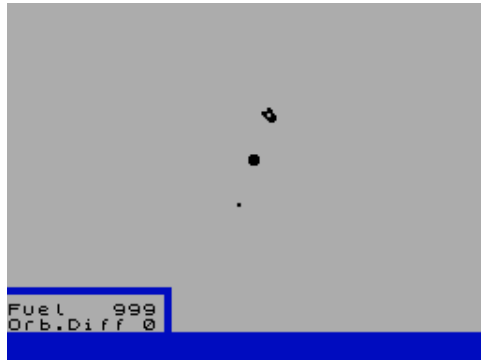

Doctor (Luis Eduardo Juan,1985)
Simulation

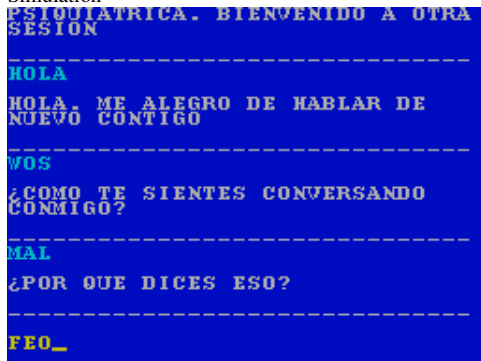

DMC Demo 7 (The Mad Guys,1990)
Scene Demo

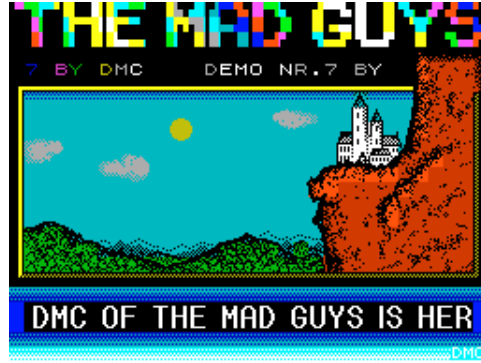

D.N.A. Warrior (Cascade Games Ltd,1989)
Arcade



Doce Trabajos de Heracles (David Fraile,)
Text Adventure



Docking the Spaceship (Sinclair Research Ltd,1982)
Arcade

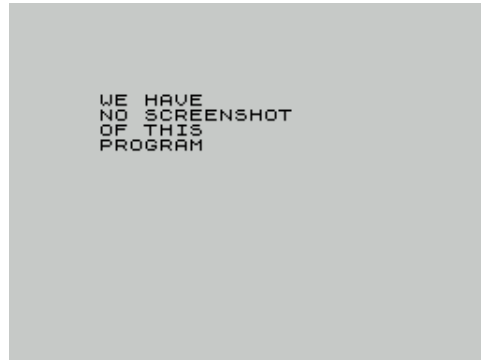

Doctor Aibolit (Transman,2002)
Arcade

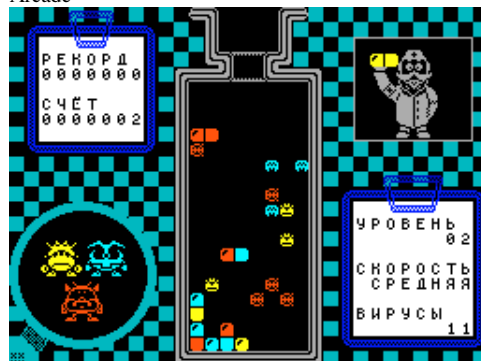

DMC Demo 8 (The Mad Guys,1991)
Scene Demo



Dobranocki (Kicia,1989)
Scene Demo



Docker Dan (Wizard Software,)
Arcade



Doc the Destroyer (Melbourne House,1987)
Arcade



Doctor Goo and the Samorons (Global Games [1],1991)

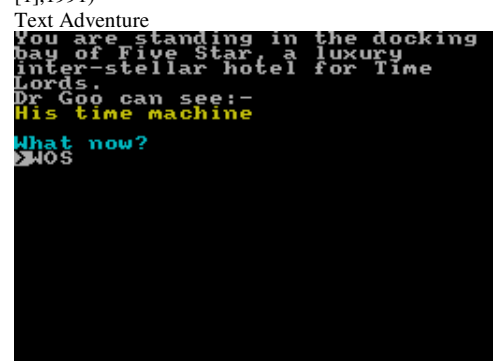

Doctor Mario (Romantic Warriors,1996)
Arcade

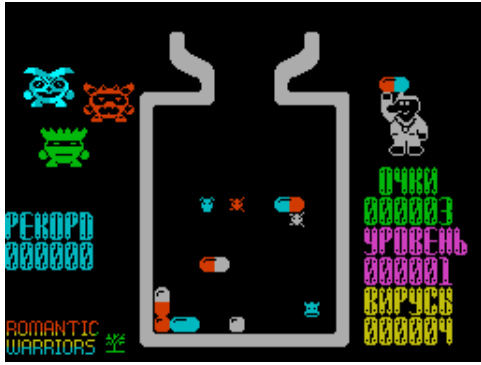

Doctor Who and the Warlords (BBC Software,1984)
Text Adventure



Dodge City 2 (Phoenix Software,1984)
Text Adventure



Dodgy Geezers (Melbourne House,1986)
Text Adventure



Dogboy, The (St. Bride's School,1985)
Text Adventure



Doctor What! (CRL Group PLC,1986)
Arcade Adventure



Doctum (Carlos Gandarillas/Antonio Ballesteros,1991)
Arcade

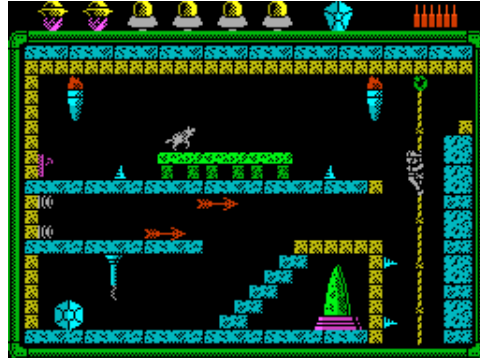

Dodgems (P. Tolland,)
Arcade

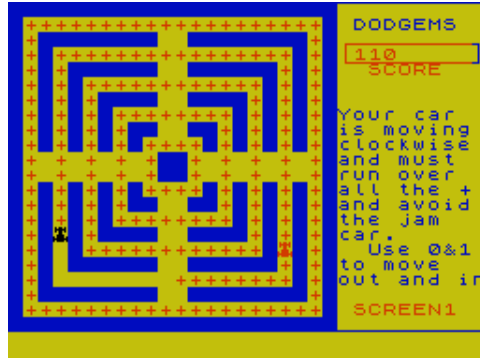

Do-Do (Blaby Computer Games,1983)
Arcade

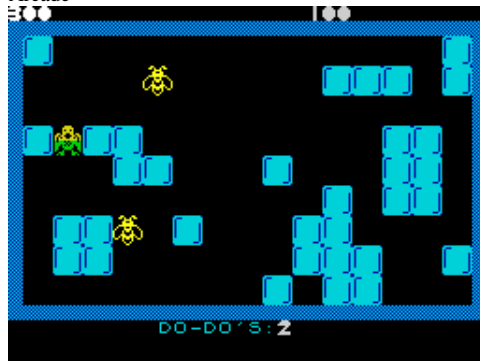

Dogfight (Fontana Publishing,1984)
Arcade



Doctor Who and the Mines of Terror (Micro Power Ltd,)
Arcade



Dodge City (Phoenix Software,1983)
Text Adventure



Dodger Don (Adsoft Software Ltd,1985)
Arcade



Dodo and Damn (R.C.L. Software,1989)
Text Adventure



Dogfight (Slogger Software,1984)
Arcade



Dogfight 2187 (Starlight Software,1987)
Arcade

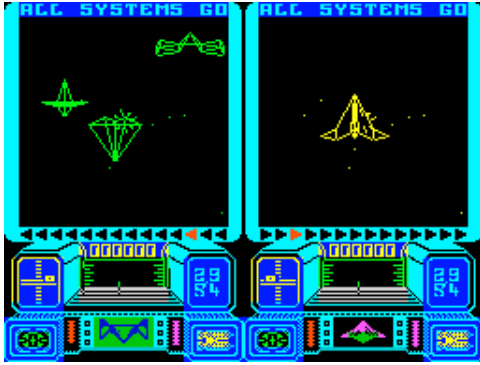

Dokonala Vrazda (Ultrasoft,1987)
Text Adventure

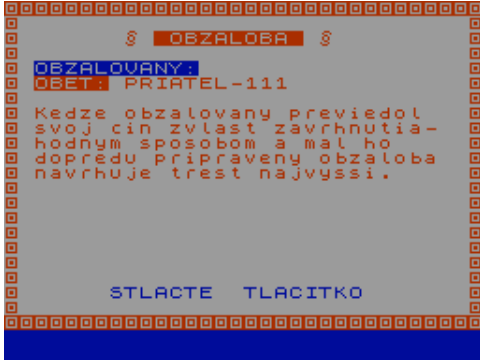

Do-Little (Adam/Hooy-Program,1998)
Scene Demo



Domain (Space Age Software,1983)
Arcade



Dome, The (Studio Stall,2002)
Arcade

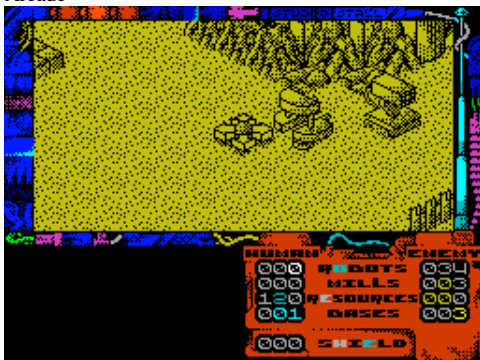

Dogsbody (Bug-Byte Software Ltd,1985)
Arcade

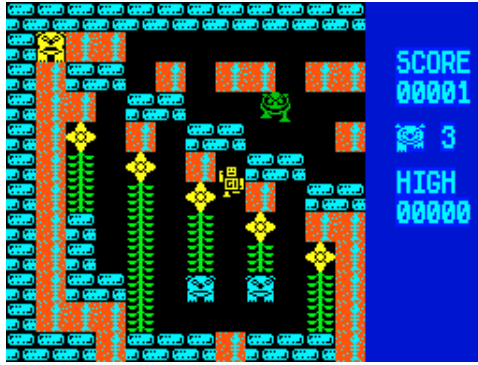

Dokonala Vrazda II: Bukapao (Ultrasoft,1991)
Text Adventure

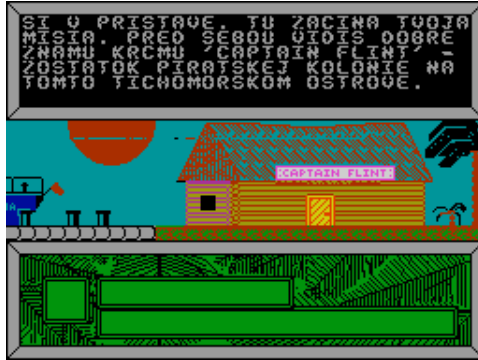

Dollars in the Dust (Pelagon Software,1985)
Text Adventure

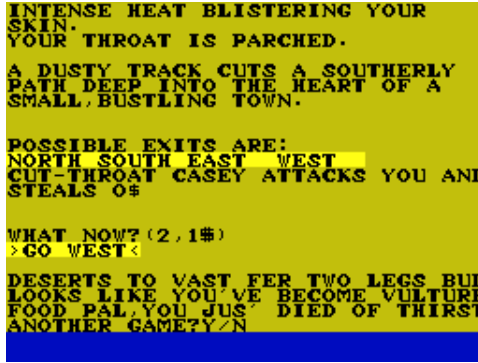

Domes of Sha, The (River Software,1988)
Text Adventure



Dome Trooper (Matand Software,1986)
Text Adventure

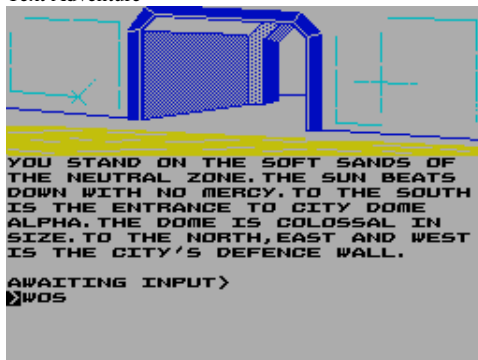

Dog Weazle - The Megaventure (Alphasoft,1986)
Text Adventure



Dole Queue (Sentient Software Ltd.)
Text Adventure



Domain (Abacus Programs,1982)
Arcade

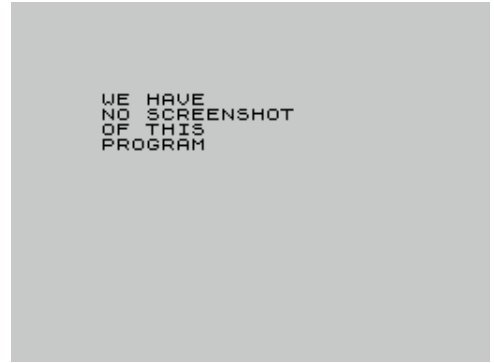

Domes of Sha, The + Letter Bomb (River Software,1988)
Compilation



Dome Warrior (US Gold Ltd.)
Arcade



Domination (Secundus,1992)
Arcade

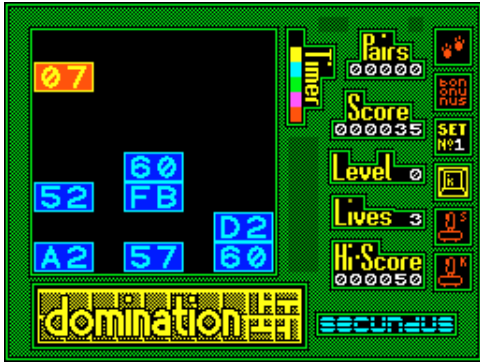

Dominetris (Cronosoft,2005)
Board/Card Game

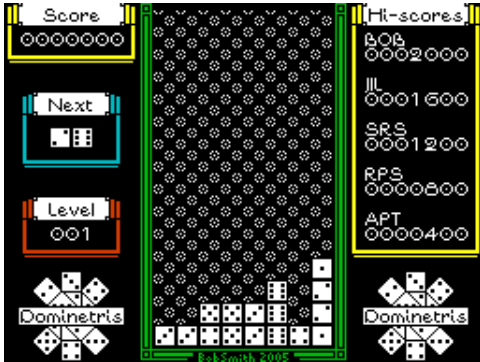

Domino (MicroHobby,1985)
Board/Card Game

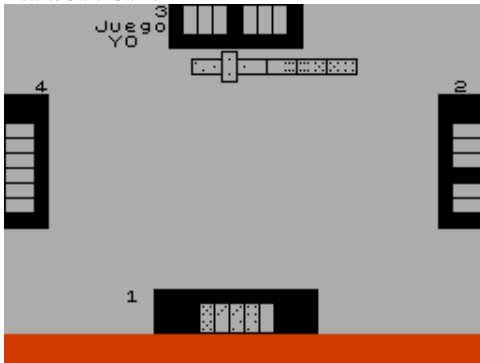

Dominoes (Micromega,1983)
Board/Card Game



Dominos (Jose Maria Gonzalez Ondina,2003)
Arcade

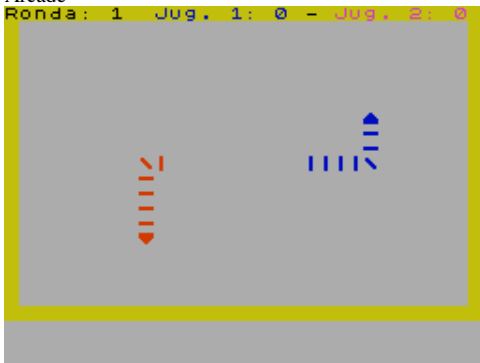

Dominator (Electric Dreams Software,1989)
Arcade



Dominion (Pandora,1991)
Arcade

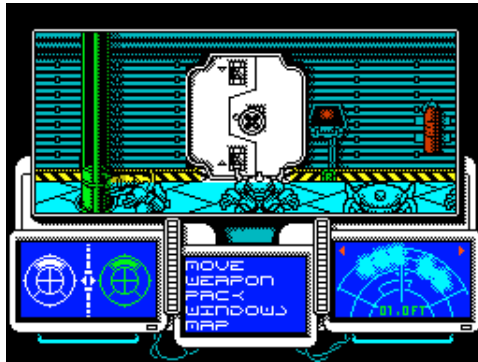

Domino 3-D (Sound On Sound,)
Board/Card Game



Dominoes (Phipps Associates,1983)
Board/Card Game

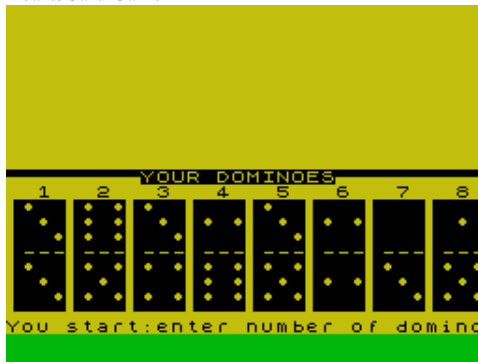

Donald's Alphabet Chase (Disney Software,1991)
Educational

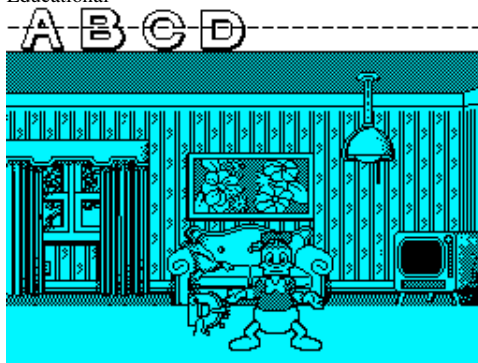

Domine (Moj Mikro,1985)
Board/Card Game

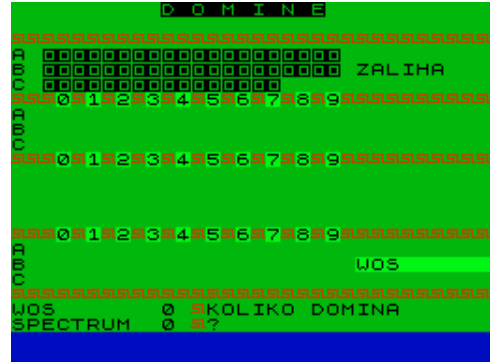

Domino (ABC Soft,1985)
Board/Card Game

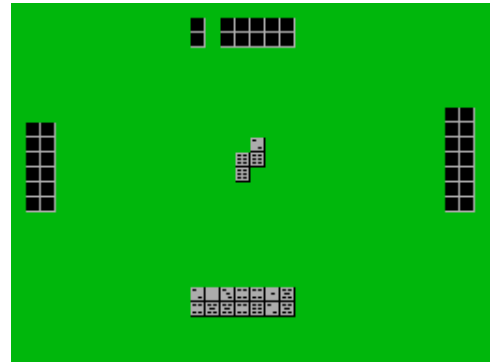

Dominoes (CDS Microsystems,1988)
Board/Card Game

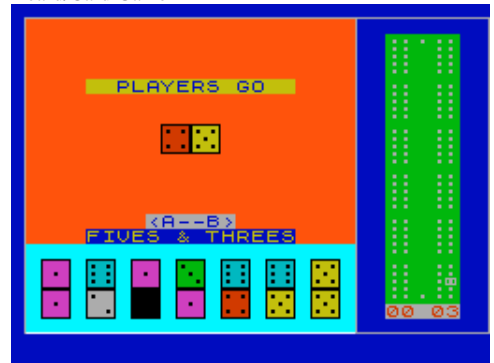

Domino's (C.W. May,)
Board/Card Game

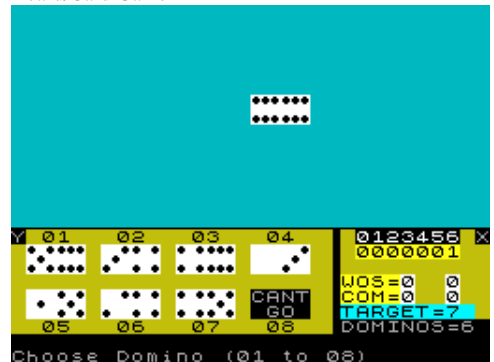

Dona Pepa (MicroHobby,1985)
Board/Card Game



Don Cosme (MicroHobby,1985)
Arcade



Don Juan Tenorio (Francisco Javier Rodriguez Para,1989)
Text Adventure



Donkey Kong Jr. (Thomas Busse,1984)
Arcade



Don Quijote de la Mancha (Aventuras Level 10,1989)
Text Adventure



Don't Panic - Panic Now (Dented Designs,1986)
Text Adventure

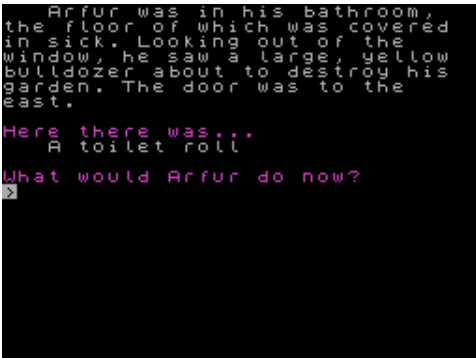

Don Din: El Saber no Ocupa Lugar (David Fraile,)
Board/Card Game

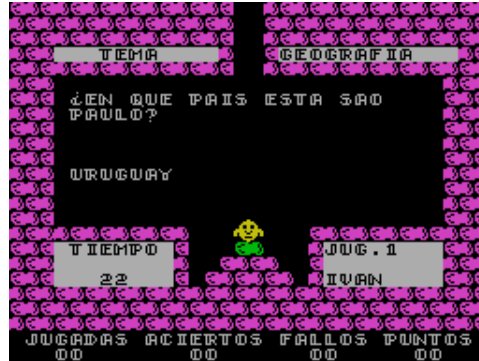

Donkey Kong (Ocean Software Ltd,1986)
Arcade

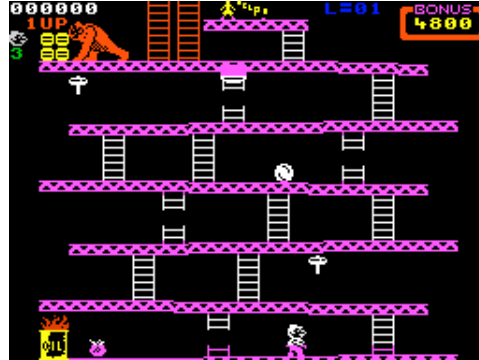

Do Not Pass Go (Work Force,1982)
Board/Card Game



Don't Buy This (Firebird Software Ltd,1985)
Compilation



Don't Pull It Too Much George (Sygma Press,)
Scene Demo



Doni-UDG (Donisoft,1984)
Utility: Font/UDGs

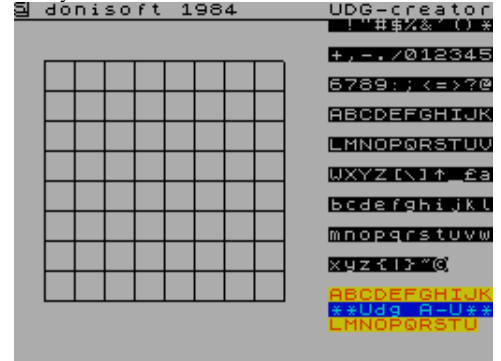

Donkey Kong Jr. (Sir Clive and Mr ZX,)
Arcade



Don Quijote (Dinamic Software,1987)
Text Adventure



Don't Panic (Firebird Software Ltd,1985)
Arcade

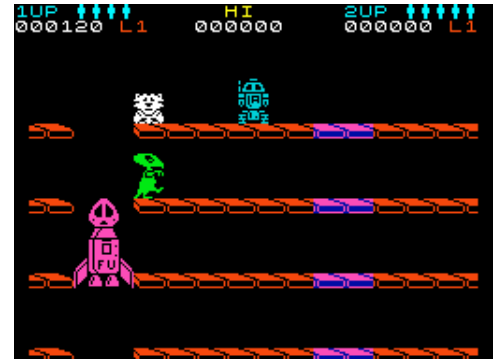

Don't Say It, Spray It (Pirate Software Ltd,1988)
Arcade

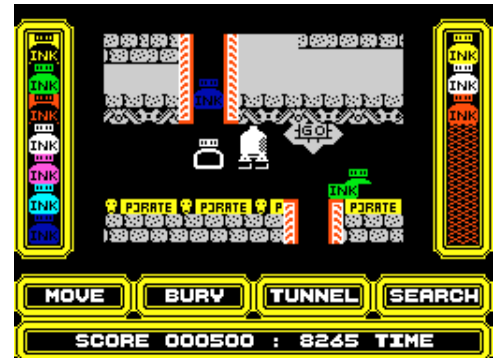

Don't Stop the Music (Castor Cracking Group,1987)
Scene Demo



Doom (Cobra Computer Software,1995)
Arcade

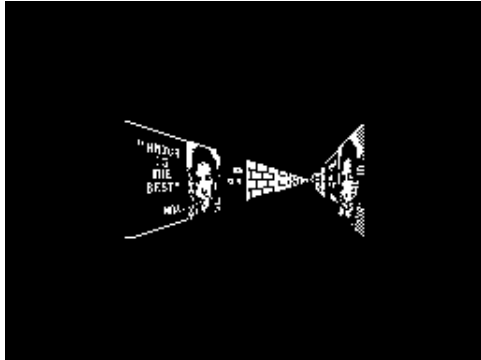

Doombase (Sparklers,1986)
Arcade

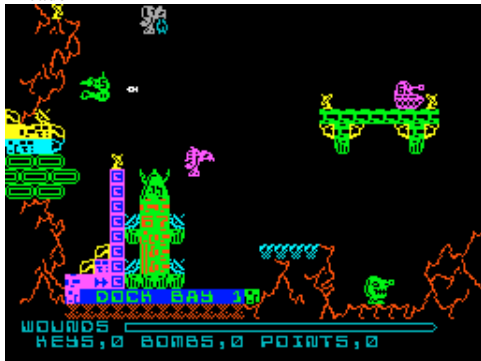

Doomdark's Revenge (Beyond Software,1984)
Strategy



Doom Mania (Syndicate,1996)
Arcade

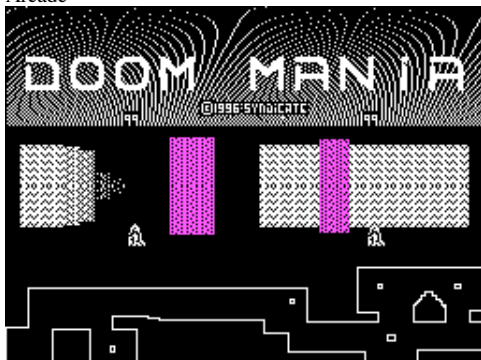

Doody Gei (The United Minds/Extacy-3,1995)
Scene Demo

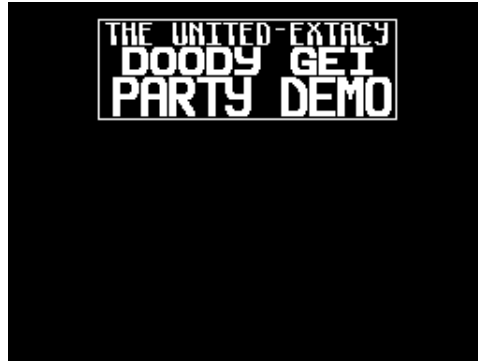

Doom (Digital Reality [2],1996)
Arcade



Doombugs (Work Force,1983)
Arcade

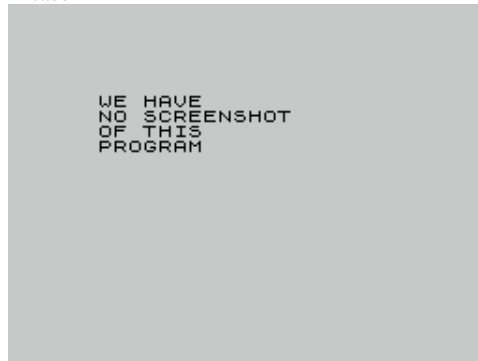

Doomdark's Revenge Editor (PDT,1985)
Arcade Game Development Tool



Doomsday (Relion Software,1991)
Text Adventure

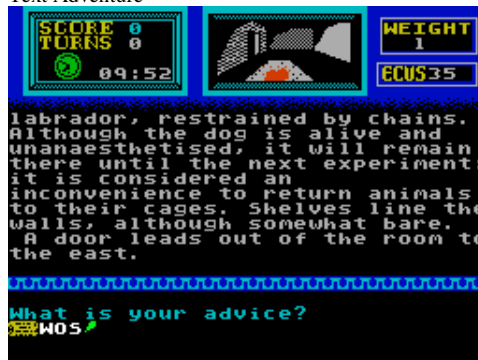

Doolhof (,1984)
Arcade

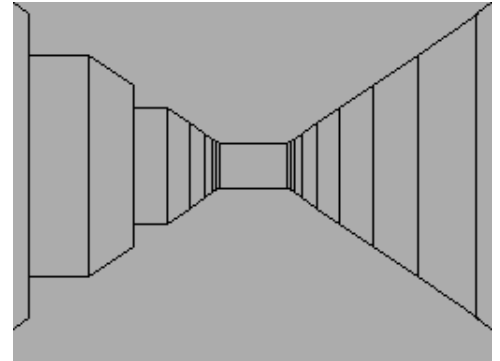

Doom 2 (JSH Company Ltd.)
Scene Demo

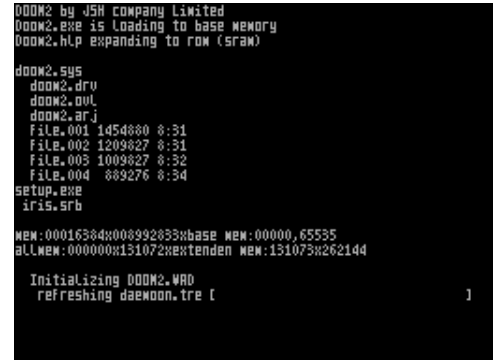

Doom Castle (The PRess Adventure,)
Text Adventure



Doom Demo (Cobra Soft,1996)
Scene Demo

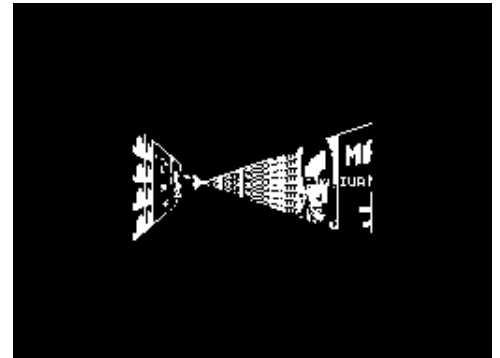

Doomsday Castle (Fantasy Software [1],1983)
Arcade



Doomsday Papers, The (Matand Software,1986)

Text Adventure

```

I AM IN PROF.FERRIC'S LAB. I CAN
SEE THE TIME MACHINE AT THE FAR
END OF THE LAB. ON THE FRONT OF
THE MACHINE IS AN OPEN HATCH.
YOU'RE THE BRAINS! WHAT NOW?
>W
THAT'S NOT POSSIBLE HERE.
YOU'RE THE BRAINS! WHAT NOW?
>N
THAT'S NOT POSSIBLE HERE.
YOU'RE THE BRAINS! WHAT NOW?
>U
THAT'S NOT POSSIBLE HERE.
WHAT NEXT?
>S
THAT'S NOT POSSIBLE HERE.
WHAT NEXT?
>I
I'M CARRYING:
NOTHING AT ALL.
WHAT NEXT?
>WOS

```

Dorado, El (Atlantis Software Ltd,1985)

Text Adventure

```

You are in a clearing in the
rain-forest, with light filter-
ing down through the tree canop-
y to reveal a profusion of vegeta-
tion. The clearing is dominated
by a statue of the Inti, the Sun
God. Dense undergrowth surrounds
you, but a path leads SOUTH.

Use TASK to see your objectives.

You are carrying:-
a string of rosary beads (worn)

Give me your command.
>WOS

```

Dotty (Dollarsoft,1984)

Arcade



Double Agent + Escape (Tartan Software,1987)

Compilation



Double Dare (Alternative Software Ltd,1991)

Board/Card Game

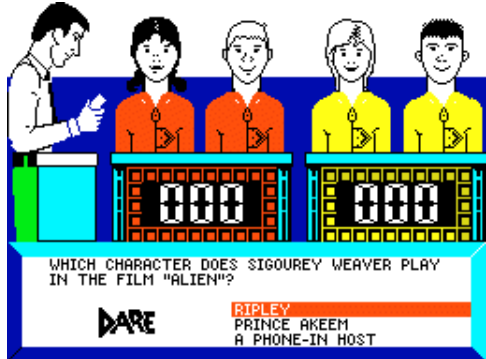

Doomskulle (Crash,1990)

Arcade



Dos en Dos (Load 'n' Run [Spa],)

Board/Card Game

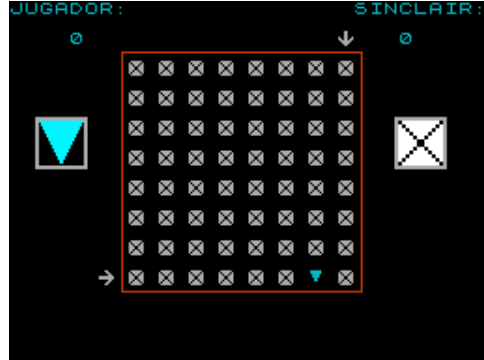

Double (Datamasters Software,1996)

Arcade

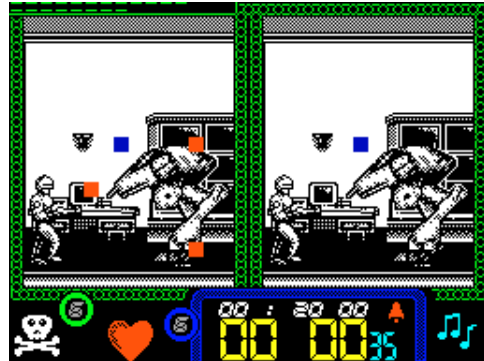

Double Bill, 3D (Go-It-Along Software,1987)

Arcade



Double Dash (Proxima Software,1990)

Arcade



Doomwatch (Live-Wire Software,1986)

Arcade

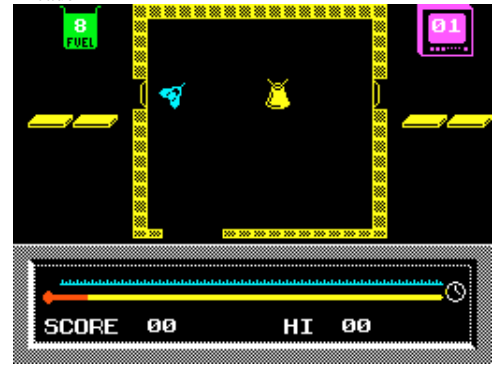

Dos Lineas (MicroHobby,1985)

Arcade



Double Agent (Tartan Software,1987)

Text Adventure



Double Classic (Zenobi Software,)

Compilation



Double Dealer (MFM Data Services Ltd,1984)

Compilation



Double Density Format Program (Technology Research Ltd,1984) Utility



Double Dragon III: The Rosetta Stone (Storm Software [2],1991) Arcade



Double Play Adventure 01 (Double Play Adventures,1986) Compilation



Double Play Adventure 04 (Double Play Adventures,1986) Compilation

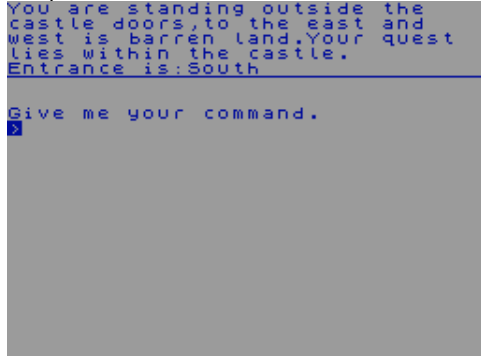

Double Play Adventure 07 (Double Play Adventures,1986) Compilation

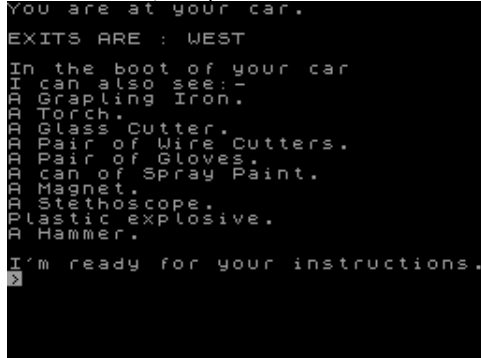

Double Dragon (Melbourne House,1989) Arcade

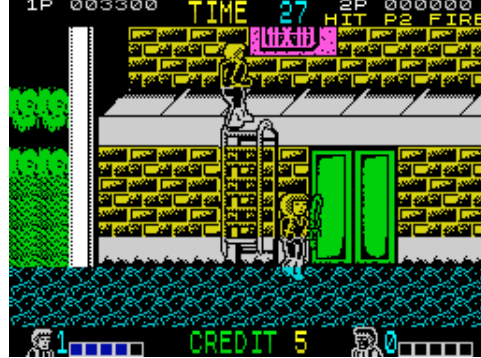

Double Editor, The (BadBeard,2005) Arcade Game Development Tool



Double Play Adventure 02 (Double Play Adventures,1986) Compilation

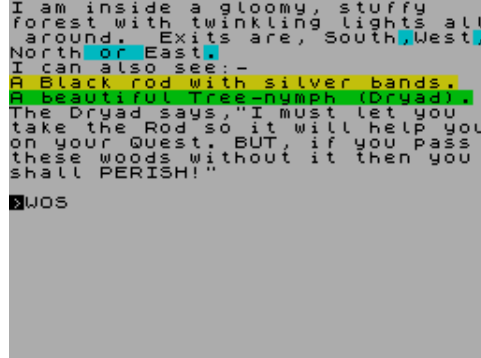

Double Play Adventure 05 (Double Play Adventures,1986) Compilation

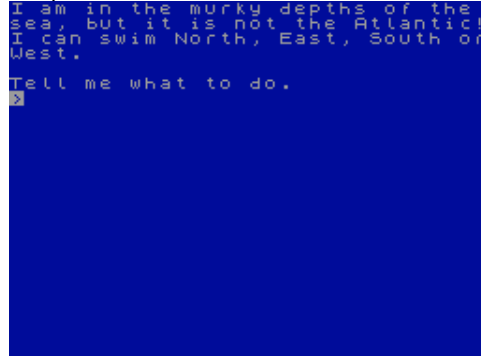

Double Play Adventure 08 (Double Play Adventures,1986) Compilation



Double Dragon II: The Revenge (Virgin Mastertronic Ltd,1989) Arcade



Doubleit (Camel Micros,1984) Text Adventure



Double Play Adventure 03 (Double Play Adventures,1986) Compilation

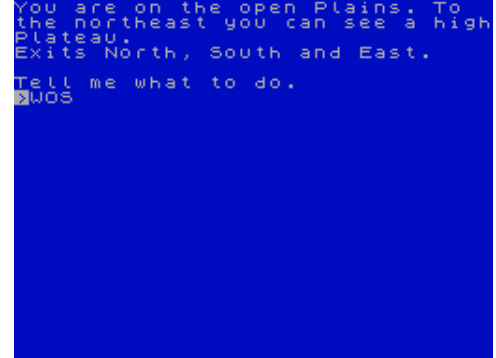

Double Play Adventure 06 (Double Play Adventures,1986) Compilation

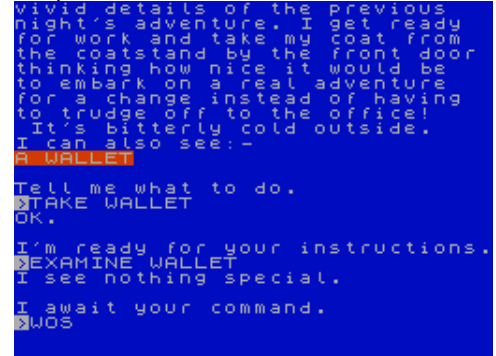

Double Play Adventure 09 (Double Play Adventures,1986) Compilation



Double Play Adventure 10 (Double Play Adventures, 1986)

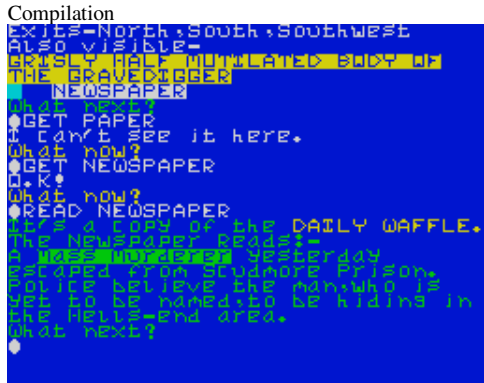

Doubler MkII (Evesham Micro Centre, 1984)
Utility: Copier

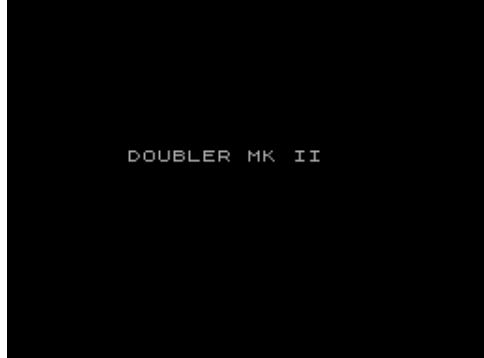

Double Tetris (MAS, 1996)
Arcade

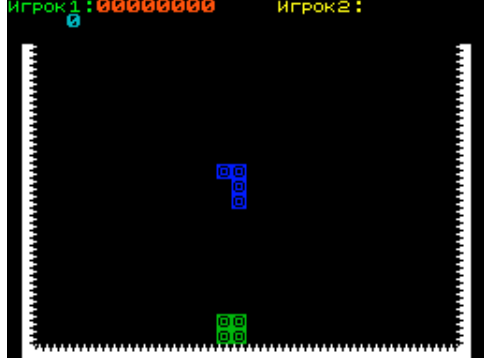

Double Value Cassette (Valuesoft, 1983)
Compilation



Downhill Champion (Lambourne Games, 1988)
Strategy

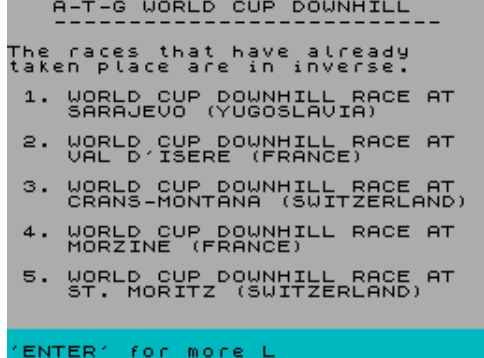

Double Play Adventure 11 (Double Play Adventures, 1986)

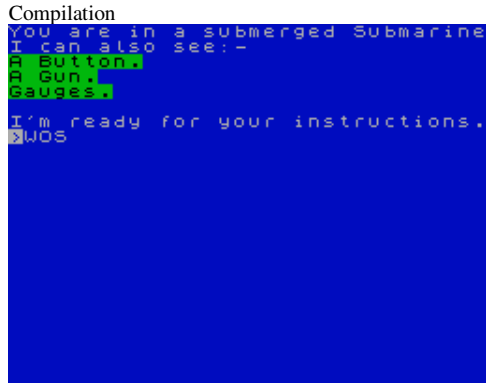

Double Take (Ocean Software Ltd, 1987)
Arcade



Double, The (Scanatron, 1987)
Simulation



Double Xinox (ZX-Masters Software, 1995)
Arcade

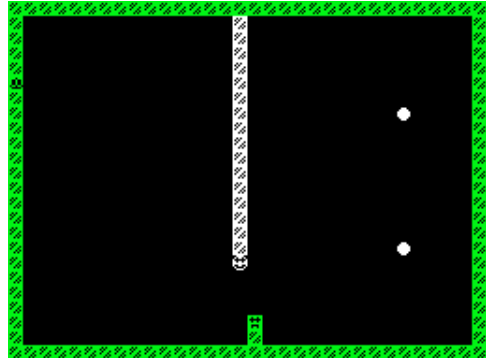

Down to Earth (Firebird Software Ltd, 1987)
Arcade



Double Play Adventure 12 (Double Play Adventures, 1986)

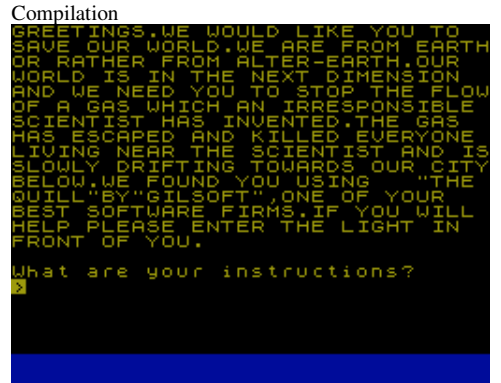

Double Tennis (VM Soft, 1990)
Arcade



Double Trouble (Starlite, 1984)
Arcade



Dow Joined (Total Eclipse, 1992)
Scene Demo



Downtown (Atlantis Software Ltd, 1991)
Arcade Adventure



Down Under (Hansesoft GmbH,1984)

Strategy



Draconus (Zeppelin Games Ltd,1988)

Arcade Adventure



Dracula's Castle (Silicon Joy,1984)

Arcade



Dragon Breed (Activision Inc,1990)

Arcade



Dragon Ninja (Imagine Software Ltd,1988)

Arcade



Dracman, 3D (Your Computer,1984)

Arcade

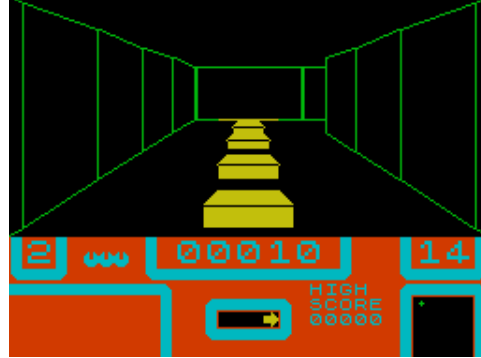

Dracula (CRL Group PLC,1986)

Text Adventure



Draculas Diamanten (,)

Text Adventure



Dragonfire (Cheetahsoft Ltd,1984)

Arcade

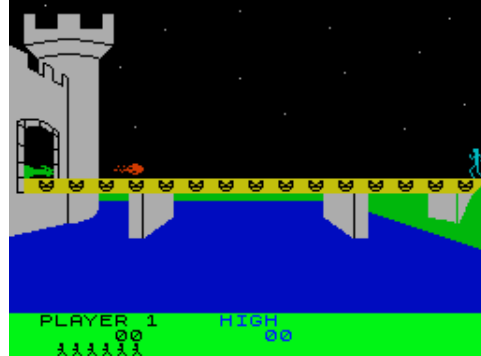

Dragon of Notacare, The (The Guild,1986)

Text Adventure



Draco (MicroHobby,1985)

Arcade



Dracula's Castle (CP Software,1984)

Text Adventure

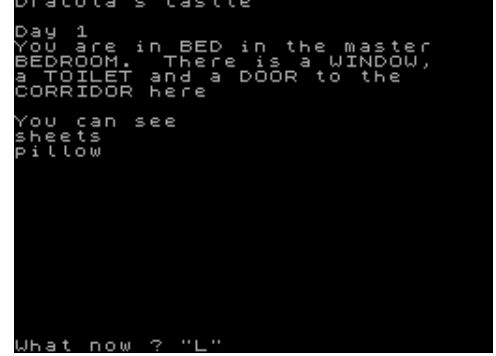

Dragnet (Taskmaster Software,)

Text Adventure

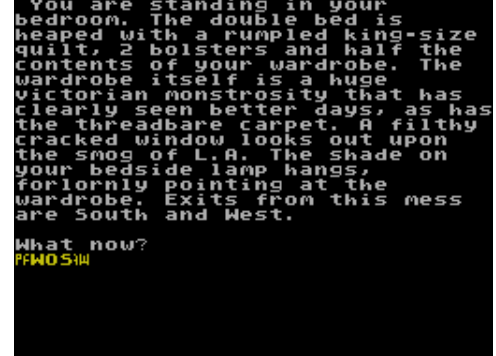

Dragonica (Astros Productions,1988)

Arcade Adventure



Dragon Quest (Zenobi Software,1994)

Text Adventure

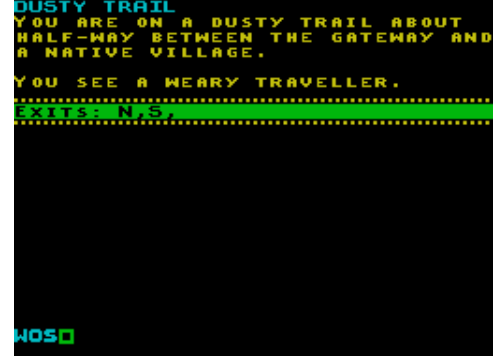

Dragonsbane (Quicksilva Ltd,1983)
Arcade Adventure

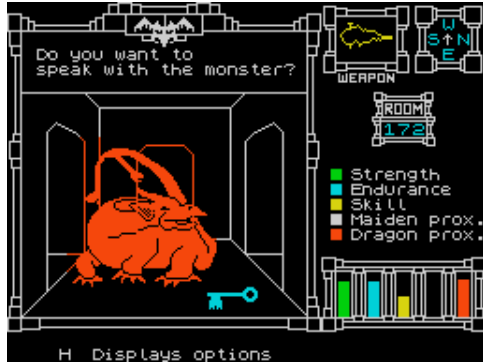

Dragons Lair 2 Demo (Dimitry Kulikov,1993)
Scene Demo

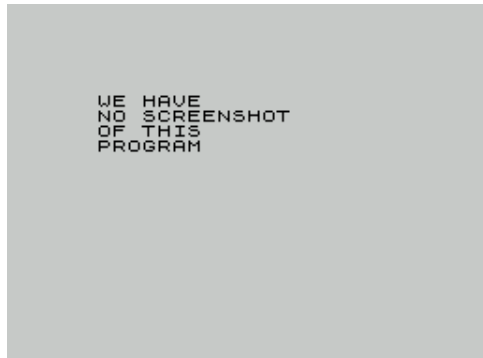

Dragon Slayer (Double Play Adventures,1984)
Text Adventure

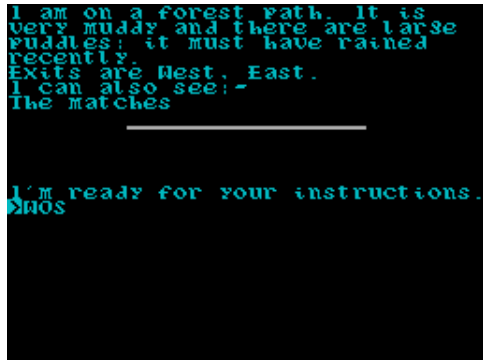

Dragon Spirit (Domark Ltd,1989)
Arcade

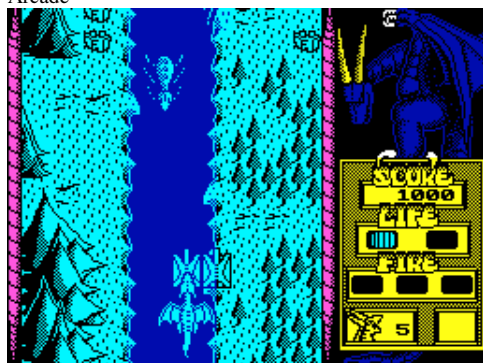

Drainlayer 2 (Pricing Building Works,1984)
Utility



Dragon's Lair (Software Projects Ltd,1986)
Arcade

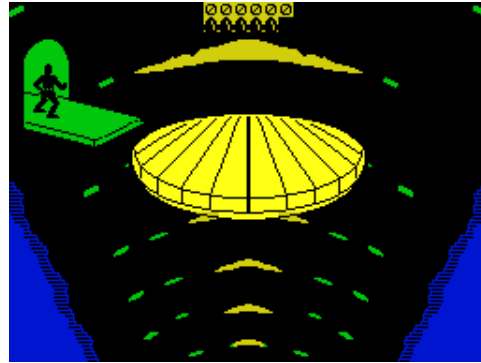

Dragon's Lair II: Escape from Singe's Castle (Software Projects Ltd,1987) Arcade



Dragon Slayer (Dream World Adventures,1992)
Text Adventure

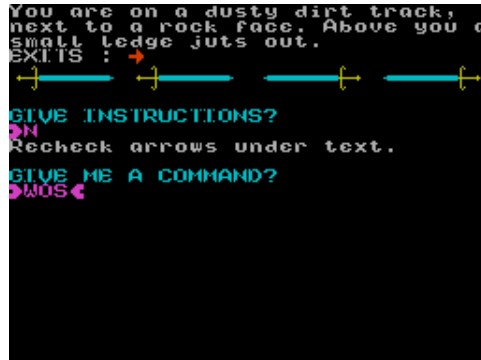

Dragon Star Trilogy (Delta 4 Software,1995)
Text Adventure

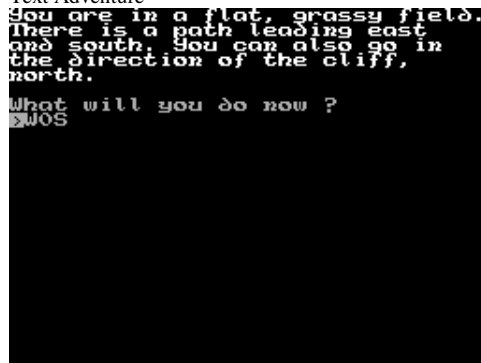

Drakkar (Delta Software,1989)
Arcade Adventure



Dragon's Lair + Buggy Boy (MCM Software S.A.,1989)
Compilation



Dragons Land (XL-Design Inc,1995)
Strategy



Dragons of Flame (US Gold Ltd,1990)
Arcade Adventure

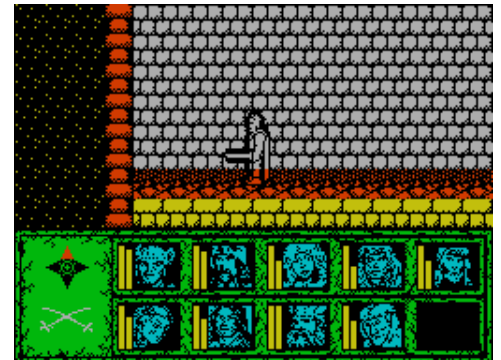

Dragonorc (Hewson Consultants Ltd,1985)
Arcade Adventure



Drakmaze (Mikro-Gen Ltd,1984)
Arcade

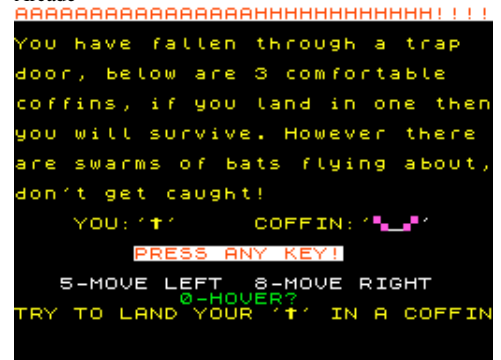

Draughts (.1984)
Board/Card Game

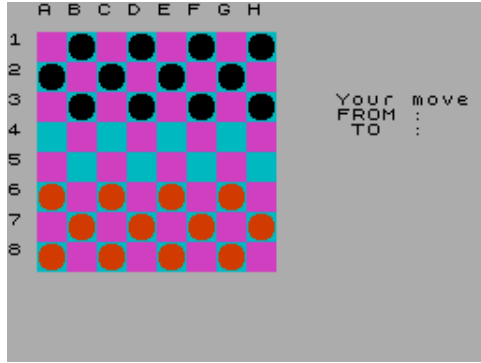

Draughts (Oasis Software,1984)
Board/Card Game

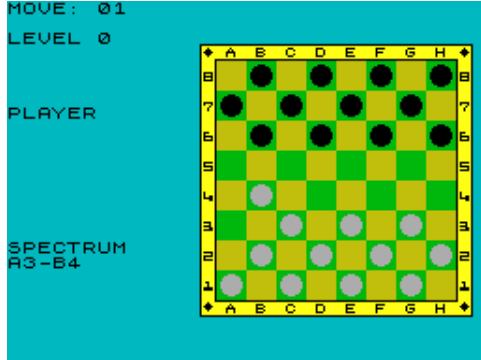

Draughts Master (CP Software,1982)
Board/Card Game

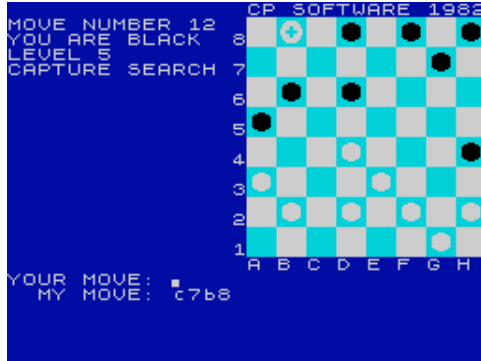

Draw 15/Graphics Subroutine (Fowler Software,1984)
Utility



Draw Mandel (.)
Utility: Screen Manipulation

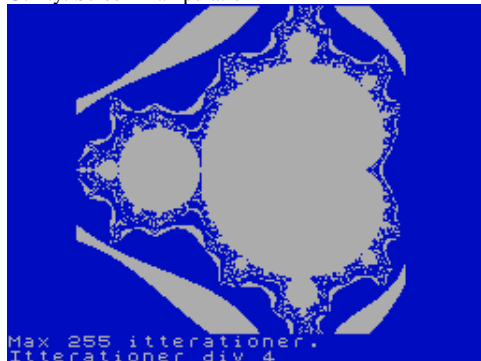

Draughts (16/48 Tape Magazine,1985)
Board/Card Game

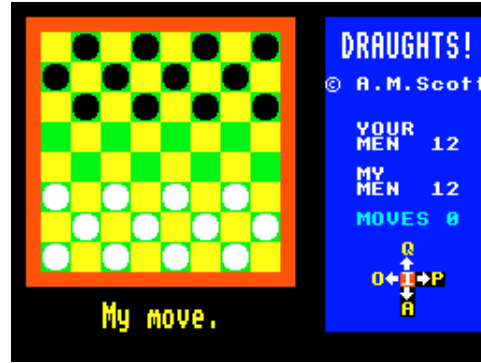

Draughts (P. Macey,1983)
Board/Card Game

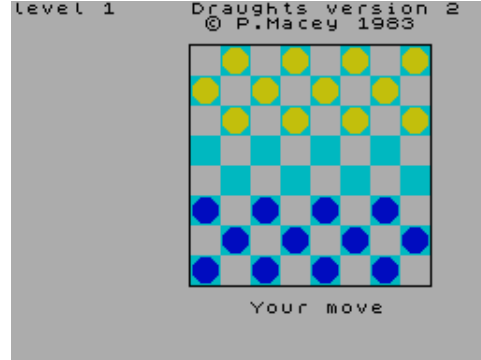

Draw (.)
Utility: Drawing

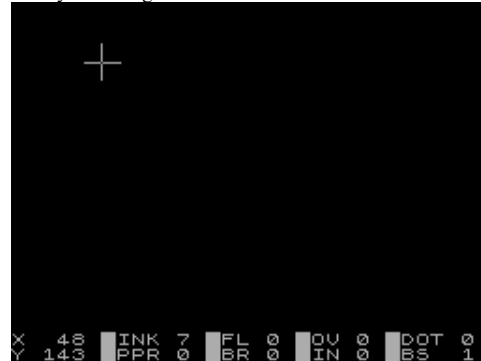

Drawer (Coral Software,1983)
Utility: Drawing



Draw Master (Campbell Systems,1983)
Utility: Drawing

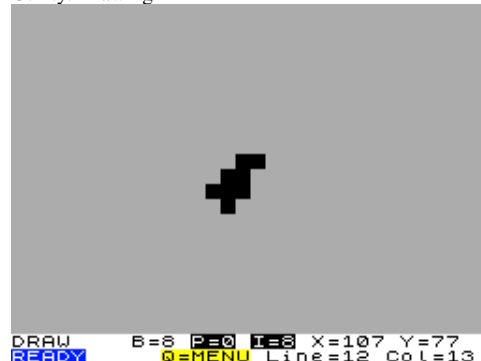

Draughts (CRL Group PLC,1983)
Board/Card Game



Draughts Genius (Rack-It,1987)
Board/Card Game



Draw (Sinclair Research Ltd,1982)
Utility: Drawing



Draw It (Your Sinclair,1991)
Utility

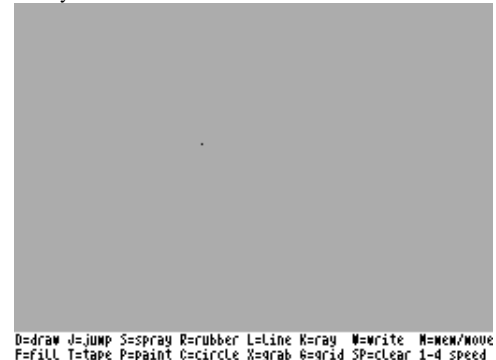

Draw Poker (16/48 Tape Magazine,1985)
Board/Card Game

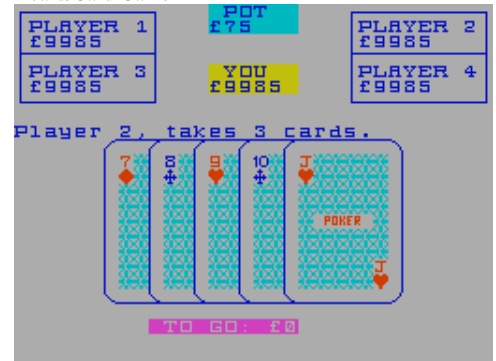

Drazen Petrovic Basket (Topo Soft,1989)
Sport



Dreadnoughts (MC Lothlorien Ltd,1983)
Strategy

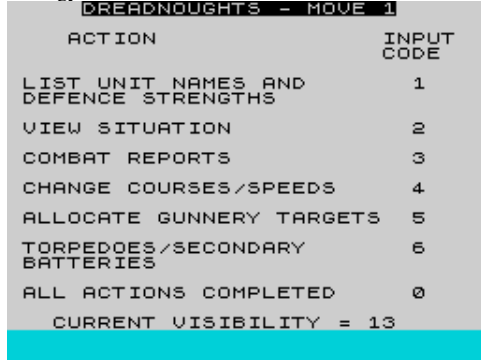

Dream Concert, The (Adventure Probe Software,2002)
Text Adventure

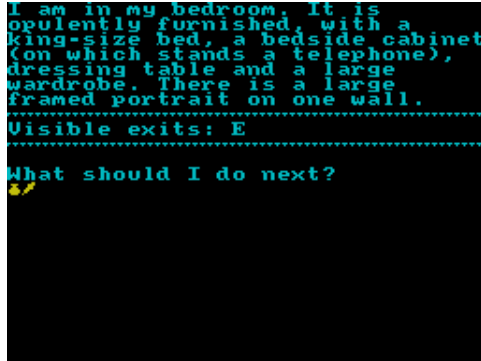

Dreamweb (.)
Text Adventure



Driller (Incentive Software Ltd,1987)
Arcade



Dr. Bongo's Safari Park (Custom Software,1983)
Text Adventure

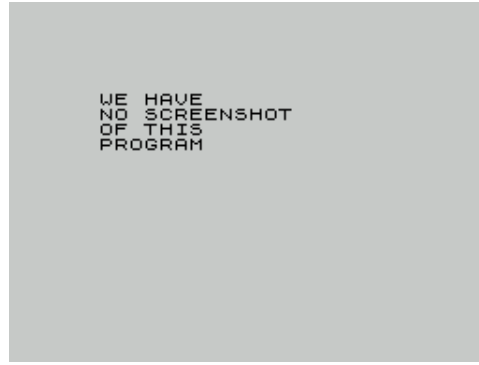

Dreadnoughts at Jutland (Specsim,1987)
Strategy



Dream Team, The (Ocean Software Ltd,1993)
Compilation



Dr. Franky and the Monster (Virgin Games Ltd,1984)
Arcade



Driller Tanks (Sinclair Research Ltd,1983)
Arcade



Dr. Doom's Revenge (Empire Software,1989)
Arcade Adventure

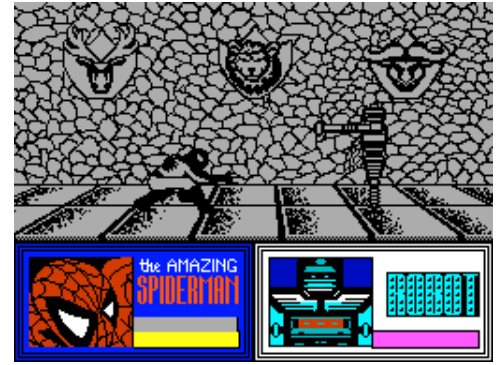

Dreamare (Elven Adventurers,1991)
Text Adventure



Dream Warrior (US Gold Ltd,1988)
Arcade



Dr. Genius (Loricels,1984)
Text Adventure



Drink 'Em (RST7,1994)
Scene Demo



Drive-In, The (Fantasy Software [1],1984)
Arcade



Driver, 3D (Virgin Books,1983)
Arcade

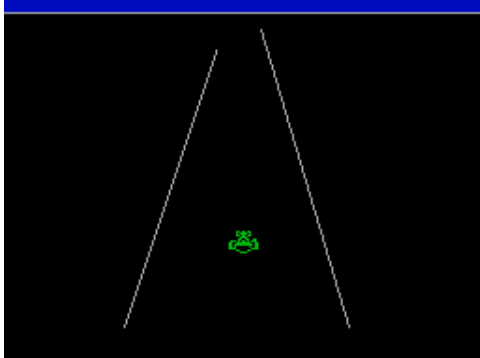

Dr. Jekyll vs. Mr Hyde (Morbosoft,1989)
Text Adventure



Droga do Duplandu (H-PRG,2003)
Text Adventure



Dropout (Micro Press [1],1983)
Arcade

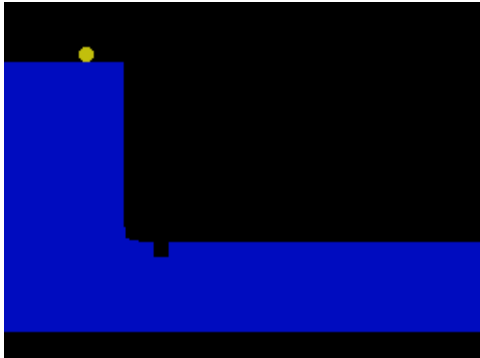

Driver (Sinclair Programs,1983)
Arcade

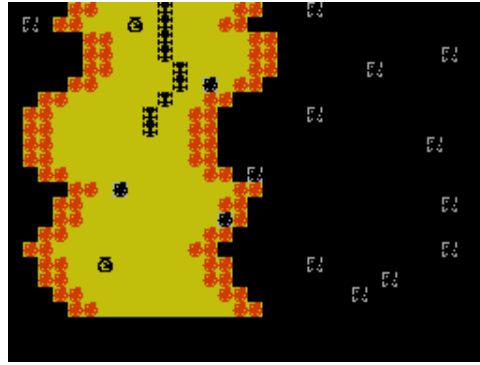

Dr. Jackel and Mr. Wide (Bulldog,1987)
Arcade



Dr. Jekyll und die Geheimformel (Potz Blitz,1985)
Arcade



Droidz (Silverbird Software Ltd,1988)
Arcade

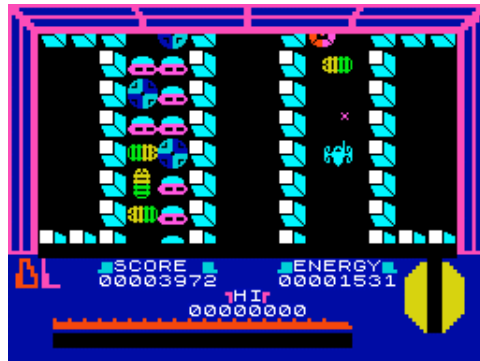

Drop Out (Virgin Books,1983)
Board/Card Game

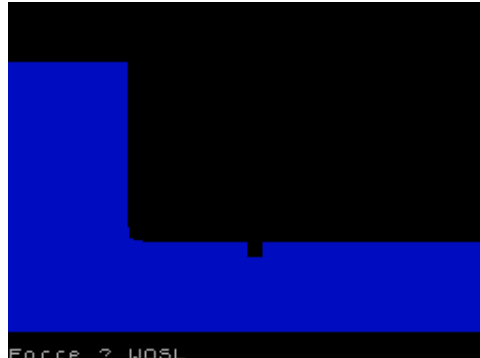

Driver 2 - Leeds - Settle - Carlisle (Ashley Greenup,1988)
Simulation

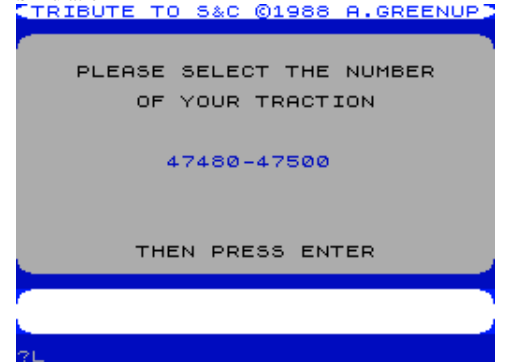

Dr. Jekyll and Mr. Hyde (Essential Myth,1988)
Text Adventure

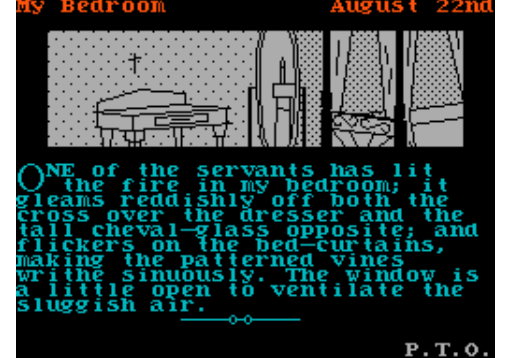

Dr. Maddo (US Gold Ltd,1986)
Arcade

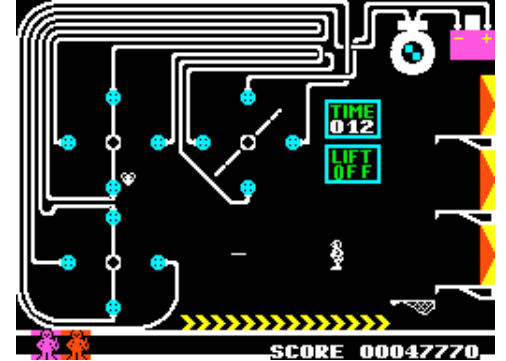

Drop a Brick (Sinclair Research Ltd,1982)
Arcade



Drop Out (Your Spectrum,1985)
Board/Card Game

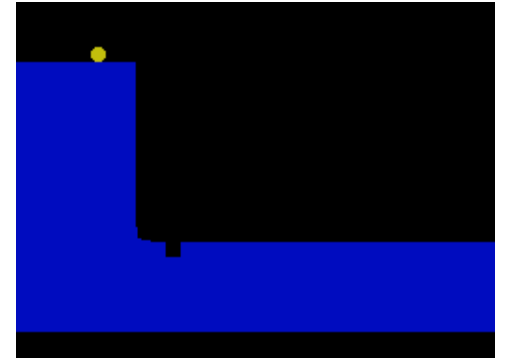

DR Scroll (Digital Image,1989)
Utility

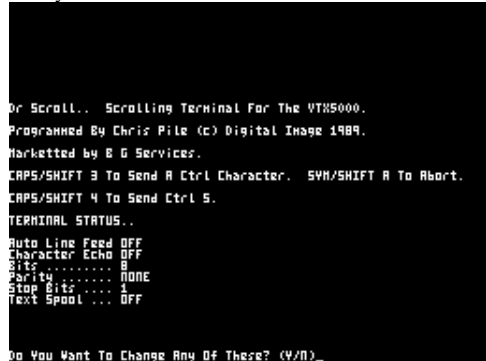

Druid (Firebird Software Ltd,1986)
Arcade



Drumbeat (.)
Utility: Sound Manipulation

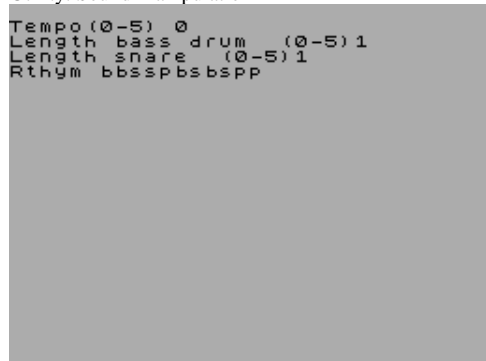

Drunk Dizzy (Black Eagle Company,1995)
Arcade Adventure



DTP Pack (PCG Software,1991)
Compilation

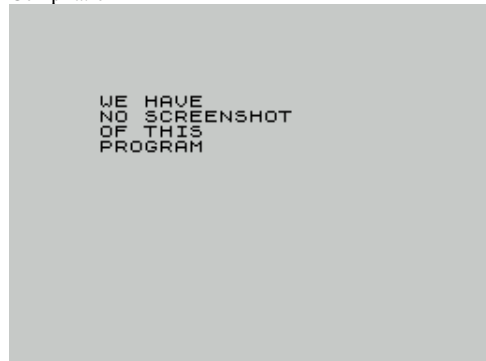

Drug File (R.D. Foord Software,1985)
Utility



Druid II: Enlightenment (Firebird Software Ltd,1986)
Arcade

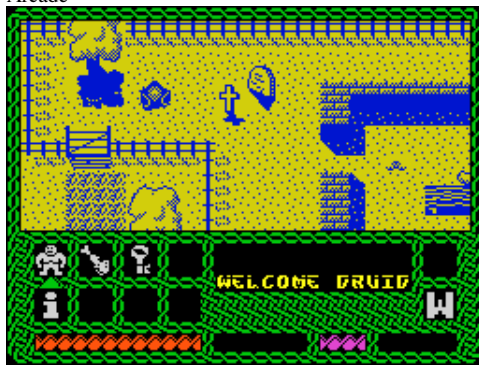

Drum Machine (Steve A.J. Broad,1984)
Utility: Music Creation

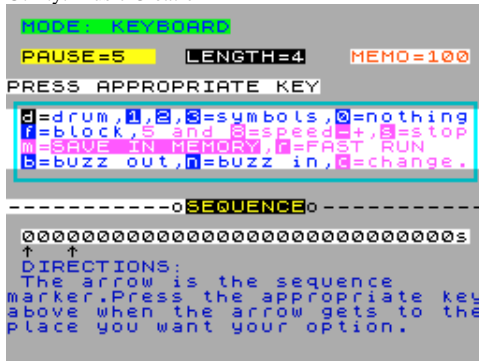

Drunk Policeman (Automata UK Ltd,1985)
Arcade



DU54 (John Elliott,1998)
Utility

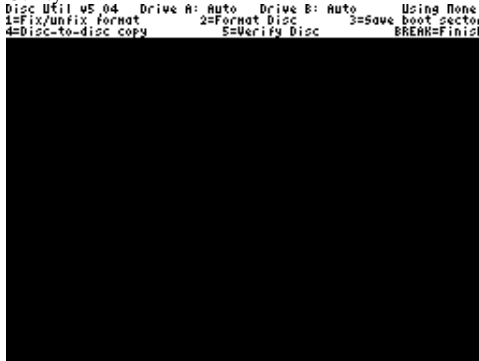

Drug Watch (Nottinghamshire Constabulary,1985)
Arcade



Druids Moon (Alternative Software Ltd,1987)
Text Adventure

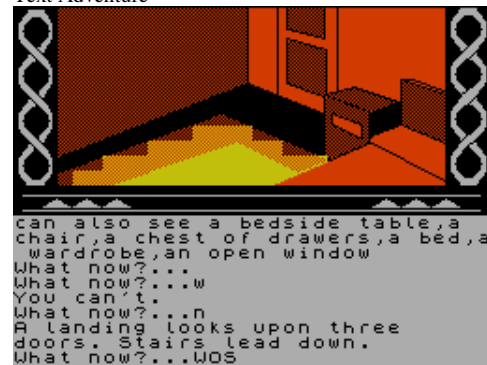

Drums (Einstein Software,1985)
Utility: Sound Manipulation



Drunk Show (Benkosoft,1994)
Scene Demo



Dubbeldool (Bert Koning,1986)
Board/Card Game

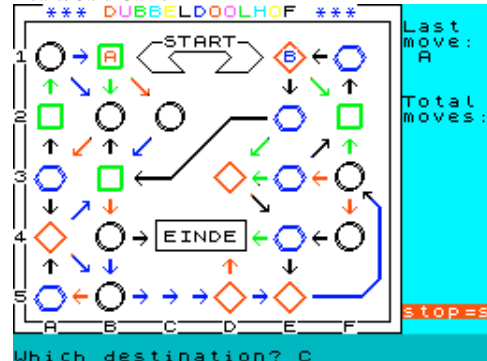

Duckmania (Depeche Code,1993)
Scene Demo



Duckworth Highway Code (Duckworth Educational Computing,1985) Educational

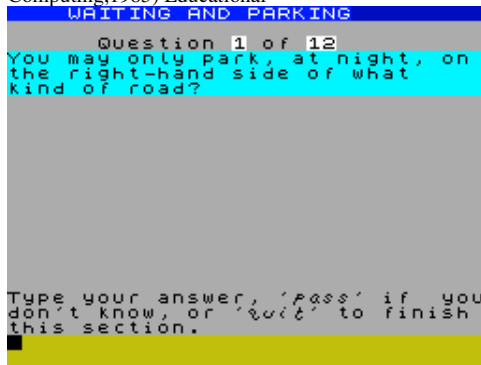

Duelo a Muerte (MicroHobby,1984)
Arcade



Duende Perdido, El (MicroHobby,1985)
Arcade



Duke Bluebeard's Castle (M.42 Software,1985)
Text Adventure

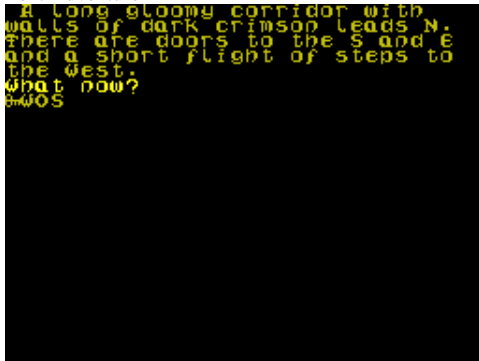

Duck Out! (Dro Soft,1989)
Arcade Adventure

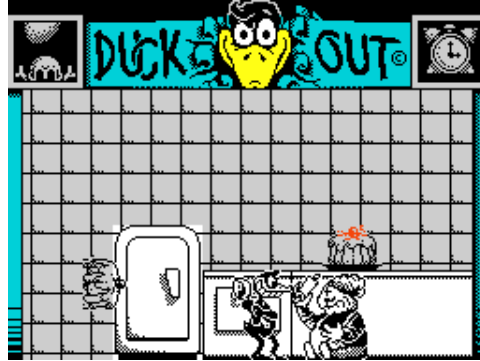

Duct, The (Gremlin Graphics Software Ltd,1988)
Arcade

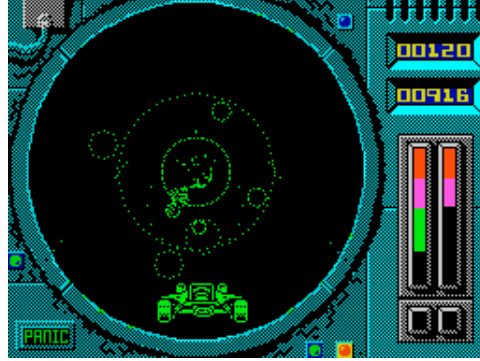

Duelo en las Estrellas (MicroHobby,1984)
Arcade



Duet (Elite Systems Ltd,1987)
Arcade

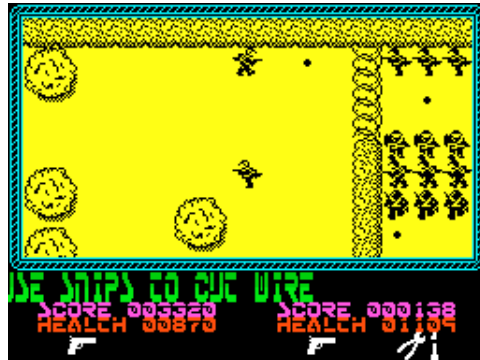

Dukes of Hazzard, The (Elite Systems Ltd,1985)
Arcade



Duck Tales: The Quest for Gold (Disney Software,)
Arcade Adventure



Duelmaster (Virgin Games Ltd,)
Arcade Adventure



Duel, The: Test Drive II (Accolade Inc,1989)
Arcade



Duggy (.)
Arcade



Dumb Duck (Anik Microsystems,1984)
Arcade



Dumper (MicroHobby,1986)
Arcade



Dundeas European Challenge (Season Soft,1986)
Simulation



Dungeon Adventure (Level 9 Computing Ltd,1983)
Text Adventure

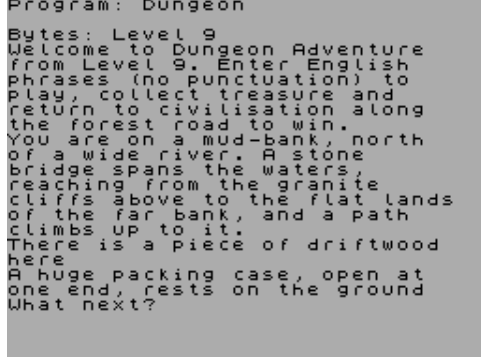

Dungeon Dare (Central Solutions,1986)
Arcade

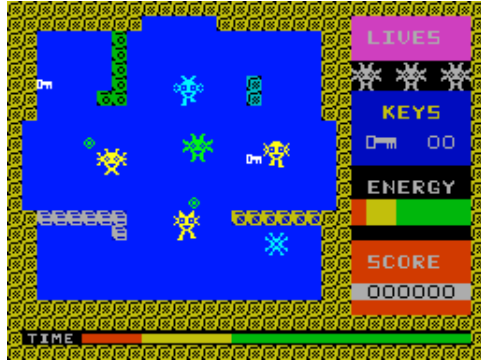

Dungeon of Death (Exclusive Software,1989)
Text Adventure

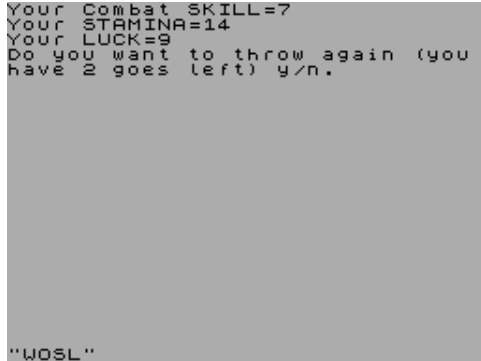

Dumpy (Bradway Software,1987)
Utility



Dune II (Infokorm,1996)
Strategy

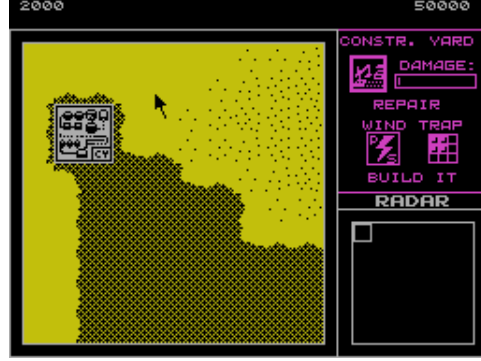

Dungeon Builder, The (Dream Software Ltd,1984)
Text Adventure Development Tool



Dungeon Dare + Classroom Chaos (Central Solutions,1986)
Compilation

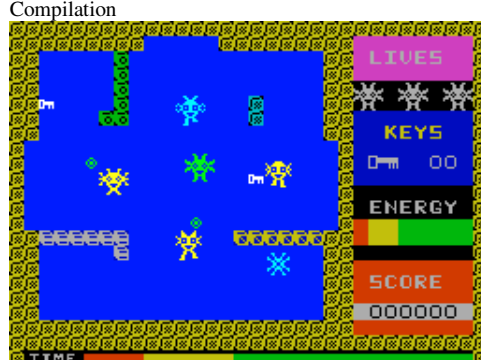

Dungeon of Torgar, The (The Guild,1993)
Text Adventure



Dun Darach (Gargoyle Games,1985)
Arcade Adventure



Dungeon (Cascade Games Ltd,1984)
Text Adventure

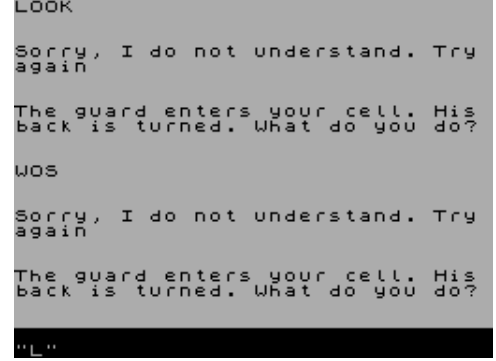

Dungeon Danny (Sinclair User,1986)
Arcade



Dungeon Master, The (Crystal Computing,1983)
Text Adventure Development Tool



Dungeon Romp, A (Zenobi Software,1995)
Text Adventure



Dungeons (J.M. Allen,1983)



Dungeons & Dragons Character Creator (Steven Davis,1986)

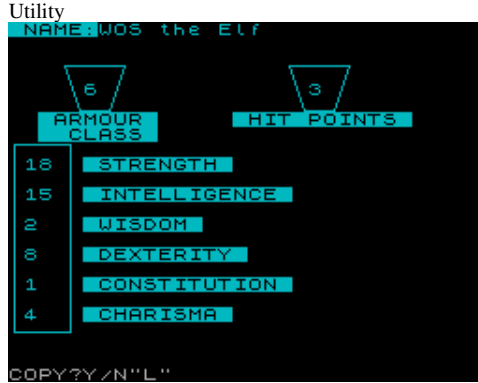

Dungeons of Doom (Temptation Software,1984)

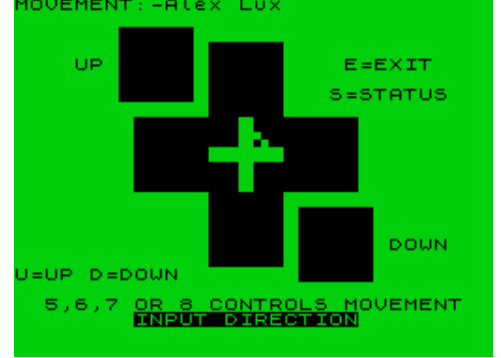

Dungeons of Maldread, The (Zenobi Software,1995)



Dungeon, The (Dave Newton,1984)

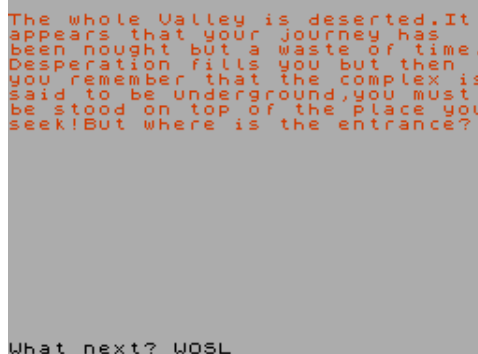

Dungeon, The (Patrick Thiel)

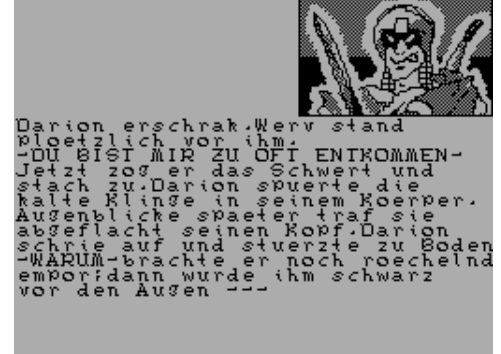

Dungeon Treasures (TM'M Studio,1993)



Dunshalt Donut, The (Anubis Software,1984)



Duplex (MicroHobby,1985)



Duplicate Bridge Computer Scoring (R.F. When,1985)



Duplicator (Ronen Nizry/Herzel S.)

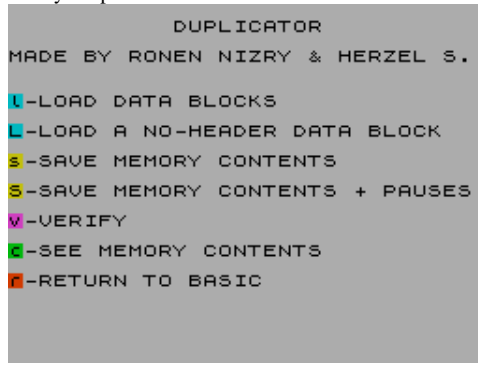

Board/Card Game

Duplitape (MicroHobby,1987)



Durak (Copper Feet,1991)

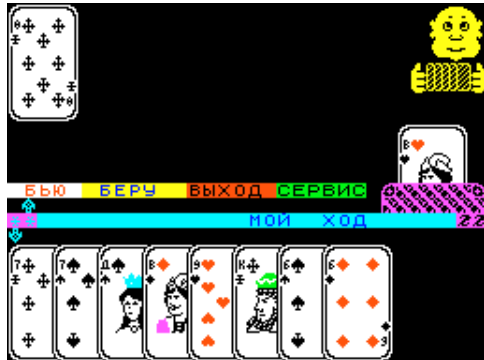

Durak 2 (Copper Feet,1994)



Dusarlyn (Crazy Soft,2003)

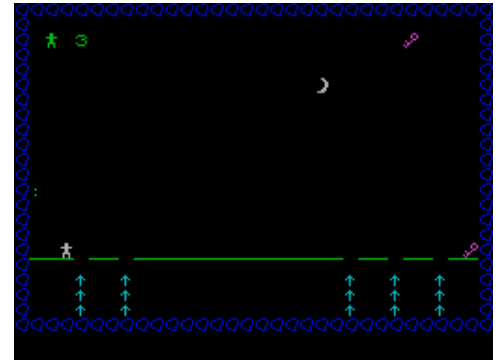

Dusk over Elfinton (Skyslip Software,1986)

Text Adventure



Dustman (Timescape Software,1984)

Arcade



Dux (EP Software,)

Arcade

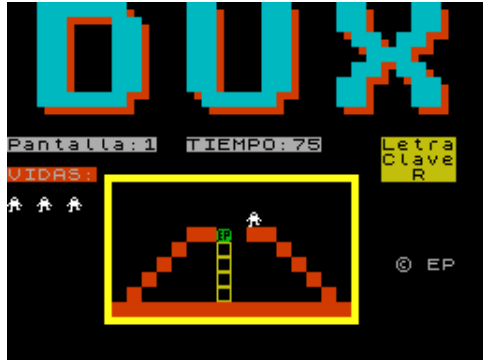

Dwarfs of Lewis (Psychaedelic Hedgehog Software,1989)

Text Adventure



Dynamic Duo (Firebird Software Ltd,1989)

Arcade

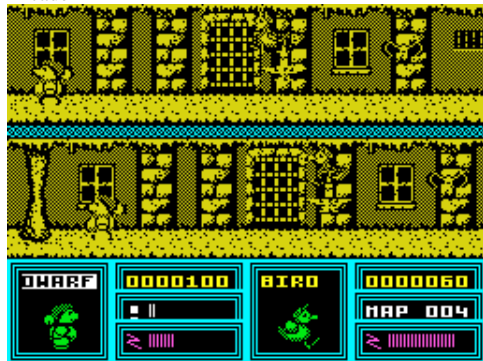

Dustbin Txp (Clive Smith,1985)

Utility: Copier

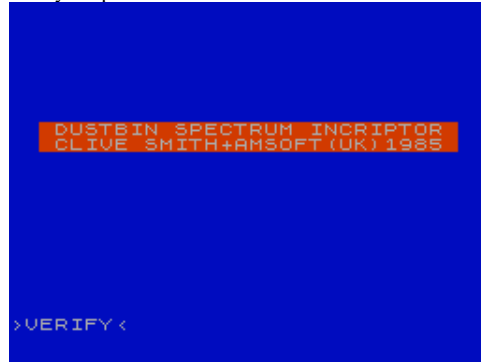

Dust of Starry Roads (GalaxySoft Corp,1997)

Arcade Adventure



Dvorak (MicroHobby,1986)

Utility



Dymonoids (Dymond Software,1983)

Arcade



Dynamic Graphics (Procom Software,1983)

Utility: Drawing



Dustin (Dinamic Software,1988)

Arcade

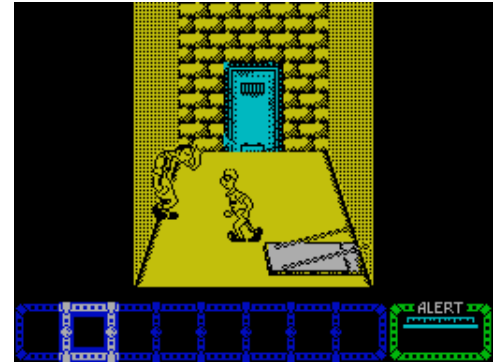

Dusty Droid and the Garbage Gobblers (Pirate Software Ltd,1988)

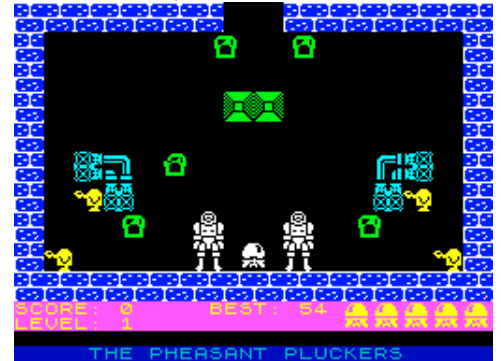

Dwarfs Domain (King Software,1984)

Text Adventure

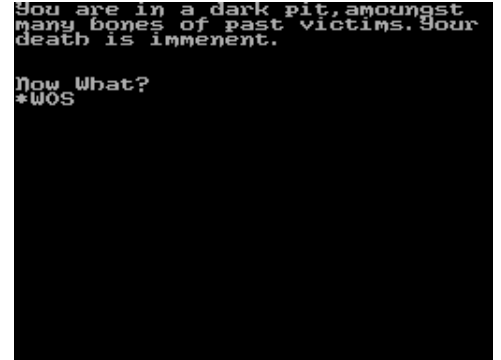

Dynamic Diver (Dynamic Software,1986)

Arcade



Dynamic Programming (Dynamic Software,1984)

Utility

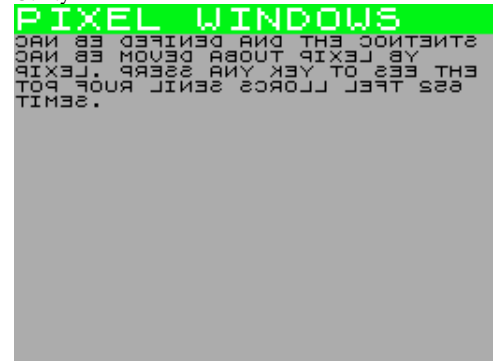

Dynamite Dan (Mirrorsoft Ltd,1985)
Arcade



Dynamite Dux (Activision Inc,1989)
Arcade



Dynasty Wars (US Gold Ltd,1990)
Arcade



Dzeta (Alexander Harlov,1995)
Arcade

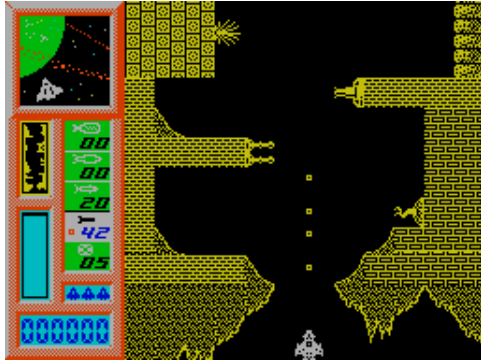

Early Punctuation (Sinclair Research Ltd,1983)
Educational

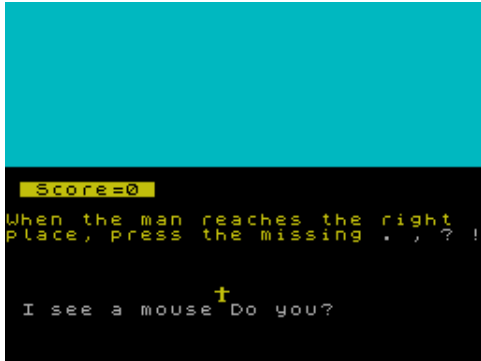

Dynamite Dan II (Mirrorsoft Ltd,1985)
Arcade

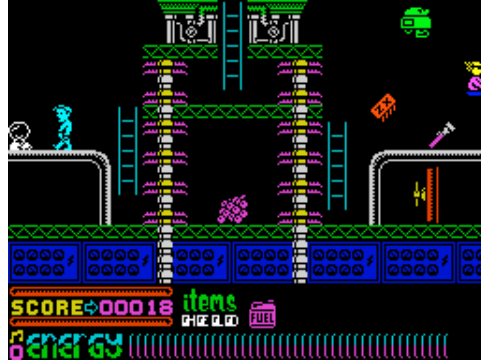

Dynamix (Virgin Mastertronic Ltd,1989)
Arcade

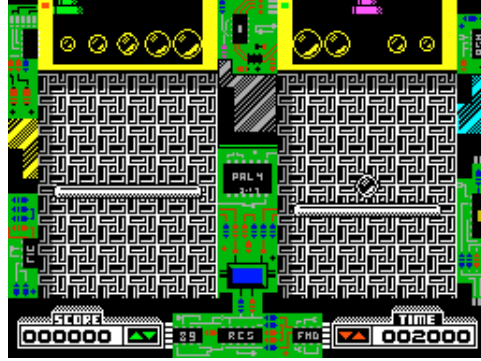

Dynatron Mission (Mastertronic Ltd,1987)
Arcade



Eagle (Dro Soft,1987)
Arcade



Earth Attack (ZX Computing,1983)
Arcade



Dynamite Duo (Var Crackhawk.)
Scene Demo



Dyna Star (Pirate Software Ltd,1988)
Arcade



Dyslexia Beater (Dunitz Software,1984)
Educational



Eagle (MicroHobby,1985)
Arcade



Earthbound (,1984)
Text Adventure

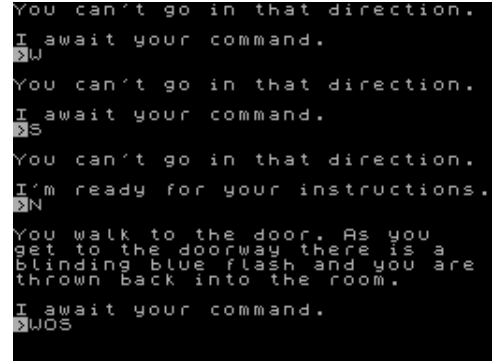

Earth Defence (Artic Computing Ltd,1984)



Earthquake (Spectrum Computing,1984)

Utility: BASIC Related



Earthshock (8th Day Software,1986)

Text Adventure



EastEnders (Macsen Software,1987)

Arcade

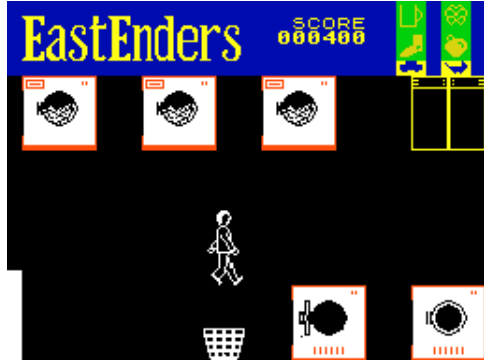

Easydraw (Westbourne Business Systems Ltd,1983)

Utility: Drawing



Earth Demo, The (CBM Software,1992)

Scene Demo



Earth Shaker (Michael Batty,1990)

Arcade



Earth War (Fanat & Co.)

Arcade



East Front (CCS,1984)

Strategy

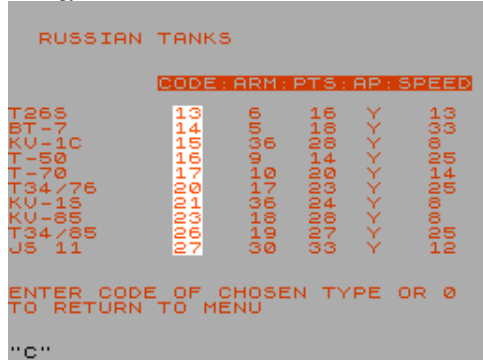

Echelon (US Gold Ltd,1988)

Arcade

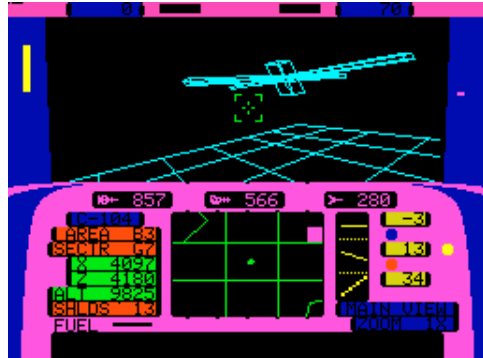

Earthlight (Firebird Software Ltd,1988)

Arcade

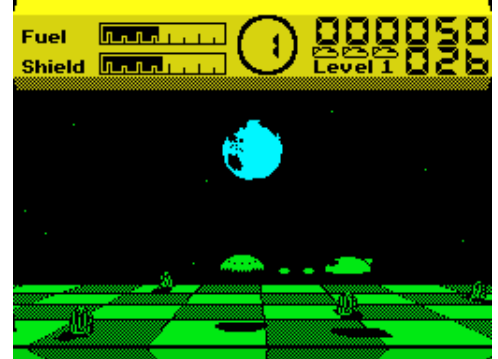

Earth Shaker Editor (Your Sinclair,1991)

Arcade Game Development Tool

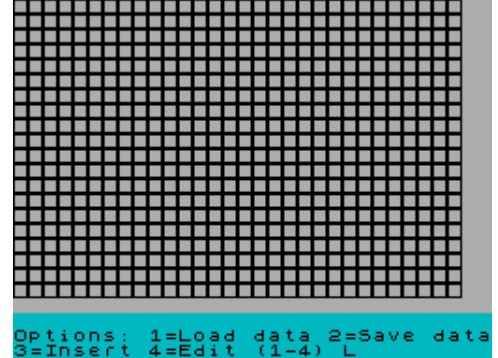

Easiledger (Gemini Marketing Ltd,1984)

Utility: Spreadsheet

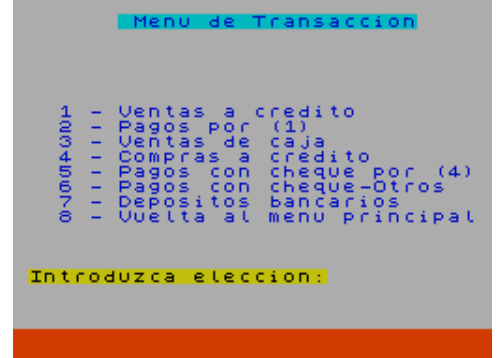

Eastmon Monitor/Disassembler (Eastway Systems,1986)

Utility



Echologia (Busy/Noro,1995)

Scene Demo

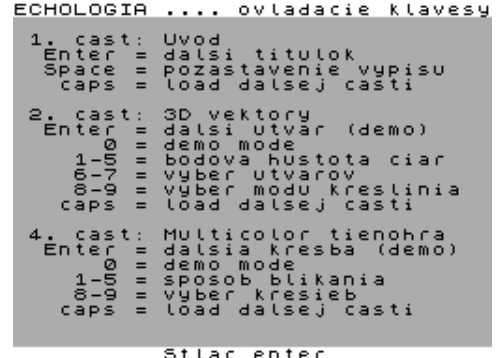

Eclipse (Zenobi Software,1991)

Text Adventure

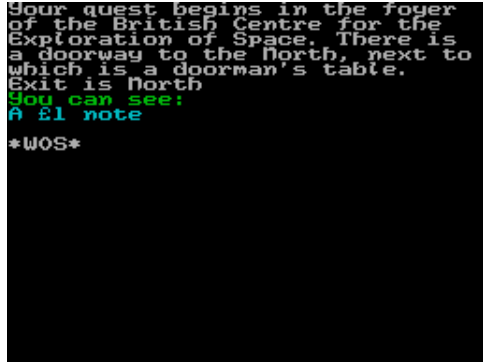

Eddie Kidd Jump Challenge (Martech Games Ltd,1984)

Arcade



Eddy Electric (Digital Star,1986)

Arcade



Editext (MicroHobby,1985)

Utility: Word Processor



Edit-M (Kapyrin M.W.,1987)

Utility: Assembler/Disassembler/Monitor

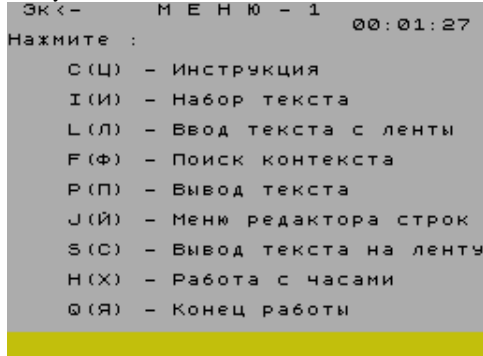

Ecstasy Mega Demo (Dream Makers Software,1996)

Scene Demo

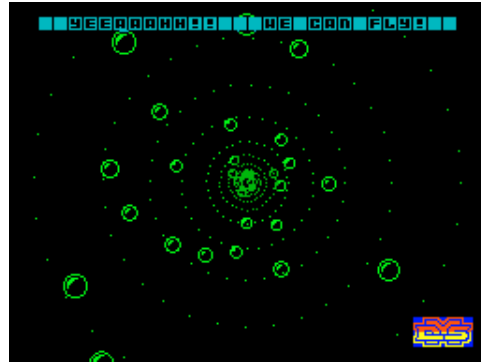

Edd the Duck (Impulze,1990)

Arcade



Edinburgh Powerbox (Ashley Greenup,1990)

Simulation

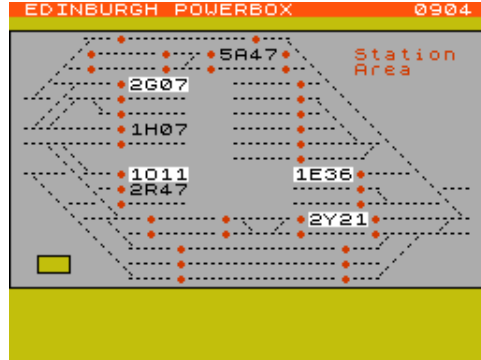

Edition One (Virgin Games Ltd,1990)

Compilation

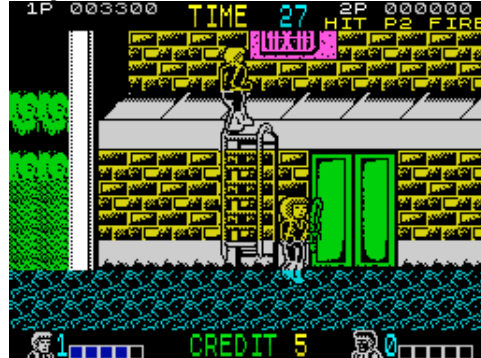

Editor (.)

Utility: Assembler/Disassembler/Monitor

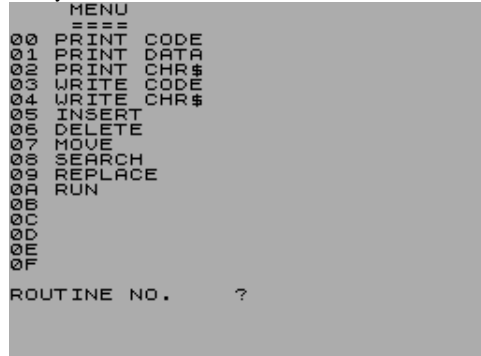

Eddie Edwards' Super Ski (Loriciels,1989)

Sport

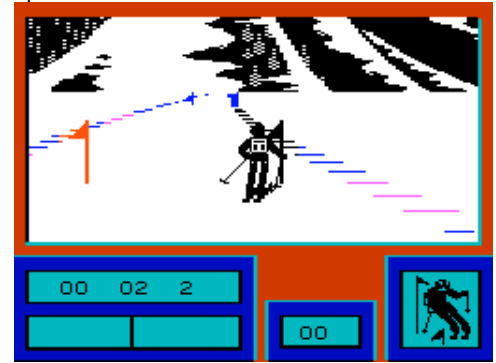

Edd the Duck Editor (Zeppelin Games Ltd,1990)

Arcade



Edisprites (Slowglass,)

Utility

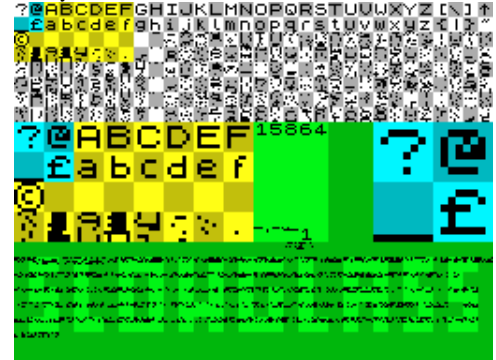

Edit-Link (Andy Schraepel,1992)

Utility: Assembler/Disassembler/Monitor

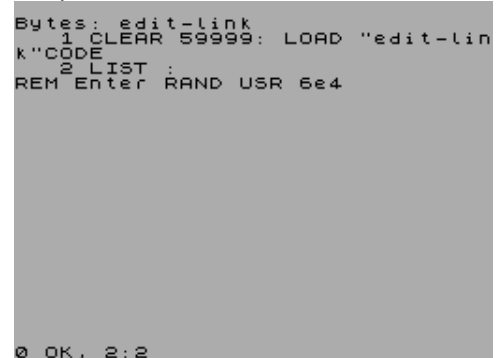

Editor/Assembler (Picturesque,1982)

Utility: Assembler/Disassembler/Monitor

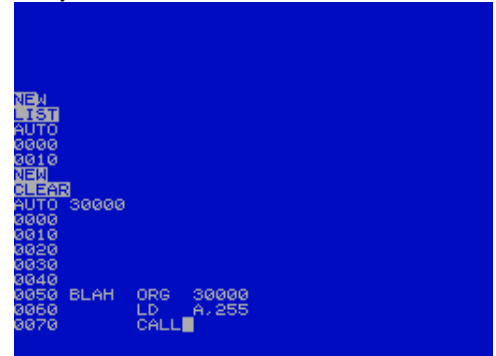

Editor BASIC (MicroHobby,1991)
Utility



Editor de Envolventes (MicroHobby,1991)
Utility: Music Creation



Editor de Sectores (MicroHobby,1991)
Utility



Edit Sampler (Proxima Software,1990)
Utility: Sound Manipulation



Educational Cassette 1 (Turtle Software,1985)
Educational



Editor Caratteri (Run,1986)
Utility: Font/UDGs



Editor de Linea (MicroHobby,1986)
Educational



Editor de Textos para Plus3 (MicroHobby,1991)
Utility

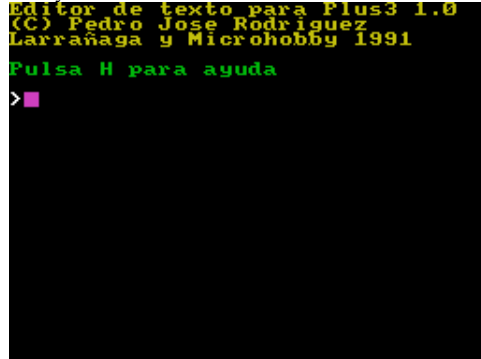

Ed-On (Add-On Electronics Ltd,1983)
Arcade



Education Compendium (Orwin Software,1984)
Educational



Editor de Caracteres (MicroHobby,1984)
Utility: Font/UDGs



Editor de Pantallas (MicroHobby,1986)
Utility



Editor G.D.U. (MicroHobby,1985)
Utility: Font/UDGs



Educate 3 (Simon Software,1984)
Educational

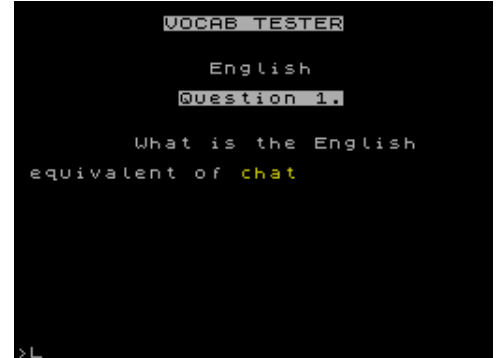

Education Tape for Infants and Juniors (M.B. Software.) Educational



Edytor Tekstu (.)
Utility: Word Processor
#05

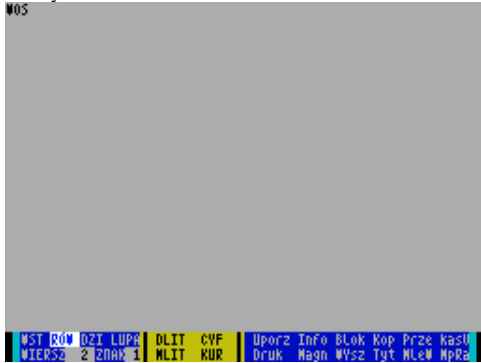

Egg Farm (Lasersound Ltd,1983)

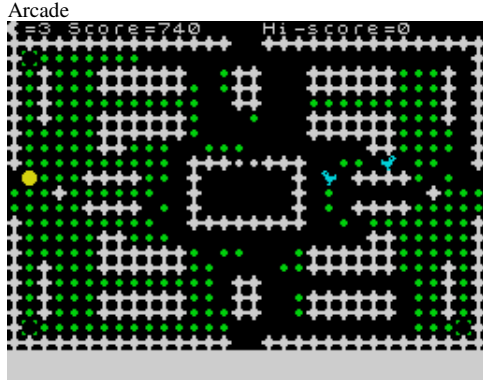

Egghead in Space (Cronosoft,2003)

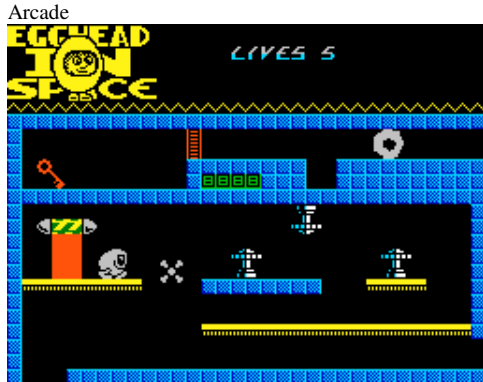

Egg Saver (Sinclair Programs,1984)



Egg, The (Automata UK Ltd,1985)

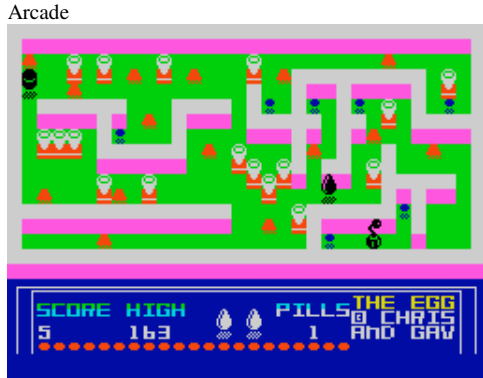

Efenders (Add-On Electronics Ltd,1983)
Arcade

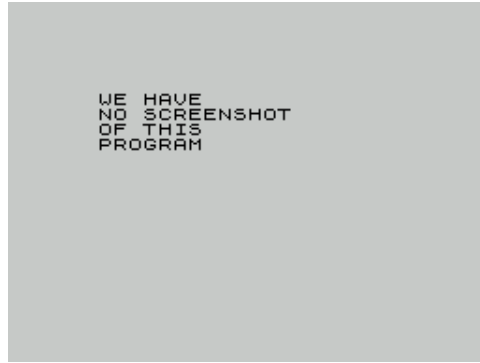

Egghead (Crash,1989)



Egghead to the Rescue (Crash,1990)

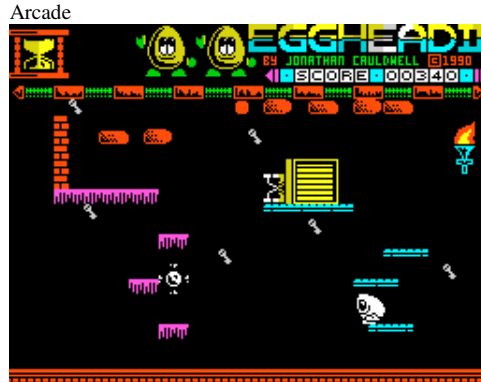

Egg Saviour (Virgin Books,1983)



Egyptian Pyramid (.)

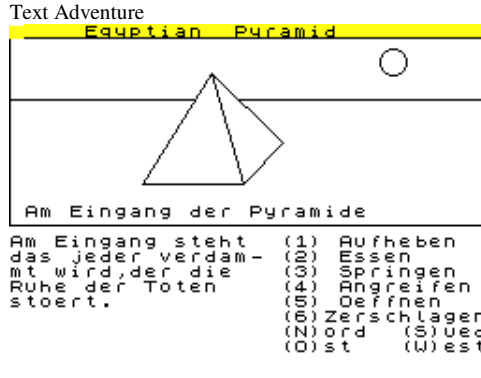

Egal (The Mad Guys,1993)
Scene Demo

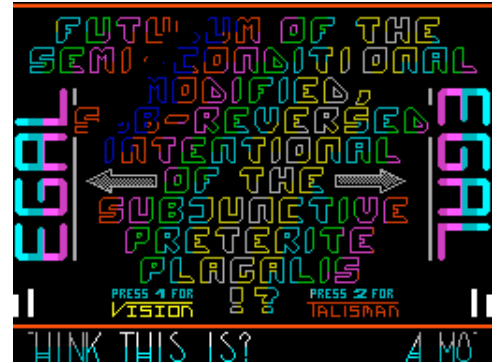

Egghead 4: Egghead Entertains (Jonathan Cauldwell,2006)



Eggo (Spectrum Computing,1986)

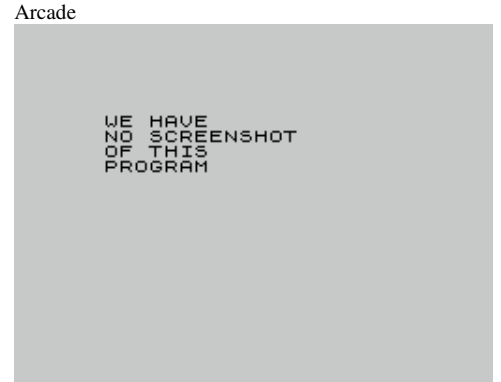

Eggscape (Disco List,)



Eidolon, The (Activision Inc,1986)



Eiffel Tower (Chalksoft Ltd,1983)
Educational

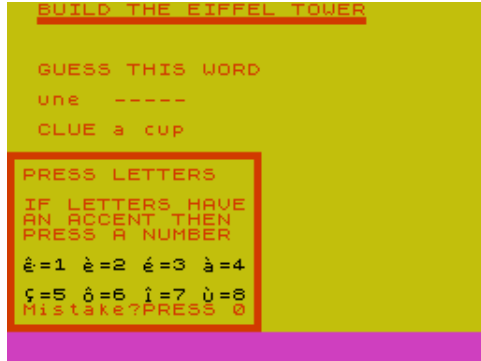

Ekranski Editor (Racunari,1986)
Utility: Word Processor



Election (Virgin Games Ltd,1987)
Arcade Adventure



Electric Office (Fisher Software,1985)
Utility



Electro Bingo (Sinclair User,1989)
Arcade

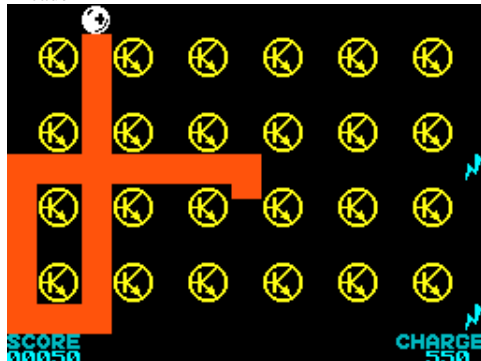

Eight Cards Patience (.)
Board/Card Game



Elecciones Generales (Juegos & Estrategia,1986)
Strategy



Election Trail (Braingames,1984)
Simulation

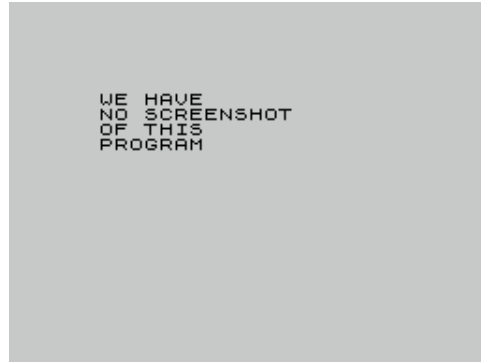

Electric Reindeer Maniacs (The Gasman,1996)
Scene Demo



Electro Bingo 2 (Sinclair User,1989)
Arcade

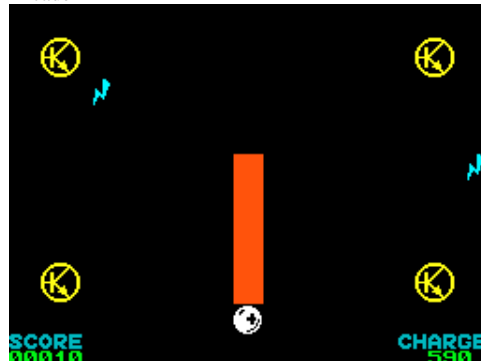

Eights (Atlantis Software Ltd,1985)
Board/Card Game

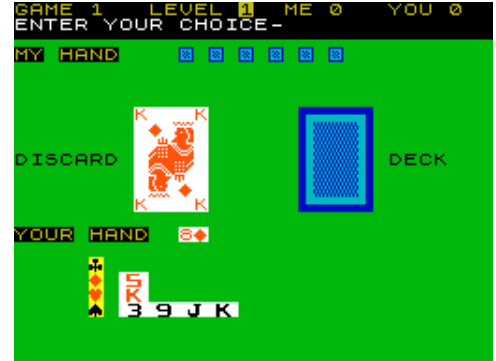

Election (Mastertronic Ltd,1984)
Simulation

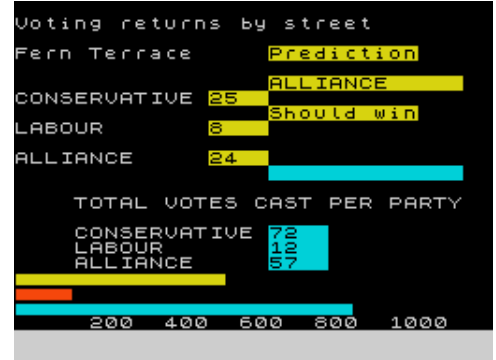

Electoral Suite Documentation (Radical Alternative Software,1992) Educational

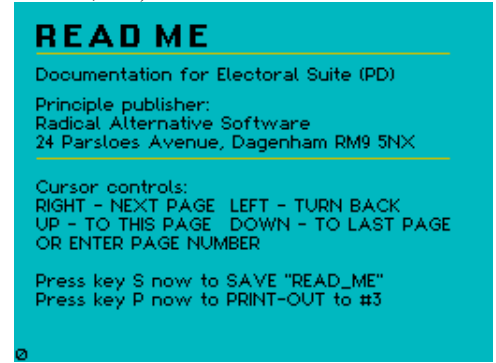

Electro (5D Software,1984)
Arcade

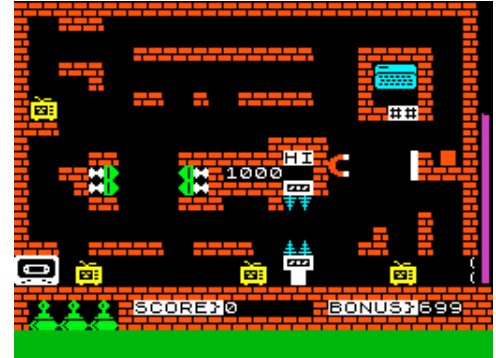

Electro Bingo 3 (Sinclair User,1989)
Arcade

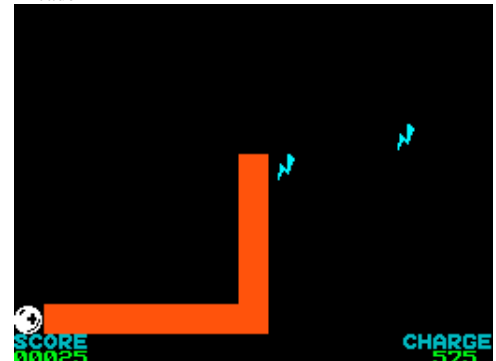

Electrocal (Ediciones y Textos S.A.,1985)
Utility: Electronics



Electronic Learners Guide (ETST Software,1984)
Educational



Electronics Kit (Westex Electronics,1987)
Educational

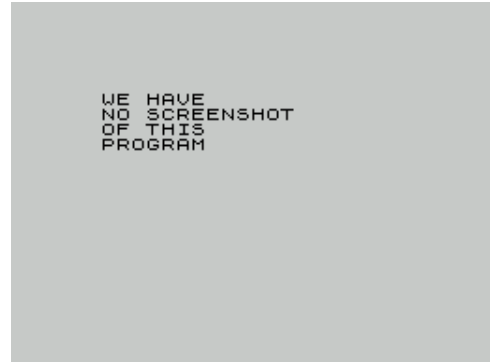

Elefants Graveyard (Silicon Software,1983)
Text Adventure



Elektra Glide (English Software,)
Arcade



Elektro Storm (PSS,1983)
Arcade



Elements (16/48 Tape Magazine,1984)
Educational



Elephant Polo (Argus Press Software Ltd,1986)
Arcade



Elevator (16/48 Tape Magazine,1984)
Arcade



Elevator (Black Knight Software,1985)
Strategy



Elevator Action (Quicksilva Ltd,1986)
Arcade



Elevator Boy (M.M.G.,1988)
Arcade

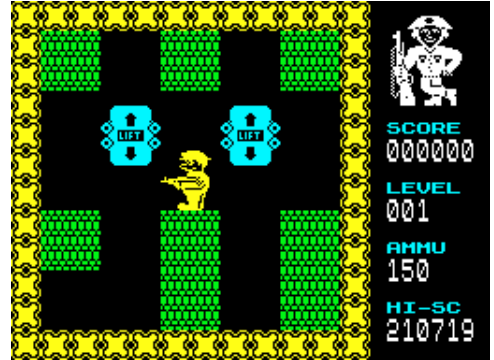

Eleventh Hour, The (Venturesoft,1986)
Text Adventure

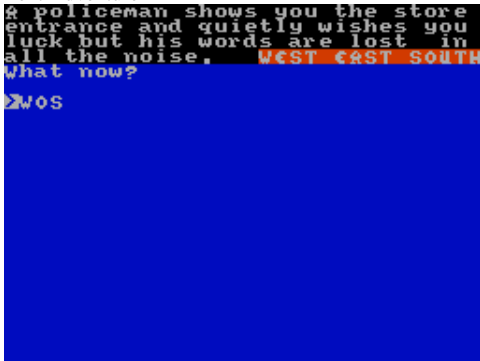

Elfindor (Zenobi Software,1990)
Text Adventure

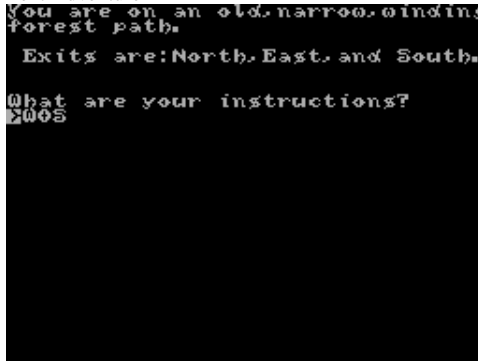

Elfin Wars, The (Zenobi Software,1994)
Text Adventure

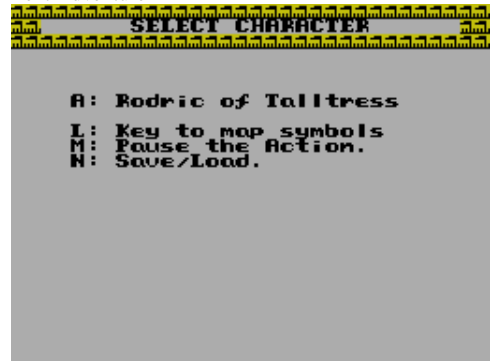

Elfos de Maroland, Los (Kame Soft,1993)
Text Adventure



Eliminator (Hewson Consultants Ltd,1988)
Arcade

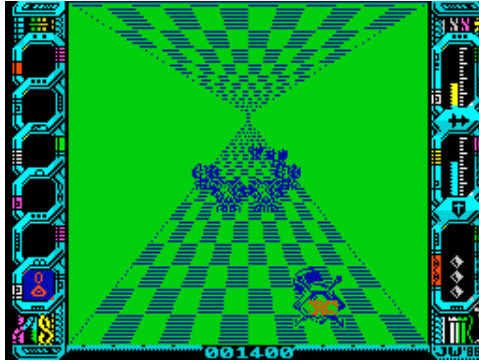

Elite 3 Novosibirsk (Shadow Soft,1992)
Strategy

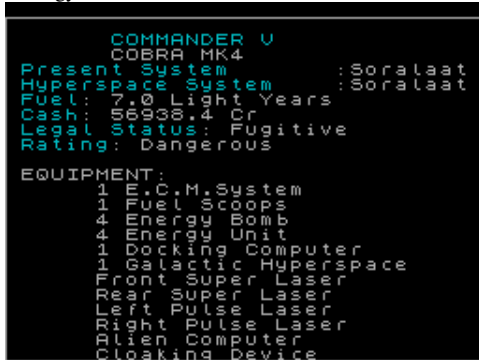

Elite Commander Editor (ACS Software,1986)
Cheat

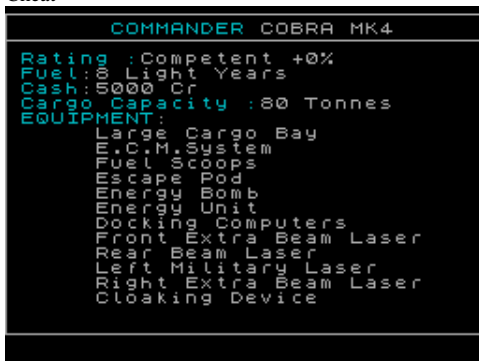

Elite Service (THD,1993)
Arcade Game Development Tool

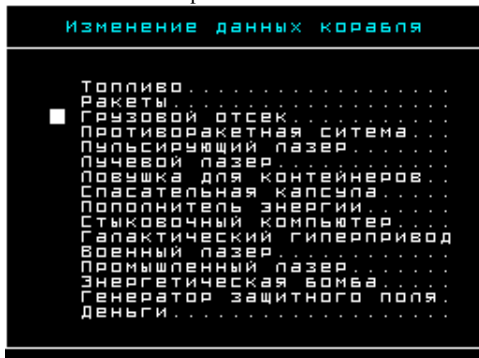

Elfquest (Chaosium,1984)
Board/Card Game

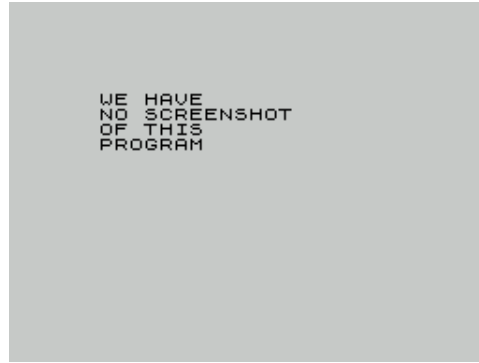

Elisa Analyst Program (Craigmount Computer Centre,1984)
Utility

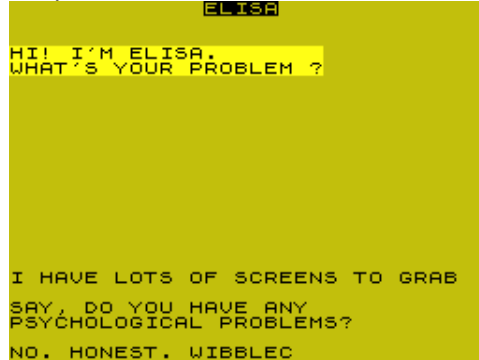

Elite Character Designer (Your Sinclair,1986)
Arcade Game Development Tool



Elite Editor (Data Design Systems,1984)
Utility



Elite Shipbuilder (Mark Alexander,1985)
Arcade Game Development Tool

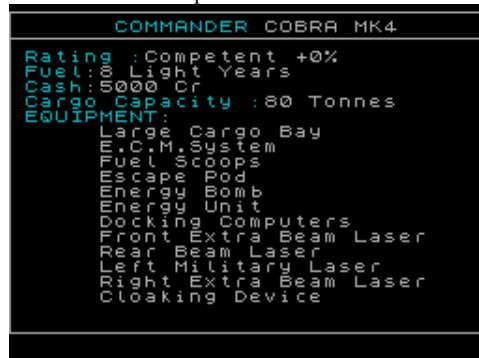

Eliminator (Alternative Software Ltd,1988)
Arcade

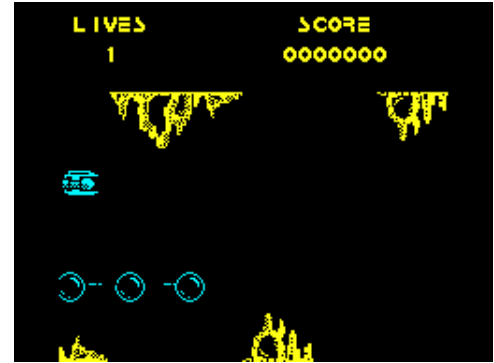

Elite (Firebird Software Ltd,1985)
Arcade

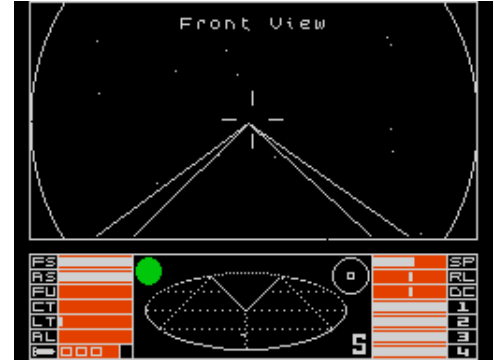

Elite Collection, The (Hit-Pak,1988)
Compilation

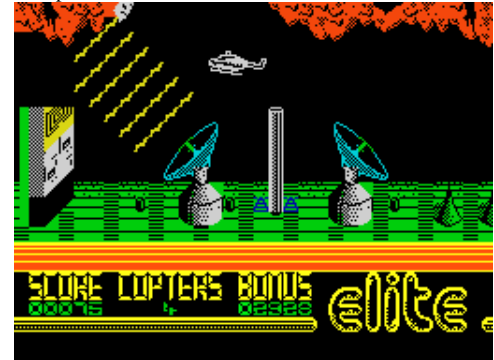

Elite III (THD,1993)
Strategy



Eliza (.)
Simulation

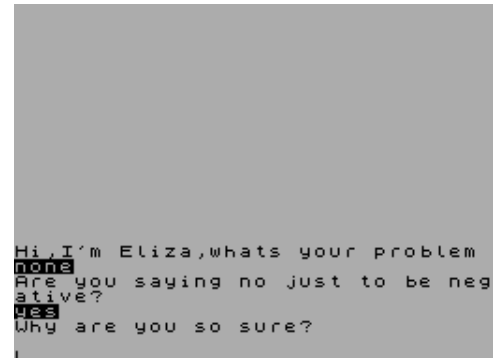

Elizabethan, The (Dee-Kay Systems,1986)
Simulation



El Mejor Spectrum issue ? (Grupo de Trabajo Software S.A.) Covertape



Elvin the Elf (ZXF,2006)
Arcade



Emerald Isle (Level 9 Computing Ltd,1985)
Text Adventure



Emilio Butragueno Futbol (Topo Soft,1987)
Sport



Ellak's Tomb (Spectrum Computing,1984)
Text Adventure



Elopement: Back to The Earth (Omega Hackers Group,1997)
Arcade Adventure

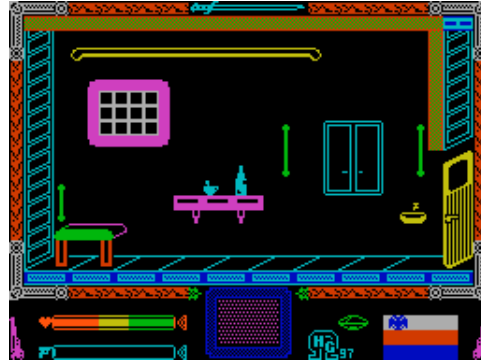

Embassy Assault (Sinclair Research Ltd,1982)
Arcade Adventure

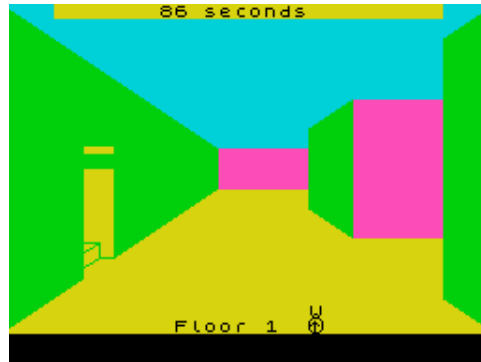

Emergency (Real Masters,1998)
Scene Demo



Emilio Sanchez Vicario Grand Slam (Zigurat Software,1990)
Sport

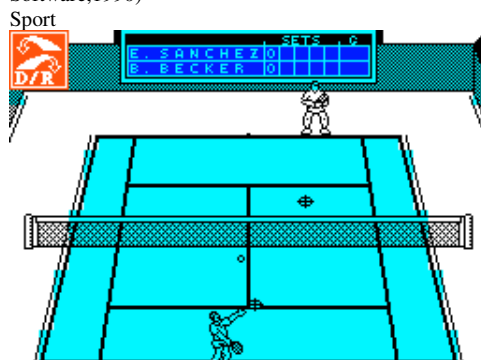

Ellisnore Diamond, The (River Software,1992)
Text Adventure

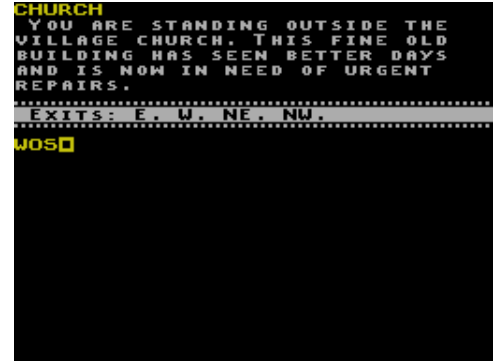

Elven Warrior (Players Premier Software,1989)
Arcade Adventure



Emerald Elf, The (Zenobi Software,1995)
Text Adventure



Emilio Butragueno 2 (Erbe Software S.A./Ocean Software Ltd,1989) Compilation



Emily's Tantrums (Sinclair Programs,1984)
Arcade

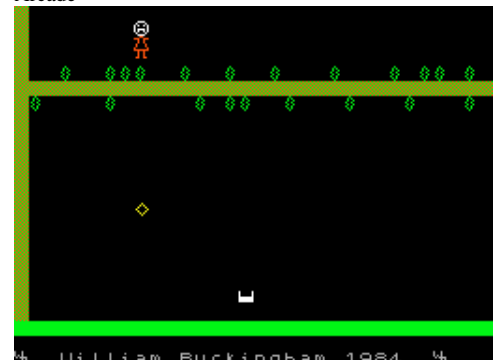

Emission / Recepcion Morse (Ventamatic,1984)
Utility

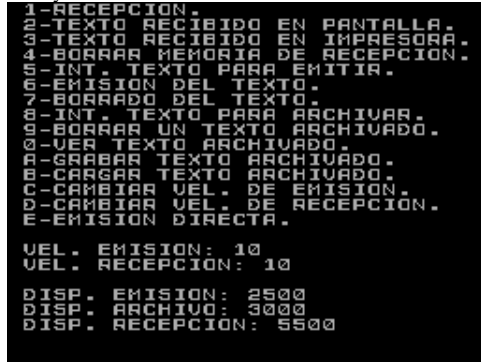

E-motion (US Gold Ltd,1990)

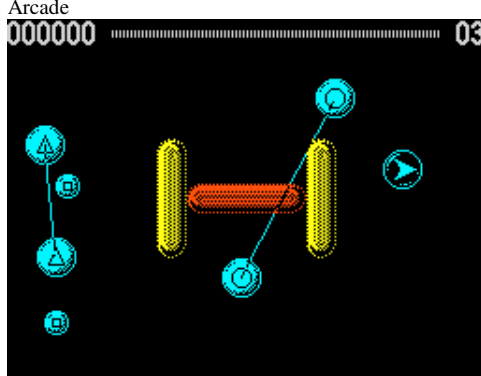

Empire (VV9,1998)
Strategy



Empires (Imperial Software,1984)
Strategy



EMR Miditrack Performer (Electro Music Research,1985)
Utility

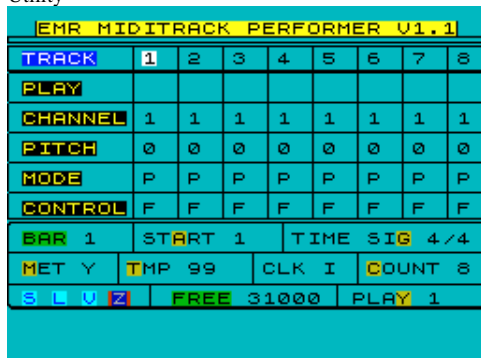

Emlyn Hughes Arcade Quiz (Audiogenic Software Ltd,1990)



Empareja 2 (Alberto Perez Torres.)
Board/Card Game

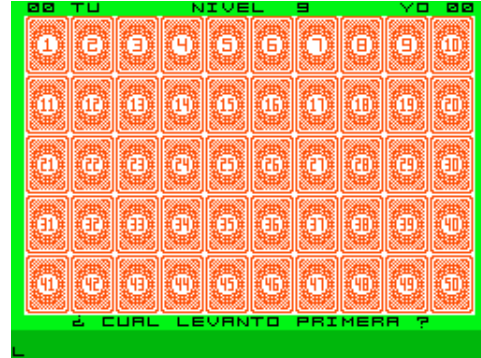

Empire Fights Back, The (Mastertronic Ltd,1985)
Arcade



Empire Strikes Back, The (Domark Ltd,1988)
Arcade



Emulate (Phantasy,1997)
Scene Demo



Emlyn Hughes International Soccer (Audiogenic Software Ltd,1989) Sport



Empire! (Firebird Software Ltd,1986)
Arcade



Empire of Karn (Interceptor Micros Software,1985)
Text Adventure



Empire, The (Virtual Vision,1997)
Strategy



En Busca de la Joya Encantada (Rockersuke Moroboshi,2006)

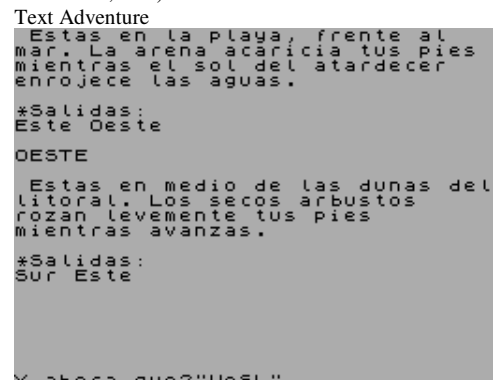

En Busca del Tesoro (MicroHobby,1985)
Arcade

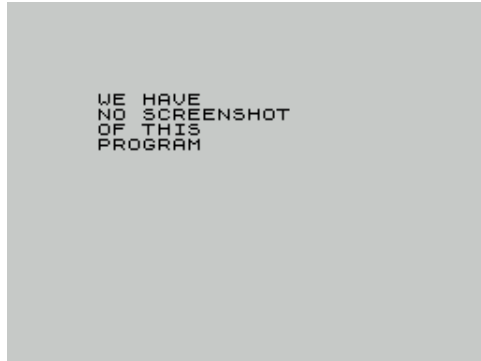

Enchanted Cottage, The + Jack and the Beanstalk (River Software,1987) Compilation

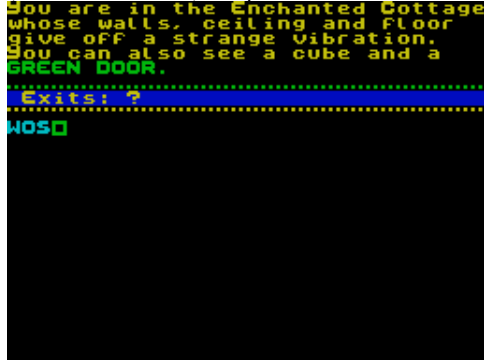

Encyclopedia of War: Ancient Battles (CCS,1989)
Strategy



Enduro (Activision Inc,1984)
Arcade



Endzone (Sport-Sim,1991)
Simulation

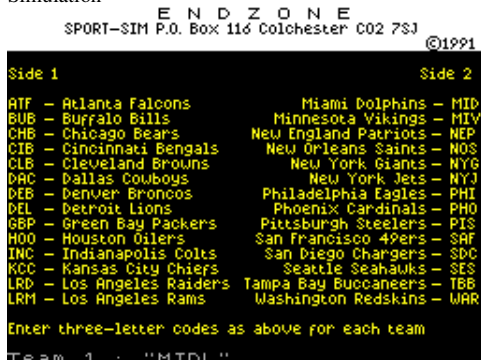

Enchanted (Positive,1989)
Board/Card Game

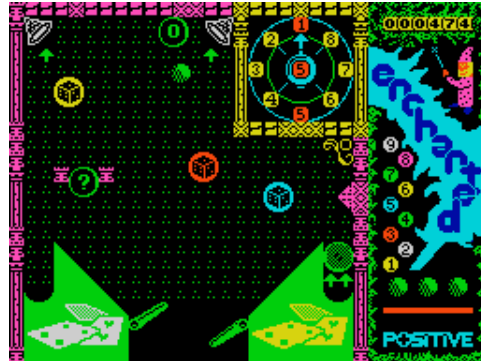

Enchantress (CRL Group PLC.)
Text Adventure



End Is Nigh, The (Zenobi Software,1994)
Text Adventure



Enduro Racer (Activision Inc,1987)
Arcade



Endzone - 87f Rosters (Sport-Sim,1987)
Simulation



Enchanted Cottage, The (River Software,1988)
Text Adventure

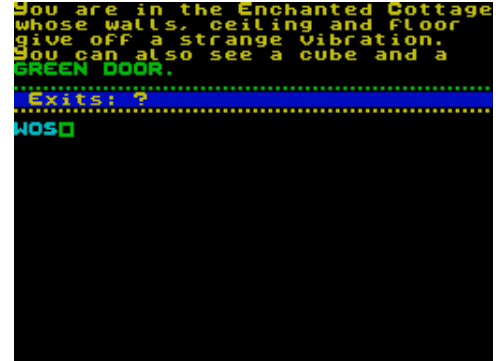

Encounter (Seyern Software,1983)
Text Adventure

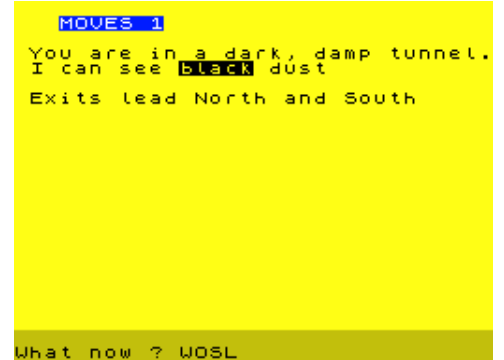

Endurance (CRL Group PLC,1985)
Arcade



End Zone (Alternative Software Ltd,1989)
Simulation

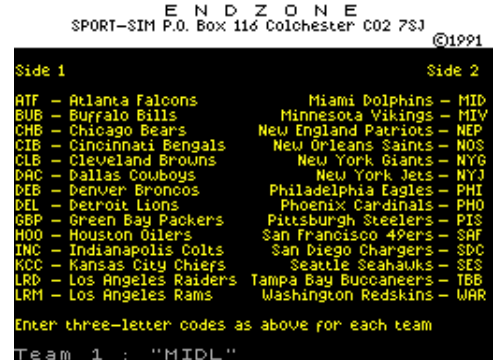

Endzone - 88e Program (Sport-Sim,1988)
Simulation



Endzone - 88e Rosters (Sport-Sim,1988)
Simulation

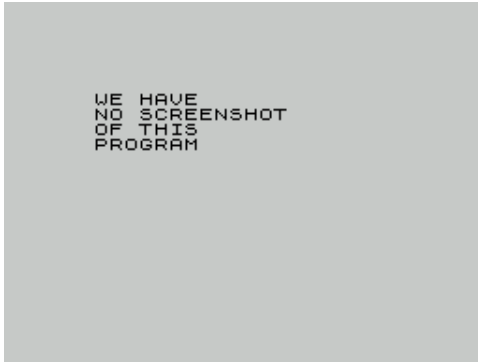

Endzone - 89e Rosters (Sport-Sim,1989)
Simulation



Endzone - 90f Program (Sport-Sim,1990)
Simulation



Endzone - 90f Rosters (Sport-Sim,1990)
Simulation



Enemies (Cascade Games Ltd.)
Arcade



Energem Enigma, The (Precision Games,1987)
Text Adventure



Energy 30,000 (Elm Computers,1984)
Arcade

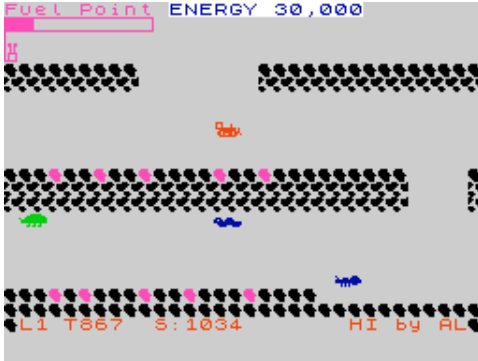

Energy Warrior (Mastertronic Ltd,1987)
Arcade



Energy Warrior + Molecule Man (Mastertronic Added Dimension,1987) Compilation



Engendro (Jorge Duran Ponsa,1989)
Text Adventure



Engine (Roelof Koning,1989)
Scene Demo

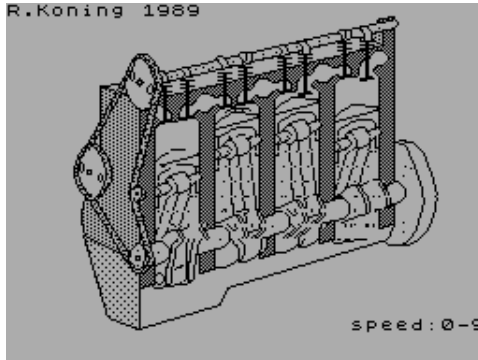

Engineer Humpty (Artic Computing Ltd,1984)
Arcade



Engines (Arnold Wheaton Software,1984)
Educational

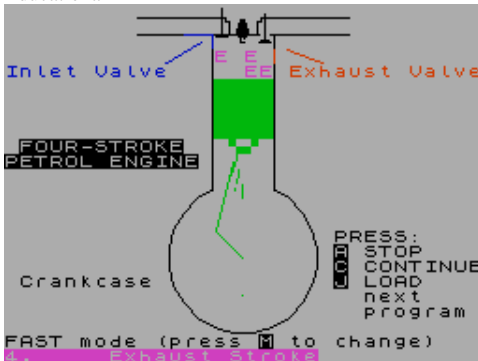

England-Adventure (Jujstronic,1984)
Text Adventure

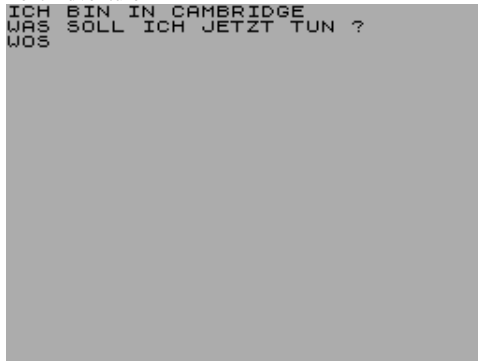

Engleski Jezik 2 (Zavod za Udzbenike/Nastavna Sreds.,1986)
Educational

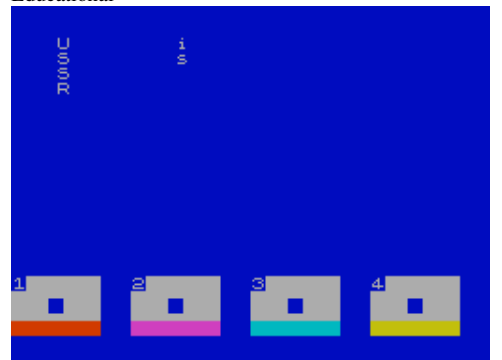

English (.)
Educational

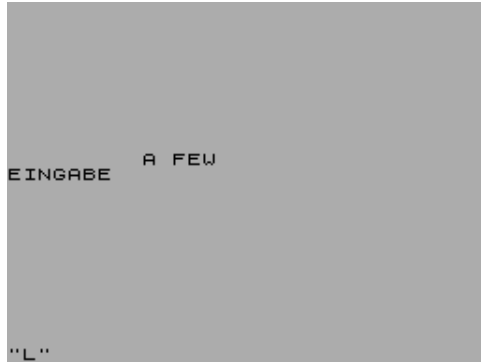

English Literature 1 (Sinclair Research Ltd,1982)
Educational

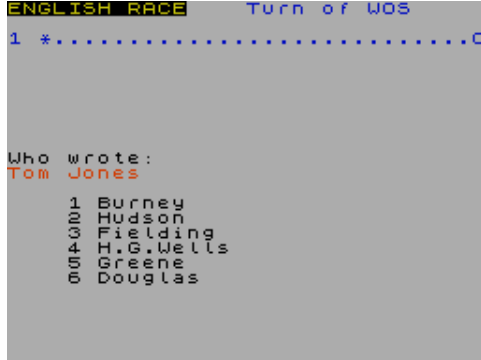

English Verbs (Softhouse Ltd,1994)
Educational

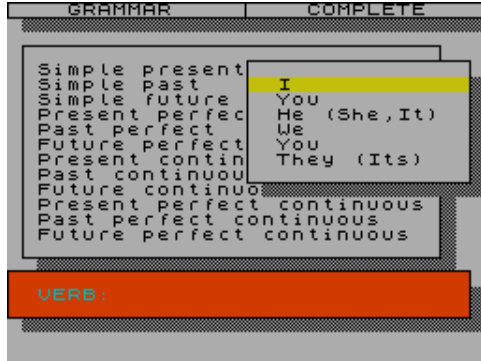

Enigma (Dealer Deals Ltd,1984)
Board/Card Game



Enigma Tape Magazine issue 8 (Enigma Software Developments,1991) Covertape

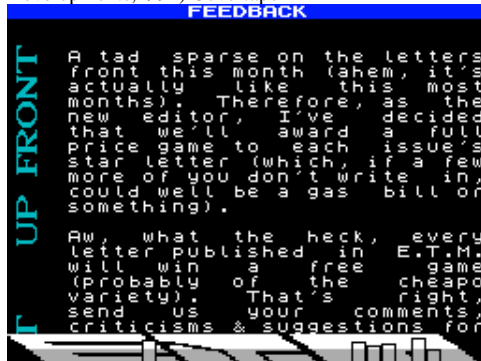

English Language Tutors (Options International,1986)
Educational

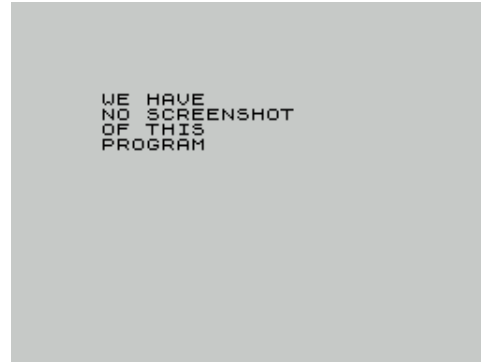

Englishskills I (Griffin Software,1984)
Educational

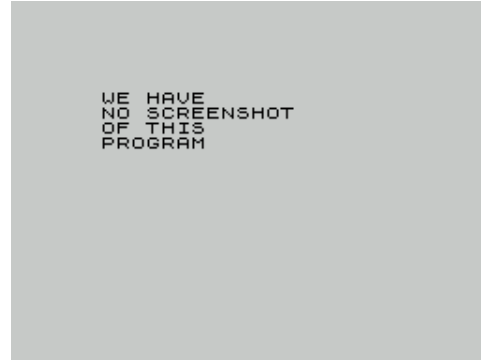

EnigEd (Enigma Software Developments,1990)
Utility: Word Processor



Enigma (Work Force,1983)
Arcade



Enigma Tape Magazine issue 9 (Enigma Software Developments,1991) Covertape

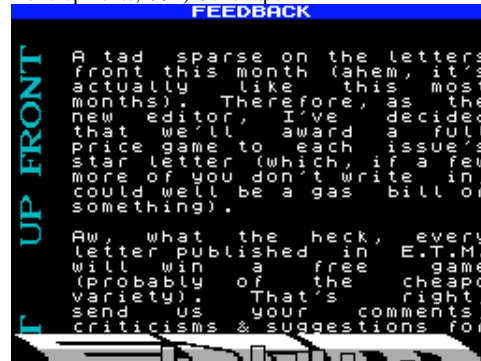

English Literature (Charles Letts & Co,1985)
Educational

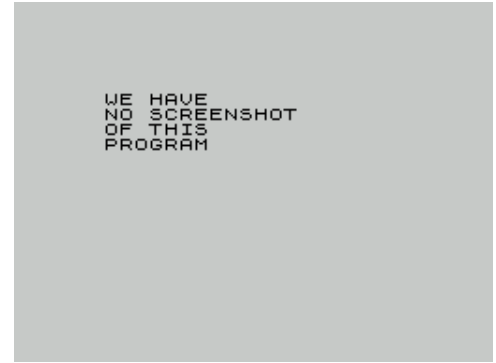

Englishskills II (Griffin Software,1984)
Educational

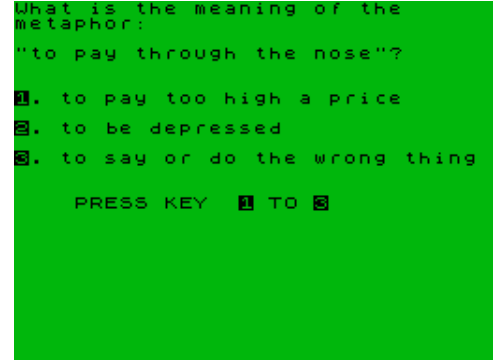

Enigma (Brainbox Software,1984)
Board/Card Game



Enigma Force (Beyond Software,1985)
Arcade



Enigmatico (MicroHobby,1985)
Utility

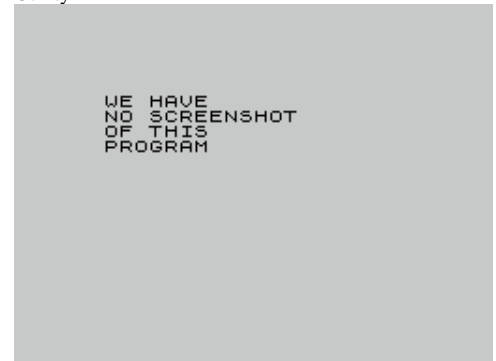

Enigma Variations (.)
Educational
1?0

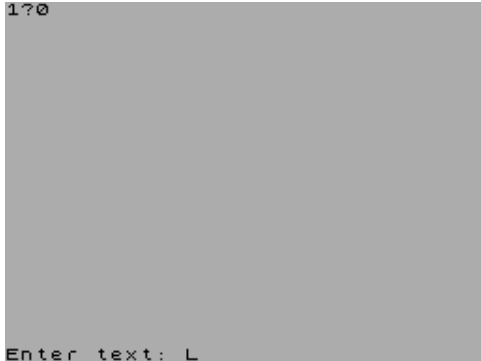

Enter text: L
Enjoy with PC-system (Bromba,1989)
Scene Demo

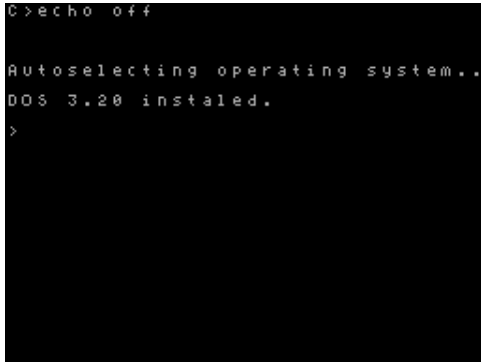

Ensamblador para Plus3 (MicroHobby,1991)

Utility: Assembler/Disassembler/Monitor
Ensamblador para Plus3 1.0
(C) Pedro Jose Rodriguez
Larrañaga y Microhobby 1991
Pulsa H para ayuda

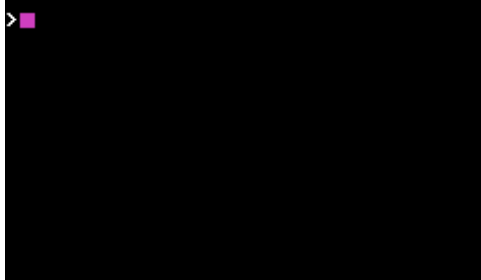

Enterprise (Melbourne House,1987)

Arcade



Enter Spectrum issue 03 (Software Editores,)

Covertape



Enima (Vaxalon,1995)
Utility
XWN

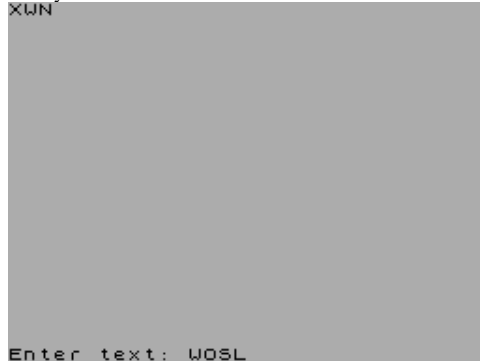

Enter text: WOSL
Enlight '96 Graphix (Hacker Chris,1996)
Scene Demo



Enter at Your Own Risk (Teenware,1988)

Text Adventure

You are beside the cottage.
There is a picture window in the
featureless wall. Dense thicket
lies west, paths lead north and
south.

What now?
\$WOSL

Enter Spectrum issue 01 (Software Editores,)

Covertape



Enter Spectrum issue 04 (Software Editores,)

Covertape



Enjoy Maths (Silverlind Ltd,1983)
Educational



Press ENTER to finish each sum.
Enormous Turnip, The (Arrow,1984)
Educational



Enterprise (.)

Arcade



Enter Spectrum issue 02 (Software Editores,)

Covertape



Enter Spectrum issue 05 (Software Editores,)

Covertape



Enter Spectrum issue 06 (Software Editores,)
Covertape



Enter Spectrum issue 07 (Software Editores,)
Covertape

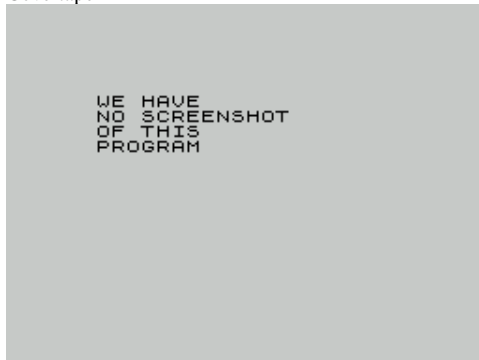

Enter Spectrum issue 08 (Software Editores,)
Covertape



Enter Spectrum issue 09 (Software Editores,)
Covertape



Enter Spectrum issue 10 (Software Editores,)
Covertape



Enter Spectrum issue 11 (Software Editores,)
Covertape



Enter Spectrum issue 12 (Software Editores,)
Covertape



Enter Spectrum issue 13 (Software Editores,1986)
Covertape



Enter Spectrum issue 14 (Software Editores,1986)
Covertape



Entre Comillas (M.G. Medina,)
Board/Card Game



Entrepreneur (Collins Educational,1985)
Utility



Entropy (ZX Maniacs,1998)
Scene Demo



Envelope, The (Yodasoft,1984)
Text Adventure

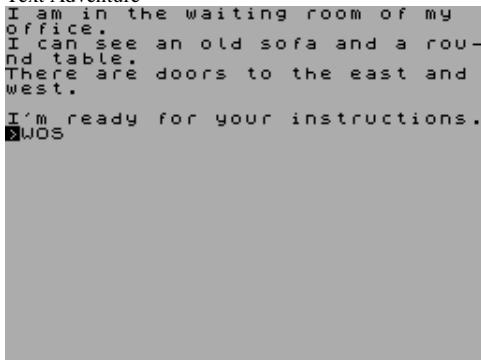

Ephemeris (Bridge Software,1982)
Utility



Epidemic (Disco List,)
Arcade



EPROM Operating System (Sinclair Research Ltd,1985)

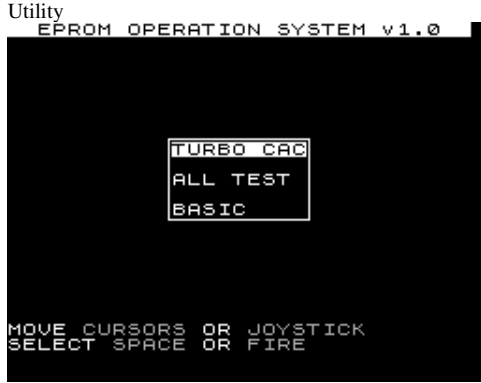

EPROM Programmer (G. Windt Opusdisk,1988) Utility

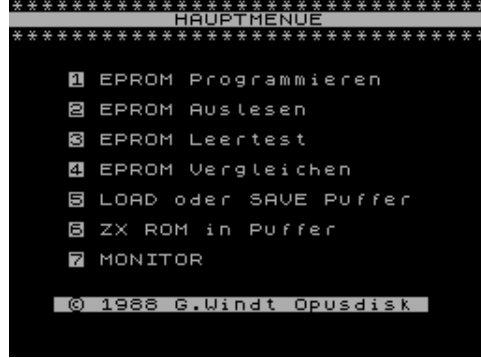

Epsilon (Grupo de Trabajo Software S.A.,1987) Arcade

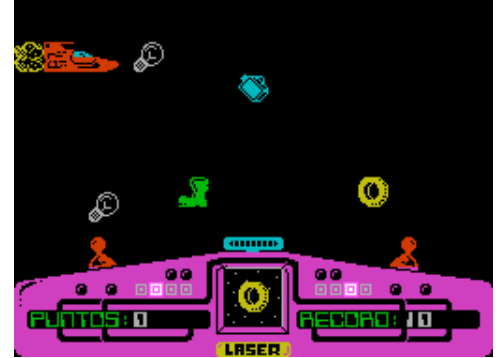

Epson IIs (Miodrag Stancevic,1997) Utility: Word Processor

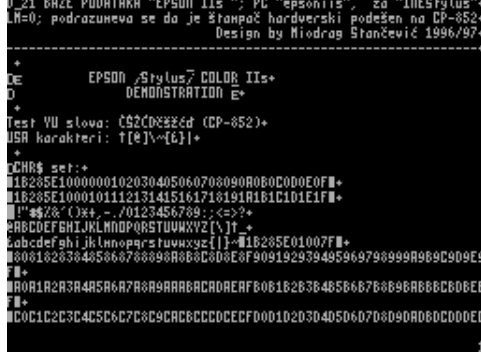

Epyx 21 (US Gold Ltd,1990) Compilation

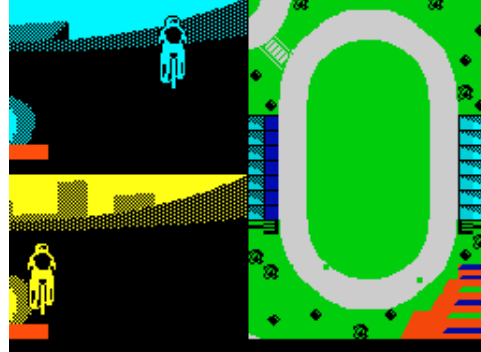

Epyx Action (US Gold Ltd,1990) Compilation

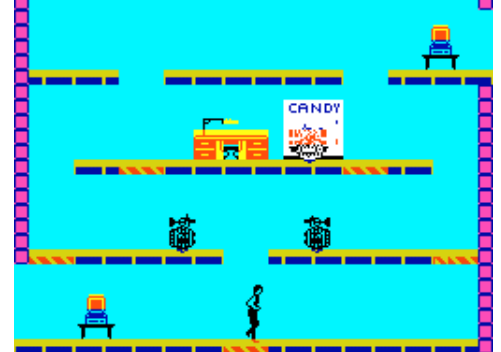

Equinox (Mikro-Gen Ltd,1986) Arcade



Era of Enchantment (Sacred Scroll Software,1988) Text Adventure



Erbe 88 (Erbe Software S.A.,1988) Compilation

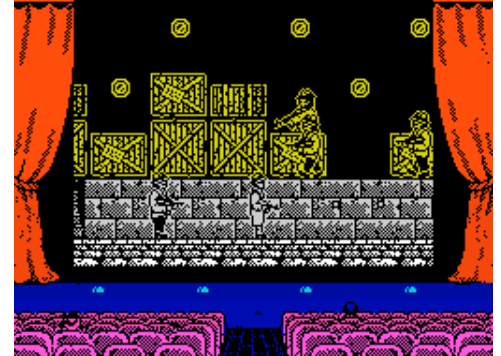

Eric and the Floaters (Sinclair Research Ltd,1984) Arcade

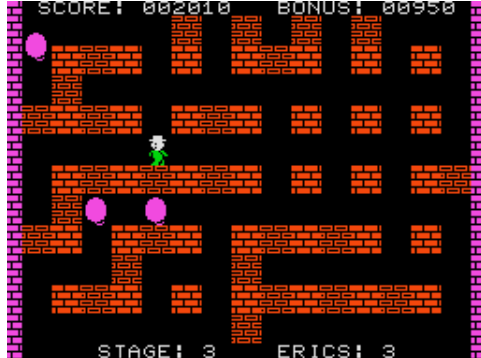

Eric Bristow's Pro-Darts (Quicksilva Ltd,1984) Sport

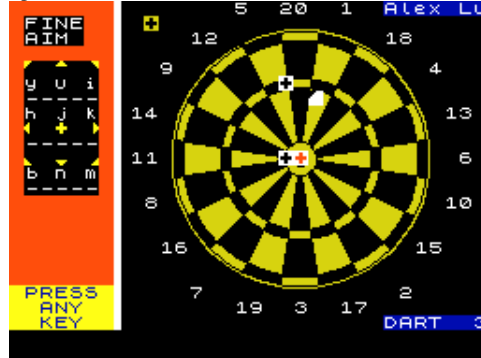

Erik: the Phantom of the Opera (Crysis,1987) Arcade Adventure



Erklärung (Omikron Software [1],1986) Utility



Ervaders (IEC Software,1986) Educational



Escalador Loco (Ventamatic,1983) Arcade

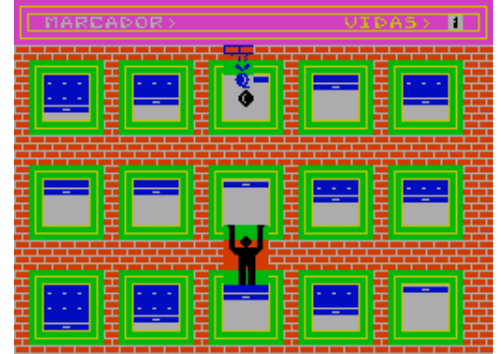

Escaldo (Mark Hallam,) Board/Card Game

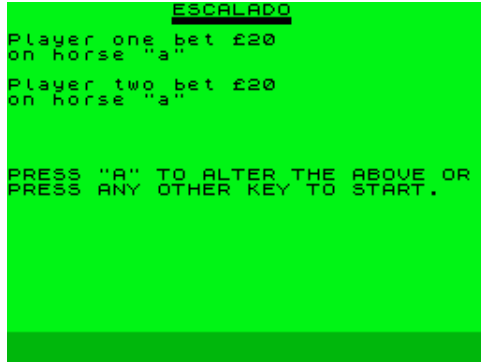

Escape (New Generation Software,1982) Arcade



Escape (Tartan Software,1987) Text Adventure

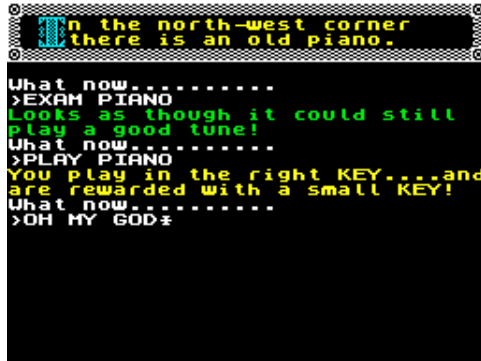

Escape from Colditz (Martin Malley,1982) Text Adventure

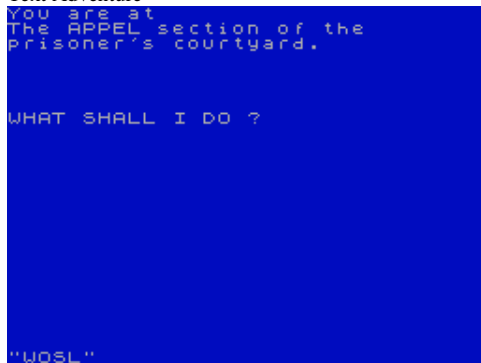

Escape from Hodgkin's Manor (Zenobi Software,1990) Text Adventure

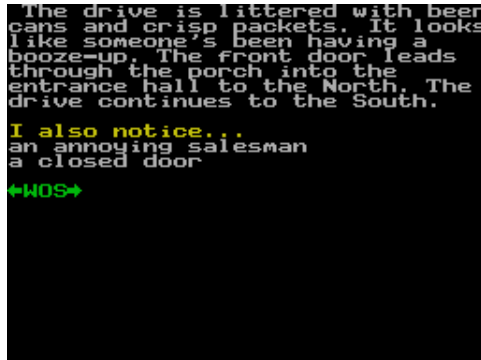

Escape (16/48 Tape Magazine,1984) Arcade

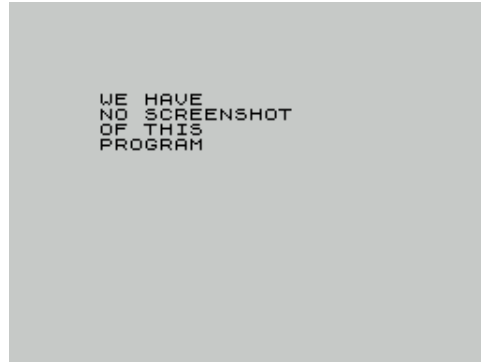

Escape (Sinclair Research Ltd,1982) Arcade



Escape from Alcatraz (Stack Computer Services Ltd,1983) Arcade



Escape from Devil's Island (Central Solutions,1986) Text Adventure

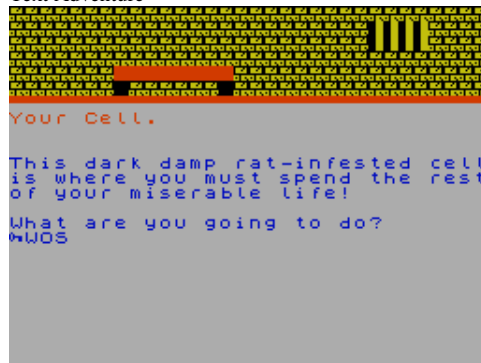

Escape from Khoshima (Atlantis Software Ltd,1988) Text Adventure

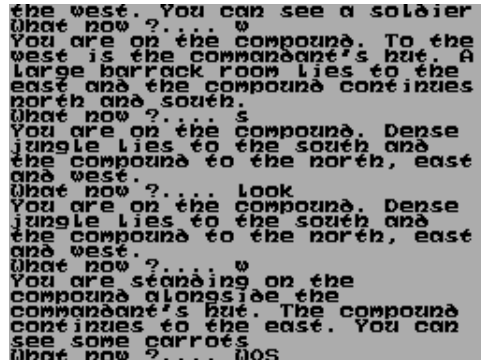

Escape (A. Price,1992) Arcade

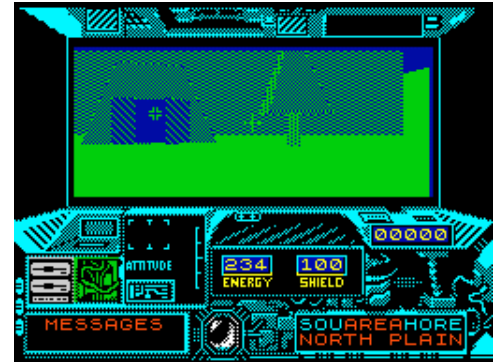

Escape! (Spectrum Computing,1984) Arcade



Escape from Castle (Jioi Chabek,1988) Text Adventure

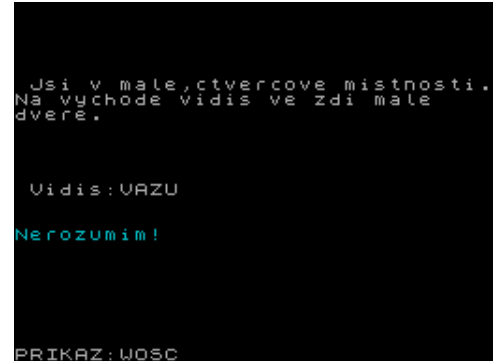

Escape from Devils Island + Barchou (Central Solutions,1986) Compilation

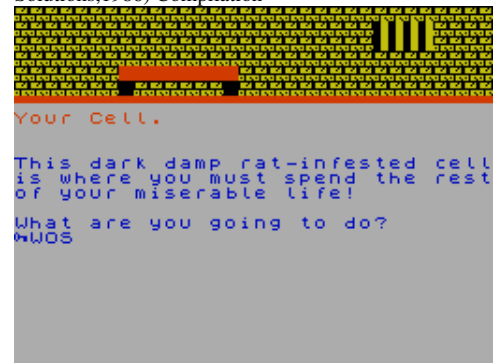

Escape from Magic (Eric Stewart,) Text Adventure

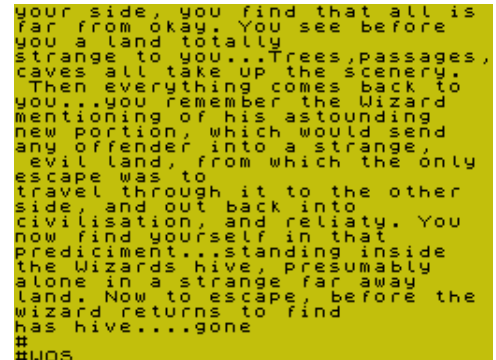

Escape from Malagar (.)

Text Adventure

I am on the road to the tower, around it I can now see a kind of complex of buildings all joined by corridors. Exits north and south.

Tell me what to do.
>WOS

Escape from Pulsar 7 (Digital Fantasia,1983)

Text Adventure



Escape from the Planet of the Robot Monsters (Domark Ltd,1990) Arcade Adventure



Escape from Time (.)

Text Adventure

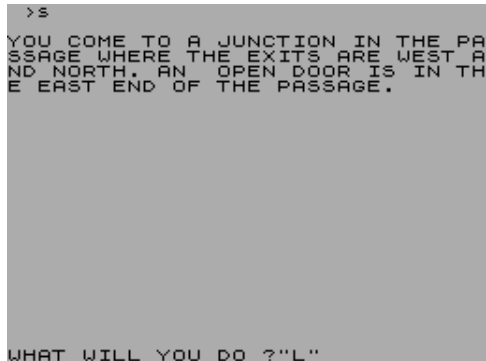

Escaping Habit, The (Zenobi Software,1992)

Text Adventure

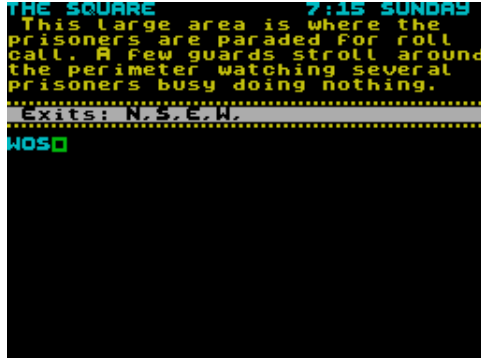

Escape from Omicron (Video Showcase,1984)

Arcade

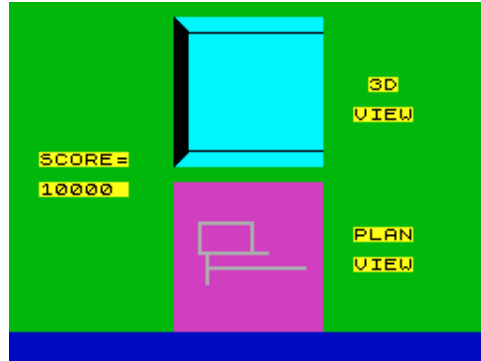

Escape from Stalag 13 (AGS,1985)

Text Adventure



Escape from the Shire (D.N.D. Software,)

Text Adventure



Escape into Space (Kelsoft,1987)

Text Adventure

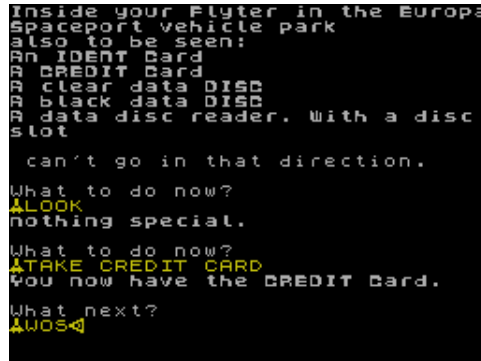

Escoba Espacial, La (MicroHobby,1985)

Arcade



Escape from Prison Planet (Peter Clark,1994)

Text Adventure



Escape from Sylon 6 (King Software,1984)

Text Adventure

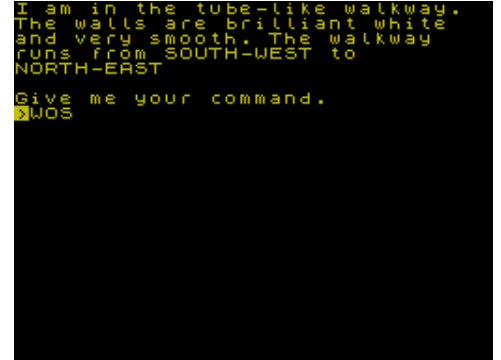

Escape from the Underworld (Temptation Software,1984)

Arcade



Escape-MCP (Rabbit Software Ltd,1983)

Arcade



Escoba, La (MicroHobby,1985)

Arcade



Escudo (Microparadise Software,1984)
Arcade

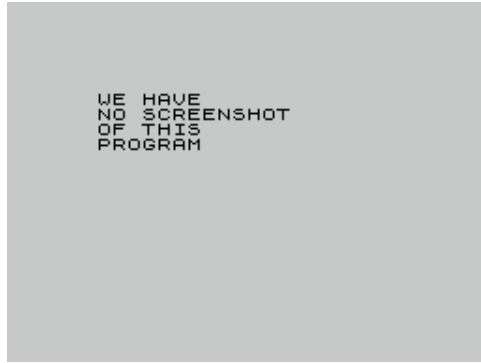

Eskimo Eddie (Ocean Software Ltd,1984)
Arcade

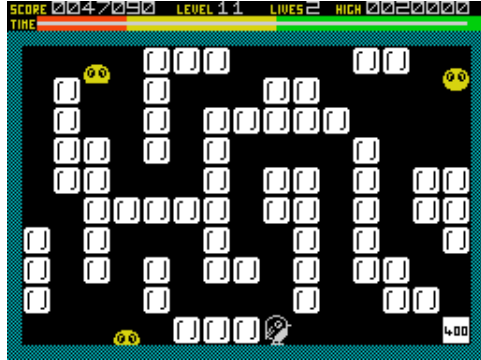

E-S-P (Sinclair Programs,1983)
Utility: BASIC Related

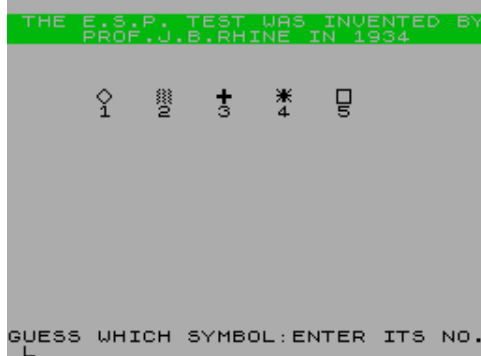

Espectrografo de Sonidos (MicroHobby,1986)
Utility

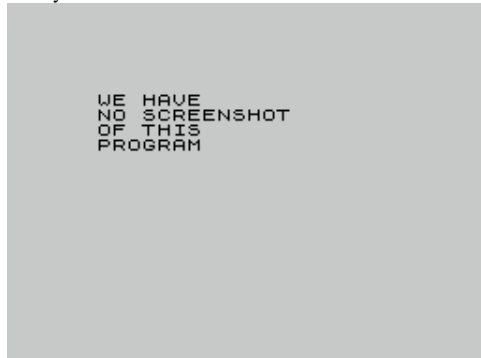

Espia (Investronica S.A.,1984)
Board/Card Game

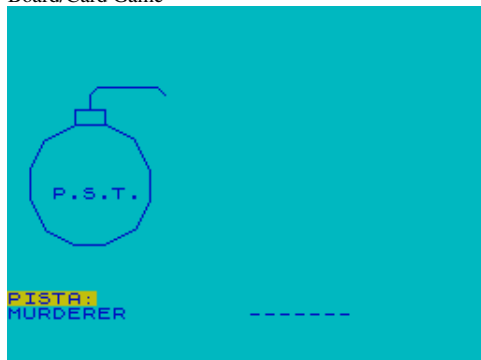

ESI Demo (ESI.)
Scene Demo



Es la Guerra! (MicroHobby,1985)
Arcade

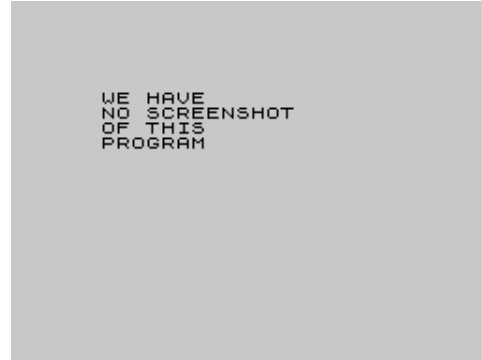

Espacio Maligno, El (Daniel Perez Espinosa,1989)
Text Adventure



Espejos (Pedro Jose Rodriguez/Raul Lopez,1989)
Text Adventure



Espia + Platero (Investronica S.A.,1984)
Compilation

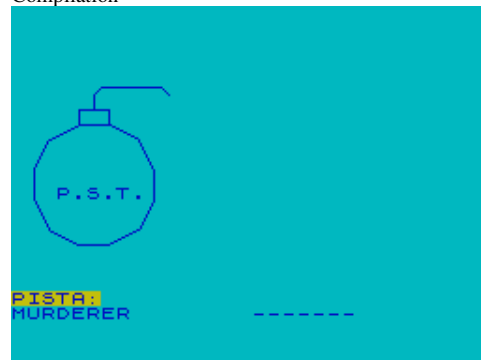

Eskimo Capers (Power Software,1984)
Arcade



E.S.P. (Convention/Extacy-3,1995)
Scene Demo



Espada Sagrada, La (Topo Soft,1990)
Arcade Adventure

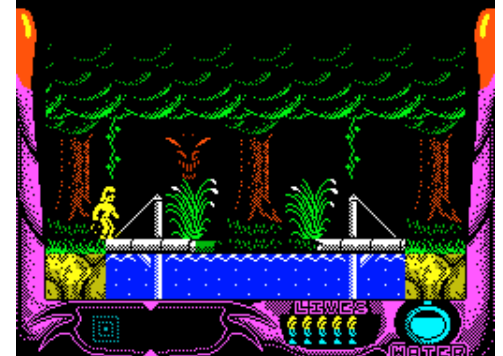

Espersoft (Samir Ribic,1988)
Educational



Espia, La (MicroHobby,1985)
Utility



Espionage (Grandslam Entertainments Ltd,1988)
Board/Card Game

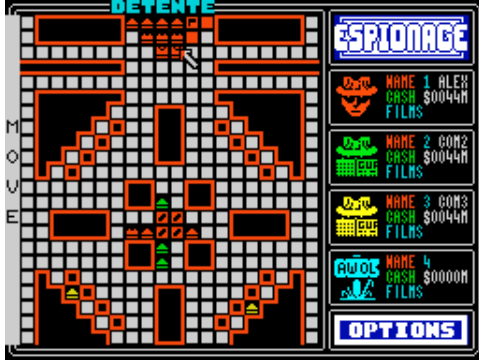

Estacion Acuario (Luis Sanchez Palacios,1992)
Text Adventure



Estadistica (Investronica S.A.,1985)
Utility

PULSE \square

x_i	n_i	N_i	f_i	F_i
x_1	n_1	N_1	f_1	F_1
x_2	n_2	N_2	f_2	F_2
.
.
x_n	n_n	N_n	f_n	F_n
tot.	n		1	

Estadistica Escolar [1] (MicroHobby,1986)
Arcade



Estrellas y Constelaciones (Ediciones y Textos S.A.,1985)
Educational



Espionage (Modular Resources Ltd,1984)
Strategy

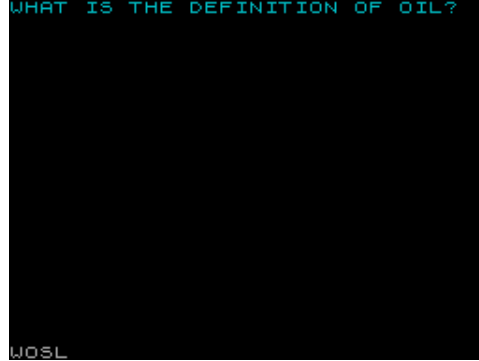

Estacion, La (Imperator,1990)
Text Adventure

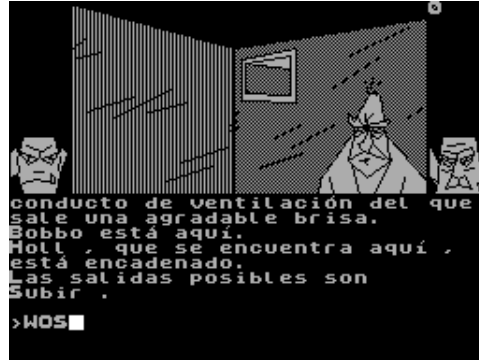

Estadistica (MicroHobby,1984)
Utility: Mathematics



Estadistica Escolar [2] (MicroHobby,1985)
Utility: Mathematics



Estructuras de Hormigon (Paraninfo Soft S.A.,)
Utility



Esqueleto Humano, El (MicroHobby,1986)
Educational

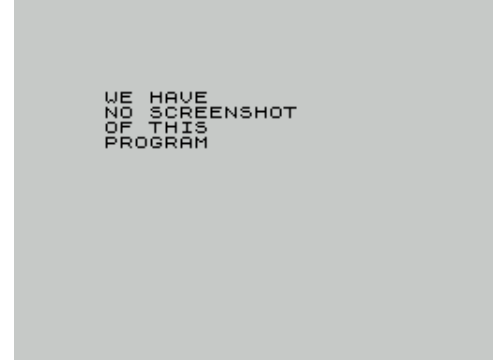

Estacion Loca (MicroHobby,1986)
Arcade



Estadistica: Regresion Lineal (J.A. Lajarin Software,1984)
Educational

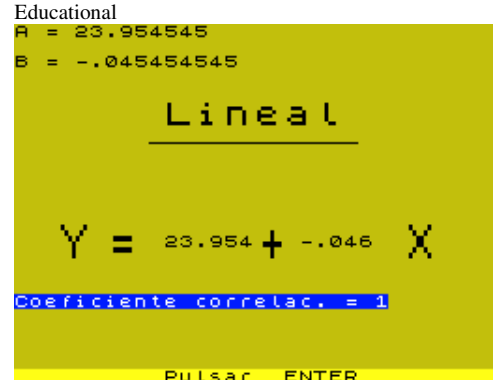

Estimator Racer (Sinclair Research Ltd,1984)
Educational



Estructuras Metalicas (Paraninfo Soft S.A.,)
Utility

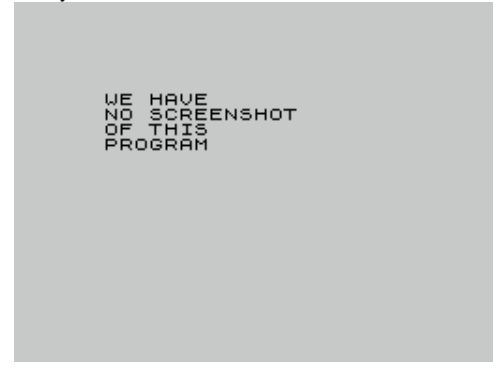

E-SWAT (US Gold Ltd,1990)

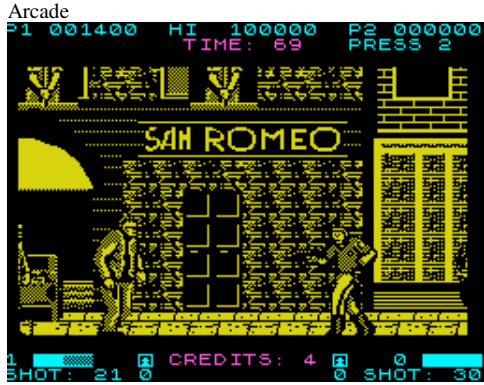

Eteor Torn (Add-On Electronics Ltd,1983)



E.T.X. (Abbex Electronics,1983)



Eureka! (Domark Ltd,1984)

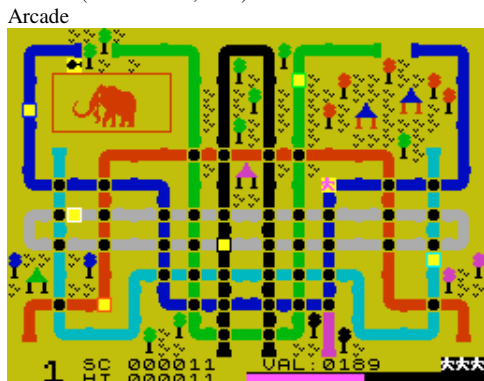

Euro Football Champ (Domark Ltd.)



E.T. (Macronics Systems Ltd,1983)

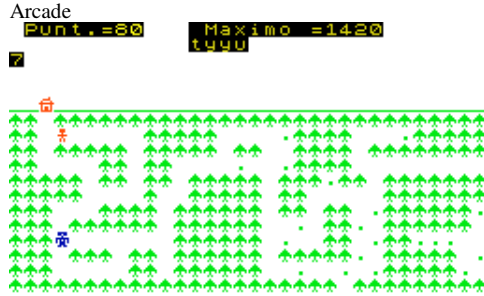

Ethnipod (Your Sinclair,1991)

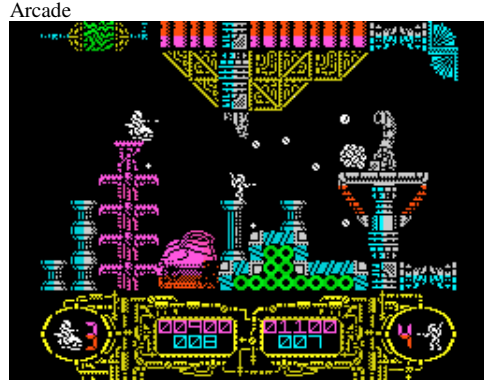

Euchre (Copyright Control,1985)



Euro Boss (Challenge Software,1991)



Europa (Argus Press Software Ltd,1985)



ETa (Automata UK Ltd,1982)

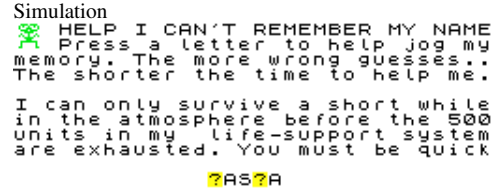

There is no "E" in my name. I only have 495 units left.

Etiuda (Krakow,1986)

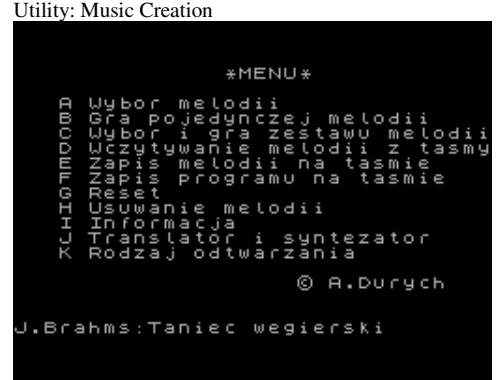

Eunuch's Ball, The (The Adventure Workshop,1995)



Eurodroid (16/48 Tape Magazine,1984)



Europe (Argus Press Software Ltd,1985)



European Champions (E&J Software,1990)
Simulation



European Soccer Challenge (Players Software,1990)
Sport

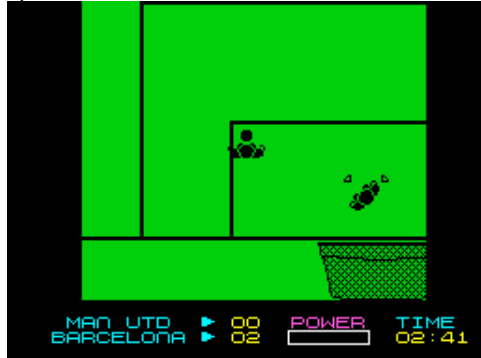

Europol (Reistel,1984)
Arcade



Evening Star (Hewson Consultants Ltd,1987)
Simulation



Everton F.C. Intelligensia (Amfas Computer Software Ltd.) Sport



European Five-a-Side (Silverbird Software Ltd,1988)
Sport



European Superleague (CDS Microsystems,1991)
Simulation



Evaristo el Punky (SPE,1988)
Arcade Adventure

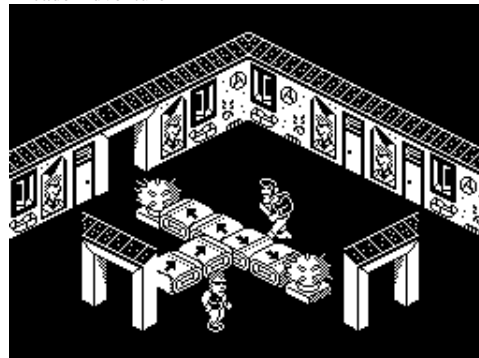

Even Yet Another Big Disk (Zenobi Software,1991)
Compilation



Everyday Tale of a Seeker of Gold, An (Zenobi Software,1986) Text Adventure

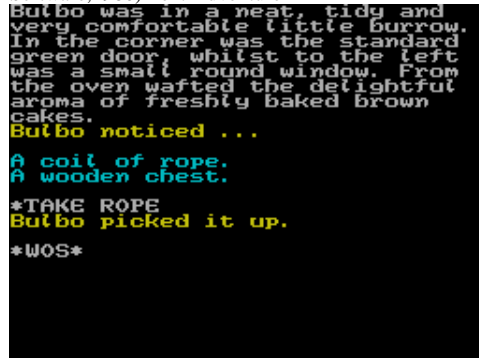

European II (E&J Software,1986)
Simulation

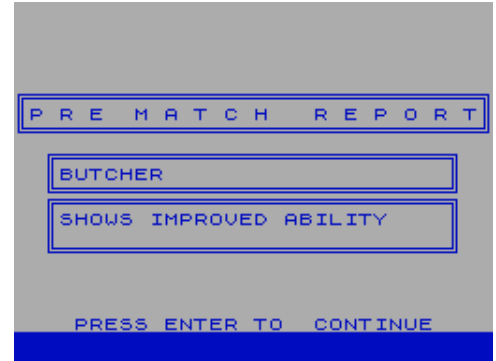

European Trophy (E&J Software,1985)
Simulation



Eve (Primoz Jakopin,1986)
Utility: Word Processor

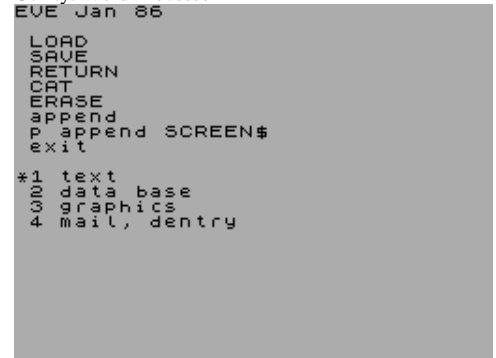

Everest Ascent (Richard Shepherd Software Ltd,1983)
Simulation



Everyone's a Wally (Mikro-Gen Ltd,1985)
Arcade Adventure



Every Second Counts (TV Games,1988)
Board/Card Game



Evil Dead, The (Palace Software,1984)
Arcade



Evil Realm (Turtle Software,1985)
Text Adventure

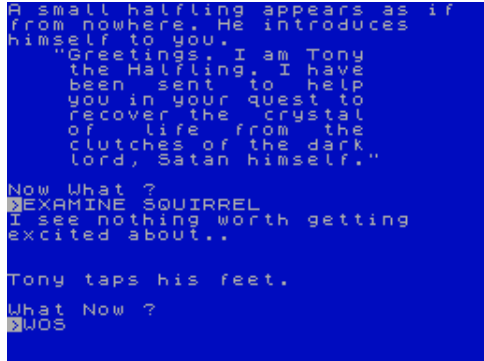

Evolution (Microsphere,1983)
Simulation



Ex-Alf (The Gasman,1996)
Scene Demo



Evictor (Wizard Software,1984)
Arcade

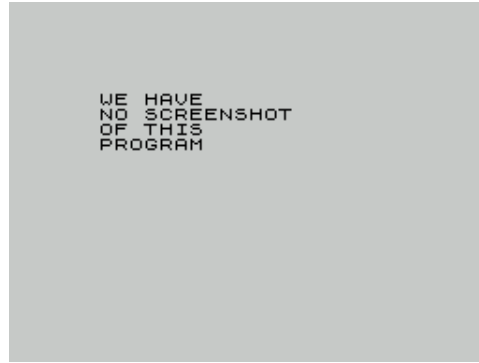

Evil Demo (The United Minds,1995)
Scene Demo



Evil Realm + Bugout (Turtle Software,1985)
Compilation



Evolution (Sinclair Research Ltd,1982)
Educational



Examen, El (Burga's Adventure,1989)
Text Adventure

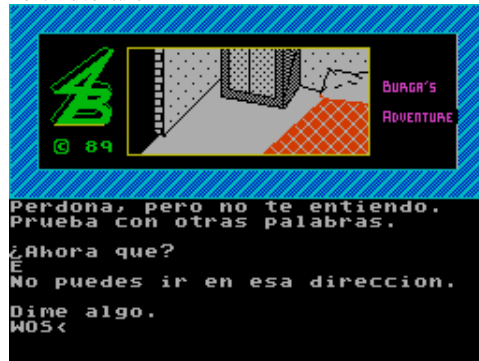

Evil Crown (Argus Press Software Ltd,1985)
Strategy



Evil Domain (R'n'H Microtec,1988)
Arcade



Evil Realm (.)
Text Adventure



Evopunt (MicroHobby,1990)
Utility

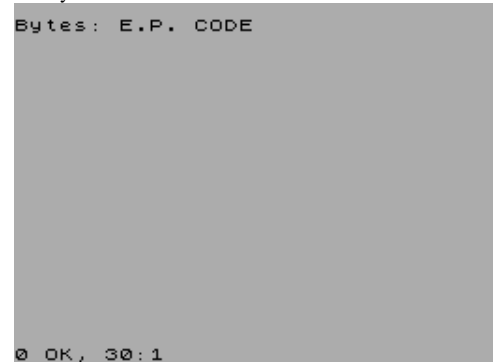

Examen, El (Rock'n'Soft.)
Text Adventure



Examiner (Venny Software,1984)

Utility
Filename: Examiner
Type: Program
Total length: 1273 bytes
Program length: 1273 bytes
Runs from line 1

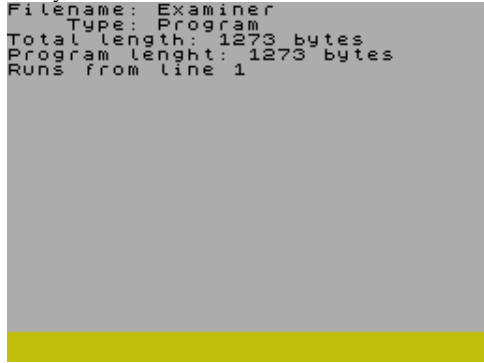

EX-BASIC (Companion Software,1988)

Utility: Programming

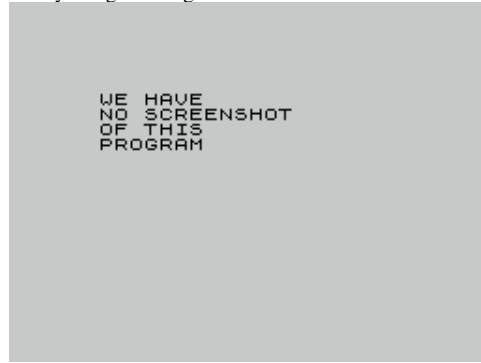

Excalibur (Jose Damian de la Flor San Vicente,1989)

Text Adventure

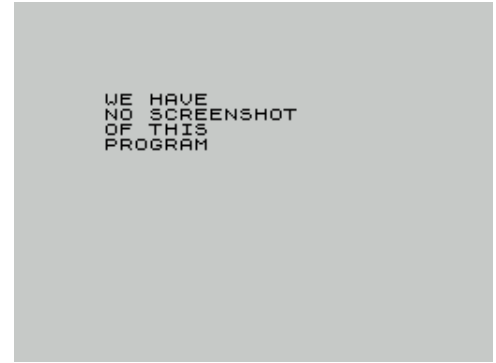

Excalibur (QLS,1985)

Arcade Adventure



Excalibur: Sword of Kings (Alternative Software Ltd,1987)

Text Adventure



Excalibur Against the Enemy (Virgin Books,1983)

Arcade

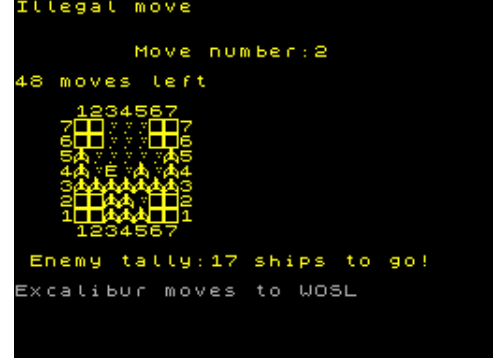

Excavator/Drainlayer 1 (Pricing Building Works,1984)

Utility



Excess (Zer0 International Association,1997)

Scene Demo

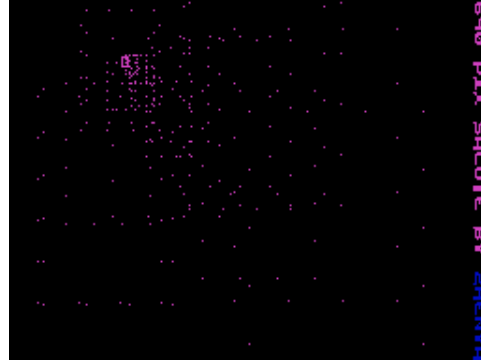

Excessus (Wazertown Works,1990)

Text Adventure

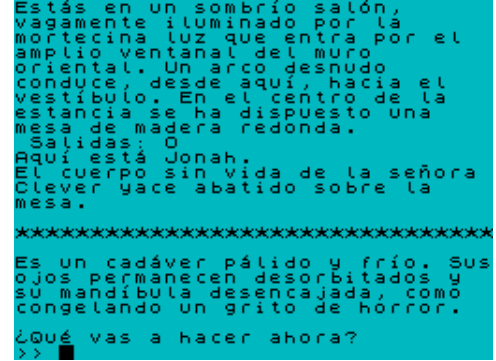

Exclamation (Pansoft,1992)

Scene Demo



Exiled (Your Sinclair,1992)

Text Adventure



Exion (Eclipse [2],1989)

Arcade



Existenz (Triumph Game Labs,2000)

Arcade



Exodus (Firebird Software Ltd,1984)

Arcade

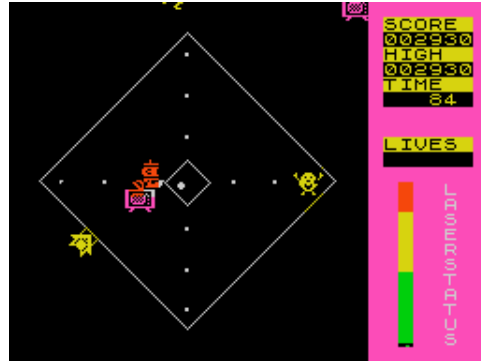

Exodus 1995 (Exodus,1995)

Scene Demo



Exofox (Logic-Art-Ware,1990)
Arcade

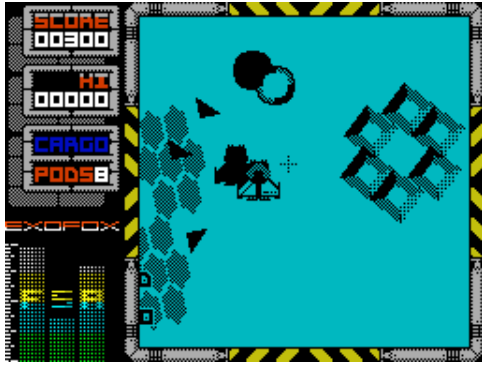

Exotron (Carrium Software,1985)
Arcade

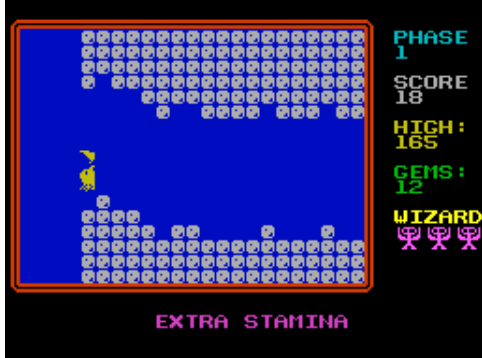

Experience, The (Players Software,)
Text Adventure



Explodeit (16/48 Tape Magazine,1985)
Utility



Exploding Screen, The (16/48 Tape Magazine,1985)
Utility



Exolon (Hewson Consultants Ltd,1987)
Arcade

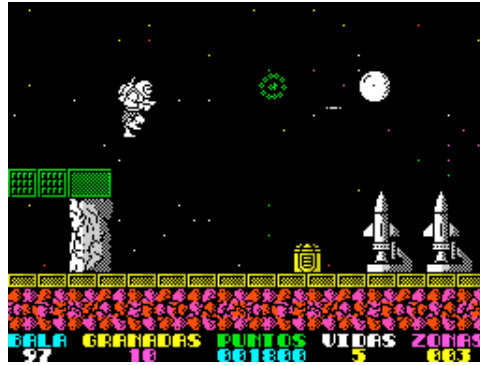

Expander (.)
Utility: Database



Expert (OKF,1988)
Text Adventure



Exploding Atoms (Proxima Software,1991)
Arcade



Exploding Screen Wipe, The (Spectrum Computing,1984)
Utility: BASIC Related



Exoter (Cybexlab Software,1987)
Text Adventure



Expedice (Proxima Software,1990)
Arcade



Expert 4 Bank (Kamasoft,1988)
Utility

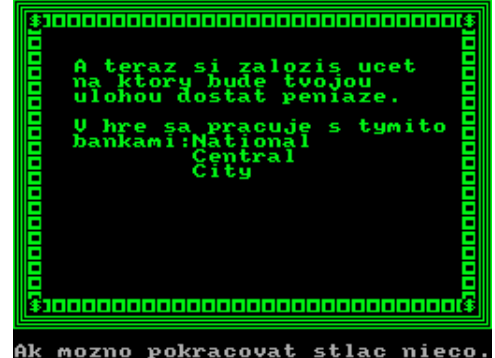

Exploding Fist + (Firebird Software Ltd,1988)
Arcade



Exploding Wall (MC Lothlorien Ltd,1989)
Arcade



Exploits in a Wheelie-Bin (Delbert the Hamster Software,) Text Adventure

```
Ruprect stood on a dusty track that wound its way north towards a forest. Rising up on the other side of the forest, Ruprect could see a large hill, though what was behind that remained a mystery. The track also led southeast past some more fields.

Ruprect shook his head in disbelief. "That was an ingenious way of telling me my quest using as little computer memory as possible," he said.
```

Explorer (Electric Dreams Software,1986) Arcade



Exploring Adventures on the Spectrum (Duckworth Educational Computing,1984) Compilation



E x T (Add-On Electronics Ltd,1983) Arcade



Exterminator (Audiogenic Software Ltd,1991) Arcade

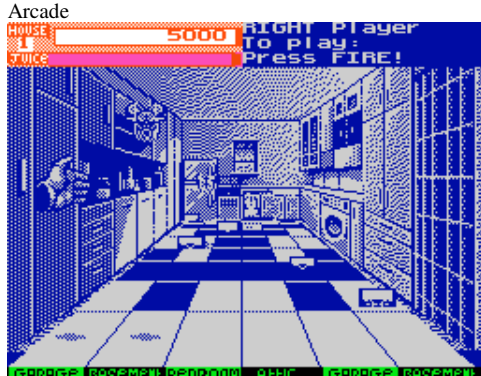

Explorador, El (Microparadise Software,1984) Arcade

```
***CAZA DE SERPIENTES***
Mate 15 serpientes en 45 seg.
Seg.=45 Serpientes=0
<<<<<<< >>>>>>> '1' disparo
V
W W W W W W W W
W W W W W W W W
W W W W W W W W
W W W W W W W W
W W W W W W W W
W W W W W W W W
***PULSE UNA TECLA***
```

Explorer (Sinclair User,1993) Utility

```
TRACK 00 (TRACK) (00 00 00 00) SELECT KEY
(1)....FORMAT TRACK
(2)....READ INDEX
(3)....READ DATA
(4)....WRITE INDEX
(5)....WRITE DATA
(6)....DISPLAY READ INDEX FLAGS
(7)....DISPLAY READ DATA FLAGS
(8)....DIPLAY WRITE INDEX FLAGS
(9)....DISPLAY WRITE DATA FLAGS
(C)....COMPARE TRACKS
```

Expose (Keysoft,1986) Educational



Extended BASIC (CP Software,1984) Utility: Programming



Exterminator (Silversoft Ltd,1983) Arcade



Explorer (Clockbyte,1984) Text Adventure

```
Ich bin an einem Feldrand. Der einzige Ausgang fuehrt nach Osten.
Ich sehe :
...TOTENKOPF

Was jetzt ? WOSC
```

Explorer XXXI (Dro Soft,1988) Arcade



Express Raider (US Gold Ltd,1987) Arcade

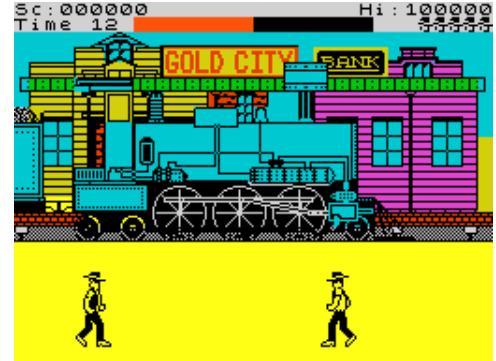

Extensor (Awk Software,1985) Arcade



Exterminator (Torg Software,1984) Arcade



Extraordinarios Casos del Dr. Van Halen Caso 1: Misterio en la (Josep Coletas Caubet,2004) Text Adventure

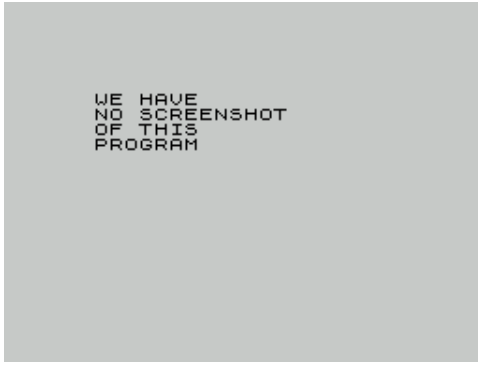

Extraordinarios Casos del Dr. Van Halen Caso 4: Tristes Alas de (Josep Coletas Caubet,2005) Text Adventure



Extricator, The (Precision Games,1986) Text Adventure

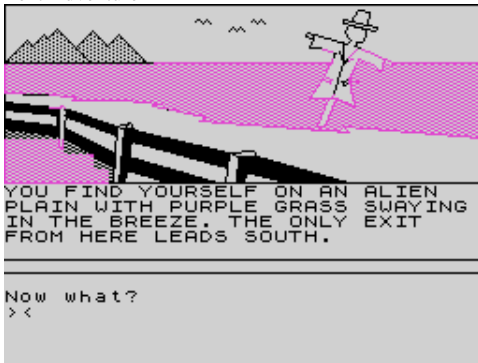

Eye of the Beholder (Cassiopeia,1993) Scene Demo



Eye of Vartan (Pocket Money Software,1985) Text Adventure

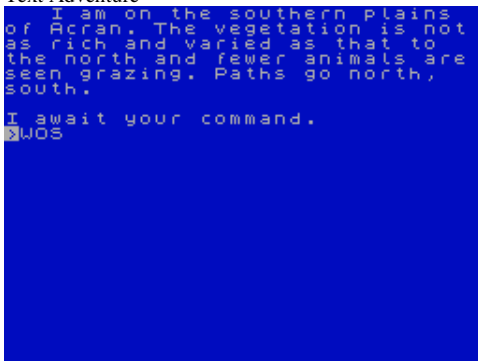

Extraordinarios Casos del Dr. Van Halen Caso 2: El Cuervo de la (Josep Coletas Caubet,2004) Text Adventure

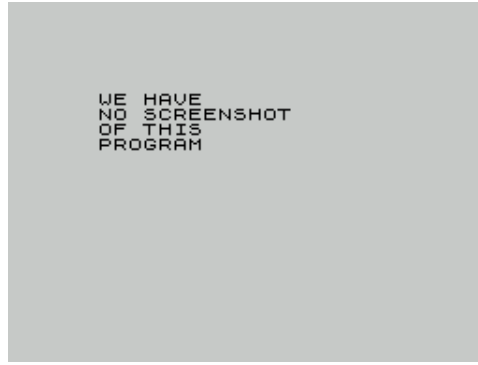

Extraordinarios Casos del Dr. Van Halen Caso 5: Ultimo Acto, Lo (Josep Coletas Caubet,2005) Text Adventure

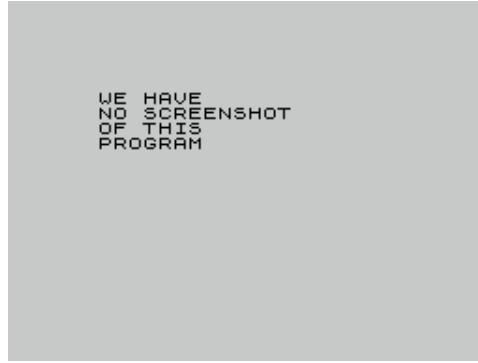

Eye (Endurance Games,1987) Board/Card Game

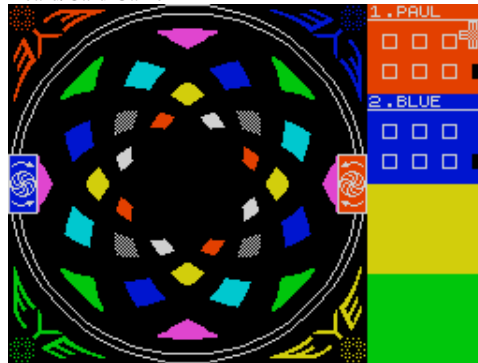

Eye of the Moon, The (Beyond Software,) Strategy



F-15 Strike Eagle (Microprose Software Ltd,1986) Arcade



Extraordinarios Casos del Dr. Van Halen Caso 3: Cantos de Anubi (Josep Coletas Caubet,2005) Text Adventure



Extreme (Digital Integration,1991) Arcade



Eye Ache (Code Busters,1996) Scene Demo

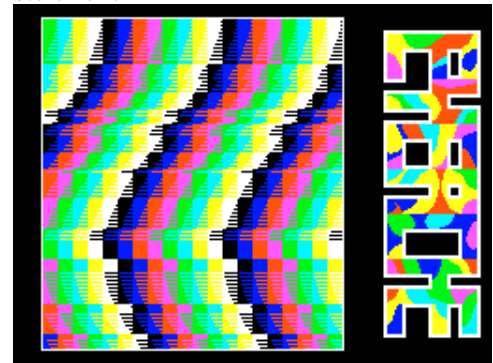

Eye of the Star Warrior, The (Sunshine Books,1984) Text Adventure



F-16 Combat Pilot (Digital Integration,1991) Arcade



F-16 Fighting Falcon (Virgin Mastertronic Ltd,1990)
Arcade



Faals of Shalor (Emprise Software,1983)
Arcade



Fabled Treasure of Koosar, The (The Guild,1992)
Text Adventure



Factory Breakout (Poppy Soft,1984)
Arcade

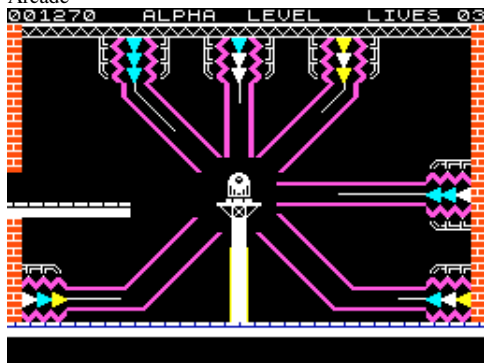

Faerie (8th Day Software,1985)
Text Adventure

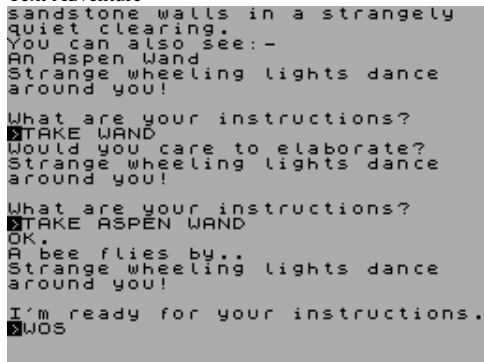

F-18 Simulator (Hipocrates Soft,)
Arcade



Fabled Black Rose, The (Dream World
Adventures,1994)
Text Adventure



Face of Blood (,1986)
Text Adventure



F.A. Cup (Top Spec,1986)
Simulation



Faerie 2: The Buggon's Gold (8th Day Software,)
Text Adventure



F1 Tornado Simulator (Zeppelin Games Ltd,1991)
Arcade



Fabled Treasure of Koosar + Birthday Surprise, The
(The Guild,1992) Compilation



Factors (Sinclair User,1984)
Utility: Mathematics

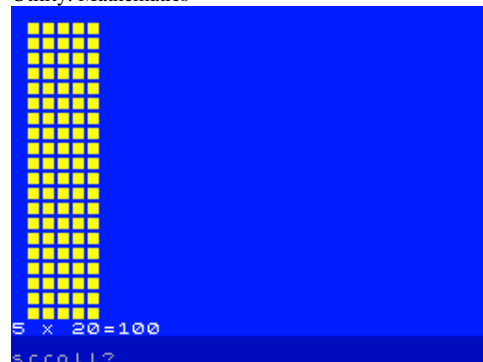

FA Cup Football (Virgin Games Ltd,1986)
Simulation

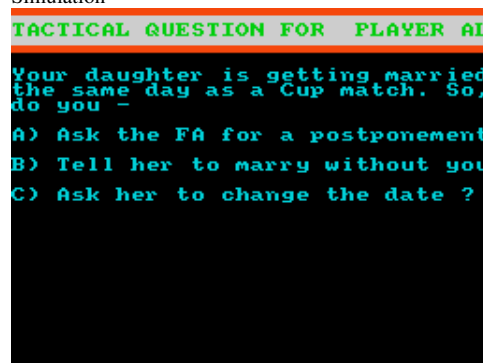

Fahrenheit 3000 (Firebird Software Ltd,1985)
Arcade Adventure

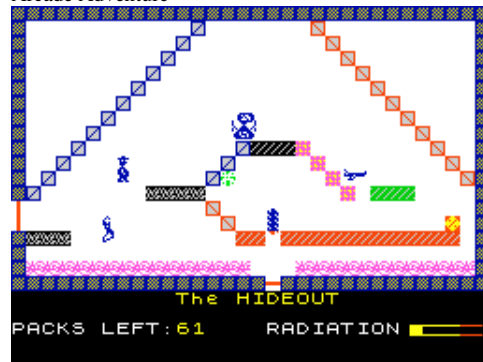

Fairlight (The Edge Software,1985)
Arcade

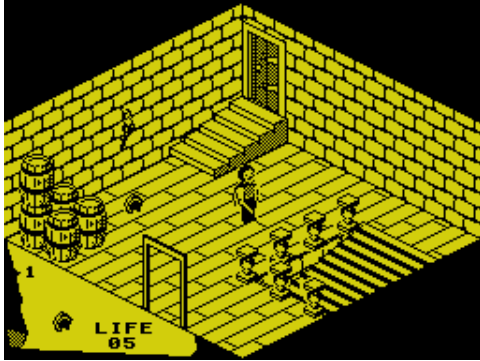

Fairly Difficult Mission (Zodiac Software,1988)
Text Adventure

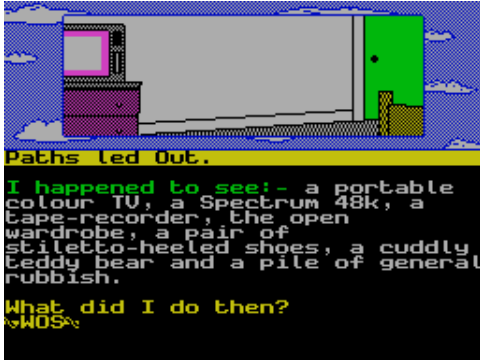

Fakultet (Ribic Samir,1987)
Text Adventure



Falklands 82 (PSS,1986)
Strategy



Fallen Angel (Paradox,1998)
Arcade



Fairlight: The Legend (The Micro Selection,1988)
Compilation

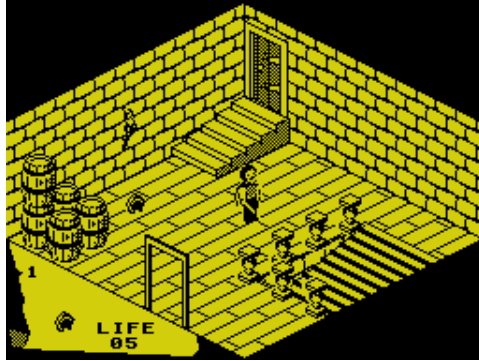

Fairshare (Griffin Software,1984)
Educational

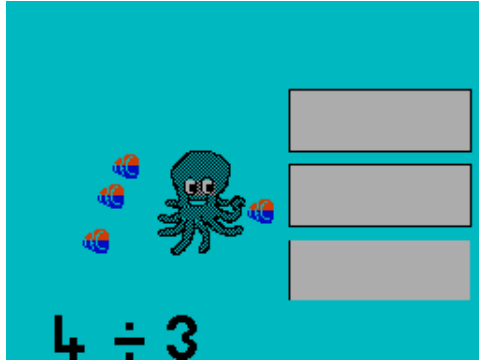

Falcon Patrol 2 (Virgin Games Ltd,1985)
Arcade



Falklands Crisis (Llainlan Software,1985)
Arcade



Fallen Angel (Screen 7 Ltd,1989)
Arcade

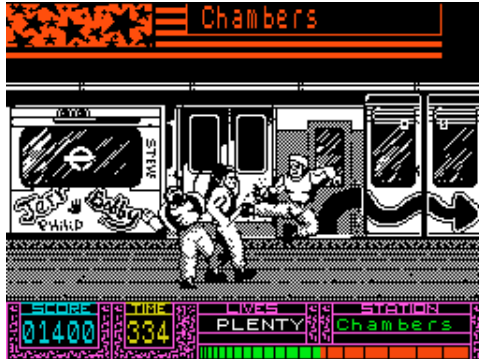

Fairlight II (The Edge Software,1986)
Arcade Adventure

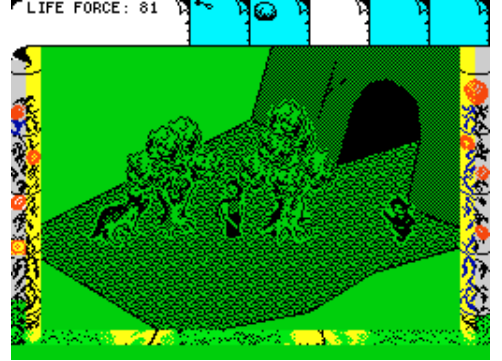

Fair Shares (Shiva Publishing Ltd,1983)
Arcade



Falcon the Renegade Lord (Virgin Games Ltd,1987)
Arcade Adventure



Falldown Forever (Bohumil Pesek,2004)
Arcade

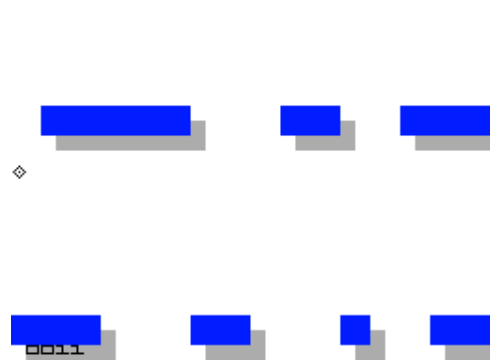

Fall Guy, The (Elite Systems Ltd,1985)
Arcade



Falling Down (J.H.C.S.,1995)
Arcade

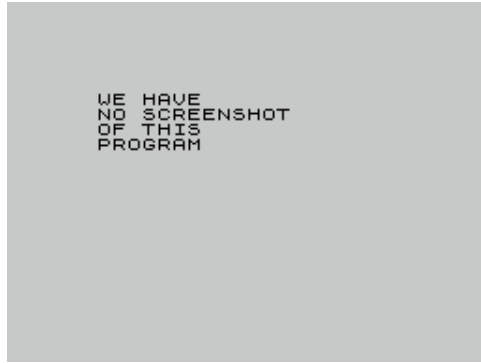

Falls of Shalor, The (C.P. Woodward,1983)
Text Adventure

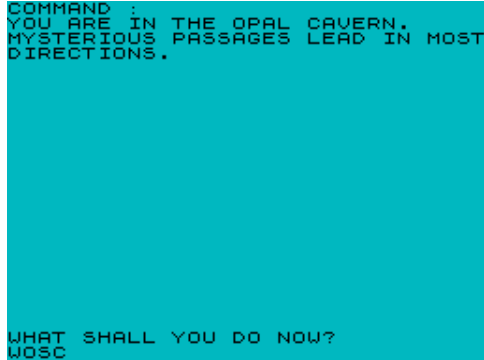

Family Quiz (Blandford Press.)
Board/Card Game

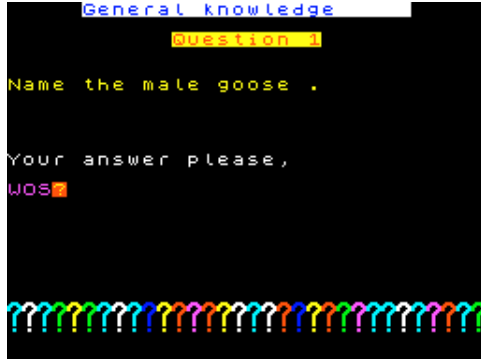

Famous Five, The (Enigma Variations Ltd,1990)
Text Adventure

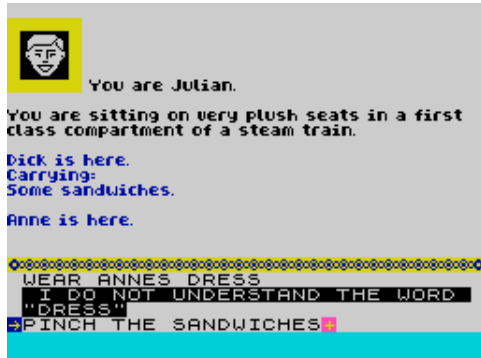

Fantasma del Castillo, El (Micromania [2],1985)
Arcade



Fall of Rome, The (ASP Software Ltd,1984)
Strategy

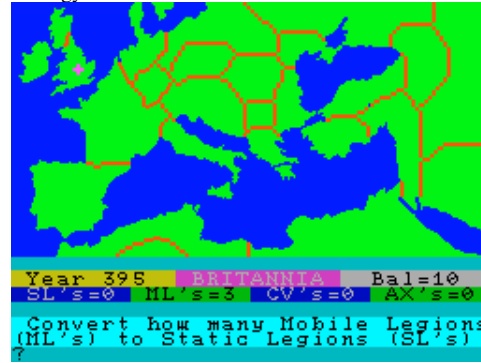

False Gold (David J. Stew,1983)
Strategy



Family Tree (Keysoft,1982)
Utility

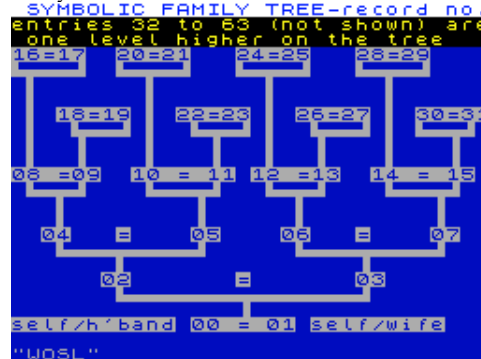

Fancy Border Story (Spectrum Computing,1984)
Utility



Fantastic Adventure (Masters Games,1991)
Arcade



Fall of the Third Reich (Tk Computerware,1985)
Strategy



Fame Quest (Braingames,1984)
Simulation



Famous Five (Mastertronic Ltd,1987)
Compilation

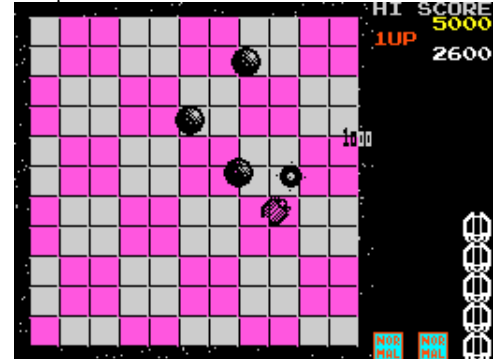

Fantasia Diamond (Hewson Consultants Ltd,1984)
Text Adventure

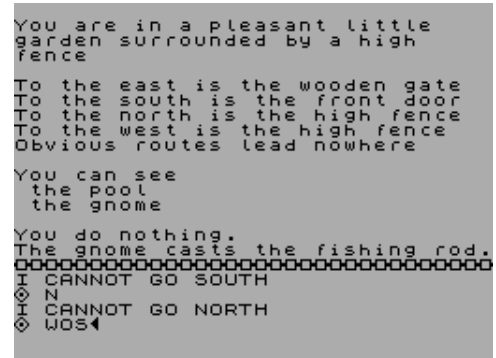

Fantastic American Football (Zeppelin Games Ltd,1990)
Arcade



Fantastic Four (Mastertronic Ltd.)
Compilation



Fantastic Voyage (Quicksilva Ltd,1984)



Fantasy, The (Mediandroid,1987)

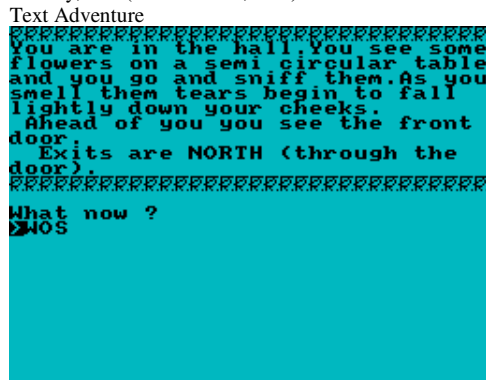

Faraon (ABC Soft,1985)

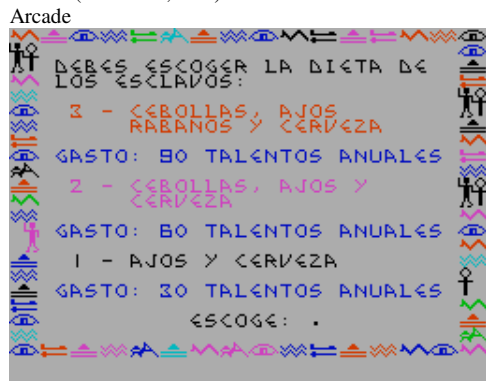

Farmer Jack in Harvest Havoc (Cronosoft,2006)



Fantastic Mission (Program Software,1984)
Arcade

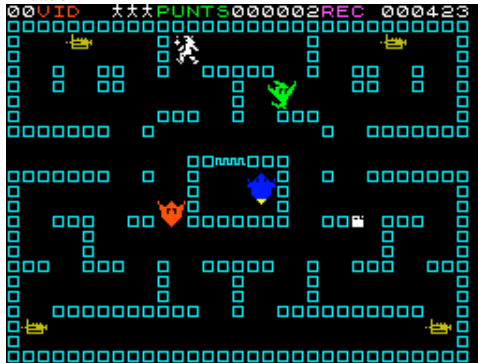

Fantasy (Rafii Soft,1990)



Fantasy World Dizzy (Code Masters Ltd,1989)



Faraon (CV Software,1989)



Farm Simulation (R. Bucket,1987)

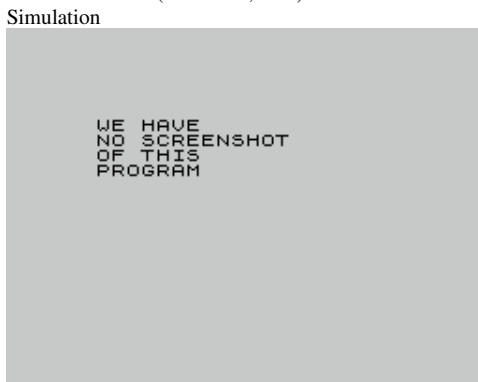

Fantastic Mister Fruity, The (Cronosoft,2005)
Arcade

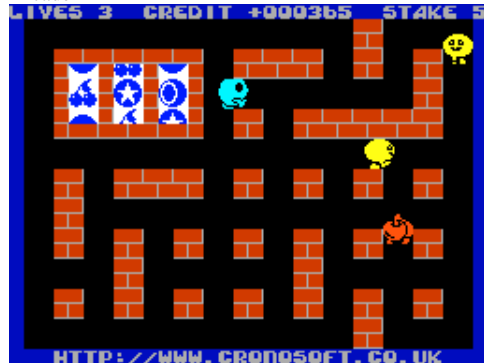

Fantasy: An Adult Game (R'n'H Microtec,1987)

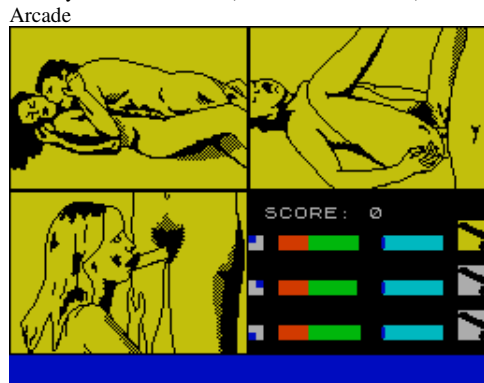

Fantasy Zone 2, The (.)

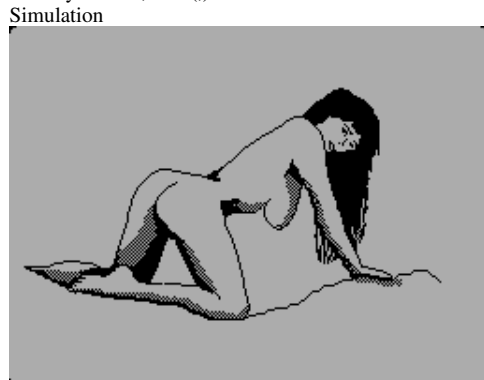

Farmer Horace (CCS,1983)

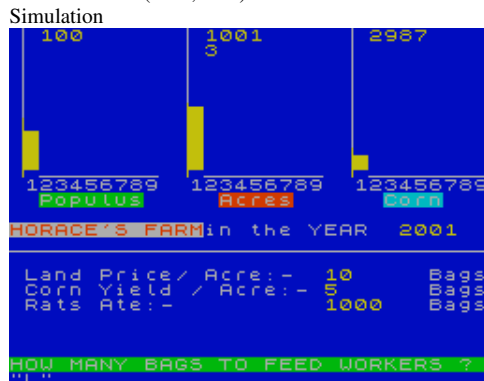

Farspace (Mayhem,2001)



Fashion Tops and Batwing (Terry Mason,1987)
Utility



Fast Format (.)
Utility

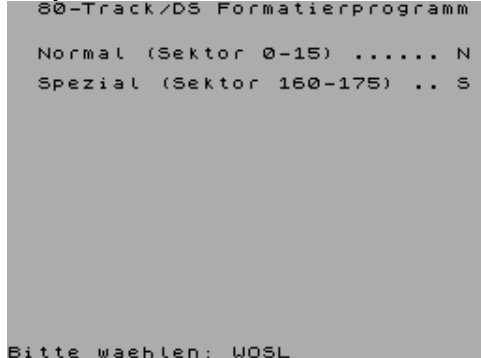

Bitte waehlen: WOSL
Fastword (Bruce Publishing,1988)
Utility: Word Processor



Father of Darkness (Central Solutions,1984)
Text Adventure



Faulty Towers (Harbour Soft,1984)
Text Adventure



Fast Breed (Master Home Computers Group,1998)
Board/Card Game



Fast 'n' Furious (Go!,1987)
Arcade



Fastword Plus (Betterbytes Software,1989)
Utility: Word Processor



Father of Darkness + Murder (Central Solutions,1986)
Compilation



Faust's Folly (AbbeX Electronics,1983)
Text Adventure



Fast Food (Code Masters Ltd,1989)
Arcade



Fast 'n' Furious + Thunderceptor (Go!,1987)
Compilation



Fastword Plus + TasWord (Betterbytes Software,1989)
Compilation

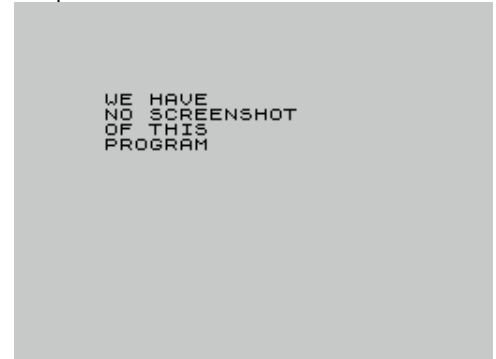

Fat Worm Blows a Sparky (Durell Software Ltd,1986)
Arcade



Fax (G4IDE Micro Systems,1986)
Utility



Fax for Your Spectrum (G4OIK/G4OIL,1988)
Utility

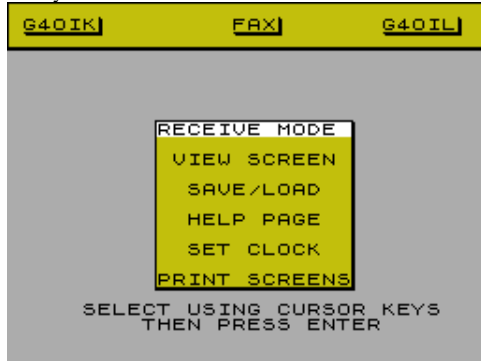

FBI-13 (Black Eagle Company,1995)
Arcade

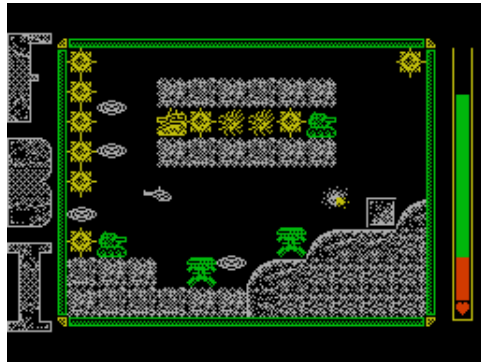

Fear Tales (Games Killer,1995)
Arcade



Federico Jones (Rock'n'Soft,1992)
Text Adventure



Fernandez Must Die (Image Works,1988)
Arcade



FB01 Editor (XRI Systems,1987)
Utility



F-Disk Editor (Igor Kapultsevich,1988)
Utility

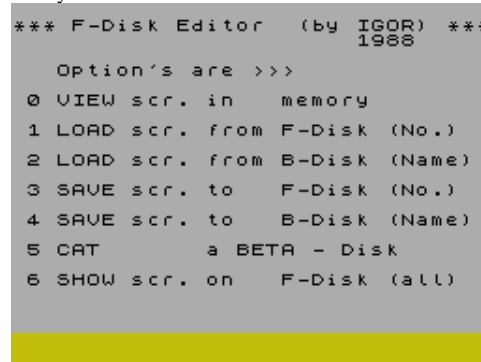

Fearzone (Naughty Crew,1998)
Scene Demo

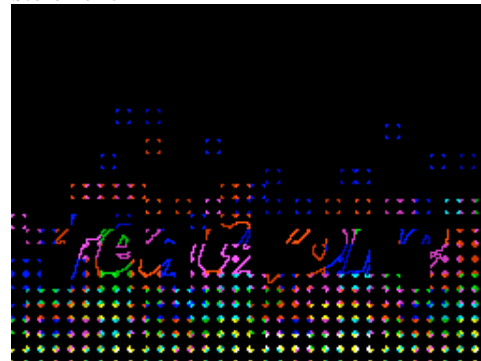

Feline Sleepy (Adventure Probe Software,1998)
Text Adventure

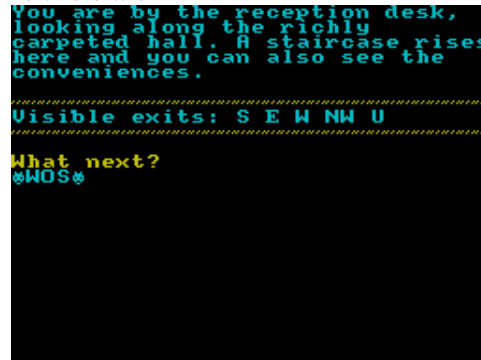

Fernando Martin Basket Master (Dinamic Software,1987)
Sport



F.B.I. (The Unbelievables,1996)
Scene Demo



Fearless Frank (St. Michael,1984)
Arcade



Feasibility Experiment (Digital Fantasia,1983)
Text Adventure



Fergus Furgleton (Infected Software,1987)
Text Adventure

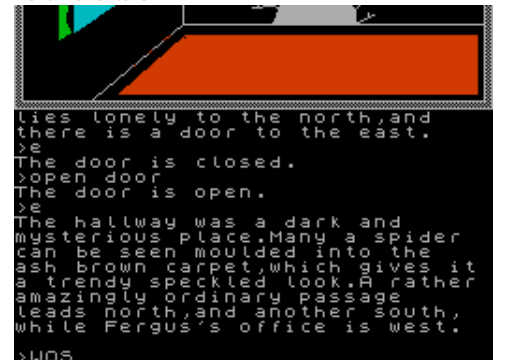

Ferrari Formula 1 (Electronic Arts,)
Arcade



Festung (.)
Board/Card Game

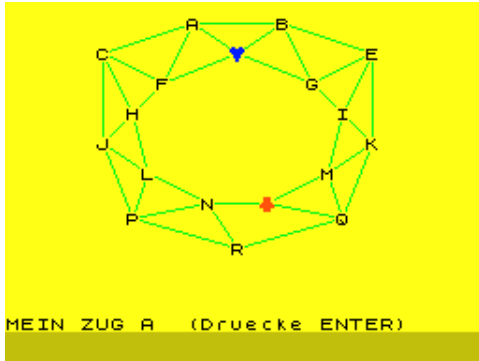

Feudal Wars (ZX-Studio,1997)
Strategy



Fichero Musical (Music Soft,1984)
Utility

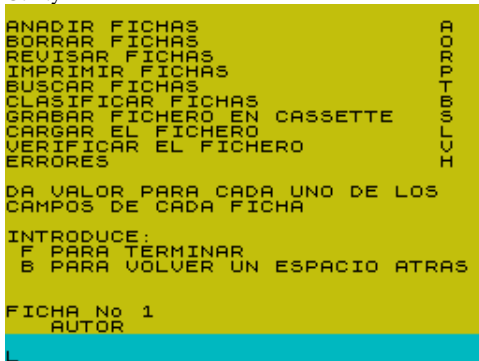

Fido (Firebird Software Ltd,1985)
Arcade



Fiendish Freddy's Big Top o'Fun (Mindscape International Inc,1990) Arcade

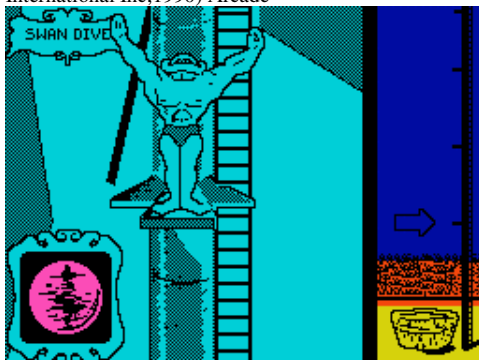

Feud (Bulldog,1987)
Arcade



Feuerfaust, Die (FSF Adventures,1995)
Text Adventure

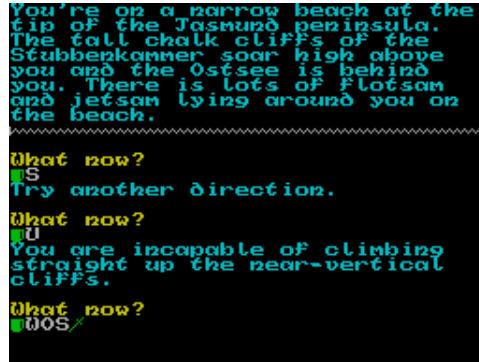

Ficheros de Carga Automatica en Microdrive (MicroHobby,1985) Utility

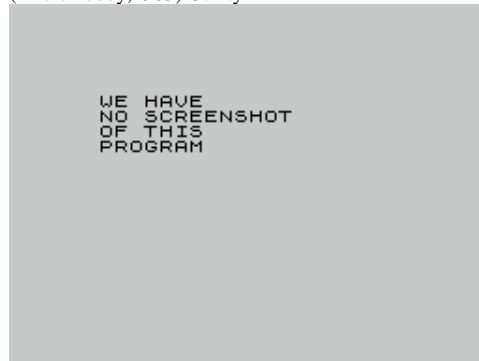

Fido 2: Puppy Power (Firebird Software Ltd,1985)
Arcade



F.I.F.O. (Klub Fifo,1989)
Arcade



Feudal Overlord (Channel 8 Software,1984)
Strategy



Fichero (Investronica S.A.,1984)
Utility: Database



Fichesprit (Slowglass,)
Utility



Fields of Logic (Smokers,1999)
Board/Card Game

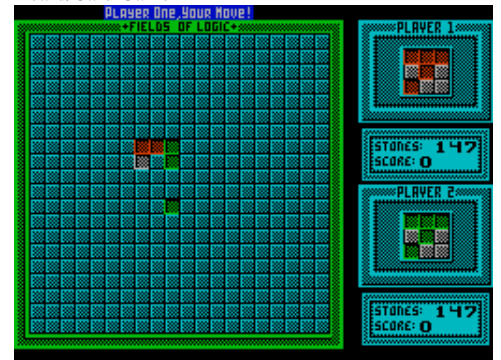

Fifth (CRL Group PLC,1983)
Utility: BASIC Related



Fifth Quadrant, The (Bubblebus Software,1987)
Arcade Adventure

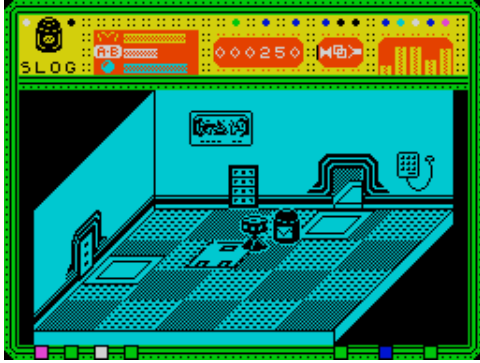

Fig Chess (16/48 Tape Magazine,1985)
Board/Card Game



Fighter Pilot (Digital Integration,1983)
Simulation



Fighting Soccer (Activision Inc,1989)
Sport

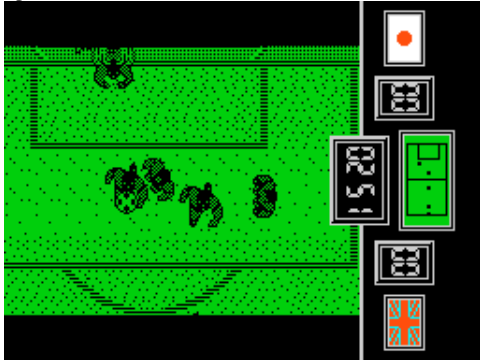

Fikus Pikus Gift (Flash Inc.)
Scene Demo



Fifty / Fifty (Homesoft,)
Scene Demo



Fighter (Werner Spahl,1983)
Arcade

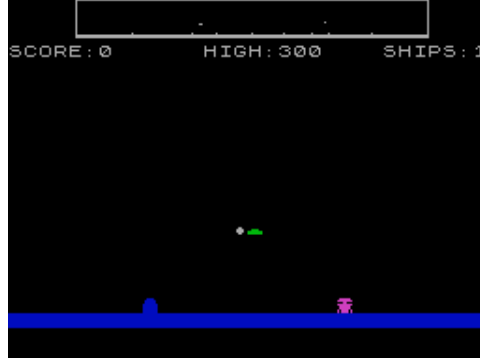

Fighter Pilot (Precision Software Engineering,1983)
Arcade



Fighting Warrior (Melbourne House,1985)
Arcade



File Card (Daniel Sailer,)
Utility



Figaro II (Saxon Computing,1983)
Utility



Fighter Bomber (Activision Inc,1990)
Arcade

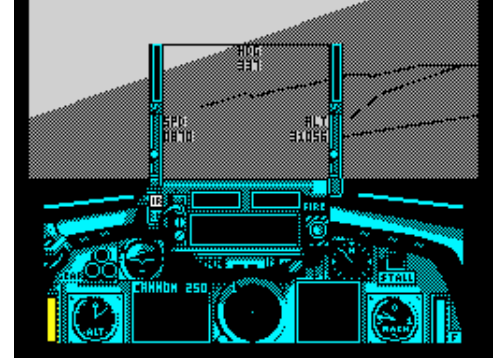

Fight for the Ashes 1, The (Lambourne Games,1996)
Strategy



Figment (Flash Inc,1995)
Scene Demo



File Card (Daniel Sailer,)
Utility

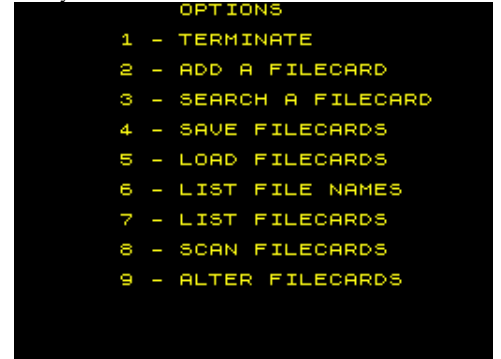

File Convertor (S.D. Software,1998)
Utility

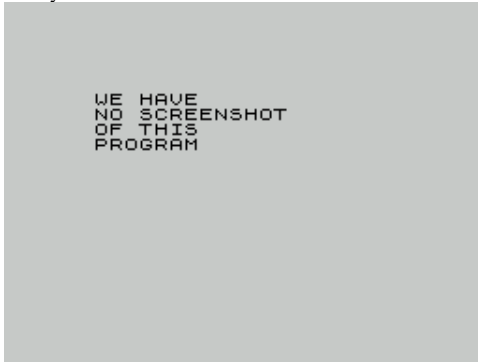

File Copy (NCB,1983)
Utility: Copier

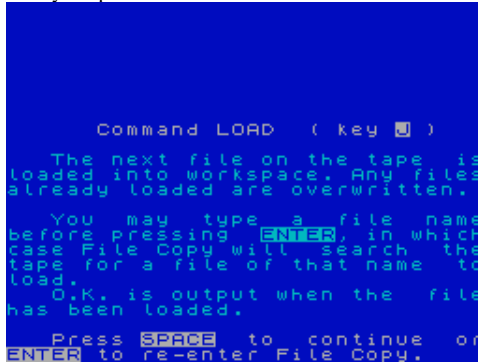

File Master (Betterbytes Software,1989)
Utility



Filemon (Leszek Krecielewski,1986)
Arcade

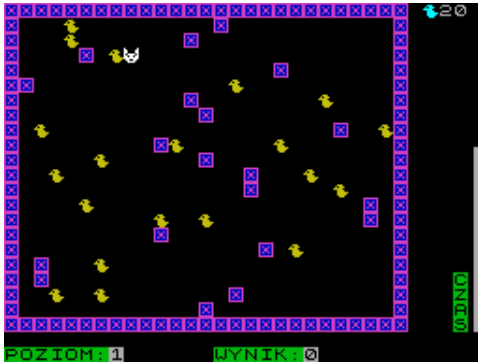

Filer (Technology Research Ltd,1984)
Utility: Database

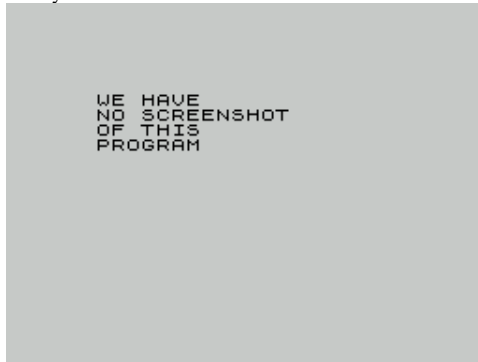

Filing System (R.D. Foord Software,1987)
Utility



Fill (.)
Utility: Screen Manipulation

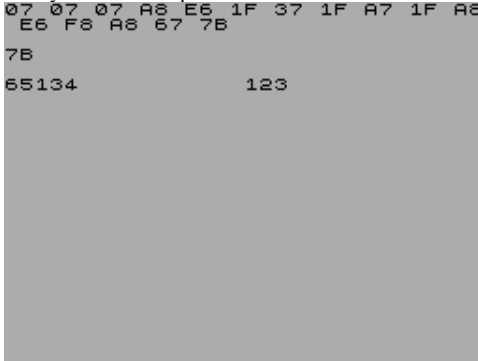

Fill (16/48 Tape Magazine,1985)
Utility



Filler (ZC,1996)
Board/Card Game

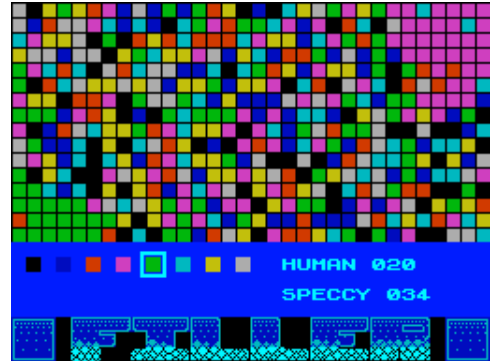

Fillers (Oleg Sergeyev,1995)
Arcade

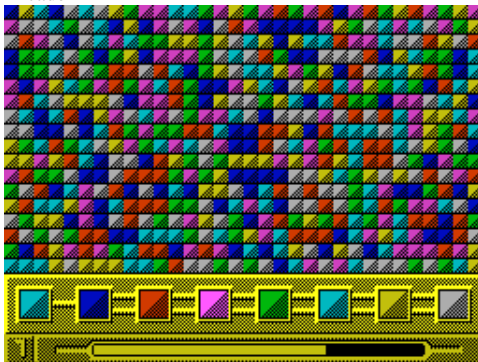

Fill It (Your Sinclair,1993)
Utility: Drawing

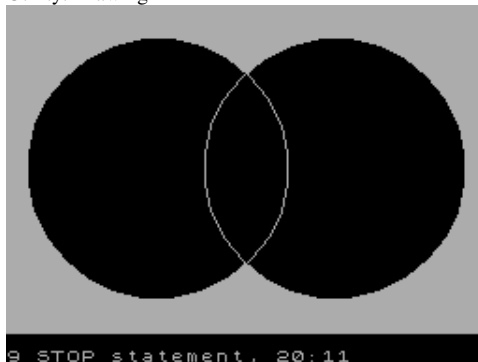

Filimation (MicroHobby,1986)
Educational



Final Accounts (Gemini Marketing Ltd,1984)
Utility: Spreadsheet



Final Assault (US Gold Ltd,1988)
Sport



Final Battle, The (Dream World Adventures,1993)
Text Adventure

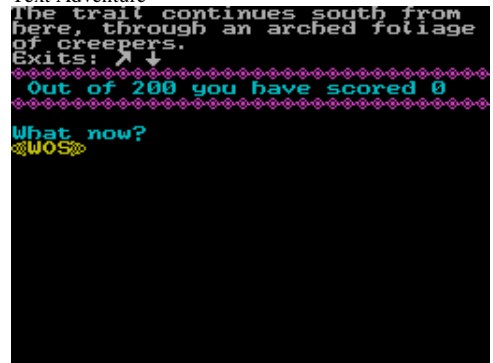

Final Chorus, The (Zenobi Software,1995)

Text Adventure

The clearing was dark, damp and quite miserable. (A bit like Leopold, really, especially sporting his new tan). Sounds of birds in the tall trees high above echoed all around, as if they were throwing a wild party. Overgrown paths were visible north, west and east.

Leopold could also see:
Smidgin the Olde

What did Leopold do next?
>WOS*

Final Countdown, The (T.E.R.M. Software,1991)

Scene Demo

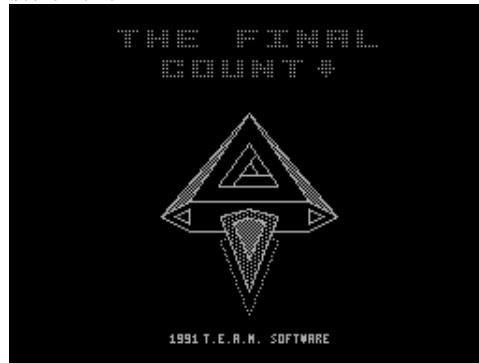

Final Demand, The (Zenobi Software,1993)

Text Adventure

Chasm:
Across a wide chasm is a mountain range. Directly opposite the rock face is crumbling and occasionally rocks drop into the aching void below. A path leads east and west along the chasm edge.

What now?
>WOS*

Final Fight (US Gold Ltd,1991)

Arcade



Final Frog (Pepsi Soft,1991)

Text Adventure

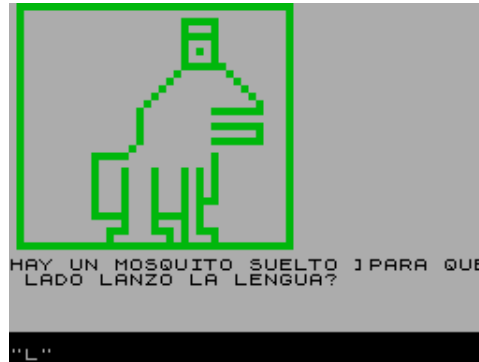

Final Frontier (Procom Software,1984)

Arcade



Final Frontier, The (Gadtek Games,1987)

Arcade Adventure

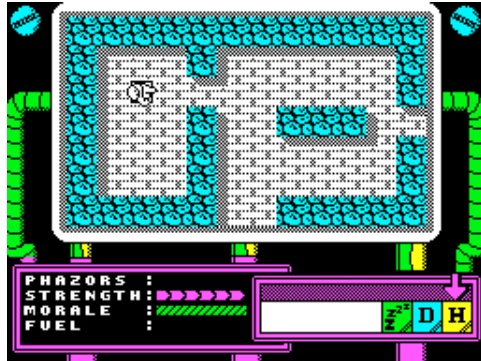

Final Matrix, The (Gremlin Graphics Software Ltd,1987)

Arcade

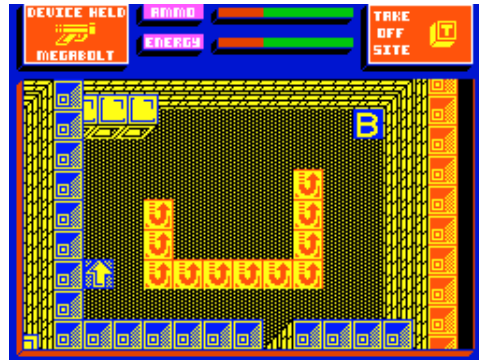

Final Mission, The (Incentive Software Ltd,1984)

Text Adventure

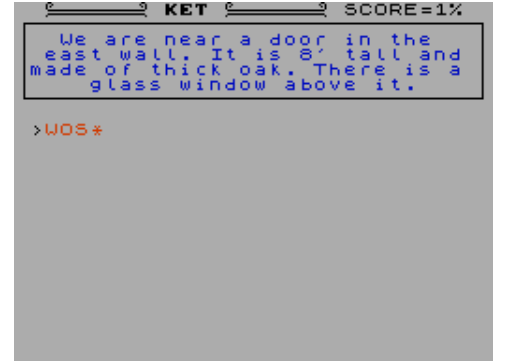

Final Strike 1 (The Unbelievables,)

Scene Demo



Final Strike 2 (The Unbelievables,)

Scene Demo



Finance Manager (Oxford Computer Publishing,1983)

Utility



Finders Keepers (Mastertronic Ltd,1985)

Arcade Adventure



Find the Mate (Sinclair Research Ltd,1982)

Arcade



Find the Rabbit (Sinclair User,1984)

Arcade

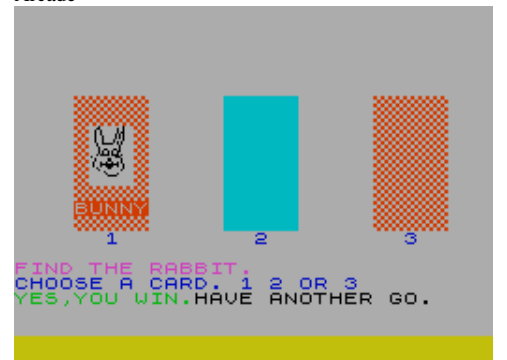

F.I.R.E. (UltraSoft,1988)
Arcade

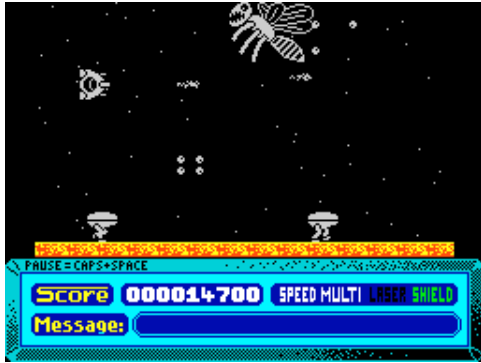

Fireball (Fontana Publishing,1984)
Arcade



Fire Fight (H.S. Software,1987)
Educational

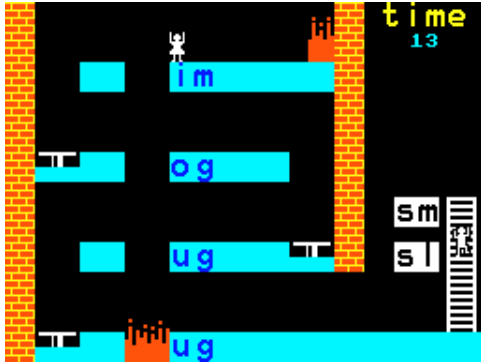

Firefly (Ocean Software Ltd,1988)
Arcade

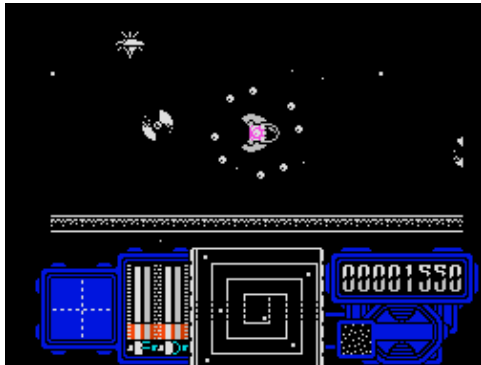

Fire Hawks (Postern,1984)
Arcade

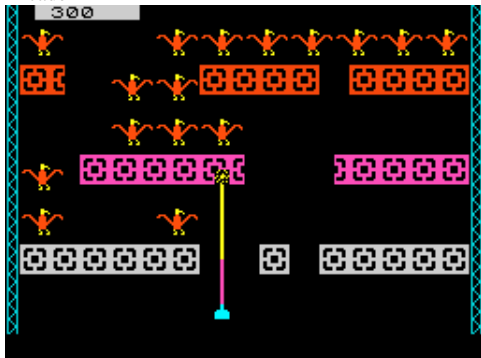

Fire and Forget (Titus,1988)
Arcade

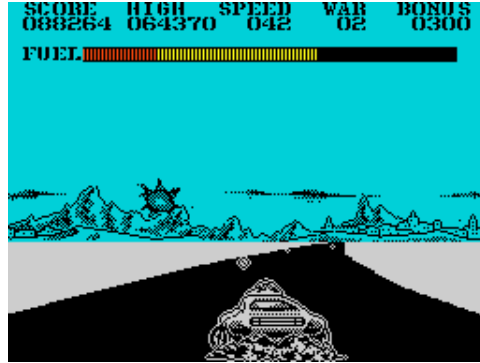

Firebirds (Softek Software International Ltd,1983)
Arcade



Fireflash (Abacus Programs,1983)
Arcade

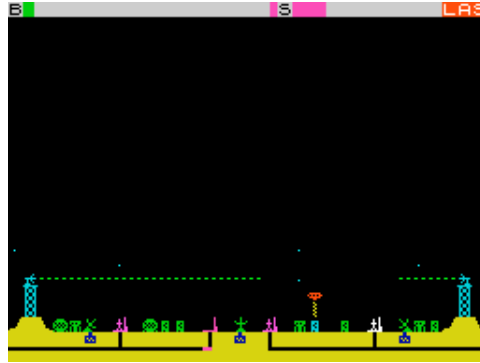

Fire Fox (MicroHobby,1985)
Arcade

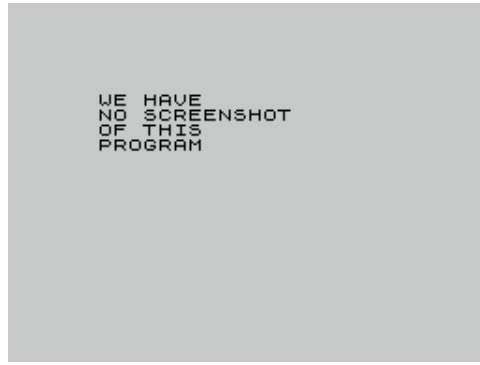

Firelance (Hamster Software,1985)
Text Adventure

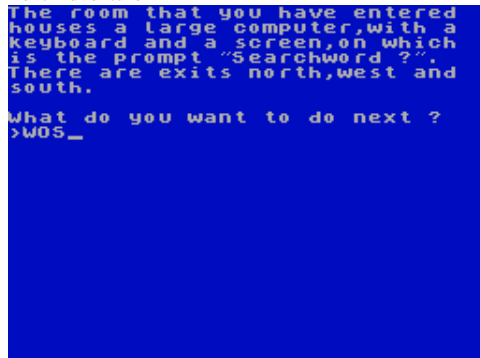

Fire and Forget II: The Death Convoy (Titus,1985)
Arcade

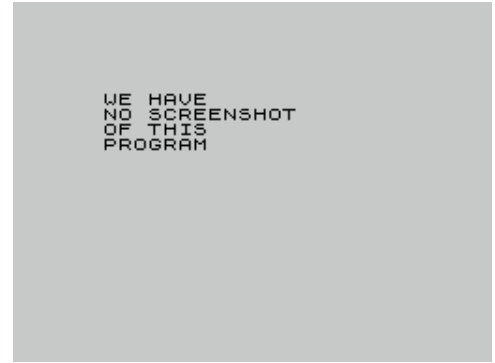

Fire Copy (Zeljko Juric,1985)
Utility: Copier



Fireflash + Destroyer (Abacus Programs,1983)
Compilation

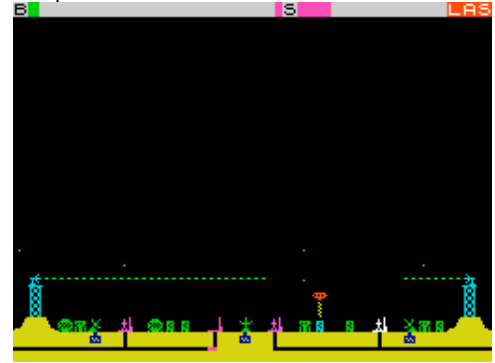

Fire Gear (TM'M Studio,1994)
Arcade

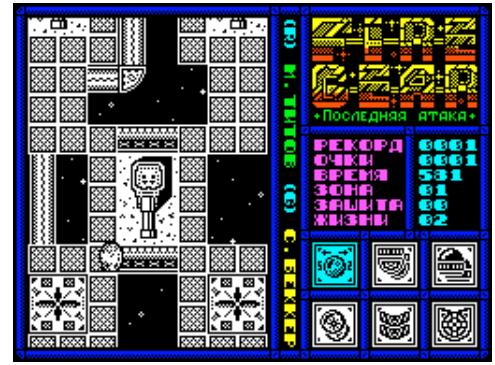

Firelance + Fortress of Keler (Hamster Software,1985)
Compilation

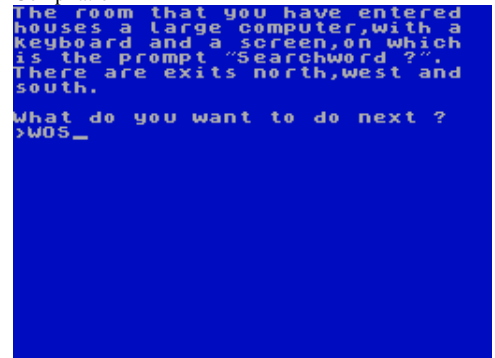

Firelord (Hewson Consultants Ltd,1986)
Arcade Adventure



Fireman Sam (Alternative Software Ltd,1992)
Arcade



Firepower (Armadillo Soft,1987)
Arcade



Fireterm Scrolling Terminal (Paul Clevett,1986)
Utility

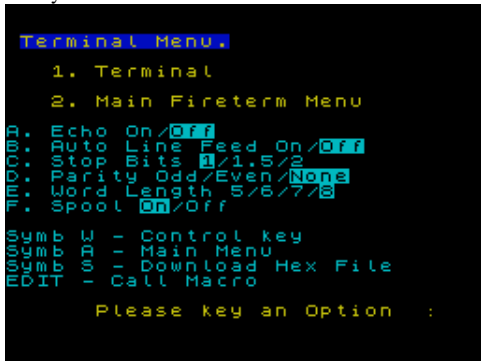

Firewolf (Cybexlab Software,1986)
Arcade

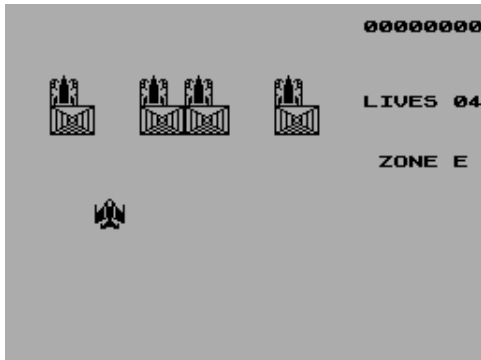

Fireman (Miguel Angel Rodriguez Jodar,2005)
Arcade



Fire 'n Ice (N-Discovery,2004)
Arcade

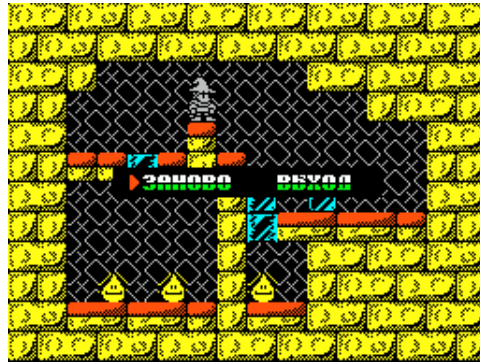

Fire Ruby, The (Zenobi Software,1997)
Text Adventure

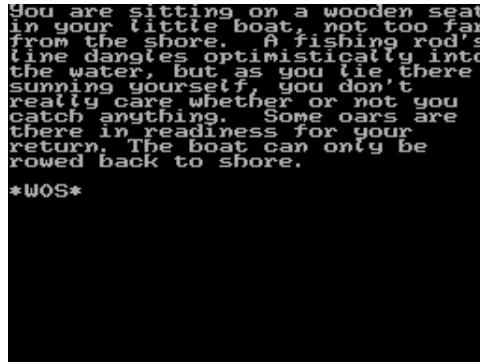

FireTrap (Electric Dreams Software,1987)
Arcade

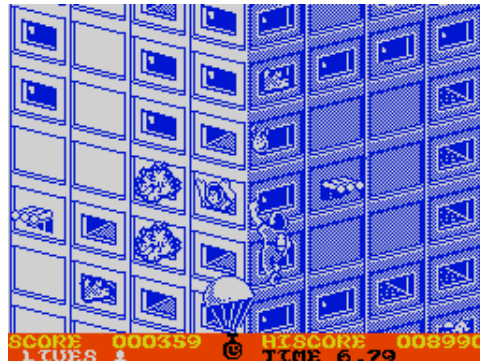

Firework Music (Software Cottage,1983)
Educational

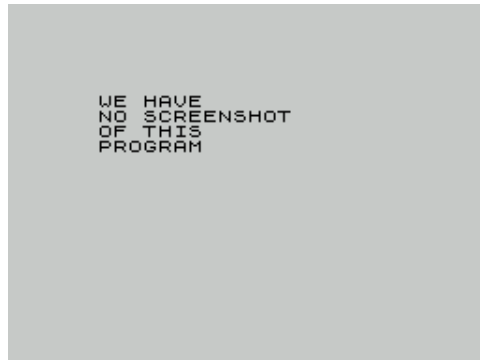

Fireman Fred (Tynesoft,1984)
Arcade

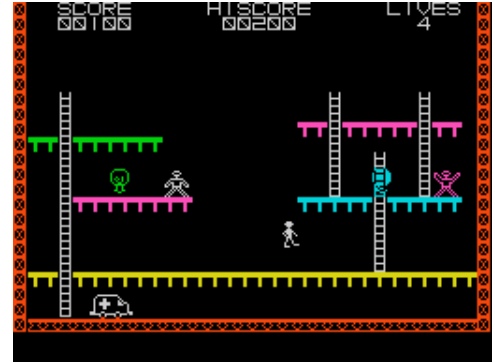

Fire on the Water (Hutchinson Computer Publishing,1984)
Text Adventure



Firestorm (Nexus Productions Ltd,1986)
Arcade

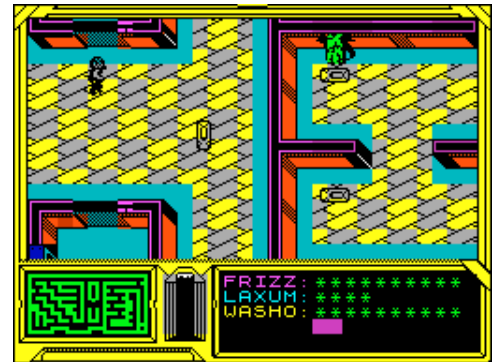

Fire Trap (Sinclair User,1983)
Arcade

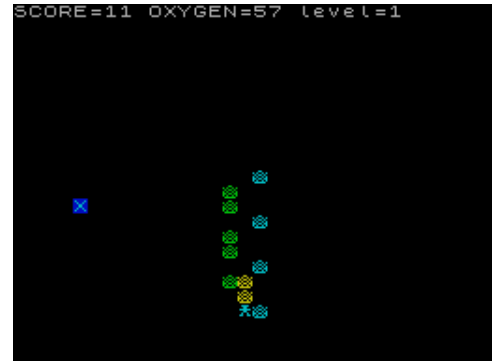

Firework Music + Water Music (Software Cottage,1983)
Compilation



First Aid (Eastmead Computer Systems,1984)
Educational

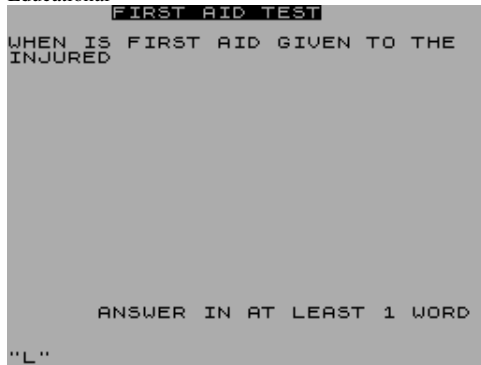

First Demo for AY Interface (Sauron,1994)
Scene Demo

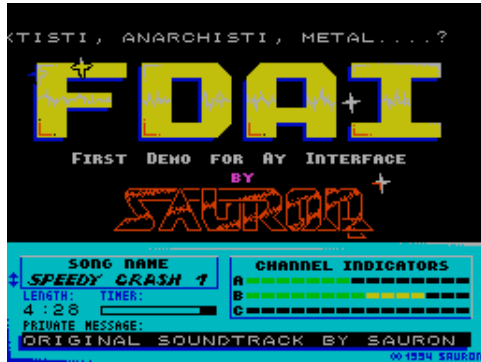

First Moves (Longman Software,1985)
Board/Card Game

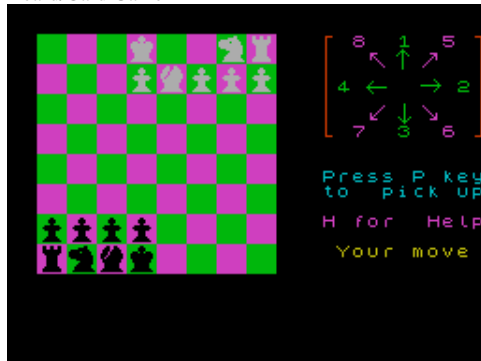

First Past the Post (Cult Games,1988)
Simulation



First Steps with the Mr. Men (Mirrorsoft Ltd,1983)
Educational

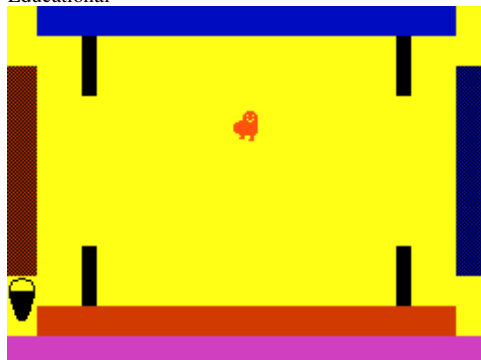

First Association Preview (Omega Software
GFX,1997)

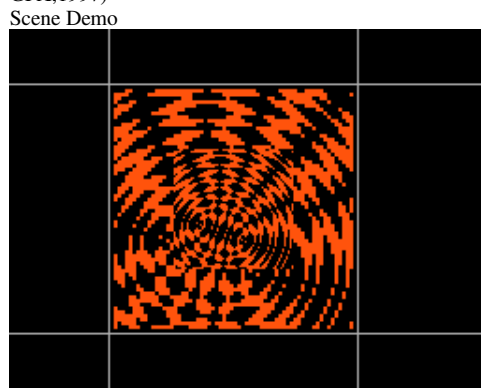

First Division Manager (Code Masters Ltd,1991)
Simulation



First Music Demo (Sergey Magera,)
Scene Demo



First Past the Post (Delbert the Hamster Software,1992)
Text Adventure

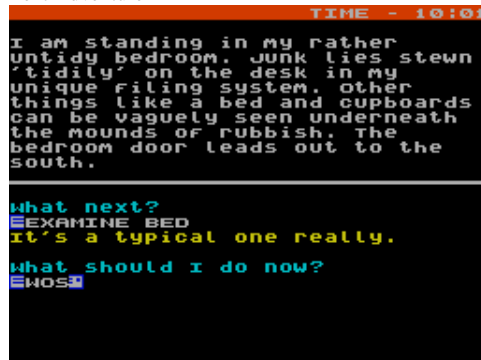

Fischen (Kurt Windolf Westerland,1983)
Simulation

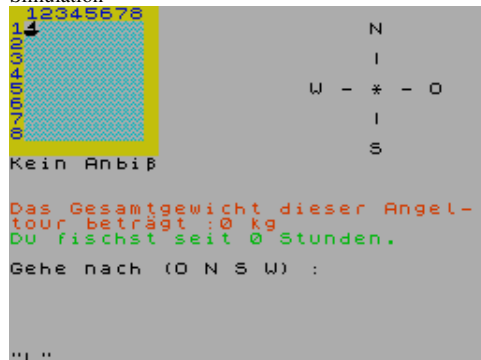

First Class (Gremlin Graphics Software Ltd,1992)
Educational



First Empire (Red Shift Ltd,1984)
Strategy



First Numbers (Collins Educational,1983)
Educational

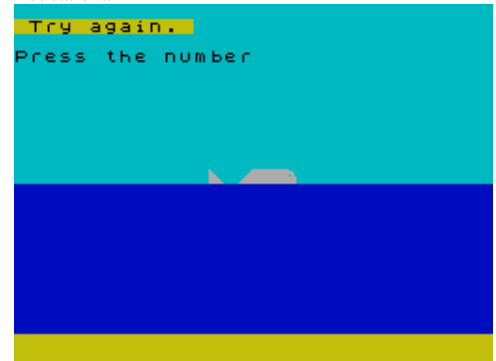

First Slovak Real Demo (7 Gods,1995)
Scene Demo

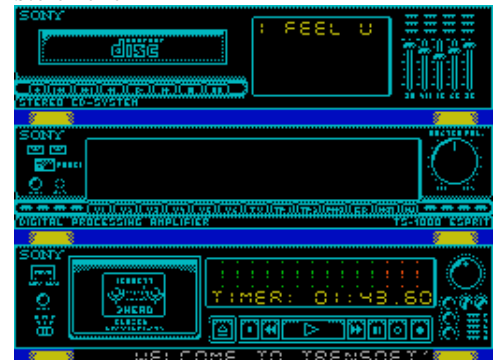

Fish! (Rainbird Software Ltd,1989)
Text Adventure

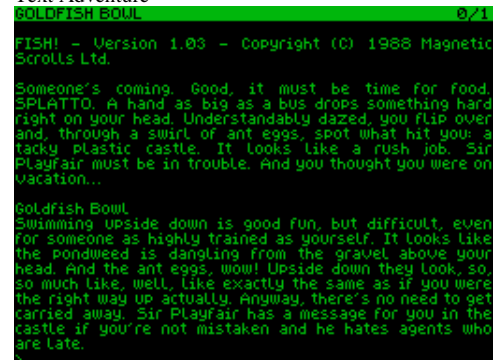

Fisher (A. Vashin,1995)
Arcade

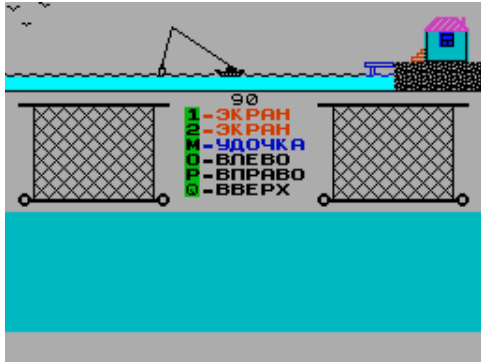

Fisherman Fred (Add-On Electronics Ltd,1983)
Arcade



Fishpaste Volume 2 (FISH,1995)
Compilation



Fistful of Blood Capsules, A (Zodiac Software,1987)
Text Adventure



Fists 'n' Throttles (Elite Systems Ltd,1989)
Compilation



Fisher (Hard Code,1997)
Arcade



Fisherman's Friend (JA Software,1996)
Arcade

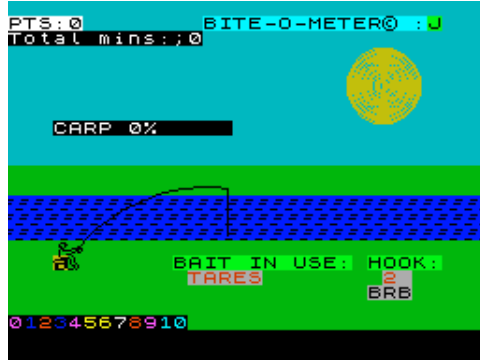

Fishy Business (Salamander Software,1984)
Text Adventure



Fistful of Necronomicons, A (Zenobi Software,1995)
Text Adventure

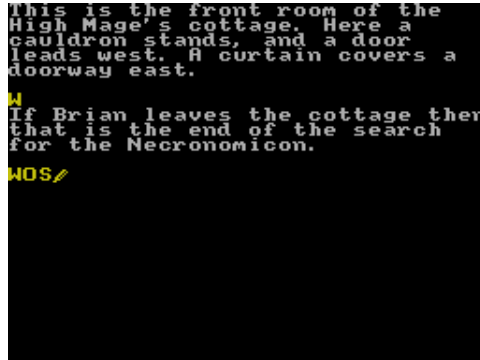

Fists of Fury (Virgin Games Ltd,1991)
Compilation



Fisher King, The (Zenobi Software,1991)
Text Adventure



Fishpaste Volume 1 (FISH,1995)
Compilation



Fishy Dick (Meow Micros,1984)
Arcade



Fist II: The Legend Continues (Melbourne House,1986)
Sport



Five-a-Side Soccer (Mastertronic Ltd.)
Sport



Five Dice (Christopher James Software Ltd,1984)
Board/Card Game

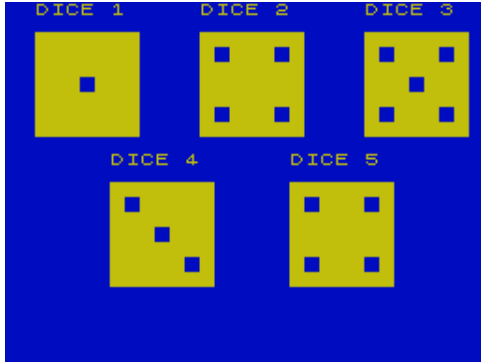

Five Star Games (Beau-Jolly Ltd,1987)
Compilation

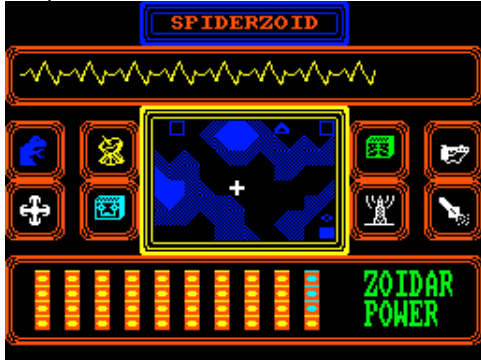

Fiveteens Classic (Dmitriy Zhivilov,2000)
Board/Card Game



Fizzy (Denis Rykov,1997)
Arcade Adventure

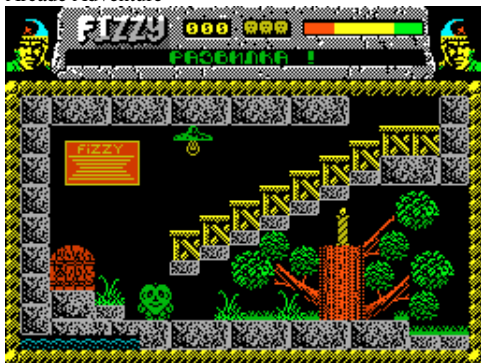

Flak (US Gold Ltd,1984)
Arcade

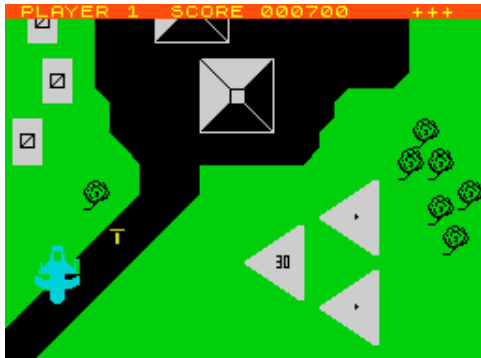

Five Doctors, The (Kevin O'Shea,1986)
Text Adventure

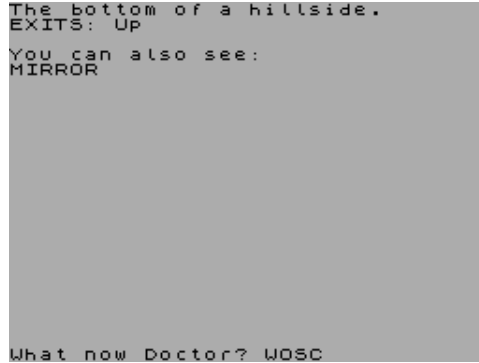

Five Star Games 2 (Beau-Jolly Ltd,1987)
Compilation

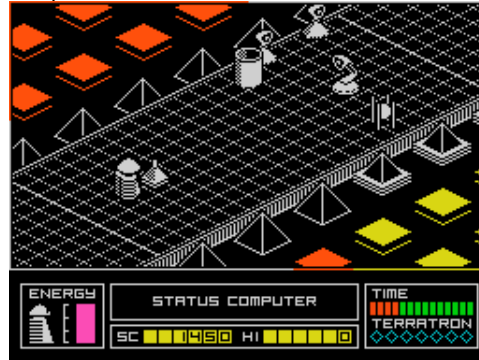

Five Treasures of Ryzar, The (Space Age Software,1984)
Text Adventure

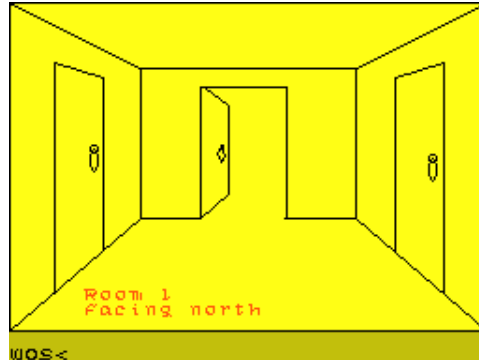

Fizzy Wizzy (ESP Software,1984)
Arcade



Flame 1 (Mat,1990)
Scene Demo



Five Little Ducks (Arrow,1984)
Educational

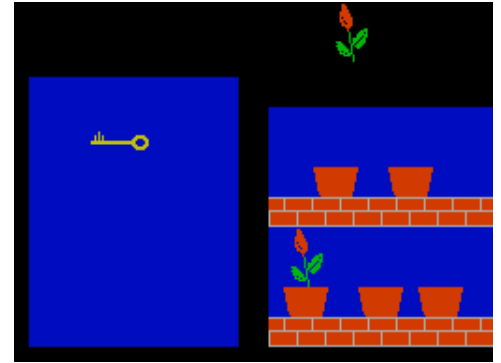

Five Star Games 3 (Beau-Jolly Ltd,1987)
Compilation



Fixsterne (Werner Mueller.)
Utility: Astronomy/Astrology



Flaggen (J. Koellner,1983)
Utility



Flameout (Zenobi Software,1994)
Text Adventure



Flappy (KVL,1990)
Strategy



Flash Gordon (Mastertronic Added Dimension,1987)
Arcade



Flat Season (Bastec Software,1988)
Simulation



Flecht (.)
Utility



FlexiGraf (Saxon Computing,1983)
Utility



Flash Beer (Weird Science Software,2003)
Arcade

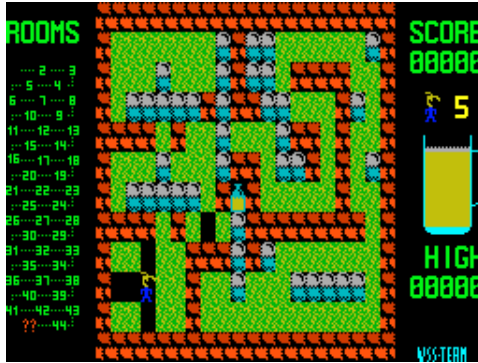

Flashpoint (Ocean Software Ltd,1987)
Arcade

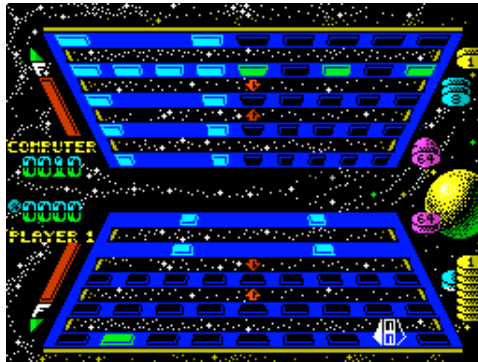

Flea Adventure (Studio 7,1995)
Arcade



Fletcher's Castle (Fernleaf Educational Software,1984)
Educational

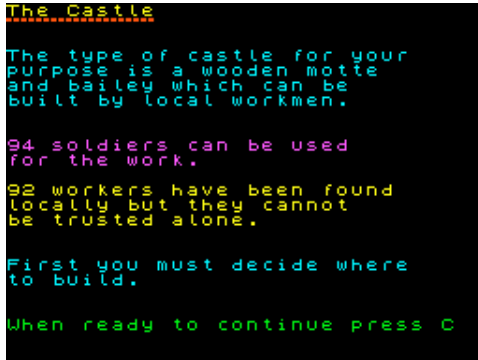

Flexipage 200 (Flexibase Software,1989)
Utility



Flasher (Tony Wye,)
Board/Card Game

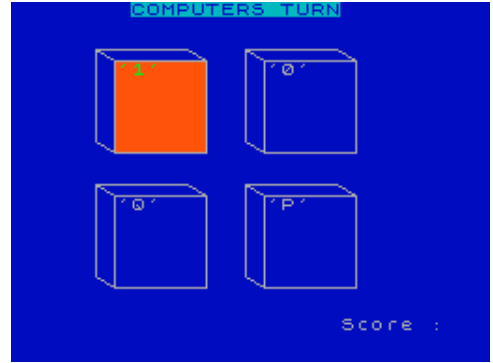

Flash Tracker: Demo Mode (Flash Inc,)
Scene Demo



Flecha Intrepida, La (MicroHobby,1985)
Board/Card Game



FlexiCalc (Saxon Computing,1983)
Utility

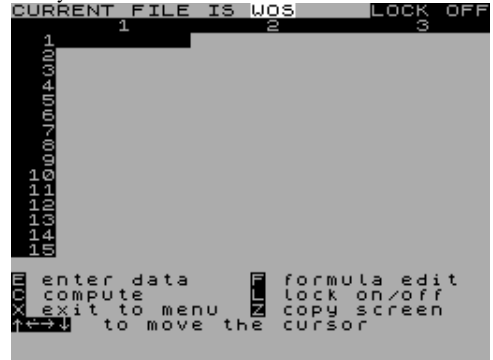

Flexitext (,1985)
Utility: Screen Manipulation

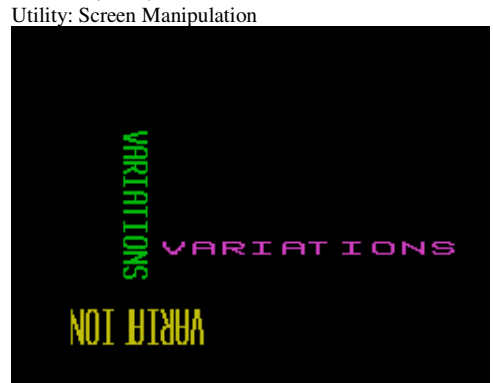

Flight 191 (Northern Underground,1990)
Text Adventure

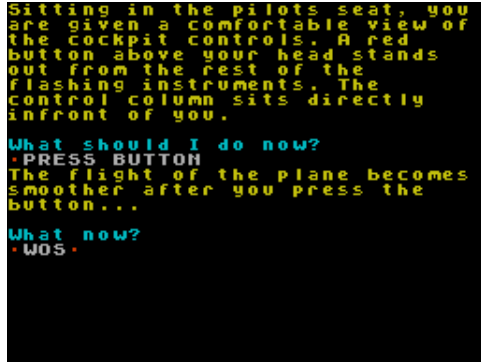

Flight Ace (Gremlin Graphics Software Ltd,1989)
Compilation

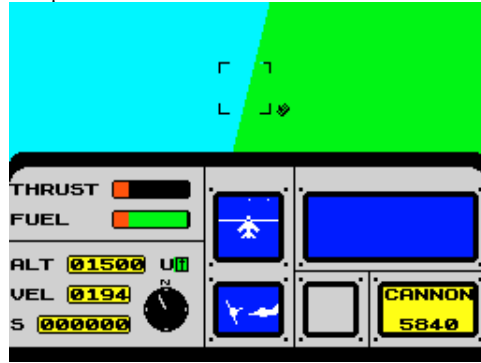

Flight from the Dark (Hutchinson Computer Publishing,1984)
Text Adventure



Flight Master (B.O.S.S.,1983)
Arcade



Flight Path 737 (Anirog Software,1985)
Simulation



Flight Simulation (Sinclair Research Ltd,1983)
Simulation

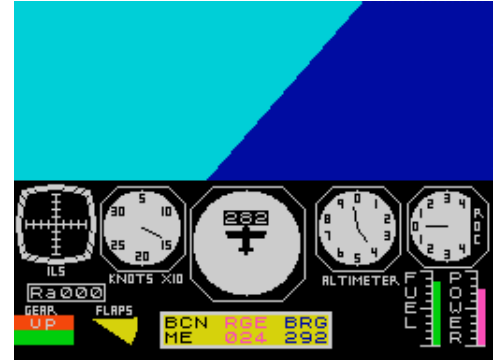

Flight Simulator (Artic Computing Ltd,1983)
Simulation

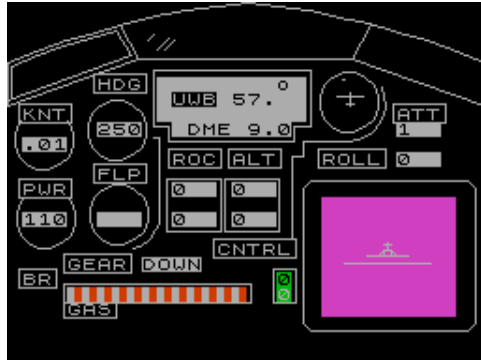

Flightsimulator (Graffiti Software,)
Simulation



Flights of Fantasy Vol 1 (The Guild,)
Compilation

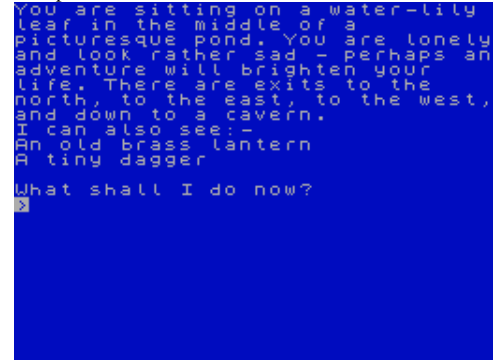

Flights of Fantasy Vol 2 (The Guild,)
Compilation

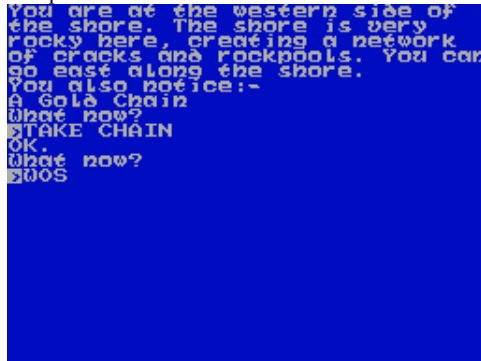

Flimbo's Quest (System 3 Software Ltd,)
Text Adventure



Flintstones, The (Grandslam Entertainments Ltd,1988)
Arcade



Flip Flap (Software Super Savers Ltd,1984)
Arcade

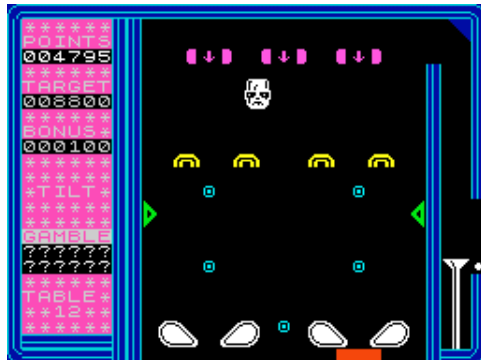

Flipi (Wr. Agostini,1984)
Arcade

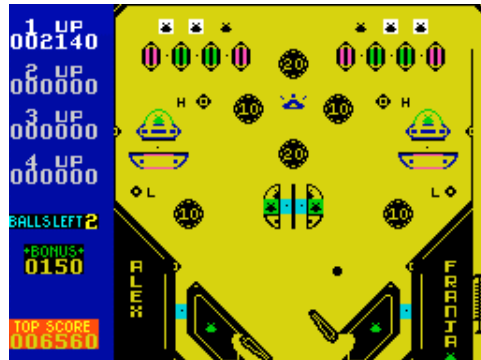

Flip It (Mikropol,1991)
Board/Card Game

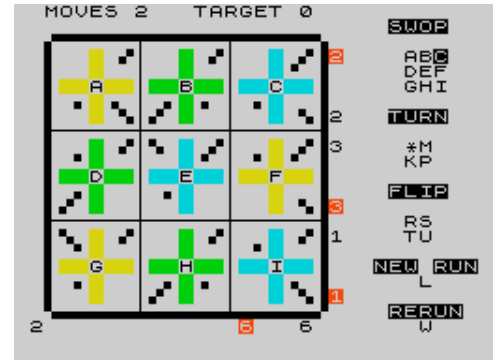

Flipper (Wicosoft,1983)
Arcade



Flite (Sinclair Programs,1984)
Arcade

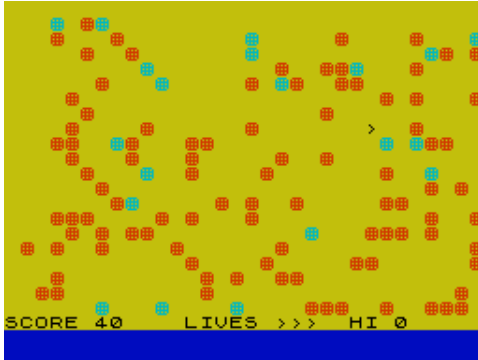

Floating Point Forth - Game Editor (CP Software,)
Arcade Game Development Tool



Flucht (P.W. Software,1983)
Arcade

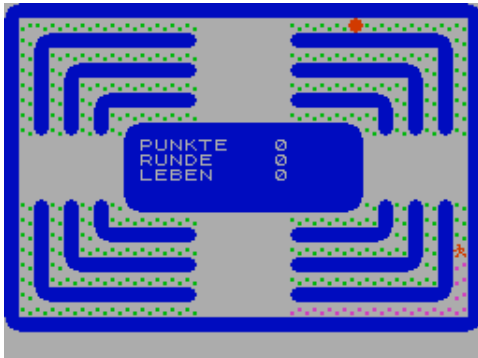

Flush Gordon (Creative Juices,1988)
Text Adventure

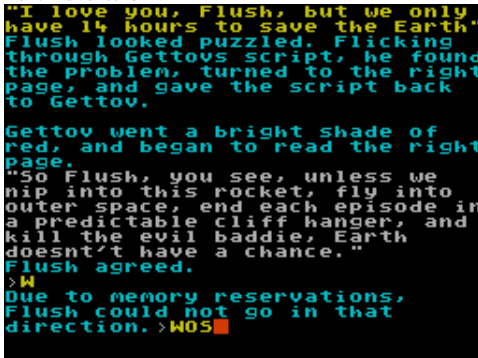

Flippit (Sinclair Research Ltd,1983)
Board/Card Game



Flix (Softricks,1984)
Board/Card Game



Flow (Scisoft,)
Educational

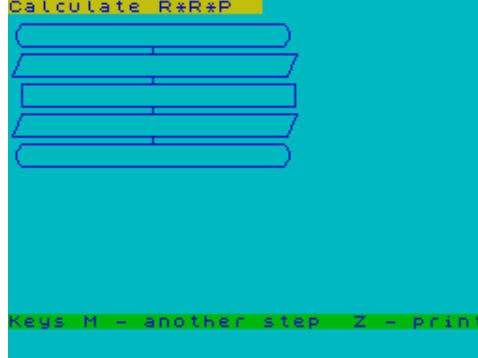

Flucht aus der Pyramide (Bakersoft,)
Arcade

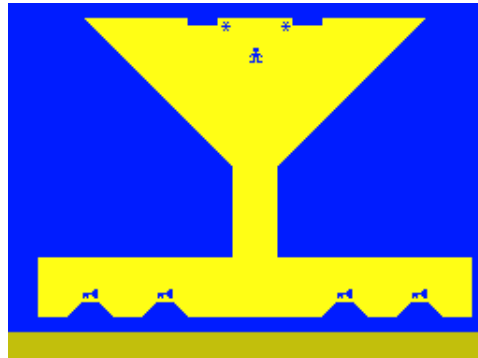

Flux (Krypton Force,1984)
Arcade



Flipwind (Anco Software Ltd,1984)
Simulation

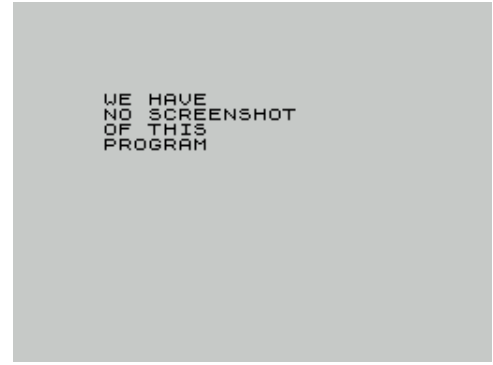

Floarea Soarelui (ZXIF,2006)
Text Adventure



FLP 18 (Gambler,1996)
Scene Demo



Flunky (Piranha,1987)
Arcade Adventure



Flyer Fox (Bug-Byte Software Ltd,1986)
Arcade



Flying Formula, The (ZX Computing,1986)

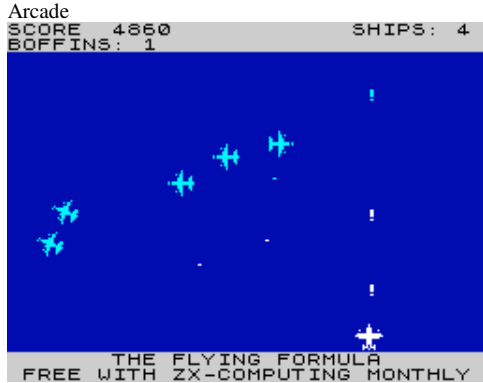

Flying Train (Random Records,1983)



Follow Me (Prospect Software,1990)

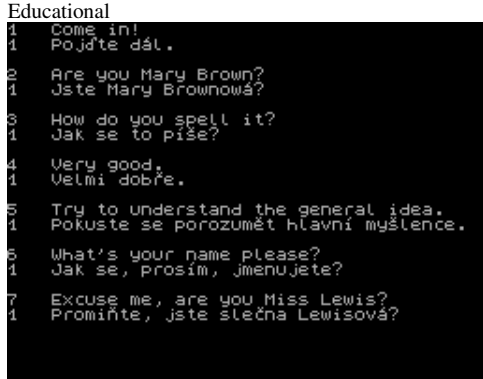

Fontanero, El (MicroHobby,1986)



Font Editor & Script Designer (R.D. Foord Software,1985)



Flying Scotsman (Dee-Kay Systems,1984)

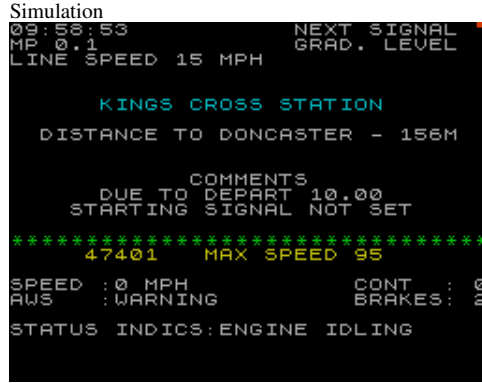

Fly, The (Agent-X,)

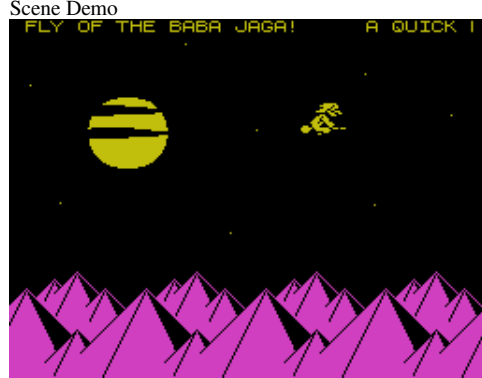

Fomalhaut (MicroHobby,1986)

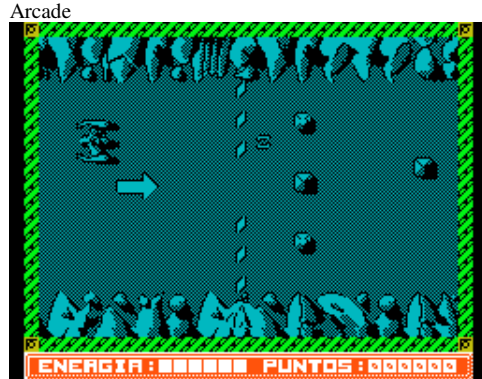

Font Creator (Simon Kimberley,1987)



Fontograph (Soft 2000,1986)

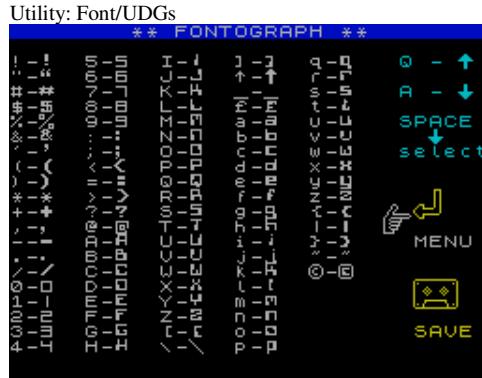

Flying Shark (Firebird Software Ltd,1987)



Focus (16/48 Tape Magazine,1985)

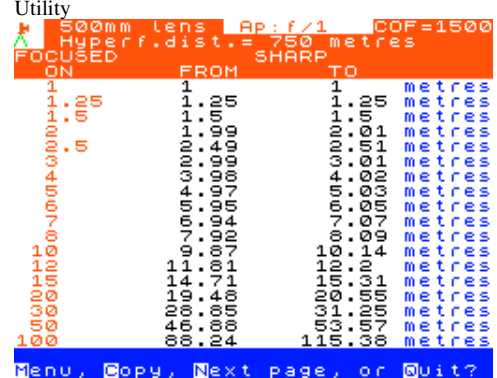

Font (Alesoft)



Font Creator (Sinclair User,1992)

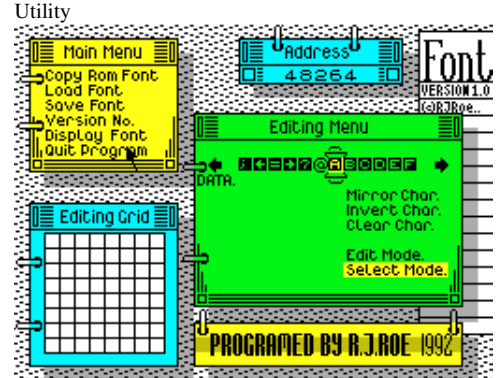

Fonts (Alan Grier,1986)



Fonty el Fontanero (MicroHobby,1986)
Arcade



Football Boxform (Boxoft,1988)
Simulation

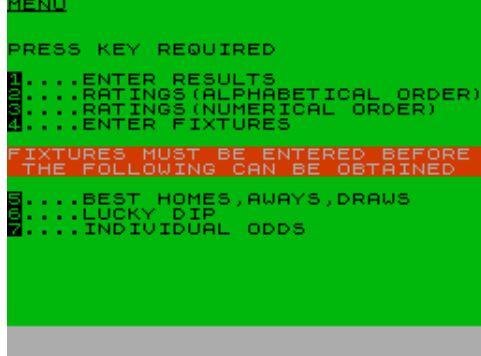

Football Director (D&H Games,1986)
Simulation



Football Director II (D&H Games,1987)
Simulation

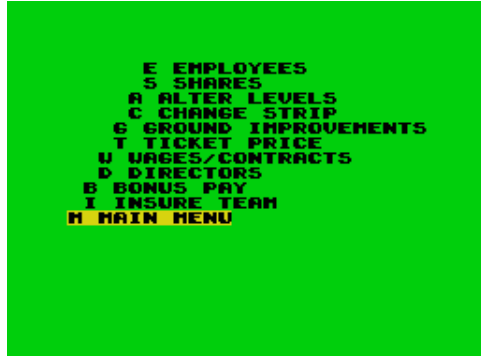

Footballer, The (Cult Games,1989)
Simulation



Football (Wintersoft,1982)
Simulation



Football Champions (Cult Games,1990)
Simulation



Football Director: 2 Player Super League (D&H Games,1986)
Simulation



Footballer of the Year (Gremlin Graphics Software Ltd,1986) Sport



Football Fever (Tanglewood Software,1986)
Simulation

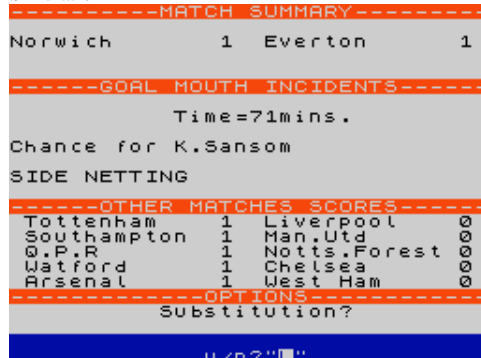

Football Analysis (Holly Products,1982)
Simulation



Football Club (Frozen Ice,1989)
Simulation



Football Director: 2 Player Super League - Records File (D&H Games,1986) Simulation



Footballer of the Year 2 (Gremlin Graphics Software Ltd,1987) Sport



Football Follower (Selec Software,1988)
Utility

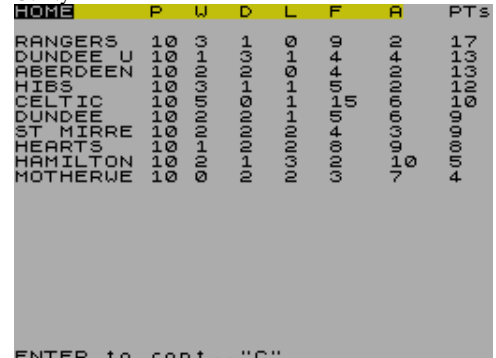

Football Forecast (Kuma Computers Ltd,1983)
Simulation

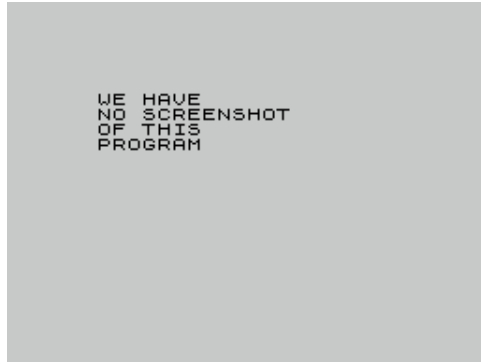

Football Frenzy (Alternative Software Ltd,1987)
Text Adventure



Football Glory (Megaspertz,1992)
Strategy



Football Glory (Redwood Designs,1991)
Strategy

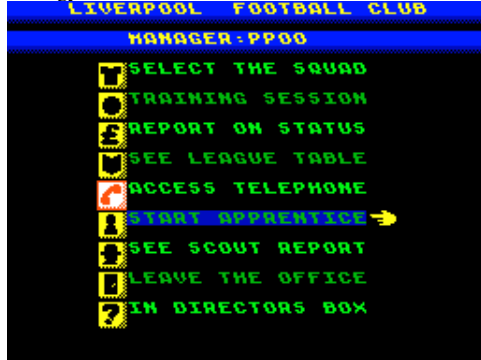

Football League Analysis (Digital Integration,1983)
Simulation

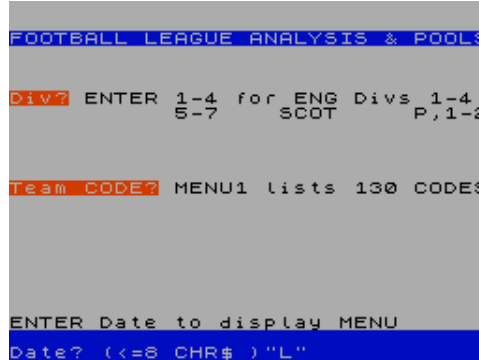

Football Manager (Addictive Games Ltd,1982)
Sport

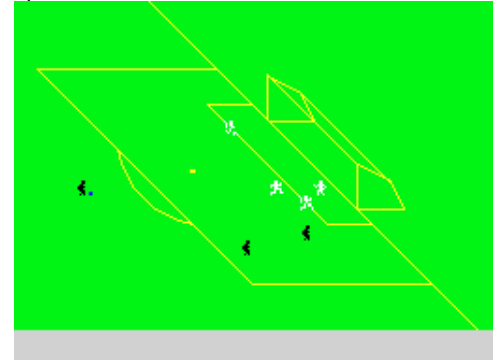

Football Manager + Penetrator (Microbyte Software [2],) Compilation

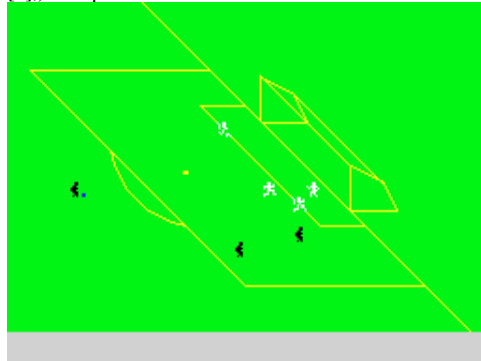

Football Manager: World Cup Edition (Addictive Games Ltd,1990) Simulation



Football Manager 2 (Addictive Games Ltd,1988)
Simulation

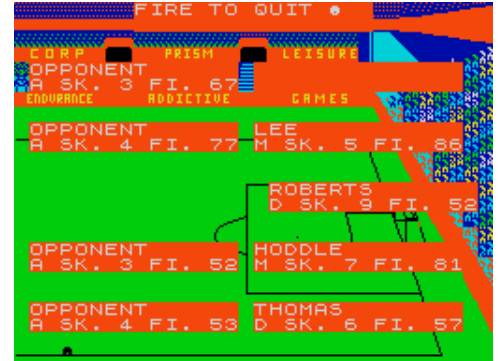

Football Manager 2 + FM2 Expansion Kit (Addictive Games Ltd,1989) Compilation

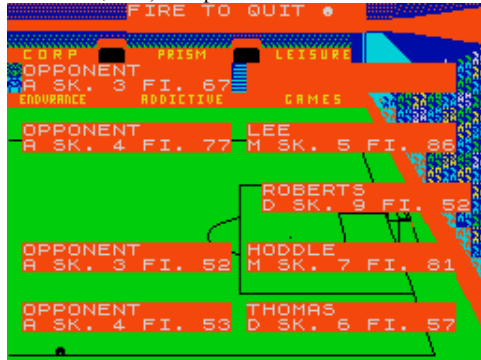

Football Manager 2 Expansion Kit (Addictive Games Ltd,1989) Simulation



Football Manager 3 (Addictive Games Ltd,1991)
Simulation

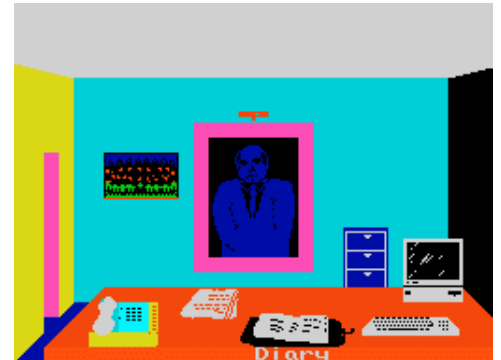

Football Pools (Hartland Software,1983)
Sport

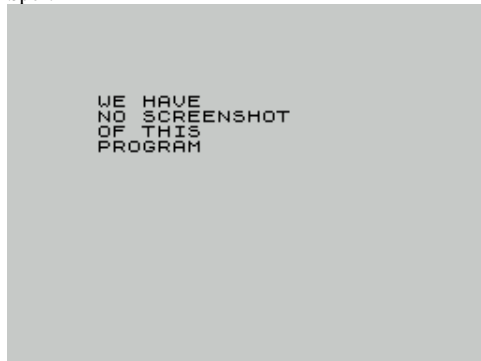

Football Results Forecasting (Butronics Co,1984)
Simulation



For Alex (Flash Inc.)
Scene Demo



Forastero, El (Grupo Creators Union,1990)
Text Adventure



Forbidden Planet (Design Design Software,1986)
Arcade



Force, The (Argus Press Software Ltd,1985)
Strategy



Forest at World's End (Interceptor Micros Software,1984)
Text Adventure

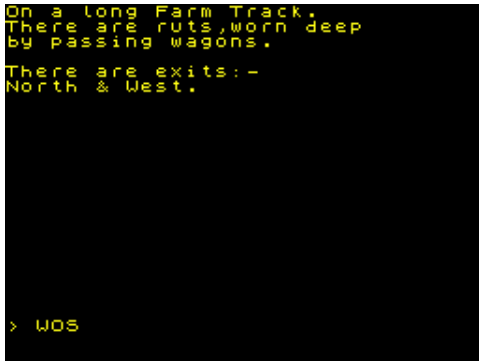

For Gold or Glory (Alternative Software Ltd,1988)
Text Adventure



Forbidden Fruit (Tansoft,1985)
Arcade

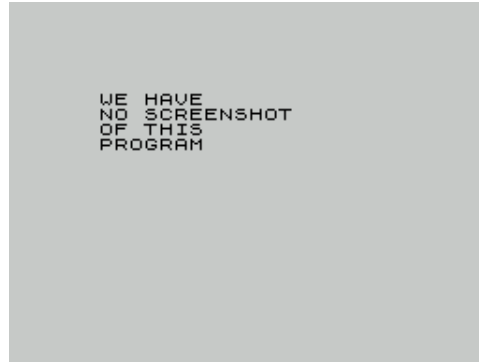

Force ... Beyond, The (Anik Microsystems,1984)
Arcade



Forecaster (Collins Educational,1985)
Utility



Forest of Doom, The (Puffin Books,1984)
Arcade Adventure



Forgotten City (H.A.W.K. Adventuring,1987)
Text Adventure



Forbidden Lands (Alien Software,1993)
Text Adventure



Force Fighter (Perfection Software,1984)
Arcade



Forensic (John McMullan,1983)
Simulation

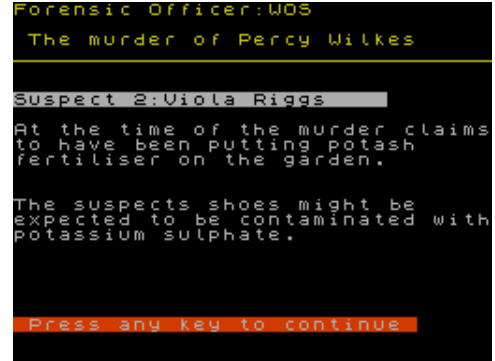

Forest, The (Phipps Associates,1983)
Simulation



Forgotten Island (Fantasy Software [2],1989)
Text Adventure



Forgotten Past, The (Trevor Whitsey,1987)

Text Adventure

```

You find yourself on a
spacious, sandy beach running
east to west. Waves crash onto
the shore to the north, breaking
the silence rather abruptly,
although it cannot get rid of
your lonely feeling. Dunes pile
up to the south. Exits: West and
East. You can also see a shovel,
a map
What now?
What now?
What now?w
You are close to the west end
of the beach, as you can see
some bleak, dull rocks towering
west of you. They're still some
way off though. As well as this,
cliffs tower to the south,
opposite the sea that's
sparkling in the sun. Exits:
West and East. You can also see
a sea shell
What now?WOS

```

Format 64 in Line (Megasoft [3],1985)

Utility: Font/UDGs

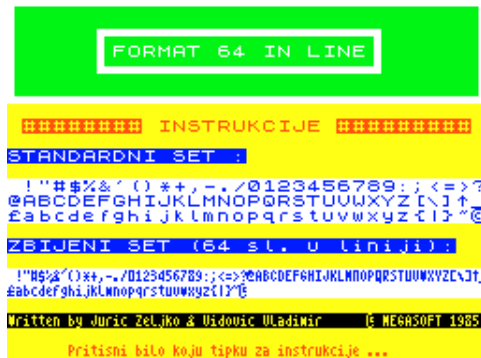

Formula (MicroHobby,1985)

Arcade



Formula One (CRL Group PLC,1985)

Simulation



Fornax (Gargoyle Games,)

Arcade Adventure



Forgotten Worlds (US Gold Ltd,1989)

Arcade

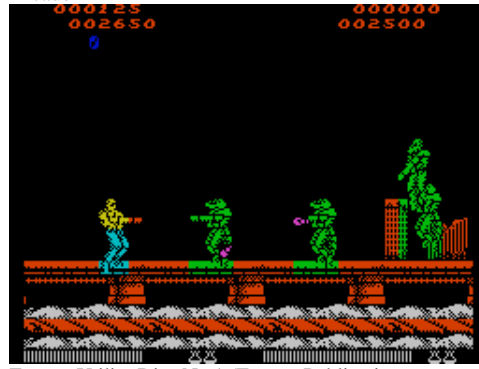

Format Utility Disc No.1 (Format Publications Software,)

Utility



Formulation (Ventamatic,1986)

Utility



Formula One (Spirit Software,1984)

Arcade



For Peace in Yugoslavia (,)

Scene Demo



Format 42 (Stuart Licholls,1982)

Utility: Word Processor

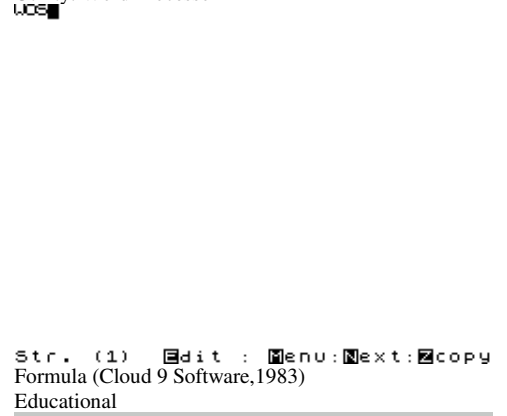

Formulae and Compounds (Griffin Software,1984)

Educational

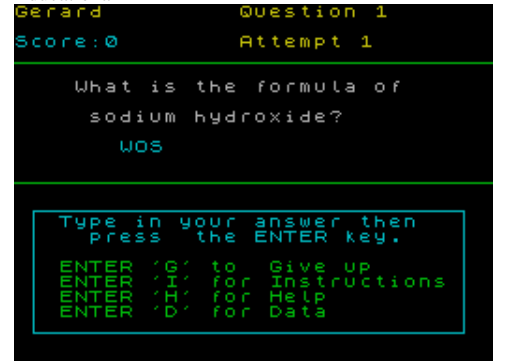

Formula One Editor (BadBeard,2004)

Arcade Game Development Tool

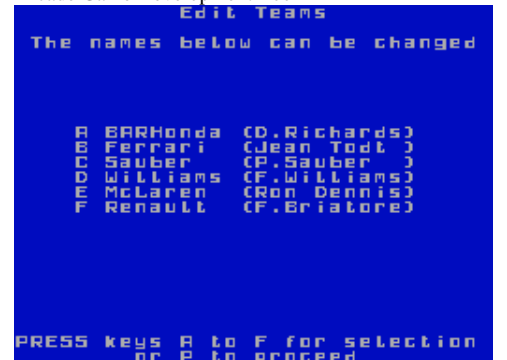

For Pete's Sake (Zenobi Software,1993)

Text Adventure



Fort Apache (Contrast Software,1984)
Strategy



Fort Apocalypse (US Gold Ltd.)
Arcade



Forth (Abersoft,1983)
Utility: Programming

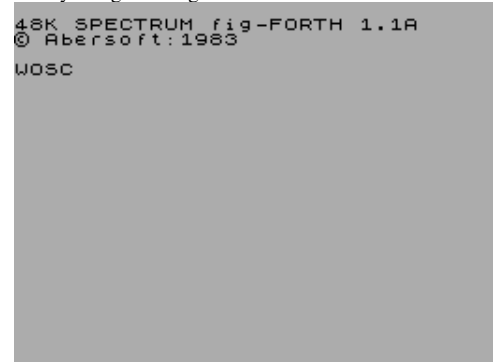

Forth (GCE Tutoring,1984)
Educational



Forth (Your Computer,1985)
Utility: Programming

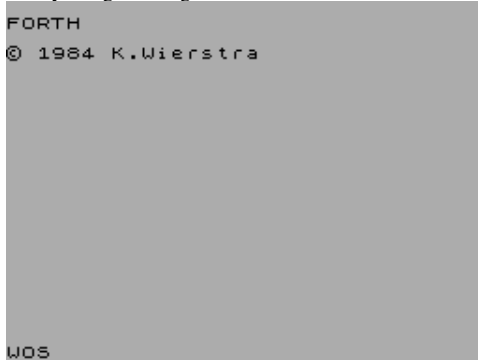

For the United Minds (Yolpa Brothers
Productions,1995)
Scene Demo



Forth Simulator (Spectrum Computing,1985)
Utility: Programming



FORTH Stack Simulator (Bernard Babani
Publishing,1984)
Utility: Programming

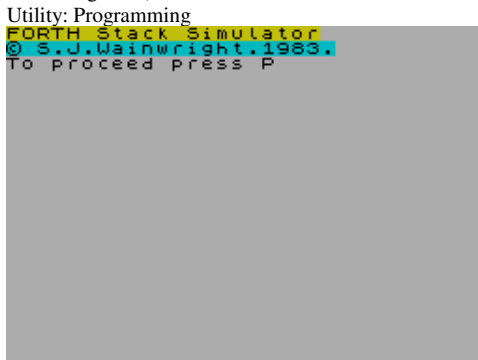

Fortress of Keler (Hamster Software,1985)
Text Adventure

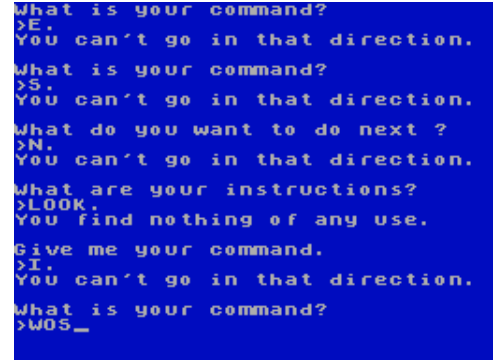

For Your Thighs Only (Zodiac Software,1987)
Text Adventure



Found Yet Another Big Disk (Zenobi Software,)
Compilation

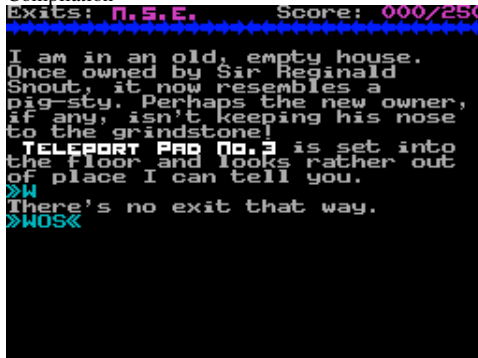

Fountain PD Newsletter 2 (Fountain PD,1996)
Simulation



Four Bat Blip (,1989)
Arcade



Four Eyed Bandit (Spectrum Computing,1983)
Simulation



Four Great Games Volume 1 (Micro Value,1988)
Compilation

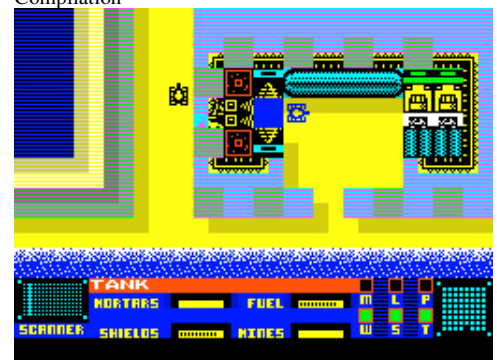

Four Great Games Volume 2 (Micro Value,1988)
Compilation



Four Minutes to Midnight (8th Day Software,1985)
Text Adventure



Four Symbols, The (FSF Adventures,1993)
Text Adventure



Fox Hunt (Sirius Group,1994)
Board/Card Game



Frac (Melbourne House,)
Arcade



Four Great Games Volume 3 (Micro Value,1988)
Compilation



Fourmost Adventures (Global Software,1986)
Compilation



Fourth Dimension, The (Laurence Creighton,1989)
Text Adventure

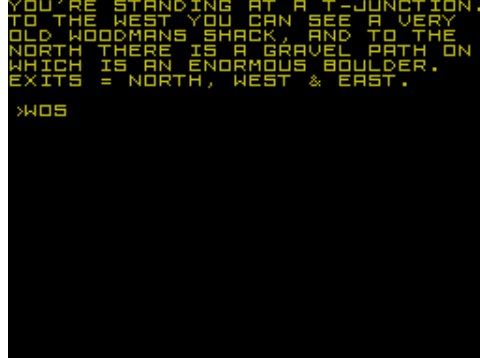

Foxx Fights Back (Image Works,1988)
Arcade



Fraciones Parciales (MicroHobby,1985)
Utility: Mathematics



Four Minutes from Glory (Lambourne Games,1993)
Strategy

TRAINING			
RUNNER	NAT	FL	TRAINING
1. ABASCAL	(SPA)	0	INTENSIVE
2. ANDERSSON	(SWE)	4	INTENSIVE
3. AOUTTA	(MOR)	1	INTENSIVE
4. BANNISTER	(GBR)	0	INTENSIVE
5. BAUMANN	(FRG)	0	INTENSIVE
6. BAYI	(TAN)	0	INTENSIVE
7. BILE	(SOM)	4	INTENSIVE
8. BOIT	(KEN)	0	INTENSIVE
9. BUSSE	(GDR)	0	INTENSIVE
10. CACHO	(SPA)	0	INTENSIVE
11. CHERUIYOT	(KEN)	0	INTENSIVE
12. COE	(GBR)	1	INTENSIVE
13. COGHLAN	(IRL)	7	INTENSIVE
14. CRAM	(GBR)	0	INTENSIVE
15. DELANEY	(IRL)	0	INTENSIVE
16. DELEZE	(SWZ)	3	INTENSIVE

Four Rules, The (Micromasters,1982)
Educational

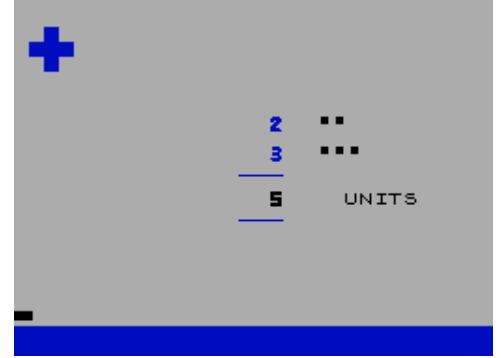

Fourth Protocol, The (Hutchinson Computer Publishing,1985)
Strategy

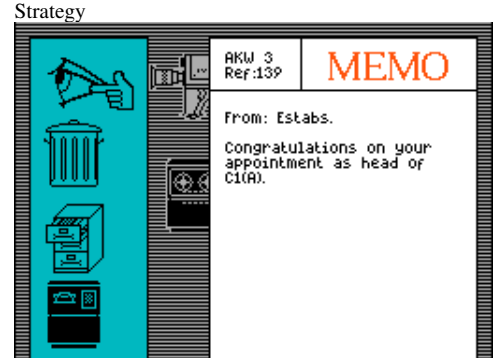

FP 50 Forth (Mike Hampson,1983)
Utility: Programming

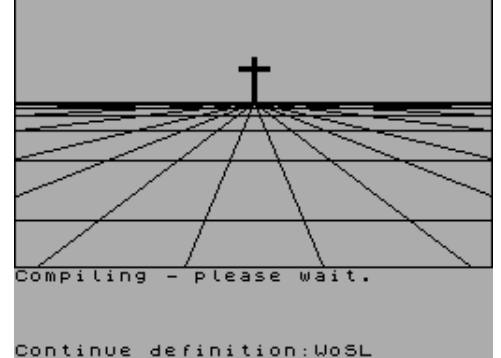

Fractal Collection, The (Daniel Sheridan,1992)
Compilation



Fractals (James Cox,1989)
Utility: Screen Manipulation

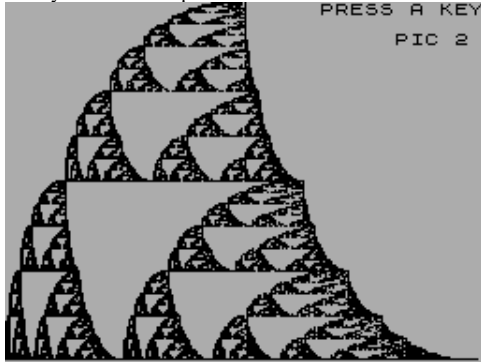

Fractions 2 (Kemsoft,1983)
Educational



Frank Bruno's Boxing + Airwolf + Boxeadores Frank Bruno (MCM Software S.A.,1989) Compilation

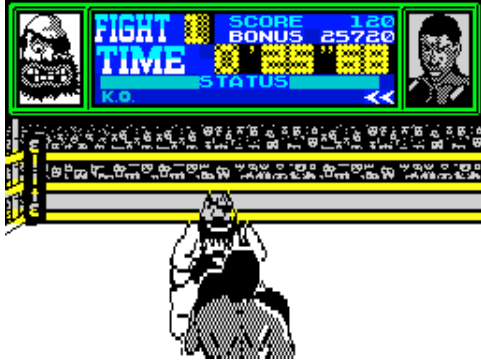

Frankenstein Jnr (Cartoon Time,1990)
Arcade

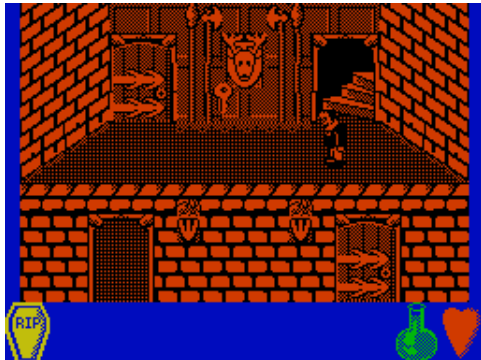

Frank Frazetta Demo 3 (Rafii Soft,1990)
Scene Demo



Fraction Fever (Spinnaker Software Corporation,1984)
Educational

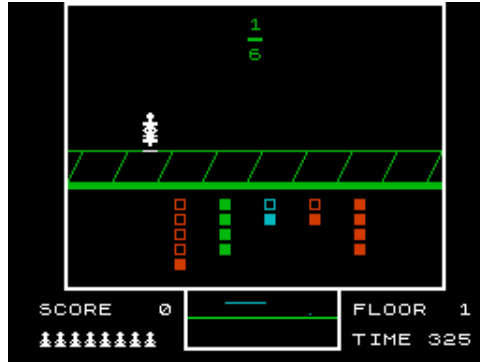

Frank Bruno's Big Box (Elite Systems Ltd,1989)
Compilation

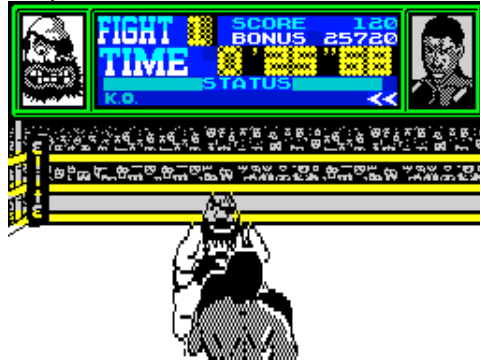

Frankenstein (CRL Group PLC,1987)
Text Adventure

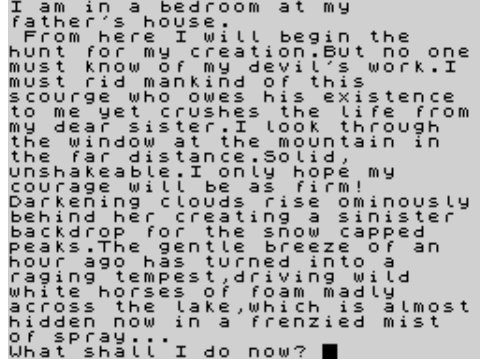

Frank Frazetta Demo 1 (Rafii Soft,1989)
Scene Demo



Frankie (MicroHobby,1989)
Arcade

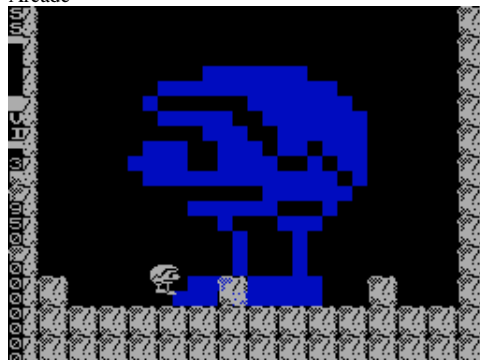

Fractions 1 (Kemsoft,1983)
Educational

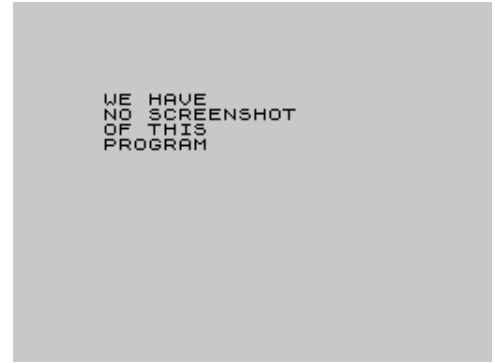

Frank Bruno's Boxing (Elite Systems Ltd,1985)
Sport

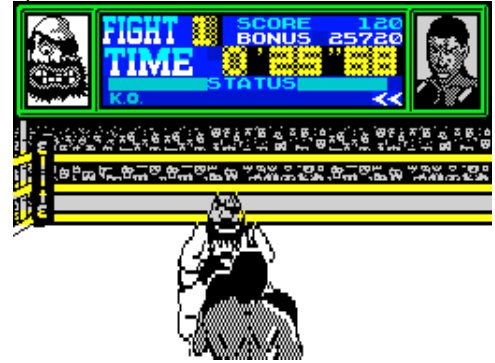

Frankenstein 2000 (Icon Software Ltd,1985)
Arcade



Frank Frazetta Demo 2 (Rafii Soft,1990)
Scene Demo



Frankie Goes to Hollywood (Ocean Software Ltd,1985)
Arcade Adventure



Franklin's Tomb (Salamander Software,1984)
Text Adventure

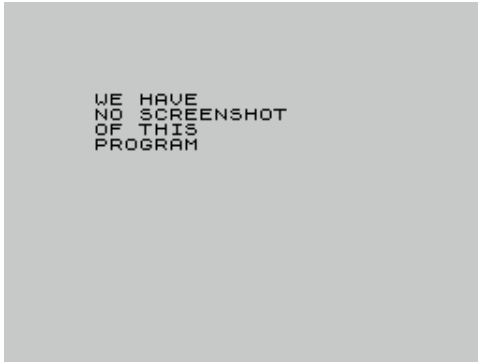

Frank (.)
Simulation

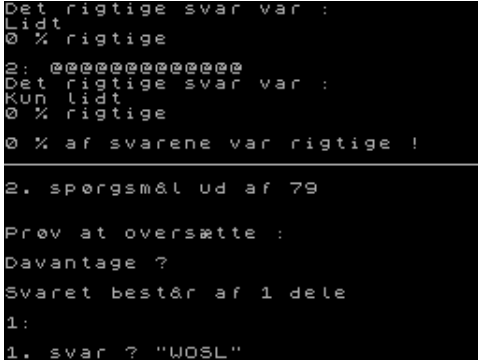

Freak (MicroHobby,1986)
Arcade



Fred (Indescomp S.A.,1983)
Arcade

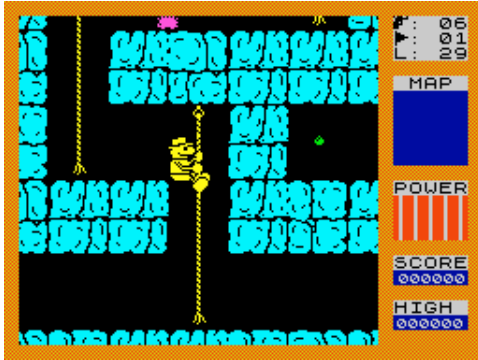

Freddy Kruger Live (Freddy Soft,1993)
Arcade Adventure

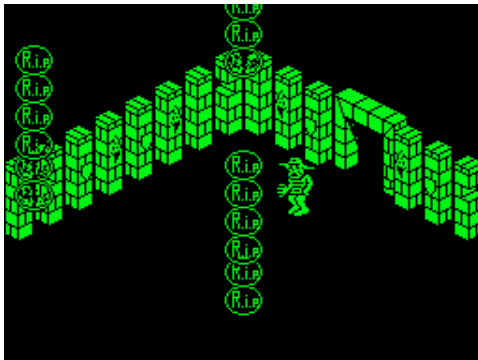

Frank N Stein (PSS,1984)
Arcade



Frantic (Imagine Software Ltd.)
Arcade

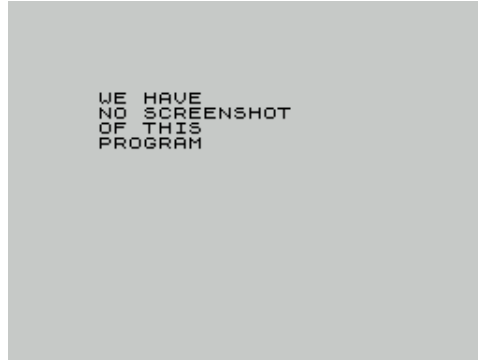

Freaky Footy (Psychaedelic Hedgehog Software,1992)
Simulation



Freddy Hardest (Dinamic Software,1987)
Arcade



Fred's Fan Factory (Software Super Savers Ltd,1984)
Arcade

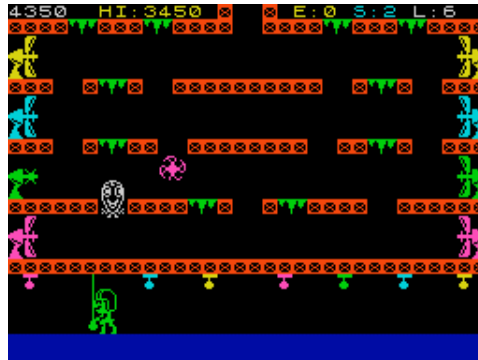

Frank the Flea (Megasoft [1],1986)
Arcade Adventure

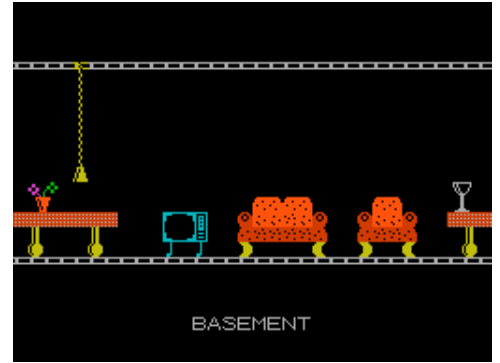

Freak (L. Martschin,1986)
Text Adventure



Frecuencimetro Digital (MicroHobby,1985)
Utility



Freddy Hardest en Manhattan Sur (Dinamic Software,1989)
Arcade



Fredy (Grupo de Trabajo Software S.A.,1987)
Arcade



Free Cell (Free Group,1998)
Board/Card Game

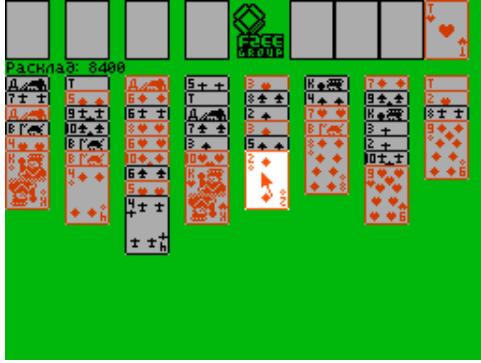

Freedom Fighter (The Power House,1988)
Arcade



Freex (Software Super Savers Ltd,1984)
Arcade

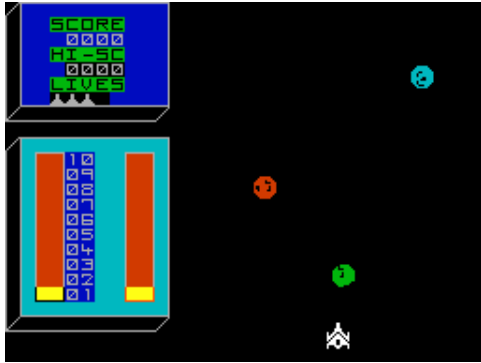

French (AVC Software,1982)
Educational

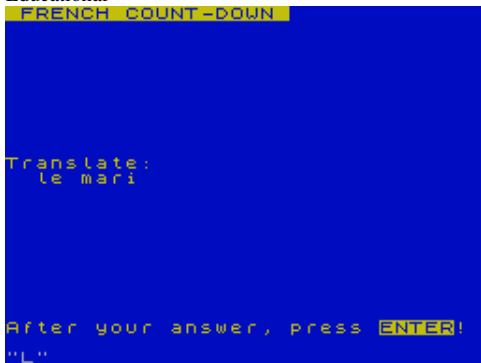

French (Longman Software,1985)
Educational



Free Climbing (Zafiro Software Division,1988)
Arcade

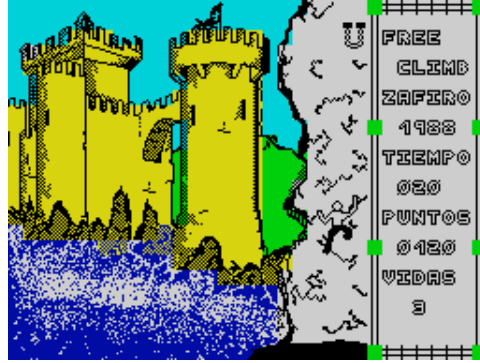

Free Sample Programs (Richard Francis
Altwasser,1982)
Compilation



Freez'Bees (Silversoft Ltd,1984)
Arcade

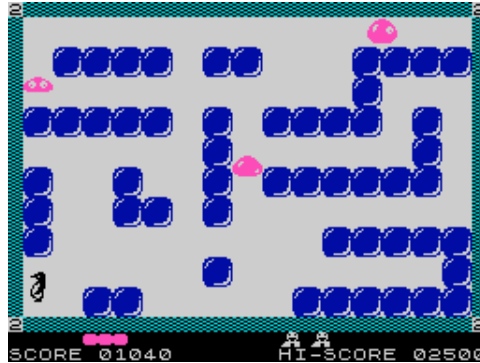

French (Disney Software,1987)
Educational



French Crosswords (AVP Computing,1986)
Educational

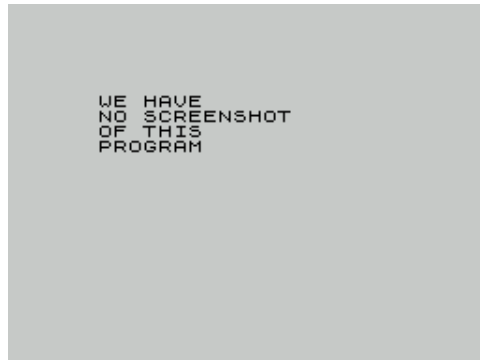

Free Copy (Hajasoft,1985)
Utility: Copier



Free Text Database (Roybot,1986)
Utility



Frekvencna Distribucija (Rolando Horvat,1986)
Utility: Mathematics



French (Hill MacGibbon,1986)
Educational



French Dictation (AVP Computing,1986)
Educational



French is Fun (CDS Microsystems,1983)

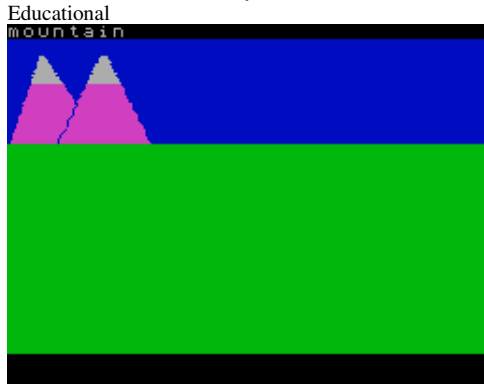

French Listening Comprehension (Softlee Systems,1985)

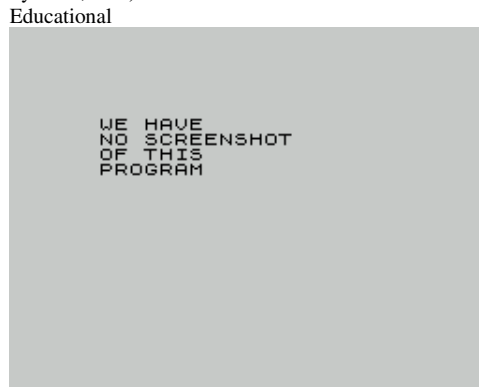

French Mistress, The (Kosmos Software Ltd.)
Compilation



French Mistress, The: Level A (Kosmos Software Ltd,1984)



French Mistress, The: Level B (Kosmos Software Ltd,1984)



French Verbs (Softhouse Ltd,1989)

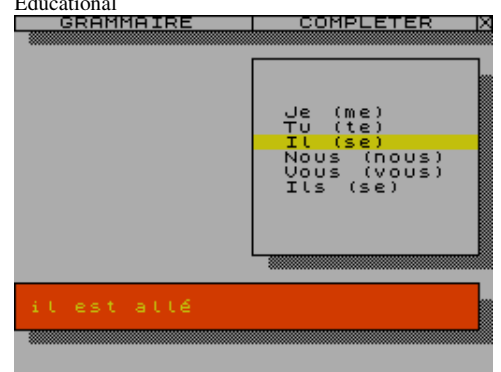

Frenzy (Quicksilver Ltd,1982)

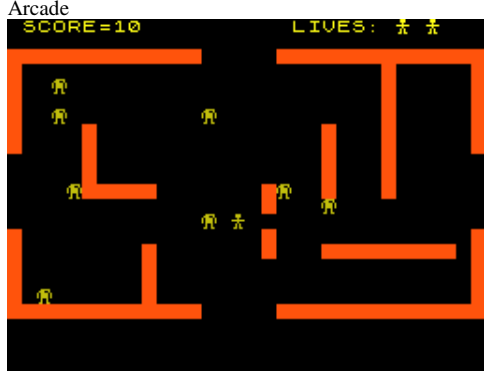

Frenzy (Spectrum Games Ltd,1983)



Freq File (OVV Rack,1984)



Frequenz Analyse (Oliver Wallner,1984)

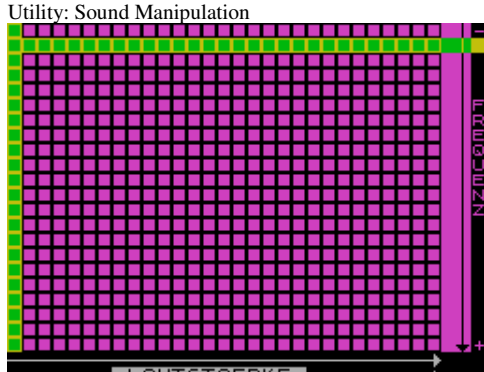

Friday the 13th (Domark Ltd,1986)

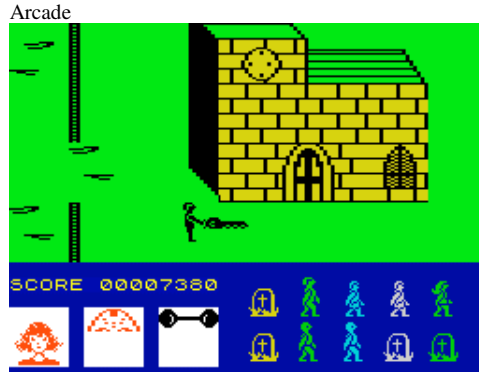

Fridge Frenzy (Bug-Byte Software Ltd,1985)



Friendly Face (Monitor,1984)



Friend or Foe (Hill MacGibbon,1985)



Frightened Fantasy (Dented Designs,1987)



Frightful (Zigurat Software/NF Stars,1989)
Arcade

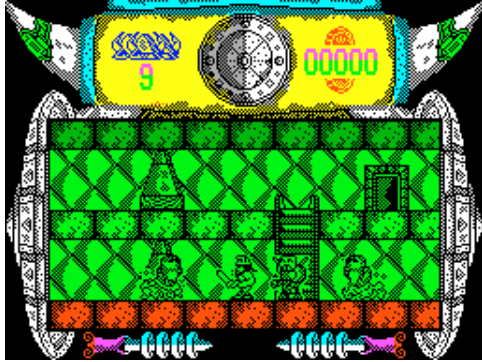

Frog 5 (Artic Computing Ltd,1983)
Arcade

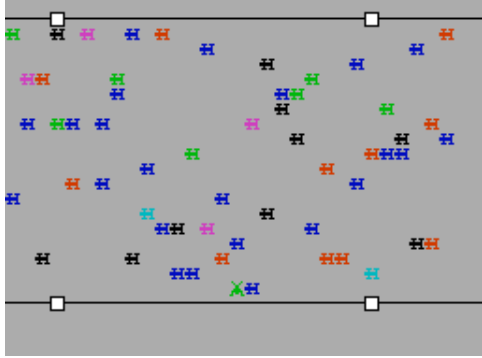

Frog Adventure (Automata UK Ltd,1996)
Text Adventure



Frogger (Astro Software,1983)
Arcade



Frogger (Rabbit Software Ltd,1983)
Arcade

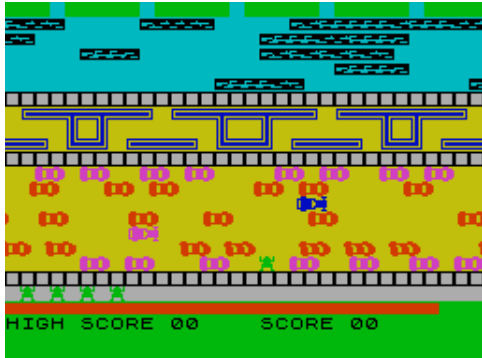

Frightmare (Cascade Games Ltd,1988)
Arcade



Frog 5 + Showdown (Artic Computing Ltd,1983)
Compilation

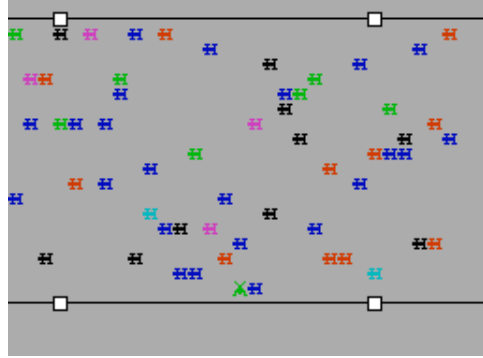

Frogger (.)
Arcade



Frogger (C-Tech,1982)
Arcade

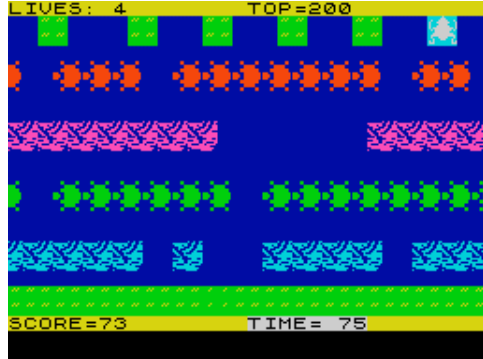

Frogger (Sinclair Programs,1983)
Arcade

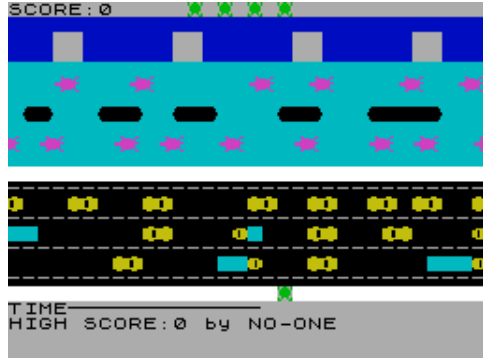

Frodo (Spiridonenko MV,1994)
Arcade

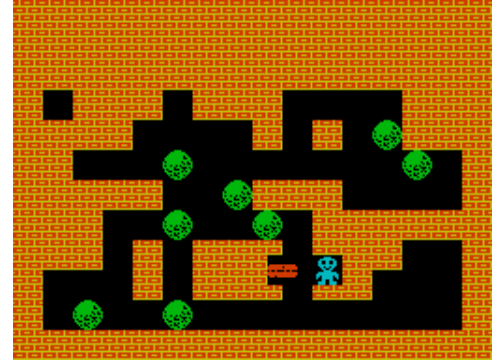

Frog Face (Positive Image,1984)
Text Adventure



Frogger (A'n'F Software,1983)
Arcade

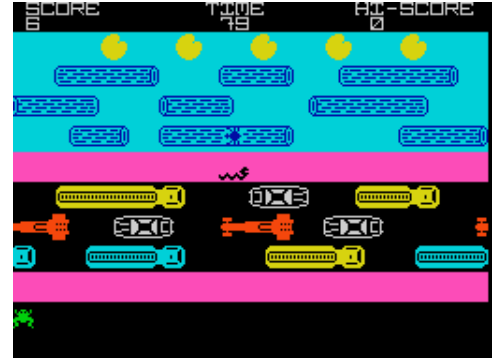

Frogger (MicroHobby,1985)
Arcade



Frogger (ZX-Power,1983)
Arcade



Frogger + Crazy Chef (Astro Software,1983)
Compilation

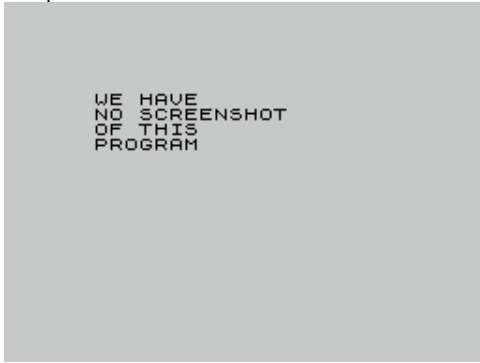

Froggy (DJL Software Ltd,1983)

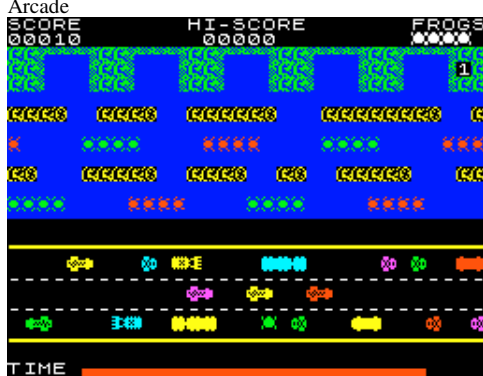

Frog Hopper (Walltone Software,)



Frog Run (Anirog Software,1984)

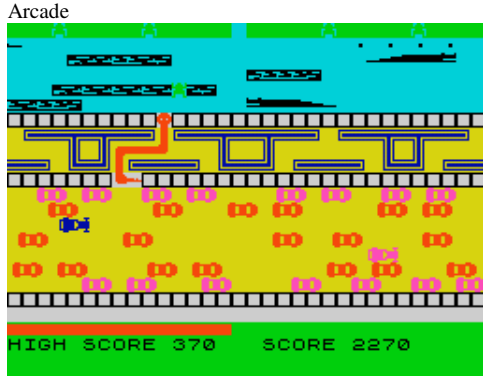

From Beyond (Sleepwalkers,1997)
Arcade Adventure



Frogger + Specman (C-Tech,1982)
Compilation

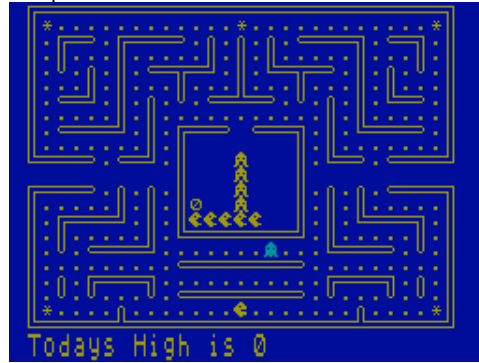

Froggy (Starsoft,1984)



Frog Hopper + Codename Mat (Dixons,1984)

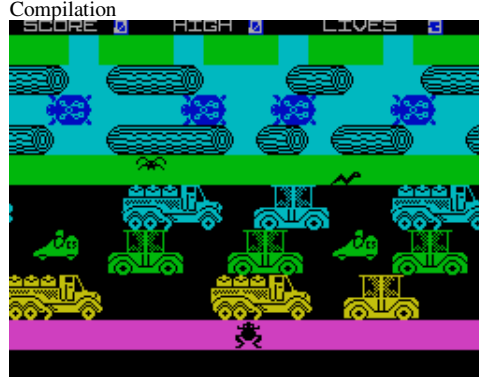

Frog Shooter (Kuma Computers Ltd,1984)



From Out of a Dark Night Sky (Zenobi Software,1989)
Text Adventure



Frogger 81 (Russell Marks,1997)
Arcade

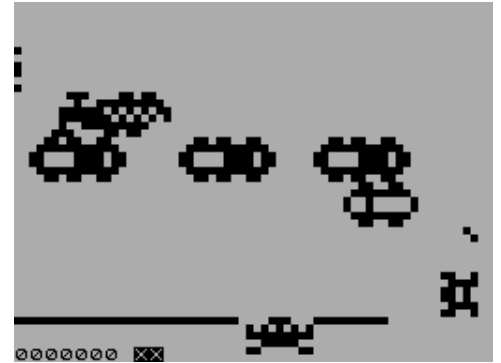

Froggy + Z-Man (DJL Software Ltd,1983)

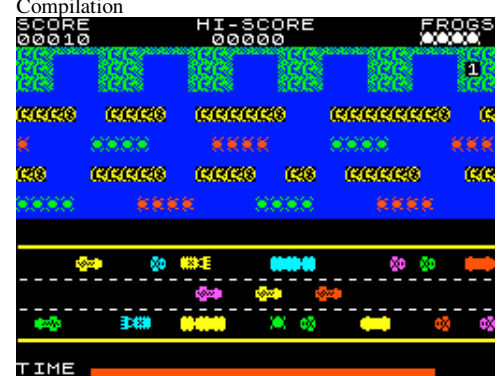

Froglets (Cascade Games Ltd,1984)



Frogs in Space (Merlin Software [1],1983)

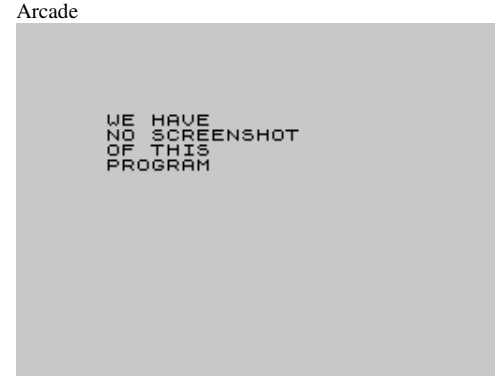

Frontier of Warriors: Mayday Call, The (Zeropolis Element,2007) Text Adventure



Frontiers (Zafiro Software Division,1988)
Arcade Adventure

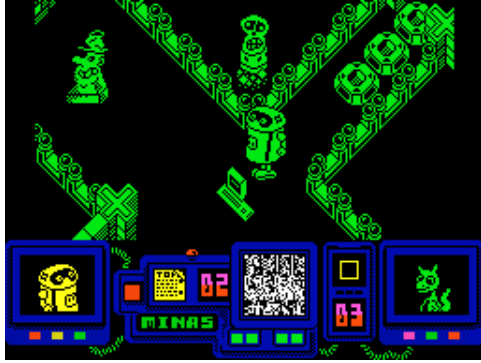

Froot Loop (Ntd Software,1984)
Arcade

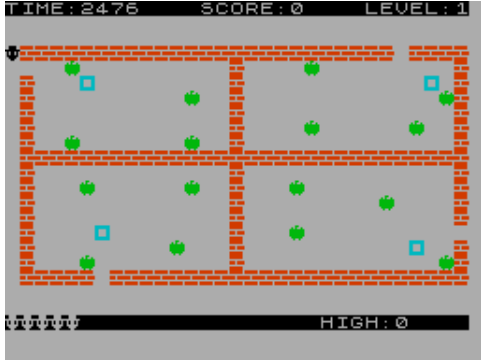

Fruit 2000 (Rossware,1985)
Simulation



Fruitmachine (,1983)
Simulation



Fruit Machine (C-Tech,1982)
Simulation

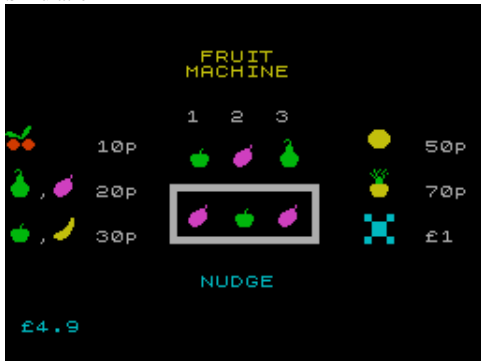

Frontline (Zeppelin Games Ltd,1988)
Arcade



Frosch (,)
Arcade

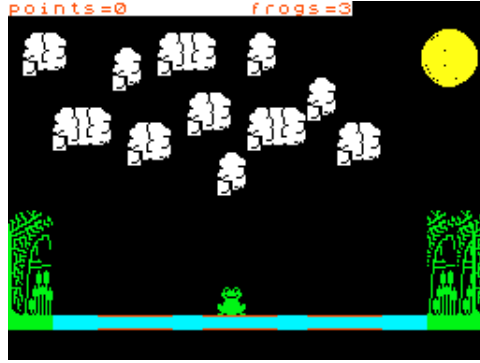

Fruit 2010 (Rossware,1986)
Simulation



Fruit Machine (Anco Software Ltd,1983)
Arcade



Fruit Machine (DK'Tronics Ltd,1983)
Simulation



Fronton (Jose Maria Gonzalez Ondina,2004)
Arcade



Frost Byte (Mikro-Gen Ltd,1986)
Arcade



Fruita (Wizard Software,1983)
Arcade



Fruit Machine (Astro Software,1982)
Arcade



Fruit Machine (Dymond Software,1983)
Arcade



Fruitmachine (Firebird Software Ltd,1985)
Simulation



Fruit Machine (Haven Hardware,1983)
Arcade



Fruit Machine (Spectrum Computing,1985)
Arcade



Fruit Machine Simulator 2 (Code Masters Ltd,1990)
Simulation



Fruity (Rossware,1987)
Simulation

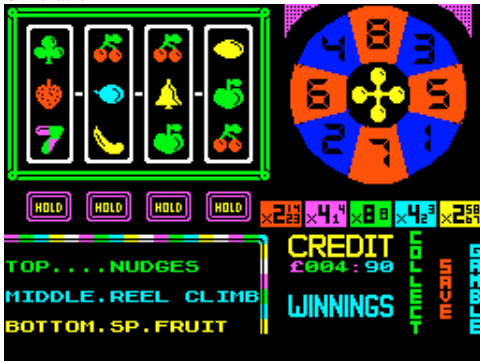

Fruit Machine (Granada Publishing,1983)
Arcade

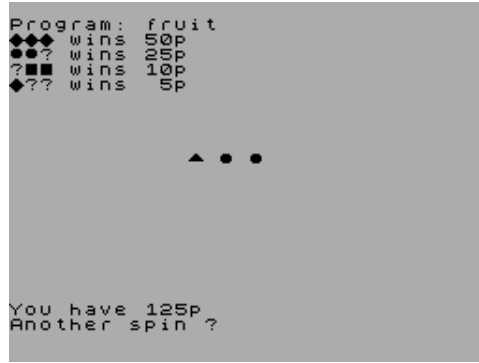

Fruit Machine (Precision Software Engineering,1983)
Arcade



Fruit Machine + Pontoon (Astro Software,1982)
Compilation



Fruit Snapper (Live-Wire Software,1984)
Arcade

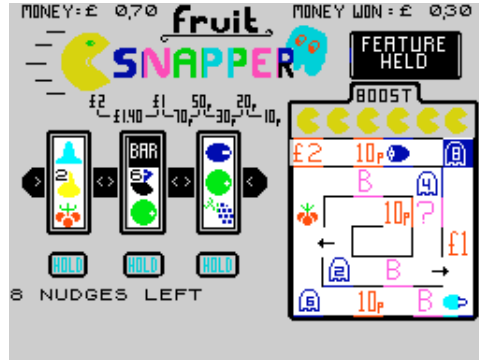

FUCK (Hacker Junior/Conradorre Soft.)
Scene Demo



Fruit Machine (Green Fish Software Enterprise,1985)
Simulation

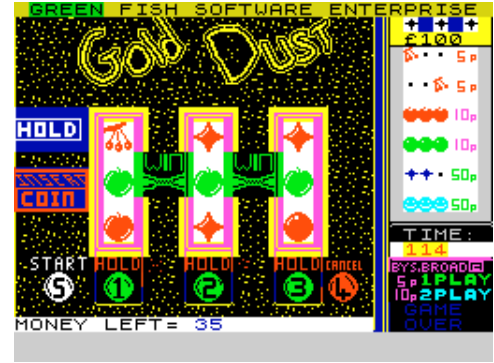

Fruit Machine (Simon Micro-Soft,1982)
Arcade



Fruit Machine Simulator (Code Masters Ltd,1987)
Simulation



Fruity (5D Software,1984)
Arcade

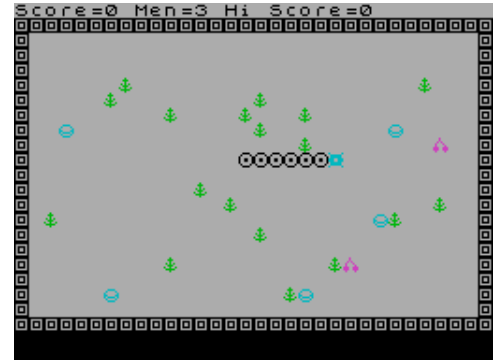

Fuck Communists! (3S-Group.)
Arcade



Fuckerman (00 Software,1985)
Text Adventure

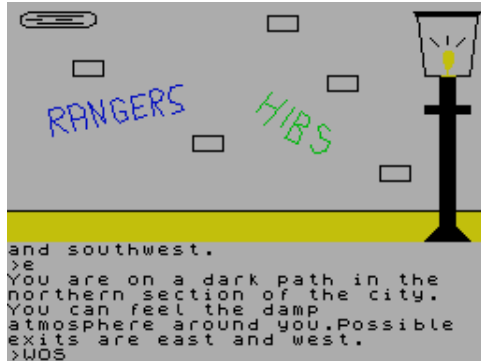

Fuddo & Slam (Zenobi Software,1988)
Text Adventure



Fuksoft (Sybilasoft,1987)
Text Adventure



Full Screen Copier (Speedy Print,1985)
Utility: Screen Manipulation

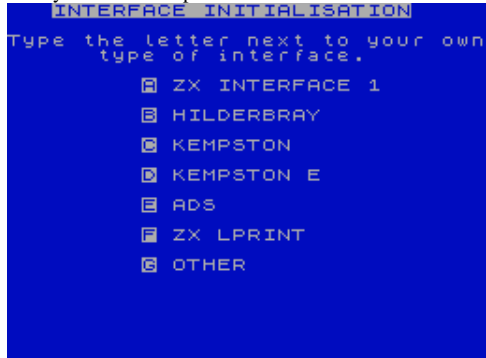

Full Throttle (Micromega,1984)
Arcade



Fucking Demo (Han Solo,1993)
Scene Demo



Fuerza Aerea (MicroHobby,1986)
Simulation



Fuksoft II (Raxoft,1989)
Text Adventure

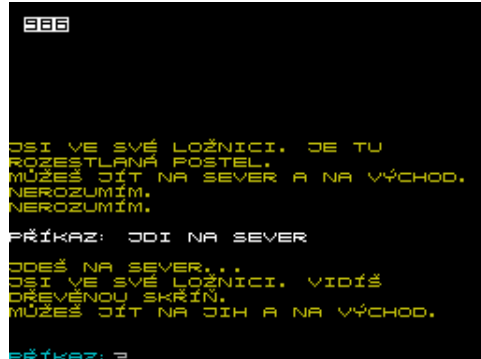

Full Screen Editor/Assembler (Oxford Computer Publishing,1984) Utility: Assembler/Disassembler/Monitor



Full Throttle II (Zeppelin Games Ltd,1990)
Arcade



Fuckman (,) Board/Card Game



Fuga de BE-31 (Francisco Bretones Castillo,1989)
Text Adventure



Fuller Box & Orator Demonstration (Fuller Micro Systems Ltd,1983) Utility

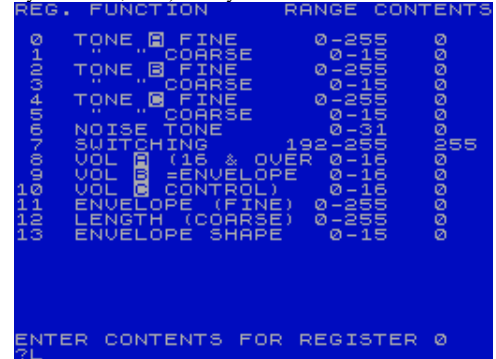

Full Shit (Experience Group,1999)
Arcade Adventure

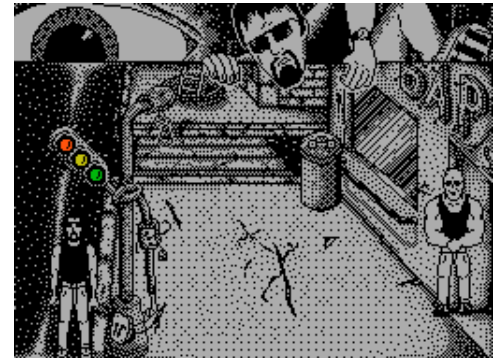

Funciones (MicroHobby,1986)
Educational



Funciones en 3D (MicroHobby,1985)

Utility: Mathematics



Funciones Trigonometricas (MicroHobby,1984)

Utility: Mathematics

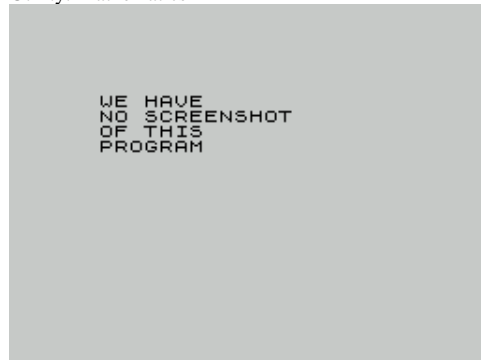

Funcoes (.)

Utility: Mathematics

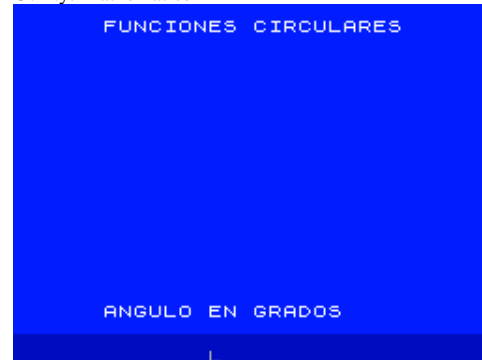

Funciones (Ariel Genis,1987)

Utility: Mathematics

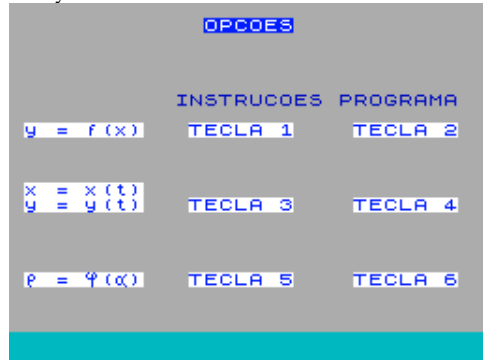

Function Keys 1 (ThunderWare Research Center,1985)

Utility: BASIC Related

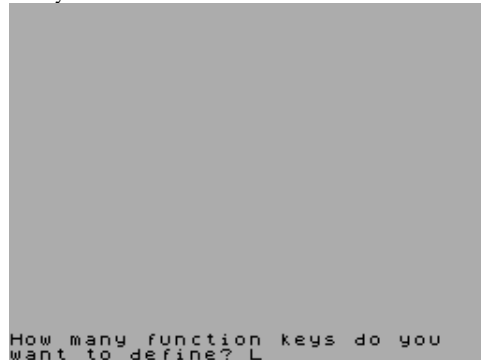

Function Keys 2 (ThunderWare Research Center,1985)

Utility: BASIC Related

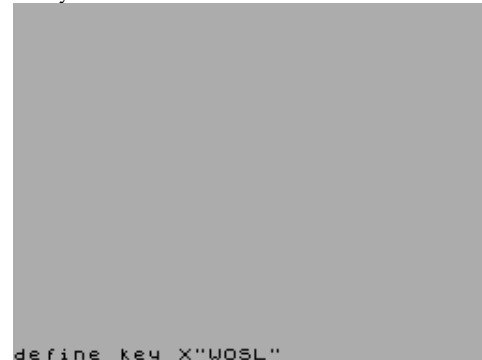

Function Plotter (Bernd Dahmer,)

Utility: Mathematics

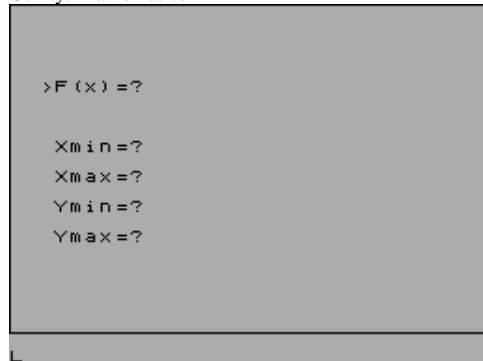

Fundamental Algebra (Griffin Software,1984)

Educational

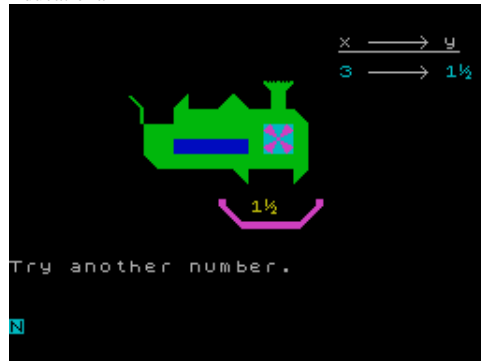

Funhouse (Pacific Software,1984)

Text Adventure



Funkcja Kwadratowa (Rabbit,1987)

Utility: Mathematics

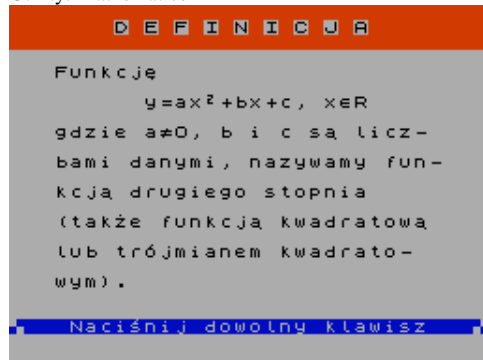

Funky Punky (Sygran S.A.,1987)

Arcade Adventure



Funky Testicle (Leigh Loveday,1991)

Arcade



Fun Maths (.)

Educational



Fun Park (Cronosoft,2004)

Simulation



Fun Part Demo, The (The Unbelievables,1993)

Scene Demo



Fun School 2 for 6-8 Year Olds (Database Software,1991)
Educational

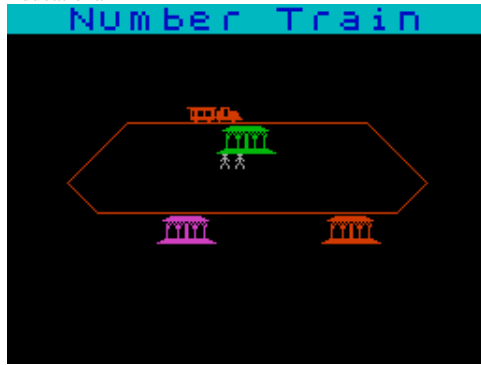

Fun School 3 for 5-7 Year Olds (Database Software,1991) Educational



Fun School 4 for 5-7 Year Olds (Europress Software,1992)
Educational

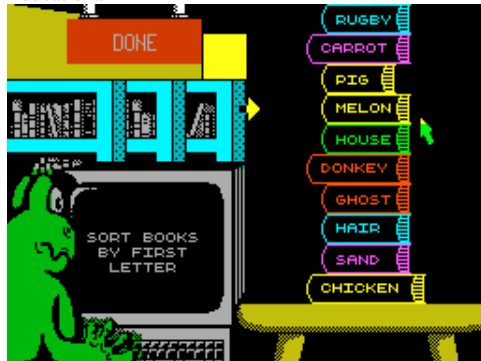

Fun to Learn (Shards Software,1984)
Educational

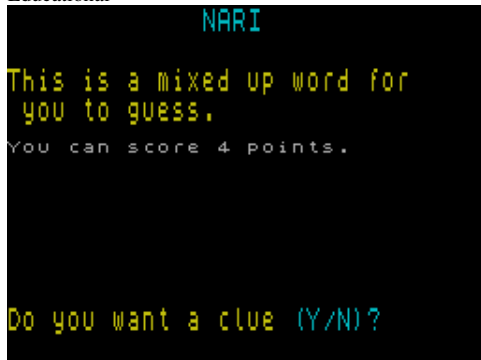

Fuseman (Bill & Marion Clews,1985)
Text Adventure

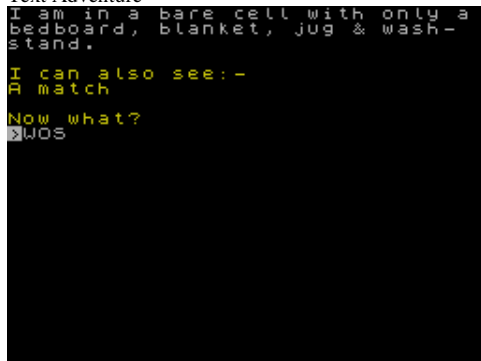

Fun School 2 for the Over-8s (Database Software,1989)
Educational



Fun School 3 for the Over-7s (Database Software,1991)
Educational



Fun School 4 for 7-11 Year Olds (Europress Software,1992)
Educational

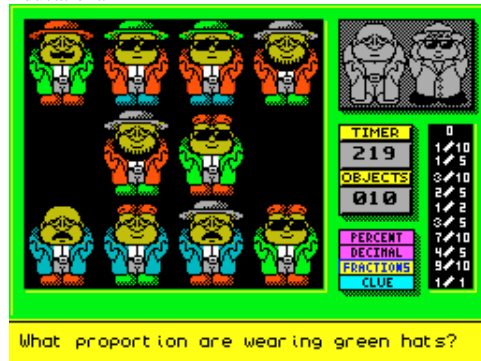

Further Adventures of Paxman (Spectrum Computing,1983) Arcade



Fussball (Klaus Jahn,1986)
Simulation



Fun School 2 for the Under-6s (Database Software,1989)
Educational

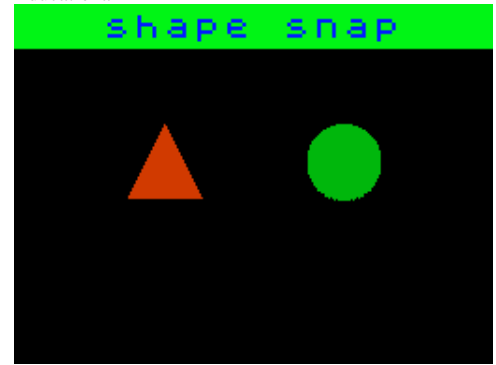

Fun School 3 for the Under-5s (Database Software,1991) Educational

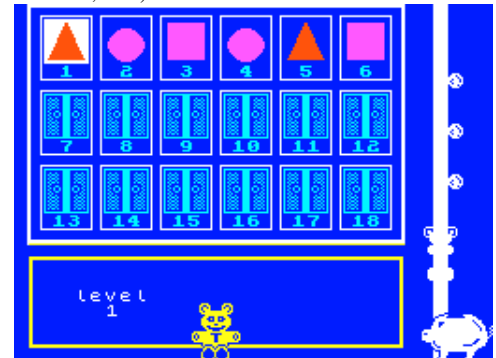

Fun School 4 for the Under-5s (Europress Software,1992)
Educational

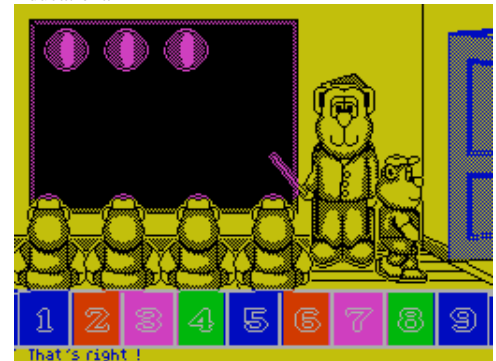

Fury, The (Martech Games Ltd,1988)
Arcade



Fussballcoach (L. Duwe,1984)
Strategy



Fussball Manager (H. Diefenbach,1984)
Simulation



Futbol (MicroHobby,1986)
Arcade



Future Bike Simulator (Hi-Tec Software Ltd,1990)
Arcade

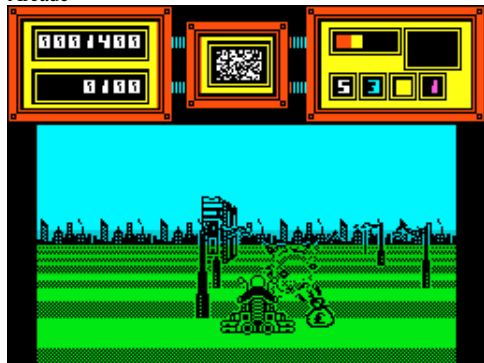

Future Tense (Mystic Software,1987)
Text Adventure



Fuxoft Soundtrack IV (Fuxoft,1989)
Scene Demo

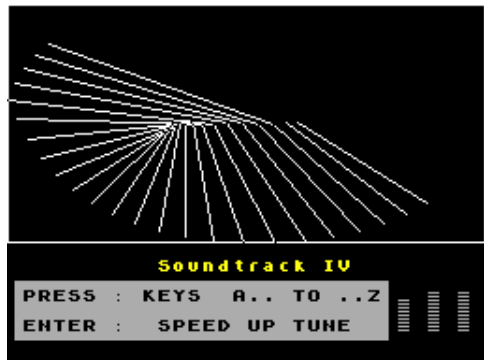

Fussball Trainer (C. Spark,1984)
Strategy



Futbol-Party (Duplinter S.A.,1984)
Sport



Future Games (Mastertronic Ltd,1986)
Arcade



Future Zoo (Clwyd Adventure Software,1986)
Text Adventure

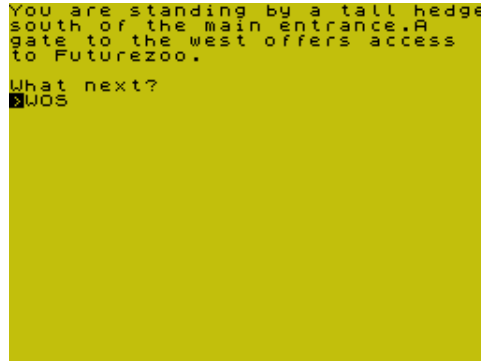

Fy-Fy (J.J. Computing.)
Scene Demo

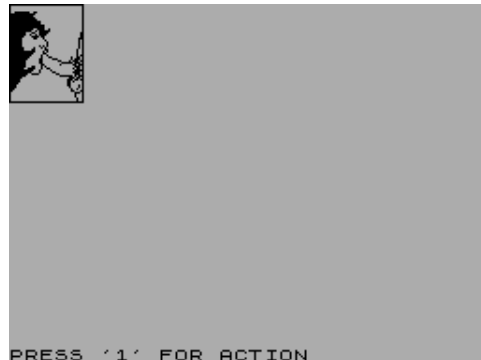

Fuss Load (Sinclair User,1992)
Utility

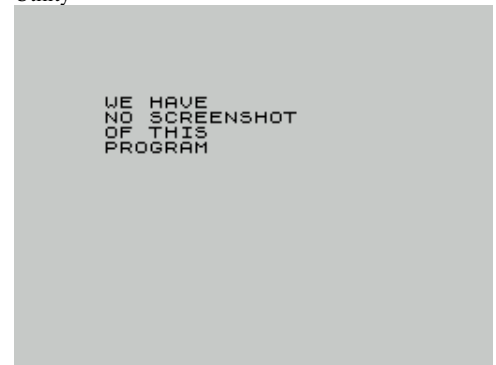

Futura (.)
Utility: Font/UDGs

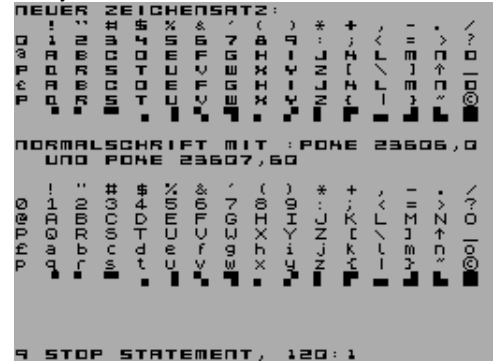

Future Knight (Gremlin Graphics Software Ltd,1985)
Arcade

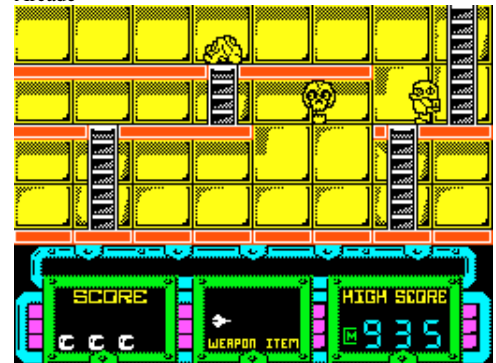

Fuxoft Soundtrack III (Fuxoft,1989)
Scene Demo

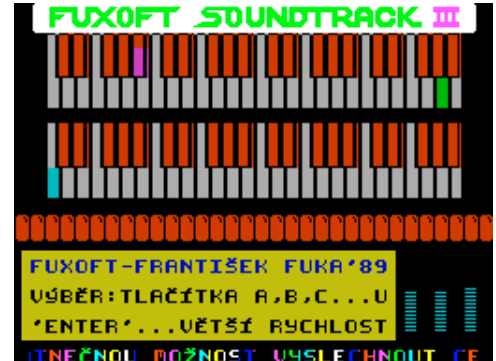

Gablota (.)
Arcade

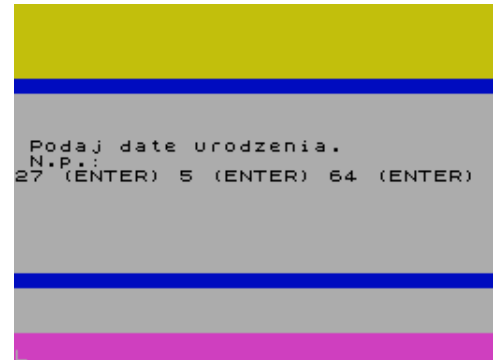

Gadget (MicroHobby,1985)
Arcade

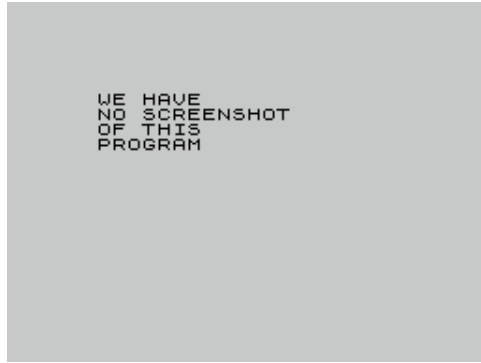

Galactians (DK'Tronics Ltd,1983)
Arcade



Galactic Gambler (Omega Software Ltd,1984)
Simulation



Galactic Invasion (Sinclair Research Ltd,1982)
Arcade



Galactic Patrol (CRL Group PLC,1983)
Arcade



G.A. Filer (ZX-Guaranteed,)
Utility: Copier

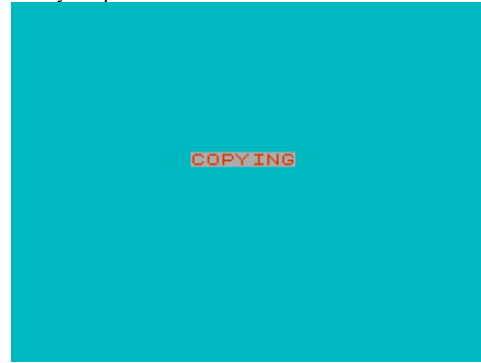

Galactic Abductors (Anirog Software,1983)
Arcade



Galactic Games (Activision Inc,1988)
Sport



Galactic Jail Break (Apocalypse Software,1983)
Arcade



Galactic Trooper (Romik Software,1984)
Arcade



Gaggles of George (Zenobi Software,1996)
Compilation



Galactic Attack in Stereo 3D (Olaf Hartwig,1984)
Arcade

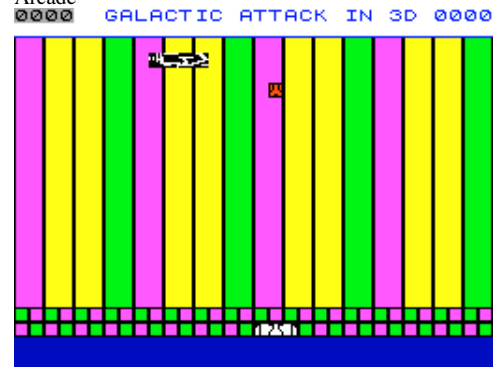

Galactic Gunners (Cybexlab Software,1987)
Arcade



Galactic Mechanic (K'Soft Ltd,1986)
Arcade



Galactic Warriors (Abacus Programs,1984)
Arcade



Galactic Warriors + Raceway (Abacus Programs,1984)
Compilation

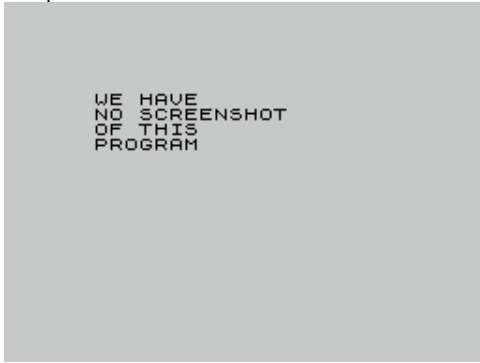

Galakzions (Mikro-Gen Ltd,1983)
Arcade



Galaxians (Artic Computing Ltd,1982)
Arcade

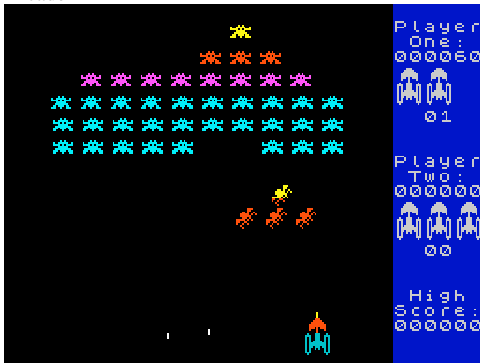

Galaxy 3 (Flash Inc,1994)
Scene Demo

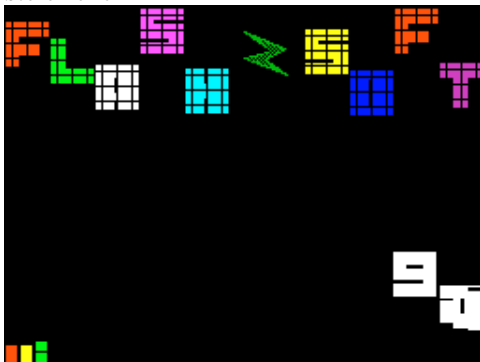

Galaxy Fighter (Computer Emuzone,2004)
Arcade



Galactoids (ZX Computing,1984)
Arcade



Galaxian (Atarisoft,1984)
Arcade



Galaxians (Microparadise Software,1984)
Arcade



Galaxy Attack (Sunshine Books,1983)
Arcade



Galaxy Force (Activision Inc,1989)
Arcade



Galaksija Emulator (Tomaz Kac,2007)
Simulation



Galaxian 5 (Abbex Electronics,1983)
Arcade



Galaxias (Delta 4 Software,1986)
Text Adventure



Galaxy Conflict (Martech Games Ltd,1983)
Board/Card Game



Galaxy Warlords (R&R Software Ltd,1983)
Arcade



Galaxy Warlords + Squirmly Wormy (John Prince Software, 1983) Compilation

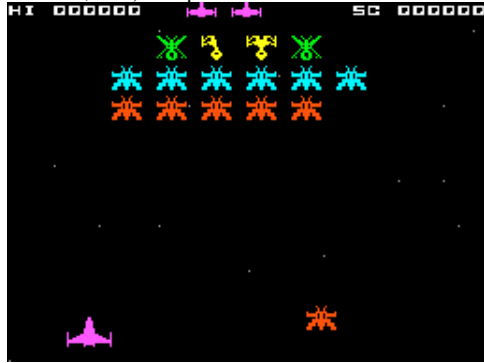

Galgie (.)
Board/Card Game



Galleons (Wizard Software, 1983)
Arcade



Gallipoli (CCS, 1986)
Strategy



Gamao (, 1983)
Board/Card Game

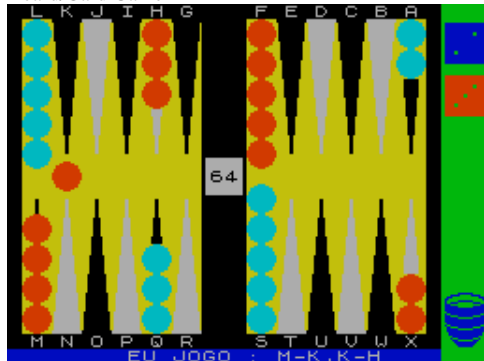

Galen (Mandragora Software, 1989)
Text Adventure



Galilee (Shards Software, 1984)
Text Adventure

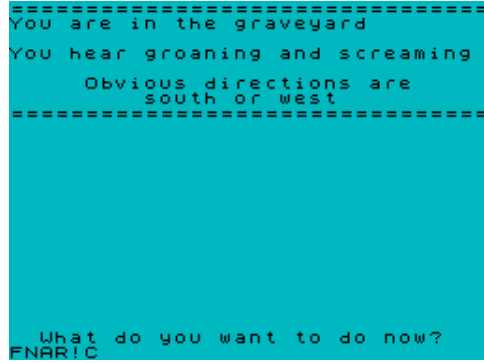

Galletron (Bulldog, 1987)
Arcade



Galope (EP Software,)
Arcade



G.A. Max Spy (ZX-Guaranteed,)
Utility: Copier



Galgen (EMM Software, 1984)
Arcade



Galivan - Cosmo Police (Imagine Software Ltd, 1986)
Arcade



Gallino Jones (.)
Text Adventure

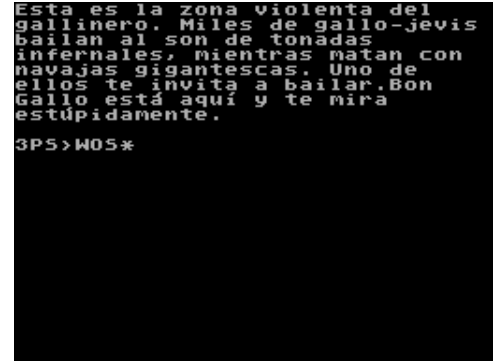

Gama Copy (Rostislav Gemrot, 1989)
Utility: Copier

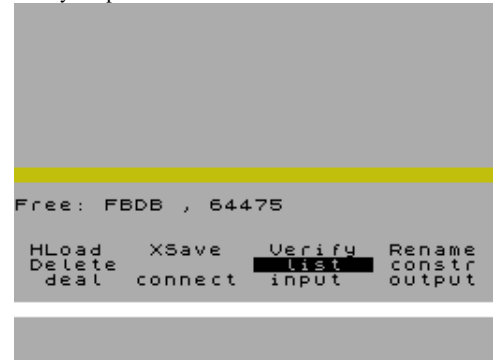

Gambit Modem (N-Discovery, 1999)
Arcade



Gamble (Gilad Japhet,)
Simulation

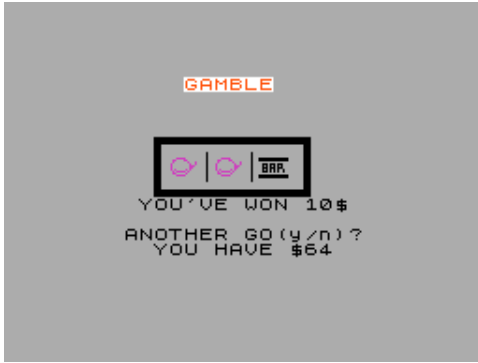

Gambling Tape (Dymond Software,1983)
Compilation



Game for Anything (K.B.G. Judson,1982)
Arcade

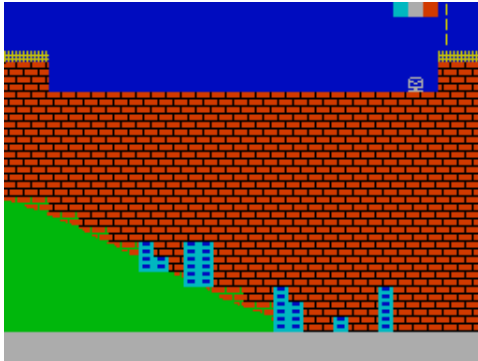

Game Over (Dinamic Software,1987)
Arcade



Games 1 (Sinclair Research Ltd,1982)
Compilation



Gambler + Editor (Diamond Games,1987)
Simulation

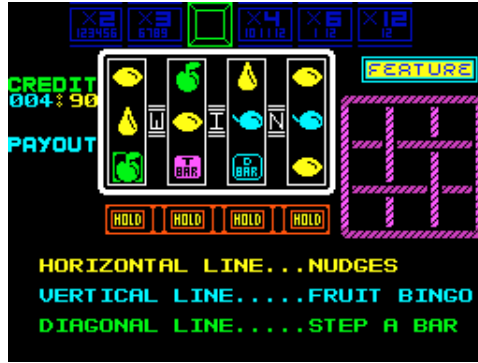

Game84 Compilation (Laszlo Nyitrai,1984)
Compilation

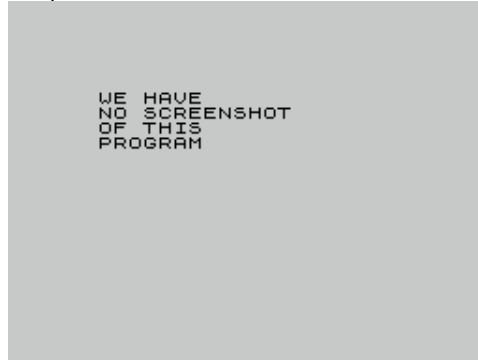

Game Mix (Suzy Soft,1987)
Arcade



Game Over + Game Over 2 (Imagine Software Ltd,)
Compilation



Games 2 (Sinclair Research Ltd,1982)
Compilation

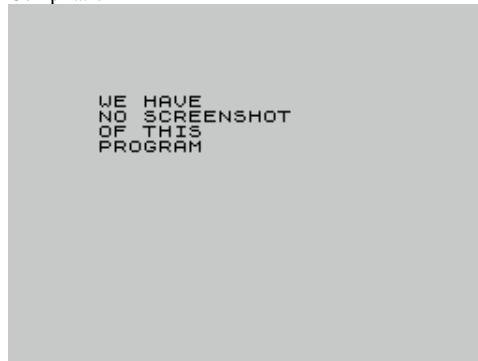

Gambler, The (Micro-Mart Software,1984)
Board/Card Game



Game Box (Copper Feet,1991)
Board/Card Game



Game of Cricket (Micromor,1983)
Sport



Games 1 (Finsbury Software,1984)
Compilation



Games 3 (Sinclair Research Ltd,1982)
Compilation



Games 4 (Sinclair Research Ltd,1982)
Compilation

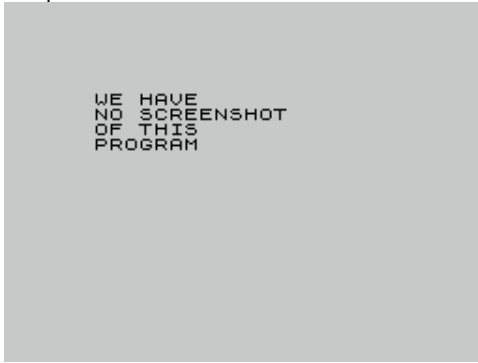

Games Cartridge (Sinclair Research Ltd,1983)
Compilation



Game Screen 1 (Software Rebels,)
Board/Card Game

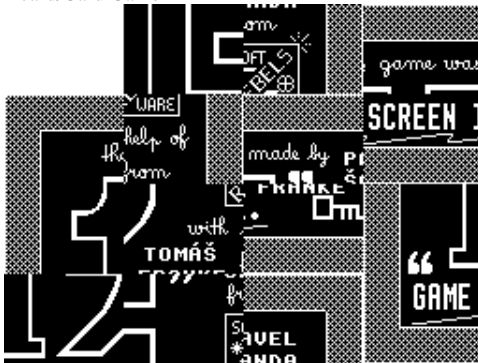

Game, Set and Match (Ocean Software Ltd,1987)
Compilation



Games of Strategy II (CCS,)
Compilation



Games 5 (Alchemist Research,1994)
Compilation



Games Compendium (Sinclair Research Ltd,1988)
Compilation



Game Screen 2 (Software Rebels,)
Board/Card Game

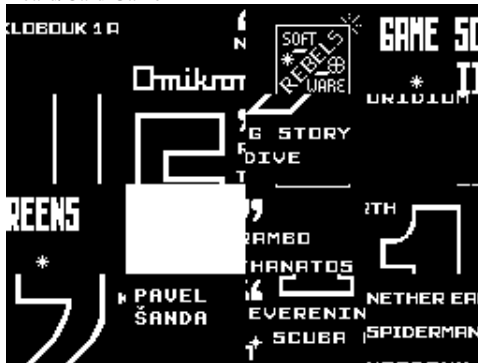

Game, Set and Match 2 (Ocean Software Ltd,1989)
Compilation



Games Pack (Impact Software [1],1983)
Compilation



Games 5 (Sinclair Research Ltd,1983)
Arcade



Games Crazy! (Gremlin Graphics Software Ltd,)
Compilation



Games Designer (Quicksilva Ltd,1983)
Arcade Game Development Tool

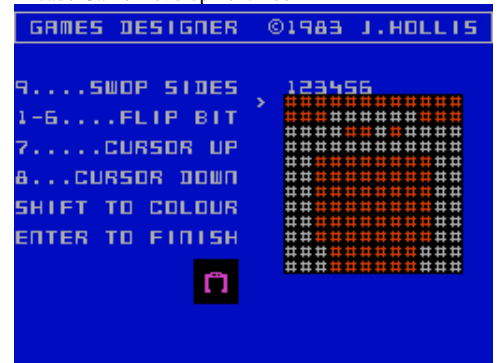

Games of Strategy I (CCS,)
Compilation



Games Pack (St. Michael,)
Compilation



Games Pack 1 (Abacus Programs,1982)
Compilation

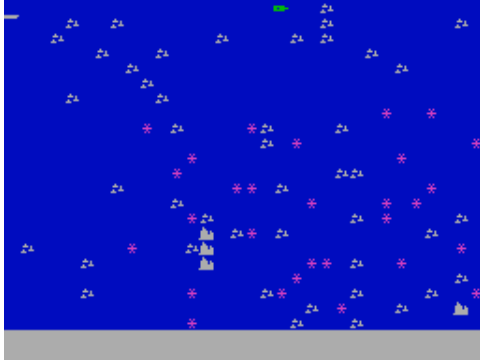

Gamespack 1 (Sagittarian Software,1984)
Compilation



Games Pack 1 (Spartan Software,1984)
Compilation



Games Pack 2 (Abacus Programs,1983)
Compilation



Games Pack 2 (Spartan Software,1984)
Compilation



Games Pack 4 (Custom Cables International Ltd.)
Compilation



Games Pack 4 (Orwin Software.)
Compilation



Games Pack One (Space Age Software,1984)
Compilation



Games - Summer Edition, The (US Gold Ltd,1989)
Sport

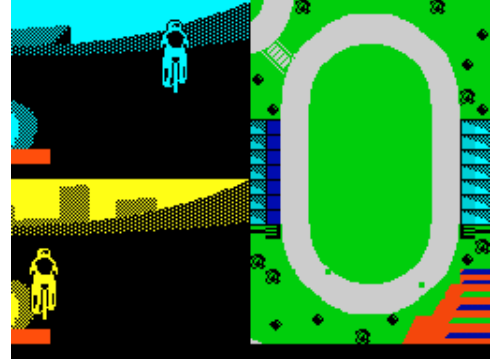

Games Tape 1 (Gilsoft International,1982)
Compilation

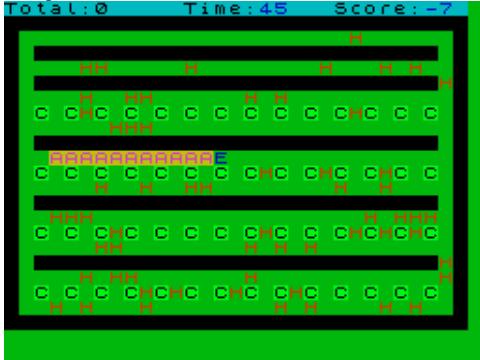

Games Tape 1 (Pi Software,1983)
Compilation



Games Tape 2 (Gilsoft International,1982)
Compilation



Games Tape 2 (Pi Software,1983)
Compilation



Games Tape 2 (Precision Software Engineering,1983)
Compilation



Games Tape 3 (Gilsoft International,1983)
Compilation



Games Tape 3 (Precision Software Engineering,1983)
Compilation

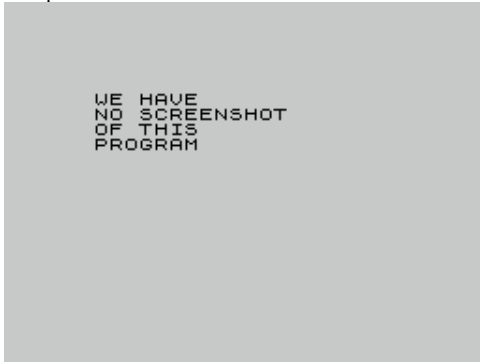

Gamestar issue 03 (A.C.E. Publications,1992)
Covertape



Games - Winter Edition, The (US Gold Ltd,1988)
Sport



Gamex (Cronosoft,2006)
Arcade

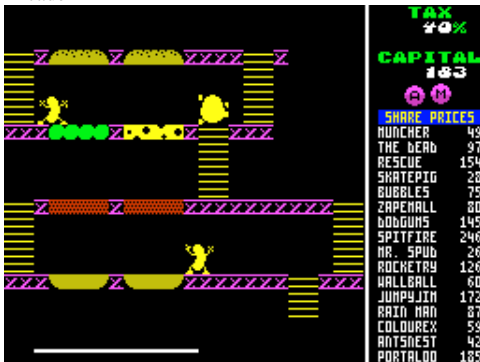

Gangplank (Pirate Software Ltd,1987)
Arcade

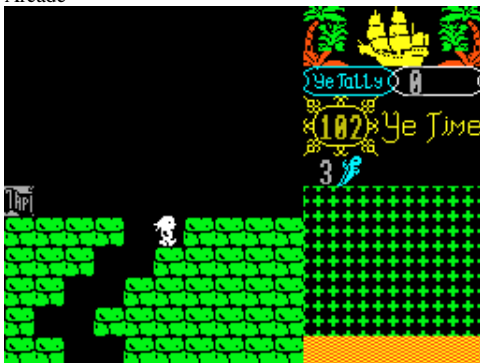

Gamestar issue 01 (A.C.E. Publications,1991)
Covertape



Gamester, The (David Walton,1987)
Utility

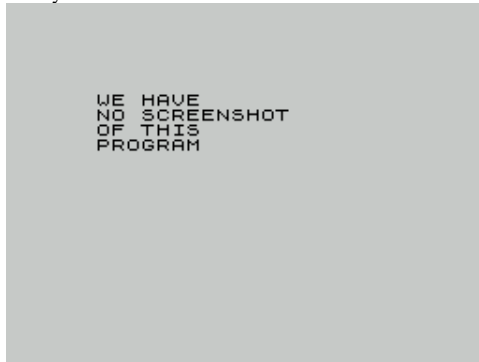

Game Tape 1 (Firefly,1982)
Compilation



Gamma (16/48 Tape Magazine,1984)
Arcade

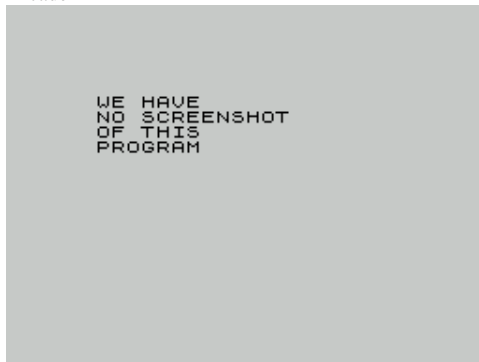

Gangster (USC Software Team,1988)
Utility: Copier

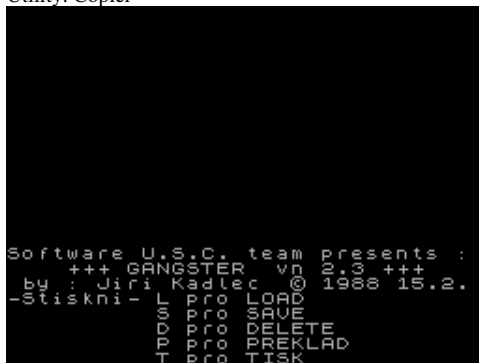

Gamestar issue 02 (A.C.E. Publications,1991)
Covertape



Games Test (CV Software,)
Educational



Game Without a Name (Dented Designs,1987)
Text Adventure

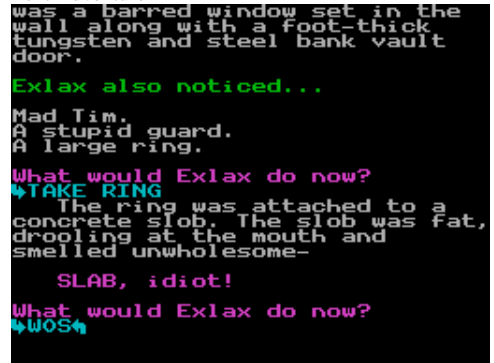

Ganemede 3 (Armin Hoelken,)
Arcade Adventure



Gangsters (P. Boulton Software,1983)
Simulation

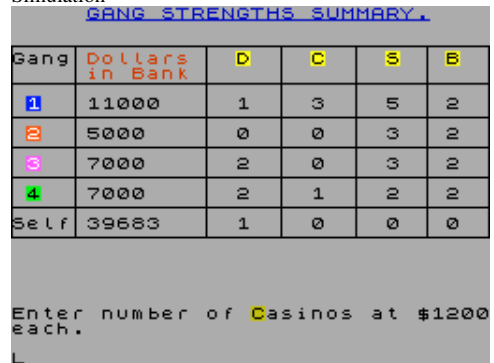

Gangsters (Sinclair Programs,1983)
Arcade

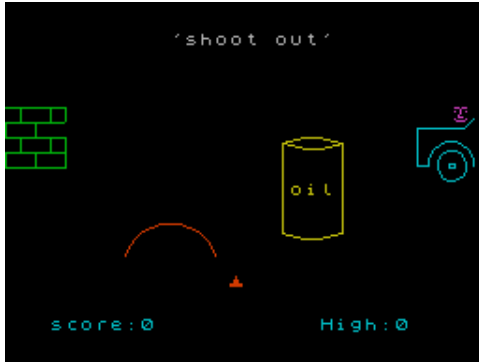

Garden Birds (Hilton Computer Services Ltd,1983)
Educational



Garfield - Big, Fat, Hairy Deal (The Edge Software,1988)
Arcade Adventure



Gargantua (Universum,1988)
Utility: Copier

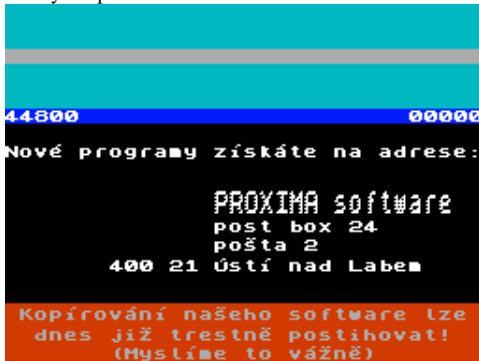

Gary Lineker Collection (Kixx,1992)
Compilation



Ganyemede II (EMS Software,1984)
Arcade



Garden Birds (Natsoft Programs,1984)
Educational



Garfield Demo (Hanyaboy's.)
Scene Demo



Gargoyle Classics (Rebound,1989)
Compilation



Gary Lineker's Hot-Shot! (Gremlin Graphics Software Ltd,1988) Sport



Garden (MicroHobby,1985)
Strategy



Garden Plant Directory (Practical Software,1984)
Utility

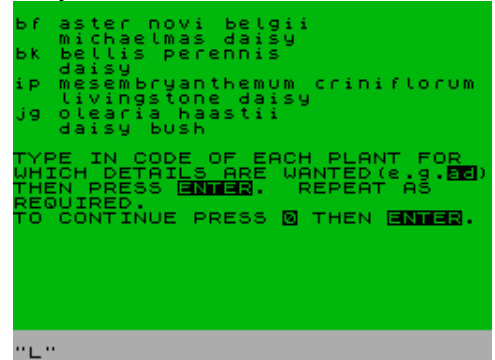

Garfield - Winter's Tail (The Edge Software,1990)
Arcade

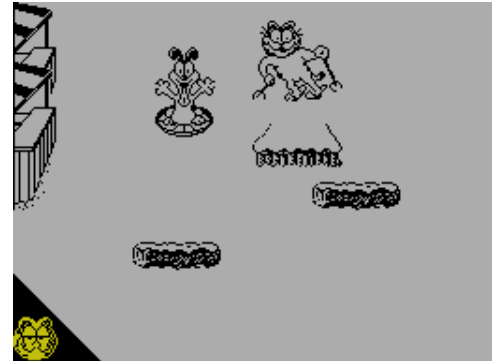

Garlic Respiration (UFO Group,1998)
Scene Demo

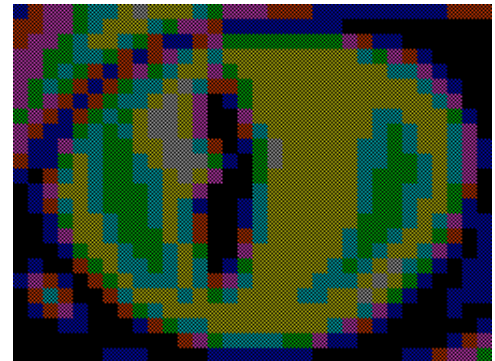

Gary Lineker's Super Skills (Gremlin Graphics Software Ltd,1988) Sport



Gary Lineker's Super Star Soccer (Gremlin Graphics Software Ltd,1987) Simulation



Gates (Scisoft,1984)

Educational

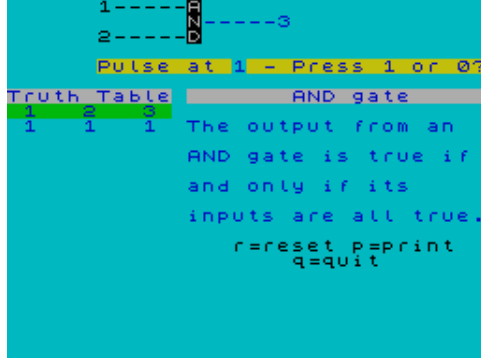

Gateway to the Skies (Solarsoft,1983)

Text Adventure

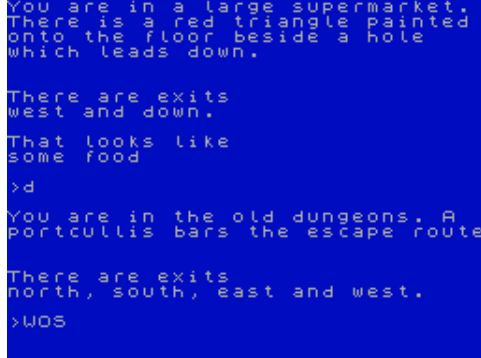

Gatos, Los (MicroHobby,1986)

Arcade

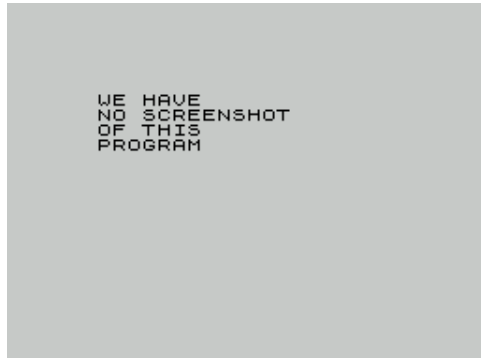

Gauntlet (V&H Computer Services,1982)

Arcade



Gas Bill (Sinclair User,1984)

Utility: Mathematics

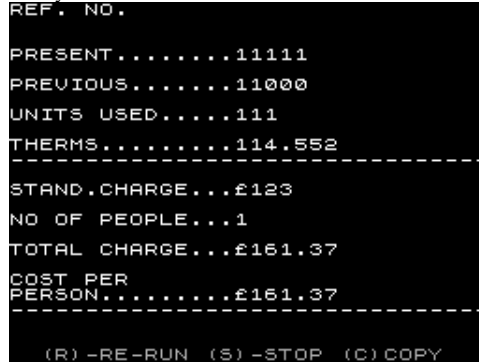

Gates of Garralon, The (Steven Cox,1984)

Text Adventure



Gath (Gargoyle Games,)

Arcade Adventure



Gatwick Express (Dee-Kay Systems,1988)

Simulation



Gauntlet + Gauntlet: The Deeper Dungeons (US Gold Ltd.)

Compilation

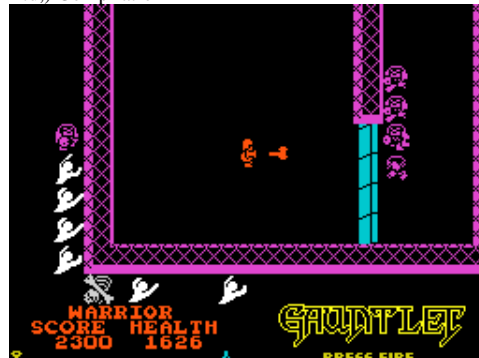

Gatecrasher (Quicksilva Ltd,1984)

Arcade

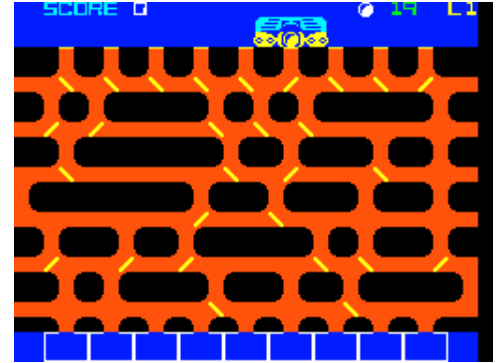

Gateway to Hell (Summit Software,1987)

Arcade

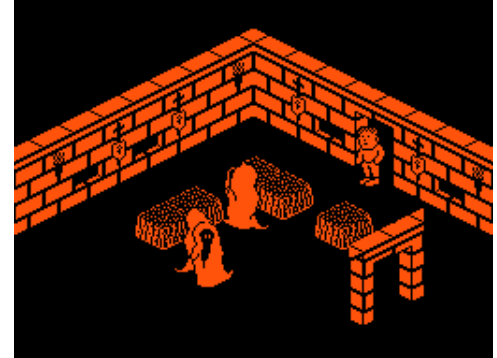

Gato con Botas, El (Nacho Gonzalez Cutre,1989)

Text Adventure



Gauntlet (US Gold Ltd,1987)

Arcade



Gauntlet + Gauntlet II (US Gold Ltd.)

Compilation

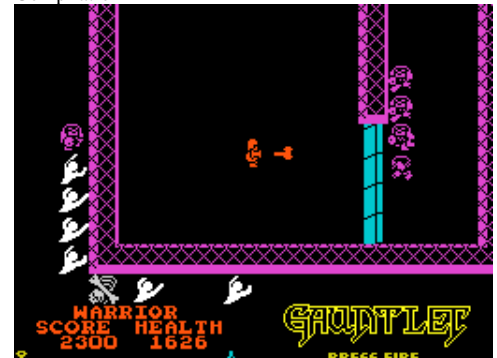

Gauntlet: The Deeper Dungeons (US Gold Ltd,1987)
Arcade



Gauntlet of Meldir (Sheila Hunt,1990)
Text Adventure



GBA Championship Basketball (Gamestar,1987)
Sport



GeeBee Air Rally (Activision Inc,1988)
Arcade



Gemelos (YOX,1989)
Arcade

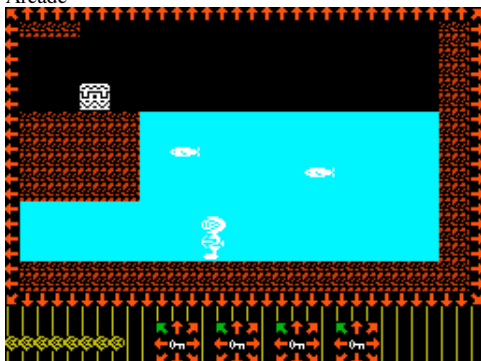

Gauntlet II (US Gold Ltd,1988)
Arcade



Gazza II (Empire Software,1990)
Sport



GDOS Backup (Zarko Cerovecki,.)
Utility: Copier



Geister Fahrer (.)
Arcade

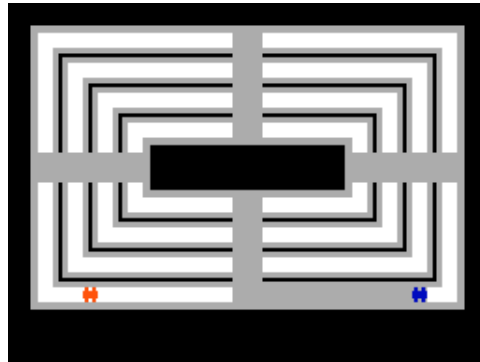

Gemini Wing (Virgin Mastertronic Ltd,1989)
Arcade

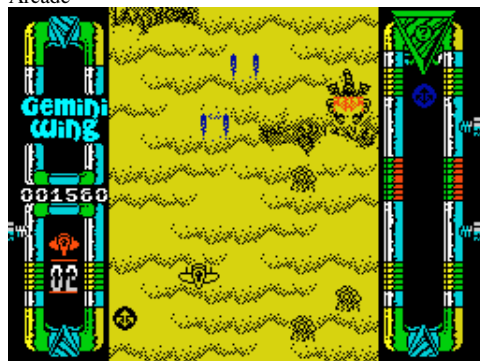

Gauntlet III: The Final Quest (US Gold Ltd,1991)
Arcade



Gazza's Super Soccer (Empire Software,1990)
Sport



G.E.B.-Stand (Data-Skip Software,1985)
Utility



Geister Fahrer (Klaus Copecz,1983)
Arcade

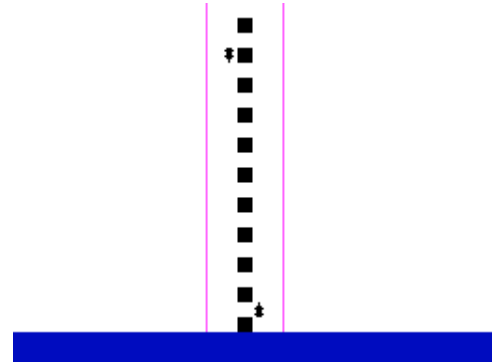

Gener-80 (Seven Stars Publishing,1984)
Utility: Programming



Generador de Rotulos (MicroHobby,1985)
Utility



General Election Statistics (Garry Rowland,1992)
Utility

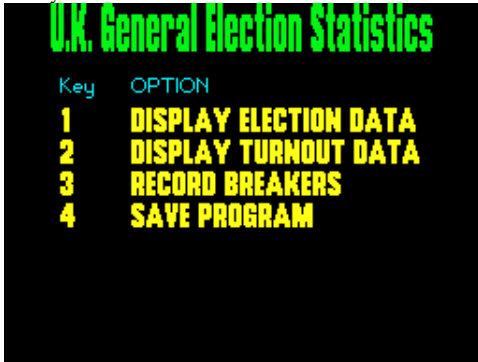

General, The (CCS,1989)
Strategy



Genghis Khan (Positive,1991)
Strategy



Genius 18 (Busy Software,1989)
Simulation

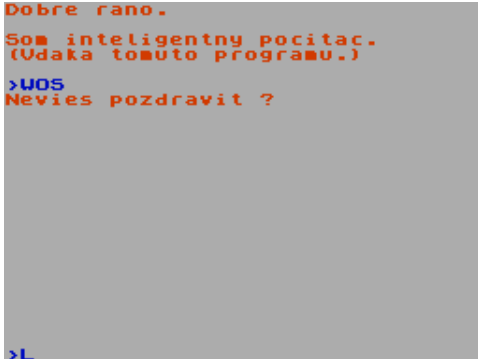

General Election (Bug-Byte Software Ltd,1983)
Simulation



General Statistics (WH Smith,1983)
Utility

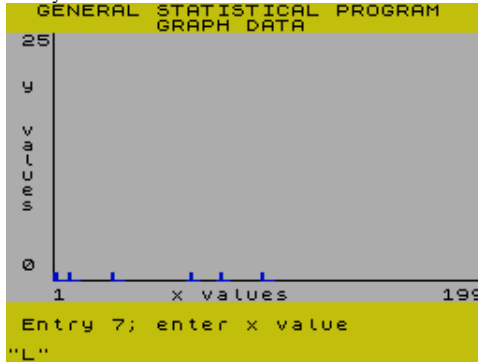

Genesis (Firebird Software Ltd.)
Arcade



Genial (Erbe Software S.A.,1990)
Compilation



Genus (Andrew Mark Daly,1988)
Arcade



General Election (Lobos Software,1987)
Simulation



General Tape Catalogue Reader (E. Kuchtin,1985)
Utility

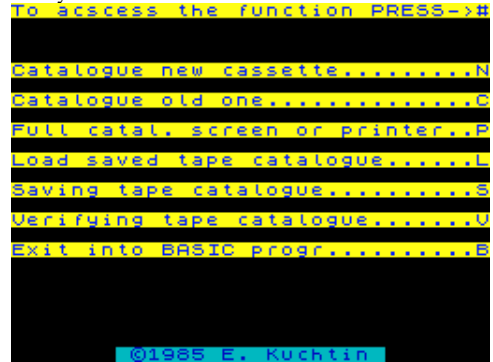

Genesis II (Mikro-Gen Ltd,1984)
Text Adventure



Genie (Romantic Robot UK Ltd,1987)
Utility

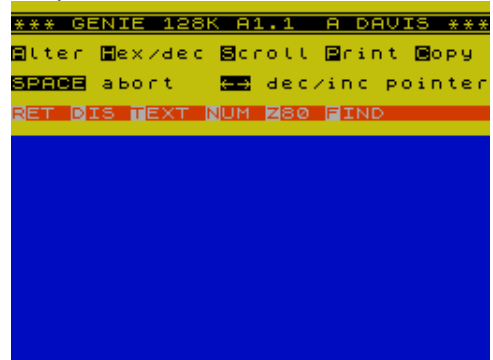

Genus (Ryan Shaw,1989)
Arcade



Geoff Capes Strong Man (Martech Games Ltd,1985)
Simulation



Geografia Polski (Jacek Długopolski,1986)
Educational

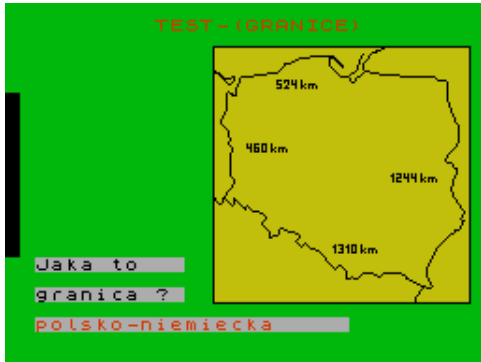

Geography (Thor Computer Software,1984)
Educational

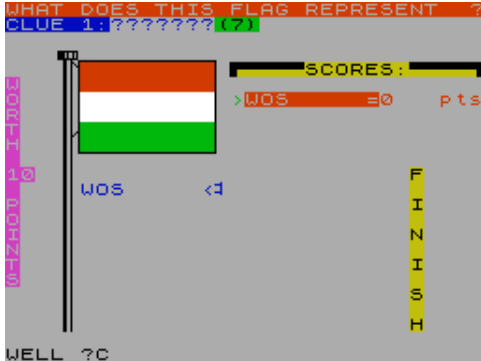

Geography 2 (Kemsoft,1984)
Educational



George and the Deadly Meteor (Your Sinclair,1986)
Arcade Adventure



Geografia (MicroHobby,1985)
Utility



Geography (Charles Letts & Co,1985)
Educational



Geography 1 (Kemsoft,1984)
Educational



Geography Demo (ESI,1993)
Scene Demo



Gerbil Riot of '67, The (The Guild,1992)
Text Adventure

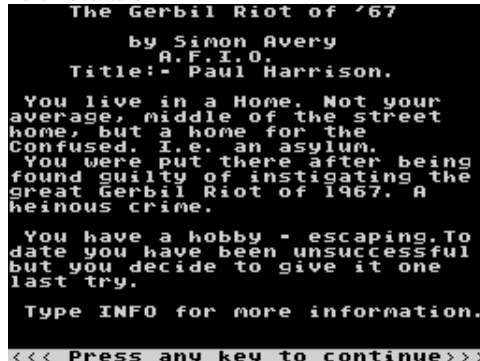

Geografia Polityczna Europy (Jacek Długopolski,1986)
Educational

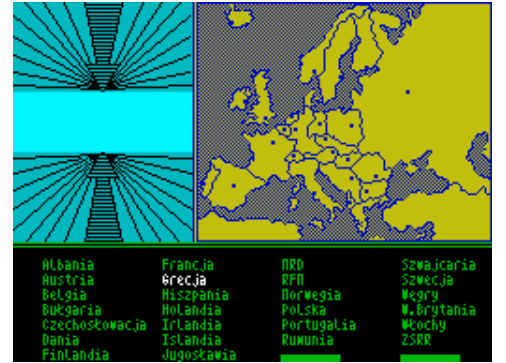

Geography (Disney Software,1987)
Educational



Geography 1 (Sinclair Research Ltd,1982)
Educational

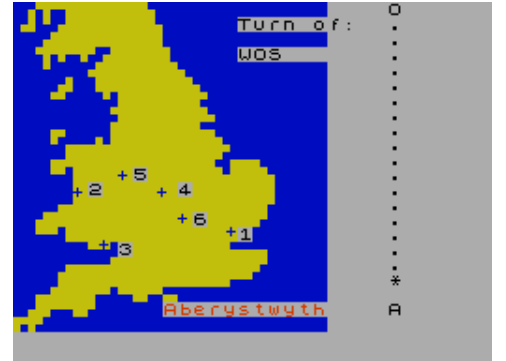

Geometra (MicroHobby,1985)
Utility



Gerente, El (DIMensionNEW/Ideologic S.A.,1984)
Simulation



German (Visions Software Factory,1988)
Educational



German Football (Antisoft,1984)
Sport

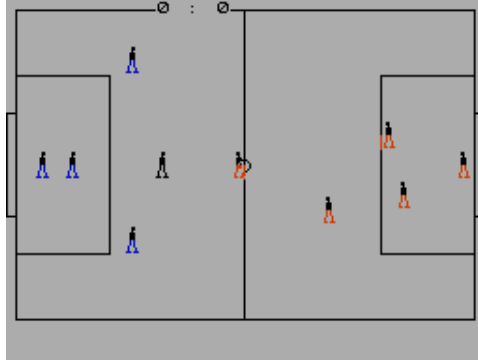

German is Fun (CDS Microsystems,1983)
Educational

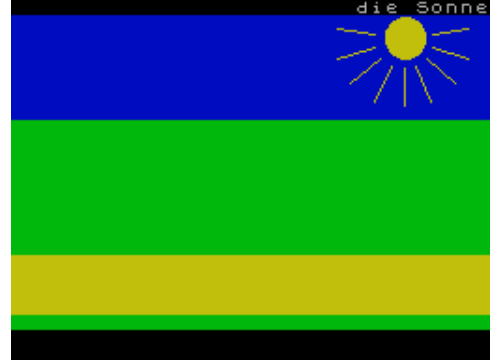

German Master, The: Level A (Kosmos Software Ltd,1984)
Educational



German Master, The: Level B (Kosmos Software Ltd,1984)
Educational



Gerry the Germ (Firebird Software Ltd,1985)
Arcade



Gestion de Fichier (Oxford Computer Publishing,1985)
Utility



Get Dexter (Infogrames,1987)
Arcade



Get Me to the Church on Time! (Zenobi Software,1992)
Text Adventure



Getset (Griffin Software,1983)
Educational



GFL Championship Football (Gamestar,1987)
Sport



G-Hacker (INDUG,1988)
Utility



Ghastly Ghouls (Anik Microsystems,1984)
Arcade



Ghaza's Super Soldier (Theo Devil,1990)
Scene Demo



Ghostbusters (Activision Inc,1984)
Arcade

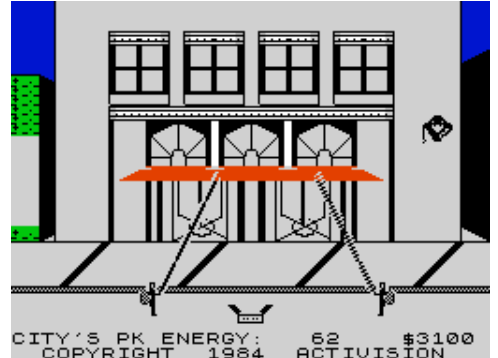

Ghostbusters (Rafael Vico Costa,1986)
Text Adventure



Ghost Castles (Weird Science Software,2005)
Arcade



Ghost Hunt (PSS,1983)
Arcade



Ghostly Shadow, The (16/48 Tape Magazine,1985)
Arcade



Ghost's Revenge (Micromania,1983)
Arcade

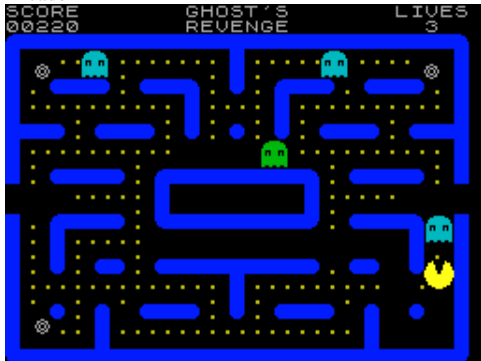

Ghostbusters (Theo Devil.)
Scene Demo

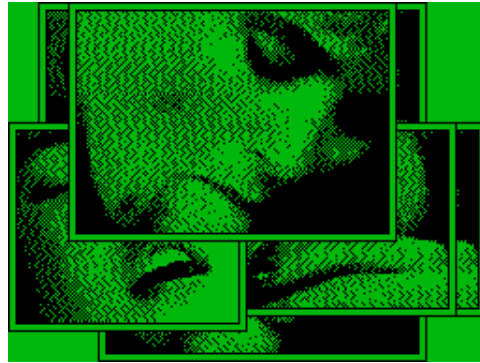

Ghost Exterminator (Spectrum Computing,1984)
Arcade



Ghost Hunters (Code Masters Ltd,1987)
Arcade Adventure



Ghost Rider (Positive Image,1984)
Arcade



Ghost, The (Your Sinclair,1987)
Utility



Ghostbusters II (Activision Inc,1989)
Arcade

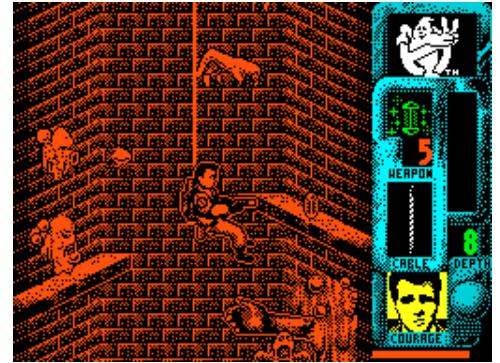

Ghost Gobbler (Orwin Software,1984)
Arcade

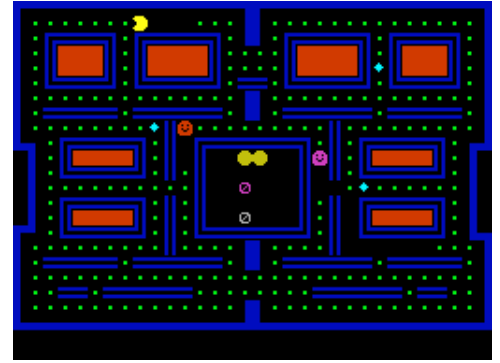

Ghostly Grange (Sparklers,1987)
Arcade



Ghosts 'n' Goblins (Elite Systems Ltd,1986)
Arcade

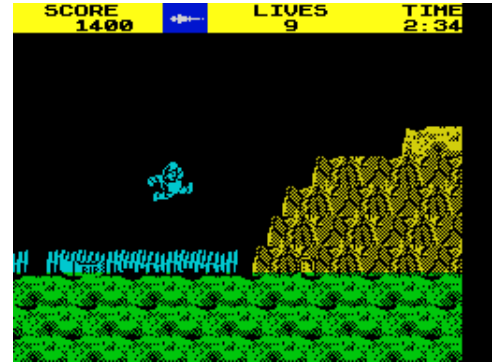

Ghost Town (Adventure International,1985)
Text Adventure



Ghost Town (Virgin Games Ltd,1983)
Text Adventure

YOU ARE IN THE SHERIFFS' OFFICE.
THERE IS A GUN CABINET ON THE
NORTH WALL AND A LARGE IRON DOOR
TO THE SOUTH.

WHAT NEXT? NOS

Ghouls 'n' Ghosts (US Gold Ltd,1989)
Arcade



Giants (US Gold Ltd,1989)
Compilation



Giddy Game Show, The (Mirrorsoft Ltd,1986)
Educational

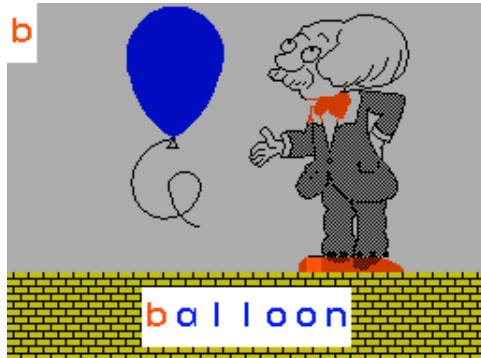

Gift for Wakson 20 (Flash Inc.)
Scene Demo

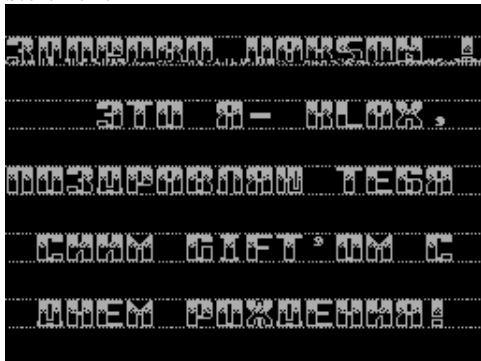

Ghoulies (IMS Software,1985)
Text Adventure

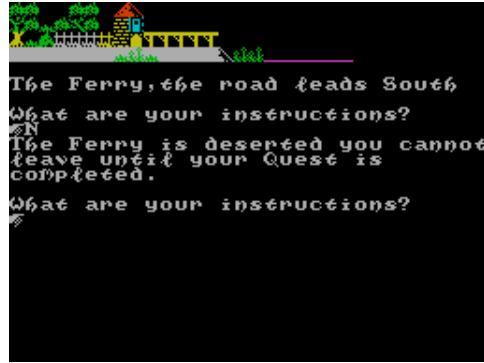

Giant Killer (Topologika,1988)
Text Adventure

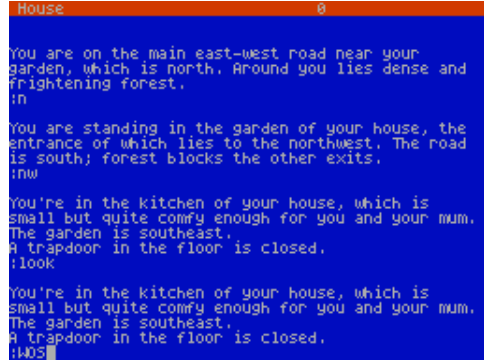

Giant's Dinner (Fowler Software,1984)
Compilation

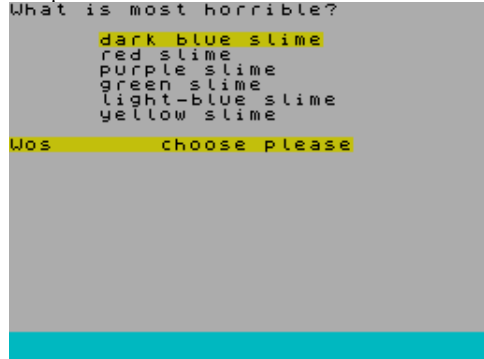

Gift for Alex (Flash Inc,1995)
Scene Demo



Gift from the Gods (Ocean Software Ltd,1984)
Arcade

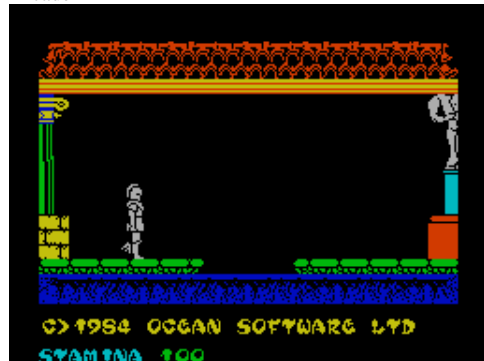

Ghoul Manor (Britannia Software Ltd,1984)
Text Adventure

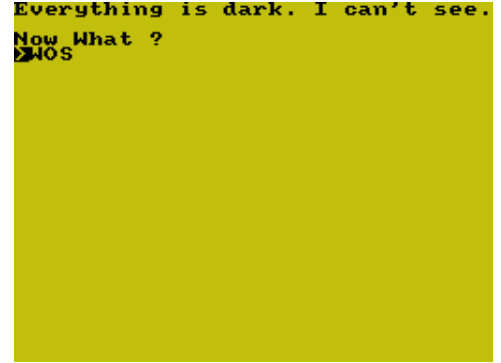

Giants (Edward Beck,1984)
Text Adventure



Giant's Revenge (Thor Computer Software,1984)
Arcade Adventure



Gift for Alex Raider (Flash Inc.)
Scene Demo



Gigantula (MicroHobby,1986)
Educational



Gigapede (D. Prostler,1984)
Arcade

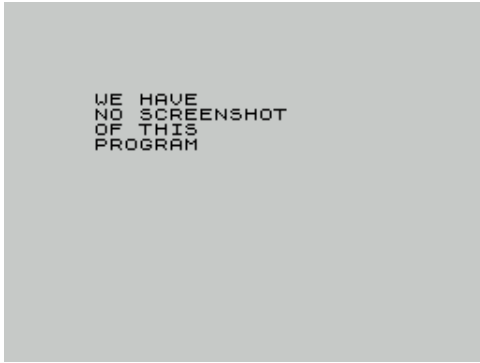

Gigolo (Silver Fox Comm Ltd,1983)
Board/Card Game



G.I. Hero (Firebird Software Ltd,1988)
Arcade



Gilbert: Escape from Drill (Again Again,1989)
Arcade Adventure

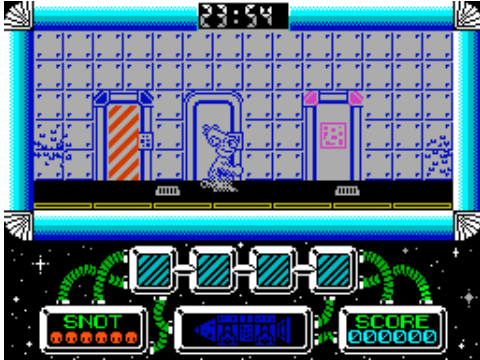

Gilizta (Egmont Koblinger/Albert Koblinger,1993)
Arcade

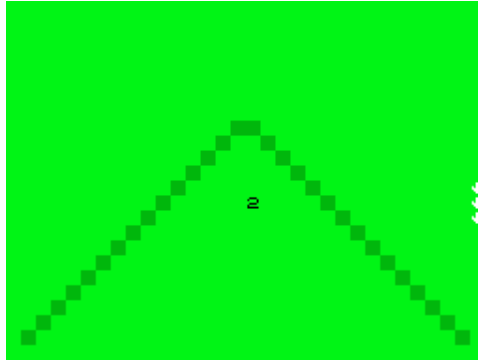

Gillespie (16/48 Tape Magazine,1986)
Arcade



Gilligan's Gold (Ocean Software Ltd,1984)
Arcade

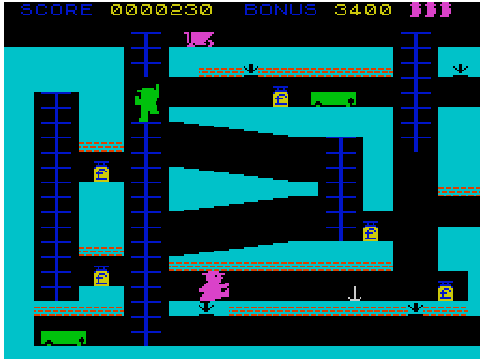

Gimme Hope Johanna (MicroHobby,1991)
Music



Ginormous Collection (Alternative Software Ltd.)
Compilation



Ginormous Fishtank Adventure, The (R. Barnard,1992)
Text Adventure

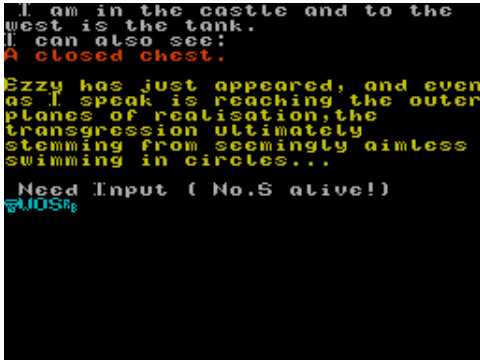

Girl Who Was Death, The (Stephen Preston,1986)
Text Adventure



Gissa Kiss (Titan Programs,1984)
Arcade



Gitternetz-Diagramm (Claus Jahn,1986)
Utility: Screen Manipulation



Give My Regards to Broad Street (Mind Games,1985)
Arcade Adventure

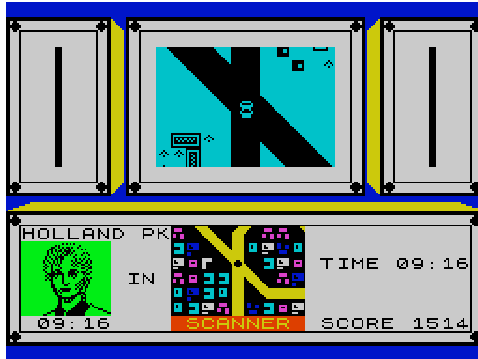

Gize (Xcellent Software,1986)
Text Adventure

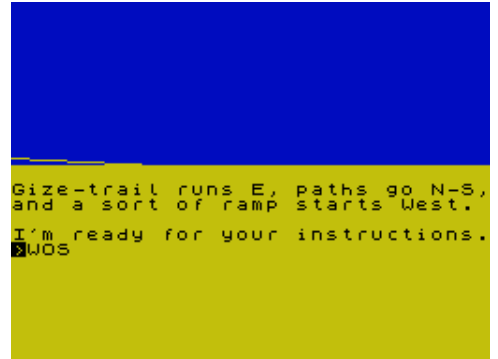

Gladiator (Domark Ltd,1986)
Arcade

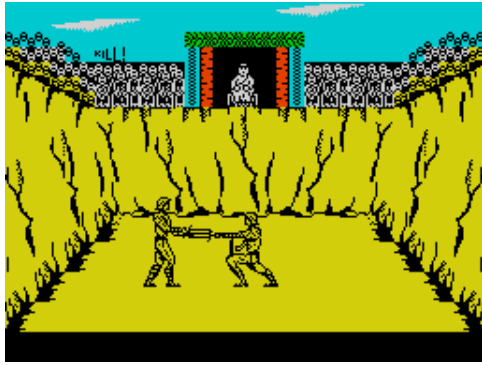

Glass (Quicksilva Ltd,1985)
Arcade



Glider Rider (Quicksilva Ltd,1986)
Arcade

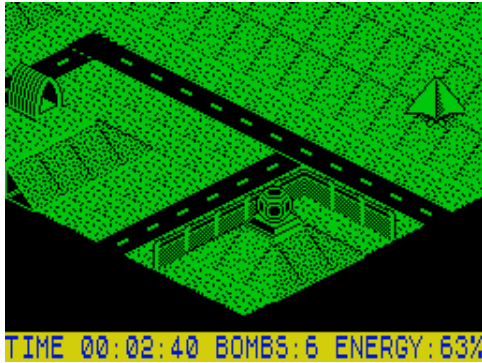

Globo Aereo + Nim-ble (Investronica S.A.)
Compilation



G-LOC + Out Run Europa (US Gold Ltd,1992)
Compilation



Gladiator, The (Pegasus Software.)
Text Adventure

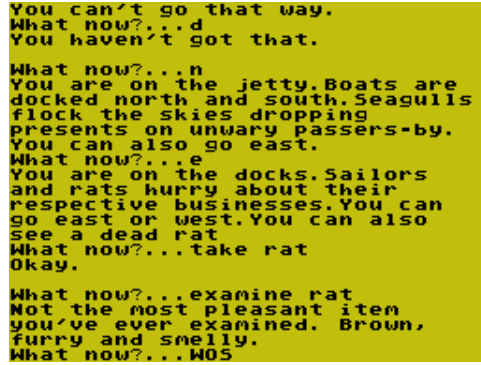

Glenagleys (Spectrum Computing,1984)
Arcade

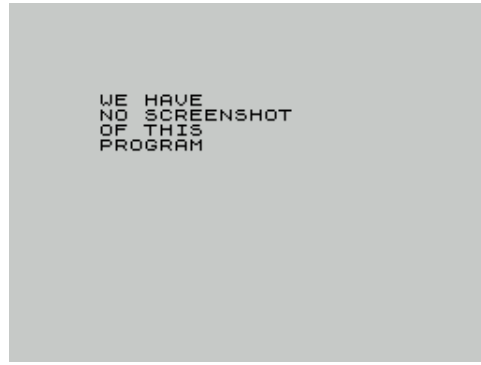

Globeplotter (Personal Computer World,1986)
Utility: Screen Manipulation

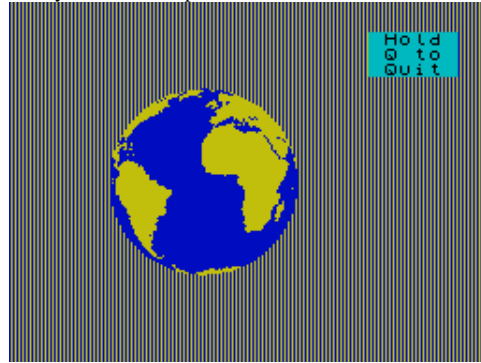

Globular Troubles (Jorgen Bech,1987)
Arcade

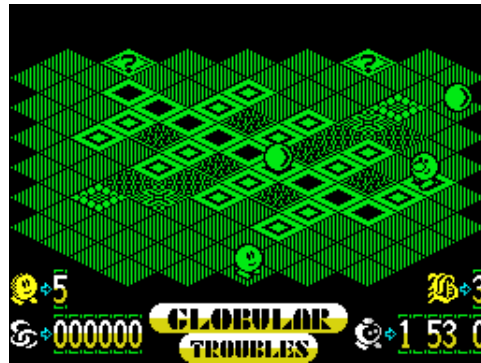

Gloop (Cronosoft,2003)
Arcade

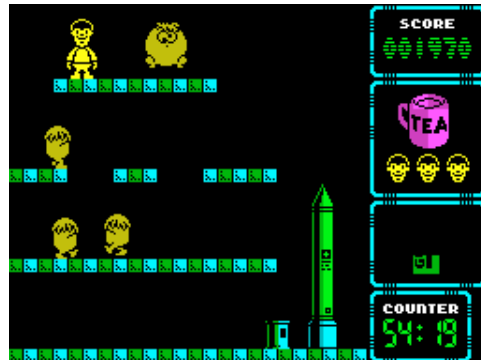

Glasgow Murder, A (J. Fanning,1986)
Text Adventure

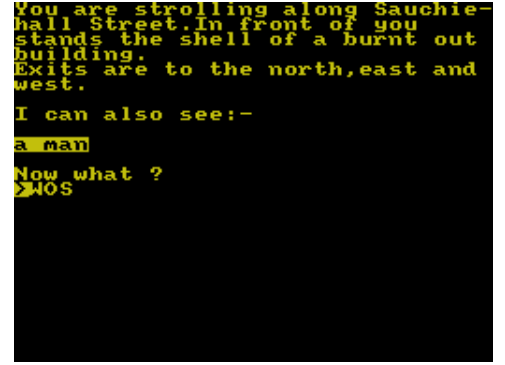

Glider (Macmillan Software Ltd/Sinclair Research Ltd,1984)
Simulation

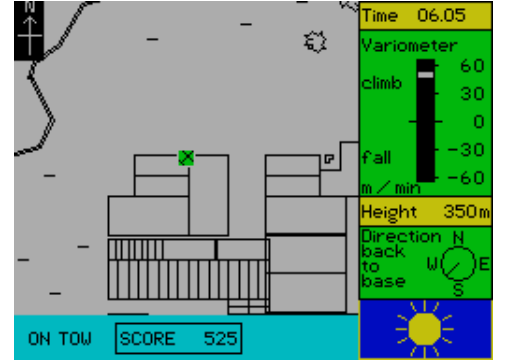

Globe, The (Zenobi Software.)
Text Adventure

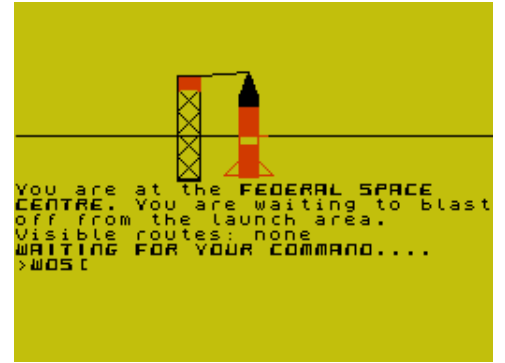

G-LOC (US Gold Ltd,1992)
Arcade

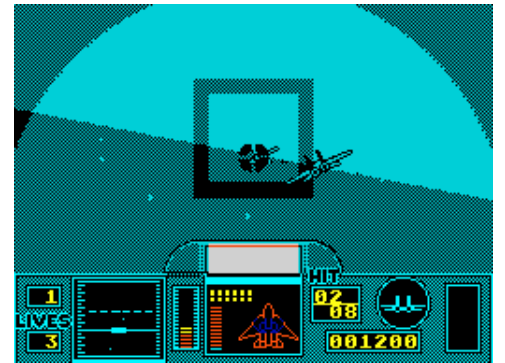

Glorious Twelfth (Stack Computer Services Ltd,1983)
Arcade



Glotho (MicroHobby,1986)
Arcade

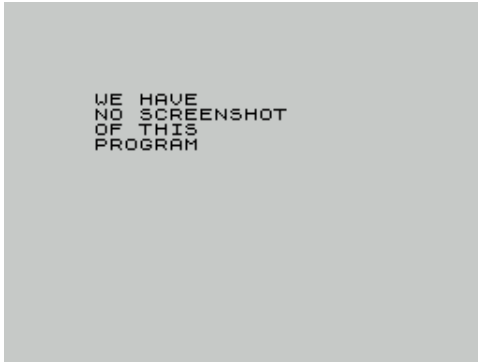

Gnasher (Mikro-Gen Ltd,1984)
Arcade



Gnome Lazies, The (Mouse.)
Arcade

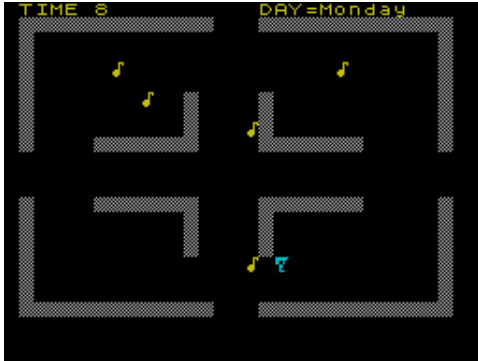

Gnoni (MicroHobby,1988)
Arcade



Goalie (Top Spec,1986)
Simulation



Glub (EP Software.)
Arcade

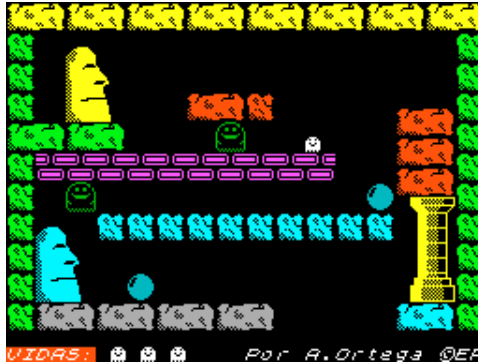

Gnasher (R&R Software Ltd,1983)
Arcade

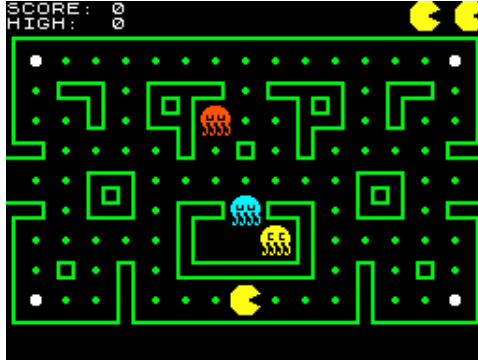

Gnome Ranger (Level 9 Computing Ltd,1987)
Text Adventure

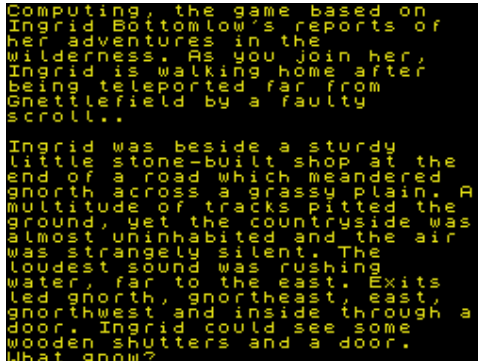

Go (Shodan Software,1985)
Board/Card Game

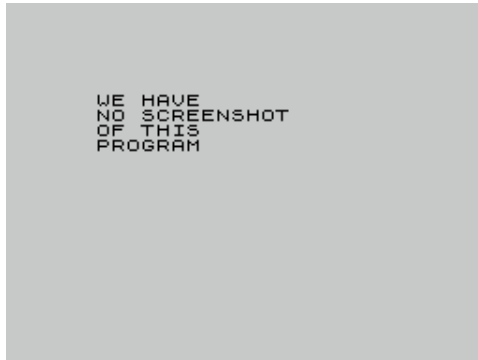

Gob (Simon Fitzpatrick/Malcolm Tyrrell.)
Text Adventure

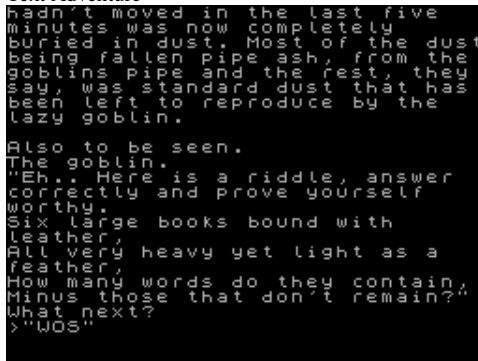

Glug Glug (CRL Group PLC,1984)
Arcade



Gnasher + Spectipede (Mastertronic Ltd,1984)
Compilation



Gnomos (MicroHobby,1985)
Arcade



Goa 4K (VAV,1998)
Scene Demo

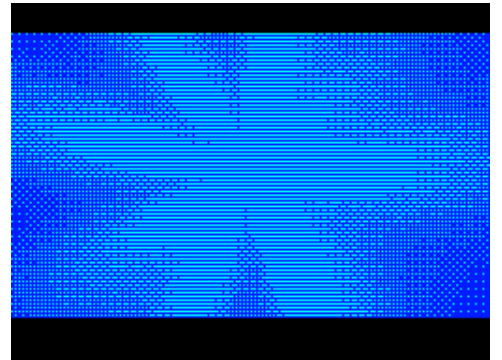

Gobble a Ghost (CDS Microsystems,1982)
Arcade

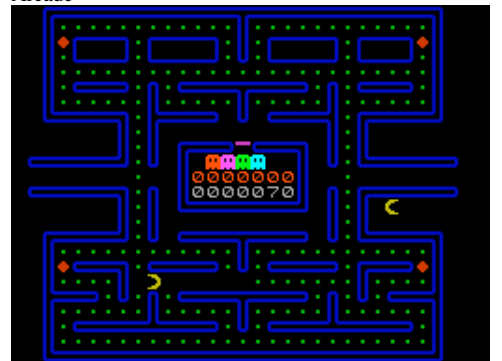

Gobbleman (Artic Computing Ltd,1982)
Arcade

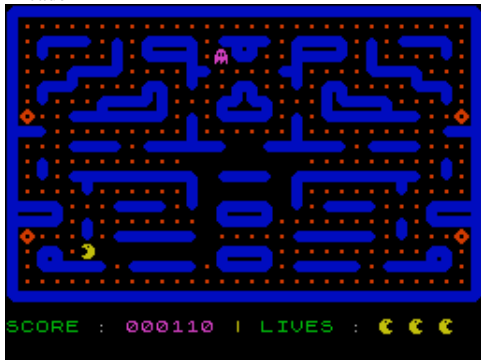

Go Bear Go! (Sinclair User,1988)
Arcade

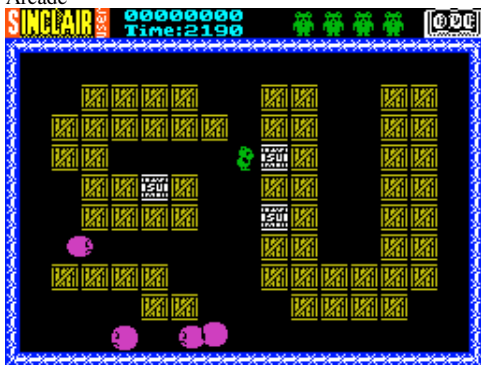

Goblin Gazette Issue 1 (Zenobi Software,1988)
Simulation



Go Crazy (US Gold Ltd,1988)
Compilation



Gods of War, The (Zenobi Software,1990)
Text Adventure



Gobbler (Saturnsoft,1982)
Arcade

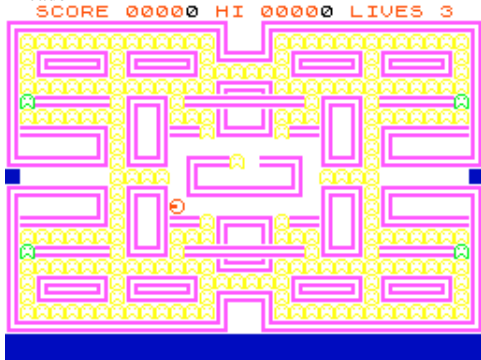

Goblin Crusher (Add-On Electronics Ltd,1983)
Text Adventure

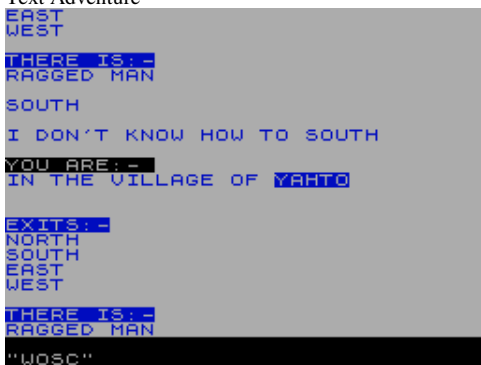

Goblin Gazette Issue 2 (Zenobi Software,1989)
Simulation

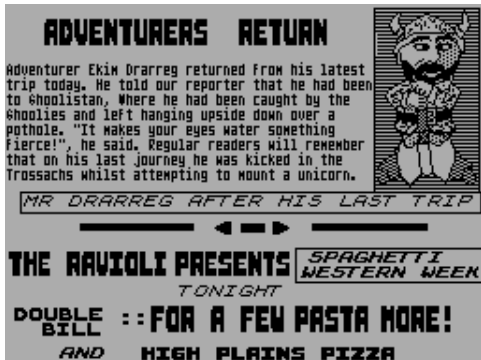

G.o.d (Studio 'Godness of Destany',1993)
Scene Demo



Godzilla: The Atomar Nightmare (Tiger's Claw,1995)
Strategy



Gobbler (Tweety Soft Ltd,1983)
Arcade



Goblin Gazette: Issues 1 & 2, The (Zenobi Software,1995)
Compilation



Gob Stopper (Calisto,1983)
Arcade

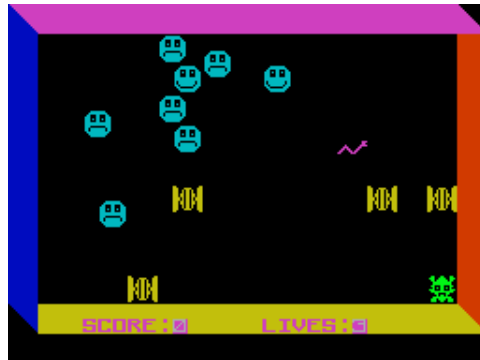

Gods (Your Sinclair,1989)
Arcade Adventure



Godzilla and the Martians (Temptation Software,1984)
Arcade

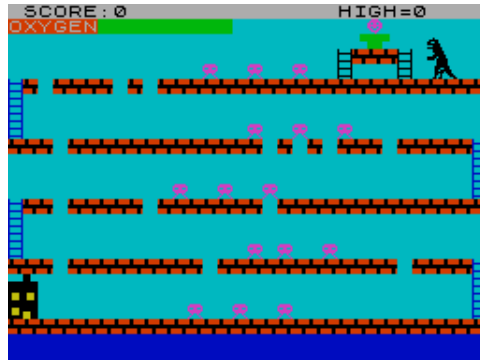

Go-Faster BASIC (Your Computer,1985)
Utility: BASIC Related

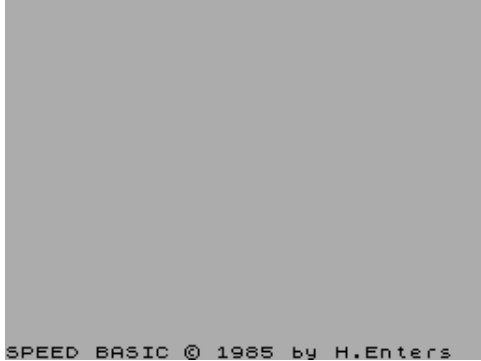

SPEED BASIC © 1985 by H.Enters
Gold (Hilderbay Ltd,1983)

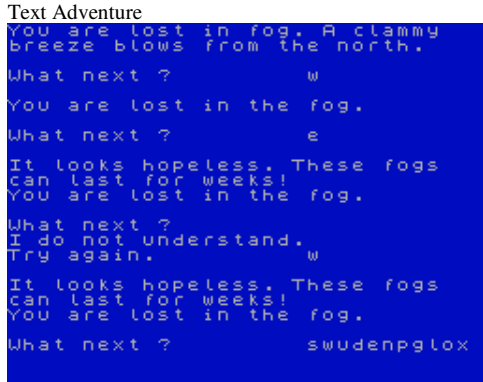

Gold Collection III, The (US Gold Ltd,1987)

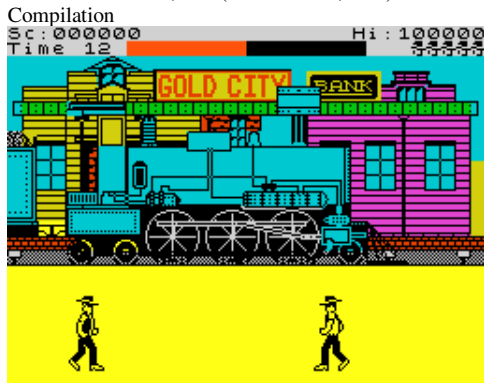

Gold Digger (Blaby Computer Games,1983)
Arcade

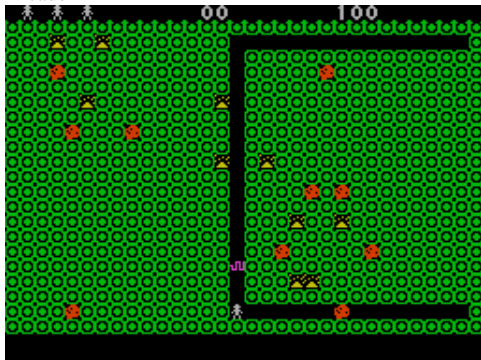

Golden Axe (Virgin Games Ltd,1990)
Arcade



Going Critical (Adventure Probe Software,1998)
Text Adventure



Gold and Silver (Darryl LeCount,1993)
Arcade

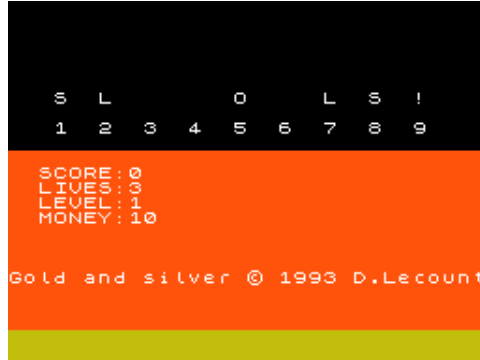

Gold Collection II, The (US Gold Ltd,1986)
Compilation



Gold Digger (Sinclair Programs,1983)
Arcade



Golden Basket (Opera Soft S.A.,1990)
Sport

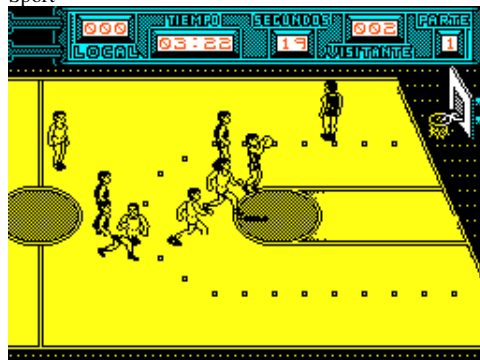

Go Kart (Xenon Software,1984)
Arcade



Gold Blast (Malan Associates,1984)
Arcade



Gold Collection, The (US Gold Ltd,1986)
Compilation



Golden Arrow (M. Price Kayem Partnership,1984)
Text Adventure

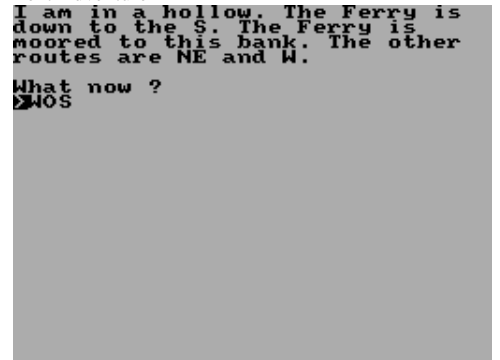

Golden Baton (Digital Fantasia,1983)
Text Adventure



Golden Chalice, The (RM Software,1984)

Text Adventure

```

east
You see:
a chest
You go east.
*****
You are in the market square of
a small, but busy village.
Doors are open to the north
and west.
A road leads out of the village
to the east.
You may go:
north south east west
You see:
nothing special.
WHAT DO YOU WISH TO DO?
"WOSL"

```

Goldene Stab, Der (Geilsoft,1984)

Text Adventure

```

WE HAVE
NO SCREENSHOT
OF THIS
PROGRAM

```

Golden Key Racing Formula, The (Annvic Racinc Ltd,1985)

Strategy

```

WE HAVE
NO SCREENSHOT
OF THIS
PROGRAM

```

Golden Rose, The (Adam Enterprises,1984)

Text Adventure

```

You are in a leafy lane
which runs east and west.
There is a signpost here.
Now what ?
WOS

```

Gold Fever (G. Kwiring,1996)

Board/Card Game



Golden Cobra, The (Chezron Software,1985)

Text Adventure

```

YOU ARE IN THE REAR COMPARTMENT
OF A SMALL AIRCRAFT WHICH HAS
LANDED AT EKALBI. THE SIDE DOOR
IS OPEN.
YOU CAN SEE A RIFLE AND A BOX OF
RATIONS.

```

Golden Figures of Death, The (Dream World Adventures,1994)

Text Adventure

```

TURNS: 2 SCORE: 0
You are standing in the 'TIME
JUMPERS' teleport compartment.
There is a panel on the wall
that is hand print operated.
Exits: >
What now Jenny?
WOS_

```

Golden Locket, The (Keith Burnard,1993)

Text Adventure

```

You find yourself amongst some
trees in a vast forest. Trails
lead North, East, South and West.
A bear is chasing you.
Here you can see:-
An old STETSON
What next pardner?
WOS+

```

Golden Sword of Bhakhor, The (Zenobi Software,1991)

Text Adventure

```

your destiny.
PRESS A KEY TO CONTINUE.....
You stand amid the dunes, before
the Great Gate into the city of
Bhakhor. Behind you, to the south,
to the east and to the west,
the caravan route is the only
mark upon the desert sands that
stretch lone and bare to the
distant horizon.
Exits lead north, east, south,
west,
what shall we do next?
.....
e
The desert winds raise the sand
in swirling storms and you lose
all sense of direction.
Exits lead north, east, south,
west,
what shall we do next?
.....
WOS

```

Goldgraber (Thoralf Klatt,1983)

Arcade Adventure

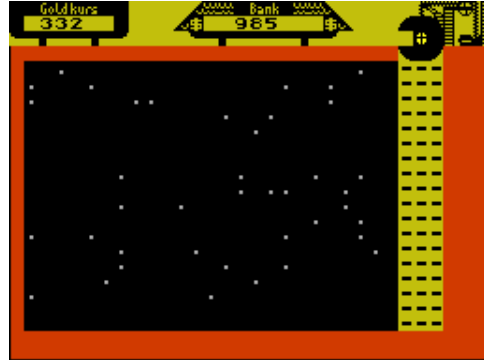

Golden Eagles (MicroHobby,1986)

Arcade

```

WE HAVE
NO SCREENSHOT
OF THIS
PROGRAM

```

Golden Hawk (Micro-Mart Software,1984)

Arcade Adventure



Golden Pyramid, The (Zenobi Software,1991)

Text Adventure

```

You have landed on top of a very
tall tree. The parachute has
tangled itself in the branches
and you appear to be stuck up
there.
YOU NOTICE:
A hovering tropical bird
*D
You can't....yet
*WOS*

```

Golden Voyage (Adventure International,1985)

Text Adventure

```

WE HAVE
NO SCREENSHOT
OF THIS
PROGRAM

```

Gold Idol, The (Infected Software,1987)

Text Adventure

```

a well worn path, you can see a
small village.
What now ?.... w
Sorry, but you can't.
What now ?.... e
You are now on a wide path
leading from a large plateau to
the west, to a small village
east. A rough track leads north
through the undergrowth.
What now ?.... n
The path here is swamped by
undergrowth and various insects
fly about on their daily
routines before your eyes. The
path now splits, leaving exits
of south and northeast.
What now ?.... WOS

```

Goldilocks (Arrow,1984)
Educational



Gold Rush (Thorn Emi Video Ltd,1983)
Arcade

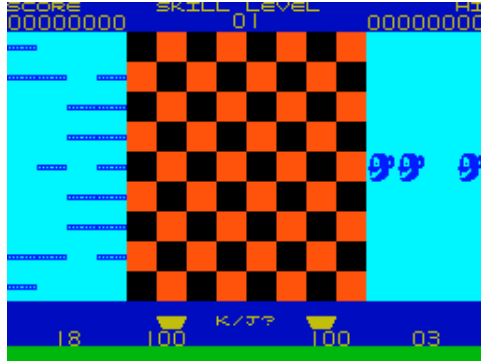

Gold Stadt (Aqua Soft,1984)
Text Adventure



Golf (16/48 Tape Magazine,1985)
Sport



Golf (Breadhill,1984)
Sport



Gold Mine (DK'Tronics Ltd,1983)
Arcade

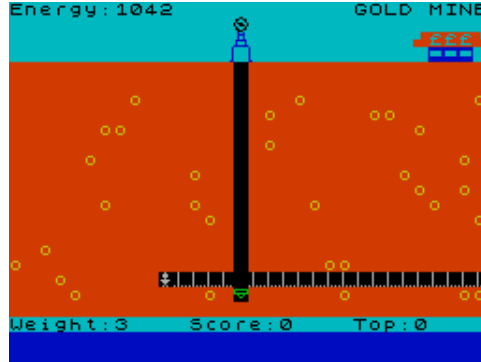

Gold Seeker (W.D. Fisher,1984)
Text Adventure

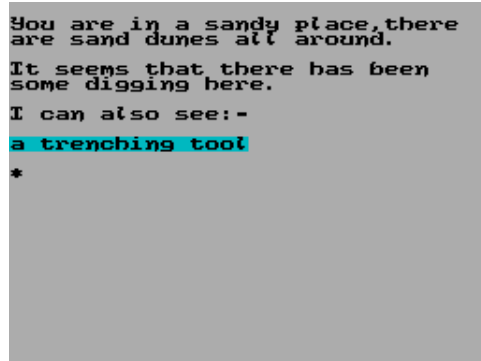

Gold Truck (Fontana Publishing,1984)
Arcade



Golf (Abrasco,1983)
Sport



Golf (Chromasoft,1982)
Sport

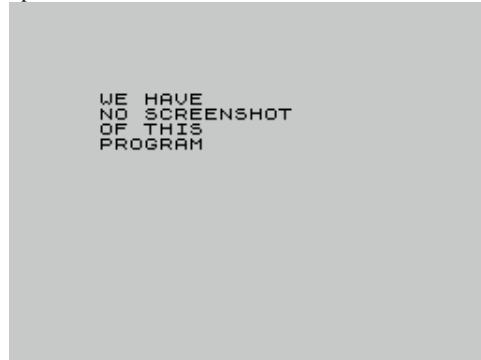

Goldmine (Memotronic,1984)
Arcade



Gold, Silver, Bronze (US Gold Ltd,1988)
Compilation



Goldwood (Xcellent Software,)
Text Adventure

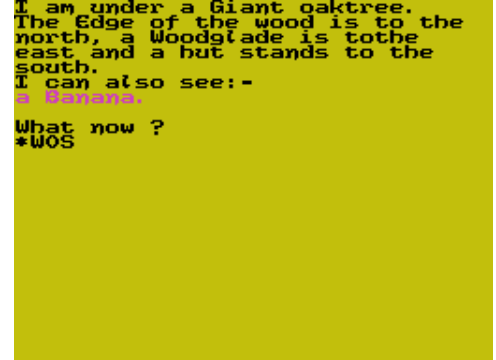

Golf (Add-On Electronics Ltd,1983)
Sport



Golf (DK'Tronics Ltd,1983)
Sport

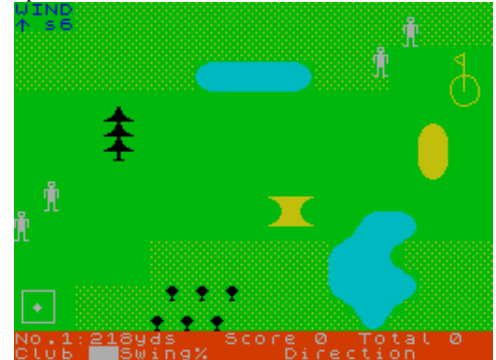

Golf (Lyversoft,1983)



Golf (Virgin Games Ltd,1983)

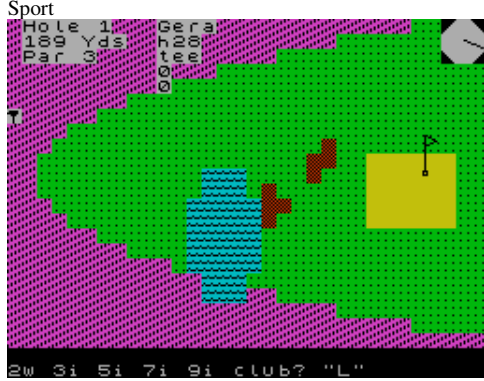

Golf 80 (Sinclair Programs,1983)

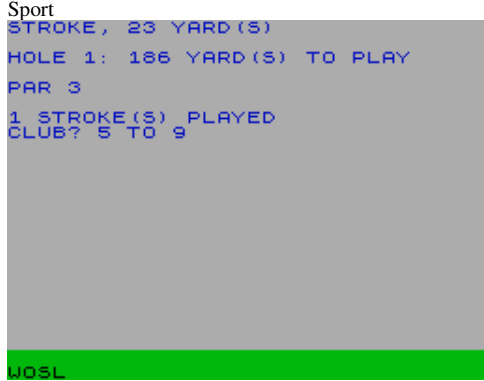

Goliath (Proxima Software,1991)



Go Micro (Longman Software,1984)



Golf (Meow Micros,1983)



Golf + Bar Billiards (Meow Micros,1983)

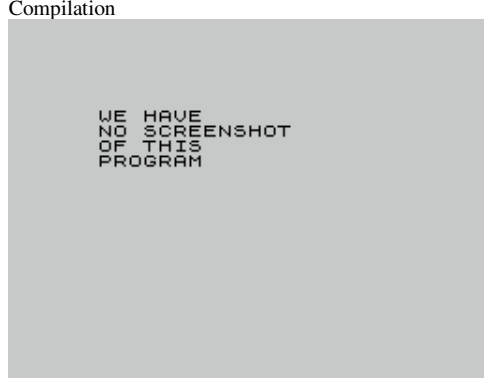

Golfing World (CP Software,1983)



Golpe, El (Software Center S.A.,1983)

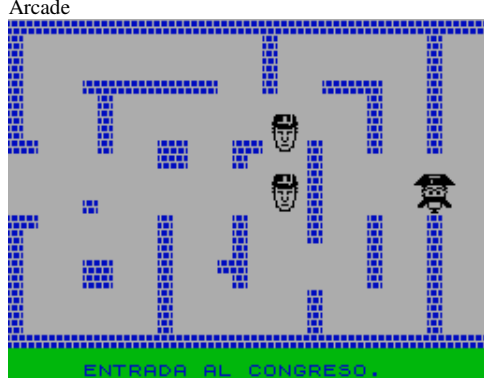

Gomoku (MicroHobby,1985)

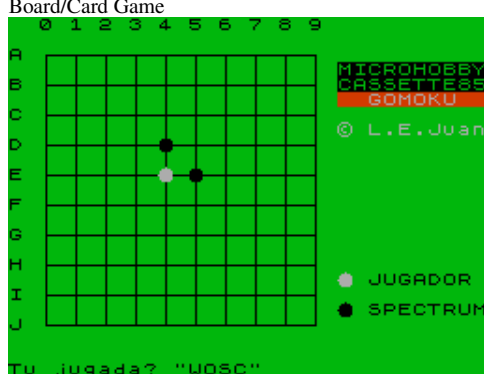

Golf (Microparadise Software,1984)

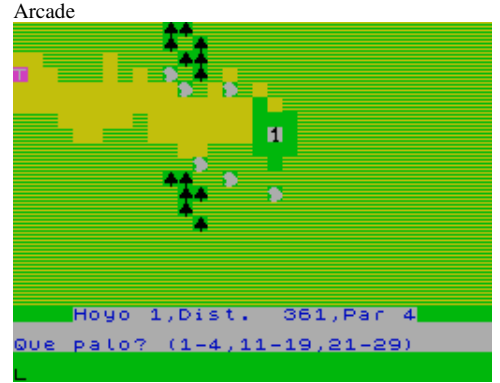

Golf, 3D (.)



Golf Scorecard (Tartan Software,.)

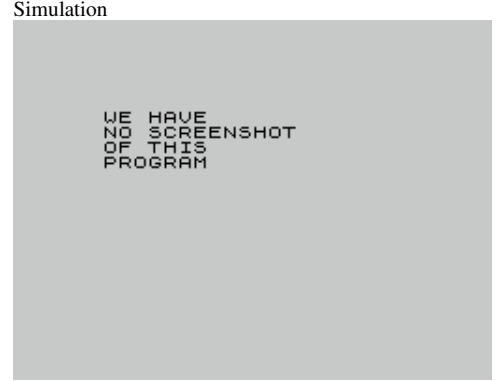

Gombfoci (Interbit Software,1984)

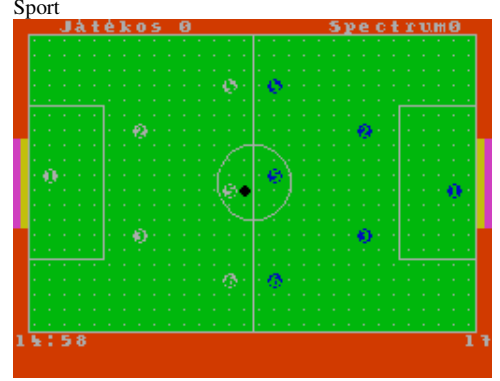

Gomoku (Scsibrany Software,1984)



Gondoliers, The (Garry Rowland,)
Music



Gonzalez (Opera Soft S.A.,1989)
Arcade Adventure



Good Questions - Lifeskills (MNL Software,1987)
Educational

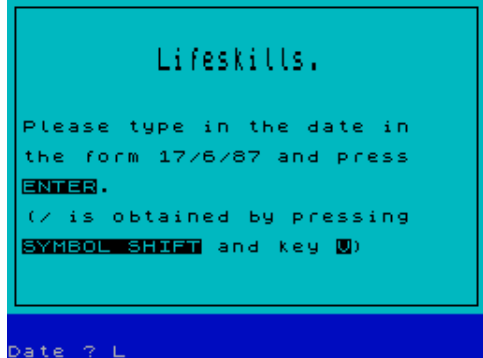

Goofy's Railway Express (Disney Software,1991)
Educational



Goof's Exit (Green Fish Software Enterprise,1986)
Arcade

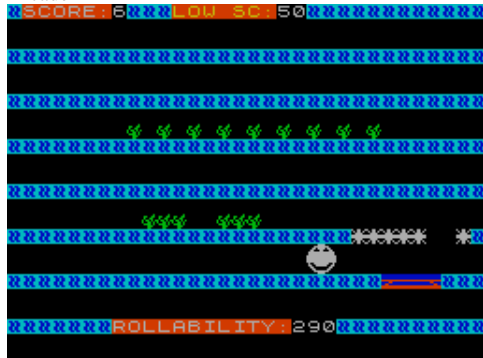

Gone Missin' (Excalibur Software,1986)
Text Adventure

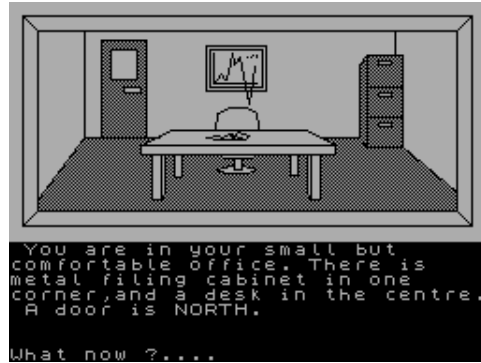

Good Luck! (unpublished,1985)
Board/Card Game



Good Questions - Relationships (MNL Software,1987)
Educational

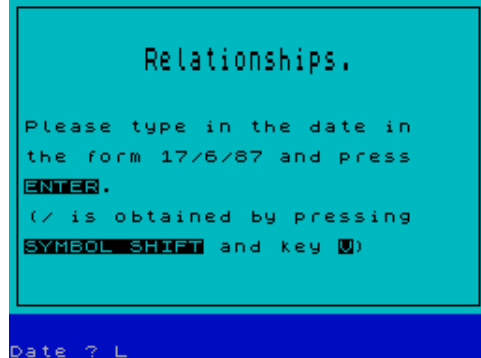

Goof (Green Fish Software Enterprise,1984)
Arcade

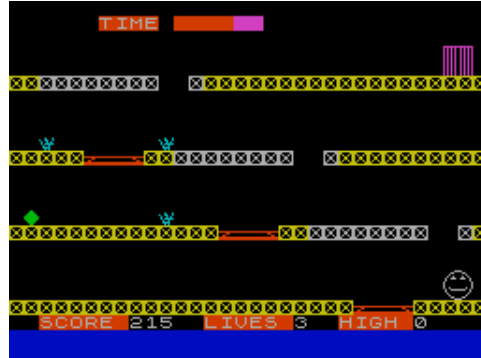

Goonies, The (US Gold Ltd,1986)
Arcade



Gonuffos (MicroHobby,1985)
Arcade

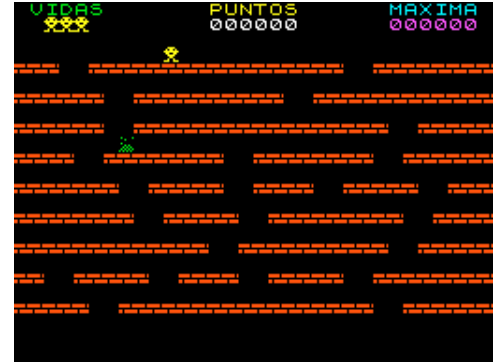

Good Questions - Lawbreaking (MNL Software,1987)
Educational

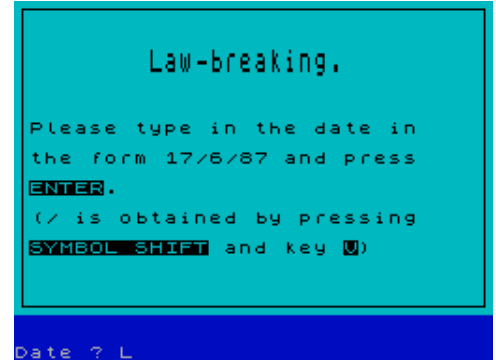

Goody (Opera Soft S.A.,1987)
Arcade

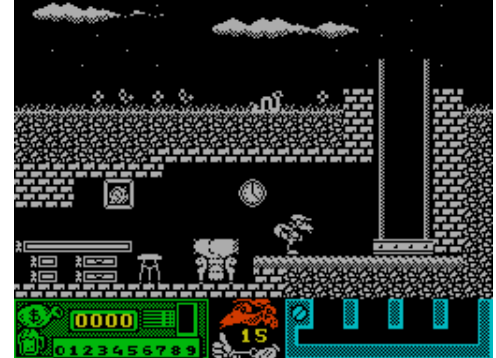

Goof Returns (Green Fish Software Enterprise,1984)
Arcade



Gop Demo 1 (RST7,1992)
Scene Demo



Gordello Dynasty, The (Tartan Software,)
Compilation



Gordess (PO Box 1520,1986)
Text Adventure



Gorila, El (MicroHobby,1985)
Arcade

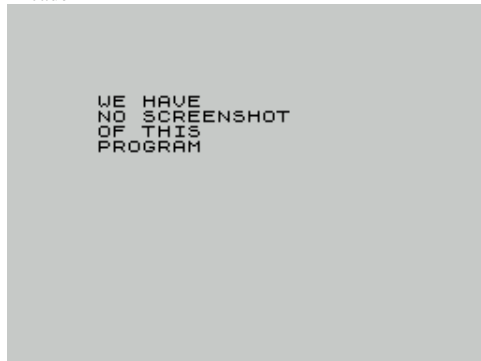

Gotcha (Blaby Computer Games,1983)
Arcade

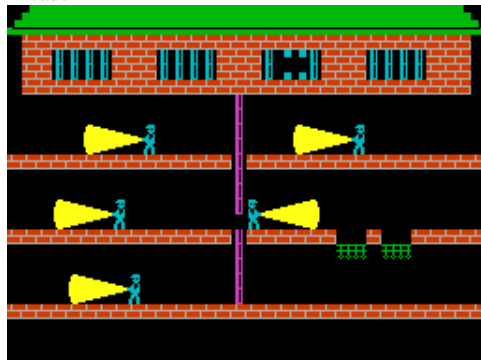

Go to Hell 2 (Frittle-Six,) Scene Demo



Gordello Incident, The (Tartan Software,1989)
Text Adventure



Gorfian Invaders (C-Tech,1983)
Arcade

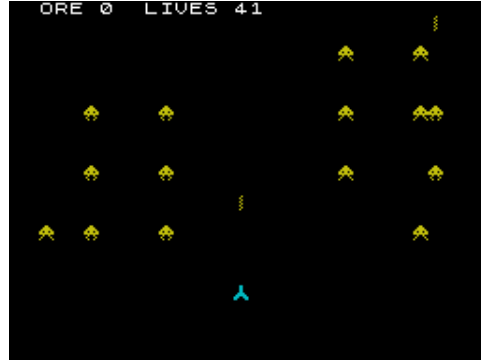

Gorodki (Spark,1996)
Arcade

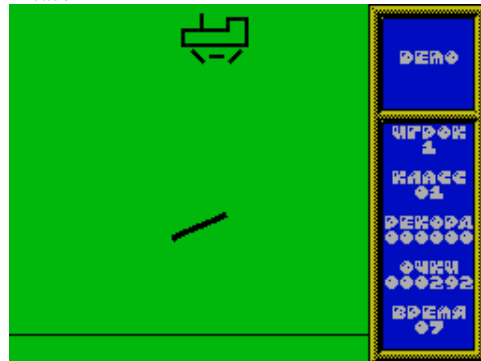

Gothik (Firebird Software Ltd,1987)
Arcade Adventure

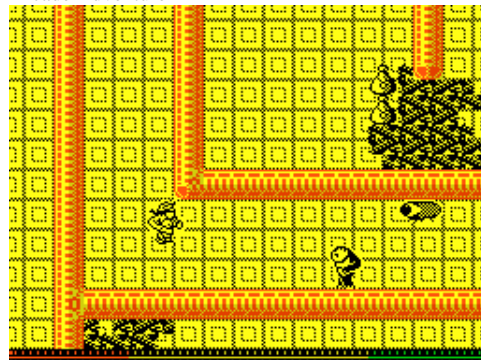

Go to Jail (Automata UK Ltd,1983)
Board/Card Game



Gordello's Demise (Tartan Software,1991)
Text Adventure

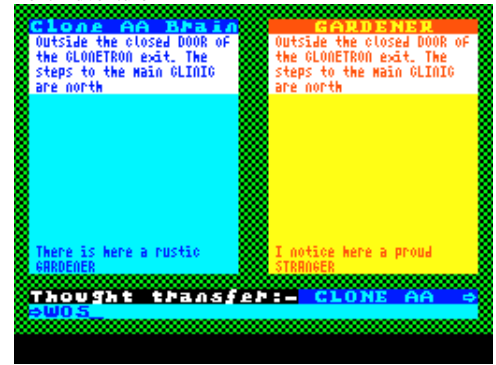

Gorgon (Phipps Associates,1983)
Arcade

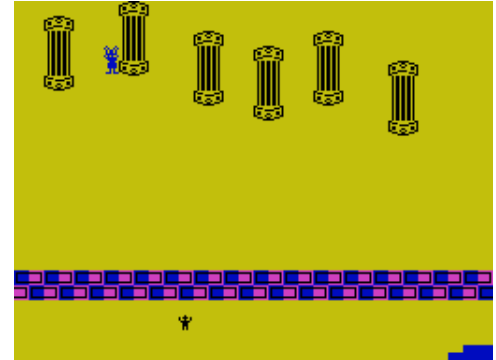

Gossip (Eugenio Ciceri,) Utility

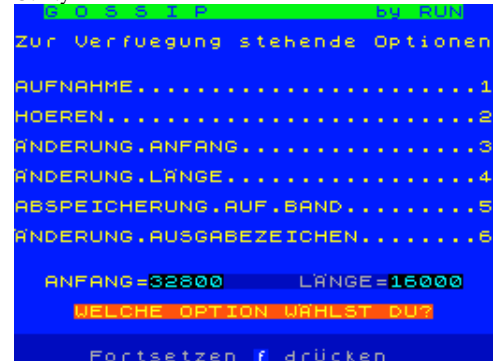

Go to Hell (Triple Six,1985)
Arcade

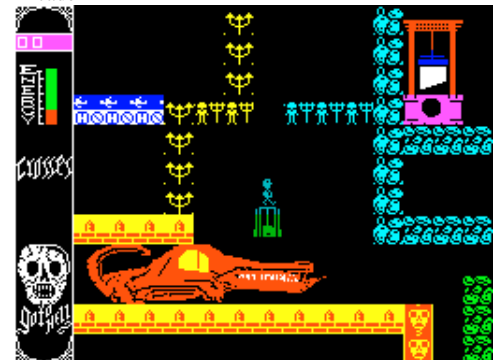

Got to Get (The President,1990)
Scene Demo

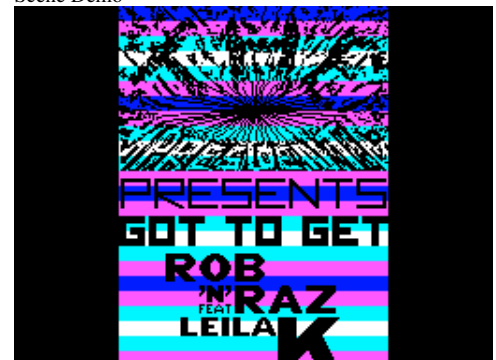

Go West Young Man (Stocksoft,1984)

Text Adventure

```
You are at the beginning of the
main street.
There is a sign that says;
"DEADWOOD
POPULATION:47
VISITORS NOT WELCOME!"
Exits:-N,E,S,W
Now What ?
>WOS
```

Grabador de EPROM (MicroHobby,1985)

Utility

```
WE HAVE
NO SCREENSHOT
OF THIS
PROGRAM
```

Graeme Souness Soccer Manager (Zeppelin Games Ltd,1992)

Simulation

DEFENDERS					
NAME	POS	AGE	GOALS	1ST	SUB
G FORSTER	GR	25	0	0	
H GOURI	LB	24	25	0	
H TYES	LB	29	0	0	
J HEADS	CD	21	0	0	
O CALDWELL	CD	23	13	0	
I TALIFORD	CD	26	0	0	
K WAUGH	RB	22	0	0	

FITNESS
ABILITY

EXIT [down] [up]

Graf Eddi (Starcomp,1985)

Utility: Screen Manipulation

CHAR 1	CHAR 2	NORMCHAR
ROTATE	MIRROR H	MIRROR V
COPY	MOVE	DELETE
FETCH	INVERSE	ZOOM
ATTR	RECALL	BACKUP
LD 1--5	PRINT	EX CHAR
OR 5--1	OR 5--2	SCHATT
EX 5--1	EX 5--2	SINCLAIR
EIGEN	SAVE	DSAVE
CATALOG	LOAD	DLOAD
ERASE	LOAD CH	DLOAD CH

Graficos (MicroHobby,1985)

Utility: Mathematics

```
WE HAVE
NO SCREENSHOT
OF THIS
PROGRAM
```

GP Formula 1 Simulator (Diabolic Software,1991)

Arcade



Grabbed by the Ghoulies! (FSF Adventures,1993)

Text Adventure

```
You find yourself stuck in a
damp, dingy cell. The walls are
covered in moss and, due to the
fact that there are no windows,
it is pretty dark. The only
light comes through the bars in
the door.
The door leads north.
*****
*N
The door is closed, and locked
from the other side.
*****
*WOS*
```

Graf 2 (.)

Utility: Mathematics

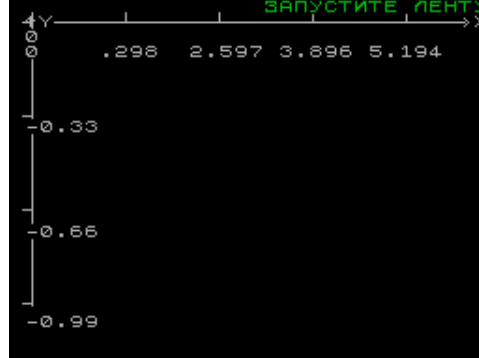

GraffiXmax (Impact Software [2],1996)

Utility



Graficos de Barras (MicroHobby,1985)

Utility: Mathematics

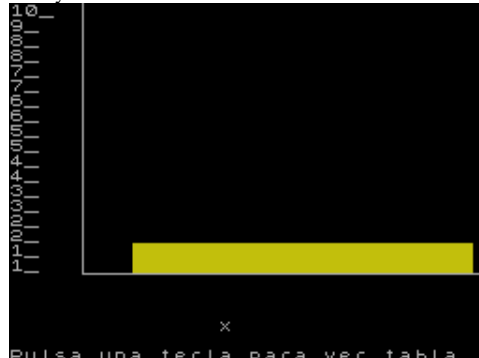

GP Motocross (Ventamatic,1985)

Arcade

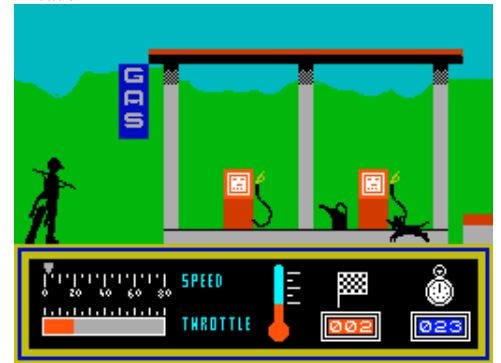

Grab of a Territory (Free Group,1996)

Board/Card Game

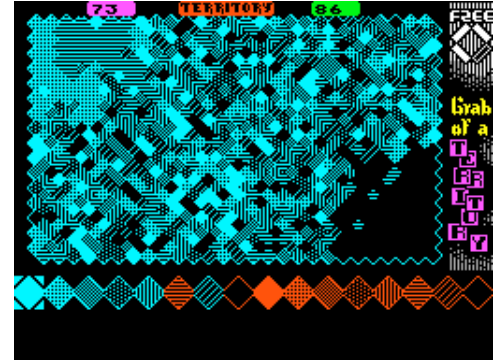

Graf 3 (.)

Utility: Mathematics

```
WE HAVE
NO SCREENSHOT
OF THIS
PROGRAM
```

Graficas de Gestion (DIMENSIONNEW/Idealogic S.A.,1984)

Utility



Graficos de Empresa (MicroHobby,1985)

Utility: Mathematics

```
WE HAVE
NO SCREENSHOT
OF THIS
PROGRAM
```

Graficos de Personajes (MicroHobby,1985)
Utility

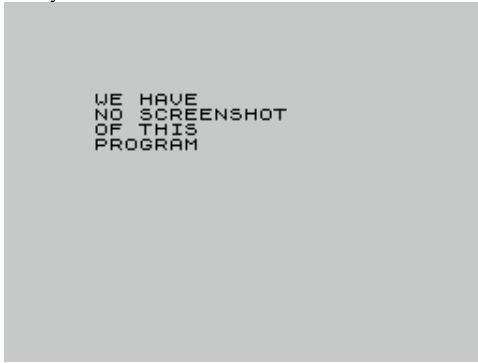

Graficos Estadisticos (MicroHobby,1985)
Utility: Mathematics



Grafik (.)
Utility: Drawing

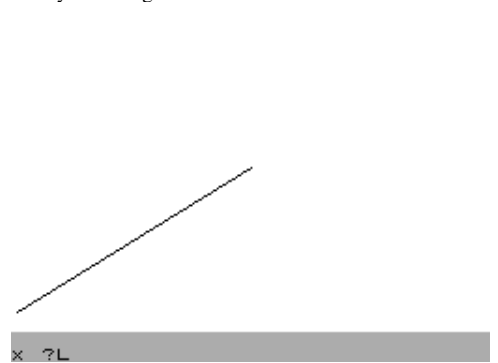

Grafik 3D (.)
Utility: Mathematics

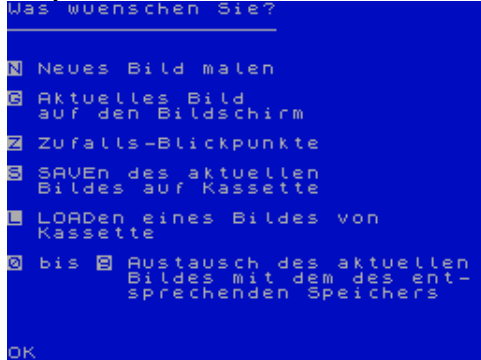

Graham Gooch's Test Cricket (Audiogenic Software Ltd,1986)
Simulation

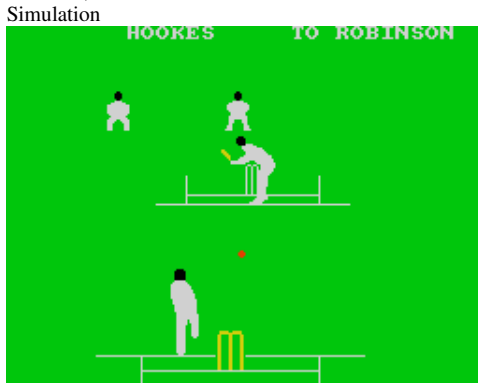

Graham Grass Snake (Micro Press [1],1983)
Arcade

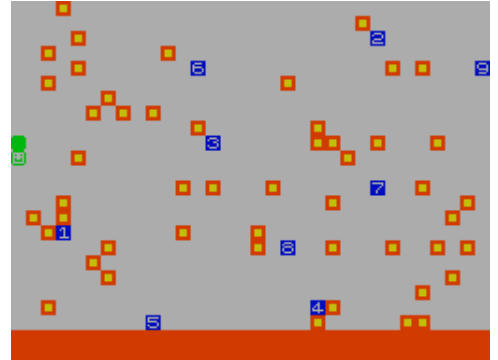

Grail (Severn Software,1983)
Text Adventure



Gramatica Inglesa (Microparadise Software,1985)
Utility

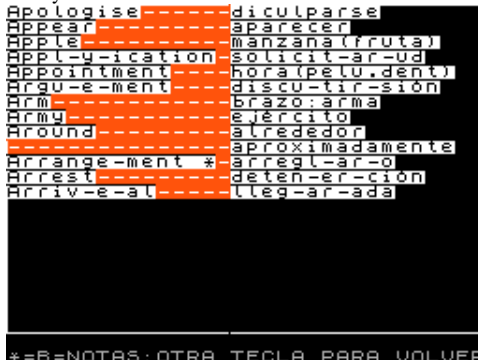

Grametica Inglesa (Microparadise Software,1985)
Educational

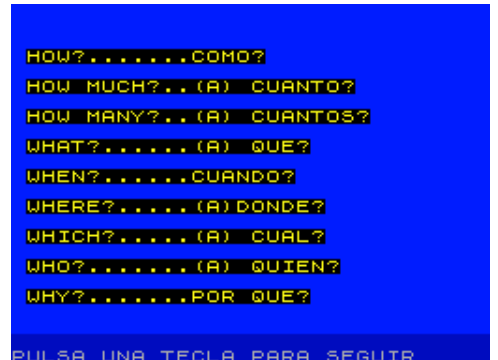

Grammar Tree, The: Nouns & Adjectives (Sulis Software Ltd,1983) Educational

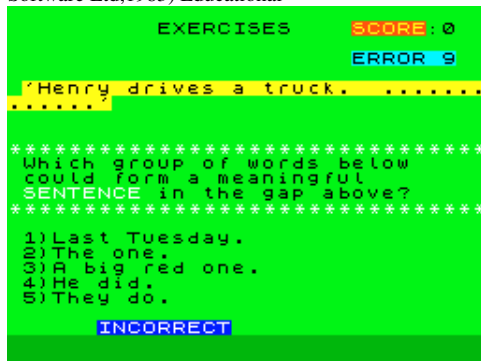

Grammar Tree, The: Sentences (Sulis Software Ltd,1983) Educational

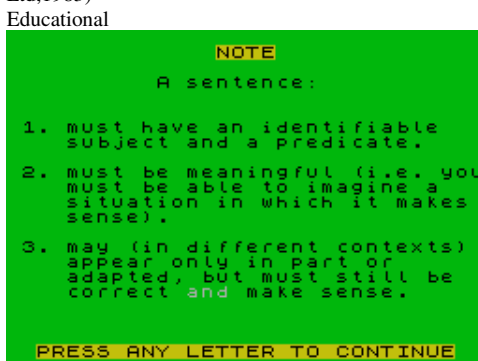

Grammar Tree, The: Verbs & Adverbs (Sulis Software Ltd,1983) Educational

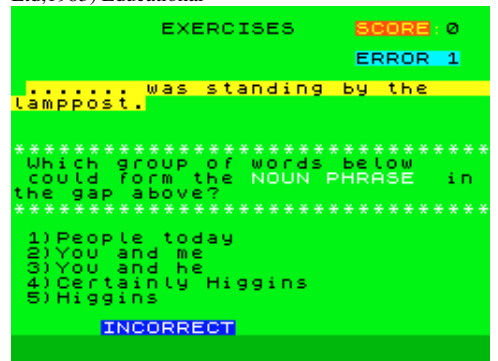

Gran Bingo (Ediciones y Textos S.A.,1985)
Board/Card Game

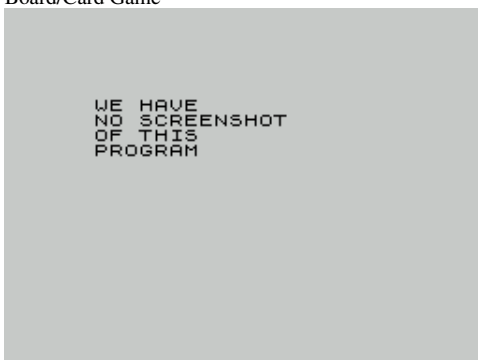

Grand-Mix (Dennis van Berkel,1989)
Scene Demo



Grand National (CRL Group PLC,1983)
Sport



Grand National (Elite Systems Ltd,1985)
Simulation

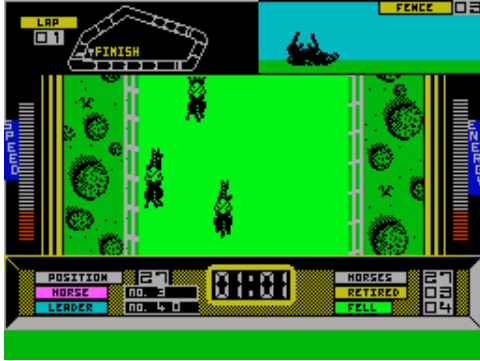

Grand Prix (Contrast Software,1983)
Arcade



Grand Prix + Rally Z (Contrast Software,1983)
Compilation



Grand Prix Circuit (Accolade Inc,1990)
Arcade



Grand Prix Manager (Silicon Joy,1984)
Simulation



Grandpa Joe Plays the Open (Global Games [2],1986)
Sport

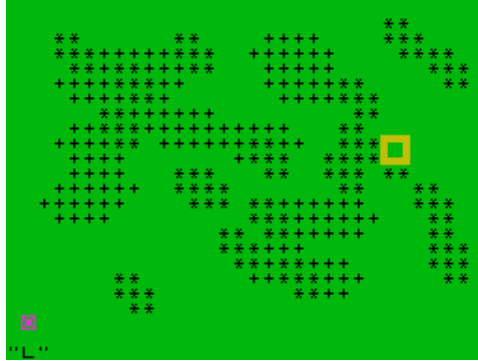

Grand Prix (D&H Games,1989)
Simulation



Grand Prix Challenge (Challenge Software,1992)
Simulation



Grand Prix Driver (Britannia Software Ltd,1983)
Arcade



Grand Prix Riders (Vinsoft,1989)
Strategy



Grand Prix (Britannia Software Ltd,1985)
Arcade



Grand Prix (MicroHobby,1985)
Arcade



Grand Prix Championship, 3D (Zeppelin Games Ltd,1991)
Arcade

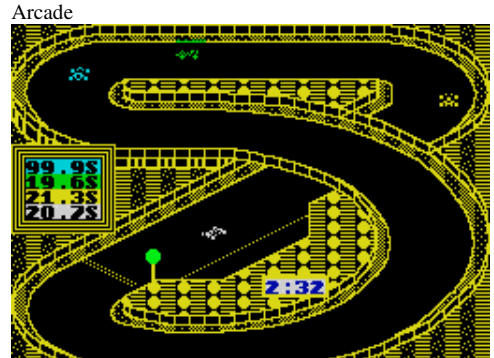

Grand Prix Drivers (Grafix Wizards,1992)
Arcade



Grand Prix Selection (Electric Dreams Software,1986)
Compilation

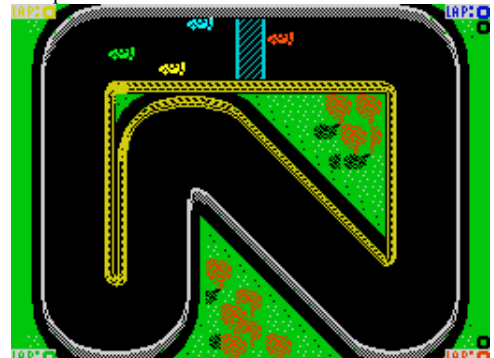

Grand Prix Simulator (Code Masters Ltd,1987)
Arcade



Grand Prix Simulator 2 (Code Masters Ltd,1989)
Arcade



Grand Prix Tennis (Mastertronic Added Dimension,1988)
Sport

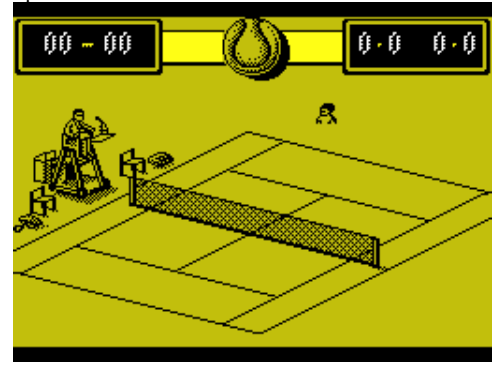

Grand Slam Tennis (Grandslam Entertainments Ltd,1990)
Sport



Grandstand (Domark Ltd,1991)
Compilation



Grange Hill (Argus Press Software Ltd,1987)
Arcade Adventure



Gran Hazana, La (Thedar Works,)
Text Adventure



Granja (MicroHobby,1985)
Arcade



Granny's Garden (4Mation Educational Resources Ltd,1983) Educational

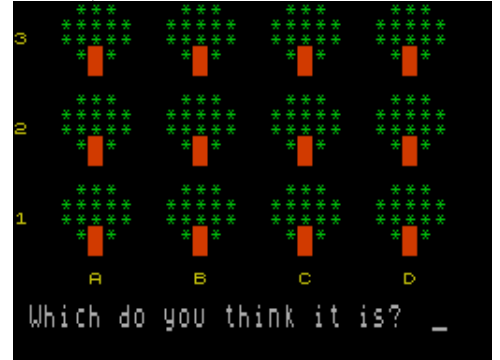

Gran Prix (Grupo de Trabajo Software S.A.,1987)
Arcade



Graphic Adventure Creator (Incentive Software Ltd,1986) Text Adventure Development Tool

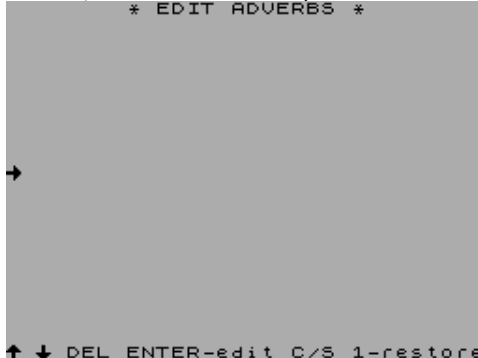

Graphic Adventure Creator - Advinman (Incentive Software Ltd,1986) Text Adventure Development Tool



Graphic Adventure Creator - Packer (Essential Myth,1987) Text Adventure Development Tool

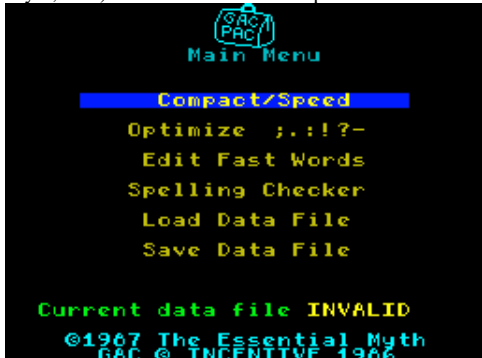

Graphic Creator (Llamasoft,1982)
Utility

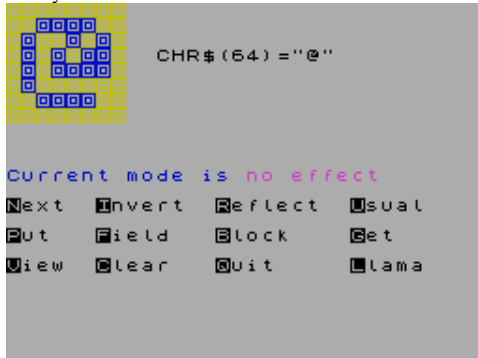

Graphic Editor, The (.)
Utility: Font/UDGs

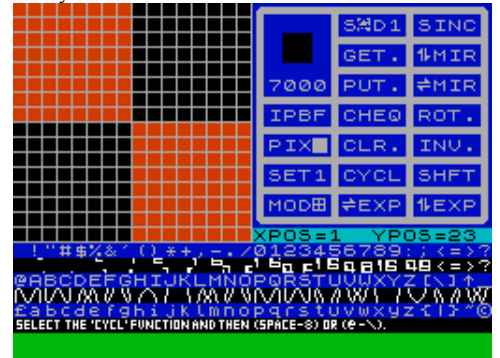

Graphic Library (R.D. Foord Software,1984)



Graphics 2 (.)



Graphics Kit (Softek Software International Ltd,1983)



Graphik Code Program (Stephan Slabihoud,1985)



Graph Plotter, 3D (Your Computer,1983)

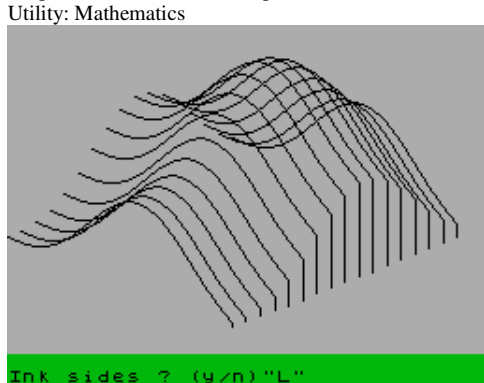

Graphics (16/48 Tape Magazine,1985)



Graphics, 3D (.)



Graphic's Master (Infotech,)



Graphik Compiler (Stephan Slabihoud,1986)



Grasp (Camel Micros,1983)



Graphics 1 (.)



Graphics Aid (Spectrum Computing,1983)



Graphics Utility (.)



Gravix (16/48 Tape Magazine,1985)



Gravely Manor (R.D. Foord Software,)



Gravity Wars (Scorpion Software,1996)
Arcade



Great Detective, The (CRL Group PLC.)
Text Adventure



Greatest Show on Earth, The (Central Solutions,1986)
Arcade

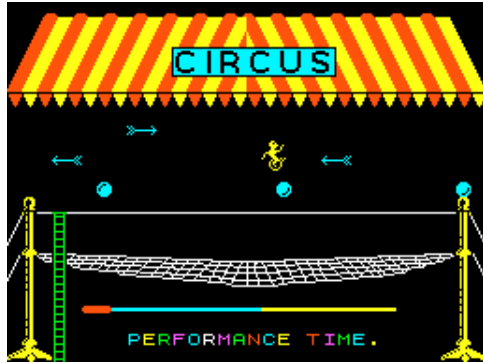

Great Fire of London, The (Rabbit Software Ltd,1985)
Arcade

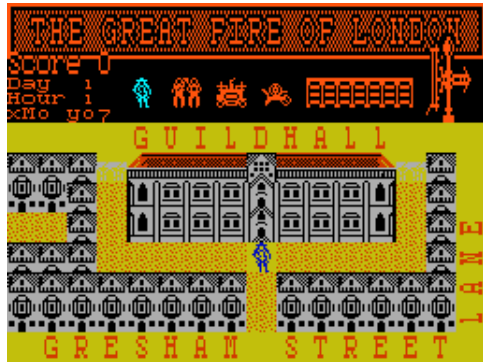

Great Hedgehog Massacre, The (CDT/R.U.P.,1993)
Scene Demo

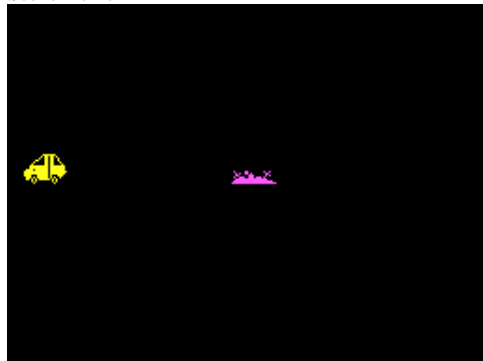

Great Britain Ltd (Hessel Software,1982)
Simulation

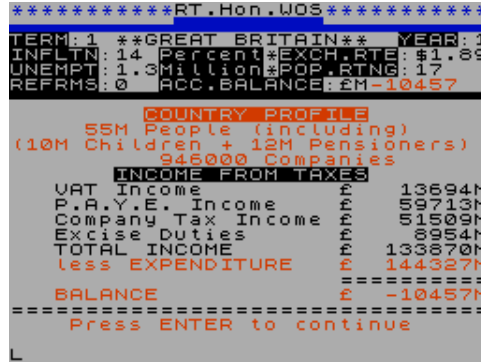

Great Escape, The (Ocean Software Ltd,1986)
Arcade

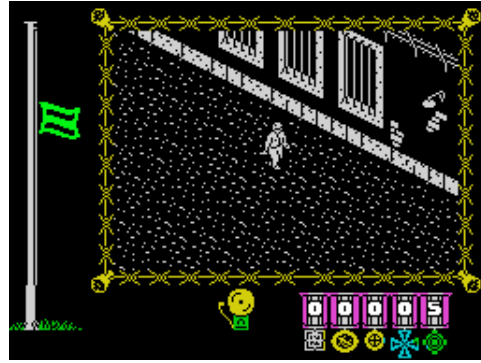

Great European Road Race (Activision Inc.)
Arcade

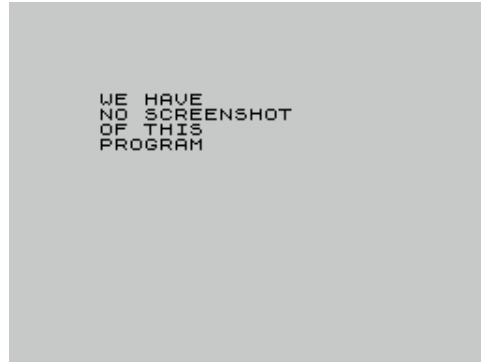

Great Giana Sisters, The (Rainbow Arts.)
Arcade



Great Music Collection, The (Pentagram,1992)
Scene Demo



Great Buns (Adrian,1990)
Scene Demo



Greatest Hits of Kolesnik Andrei (Oscar & Spielberg.)
Scene Demo



Great Fire of London, The (Phipps Associates,1982)
Arcade

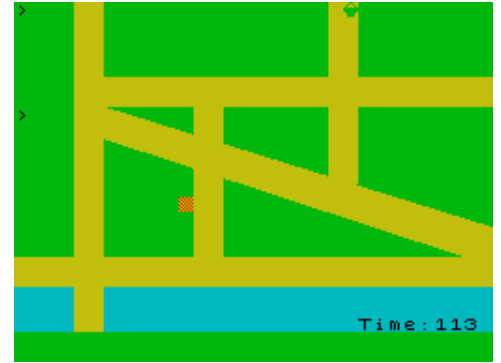

Great Gurianos (Encore,1987)
Arcade



Great Peepingham Train Robbery, The (Top Ten Software,1988)
Text Adventure

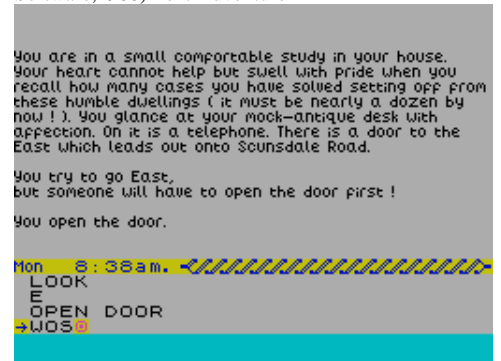

Great Shit (Hacker Chris,1988)
Scene Demo



Grebit (Alternative Software Ltd,1992)
Arcade

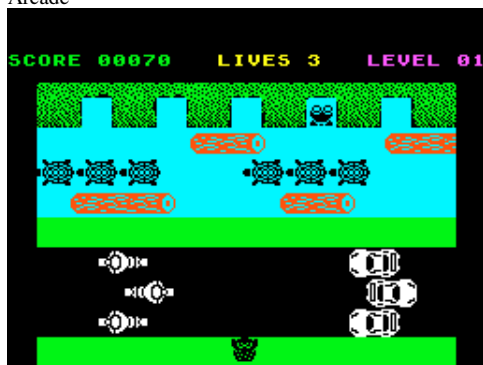

Green Beret (Imagine Software Ltd,1986)
Arcade

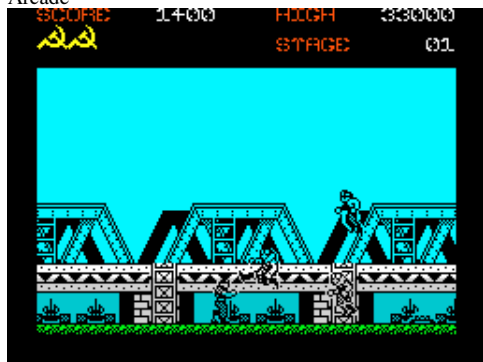

Green Sonja (Psychaedelic Hedgehog Software,1991)
Text Adventure

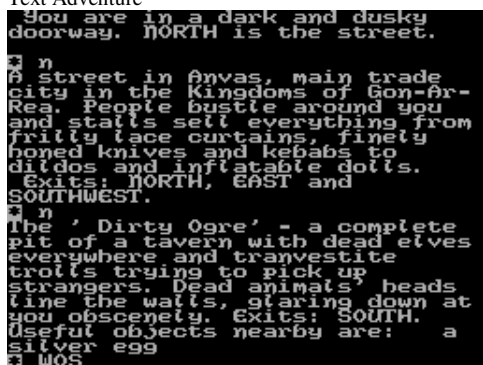

Grell and Fella (Code Masters Ltd,1992)
Arcade Adventure

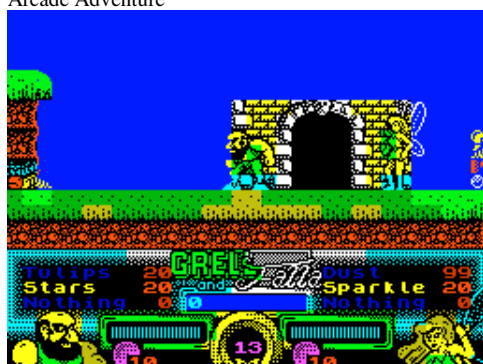

Great Space Race, The (Legend,1984)
Strategy

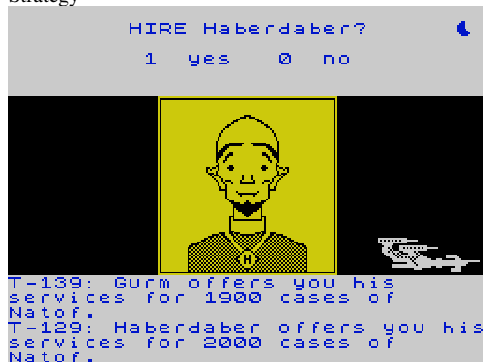

Greedy Dwarf, The (Goldstar,1984)
Text Adventure



Green Death, The (Casventures Ltd,1988)
Text Adventure



Gregory Loses His Clock (Mastertronic Plus,1989)
Arcade



Gremlins (Thor Computer Software,1984)
Arcade



Great Western, The (Newsoft Products,1982)
Arcade

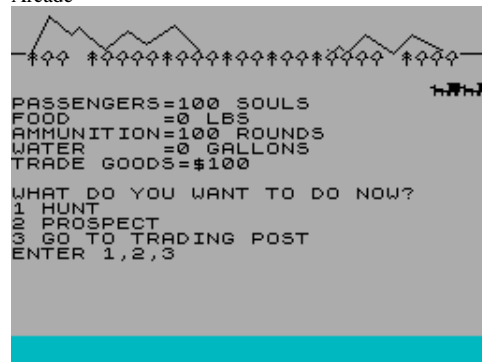

Greedy Gulch (Phipps Associates,1983)
Text Adventure

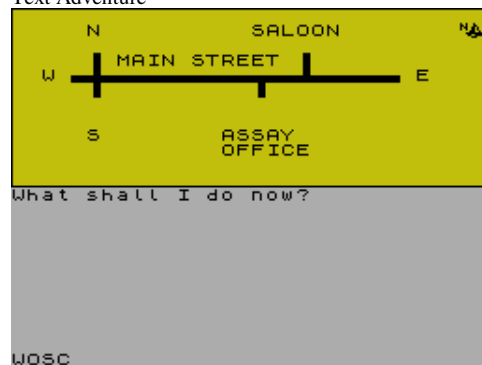

Green Door, The (Tartan Software,1988)
Text Adventure

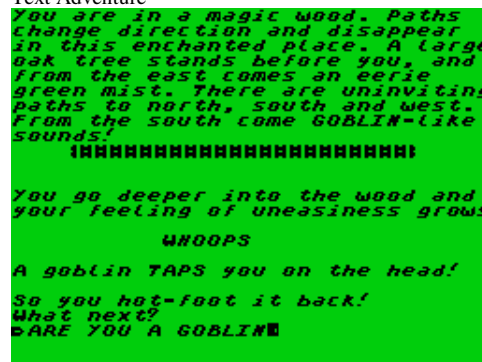

Greg the Egg (unpublished,)
Text Adventure

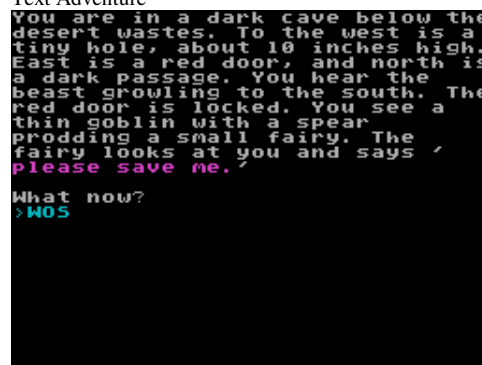

Gremlins 2: La Nueva Generacion (Topo Soft,1990)
Arcade Adventure



Gremlins - The Adventure (Adventure International,1985)
Text Adventure



Grey Island (CV Software,1989)
Text Adventure

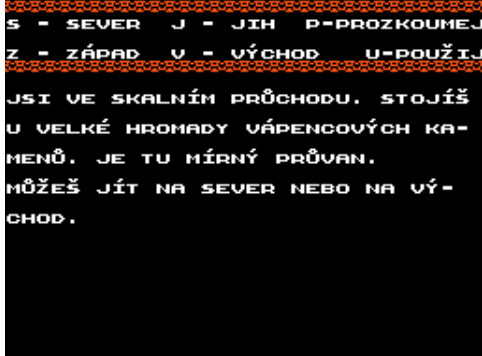

Grid Gate (Omega Software Ltd,1984)
Arcade

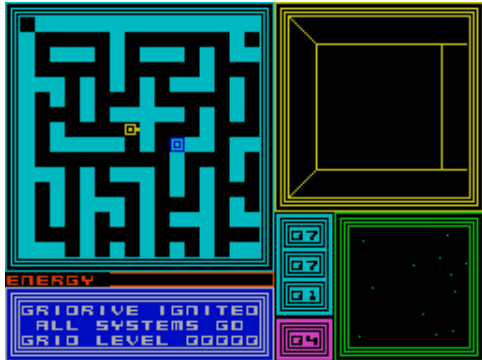

Grid Patrol (MC Lothlorien Ltd,1984)
Arcade

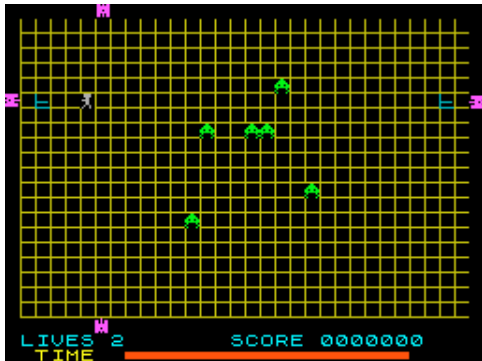

Grid-Run + Pontoon (Arcade Software,1983)
Compilation

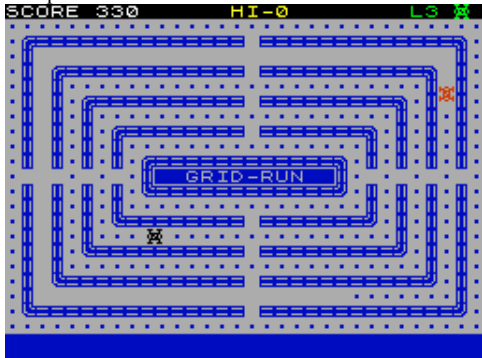

Greyfell (Starlight Software,1987)
Arcade Adventure



Grid-Bug (Add-On Electronics Ltd,1983)
Arcade

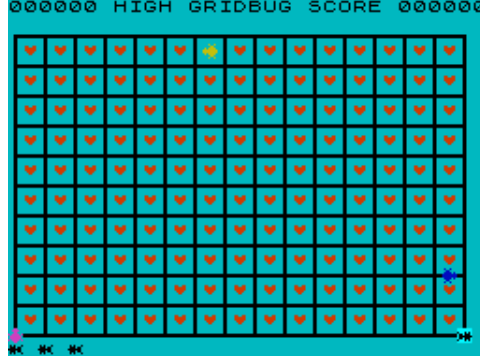

Grid Iron 2 (Alternative Software Ltd,1989)
Simulation



Grid Quest (Voyager Software,1984)
Arcade

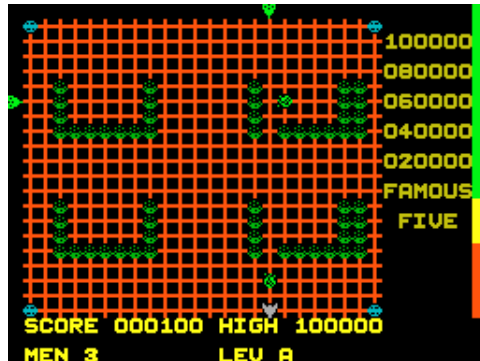

Gridrunner (Quicksilva Ltd,1983)
Arcade



Greyhound Master (Bastec Software,1988)
Simulation



Grid/Frame/Truss (S. Okoloku,1986)
Utility



Grid Master (Procom Software,1983)
Arcade



Grid-Run (Arcade Software,1983)
Arcade

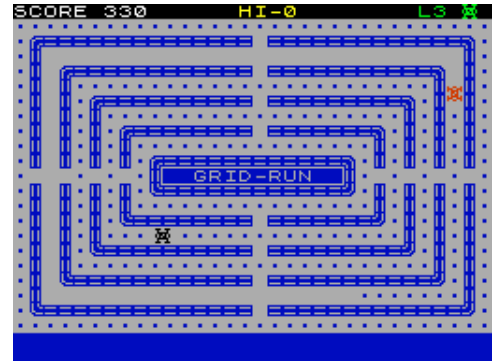

Gridrunner 2: Matrix (Salamander Software,1984)
Arcade



Grid Trap (Live-Wire Software,1986)

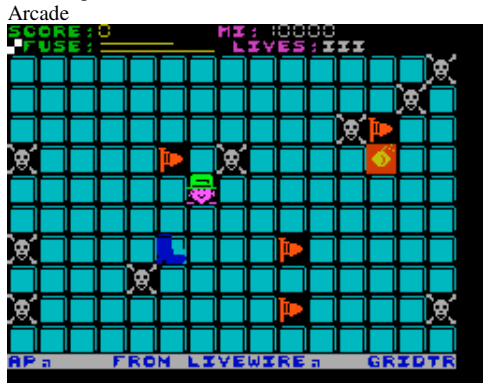

Grimble (Microtechnica,1986)



Grosse Draisinenrennen, Das (Paulin,.)

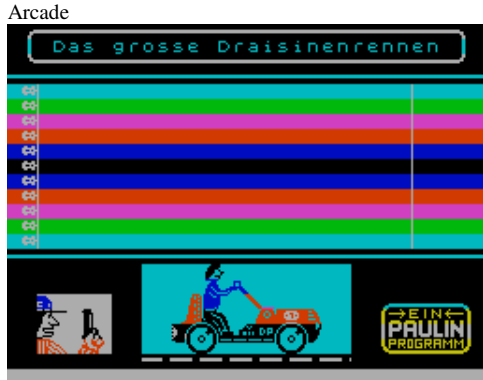

Ground Attack + Orbiter (Investronica S.A.,)



Growing Pains of Adrian Mole, The (Virgin Games Ltd,1987)



Grid Zapper (16/48 Tape Magazine,1984)

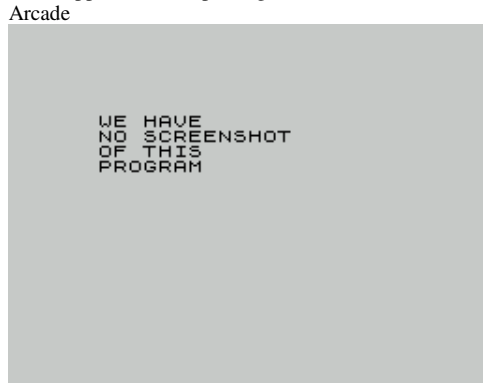

Grimwold's Big Adventure (The Adventure Workshop,1995)

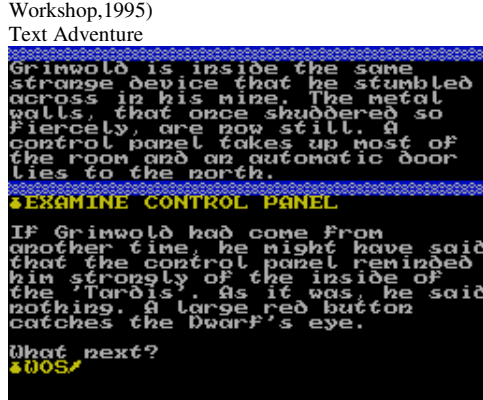

Grosse Preis, Der (P. Soult,1984)



Ground Force Zero (Titan Programs,1982)

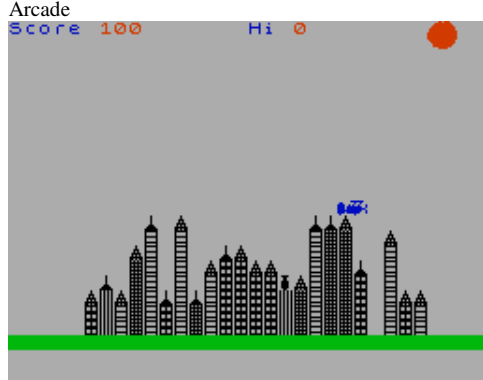

Grue-Knapped (FSF Adventures,1991)



Grimalkin 128K (Simon Wood,1989)



Grljevca (Alivojvodic Nikola,1987)



Ground Attack (Silversoft Ltd,1982)

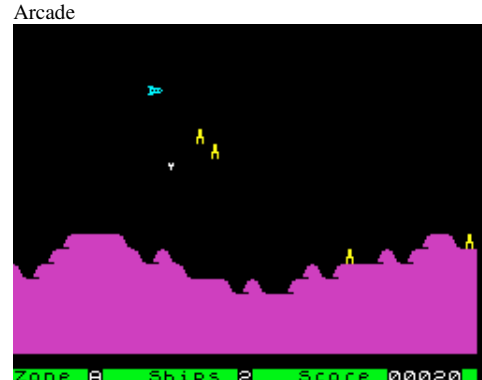

Grouse Shoot (Stack Computer Services Ltd,1983)



Grue-Knapped + Helvera: Mistress of the Park (FSF Adventures,1991) Compilation



Gruft (R. Fuchs,1984)

Text Adventure

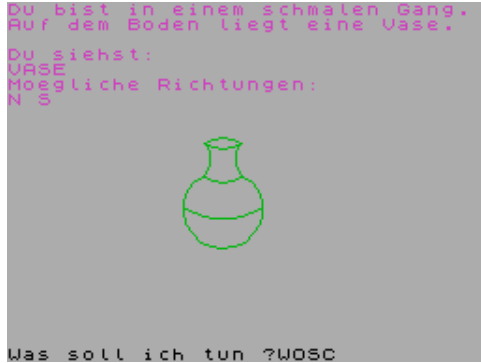

Gryzor (Ocean Software Ltd,1987)

Arcade



Guardian II: Revenge of the Mutants (Hi-Tec Software Ltd,1990) Arcade



Guerra de las Vajillas, La (Dinamic Software,1987)

Text Adventure



Guerra Submarina (MicroHobby,1985)

Arcade



Grumphers (Sinclair Programs,1983)

Arcade



Guadalcanal (Activision Inc,1987)

Strategy

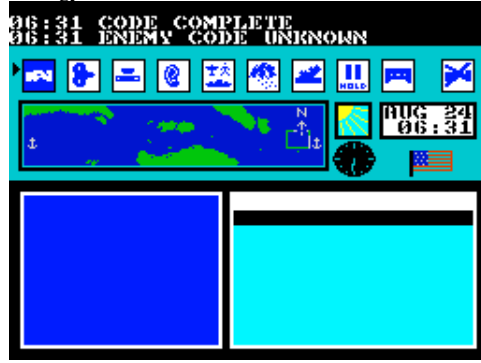

Guardian, The (PSS,1983)

Arcade

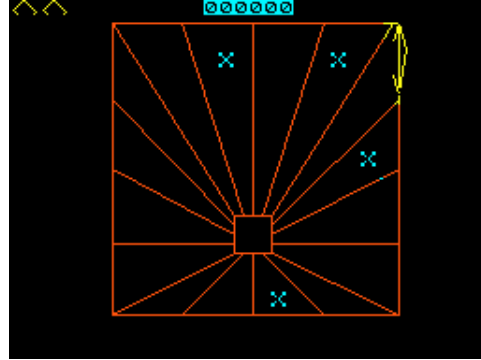

Guerra Galactica (Microparadise Software,1984)

Arcade



Guerreros Carlistas (Software Center S.A.,)

Strategy



Grumpy Gumphrey Supersleuth (Gremlin Graphics Software Ltd,1985) Arcade Adventure



Guante Blanco (Alien Software,1993)

Text Adventure



Guardian, The (The Guild,1994)

Text Adventure

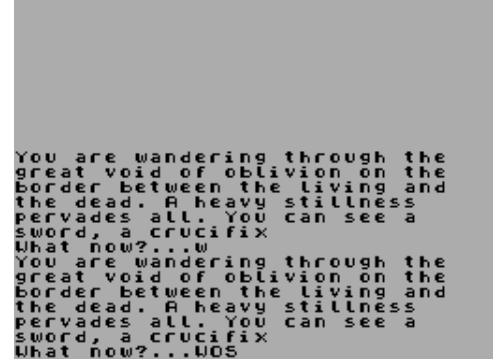

Guerra, La (,)

Text Adventure



Guerrilla War (Imagine Software Ltd,1988)

Arcade

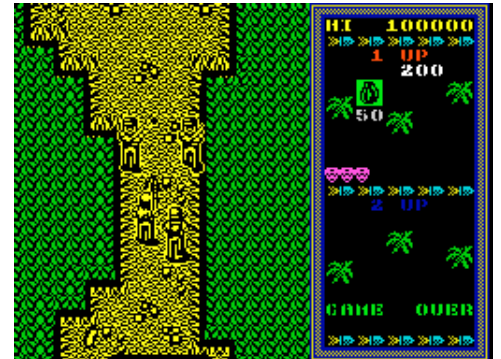

Guest, The (Stephen Wadsworth,1987)
Text Adventure

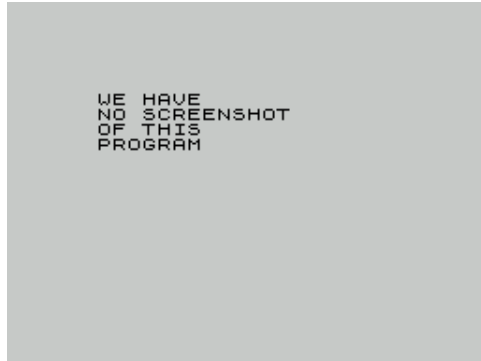

Guide to Greater London (Delta 4 Software,1985)
Educational

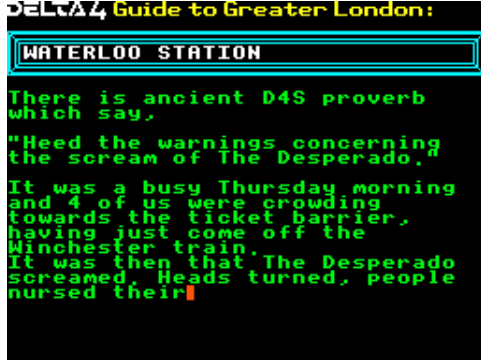

Guild of Thieves, The (Rainbird Software Ltd,1988)
Text Adventure

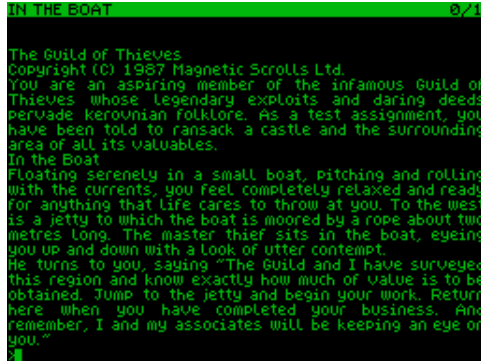

Gulpman (Campbell Systems,1982)
Arcade



Gunfighter (Atlantis Software Ltd,1988)
Arcade



Gugu (MicroHobby,1984)
Arcade



Guido (Blaby Computer Games,1984)
Arcade

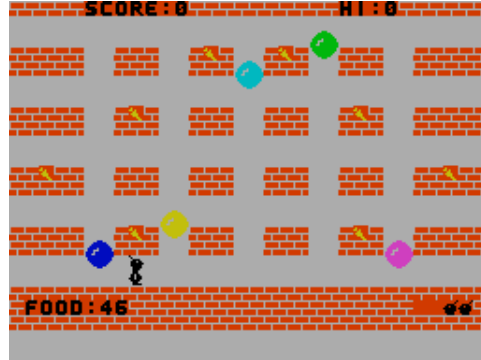

Guillermo Tell (Opera Soft S.A.,1989)
Arcade



Gunboat (Accolade Inc,1990)
Simulation

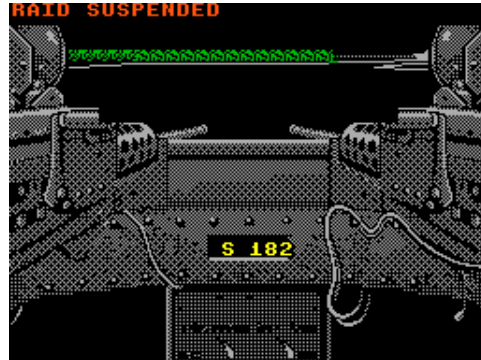

Gunfricht (Ultimate Play The Game,1985)
Arcade



Guideline (Granada Publishing,1983)
Arcade

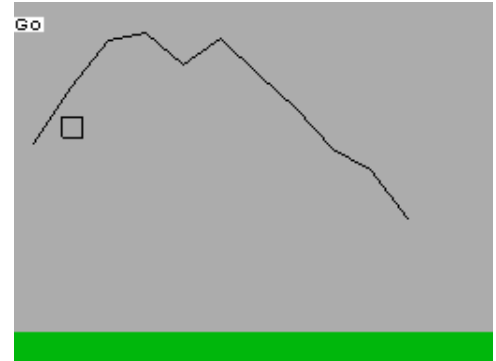

Guildmasters Vol 1 (The Guild,1992)
Compilation



Guitar Tutor (Nova Software,1992)
Educational



Gunboat (Piranha,1987)
Arcade



Gunhed (Hellenic Software,1990)
Arcade



Gun Law (Vortex Software,1983)
Arcade

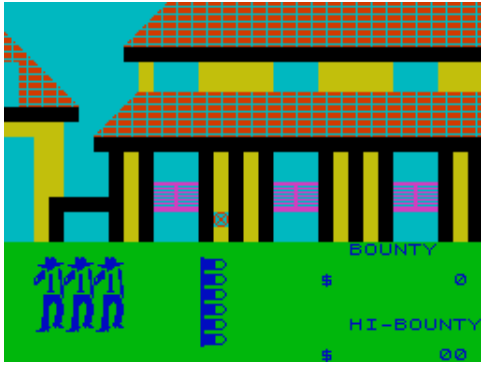

Gunman (Alien Factory/Sage Group,1999)
Arcade



Gunpowder, Treason and Plot (Redwood Designs,1988)
Arcade Adventure



Gunrunner (Hewson Consultants Ltd,1987)
Arcade



Gunship (Microprose Software Ltd,1987)
Arcade

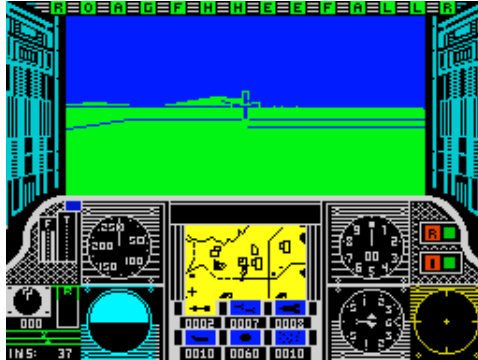

Gunslinger (US Gold Ltd,1987)
Text Adventure

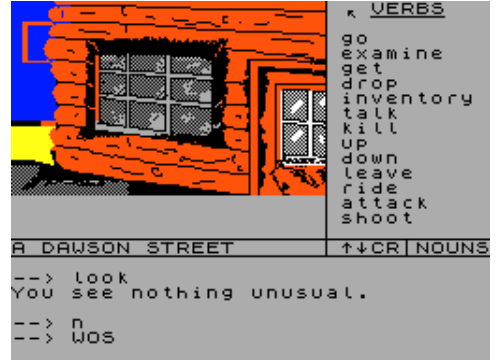

Gunstar (Firebird Software Ltd,1987)
Arcade



Guppi (Andrew Mark Daly,1987)
Arcade



Gusanin Gloton, El (MicroHobby,1985)
Arcade

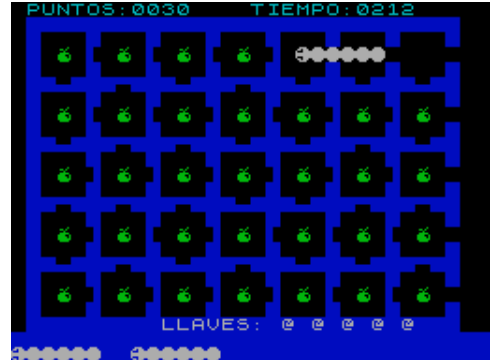

Gusano-Bus (Ediciones y Textos S.A.,1985)
Arcade



Gusano Comilon, El (MicroHobby,1985)
Arcade



Gusiloc (Monser S.A.,)
Arcade

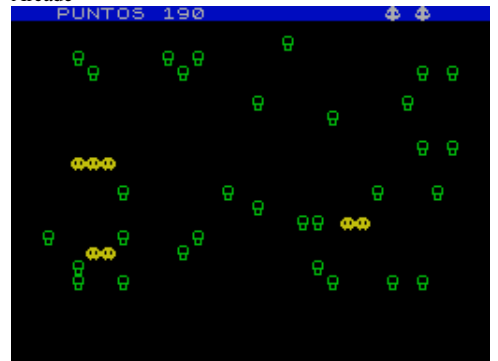

Gutz (Ocean Software Ltd,1988)
Arcade



Gwain the Haffling (Panic Software,1990)
Text Adventure



Gyron Arena (Firebird Software Ltd,1986)
Arcade



Gyron Atrium (Firebird Software Ltd,1985)
Arcade

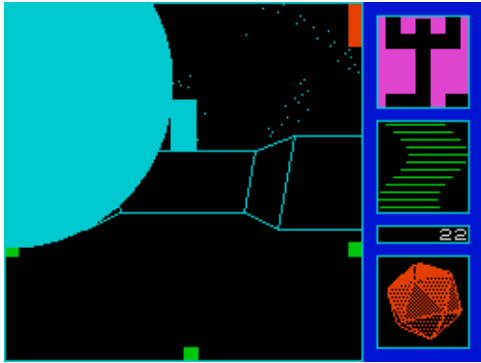

Gyroscope (Melbourne House,1985)
Arcade

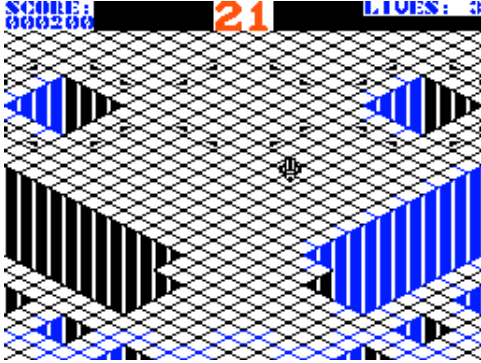

Habilit (Iber Software,1988)
Arcade

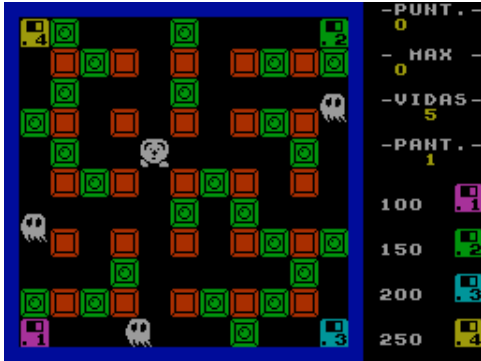

Hack Attack 2 (Gerard Sweeney,1993)
Cheat

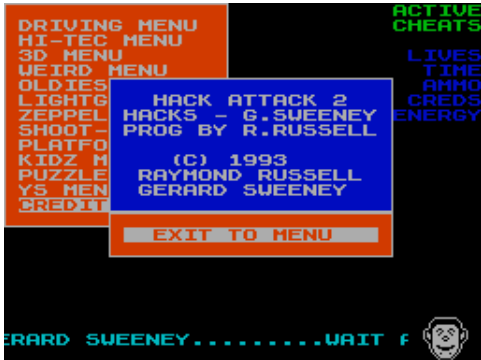

Hacker's Workbench (S.D. Software,1998)
Utility



Gyron Demonstrator (Firebird Software Ltd,1985)
Demo

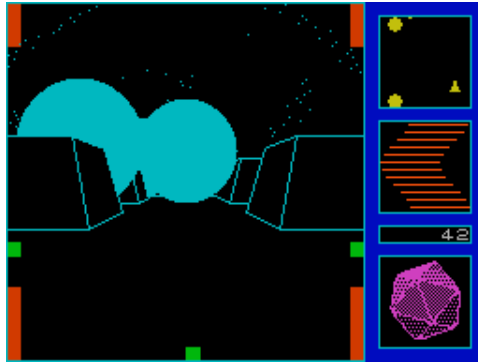

Gyroscope II (Color Magic,1987)
Arcade

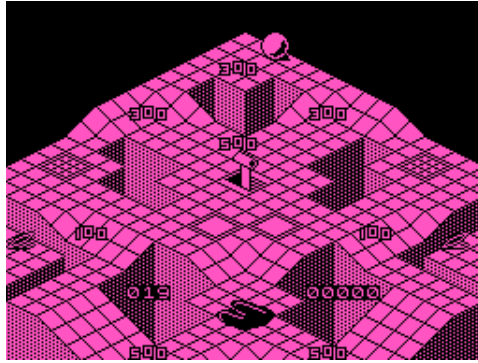

Hack (Jon North/Richard Swann,)
Utility



Hacker (Activision Inc,1985)
Arcade Adventure



Hacker, The (Utopia Software,1985)
Utility



Gyron Necropolis (Firebird Software Ltd,1985)
Arcade

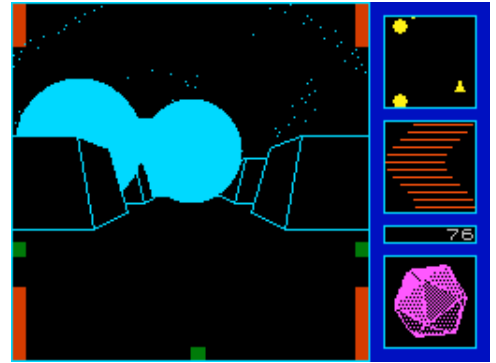

Gyruss (Parker Software,1984)
Arcade



Hack Attack (Your Sinclair,1992)
Cheat



Hacker II: The Domsday Papers (Activision Inc,1987)
Arcade Adventure

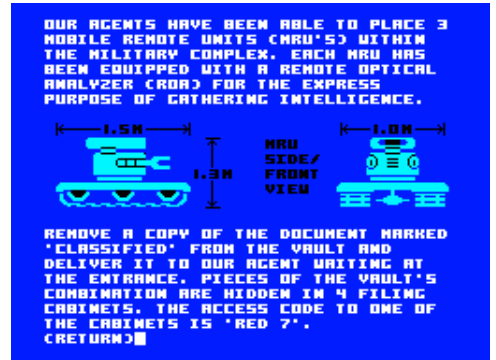

Hacking Software (Jon North,1990)
Utility



Hacking Software Backup (Jon North,1990)
Utility



Hacking Utilities (Jon North,1990)
Utility



Hack Pack (Nightshift,1987)
Utility

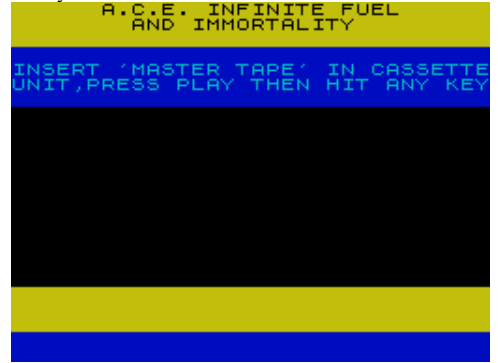

Hack Pack (Sigmsoft,)
Utility

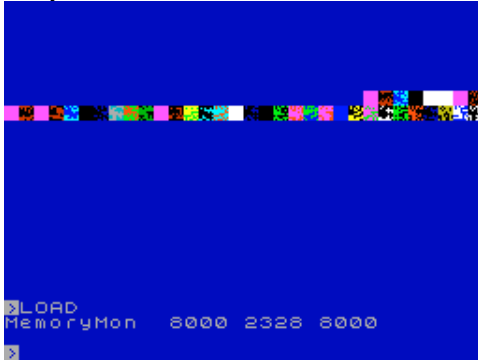

Hacks Amazing! (Sinclair User,1992)
Cheat



Hades (Antonio Baena Sanchez,1989)
Text Adventure



Hades (The Adventure Workshop,1996)
Text Adventure

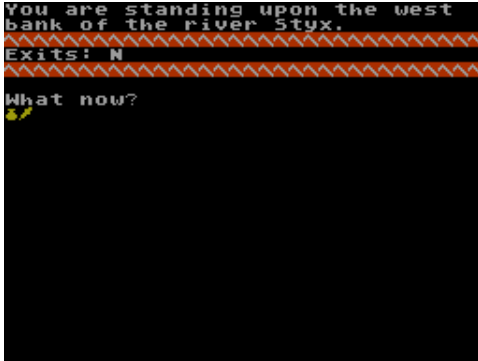

Hades Nebula (Nexus Productions Ltd,1987)
Arcade

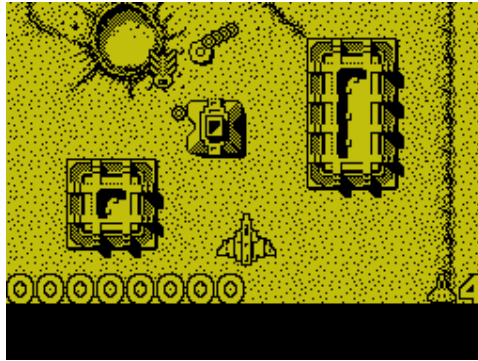

Hado Basic (,)
Utility



Haendlertrilogie, Die (Wicosoft,1983)
Strategy



Hagar the Horrible (The Software Business,1990)
Arcade



Hairy Toes (Zenobi Software,)
Compilation

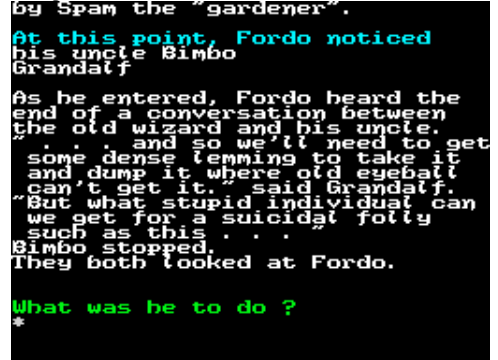

Hajoverseny (Laszlo Nyitrai,2005)
Arcade

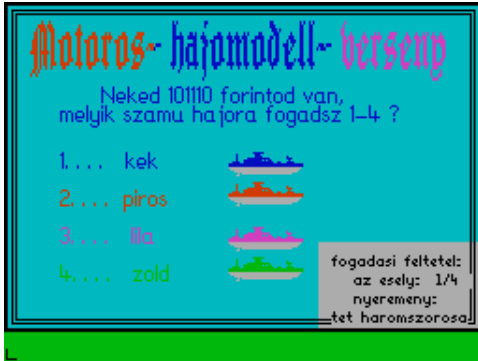

Halaga (Interceptor Micros Software,1985)
Arcade



Halley (Producciones Cicero S.A.,)
Educational



Halley's Comet (Anima Scientific Computing,1986)
Educational

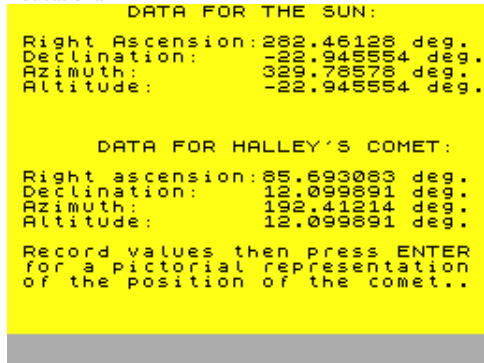

Halls of the Things (Crystal Computing,1983)
Arcade

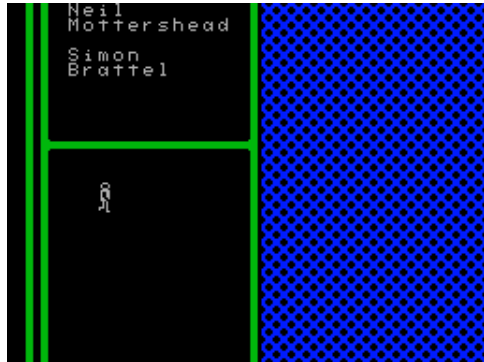

Halo Jones (Piranha,)
Arcade



Hammer-Head (Zigurat Software,1992)
Arcade



Hammurabi (Radostaw Kapitan,1988)
Arcade

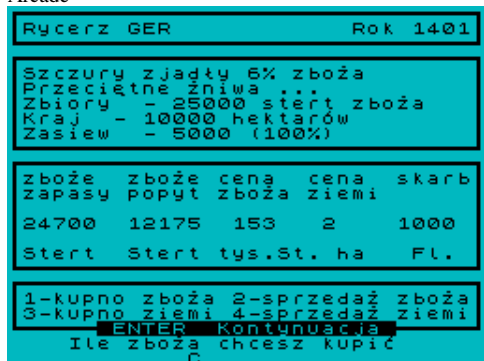

Halley's Comet (Eclipse Software,1985)
Arcade



Halls of the Things Remix (Design Design Software,1986)
Arcade

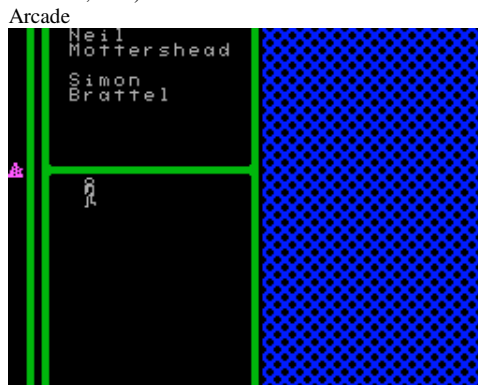

Hammer Boy (Dinamic Software,1991)
Arcade

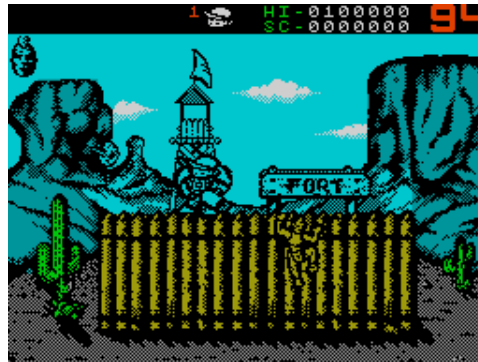

Hammer of Grimmold, The (River Software,1987)
Text Adventure

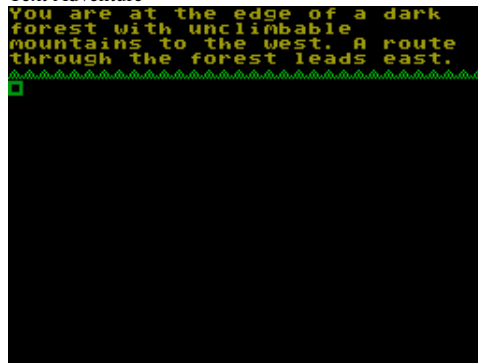

Hamon IV (Ascendancy,1997)
Arcade



Halls of Doom, The (R.D. Foord Software,1988)
Arcade Adventure



Halma 2005 (NyitraiSOFT,2005)
Board/Card Game



Hammerfist (Activision Inc,1990)
Arcade

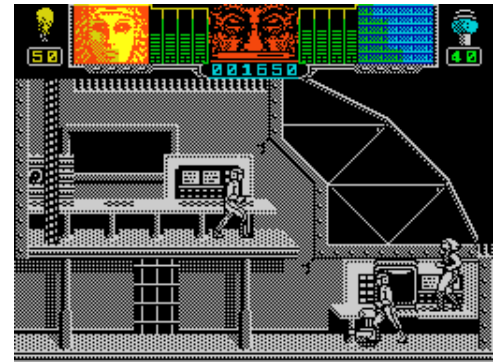

Hammer of Grimmold, The + Mutant (River Software,1987)
Compilation



Hampa 1930 (J. Izquierdo/L. Calvo,1986)
Text Adventure



Hampstead (Melbourne House,1984)

Text Adventure

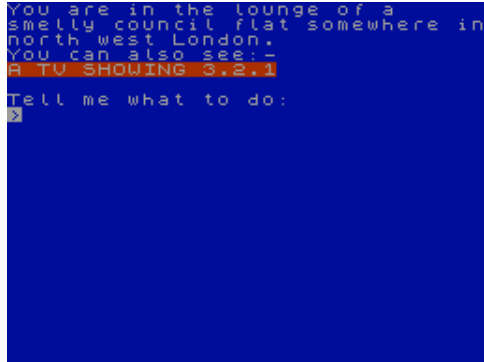

Hamte Damte (Cross Technics,1988)

Arcade



Hands of Stone (Beyond Belief,1992)

Arcade



Hangman (.)

Board/Card Game

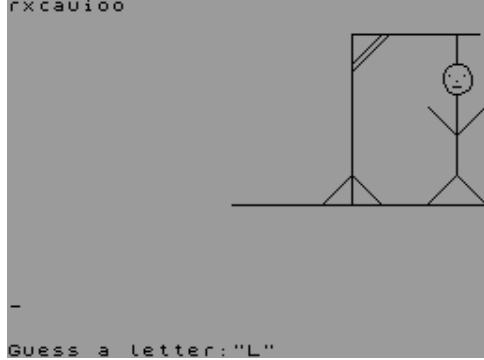

Hangman (Spectre Soft,1983)

Board/Card Game



Hampton's Caught (B.Sides Software,1984)

Arcade



Handful of Hamsters, A (Zenobi Software,1993)

Compilation



Hand, The (Pearl Software,1987)

Text Adventure



Hangman (Poppy Soft,1984)

Board/Card Game



Hangman (Virgin Books,1983)

Board/Card Game



Hamster Droppings (Zenobi Software,1993)

Compilation

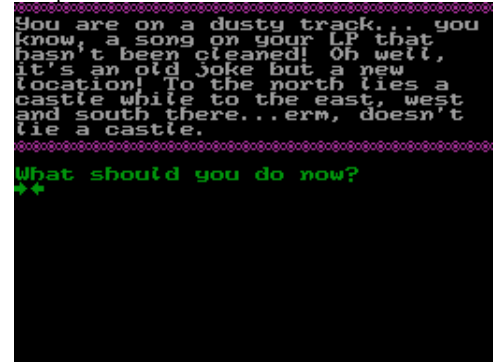

Handicap Golf (CRL Group PLC,1984)

Sport



Handy Andy (CRL Group PLC,1984)

Arcade



Hangman (R.D. Foord Software,1988)

Board/Card Game



Hangman 123 (Cowl Systems,1988)

Board/Card Game



Hanna-Barbera Cartoon Character Collection, The (Hi-Tec Software Ltd,1991) Compilation

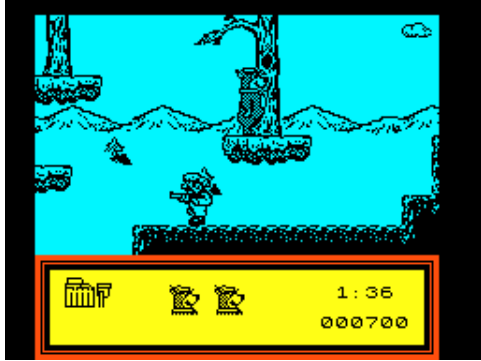

Hanoj (Flymansoft,1998)
Board/Card Game



Happelaar (.)
Arcade

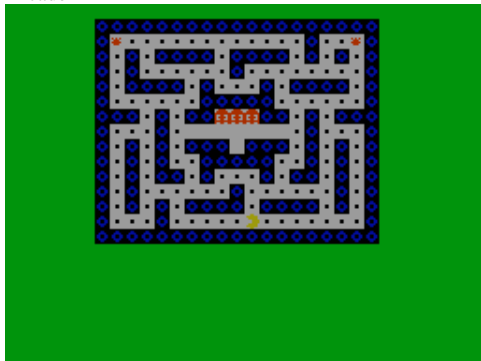

Happy Birthday Alex (Progress,1996)
Scene Demo

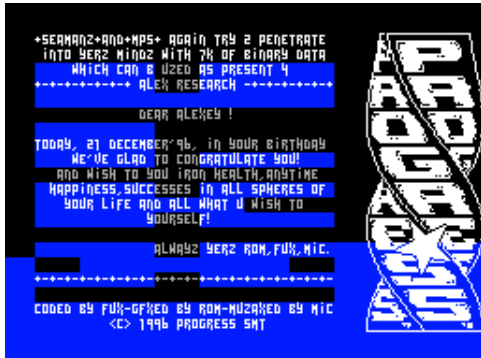

Happy Birthday Point 777 (K3L Corp,1998)
Scene Demo



Hanoi King (Contrast Software,1983)
Arcade

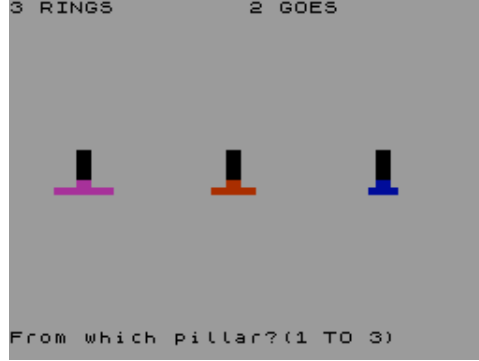

Hanse-Fakt (Hansesoft GmbH,1984)
Utility: Database



Happiest Days of Your Life, The (Firebird Software Ltd,1986) Arcade Adventure



Happy Birthday Demo, The (The Unbelievables,1992)
Scene Demo



Happy Birthday to Yurik (Flash Inc,1995)
Scene Demo



Hanois Torn (Clas Kristiansson.)
Board/Card Game

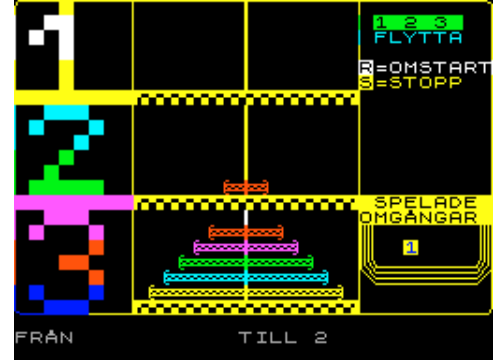

Hansel and Gretel (Arrow,1984)
Educational



Happy (Accept Corp,1997)
Scene Demo

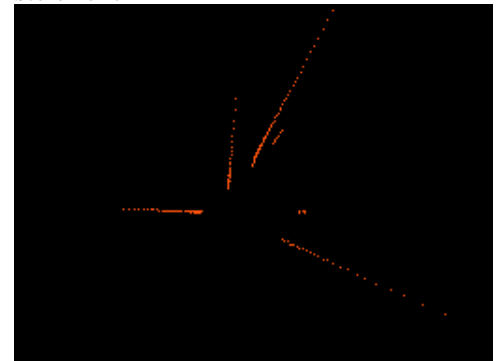

Happy Birthday Mic (Progress,1997)
Scene Demo



Happy Flower (Laussoftware,1984)
Educational



Happy Hour (Scorpio Gamesworld,1984)
Arcade



Hard Cheese (DK'Tronics Ltd,1983)
Arcade



Hareraiser: Finale (Haresoft Ltd,1984)
Arcade

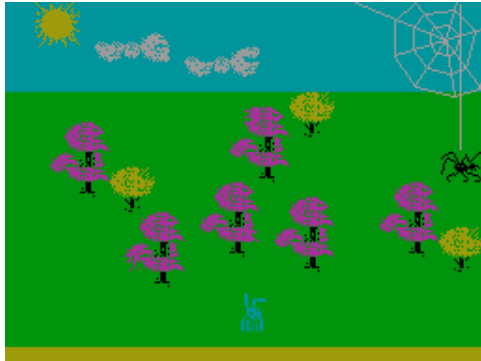

Harlequin (Mr. Micro Ltd,1985)
Board/Card Game



Harrier Attack! (Durell Software Ltd,1983)
Arcade



H.A.R.D. (IJK Software Ltd,1986)
Arcade



Hard Copy (Jozef Vavrinc,1987)
Utility: Copier



Hareraiser: Prelude (Haresoft Ltd,1984)
Arcade



Harmadik Compilation (Laszlo Nyitrai,2005)
Compilation



Harry Goes Home (Pulsonic,1984)
Arcade



HardBall! (Advance Software Ltd,1986)
Sport



Hard Drivin' (Domark Ltd,1989)
Arcade



Hare, The (,)
Text Adventure



Harrier (Abbex Electronics,1983)
Arcade



Harry Hare's Lair (Artic Computing Ltd,1985)
Arcade



Harry the Hippo (Psychaedelic Hedgehog Software,1991)
Text Adventure



Harry the Magical (C.M. Gilles,2005)
Arcade Adventure



Harry the Magical: Harry and the Orden (C.M. Gilles,2006)
Arcade Adventure



Harvesting Moon, A (8th Day Software,1985)
Text Adventure

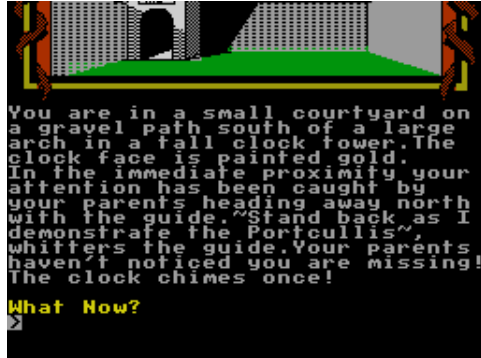

Harvesting Moon, A + Faerie (Powerplay,1984)
Compilation



Harvey Headbanger (Firebird Software Ltd,1986)
Arcade



H.A.T.E. (Gremlin Graphics Software Ltd,1989)
Arcade

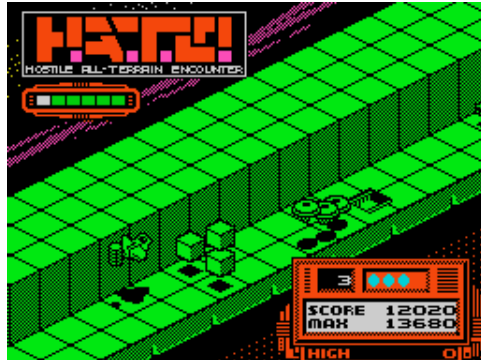

Haunted Hedges (Micromega,1983)
Arcade



Haunted Hedges + Waxworks (Dixons,1983)
Compilation



Haunted House (Sinclair User,1984)
Arcade

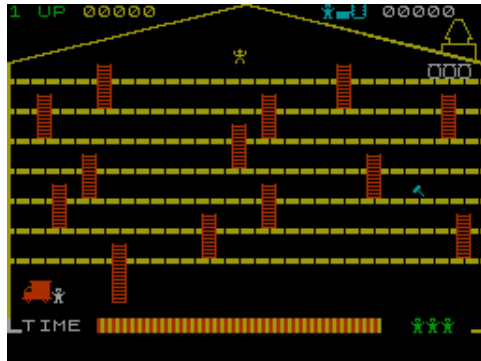

Haunted House (Your Sinclair,1992)
Arcade

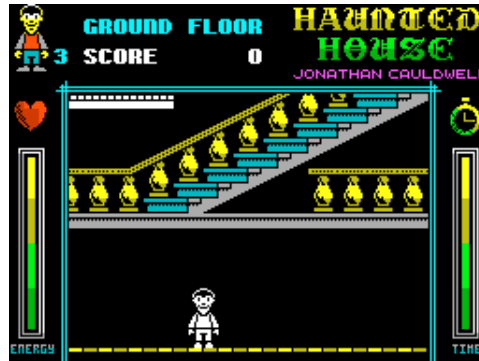

Haunted House Adventure (,1987)
Text Adventure

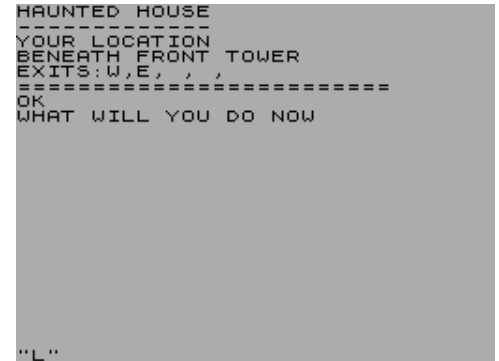

Haunting, The (Elven Adventurers,1991)
Text Adventure

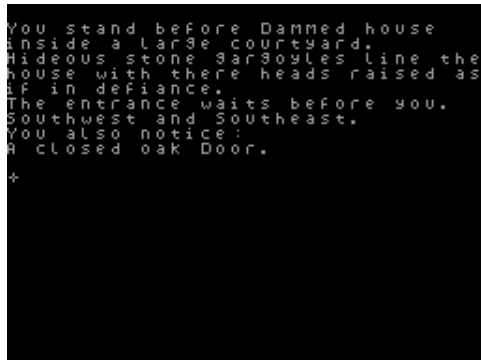

Haushaltsbuchfuehrung (.)
Utility: Spreadsheet

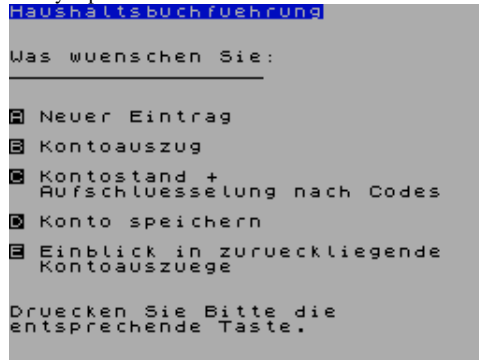

Havoc (Dynavision,1984)
Arcade

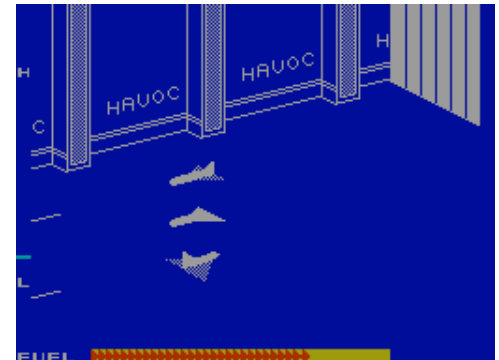

Havoc (Players Premier Software,1990)
Arcade

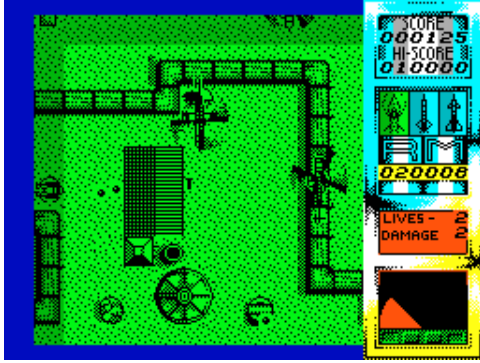

Hawk Storm (Players Premier Software,1991)
Arcade



Headache Mantra (Spectrum Computing,1985)
Utility: BASIC Related

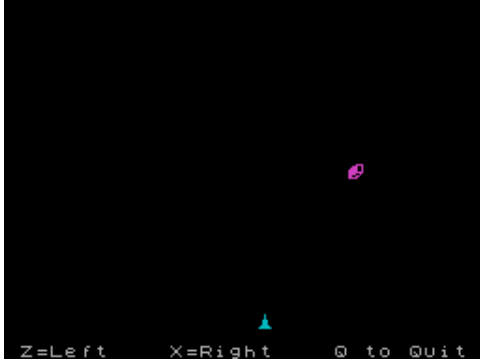

Headbangers Heaven (Llamasoft,1983)
Arcade



Header Cracker (Tweety Soft Ltd,1985)
Utility



Hawks (Abacus Programs,1984)
Arcade



H-Core (Fudgepacker,1994)
Scene Demo



Headball (ZX-Masters Software,1998)
Arcade



Headcoach (Addictive Games Ltd,1986)
Simulation



Header Designer (Reinhard Wittkopf,1984)
Utility



Hawks (Lotus-Soft,1984)
Arcade



H & D Adventure Collection (H & D Software,)
Compilation

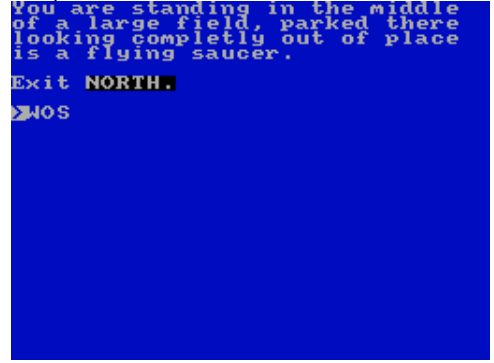

Head-Banger (A. Mehmood,)
Arcade

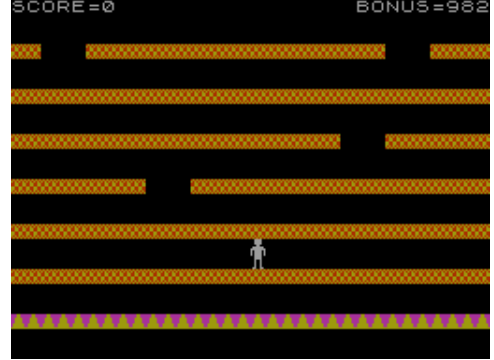

Header (Stephan Slabihoud,1985)
Utility: Sound Manipulation

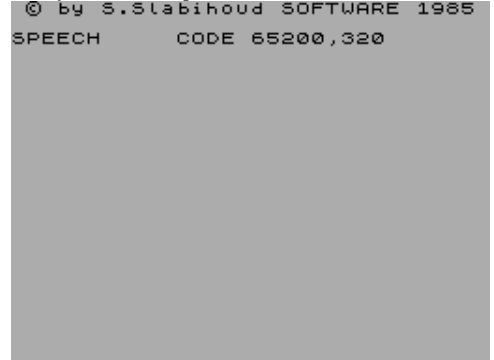

Header Editor (Zbysek Bahensky,1985)
Utility



Headerless Programmschutz (Hans Joachim Girulat,1984)
Utility: Copier



Header Reader (Your Sinclair,1993)
Utility: BASIC Related

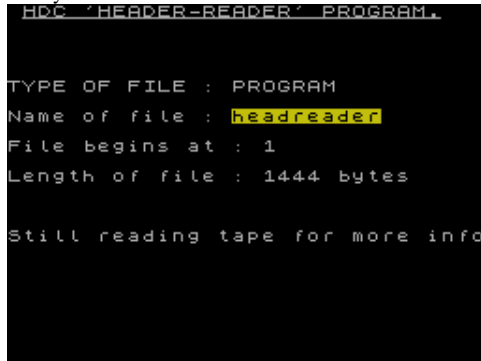

Head over Heels (Ocean Software Ltd,1987)
Arcade



Head the Ball (Crash,1992)
Arcade



Heartland (Odin Computer Graphics Ltd,1986)
Arcade

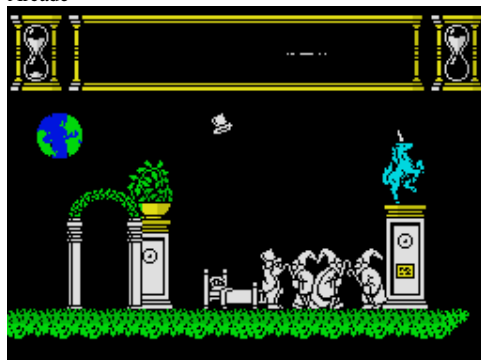

Headerlist (Z. Kosina,1984)

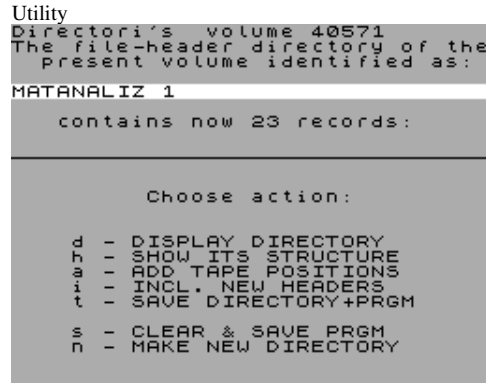

Header Reader to DOS File (.)
Utility

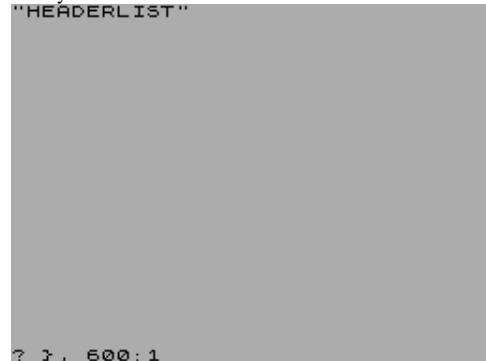

Head Reader (.)

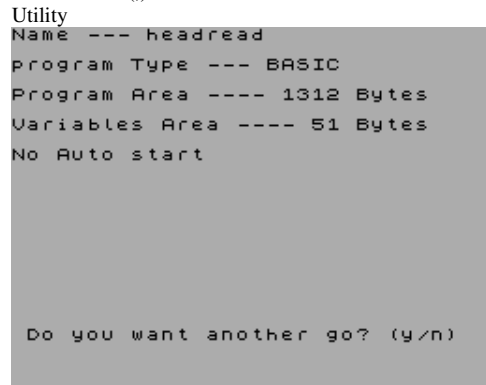

Heart and Circulation (AVP Computing,1986)
Educational



Heart of Gern, The (PCBs,1987)
Text Adventure



HeaderReader (Stephan Slabihoud,1986)

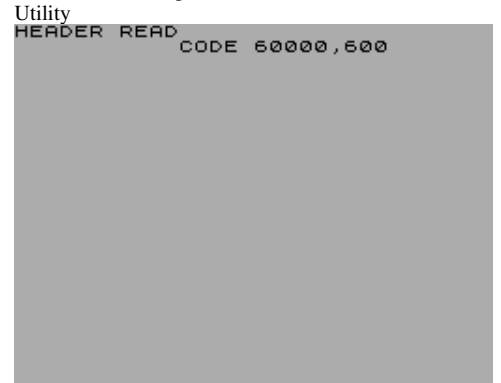

Headlights (Greyfriars,1987)
Utility



Headstart (Bug-Byte Software Ltd,1987)
Arcade

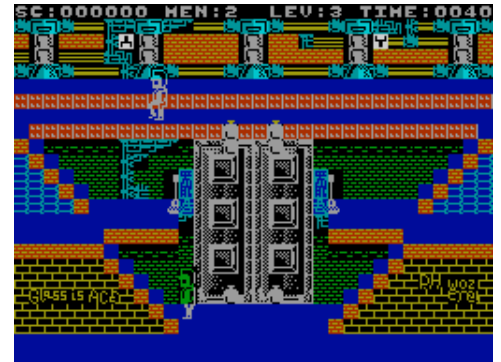

Heartbroken (Atlantis Software Ltd,1989)
Arcade Adventure

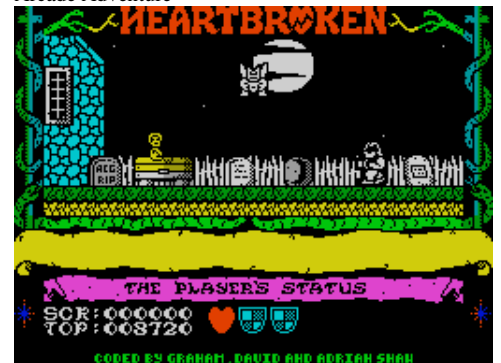

Hearts (Barisoft,1995)
Board/Card Game

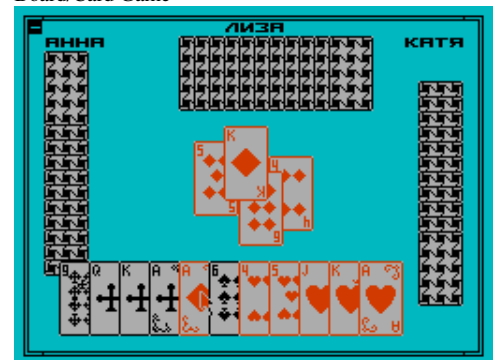

Heathrow Air Traffic Control (Hewson Consultants Ltd,1983)
Simulation

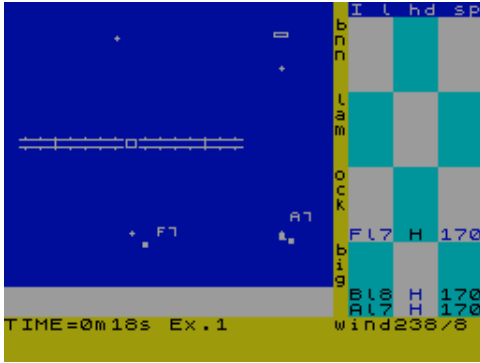

Heathrow International Air Traffic Control (Hewson Consultants Ltd,1984) Simulation

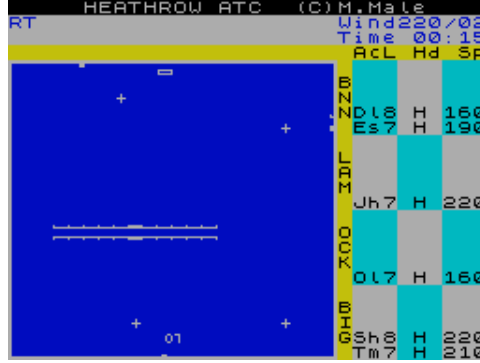

Heat Leader (Lambourne Games,1986)
Simulation

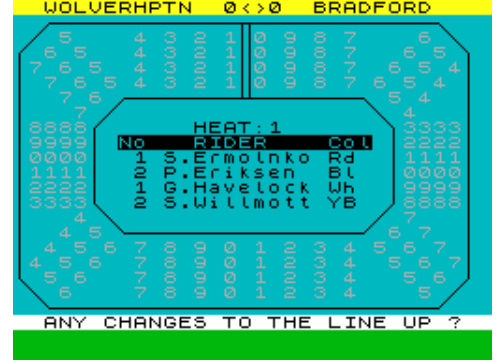

Heat Leader '91 (Lambourne Games,1992)
Simulation

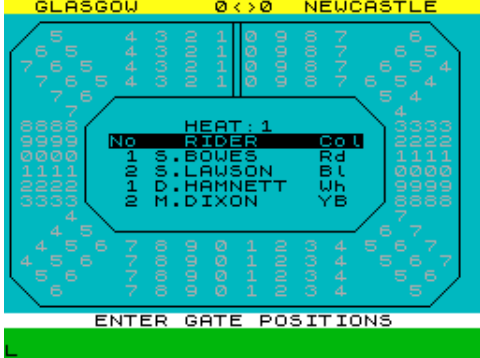

Heat Leader '97 (Lambourne Games,1986)
Simulation

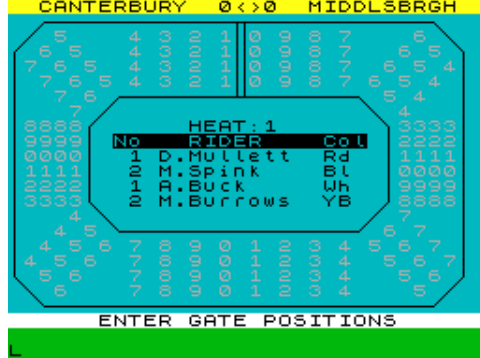

Heatwave (Hewson Consultants Ltd,1989)
Compilation



Heaven 1 (Dansoft,)
Scene Demo



Heaven 2 (Dansoft,)
Scene Demo



Heavy Lift Helicopter (Eclipse [2,])
Arcade



Heavy Metal (US Gold Ltd,1990)
Arcade



Heavy Metal Mover (UCM Group,1996)
Board/Card Game



Heavy on the Magick (Gargoyle Games,1986)
Arcade Adventure



Heavyweight (.)
Arcade

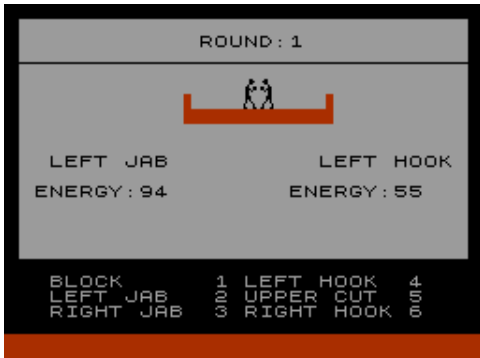

Hebrew WP (.1984)
Utility: Word Processor

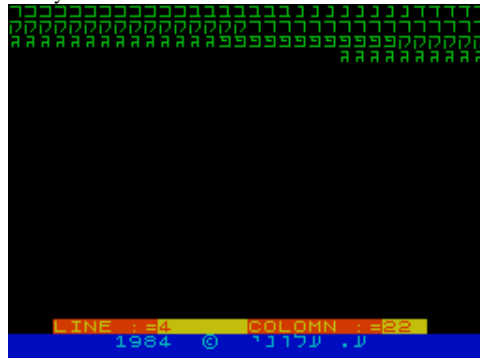

Hechizo (MicroHobby,1985)
Arcade Adventure

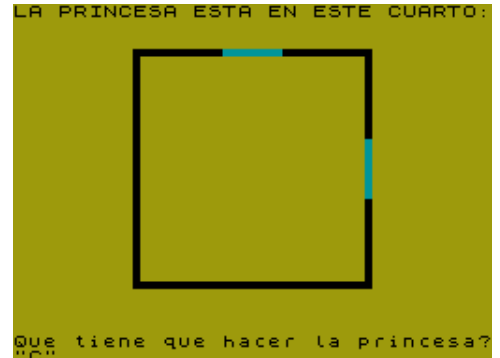

Hectic (Mind Games Espana S.A.)
Arcade



Hedda Strikes Again (Adventure Probe Software,)
Text Adventure



Height Enhancer (Spectrum Computing,1984)
Utility: BASIC Related



Helicopter (Firebird Software Ltd,1985)
Arcade



Helicopter (Paradox,1998)
Arcade

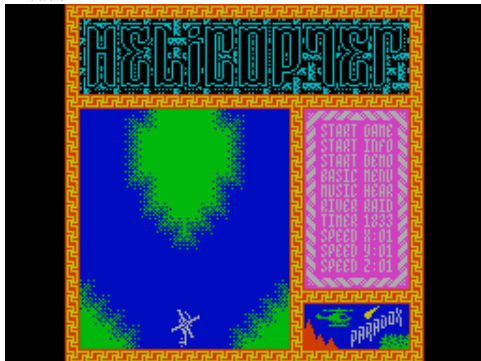

Hectic Electric (Charly Records,1984)
Utility

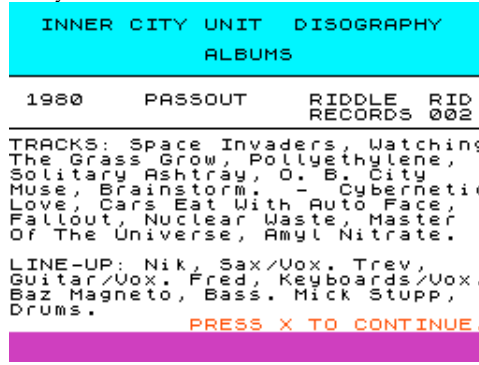

Hedgehog Run (XFAWORLD Software,2004)
Arcade

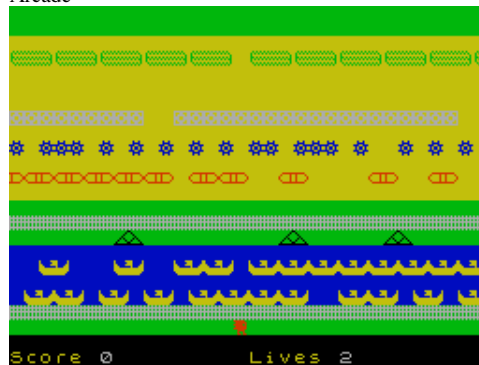

Heist 2012 (Firebird Software Ltd,1987)
Arcade



Helicopter (Baumsoft,1984)
Arcade



Helicoptero, El (MicroHobby,1985)
Arcade



Hedda's Revenge (Adventure Probe Software,1999)
Text Adventure

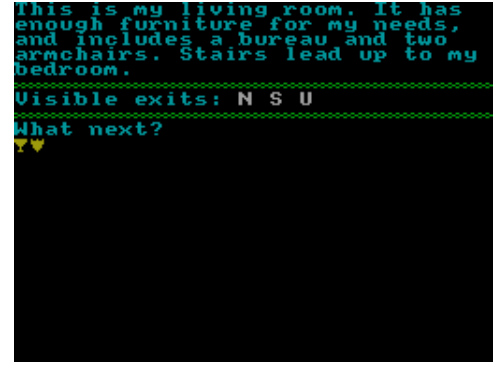

Hedgehog Shurik (Flash Inc.)
Scene Demo

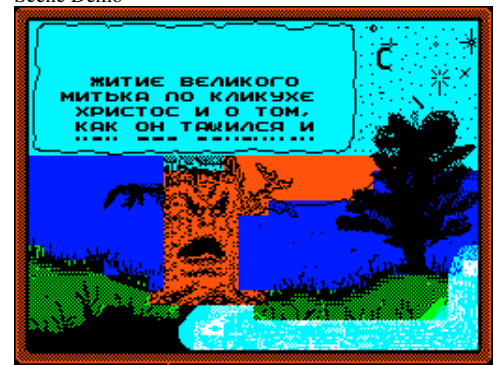

Heli 2 (Thomas Bernhart,1985)
Arcade

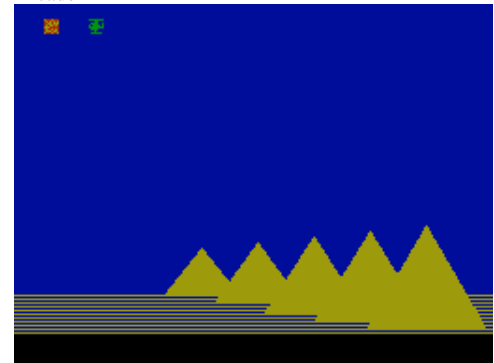

Helicopter (Gamesoft [2],1985)
Arcade



Helikopter (,)
Arcade

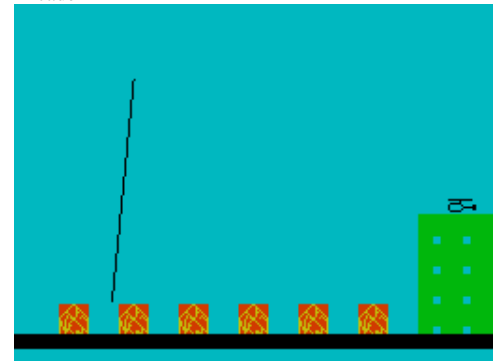

Helikopter (Jansoft,1994)
Arcade

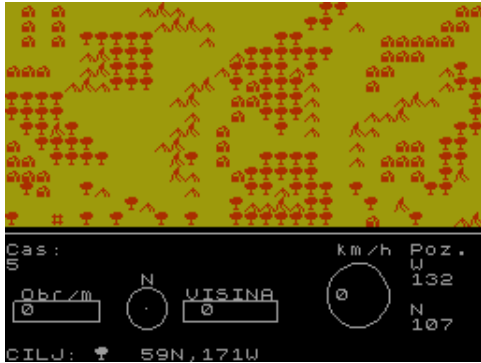

Heli-Maths (Kerian UK Ltd,1984)
Educational

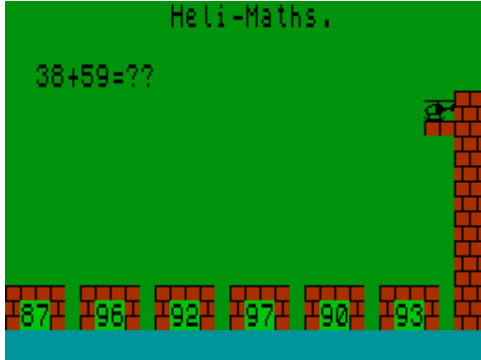

Hellfire Attack (Martech Games Ltd,1989)
Arcade



Help (MicroHobby,1985)
Utility: Mathematics



Helping Hands - Colour (Aslett Scholey,1983)
Utility

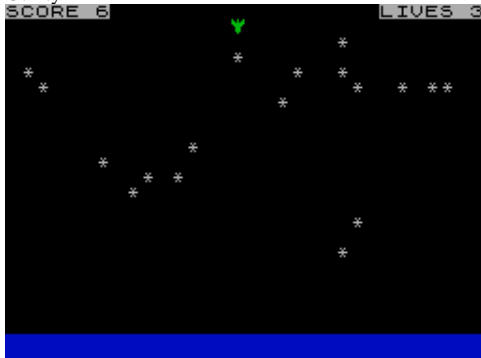

Helikoptertengeralattjaro Vadasz (Laszlo Nyitrai,1998)
Arcade



Hellfall (.)

Board/Card Game

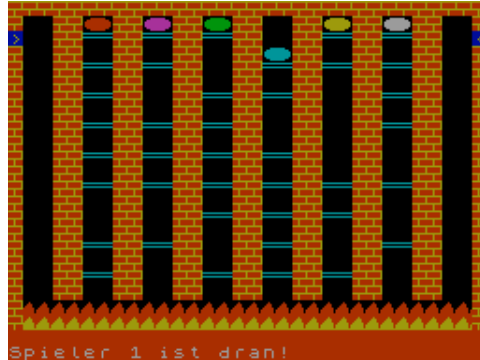

Hell Master (Paul Nikitin,1993)
Arcade

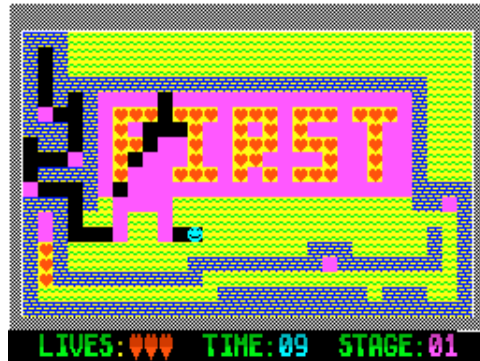

Helpa (Ian Stewart/Robin Jones,1982)

Utility: Assembler/Disassembler/Monitor

```
Ramtop: 29999
MC-Bereich: 30000
Daten: 30000 bis 30299
Run USR: 30500
HEX CODE:
DD 21 **>
```

"WOSL"

Helping Hands - Sound (Aslett Scholey,1983)
Utility



Heli-Land (.)
Arcade

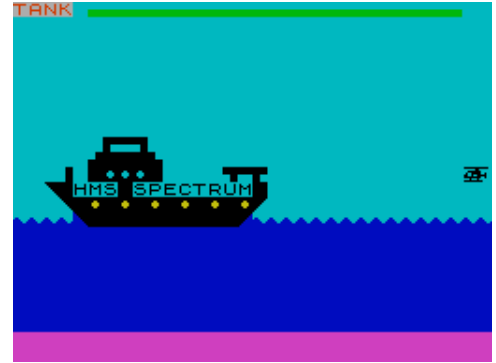

Hellfire (Melbourne House,1985)

Arcade



Helm, The (Firebird Software Ltd,1985)

Text Adventure

```
I am standing in a one roomed
hut, evidently made by very
primitive hands.
There is an exit to my south.
On the wall I see an extremely
large sign.
Upon further careful opticular
contemplation of the immediate
surrounding environment, I find
the following: -
A locked chest.
Give me your next wondrous
command. Oh all intelligent one.
```

Help. Ayuda Al Programador

(DIMensionNEW/Idealogic S.A.,1984) Utility

HELP PROGRAMACION © DIMENSIONNEW

MAPA DE MEMORIA

- 1.- cargar programa
- 0.- ejecutar programa HELP
- 3.- retorno Menu
- 4.- STOP

indica una opcion

Help the Doctor (Dennis van Berkel,1989)
Scene Demo



Helter Skelter (Audiogenic Software Ltd,1991)
Arcade

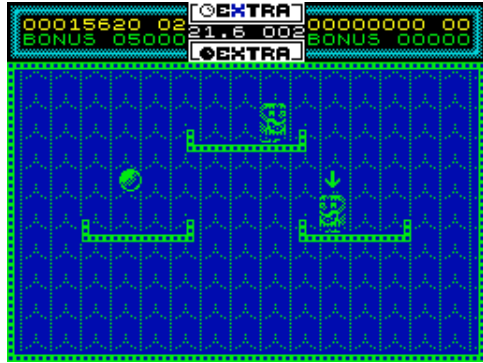

Henry's Hoard (Alternative Software Ltd,1985)
Arcade



Hercules (Alpha-Omega Software,1986)
Arcade



Here and There with the Mr. Men (Mirrorsoft Ltd,1985)
Educational

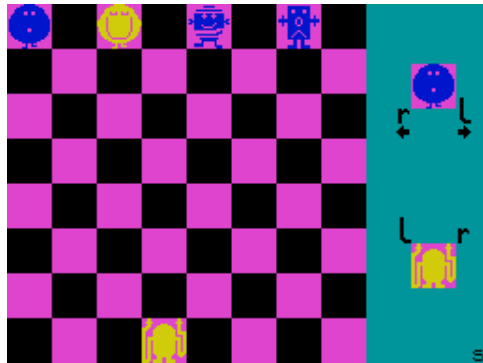

Heresville (Wazertown Works,1990)
Text Adventure

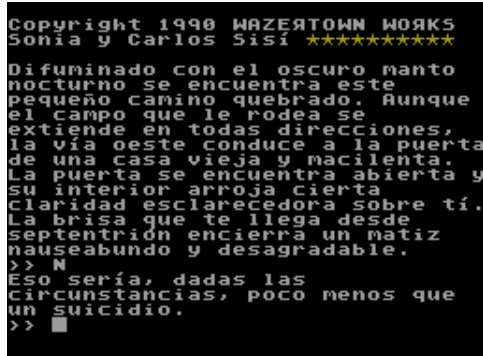

Helvera: Mistress of the Park (FSF Adventures,1993)
Text Adventure



Herbert's Dummy Run (Mikro-Gen Ltd,1985)
Arcade



Hercules (Busy Software,)
Scene Demo



Here Be Tygers (Automata UK Ltd,1985)
Text Adventure

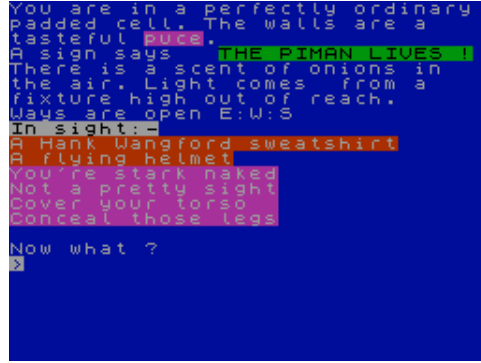

Hermitage, The (Pegasus Developments,1989)
Text Adventure

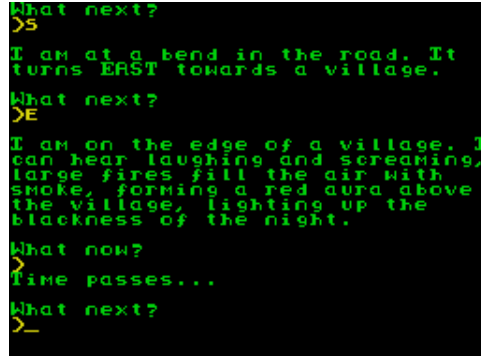

Henrietta's Book of Spells (Scetlander,1990)
Educational



Herbie (Rafael Garcia,1985)
Simulation

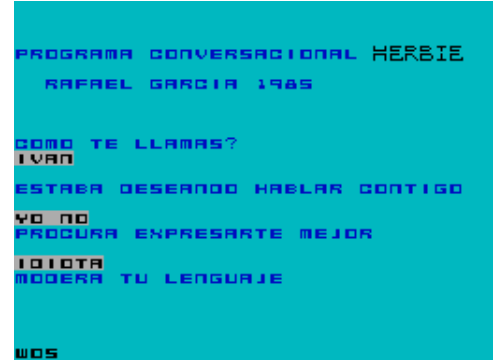

Hercules: Slayer of the Damned (Gremlin Graphics Software Ltd,1988) Arcade



Here Comes the Sun (Alligata Software Ltd,1983)
Text Adventure

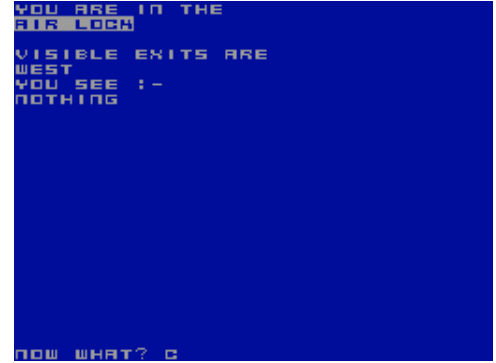

H.E.R.O. (Activision Inc,1984)
Arcade

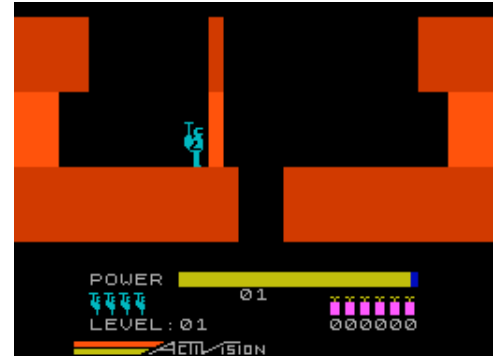

Heroes (Domark Ltd,1990)
Compilation

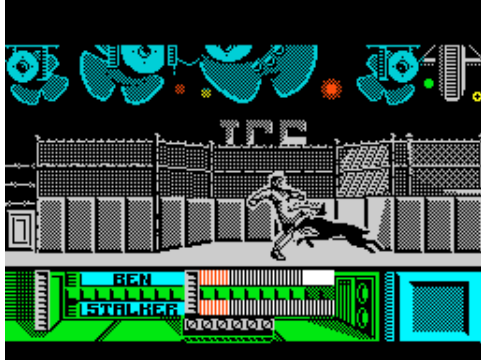

Heroes of the Lance (US Gold Ltd,1988)
Arcade Adventure

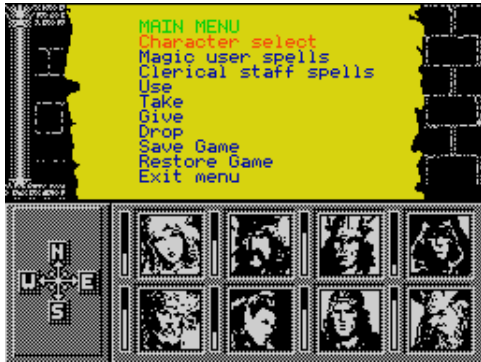

Hero Quest (Gremlin Graphics Software Ltd,1991)
Arcade Adventure

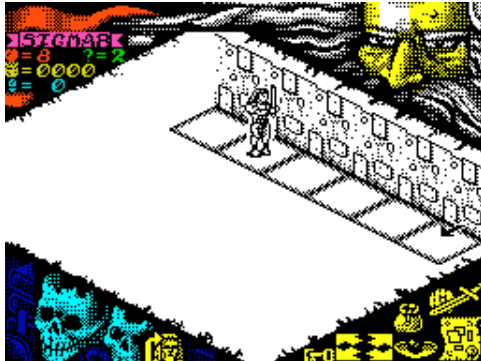

Hero Quest: Return of the Witch Lord (Gremlin Graphics Software Ltd,1991) Arcade Adventure

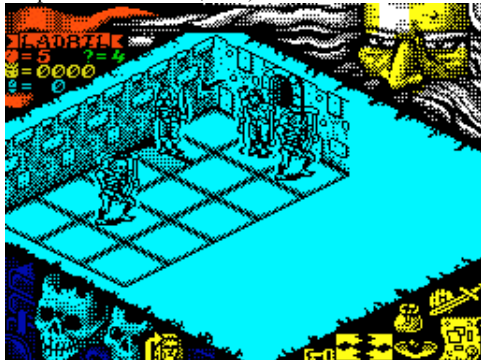

Hexagon 2 (Style Group,1997)
Board/Card Game

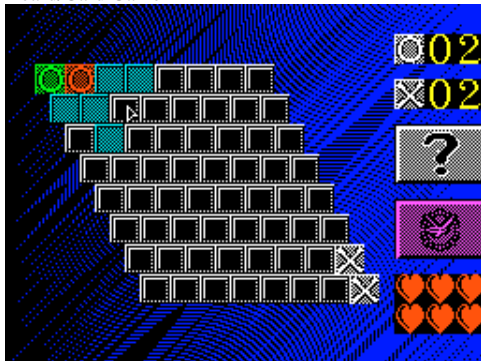

Heroes '92 (Proxima Software,1992)
Arcade Adventure

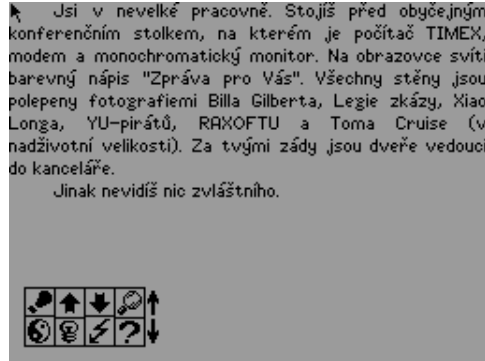

Hero for Sorania, A (Adventure Probe Software,1998)
Text Adventure



Hero-Quest (Karry Soft,1994)
Arcade Adventure



Herrgarden (Xcellent Software,)
Text Adventure

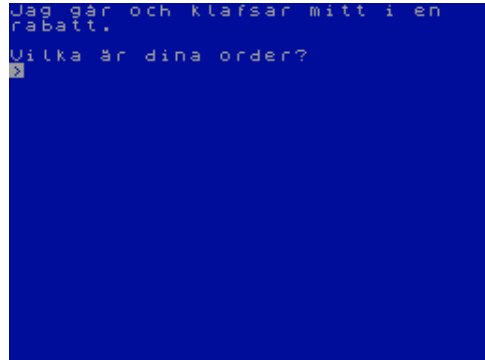

Hexagonal Museum, The (Double Play
Adventures,1984)



Heroes of Karn (Interceptor Micros Software,1984)
Text Adventure

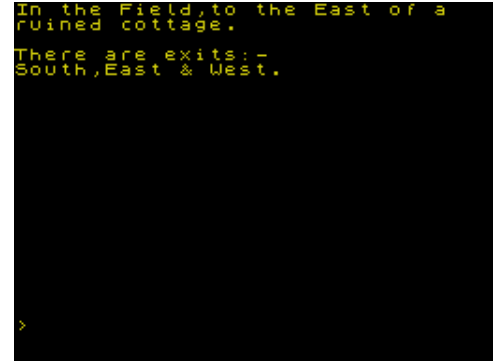

Hero of the Golden Talisman (Mastertronic Added
Dimension,) Arcade



Heroquest (PSS,)
Text Adventure



Hetty (Roberto Valverde,2005)
Arcade



Hexagonia (VTS,2001)
Board/Card Game

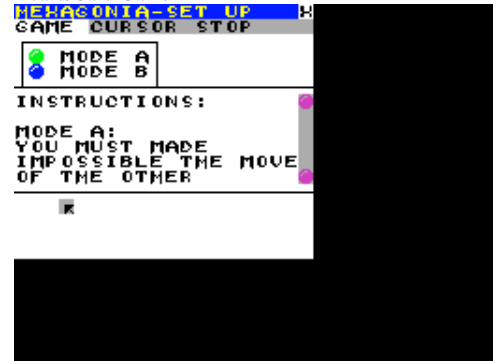

Hexan (Krajowa Agencja Wydawnicza,1987)
Educational

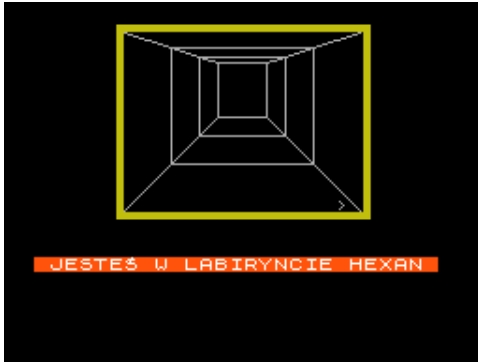

Hex Loader (FV,1983)
Utility: Assembler/Disassembler/Monitor

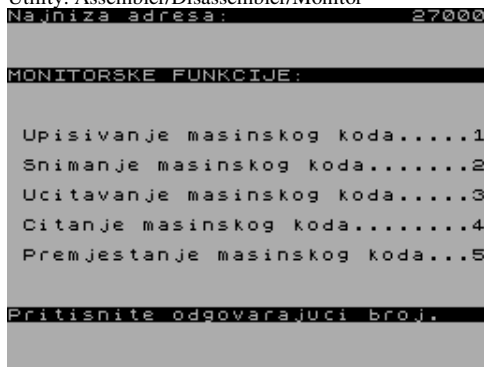

Hicksted (CCS,1983)
Simulation



Hidden Letters (Poppy Programs,1983)
Educational

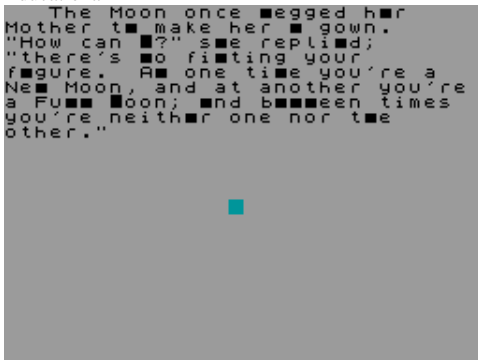

Hideous (Alternative Software Ltd,1992)
Arcade



Hexcellent (Your Sinclair,1993)
Board/Card Game

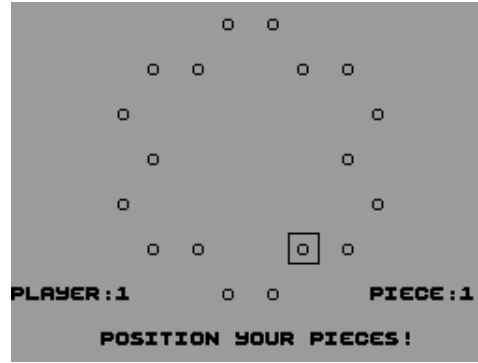

Hexogen (The Jokers,1990)
Scene Demo

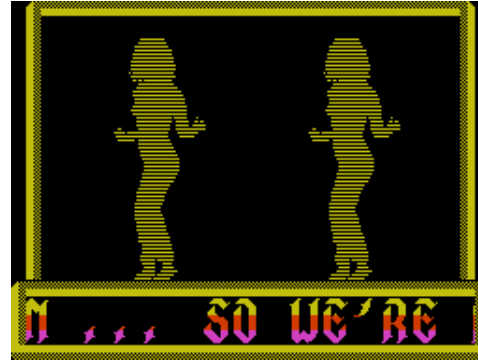

Hicksted/Mathsted (CCS,1983)
Compilation



Hidden Words (Shiva Publishing Ltd,1983)
Board/Card Game



Hidraulico (Chips Software,1986)
Arcade



Hexent (Virgin Books,1984)
Utility

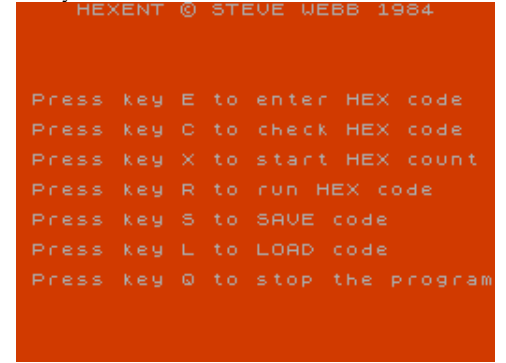

Hexxagon (WE [Belarus],1994)
Board/Card Game



Hidden City (Bytewell,1983)
Arcade Adventure

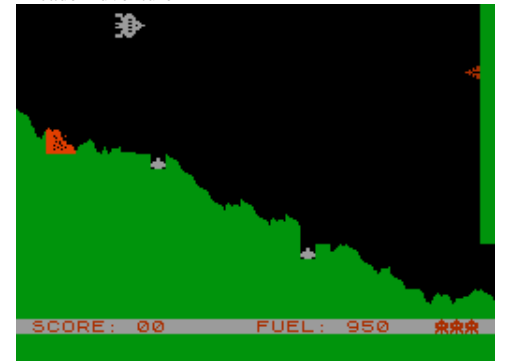

Hide and Seek (Adventure Probe Software,1997)
Text Adventure



Hifile (Gerton Lunter,1987)
Utility: Database

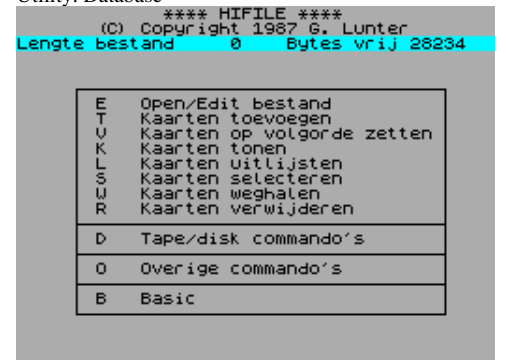

Higgledy Piggledy (Cronosoft,2005)
Arcade

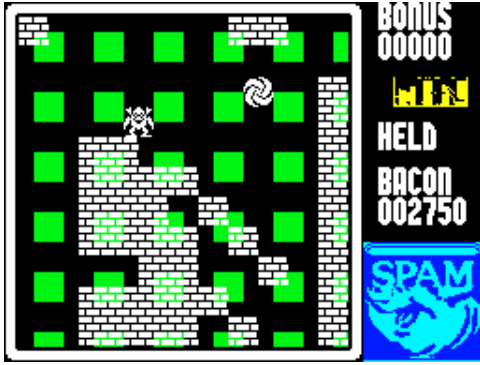

Highlander (Ocean Software Ltd,1986)
Arcade



High Noon (Stack Computer Services Ltd,1983)
Arcade



Highrise Harry (Blaby Computer Games,1983)
Arcade



Highway Code (CRL Group PLC,1984)
Educational

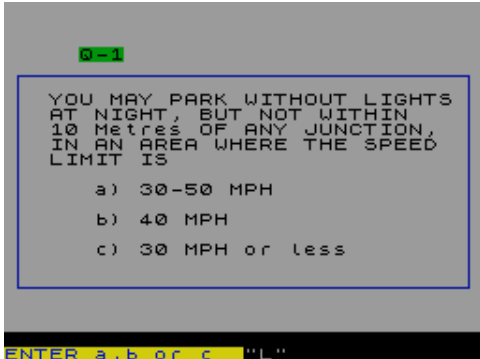

Higher State (3SC,1998)
Scene Demo

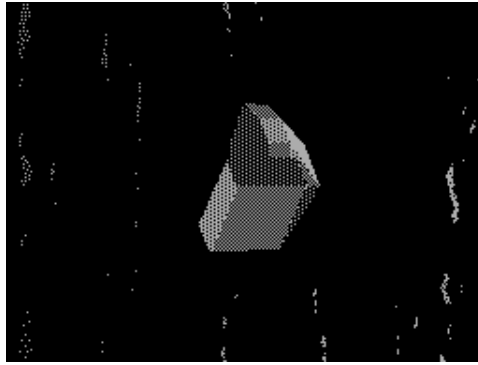

High Low (Spectrum Computing,1985)
Board/Card Game

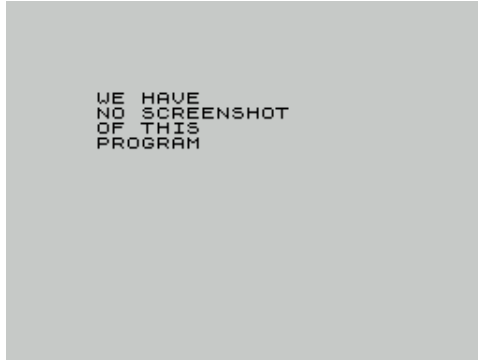

High Noon (Work Force,1983)
Arcade



High Speed Mania (Eclipse Software,1985)
Arcade



Highway Code (Datek,1985)
Educational

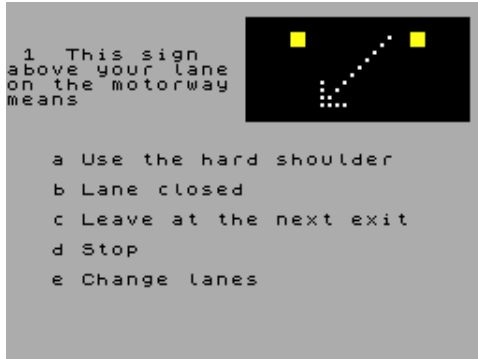

High Frontier (Activision Inc,1987)
Simulation



High Noon (Ocean Software Ltd.)
Arcade



High Odds (Crusader Computing.)
Text Adventure



High Steel (Screen 7 Ltd,1989)
Arcade

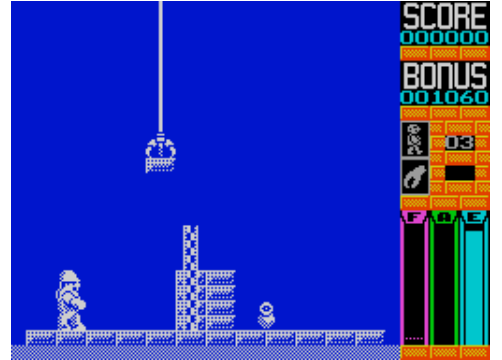

Highway Code (Rose Software,1984)
Educational



Highway Encounter (Vortex Software,1985)
Arcade

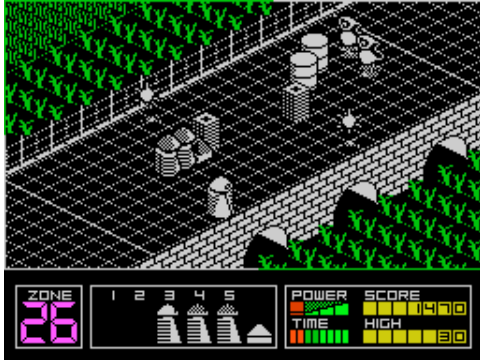

Hilderbay Printer Program (Hilderbay Ltd,1983)
Utility

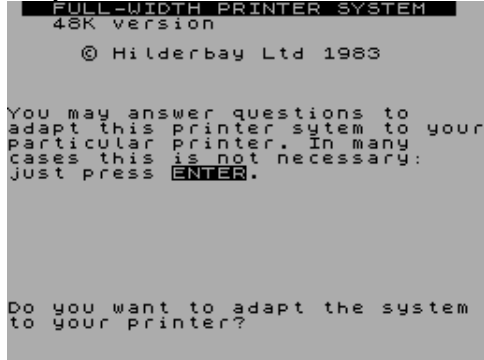

Hi-Lo (.)
Board/Card Game

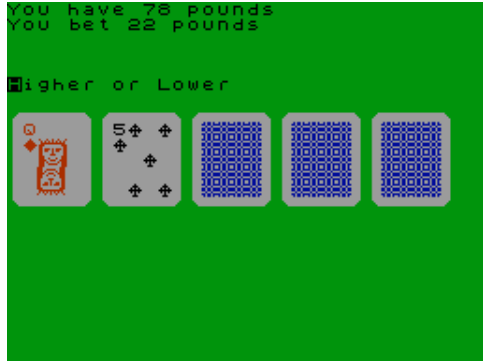

Hiper-Olimpic (MicroHobby,1985)
Sport



Hired to Kill (Tom Powell,1993)
Text Adventure

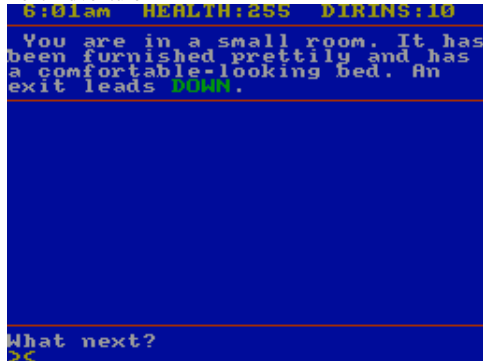

Highwire (Englefield Software,1985)
Educational



Hill MacGibbon Special Christmas Pack (Five Ways Software Ltd,1984) Compilation



Hilow (Norman Wallace,1984)
Board/Card Game

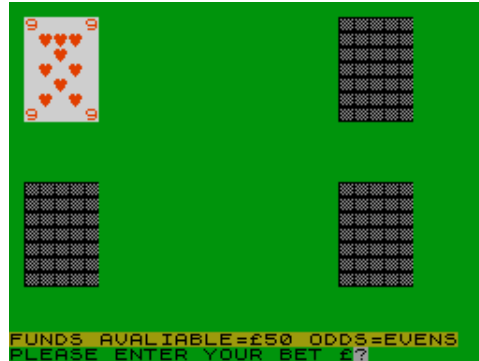

Hiperynto (MicroHobby,1985)
Arcade



Hires-Tool (.)
Utility

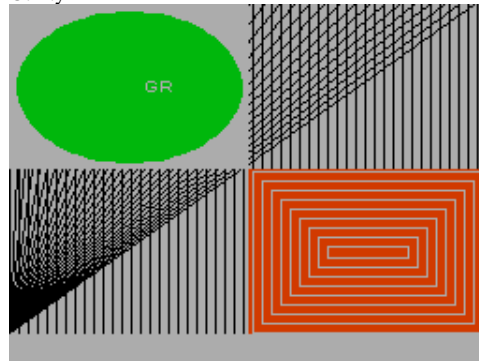

Hijack (Electric Dreams Software,1986)
Arcade



Hill Street Blues (Krisalis Software Ltd,1990)
Arcade



Hiperboloide (MicroHobby,1985)
Utility: Mathematics



Hi Q Quiz (Blue Ribbon Software,1989)
Board/Card Game



Hi-Rise Scaffold Construction Set (CRL Group PLC,1988)
Utility



Hi-Rize (Interface Publications Ltd,1984)
Arcade

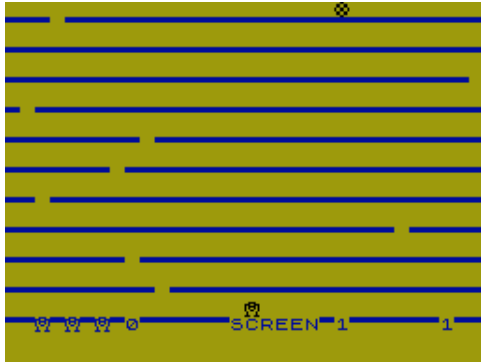

HiSoft C (HiSoft,1984)
Utility: Programming

```
HiSoft C Compiler V1.3
Copyright © 1984,6 HiSoft

org
erm

ERROR 48 AT LINE 2
bad declaration
```

HiSoft Devpac (HiSoft,1983)
Utility: Assembler/Disassembler/Monitor

```
Bytes: GENS3M
Buffer size? 20000
Copyright © HISOFT 1983
All rights reserved

>LABEL
Pardon?
>10
>30 : INPUT
>40 PUSH HL
>50 ADD HL,HL
>60 PIP BC
>70 REY
>█
```

HiSoft Pascal Modules (Artur Matuzevski,1984)
Utility: Programming

```
WE HAVE
NO SCREENSHOT
OF THIS
PROGRAM
```

Historias de Medialand (JSJ Soft Ltd,1987)
Text Adventure

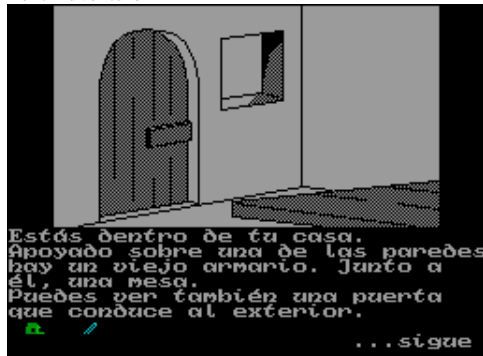

HiSoft Assembler (HiSoft,1983)
Utility: Assembler/Disassembler/Monitor

```
HISOFT ASSEMBLER
TYPE - PRINT USR 26000 -
Copyright (C) HISOFT 1983,4
All rights reserved

>WOS█
```

HiSoft Colt Compiler (HiSoft,1985)
Utility: BASIC Related

```
00:01:06:1
HISOFT COLT Integer Compiler 1.0
© 1985 THRELFALL and HODGSON

Compiling Line 20

Compiled OK

Begin End Vars Lines
40000 40074 51561 52043

Names Nmtop Ctop Nvars
52059 52191 52460 80

To run RANDOMIZE USR 40000
```

HiSoft Pascal 4 (HiSoft,1983)
Utility: Programming

```
Bytes: HP4S
Top of RAM? 40000
Top of RAM for 'T'? 30000
Table Size? 123

Copyright Hisoft 1983.
All rights reserved.

>WOS█
```

HiSoft Ultrakit (HiSoft,1984)
Utility: Programming

```
b) From BASIC: choose an address
(say x) and CLEAR x

Now (for both situations)
LOAD "header/rdr"CODE x+1
RANDOMIZE USR x+1

To direct output to a printer
POKE x+36,3 & to restore output
to the screen as normal
POKE x+36,2

I apologise for these points of
difference between the program
and the manual, but all else is
as printed.

Richard Teller.

0 OK, 220:2
```

History (Visions Software Factory,1988)
Educational

```
WE HAVE
NO SCREENSHOT
OF THIS
PROGRAM
```

HiSoft BASIC (HiSoft,1986)
Utility: BASIC Related

```
The sum is 3

0 OK, 40:1
```

HiSoft Debugger (HiSoft,1983)
Utility: Assembler/Disassembler/Monitor

```
00000 F3 DI
>PC 7138 F3 02 02 66 79 02 6C 70
SP FF40 0B 00 00 00 04 02 00
IX 5C3A FF ED 00 00 00 00 00
HL 03D4 04 00 00 04 00 00 00
DE 0012 F3 FF 11 FF FF FF FF
BC 0053 15 FF FD 75 00 ED 76
AF 0044 E1 6E FD 75 00 ED 76
IR 3F5C U U

FFF4 10 FFFC 42 0004 FF
FFF5 10 FFFD 42 0005 C3
FFF6 10 FFFE 3C 0006 C6
FFF7 00 FFFF 00 0007 11
FFF8 00 >0000 F3< 0008 0A
FFF9 42 0001 AF 0009 50
FFFF 42 0002 11 000A 5C
FFFF 42 0003 FF 000B 22

>█
```

HiSoft Pascal 4S (HiSoft,1983)
Utility

```
Bytes: HP4S
Top of RAM? 40000
Top of RAM for 'T'? 50000
Table Size? 123

Copyright Hisoft 1983.
All rights reserved.

>WOS█
```

Histo-Graph (Transform Ltd,1985)
Utility

```
WE HAVE
NO SCREENSHOT
OF THIS
PROGRAM
```

History 1 (Sinclair Research Ltd,1982)
Educational

```
BRITISH HISTORY Turn of wos
1 *.....0

Which event is associated with:
1162

1 Domesday survey completed
2 Introduction: Trial by jury
3 Only son of Henry I drowned
4 Becket: Archb. of Canterbury
5 Hereward the Wake
6 Richard goes on Crusade
```

History in the Making (US Gold Ltd,1988)
Compilation



Hi-Tech Pools Check (Mirrorsoft Ltd,1985)
Utility



Hit - Pack 2 (Zeppelin Games Ltd,1992)
Compilation

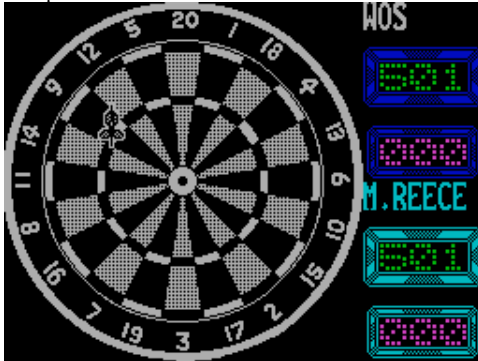

Hit Squad, The (Code Masters Ltd,1988)
Arcade Adventure

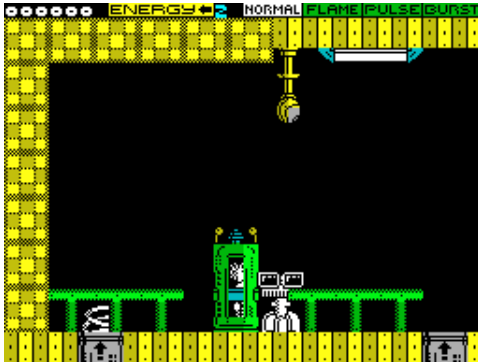

Hive (Firebird Software Ltd,1986)
Arcade



Hit (Zenobi Software,1989)
Text Adventure

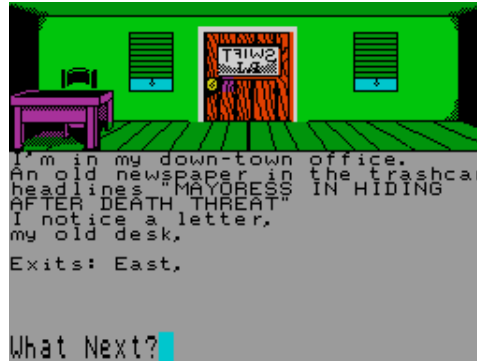

Hit Man (Scorpio Gamesworld,1984)
Arcade



Hit Pack, The (Paxman Promotions,1990)
Compilation

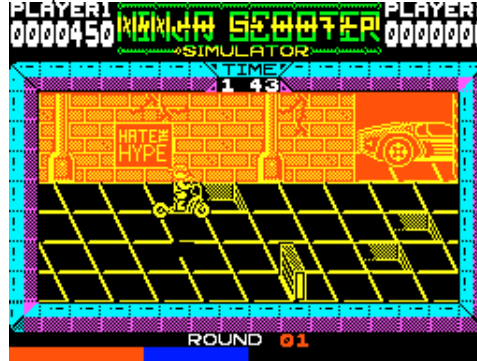

Hitsville (.)
Compilation



Hlasovy Program (Voicesoft,1985)
Utility: Sound Manipulation

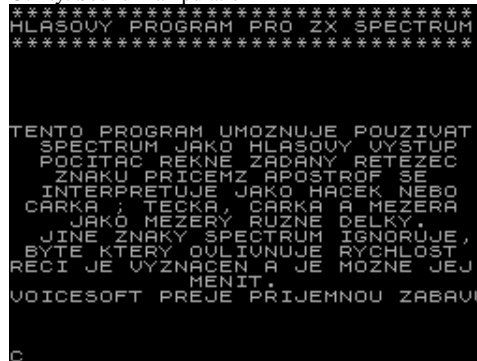

Hitch Hikers Guide to the Galaxy, The (Estuary Software Products,1985)
Text Adventure

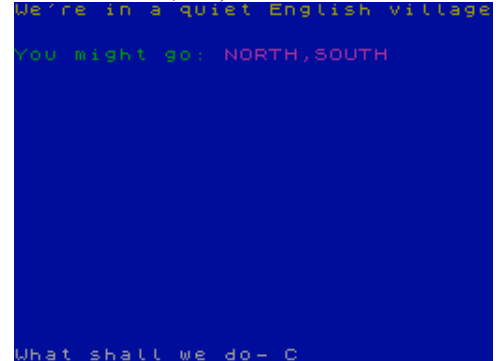

Hit - Pack 1 (Zeppelin Games Ltd,1992)
Compilation



HI-T Spectrum Screen Enhancer (Timedata Ltd,1984)
Utility: Programming



Hive (Capssoft/Softy,1986)
Arcade



Hledac - Cesta za Zlatem Mayu (Kybso,1987)
Text Adventure

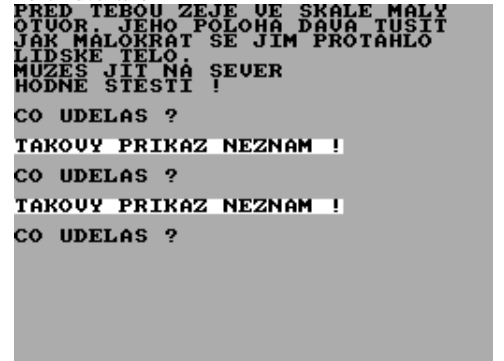

HL ZX Forth (Mike Hampson,1983)
Utility: Programming

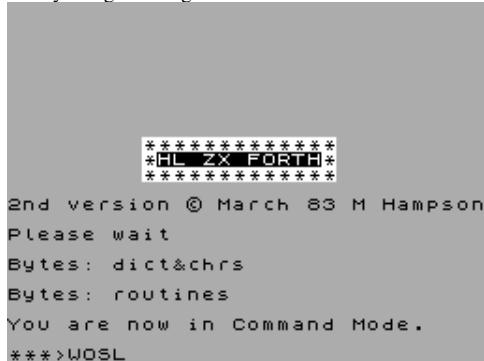

Hobble Hunter, The (Compass Software,1989)
Text Adventure



Hob's Hoard (Zenobi Software,1991)
Text Adventure



Holdmentes (Laszlo Nyitrai,1998)
Arcade



Holiday in Sumaria (Pirate Software Ltd,1987)
Arcade Adventure



Hobbit, The (Melbourne House,1982)
Text Adventure



Hobby Suerte (MicroHobby,1985)
Simulation



Hockey (MicroHobby,1985)
Sport

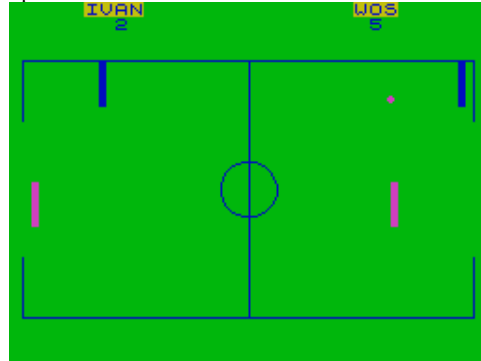

Holdraszallas (Laszlo Nyitrai,1998)
Arcade



Holiday to Remember, A (Visual Dimensions,1987)
Text Adventure



Hobble Hunter + The Micro Mutant, The (Compass Software,1989) Compilation



Hobgoblin (Atlantis Software Ltd,1991)
Arcade



Hocus Focus (Quicksilva Ltd,1986)
Arcade Adventure



Holiday (Scetlander,1988)
Educational



Hollis-Buster (The Unbelievables,) Scene Demo



Hollow, The (Gilsoft International,1985)
Text Adventure

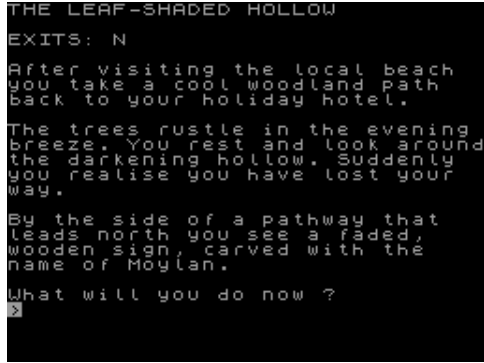

Hollywood Poker (Diamond Games,1987)
Board/Card Game

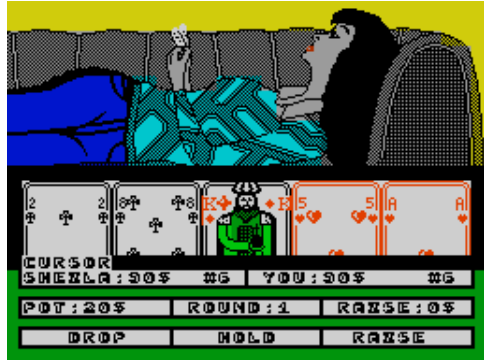

Home Budget (Kuma Computers Ltd,1983)
Utility



Home Hungaroring (Kerszi,1986)
Simulation



Home Knitter, The (Meadowmarsh Software,1984)
Utility

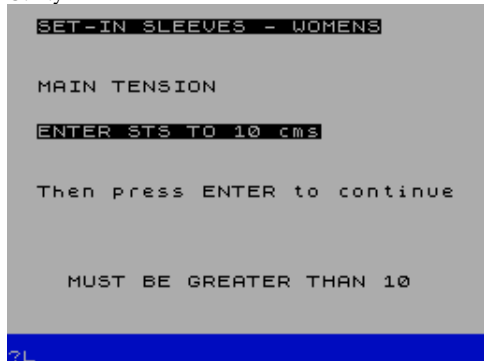

Hollywood Collection (Ocean Software Ltd,1990)
Compilation

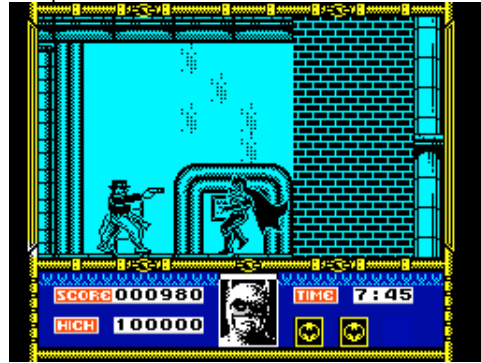

Homac (David Martin Associates Ltd,1983)
Utility: Spreadsheet

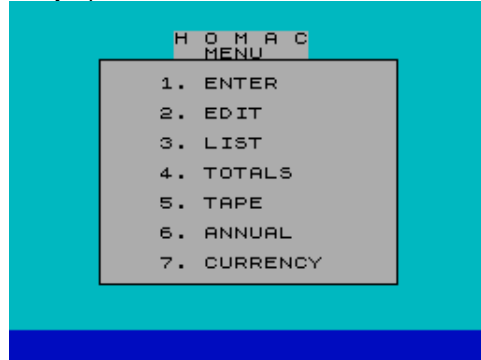

Home Builder (Coxsoft,1987)
Educational



Home Iceland Dizzy (VS Prog Group,1998)
Arcade Adventure



Homer Simpson 2: In Russia Again (MG & Co,2001)
Arcade Adventure



Hollywood Featuring Batman & The Untouchables (Ocean Software Ltd,1989)
Compilation

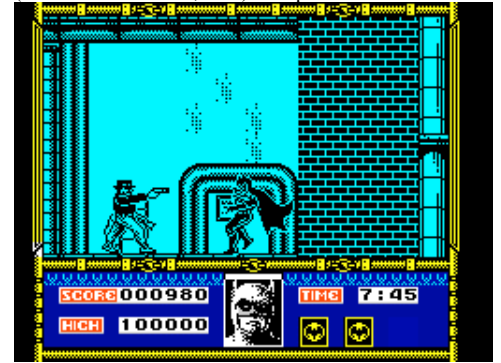

Home Accounts Management (QED Systems,1983)
Utility

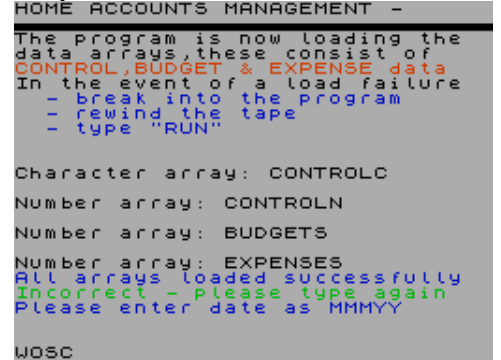

Home Calc (A. Goodwin/S. Kingswell,1983)
Utility

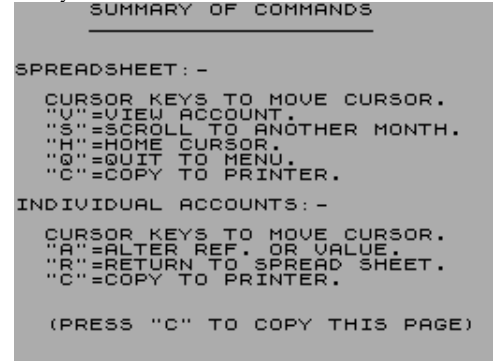

Home Investor (R.G. Winfield,1983)
Utility

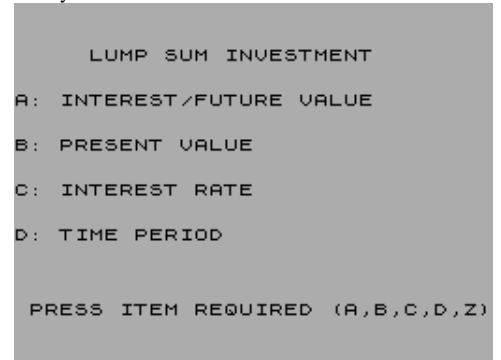

Homer Simpson in Russia (MG & Co,1998)
Arcade Adventure



Home Runner (Britannia Software Ltd,1984)



Homicide Hotel (Wallsoft/The Guild,1987)



Honeyassem (,1985)

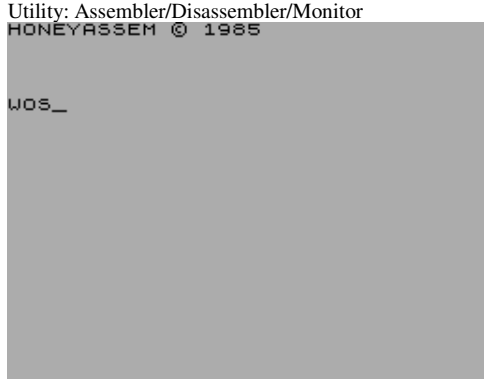

Honky Tonk (Software Cottage,1985)

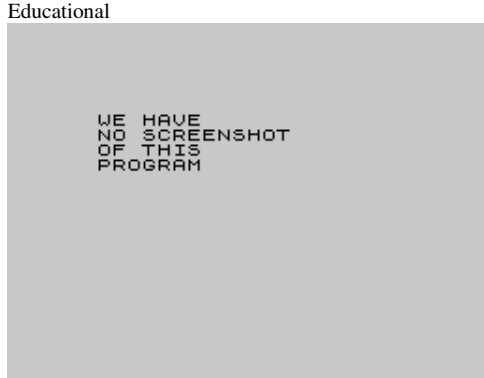

Hop 'n' Chop (Cronosoft,2003)



Home Tetris (Russian Bear Group,1996)

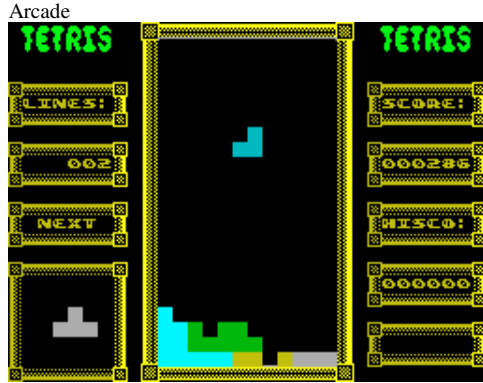

Homophones (Calpac Educational Software,1983)



Honey World (Alex Art,2000)

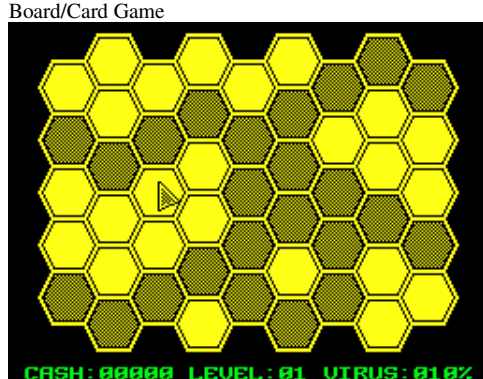

Hooper (MicroHobby,1989)



Hopper (PSS,1983)



Home Tutor (Fearless Software,1985)



Honba za Pokladem (Proxima Software,1993)



Hong Kong Phooey (Hi-Tec Software Ltd,1990)



Hooray for Henrietta (Scetlander,1990)



Hopper Copper (Silverbird Software Ltd,1988)



Hopping Mad (Elite Systems Ltd,1988)

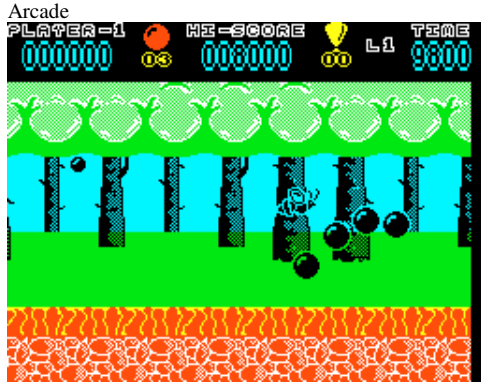

Horace to the Rescue (Melbourne House,)



Horny Hary (X-Rated Software,)

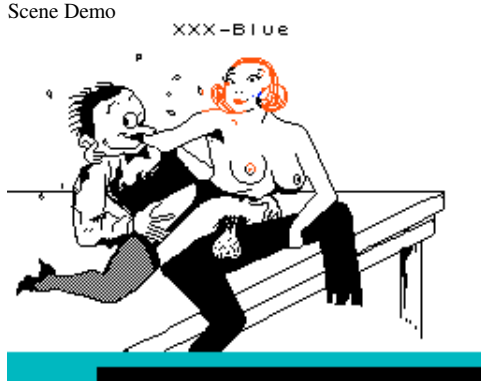

Horosopo (Load 'n' Run [Spa],1985)

Utility: Astronomy/Astrology

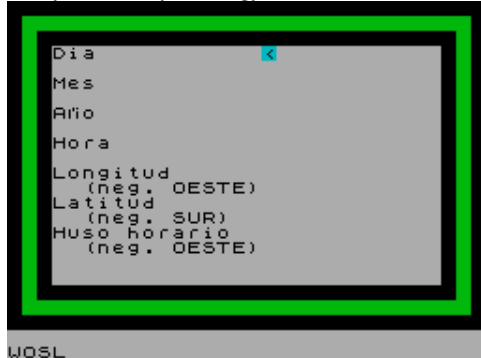

Horrscope (Square Peg,1991)

Text Adventure



Horace and the Spiders (Sinclair Research Ltd,1983)

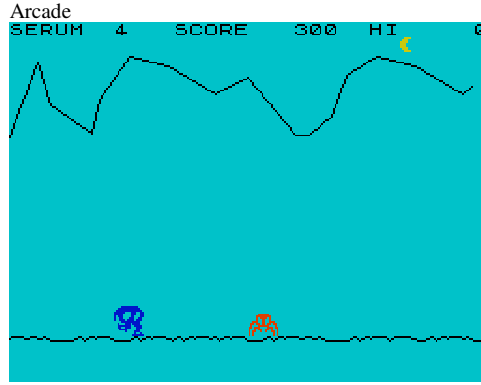

Horizons (Sinclair Research Ltd,1982)

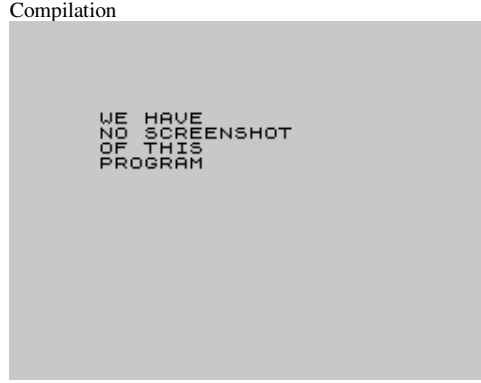

Horoscoop (Jan Kempherbeek,1986)

Utility: Astronomy/Astrology

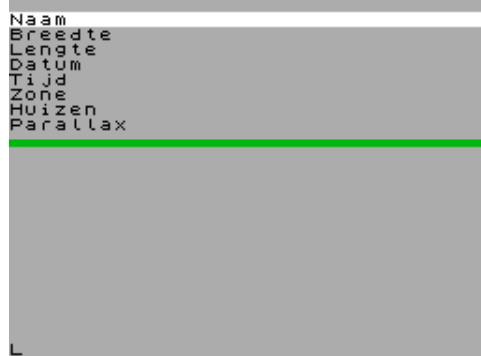

Horoskop (.)

Utility: Astronomy/Astrology

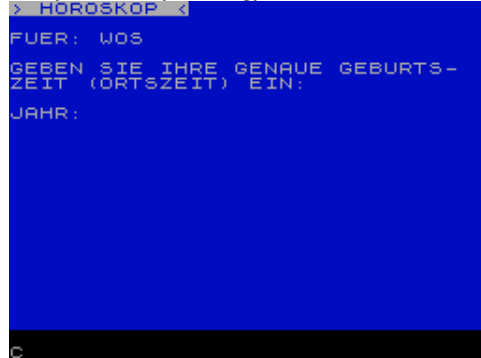

Horse Analysis (Steve McCarthy,1984)

Utility

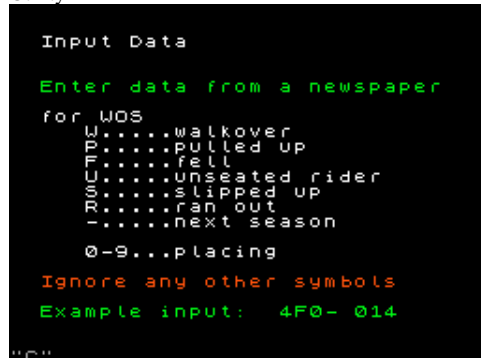

Horace Goes Skiing (Sinclair Research Ltd,1982)



Hormiguero Maldito (MicroHobby,1985)



Horoscoop 48K (MCN Software,1986)

Utility: Astronomy/Astrology



Horror Atoll (Kayde Software Ltd,1983)

Text Adventure



Horse Race (Finsbury Software,1984)

Sport



Horse Race Analyser (Mayday Software,1984)
Utility

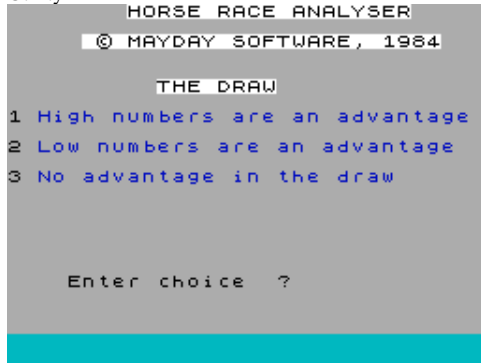

Horse Race Predictions (D. Jackson,) Utility



Horse Race Predictor: Flat Racing (Rombest,1984)
Simulation



Horse Racing Analysis (Computer Rating Methods,1986)
Sport

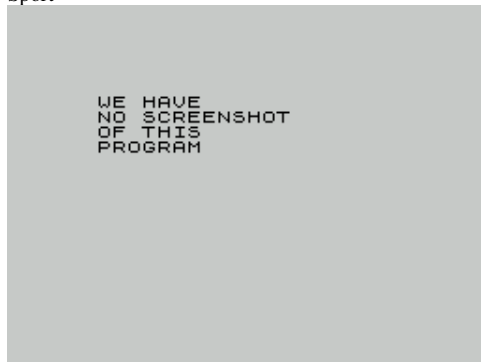

Hospital, The (Zenobi Software,1994)
Text Adventure

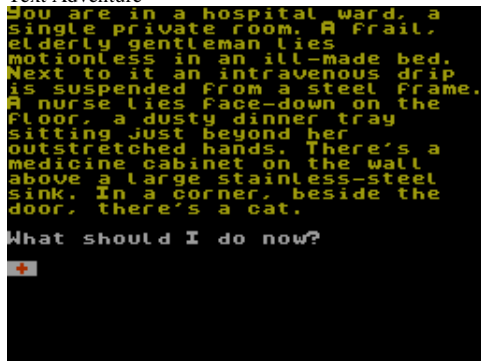

Horse Race Forecast (Kuma Computers Ltd,1983)
Simulation



Horse Race Predictor: Australian Pools (Rombest,1984)
Simulation



Horseracing (CRL Group PLC,1983)
Arcade



Horse Racing Analysis (Holly Products,1982)
Sport

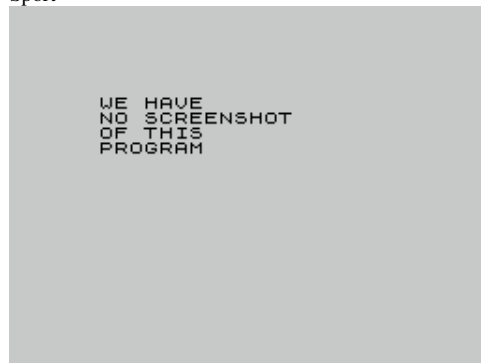

Hostages (Infogrames,1990)
Arcade Adventure



Horse Race Forecasting (Butronics Co,1984)
Simulation



Horse Race Predictor: British Pools (Rombest,1984)
Simulation



Horse Racing (J. Pooley,1985)
Simulation



Horses (John Lewis,1989)
Simulation



Hot Ball (,1989)
Arcade



Hotch Potch (Mastertronic Ltd,1985)
Board/Card Game

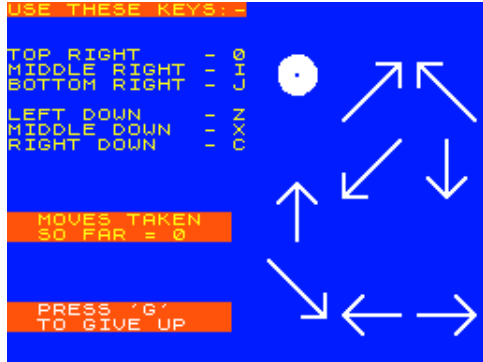

Hotfoot (Microsphere,1982)
Arcade

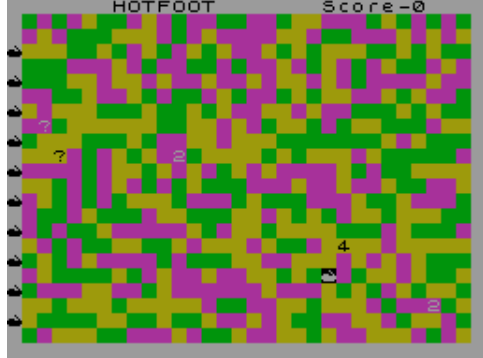

Hotline Quiz (Chalksoft Ltd,1984)
Board/Card Game

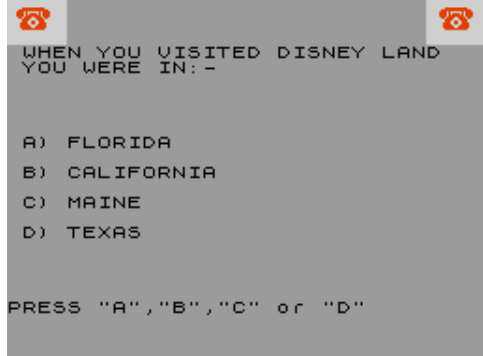

Hot Rods (16/48 Tape Magazine,1985)
Arcade



Hounds of Hell (Peter Clark,1991)
Text Adventure



Hot Dot Spotter (Longman Software,1983)
Educational

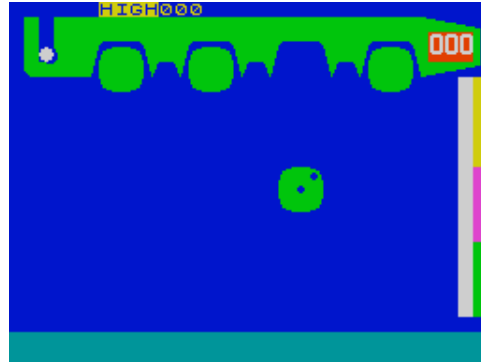

Hothouse Hell (Anik Microsystems,1984)
Arcade



Hot Rod (Activision Inc,1990)
Arcade

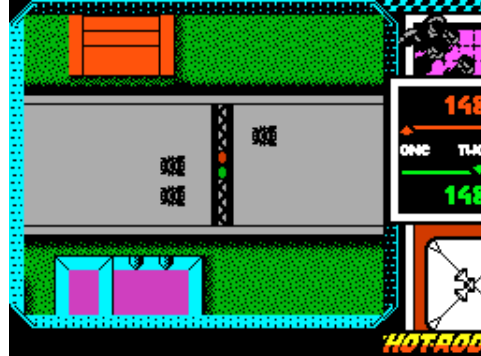

Hotshot (Addictive Games Ltd,1988)
Arcade

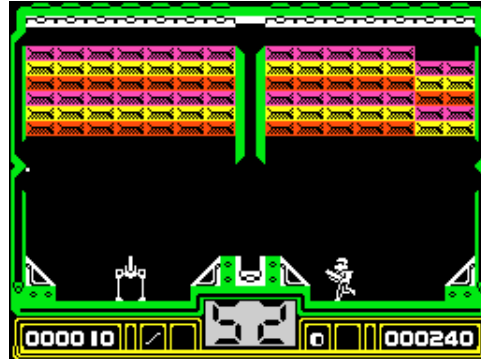

Housebuilder (Scetlander,1988)
Educational



Hotel Love (Dimasoft,)
Scene Demo

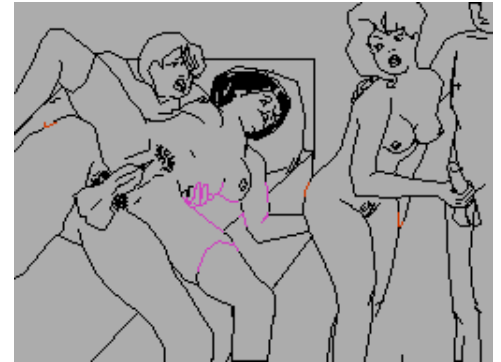

Hot Joystick (Digital Design,)
Scene Demo

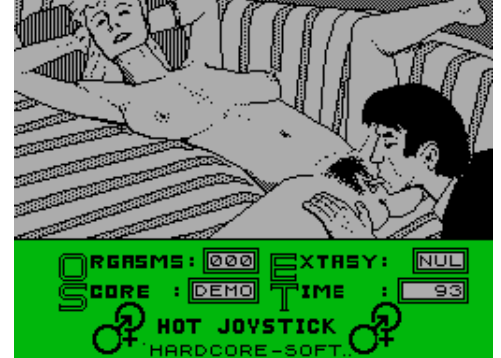

Hot Rodder (.)
Arcade

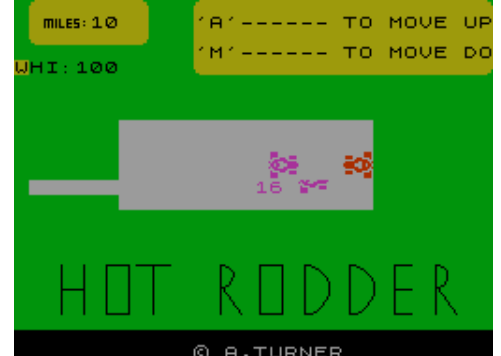

Hotshots (The Force,1986)
Compilation



House Jack Built, The (Thor Computer Software,1984)
Arcade



House Mix, The (Gremlin Graphics Software Ltd,1989)
Compilation



House of Orion (Dave Newton,1984)
Text Adventure

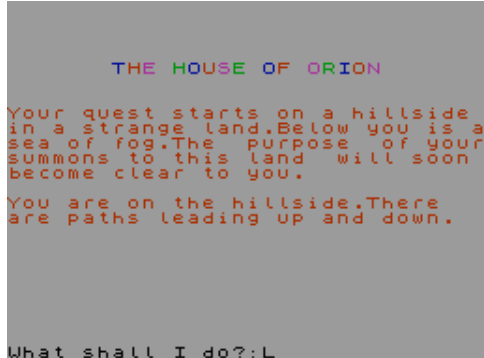

House of the Living Dead (Phipps Associates,1983)
Arcade

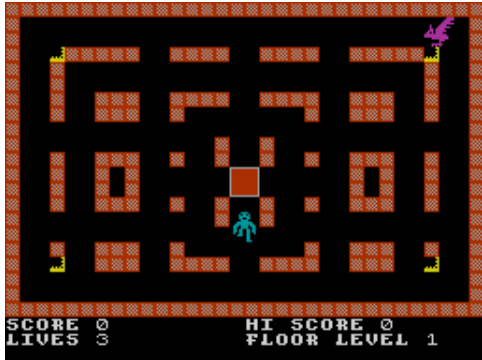

House out of Town (Simon Avery,1991)
Text Adventure



Hover + Panic (Dollarsoft,1984)
Compilation



House of Horrors (.)
Text Adventure

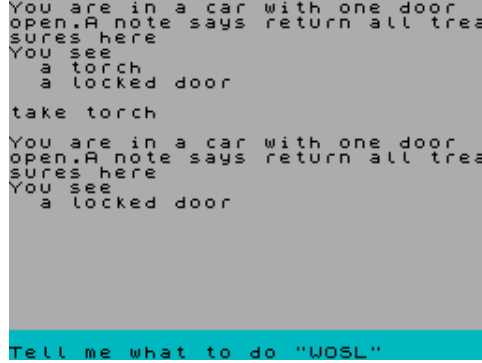

House of Shadows, The (Shadow Software,1983)
Text Adventure

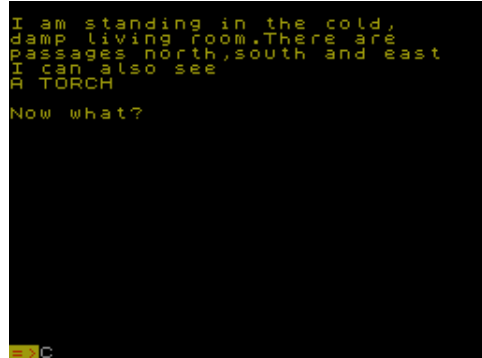

House on Damned Hill, The (Century City Software Ltd,1984)
Text Adventure



Houses (Widgit Software Ltd,1983)
Educational

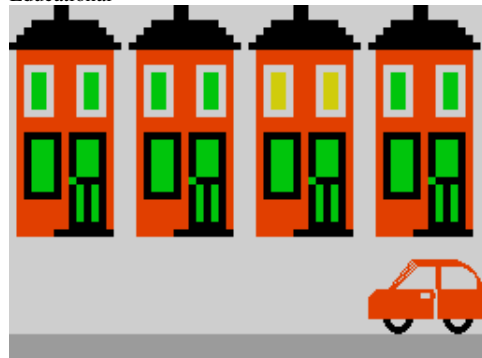

Hover Bovver (Salamander Software,.)
Arcade



House of Lockerby, The (Adventure Probe Software,2000)
Text Adventure

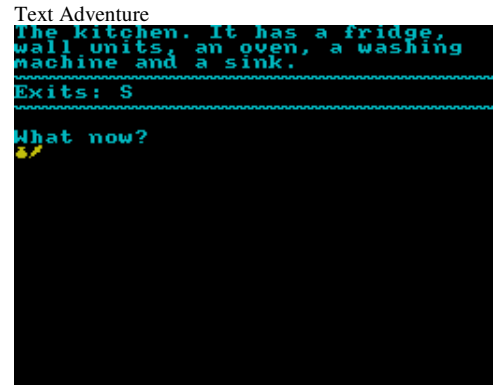

House of the Dead (.)
Text Adventure

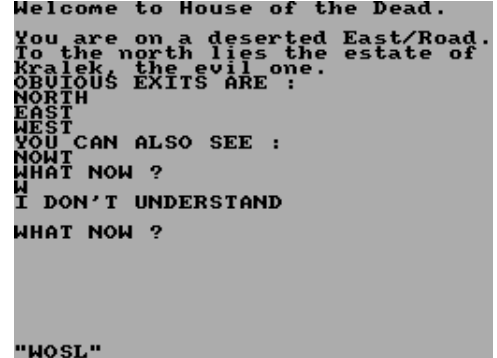

House on the Tor, The (Zenobi Software,1990)
Text Adventure

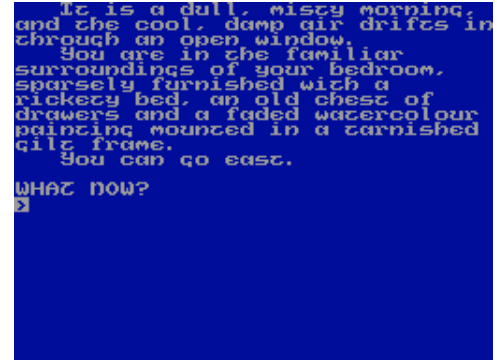

House, The (Zenobi Software,1994)
Text Adventure



Hover Droid (Stew Fordyce,1987)
Arcade



Hoverkraft (Andreas Zallmann Software,1985)

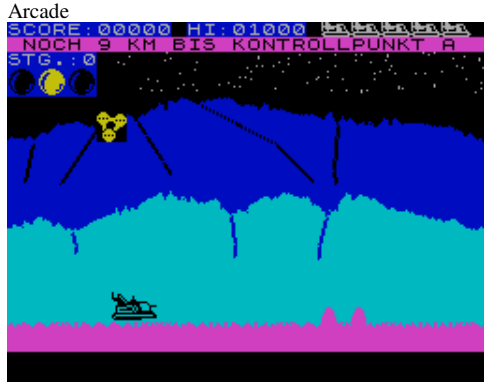

Howard the Duck (Activision Inc,1987)



How Long Have You Got? (Eastmead Computer Systems,1984)

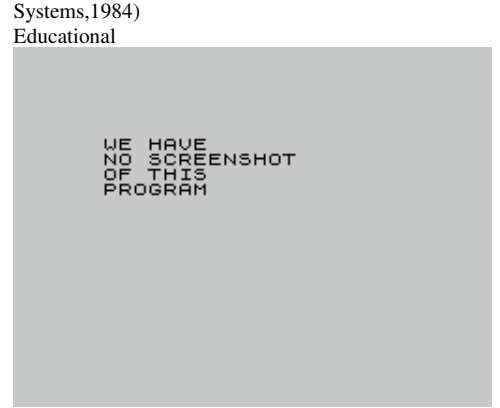

How to be a Complete Bastard (Virgin Games Ltd,1987)



How to be a Hero (Mastertronic Added Dimension,1987)

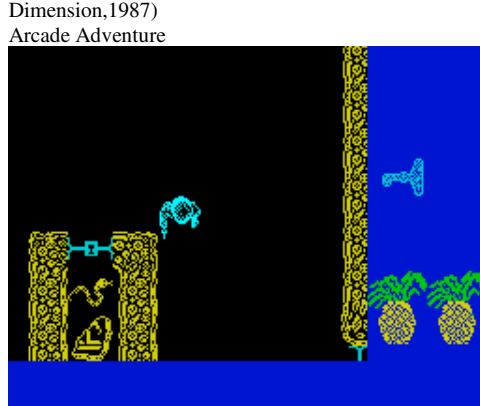

How to Get the Most out of Your Computer (The Power House,) Compilation

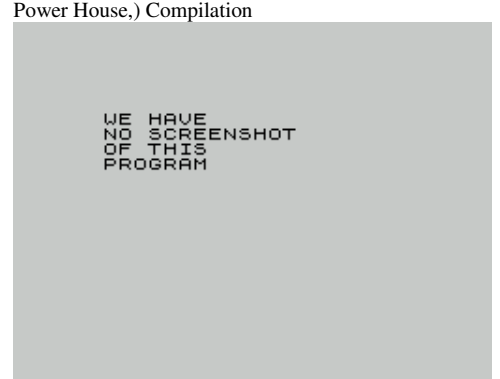

Howzat (Wyvern Software,1984)



HRH (8th Day Software,1986)

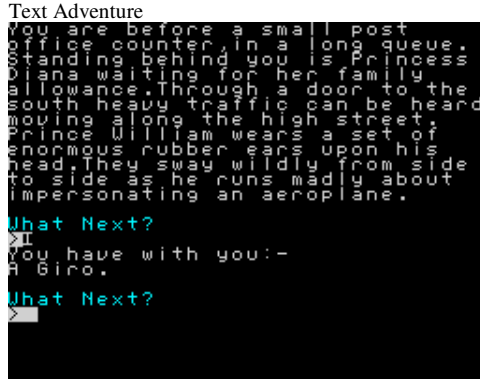

HRH + Cuddles (Powerplay,1986)

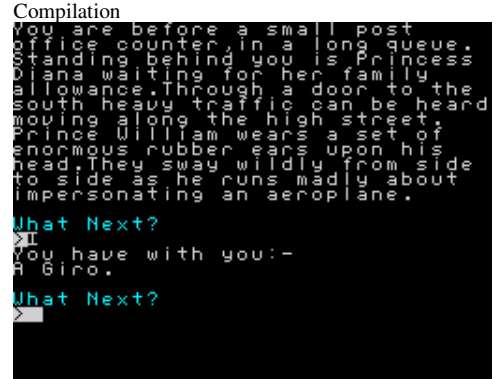

HRP (16/48 Tape Magazine,1984)



HS-Compiler (M.C.G.V.,1984)

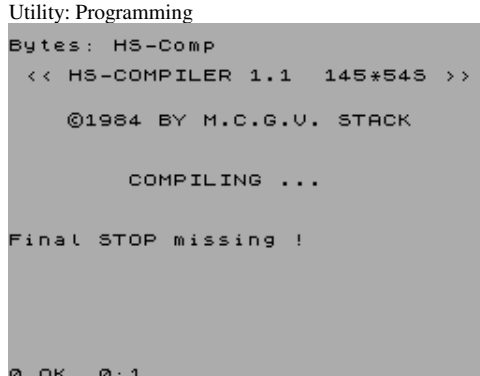

Hubert (Blaby Computer Games,1984)

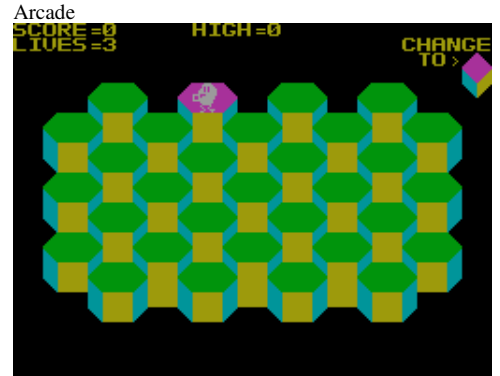

Hudson Hawk (Ocean Software Ltd,1991)

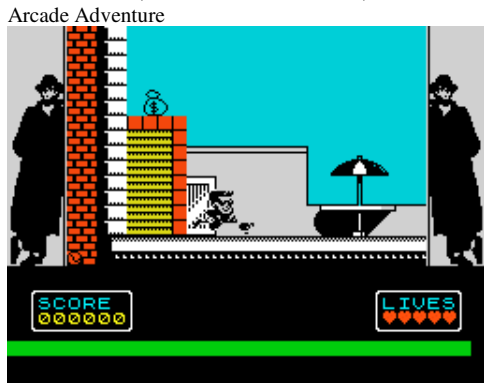

Hudson Hawk Secret Demo (Oscar & Spielberg,)



Huevos Alienigenas (Microparadise Software,1984)



Huida de Ciro, La (EP Software,)

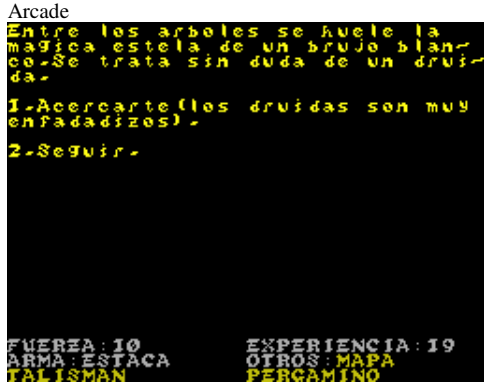

Humanoid (Shock Software,1996)



Humphrey (Zigurat Software,1988)

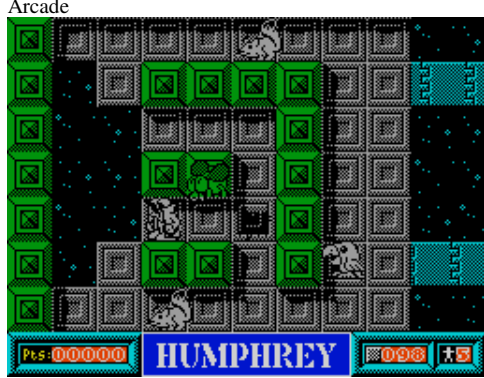

Humpty Dumpty Meets the Fuzzy Wuzzies (Artic Computing Ltd,1984) Arcade



Hunchback (Ocean Software Ltd,1984)

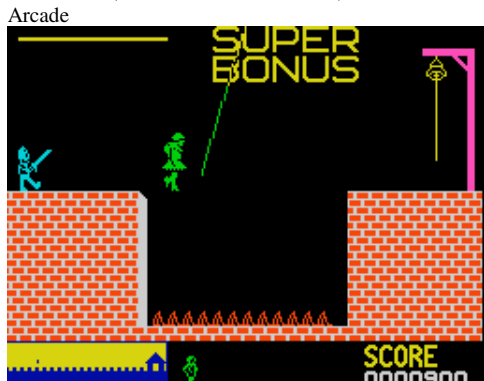

Hulk, The (Adventure International,1984)



Human Torch and the Thing (Adventure International,1986) Text Adventure



Humpty Dumpty (Firefly Software,1984)

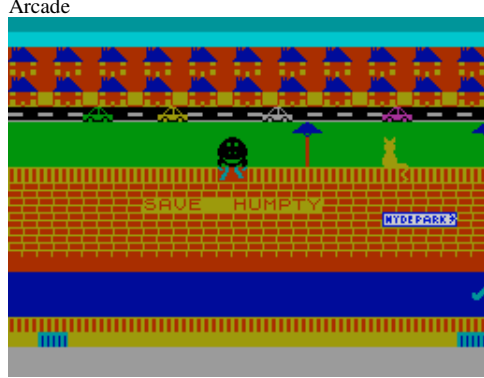

Humpty Dumpty Mystery, The (Widgit Software Ltd,1983)

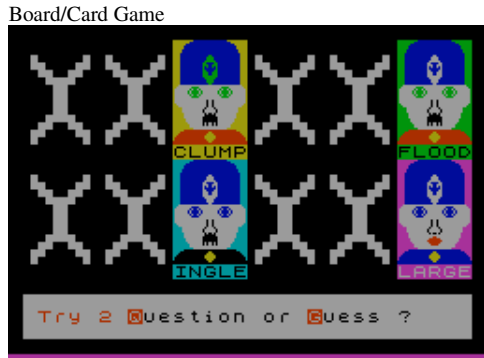

Hunchback II: Quasi Modo's Revenge (Ocean Software Ltd,1985) Arcade



Human Killing Machine (US Gold Ltd,1988)



Hummer House of Horror (Lasersound Ltd,1983) Text Adventure



Humpty Dumpty in the Garden (Artic Computing Ltd,1984)



Humpty Goes Walkabout (Artic Computing Ltd,1984) Arcade



Hunchback - The Adventure (Ocean Software Ltd,1986) Text Adventure



Hunchy (Mr. Micro Ltd,1983)
Arcade



Hundred, The (X-Masters,1996)
Arcade

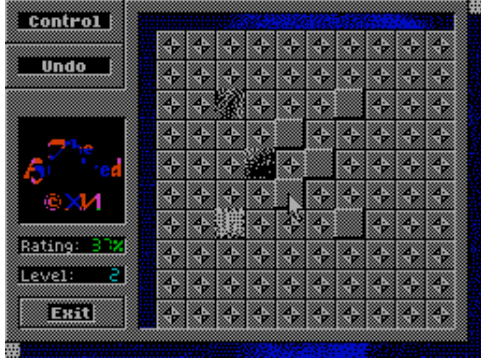

Hunter (David Rushall,1984)
Arcade



Hunter-Killer (Protek Computing Ltd,1983)
Simulation

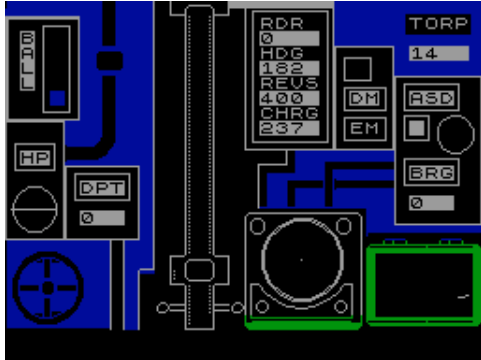

Hunting Mix (New Frontier.)
Arcade



Hunchy (Your Computer,1983)
Arcade

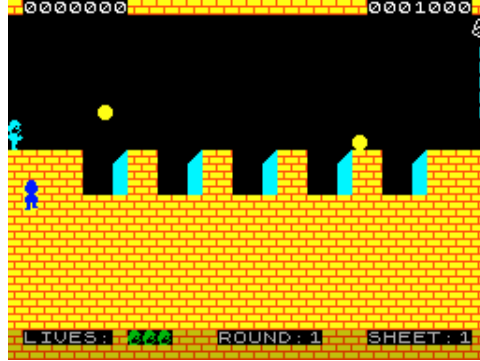

Hungry Horace (Sinclair Research Ltd,1982)
Arcade



Hunter II (David Rushall,1985)
Arcade



Hunt for Red October, The - Based on the Book (Grandslam Entertainments Ltd,1988) Arcade Adventure

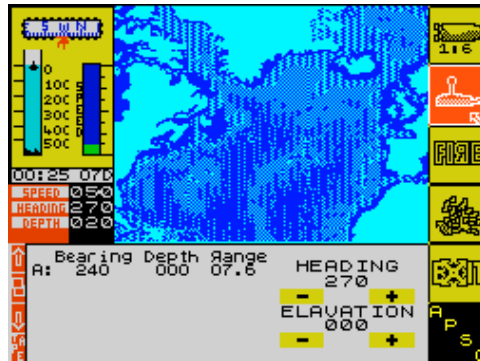

Hunt on Sparrows (Green Bit,2001)
Arcade



Hundra (Dinamic Software,1987)
Arcade

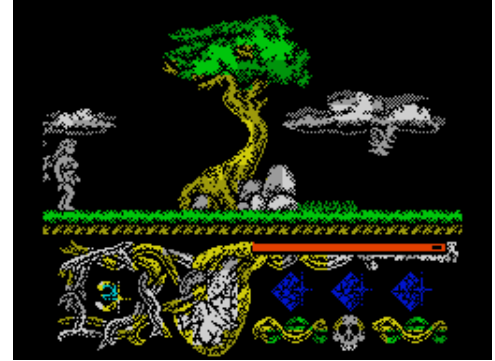

Hunter (Atlantis Software Ltd,1991)
Arcade



Hunter III: The Final Straw (David Rushall,1986)
Arcade



Hunt for Red October, The - Based on the Movie (Grandslam Entertainments Ltd,1991) Arcade Adventure



Hunt, The (.)
Text Adventure



Hunt the Hurkle (Sinclair User,1985)
Arcade

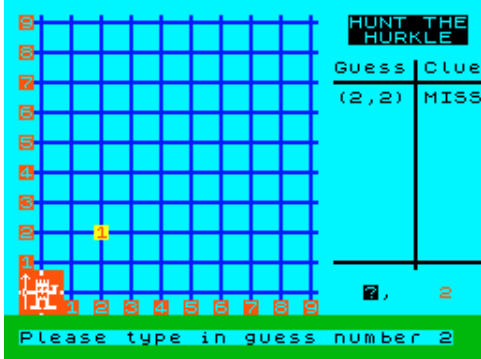

HURG (Melbourne House,1984)
Arcade

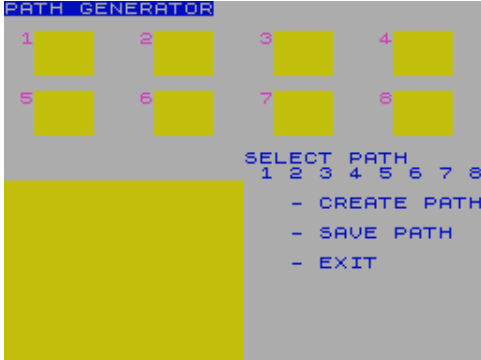

Huxley Pig (Alternative Software Ltd,1991)
Arcade Adventure



Hydrofool (Faster Than Light,1987)
Arcade



Hype (Virgin Games Ltd,1984)
Board/Card Game



Hunt the Wumpus (Wilko Schroter,2006)
Text Adventure

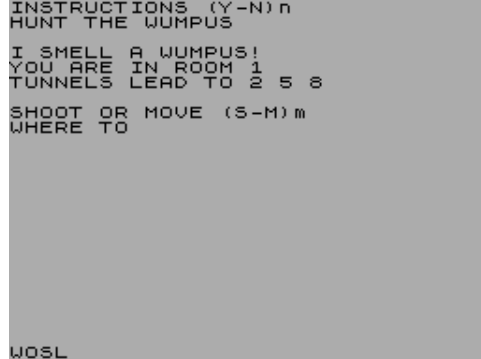

Hurricanes Digi Slideshow, The (Technium 220,1995)
Scene Demo



Hybrid (Starlight Software,1987)
Arcade

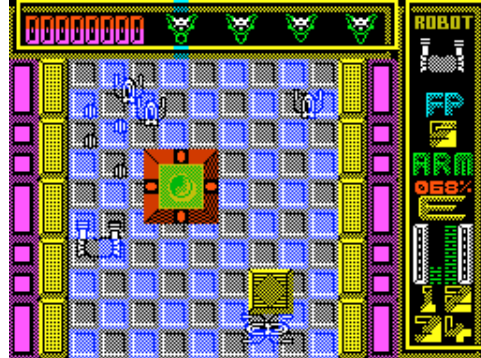

Hypaball (Odin Computer Graphics Ltd,1986)
Arcade



Hyperaction (Silversoft Ltd,1984)
Arcade

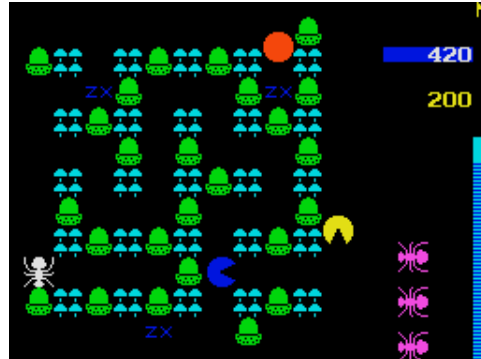

Hurdler (Sinclair Programs,1984)
Arcade



Hustler (Bubblebus Software,1984)
Arcade

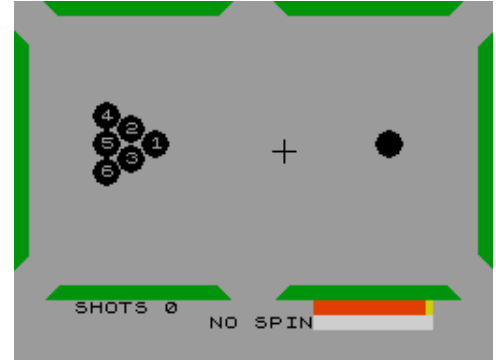

Hydra (Domark Ltd,1991)
Arcade

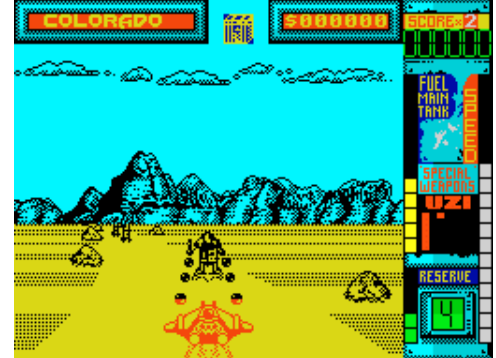

Hypa Raid (Atlantis Software Ltd,1986)
Arcade



Hyper Active (Sinclair User,1987)
Arcade



Hyper Biker (PSS,)
Arcade

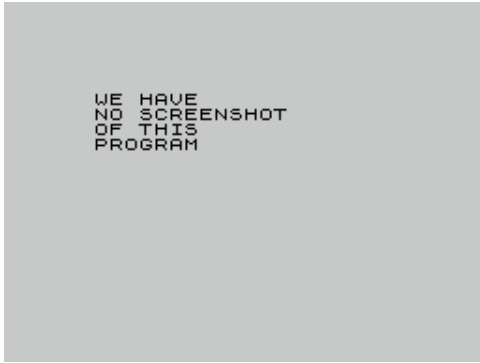

Hyperbowl (Mastertronic Ltd,1986)
Arcade



Hyperlane + (Sinclair User,1991)
Arcade



Hyper Sports (Imagine Software Ltd,1985)
Sport



Hypsys (Techno Arts,1989)
Arcade

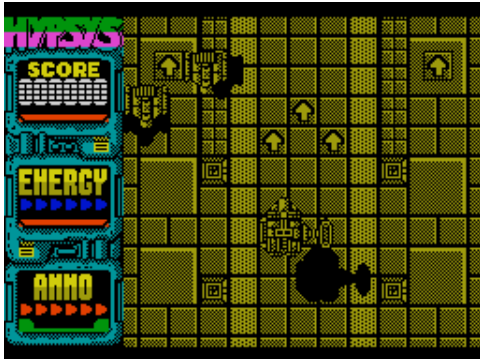

Hyperblaster (MC Lothlorien Ltd,1984)
Arcade

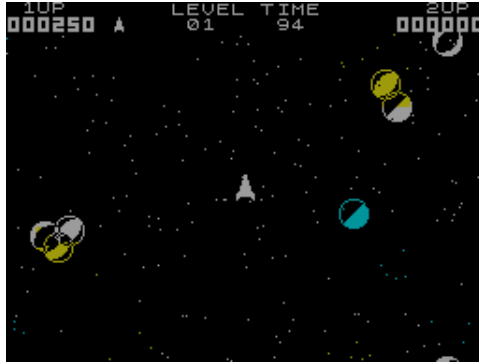

Hyperchess (Spectrum Computing,1985)
Board/Card Game



Hypersonic 2 (Pentagram,1992)
Scene Demo



Hypertron (Scorpio Gamesworld,1987)
Arcade

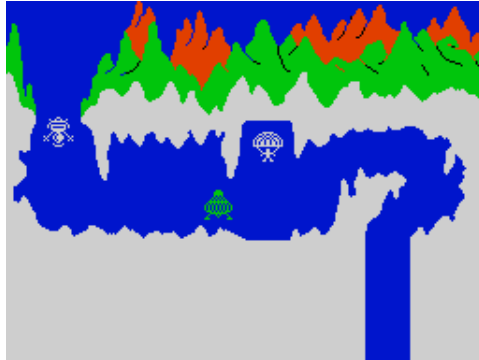

Hysteria (Software Projects Ltd,1987)
Arcade

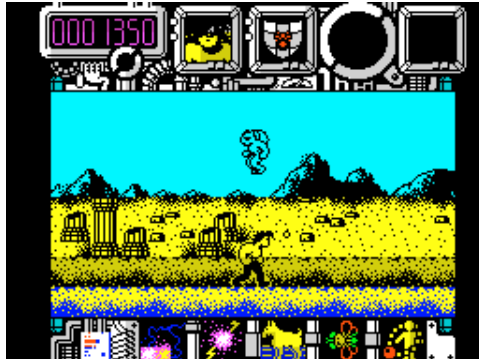

Hyperbowl (16/48 Tape Magazine,1984)
Arcade

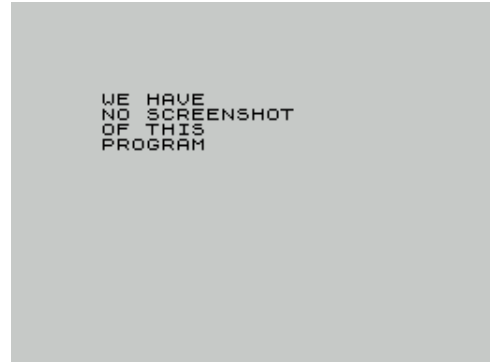

Hyperlane (Crash,1989)
Arcade



Hypersonic 2 Preview (Pentagram,1991)
Scene Demo



Hypnotic World (Triton,1995)
Scene Demo

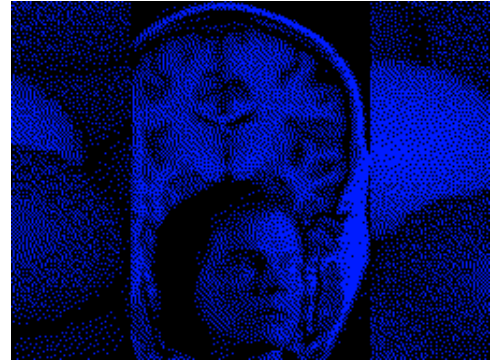

I Aint Got Nobody (Tynesoft,)
Arcade

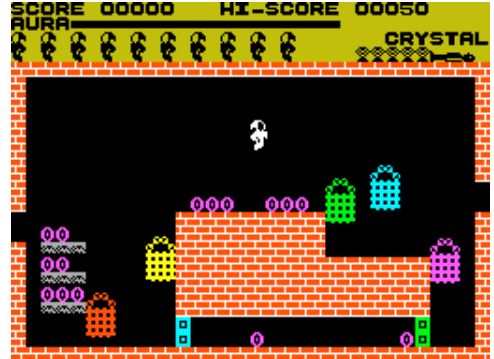

I Alien (CRL Group PLC,1988)
Arcade

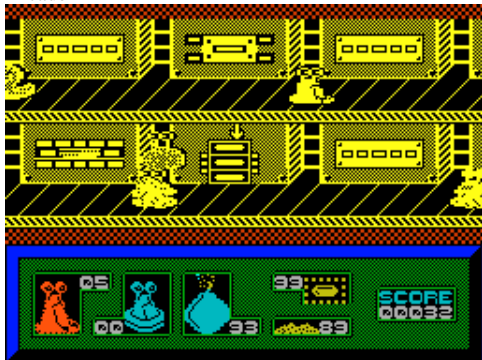

Ian Botham's Test Match (Tynesoft,1985)
Sport



Ian Botham's Test Match + Pyjamarama (Tynesoft,1985)
Compilation



Ian Botham's Test Match + Superfile (Tynesoft,1985)
Compilation



Ian's Night Out (.)
Arcade



I, Ball (Firebird Software Ltd,1987)
Arcade



IBall II (Firebird Software Ltd,1987)
Arcade



IBIS (Impact Software [2],1996)
Utility



I.B.U. (INDUG,1988)
Utility



Icarus Igginbotham (5D Software,1984)
Arcade



Ice Attack (K'Soft Ltd,1986)
Arcade

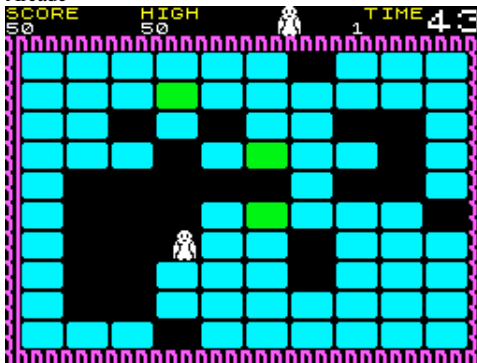

Ice Attack (Q Bit,1984)
Arcade



Iceberg (Abacus Programs,1982)
Arcade

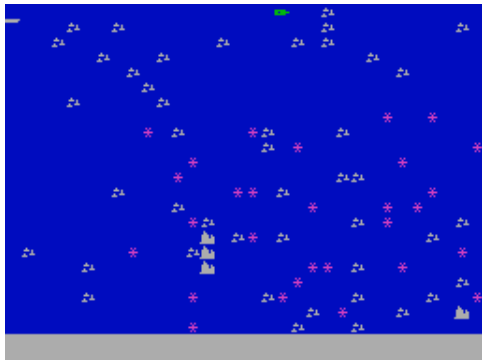

Ice Block (MicroHobby,1987)
Arcade



Ice-Breaker (Topo Soft,1990)
Arcade



Ice Climber (V.D.V. Corp,1996)
Arcade

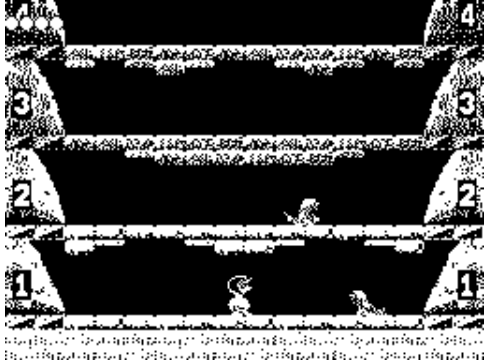

Ice Temple, The (Bubblebus Software,1986)
Arcade



Icicle Works (Statesoft,1985)
Arcade Adventure

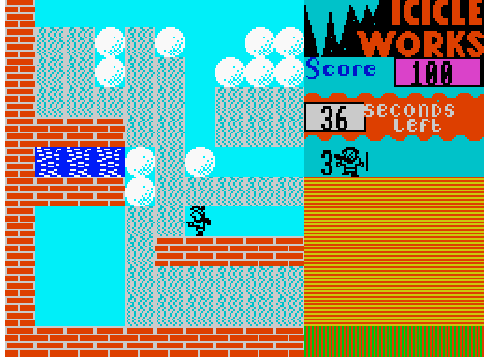

Iconclass (MicroHobby,1991)
Utility

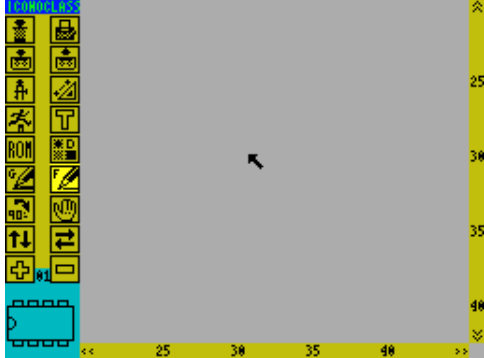

I Dare You (Pegasus Software,1992)
Text Adventure

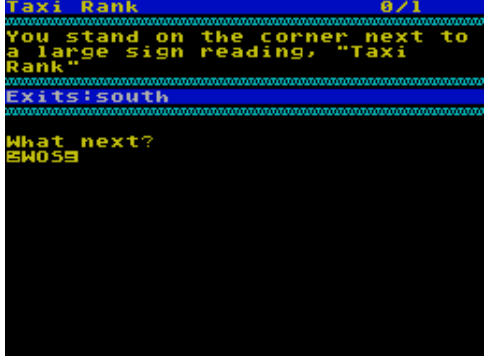

Ice Cream (World Eyes Group,1996)
Scene Demo



I-Ching (MicroHobby,1985)
Utility



Icon (Theodore Blitsas,1986)
Utility: Astronomy/Astrology

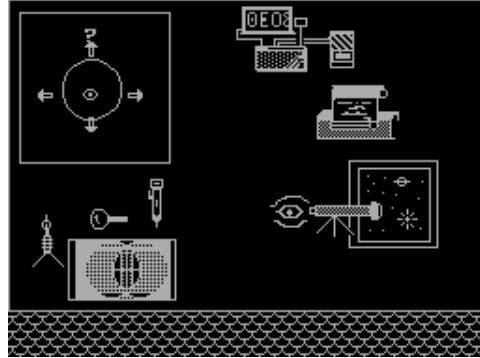

I.C.U.P.S. (Thor Computer Software,1986)
Arcade



ID-Demo 1 (Icabod,1993)
Scene Demo



Ice Station Zero (8th Day Software,1985)
Text Adventure

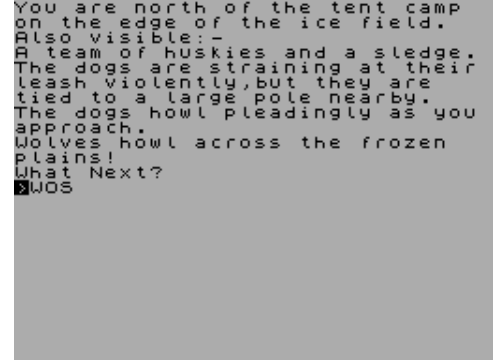

I Ching (Salamander Software,1984)
Utility



Icon Graphix (Audiogenic Software Ltd,1986)
Utility: Drawing



iD (Nu Wave Software,1986)
Simulation

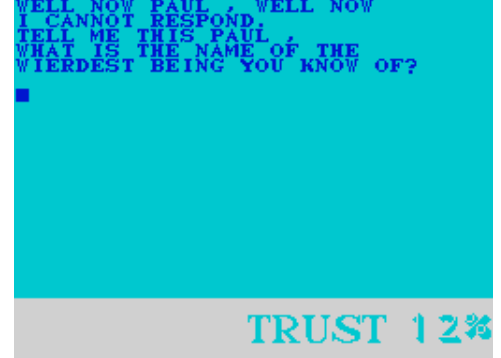

ID-Demo 2 (Icabod,1993)
Scene Demo

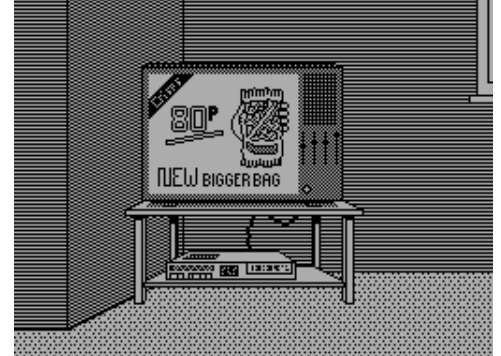

Identify Europe (Kosmos Software Ltd,1987)

Educational



Idle Space 1 (Fire Angel Software,1993)

Scene Demo



I/F Centronics (Pin Soft S.A.,)

Utility



III Guerra Mundial, La (Software Center S.A.,1985)

Arcade



Ikaros (Theodore Blitsas,)

Arcade



Identikit (Stell Software,1983)

Educational

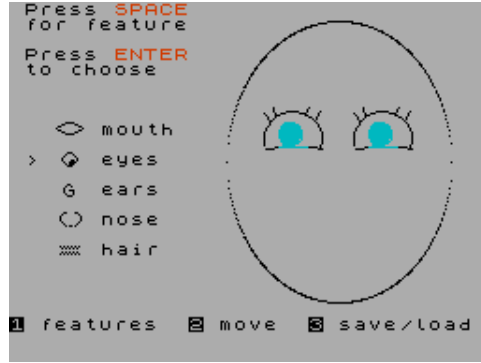

Idle Space 2 (Fire Angel Software,1993)

Scene Demo



Igloo (MicroHobby,1986)

Arcade



IK+ (System 3 Software Ltd,1987)

Sport



Ile Maudite, L' (Loriciels,1984)

Text Adventure



Idiliar (Grupo Creators Union,1991)

Text Adventure



Idolo de Oro, El (MicroHobby,1985)

Arcade



Igor (Grupo de Trabajo Software S.A.,1987)

Arcade



Ikari Warriors (Elite Systems Ltd,1988)

Arcade



Illusion (X-Trade Group,1996)

Scene Demo

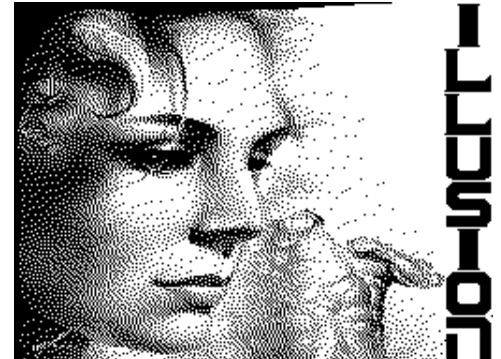

Illustrator, The (Gilsoft International,1983)
Text Adventure Development Tool

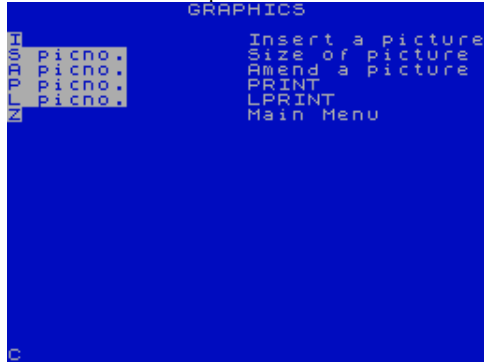

Imagination (Firebird Software Ltd,1987)
Text Adventure

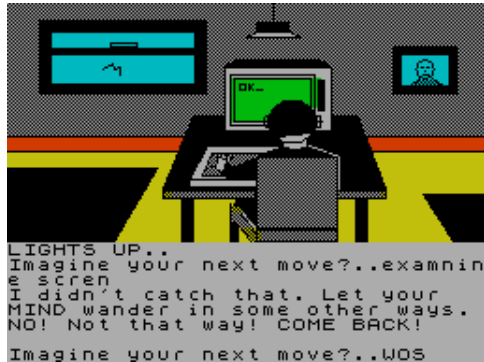

I'm in Shock (Artic Computing Ltd,1984)
Arcade

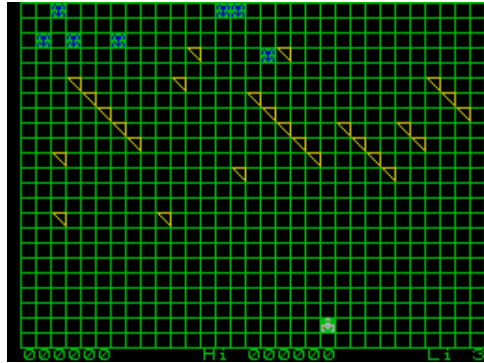

Impact! (Zenobi Software,1992)
Text Adventure



Imperator (Victory Computing,1990)
Strategy

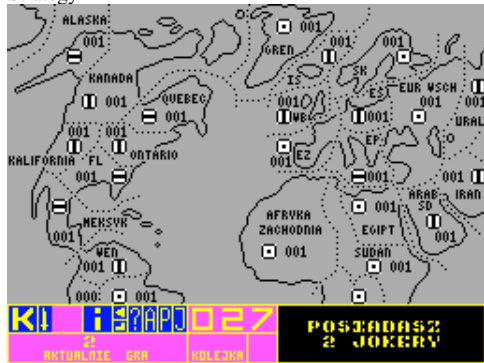

Imager (Spectrum Computing,1985)
Utility: Screen Manipulation



Imagine (.)
Text Adventure



Immortality Rules OK (Deltoid Developments,1987)
Text Adventure

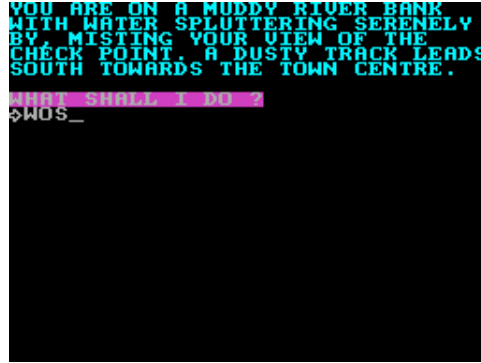

Impacto Profundo (Lucas Jorge,2006)
Arcade



Imperator (Zagruvaetsq,1992)
Arcade

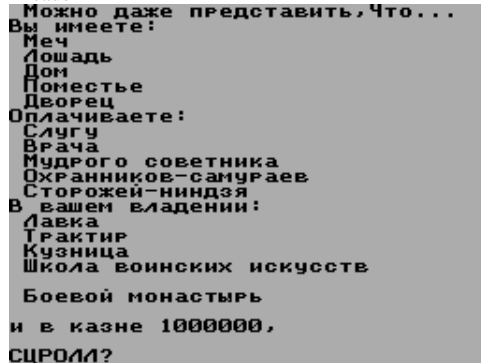

Images (SciCAL Software Ltd,1985)
Educational

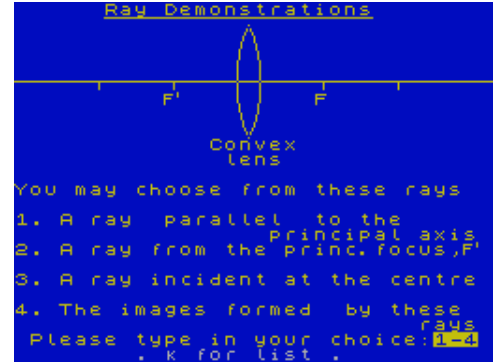

IMBOS (Kobrahsoft,1988)
Utility



Impact! (Audiogenic Software Ltd,1988)
Arcade



Imperator (I. Klokov,1991)
Text Adventure

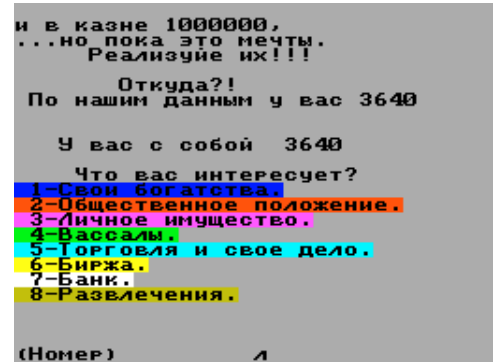

Imperia III (Action,2004)
Strategy



Implosion (Cascade Games Ltd,1987)
Arcade

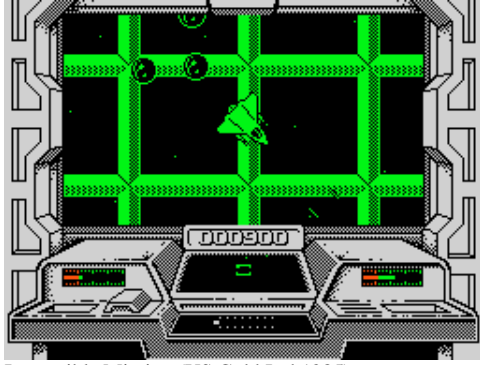

Impossible Mission (US Gold Ltd,1985)
Arcade



Improved Spectrum Character Set (Sam F.E. Goodwin,1988)
Utility: Font/UDGs



Impuls Cassette 003 (Impulsoft,1982)
Compilation



Impuls Cassette 006 (Impulsoft,)
Compilation



Impossaball (Hewson Consultants Ltd,1987)
Arcade



Impossible Mission II (US Gold Ltd,1988)
Arcade



Impuls Cassette 001 (Impulsoft,1982)
Compilation



Impuls Cassette 004 (Impulsoft,)
Compilation

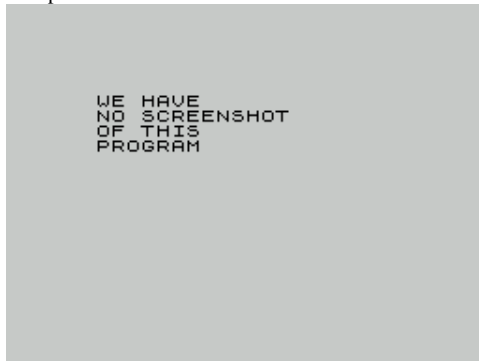

Impuls Cassette 007 (Impulsoft,1983)
Compilation

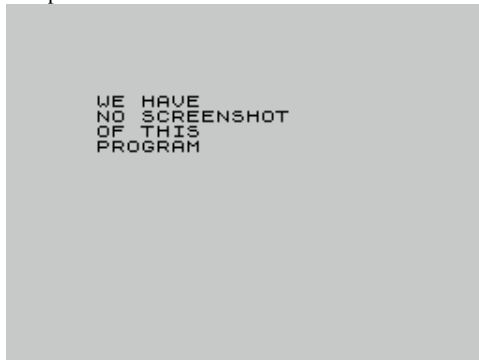

Impossamole (Gremlin Graphics Software Ltd,1990)
Arcade



Imprenta Musical (Music Soft,)
Utility



Impuls Cassette 002 (Impulsoft,1982)
Compilation



Impuls Cassette 005 (Impulsoft,)
Compilation



Impuls Cassette 008 (Impulsoft,)
Compilation



Impuls Cassette 009 (Impulsoft,)
Compilation

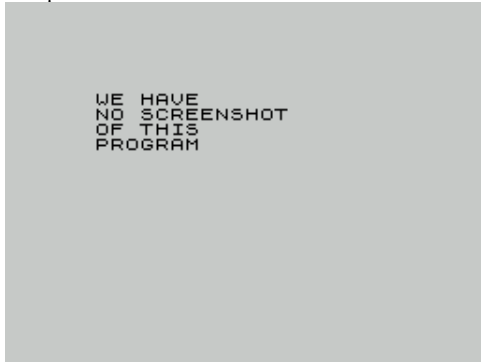

Impuls Cassette 010 (Impulsoft,)
Compilation

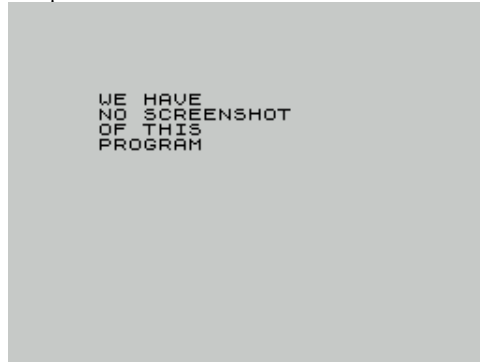

Impuls Cassette 011 (Impulsoft,)
Compilation



Impuls Cassette 012 (Impulsoft,)
Compilation



Impuls Cassette 013 (Impulsoft,)
Compilation



Impuls Cassette 014 (Impulsoft,)
Compilation



Impuls Cassette 051 (Impulsoft,)
Compilation



Impuls Cassette 052 (Impulsoft,)
Compilation



Impuls Cassette 053 (Impulsoft,)
Compilation



Impulse (Your Computer,1985)
Arcade

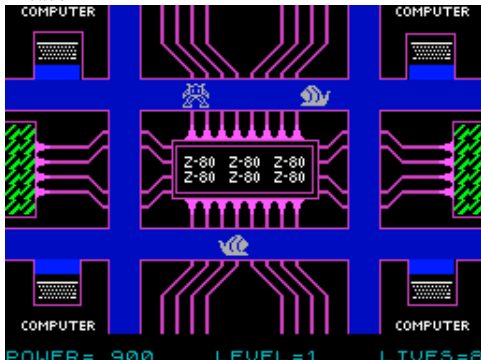

In Concert (Dennis van Berkel,1989)
Scene Demo



Incredible Adventure (CRL Group PLC,1984)
Text Adventure



Incredible Shrinking Fireman (Mastertronic Ltd,1986)
Arcade

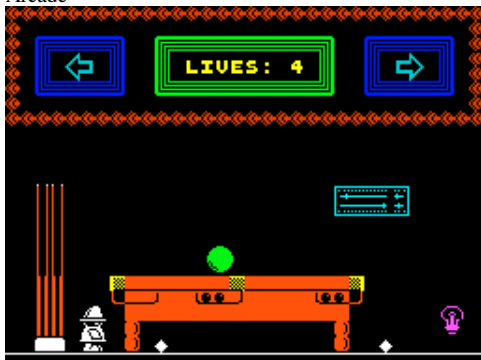

Incredible Shrinking Sphere (Electric Dreams
Software,1989) Arcade

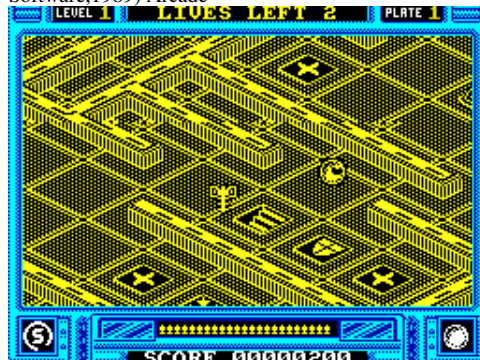

Incremat (Outlet Microdrive Magazine,1989)
Utility



In Crowd, The (Ocean Software Ltd,1989)
Compilation



Indiana Jones (TSR,1984)
Board/Card Game



Indiana Jones 3 (Proxima Software,1990)
Text Adventure

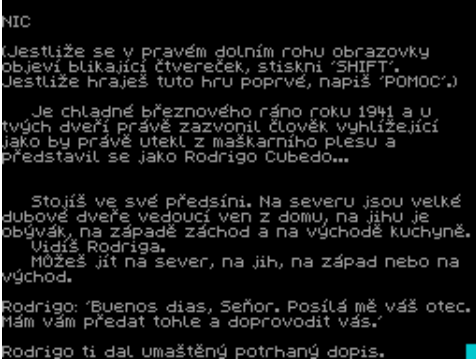

Indiana Jones and the Last Crusade (US Gold Ltd,1989) Arcade



Indian Patience (Tiger's Claw,)
Board/Card Game



In Deep (R'n'H Microtec,1990)
Board/Card Game

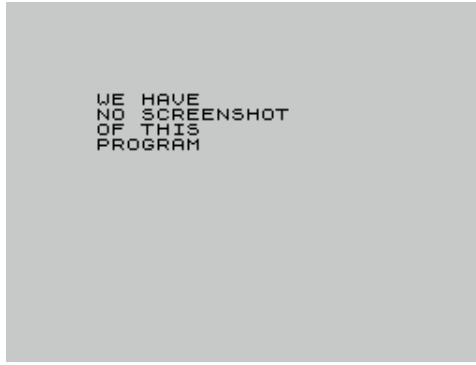

Indiana Jones: A Chram Zkazy (Proxima Software,1985) Text Adventure

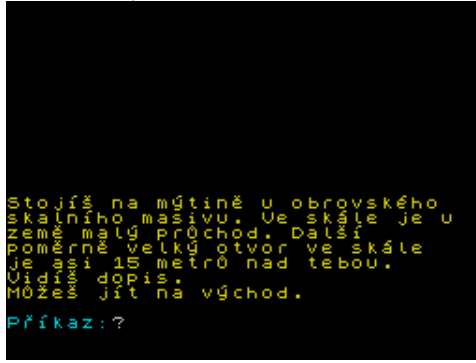

Indiana Jones 4: A Zlata Soska Keltu (Fuxoft,1990)
Text Adventure

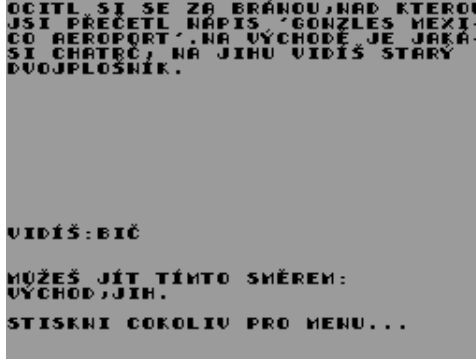

Indiana Jones and the Last Crusade + Indiana Jones and the Temp (US Gold Ltd,1989) Compilation



Indoor Bowling (Alligata Software Ltd,1987)
Sport



In Den Beginne (MCN Software,1984)
Text Adventure



Indiana Jones 2 (Proxima Software,1987)
Text Adventure



Indiana Jones and the Fate of Atlantis (US Gold Ltd,1992)
Arcade Adventure

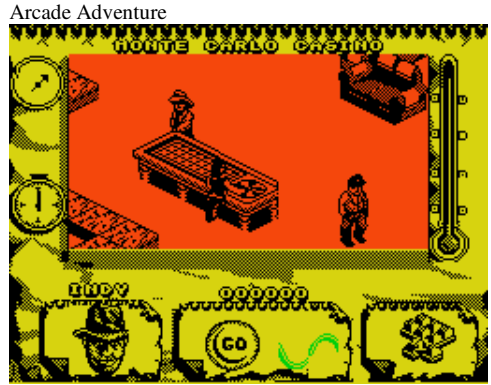

Indiana Jones and the Temple of Doom (US Gold Ltd,1987)
Arcade Adventure

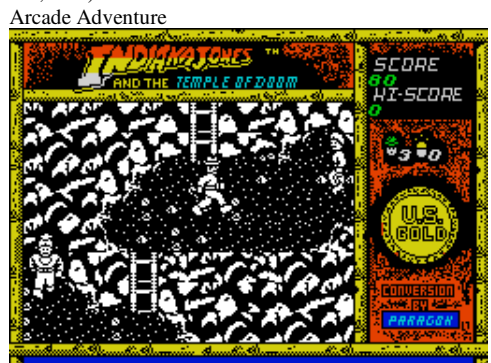

Indoor Race (Mind Games Espana S.A.,1987)
Arcade



Indoor Soccer (Code Masters Gold,1988)
Sport

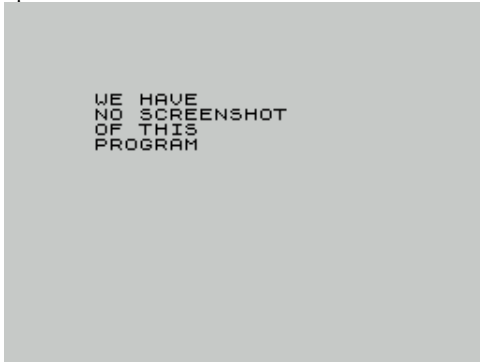

Industrial Paradayzzz (Hooy-Program,1998)
Scene Demo

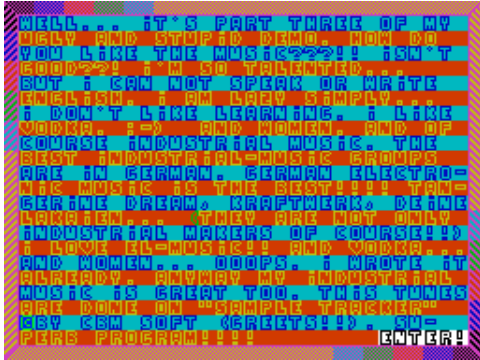

Ines/Denis/Ute/Sorti (Primoz Jakopin,1985)
Compilation



Infer (MicroHobby,1985)
Utility



Inferno (ZX Computing,1985)
Arcade



Indoor Soccer (The Magnificent 7,1986)
Sport



Ines (Primoz Jakopin,1985)
Utility: Word Processor

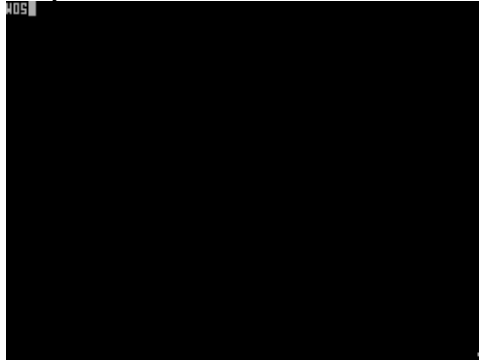

Inferno (Sabe,1990)
Scene Demo

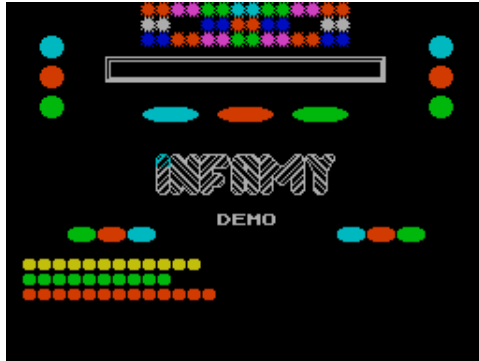

Inferno (Anco Software Ltd,1983)
Arcade



Inferno, The (Richard Shepherd Software Ltd,1984)
Text Adventure



Indoor Sports (Advance Software Ltd,1987)
Sport

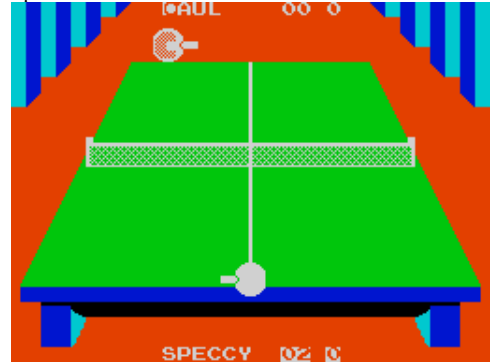

Ines 64 (Primoz Jakopin,1985)
Utility: Word Processor

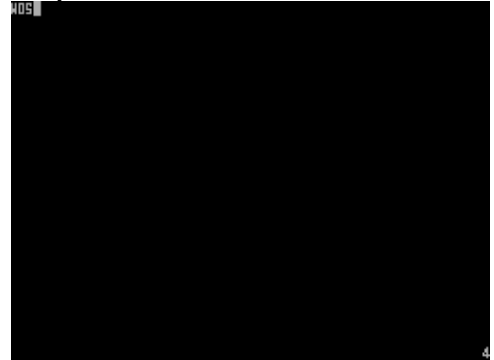

Infection (unpublished,1989)
Board/Card Game

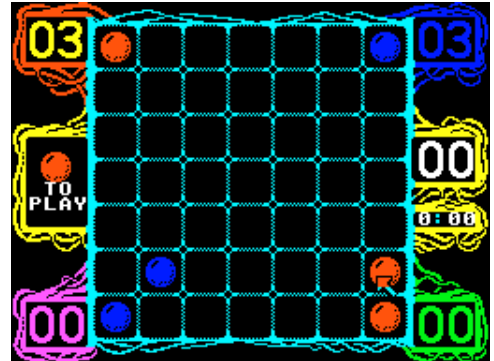

Inferno (Proxima Software,1993)
Arcade

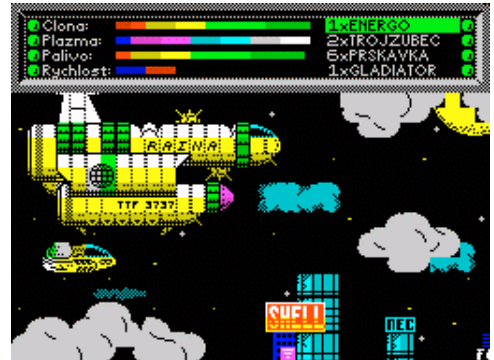

Infilaquattro (Corrado Zanella,1985)
Board/Card Game

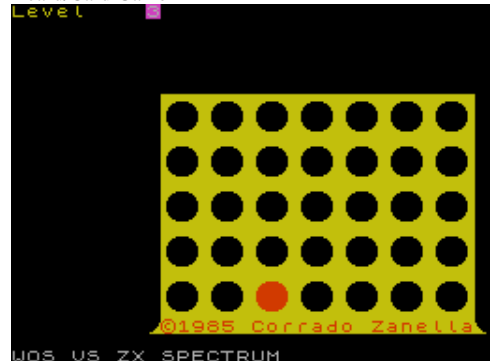

Infiltrado 2: Return To Reactor (OCTOCOM,2004)
Arcade



Influence (Seamans Beer Users Hackers Group,1996)
Scene Demo



Information Processing (Visions Software
Factory,1988)
Educational



Infy (Your Sinclair,1992)
Cheat

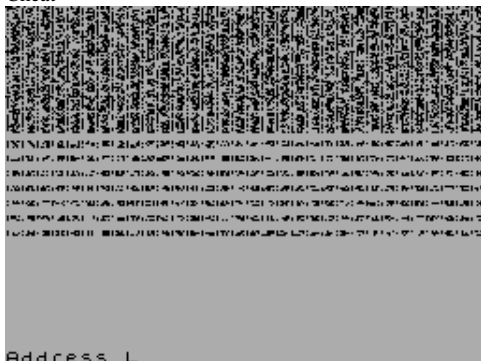

Inheritance, The (Infogrames,1987)
Arcade Adventure



Infiltrator (US Gold Ltd,1986)
Arcade

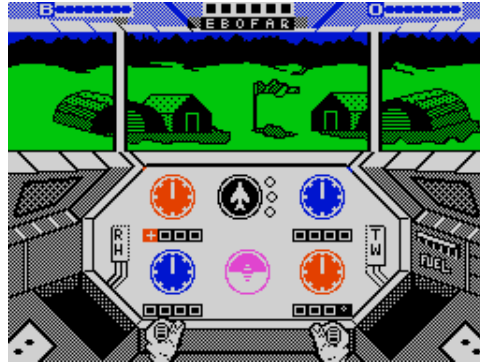

Infodroid (Beyond Software,.)
Arcade



Infrared (ACS Software,1982)

Utility: Assembler/Disassembler/Monitor



Ingrid's Back (Level 9 Computing Ltd,1988)
Text Adventure

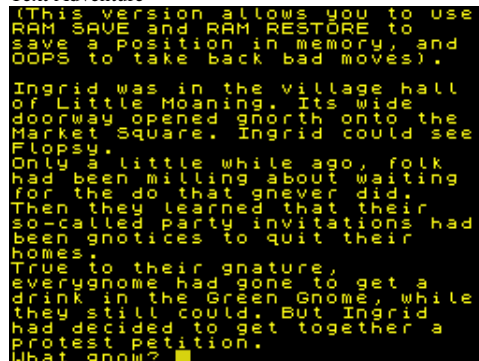

Inherit (Die Erbe) (,1986)

Text Adventure



Infiltrator, The (Zenobi Software,1989)
Text Adventure

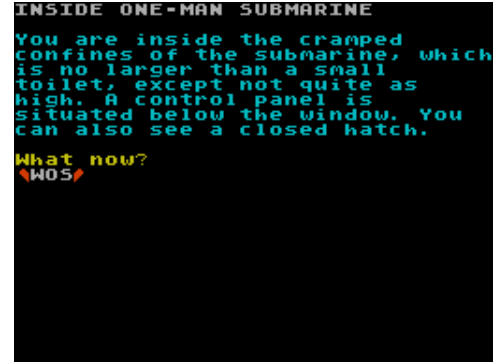

Informace pro Majitele ZX Spectrum (Luxus Software
House,.) Simulation



Infy (SuperSoft [2],1998)

Cheat



Inheritance (Hessel Software,1982)
Strategy

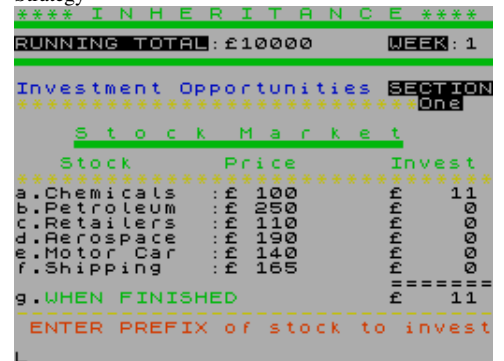

Inhumanos, Los (Delta Software,1990)

Arcade Adventure



Iniciacion al BASIC (Stars,1984)
Educational

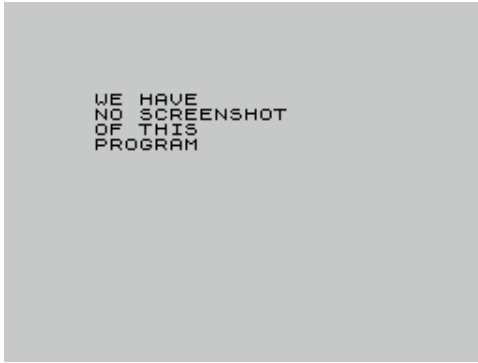

Inka-Tempel (F+K Ware,1983)
Text Adventure

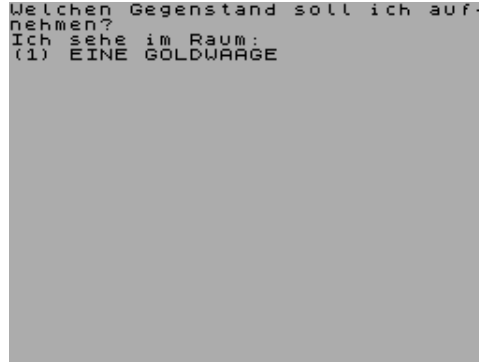

Inkosi (Chalksoft Ltd,1984)
Educational

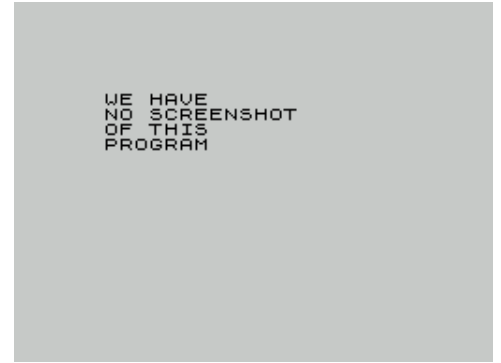

In Macuch's Words (Masters of the Universe,1991)
Scene Demo



Inner Lakes, The (Essential Myth,1988)
Text Adventure

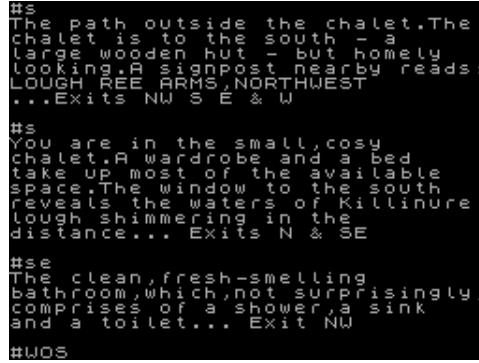

Inner Space 5 (Convention,1995)
Scene Demo



Inner Universe (Extacy-3,1994)
Scene Demo



Inquisitor (Bill & Marion Clews,1985)
Text Adventure

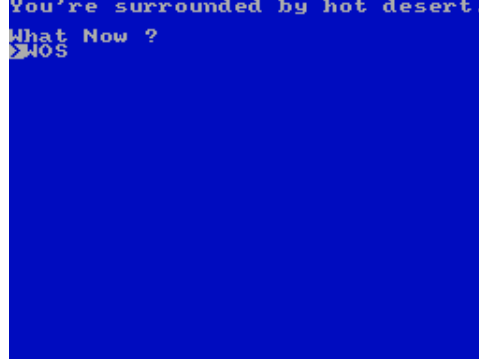

Insane (Phantasy,)
Scene Demo

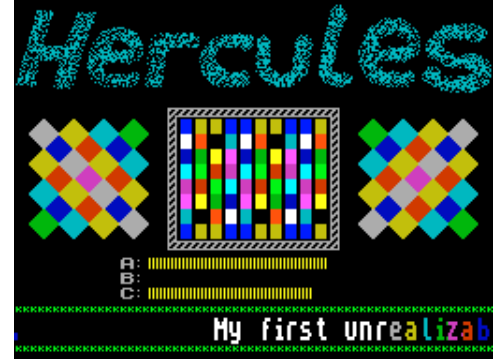

Insanity Part 1 (Extacy-3,1994)
Scene Demo

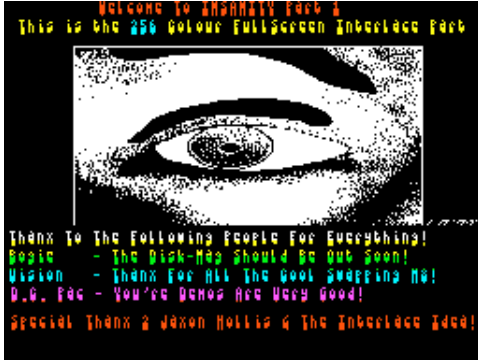

In Search of Angels (8th Day Software,1985)
Text Adventure

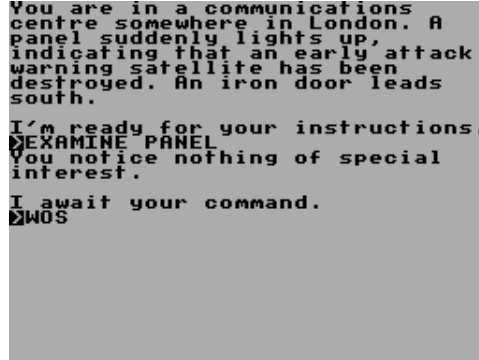

In Search of the Lost Valley (Mega-Soft [2],1988)
Text Adventure

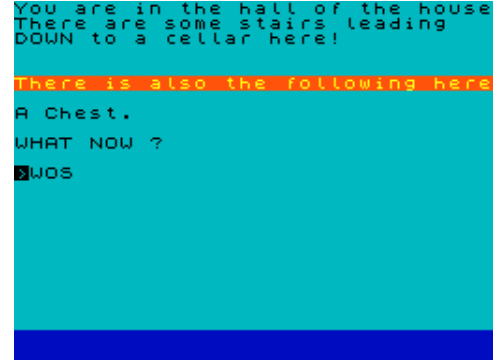

Insector Hecti in the Interchange (Hi-Tec Software Ltd,1991) Arcade



Insert Coins (OCTOCOM,2005)
Arcade



Inside Outing (The Edge Software,1988)
Arcade Adventure



Inspector Flukeit (Top Ten Software,1986)
Text Adventure

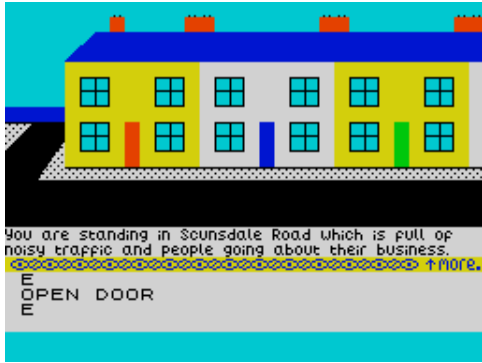

Inspiration (Klav,1992)
Scene Demo



Instant User Defined Graphics (Automata UK Ltd.)
Utility: Font/UDGs

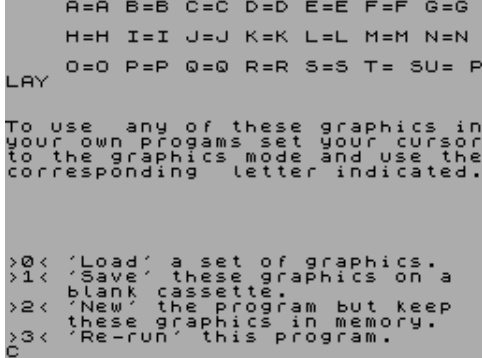

Integer Compiler (Softek Software International Ltd,1983)
Utility: BASIC Related

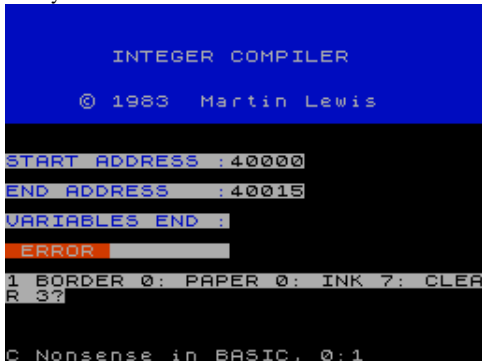

Integrales Indefinidas I (MicroHobby,1986)
Educational

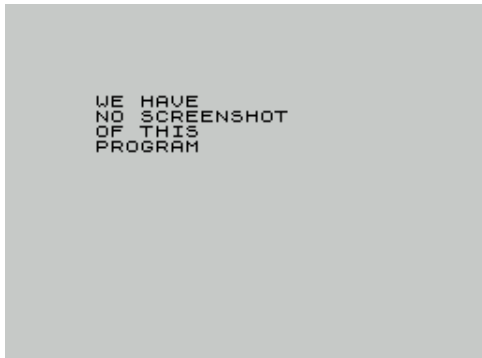

Inspector Gadget and the Circus of Fear (Melbourne House,1987) Arcade

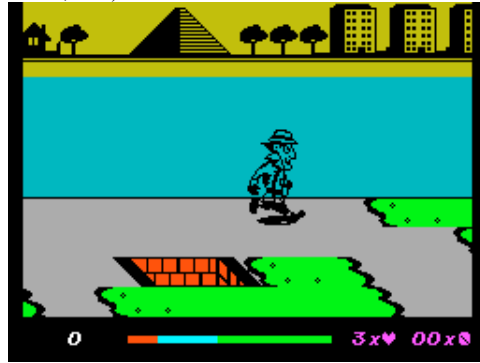

Instant Recall (Supersoft,1992)
Utility



Insult Generator (Greg Fox,1999)
Utility



Integral (MicroHobby,1985)
Educational



Integrales Indefinidas II (MicroHobby,1986)
Educational

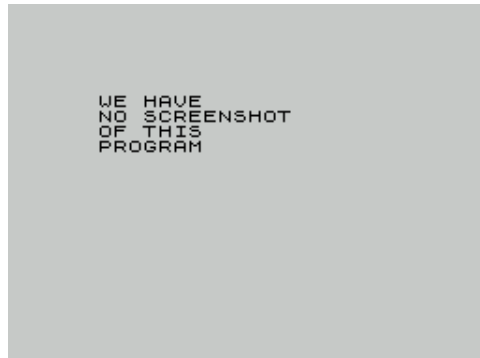

Inspector Inch (Jeffrey Fuge,1989) Arcade



Instant Replay (.)
Utility: Database



Insurgency (CCS,1984)
Strategy

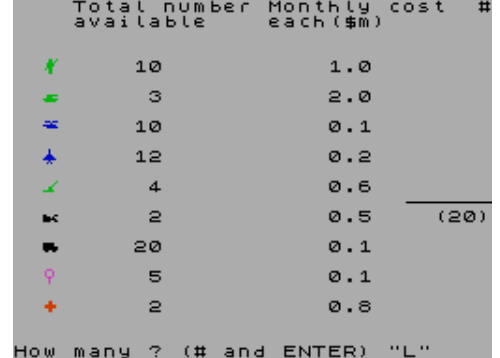

How many ? (# and ENTER) "L"
 Integrales (MicroHobby,1985)
 Utility: Mathematics



Integrales Indefinidas III (MicroHobby,1986)
Educational



Integration (University Software,1983)
Utility: Mathematics



Interchrome (The Gasman,1997)
Scene Demo



Interface III Printer Interface Tape (Evesham Micro Centre,1985) Utility



Intermediate English 2 (Rose Software,1982)
Educational

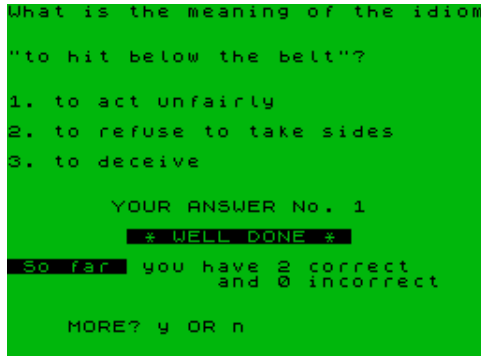

Inteligencia (MicroHobby,1985)
Utility



Intercambio (MicroHobby,1986)
Arcade



Inter City, The (Steam Railway Simulations,1988)
Simulation



Interlace Demo (Busy Software,1992)
Scene Demo



Intermediate Level French (Scisoft,1985)
Educational



Intensity (Firebird Software Ltd,1988)
Arcade

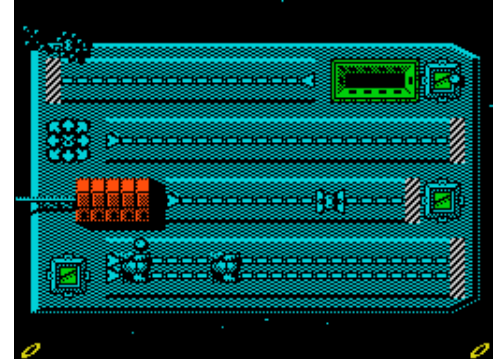

Intercepteur Cobalt (ERE Informatique,1984)
Arcade

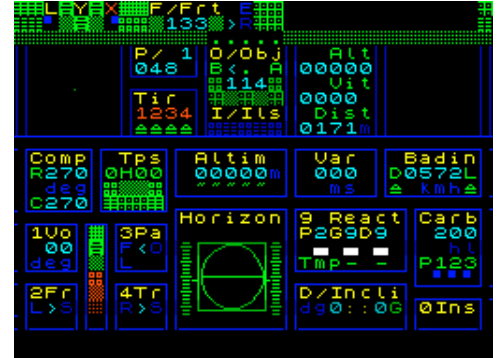

Interface III (Evesham Micro Centre,1985)
Utility: Copier

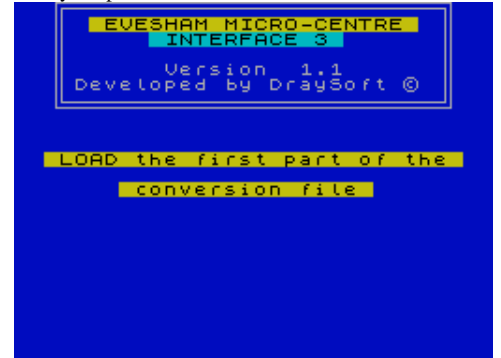

Intermediate English 1 (Rose Software,1982)
Educational

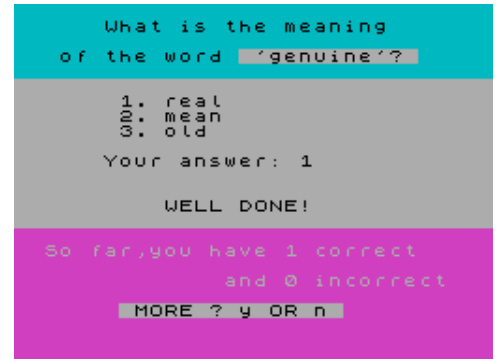

Intermediate Level Geography (Scisoft,1985)
Educational

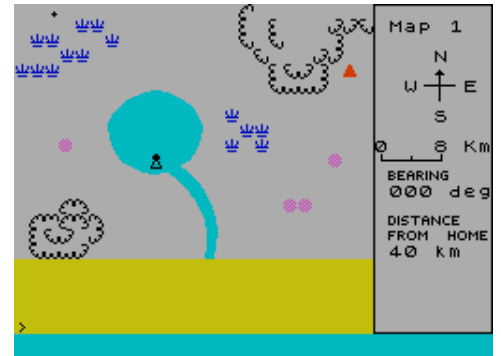

Intermediate Level German (Scisoft,1985)
Educational

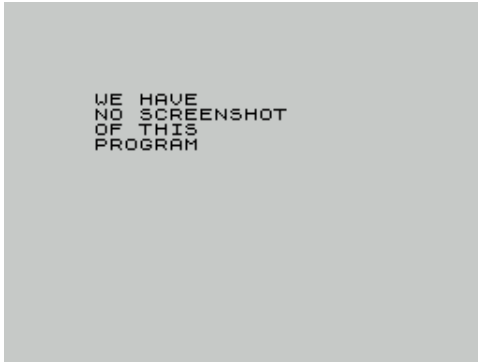

Intermediate Level Maths (Scisoft,1985)
Educational

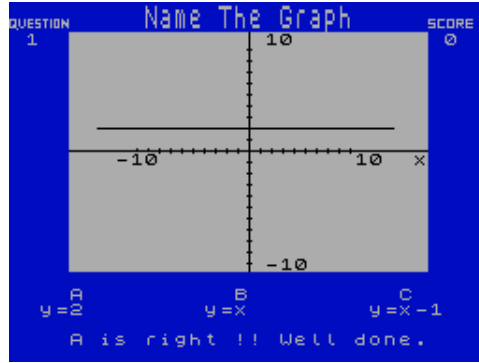

Intermediate Level Science (Scisoft,1985)
Educational

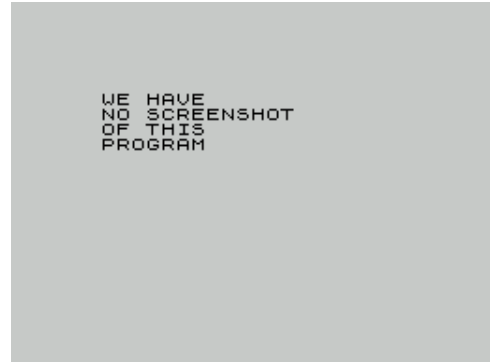

Intermediate Maths 1 (Rose Software,1982)
Educational

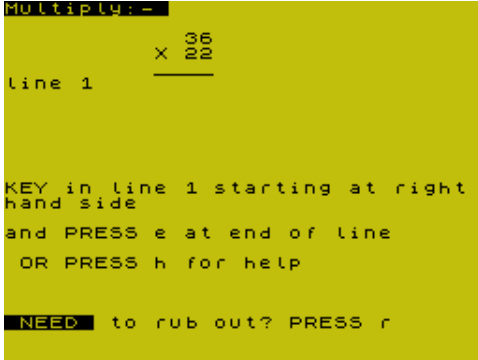

Intermediate Maths 2 (Rose Software,1983)
Educational

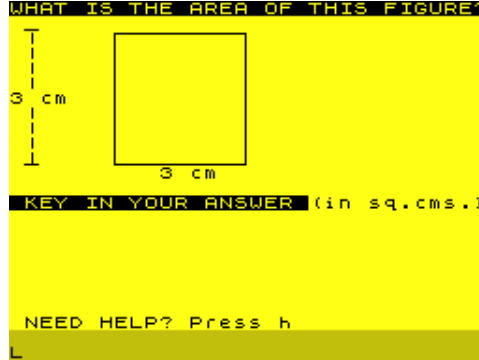

International 3D Tennis (Palace Software,1990)
Sport



International 5-a-Side (Zeppelin Games Ltd,1992)
Sport



International Basketball (Elite Systems Ltd.)
Sport



International Cricket (Your Sinclair,1988)
Sport



International Cricket Manager (Psychaedelic Hedgehog Software,1990) Strategy



International Cricket on Tour - 1 Day (Lambourne Games,1990) Simulation



International Cricket on Tour 2 - 1 Day (Lambourne Games,1991) Simulation



International Cricket on Tour 2 - 3, 4 & 5 Days (Lambourne Games,1991) Simulation



International Cricket on Tour - 3, 4 & 5 Days (Lambourne Games,1990) Simulation



International Events (Anco Software Ltd,1987)
Sport

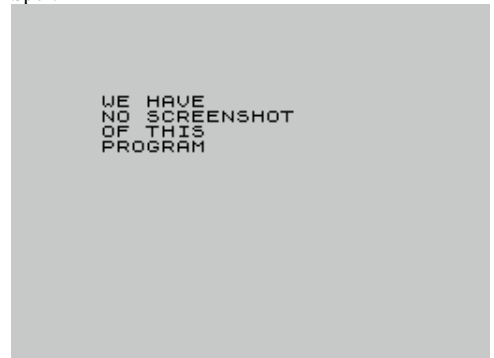

International Football (Cult Games,1989)

International Karate (System 3 Software Ltd,1985)

International Kickboxing (Your Sinclair,1993)



International Manager (D&H Games,1986)

Simulation



International Rugby (Artic Computing Ltd,1985)

Simulation



International Speedway (Silverbird Software Ltd,1988)

Arcade



Interpolacja Newtona (O. Przesmycki,1985)

Utility

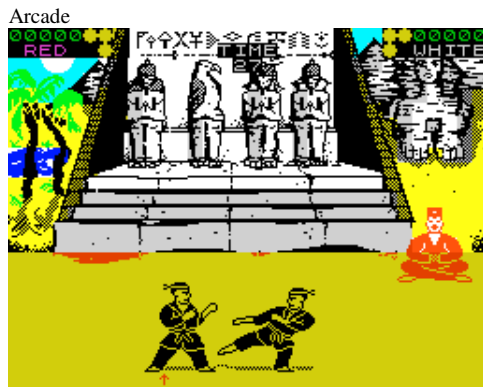
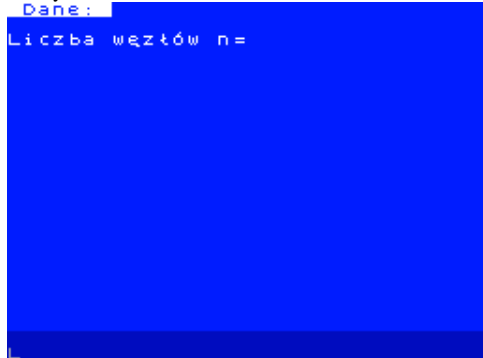

International Match Day (Ocean Software Ltd,1987)

Arcade



International Rugby (Lambourne Games,1992)

Sport



International Tennis (Zeppelin Games Ltd,1992)

Sport



Interrogator, The (Clover Services,1985)

Simulation



Sport

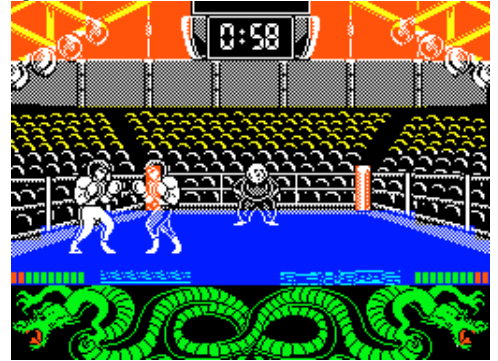

International Ninja Rabbits (Micro Value,1991)

Arcade



International Rugby Simulator (Code Masters Ltd,1988)

Sport



Interpide (ZX-Power,1983)

Arcade



Interrupcion No Enmascarable (MicroHobby,1986)

Utility



Interrupt Driven Clock (Spectrum Computing,1985)
Utility: BASIC Related



Into the Abyss (Mandarin Software,1986)
Text Adventure



Introducing Science Extra - Using Your Computer (BBC Software,) Educational



Intruder (MicroHobby,1985)
Arcade



Invaders (Anestis Koutsoudis,1998)
Scene Demo

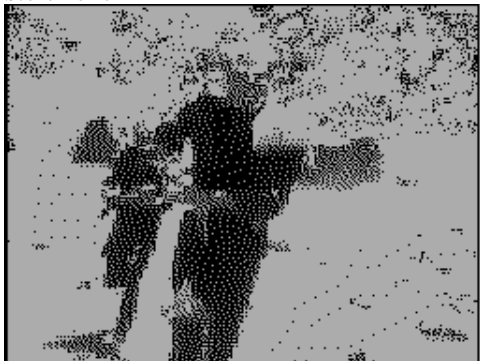

In The Army Now Demo (The Unbelievables,1994)
Scene Demo



Into the Eagle's Nest (Pandora,1987)
Arcade Adventure

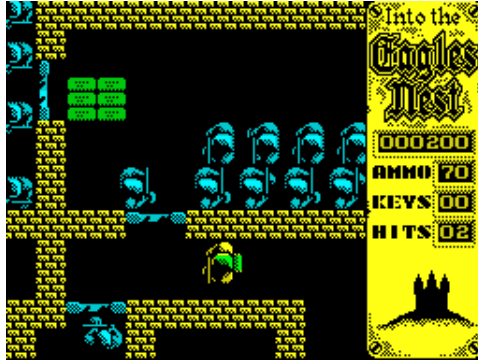

Introduction to Expert Bridge (Bridgemaster,1984)
Board/Card Game



Intruder Alert (Compass Software,1989)
Text Adventure



Invaders (Artic Computing Ltd,1982)
Arcade

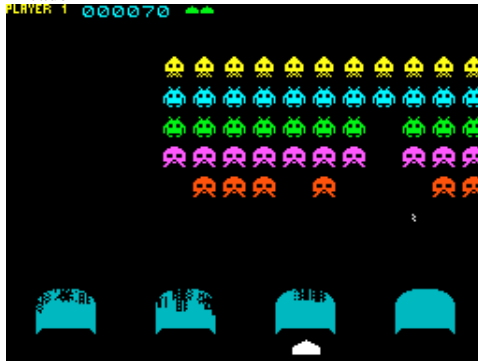

Into Africa (Rack-It,1987)
Arcade Adventure



Into the Mystic (River Software,1991)
Text Adventure

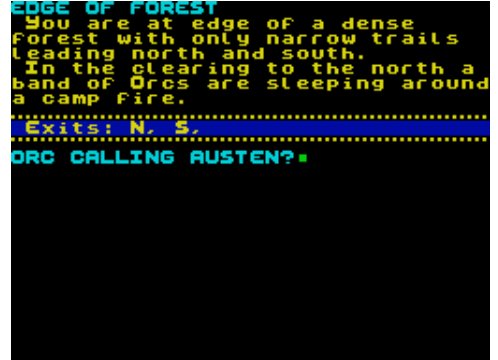

Introduction to Trigonometry (Griffin Software,1984)
Educational

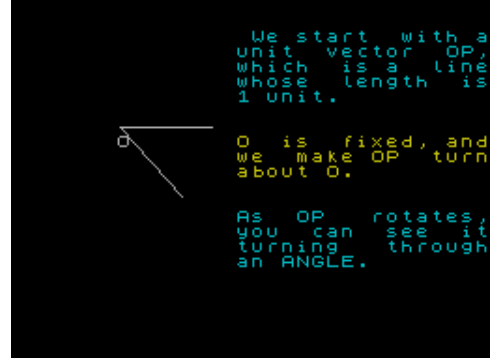

Intruder Alert + Invaders from Planet X (Compass Software,1987) Compilation



Invaders (Design Design Software,1993)
Arcade



Invaders (DK'Tronics Ltd,1983)

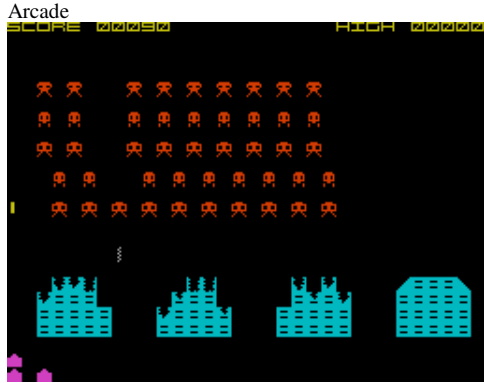

Invaders from Planet X (Compass Software,1991)

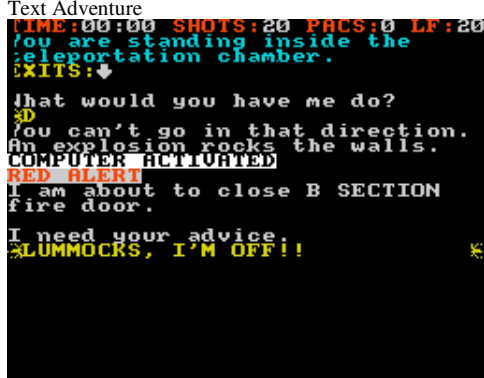

Invasion (Bulldog,1987)

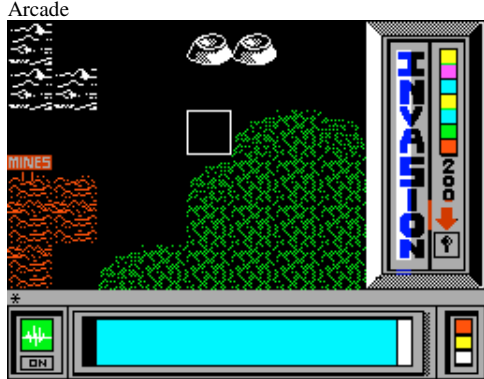

Invasion Force (Artic Computing Ltd,1982)



Invasion from Jupiter (Sinclair Research Ltd,1982)



Invaders (Spectrum Computing,1985)



Invasion (Abbex Electronics,1983)



Invasion (J.K. Greye Enterprises Ltd,1982)



Invasion Force (CCS,1990)



Invasion Galactica (Microparadise Software,1984)



Invaders + Invasion Force (Investronica S.A.,)



Invasion (ASP Software Ltd,1984)

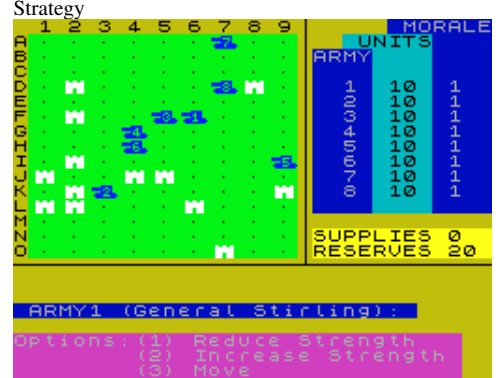

Invasion Amarilla (MicroHobby,1985)

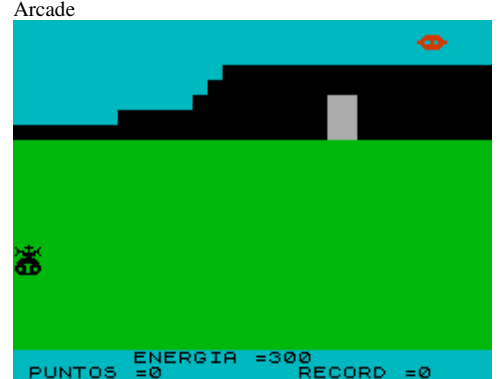

Invasion Force (Micromania,1984)

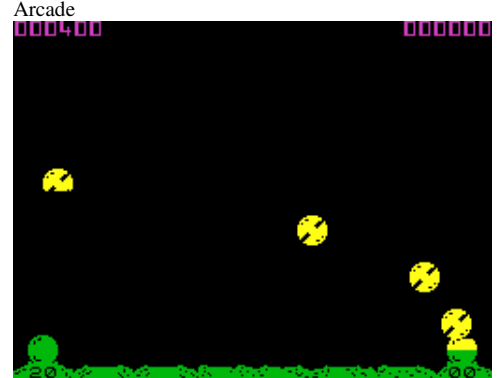

Invasion Luna (Rafael Vico Costa,1989)



Invasion of the Body Snatchas! (Crystal computing,1984) Arcade



Invasores del Espacio + Galaxian (Investronica S.A.) Compilation

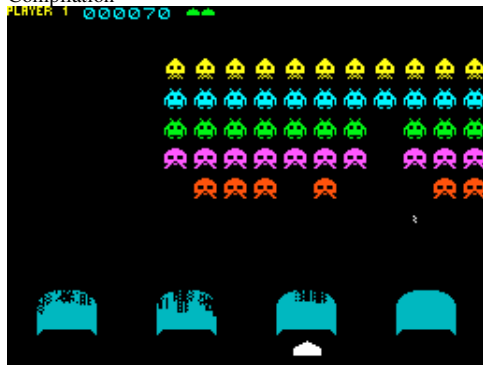

Invertor (The Smart Soft,1992) Board/Card Game



Investment Monitor (Michael Slatford,1987) Utility



Invincible Island hints (.) Cheat

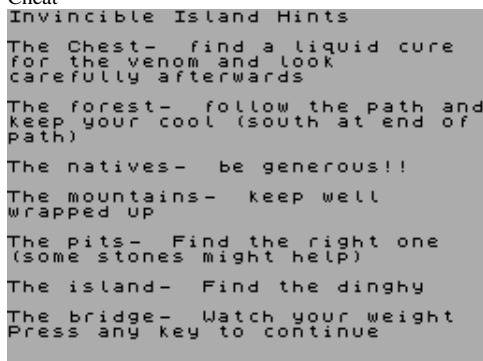

Invasores (Microparadise Software,1984) Arcade

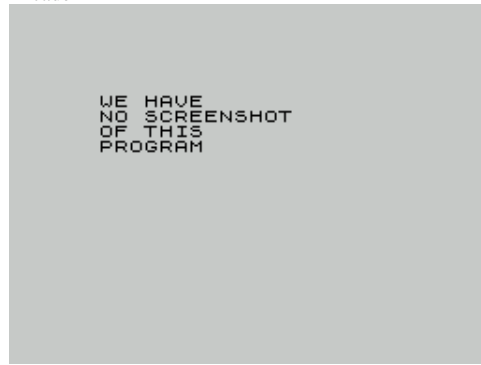

Invasores, Las (MicroHobby,1985) Arcade



Inves Spectrum + Guia de Funcionamiento (Investronica S.A.,1986) Educational



Investronica Lapiz Optico (Investronica S.A.,1985) Utility

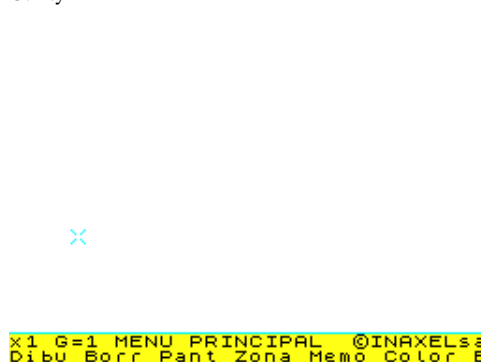

Invisible Invader, The (Sinclair Research Ltd,1982) Arcade



Invasores 16K (Duplinter S.A.,1984) Arcade

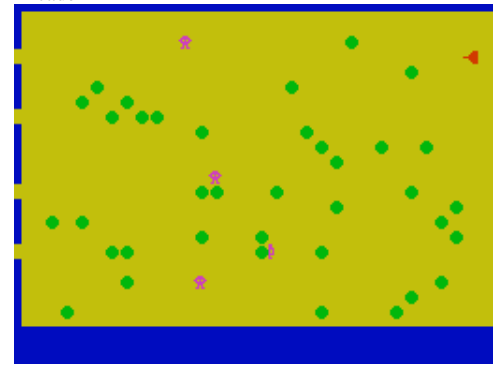

Inventions 1 (Sinclair Research Ltd,1982) Educational

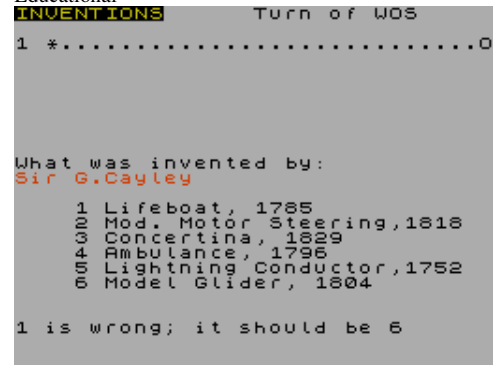

Investigations (Graphtext 128,1987) Text Adventure

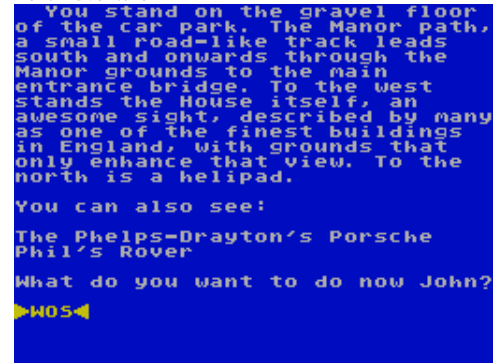

Invincible Island (Richard Shepherd Software Ltd,1983) Text Adventure



Invisible Man, The (Chalksoft Ltd,1983) Educational



Invoicing (Transform Ltd,1983)
Utility

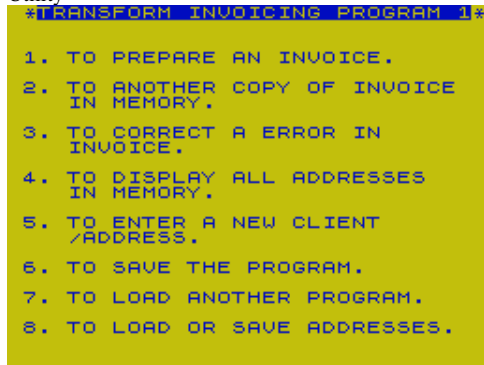

I O U Nothing (Coolguys Ltd.)
Scene Demo



IQ Test (Flowchart Ltd,1982)
Utility



Iron Horse (Konami Ltd.)
Arcade



Iron Maiden (Scandinavian Software Crackers,1989)
Scene Demo



Invoicing + Accounting (Transform Ltd,1984)
Compilation

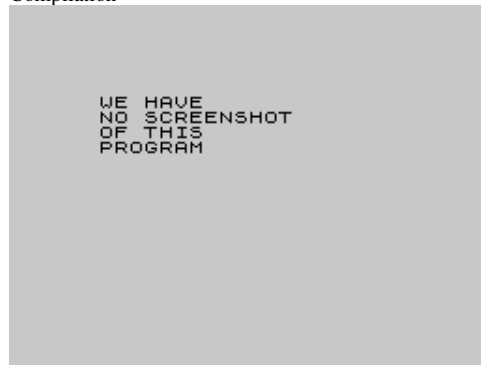

IQ (CRL Group PLC,1987)
Arcade



IQ Test (Zbynka Jenedleho,1985)
Utility

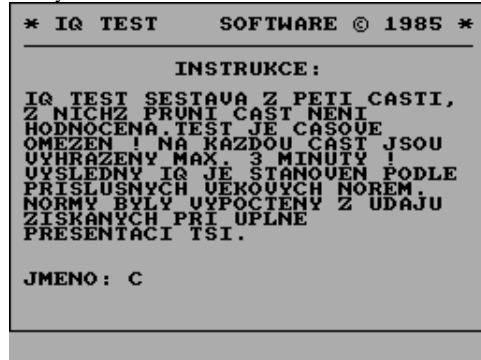

Iron-I (The Unbelievables,1994)
Scene Demo

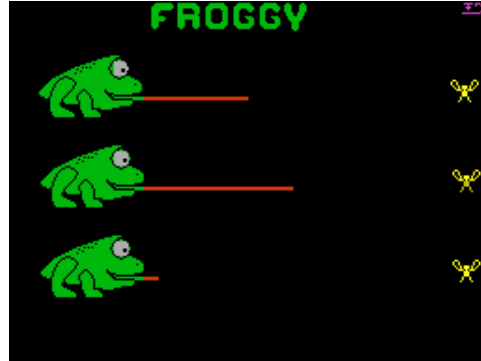

Iron Soldier (Players Premier Software,1989)
Arcade



I, of the Mask (Electric Dreams Software,1985)
Arcade

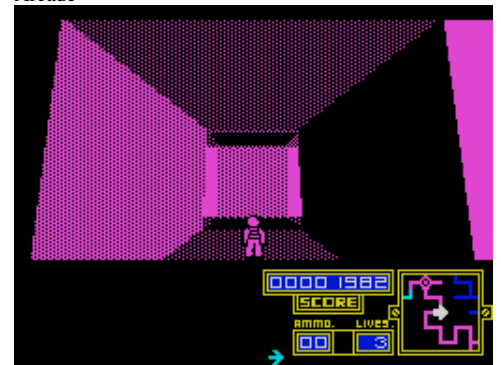

IQ Test (Alfa Soft,1987)
Utility

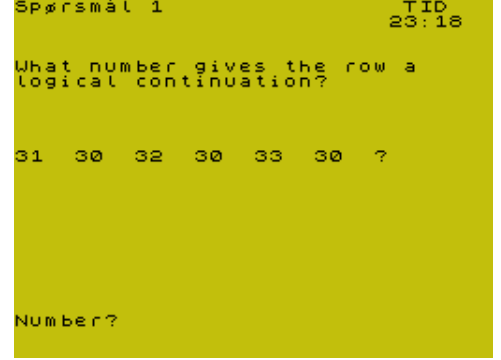

Iron Attack (ZX-Studio,1998)
Strategy

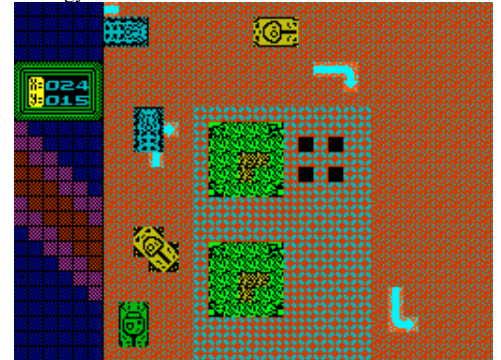

Iron Lord (Ubi Soft Ltd,1989)
Arcade Adventure

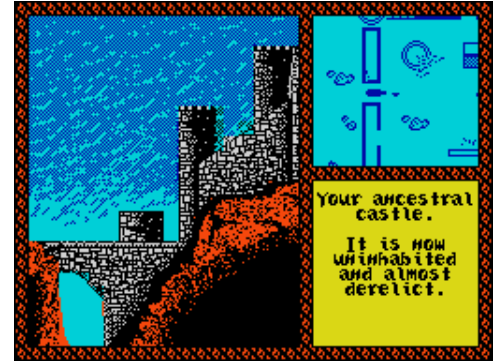

Iron Sphere (Cronosoft,2006)
Arcade

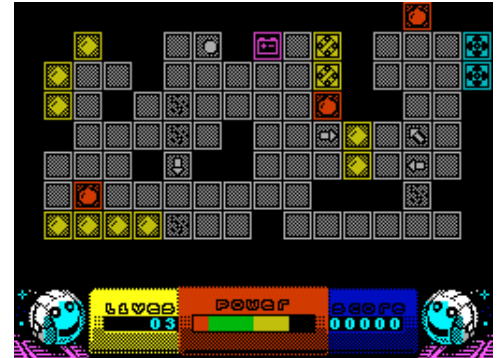

Iron War (MicroHobby,1986)
Arcade

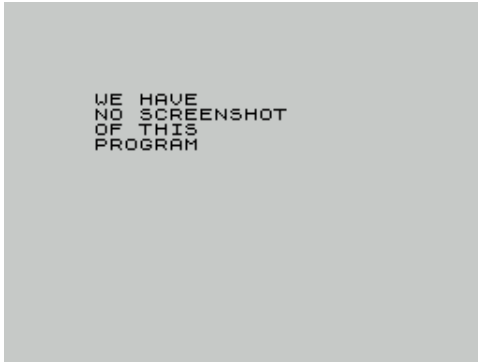

Irrgarten, 3D (J. Falkenberg,1984)
Arcade

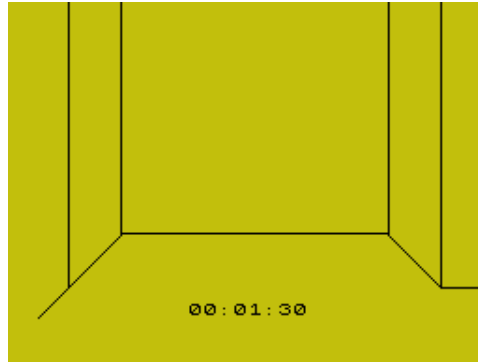

Isla del Tesoro, La (Alfonso P.M./Daniel P.M.)
Text Adventure



Island (,1983)
Arcade

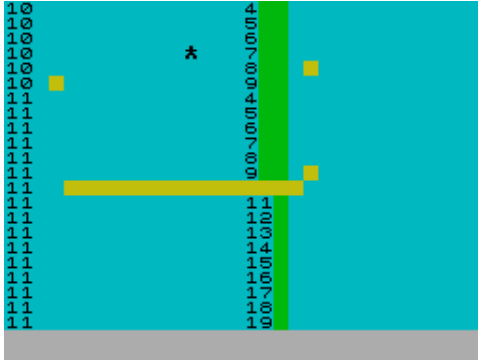

Island of Chaos (The Guild,)
Text Adventure

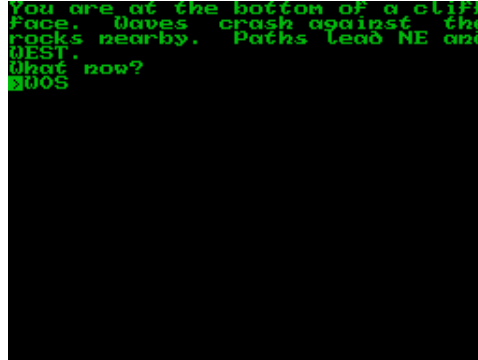

Island of Treasure (S. Rohloff,1985)
Arcade



Islands of Sinbad, The (Zenobi Software,1987)
Text Adventure

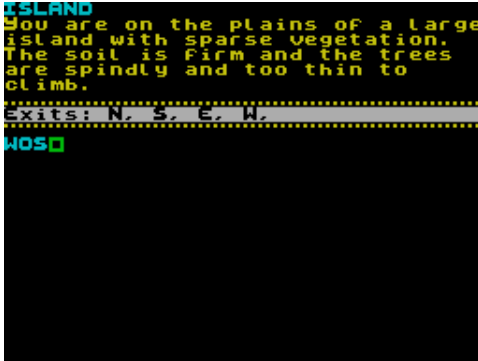

Island, The (Crystal Computing,1984)
Text Adventure

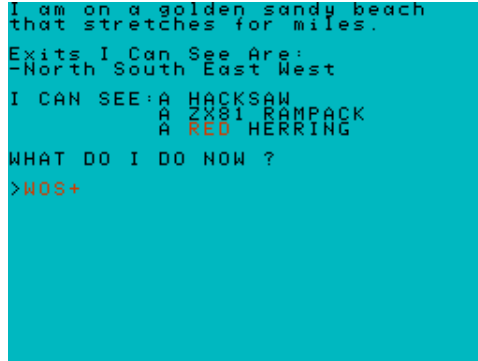

Island, The (Virgin Games Ltd,1983)
Text Adventure

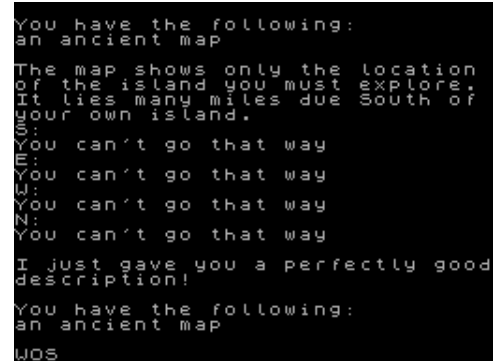

Islets of Langerhans (Amazing Games,1984)
Text Adventure



Iso-Copy (Individual Software,1984)
Utility: Copier



Israeli Team Demo 1, The (The Israeli Team,1989)
Scene Demo

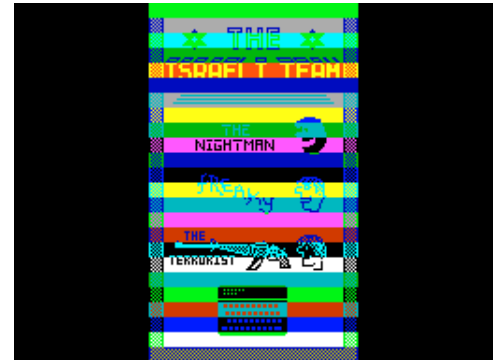

Israeli Team Demo 2, The (The Israeli Team,1989)
Scene Demo



Israeli Team Demo, The (The Israeli Team,1989)
Scene Demo



Italia '90 - World Cup Soccer (Virgin Games Ltd,1989)
Arcade



Italian is Fun (CDS Microsystems,1984)
Educational

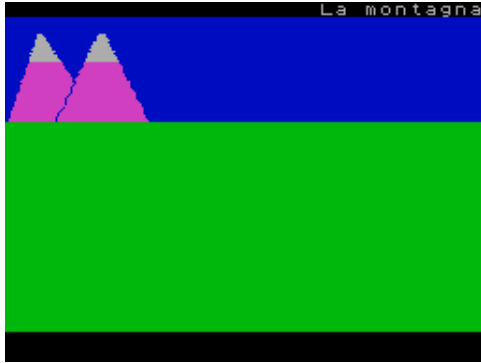

Italy 1990 - Winners Edition (US Gold Ltd,1990)
Sport

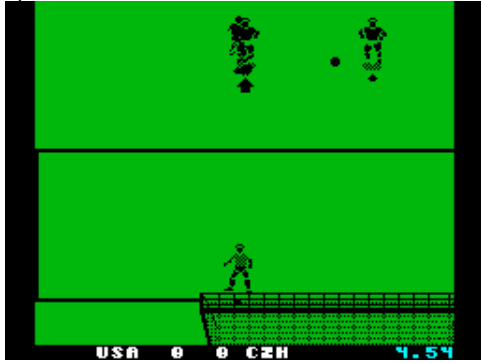

It's Only Rock 'n' Roll (K-Tel Productions,1983)
Simulation



It's the Woolf! (Crystal Computing,1984)
Arcade

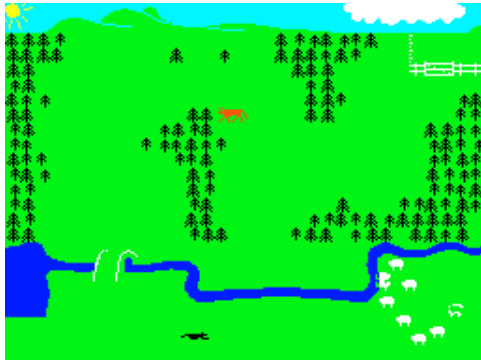

Ivan Stupid (Morozovsk,1997)
Arcade

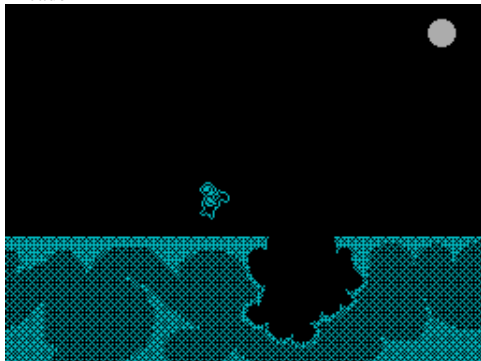

Italian Supercar (Code Masters Ltd,1990)
Arcade



Itasundorious (Hudson Soft,1983)
Arcade



It's Only Rock 'n' Roll + Tomb of Dracula, The (K-Tel Productions,1983) Compilation



It's TV Showtime (Domark Ltd,1991)
Compilation



Ivan Tsarevich (G&M,1995)
Text Adventure

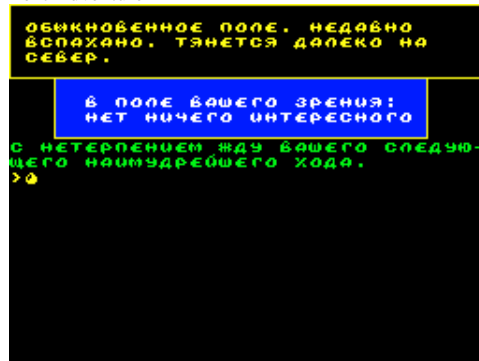

Italy 1990 (US Gold Ltd,1990)
Sport



It's a Knockout (Ocean Software Ltd,1986)
Arcade



It's Raining Bombs (Jaime Tejedor Gomez,2005)
Arcade



Ivan 'Ironman' Stewart's Super Off Road Racer (Virgin Games Ltd,1990) Arcade



I Will Survive! (Aztec Software,1984)
Text Adventure

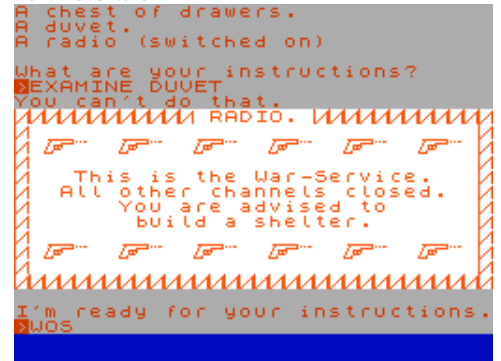

Iwo Jima (PSS,1986)
Strategy



Jabato (Aventuras AD S.A.,1989)
Text Adventure



Jack and the Beanstalk (River Software,1988)
Text Adventure



Jackass (The Devil.)
Board/Card Game

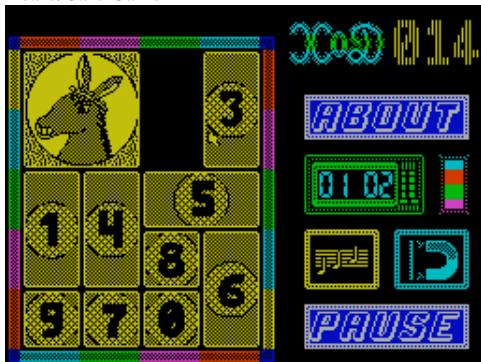

Jack in Magicland (Turtle Software,1985)
Text Adventure

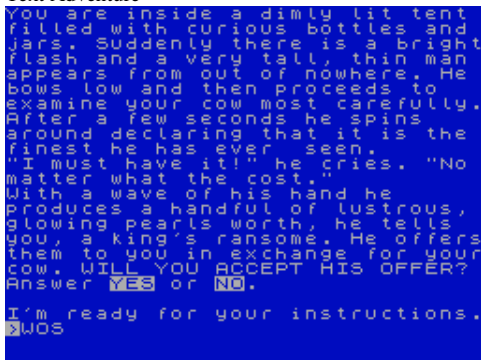

IXL (E-soft/Konczolsoft,1989)
Arcade Adventure

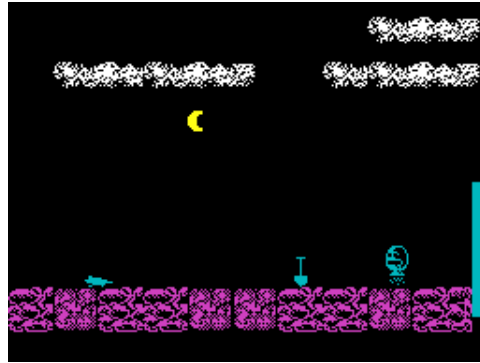

Jackal (Konami Ltd,1986)
Arcade

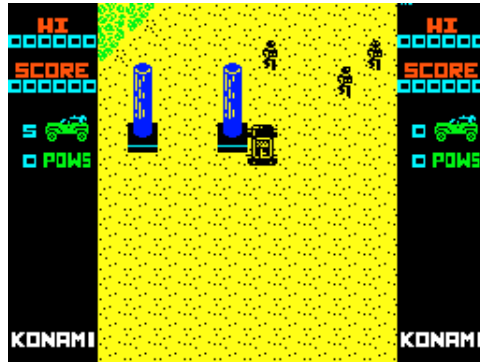

Jack and the Beanstalk (Thor Computer Software,1984)
Arcade



Jack Charlton's Match Fishing (Alligata Software Ltd,1985)
Simulation



Jackpot (CRL Group PLC,1982)
Simulation

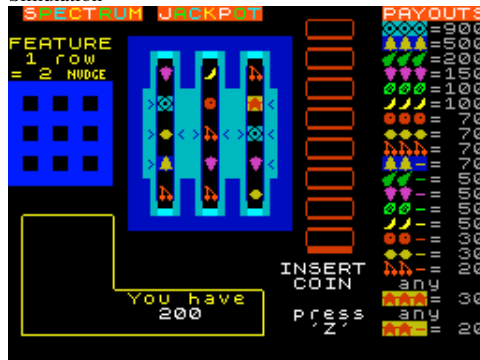

Izzy Wizzy (Cronosoft,2007)
Arcade



Jackals (BKA,1999)
Strategy



Jack and the Pirates (Turtle Software,1986)
Educational



Jack in Crazyland (Turtle Software,1985)
Educational



Jackpot (G. Torregrossa,1983)
Simulation

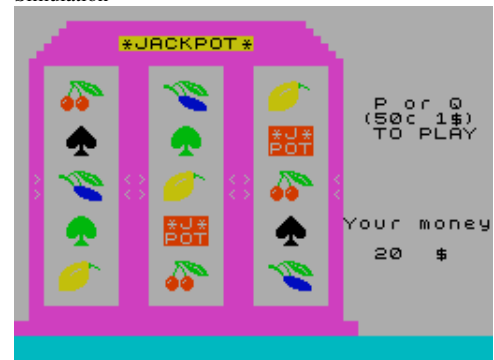

Jackpot (Impact Software [1],1983)
Arcade



Jackpot Fruit Machine (Richard Shepherd Software Ltd,1982)
Arcade



Jack the Nipper (Gremlin Graphics Software Ltd,1986)
Arcade



Jack y el Arco Dorada (Grupo de Trabajo Software S.A.,1987) Arcade



Jade Stone, The (Marlin Games,1987)
Text Adventure



Jackpot (Software of Sweden,1984)
Simulation



Jacksoft Assembler (Outlet Microdrive Magazine,1986)
Utility: Assembler/Disassembler/Monitor

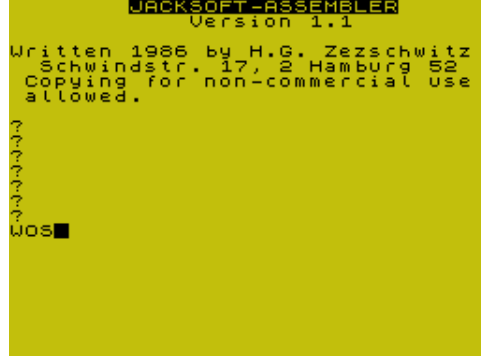

Jack the Nipper II: In Coconut Capers (Gremlin Graphics Software Ltd,1987) Arcade



Jade Necklace, The (River Software,1987)
Text Adventure

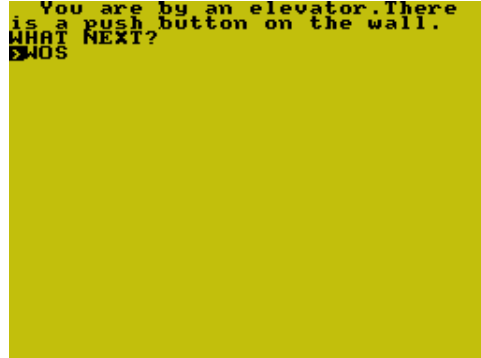

Jagd (Laussoftware,1983)
Arcade

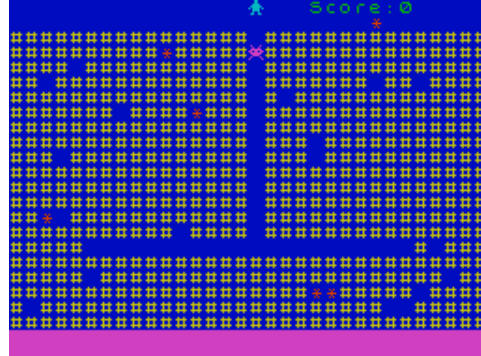

Jackpot + Submarine Attack (Richard Shepherd Software Ltd,1982) Compilation



Jackson City (G.L.L. Software,1990)
Arcade

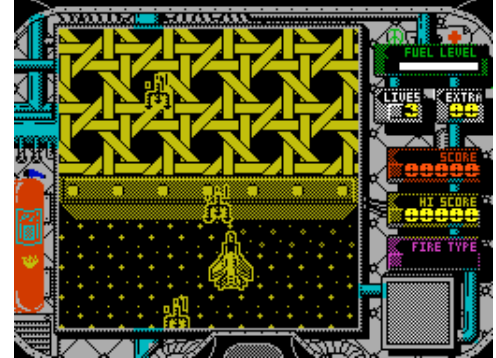

Jack the Ripper (CRL Group PLC,1987)
Text Adventure

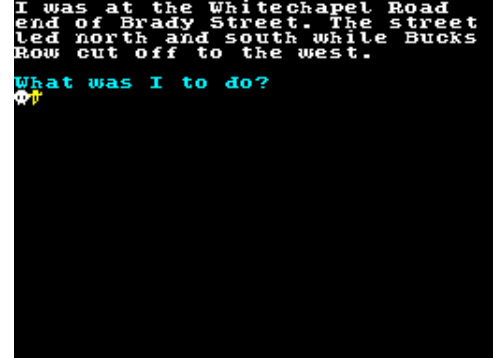

Jade Necklace, The + Lifeboat (River Software,1987)
Compilation

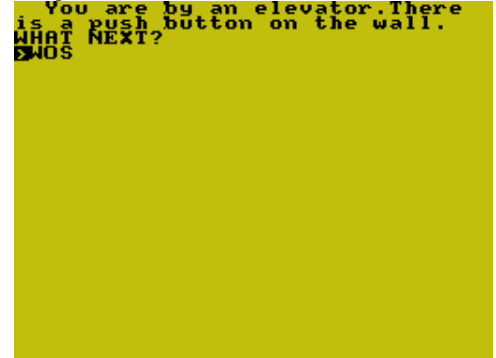

Jahangir Khan's World Championship Squash (Krisalis Software Ltd,1991) Sport

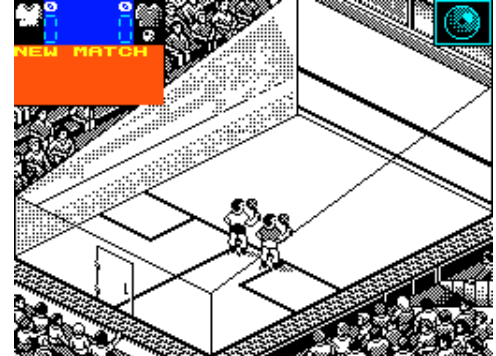

Jai Alai (Opera Soft S.A.,1991)
Sport

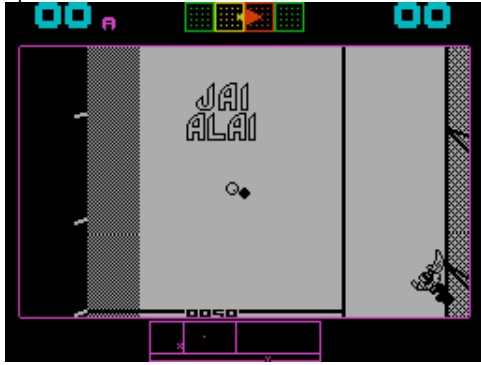

Jakten i Knackebrohult (Xcellent Software,)
Text Adventure



Jam Sandwich (Sinclair Programs,1984)
Arcade

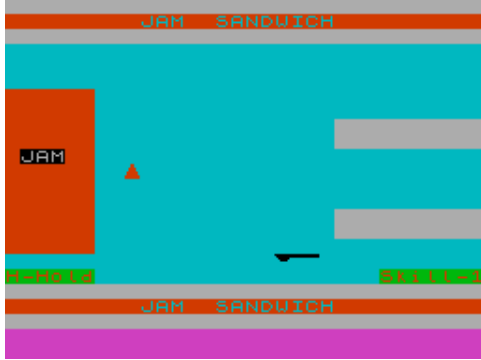

Japanese Contrast (Fenomen,1999)
Board/Card Game

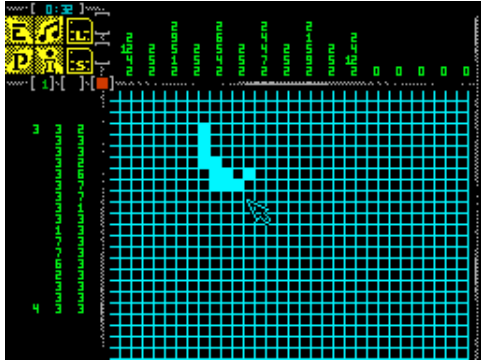

Jarrin' Pick (Alien Software,1992)
Arcade

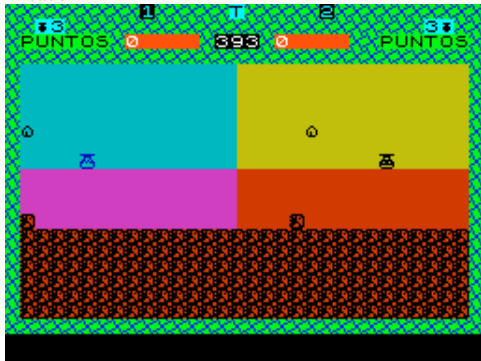

Jail Break (B. Williams,1983)
Arcade

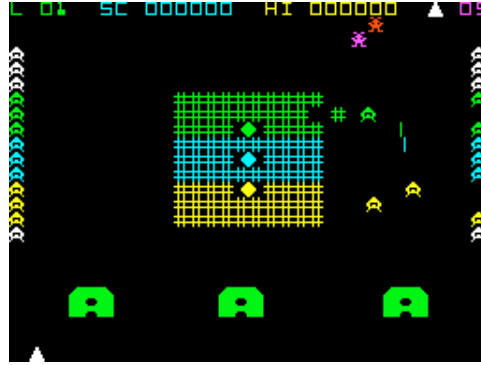

James Bond 007 Action Pack (Domark Ltd,1990)
Compilation



Jangler (Profisoft,1984)
Arcade



Jarama (Hipocrates Soft.)
Arcade



Jason (SOS Ltd,1992)
Text Adventure



Jail Break (Konami Ltd,1987)
Arcade



James Bond 007 Collection, The (Domark Ltd,1991)
Compilation

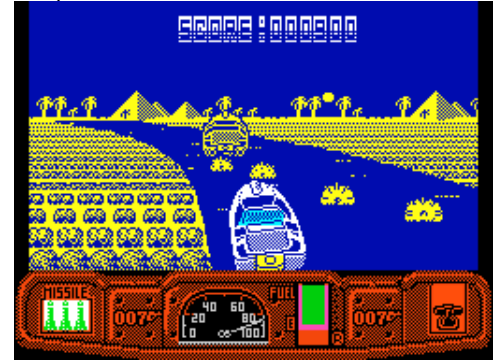

Japan Crossword (Delta Hackers Group,1999)
Board/Card Game



Jarre-Live (TRENSoft,1994)
Scene Demo



Jason and the Golden Fleece (Pocket Money Software,)
Text Adventure

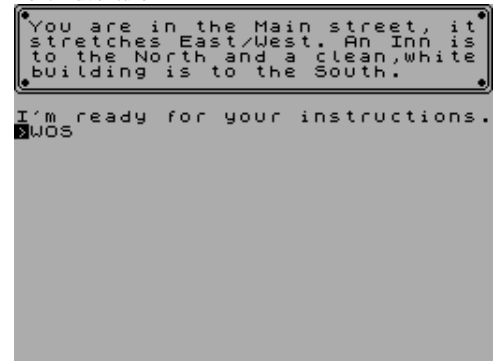

Jason of the Argonauts (The Guild,1990)

Text Adventure

```

You are in a cell of some sort,
the ceiling is only five feet
high, so you must stoop, the
walls are about twelve feet
square, and you can see a trap-
door set into the centre of the
the floor. Also there is a rough
wooden bed in one corner with a
pile of straw serving as a
mattress upon it.
Exits lead:- ???

Your wish.
M05

```

Jaws (Screen 7 Ltd,1989)

Arcade



Jawz (Elfin Software Ltd,1983)

Arcade



Jenny's Big Disk Vol 1 (Zenobi Software,)

Compilation

```

You are in the main street of
Ibira. About you are many little
shops, an hotel and a general
store. Far to the west you can
see the volcano protruding out
of the Aegean; and the rest of
the atoll-shaped island wrapped
around it. There is a sharply
zig-zagging path going down the
mountain, with a pole next to it.
Paths go North, South, East

**

```

Jenny's Next Big Disk Vol 2 (Zenobi Software,)

Compilation

```

You are on board a small boat.
It has reached its terminus, and
you are invited to disembark.
Exit is out
You see:
A boatman

**

```

Jason's Gem (Mastertronic Ltd,1985)

Arcade

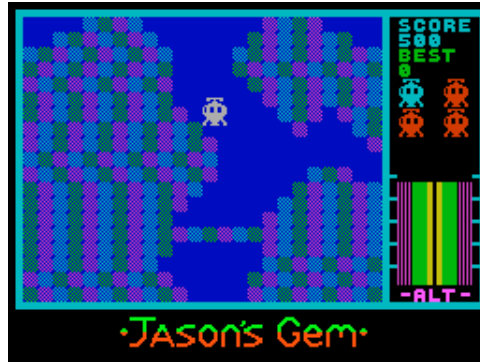

Jaws (Sinclair User,1984)

Arcade



Jellymen (Sinclair Programs,1983)

Arcade



Jenny's Big Disk Vol 2 (Zenobi Software,)

Compilation

```

You are standing in the main
street of the tiny Inca Village.
The only vague hint of the 20th
century, is the Helicopter Pad
to your west - your only means
of transportation. Except for
the few small buildings, which
try dolefully to pass themselves
off as commercial necessities,
and a fountain in the middle of
the road, you are aware of the
jungle all around you.
You can go North, South, West, East

**

```

Jeremy (King Software,1984)

Educational

```

I HAVE JUST THOUGHT OF A
NUMBER BETWEEN 1 AND 100.

TRY TO GUESS IT???
```

Guesses=0

Jasper! (Micromega,1984)

Arcade



Jaws Revenge (Work Force,1983)

Arcade

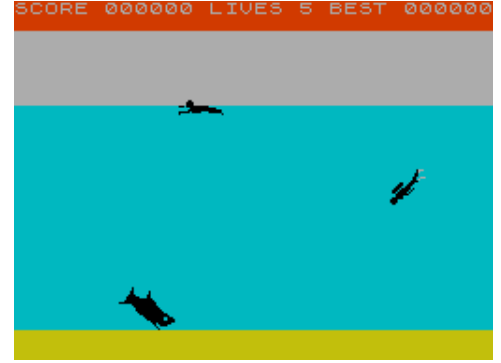

Jennifer's Dolly (Sinclair User,1985)

Text Adventure

```

YOU ARE BY SOME RED BRICKED
HOUSES, NEAR A PARK. YOU CAN SEE
THE RIVER SOME DISTANCE OFF, AND
YOU CAN HEAR THE BIRDS CHIRPING
IN SOME TREES.
AN UMBRELLA IS HERE
POSSIBLE ROUTES ARE: -
    EAST
    SOUTH

WHAT NOW? WOSC

```

Jenny's Next Big Disk Vol 1 (Zenobi Software,)

Compilation

```

You are at a bus-stop. A notice
informs you that an industrial
dispute has around the service
to a halt. Advertising posters
adorn the walls of the shelter.
A path leads east

YOU CAN SEE: -
A poster
A roll of mint humbugs
A sheet of paper

*WOS*

```

Jericho 2 (Elephant Software,1984)

Strategy

```

Day 2 of the siege of JERICHO

YOU HAVE          UNASSIGNED
-----
0000 MEN          300
0000 BALLISTA
0000 CART        5
0000 LADDER
0000 LATTERING RAM
0000 SIEGE TOWER
0000 RATION
0000 AMMUNITION UNITS

It takes 10 men to man each
BALLISTA

How many men do you assign to
this 'C'

```

Jericho Road (Shards Software,1984)

Text Adventure

```

You are by a fortress
You see a small hill
to the west
and a large pool to the east

Obvious routes are
North,East or South

What do you want to do now ?
WOSC

```

Jersey Quest (WD Software,1984)

Text Adventure

```

You are at the ENTRANCE of the
UNDERGROUND HOSPITAL. A shiver
runs up your spine as you think
of the prisoners who died in the
digging of the tunnels. A wide
tunnel leads W and NORTH.

I can also see:-
A bottle of beer
You have scored 0%.

Now what ?
WOS

```

Jester's Jaunt (Zenobi Software,1991)

Text Adventure

```

The changing room, with large
wardrobes containing hundreds of
dresses.
Exits N E W

WOS

```

Jet Bike Simulator (Code Masters Ltd,1988)

Arcade



Jetpac (Ultimate Play The Game,1983)

Arcade



Jeroen (.)

Educational

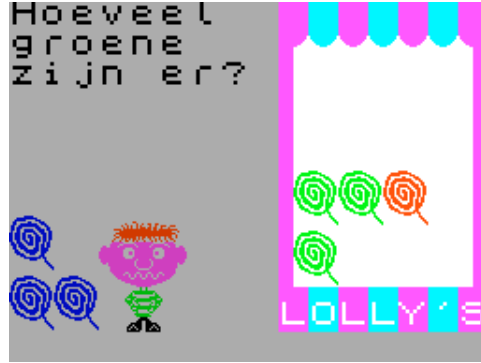

Jerusalem (The Yolpa Brothers,1996)

Scene Demo



Jesus Gil, Heroe Nacional (3P Soft,1990)

Text Adventure

```

¡Doooh...! Has arriado al Fondo
SUR. Miles de frenteatléticos
gritan con desesperación. Un
niño de seis años da vueltas en
el aire; a su lado don Jorge te
mira. Queda un solo banco. El
público llega al campo. Salidas
visibles: Este Oeste
AD-WOS$

```

Jetman 2 (Your Spectrum,1985)

Arcade



Jet Set Basic (Purple Studios,2006)

Arcade



Jerrybuilder (Ron Ridge,1984)

Simulation

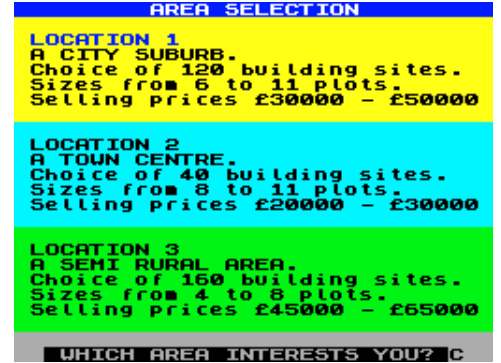

Jester Quest (Nebula Design Software,1988)

Text Adventure

```

Jeremy also saw...
an old SIGN.

Well?...
<READ> SIGN
The sign read,

Ye Olde Jobbe Centre.
*****
Abandon hope all ye who enter
here fore ye shall ne'er leave
*****

What now?...
WOS

```

Jesus On-E's (Technium 220,1996)

Scene Demo



Jet-Man Silly (Proxima Software,1993)

Arcade



Jet Set Editor (Spectrum Electronics,1984)

Arcade Game Development Tool



Jetset-Freddy (Bernd Schissler,1984)
Text Adventure

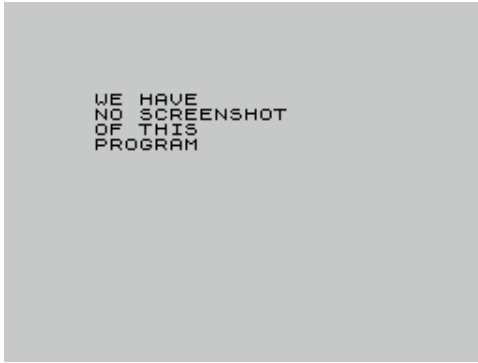

Jet Set Gertie (Spectrum Computing,1985)
Arcade



Jet Set Spidery (Spidersoft,1986)
Arcade



Jet Set Willy (R.D. Foord Software,1985)
Arcade



Jet Set Willy (Software Projects Ltd,1984)
Arcade



Jet Set Willy: A Bulgarian Requiem (Adban de Corcy,2000)
Arcade



Jet Set Willy: (again) (Filsoft,2005)
Arcade



Jet Set Willy: April Showers (Your Spectrum,1984)
Arcade

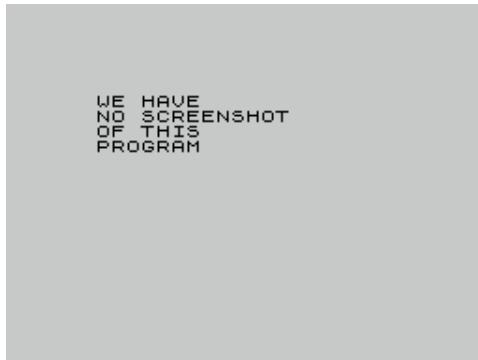

Jet Set Willy: Bizarre (.)
Arcade



Jet Set Willy: DefRoom (Jonathan Graham Harston,2003)

Arcade Game Development Tool

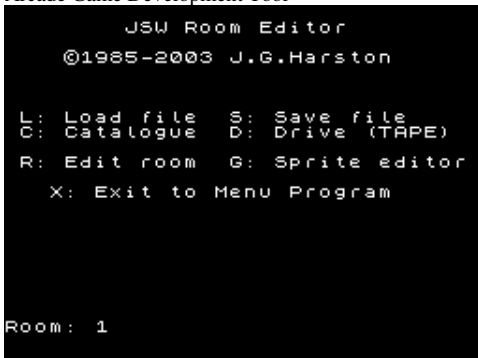

Jet Set Willy: Dr. Jet Set Willy (R.D. Foord Software,1986) Arcade



Jet Set Willy: Dr. Jet Set Willy Microdrive Tape (R.D. Foord Software,1986) Arcade Game Development Tool



Jet Set Willy: Dup Moor en T' Panat (Nick Aldridge,2002) Arcade



Jet Set Willy: Escape of the Snails (Herve Ast,2006)
Arcade



Jet Set Willy: Fantasy World Willy (BaSe1 PrOdUcTiOnZ,2002) Arcade



Jet Set Willy: Froस्या the Cat (Igor Makovsky,2002)

Arcade



Jet Set Willy: Ivy (Filsoft,1998)

Arcade



Jet Set Willy: Jet Set Emily: Baby on the Go (Doctor Who,2002) Arcade



Jet Set Willy: Jet-Set Willy in Space (Halsoft,1997)

Arcade



Jet Set Willy: Lord of the Rings (Broadsoft,2000)

Arcade



Jet Set Willy: FTB (Edward Martland,2003)

Arcade



Jet Set Willy: J4 - The Fourth Remix (Geoff Eddy,1999)

Arcade



Jet Set Willy: Jet Set Wibble (John Elliott,2005)

Arcade



Jet Set Willy: Join the Jet-Set (Halsoft,1985)

Arcade

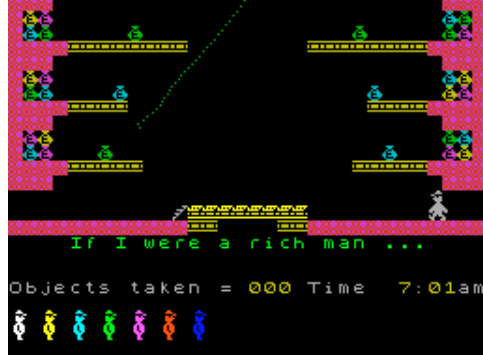

Jet Set Willy: Madam Blavskja's Carnival Macabre (Adban de Corcy,2002) Arcade



Jet Set Willy: Goodnite Luddite (Broadsoft,2002)

Arcade



Jet Set Willy: Jet Cat Froस्या (Igor Makovsky,2004)

Arcade



Jet Set Willy: Jet Set Willy in Paris (Herve Ast,2005)

Arcade



Jet Set Willy: Lena vs. Margo (Igor Makovsky,2006)

Arcade



Jet Set Willy: Manic Miner (Broadsoft,2004)

Arcade



Jet Set Willy: Manic Mining Robot's Day Out (.)
Arcade

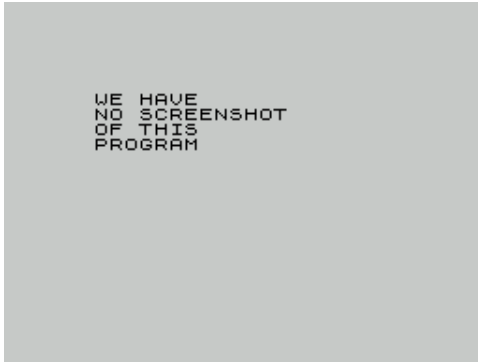

Jet Set Willy: Maria on Tour (BaSe1
PrOdUcTiOnZ,2005)
Arcade

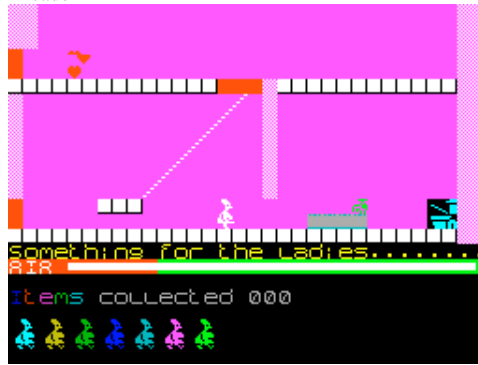

Jet Set Willy: Maria's Revenge (Mat Doughty,2004)
Arcade



Jet Set Willy: Maria vs. Some Bastards (Manic Miner
Technologies,2001) Arcade



Jet Set Willy: Mind Control (Daniel Gromann,2005)
Arcade



Jet Set Willy: Mono (John Elliott.)
Arcade



Jet Set Willy: Monstrum! (Stuart J. Hill,2000)
Arcade



Jet Set Willy: Mr Top Hat (Nick Aldridge,2003)
Arcade



Jet Set Willy: Party Willy (Broadsoft,2004)
Compilation



Jet Set Willy: Perpetual Motion (Darth Melkor,2005)
Arcade



Jet Set Willy: Skint Willy (BaSe1 PrOdUcTiOnZ,2002)
Arcade



Jet Set Willy: Soul Miner (Edward Martland,2002)
Arcade



Jet Set Willy: Spaceman Willy (Leslie Marwick,1985)
Arcade

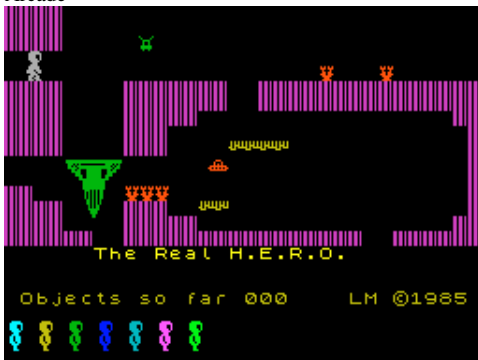

Jet Set Willy: Spectrum Computing (Spectrum
Computing,1984) Arcade



Jet Set Willy: Still Stealin' (BaSe1
PrOdUcTiOnZ,2002)
Arcade



Jet Set Willy: Strangel (Sendy,2001)
Arcade

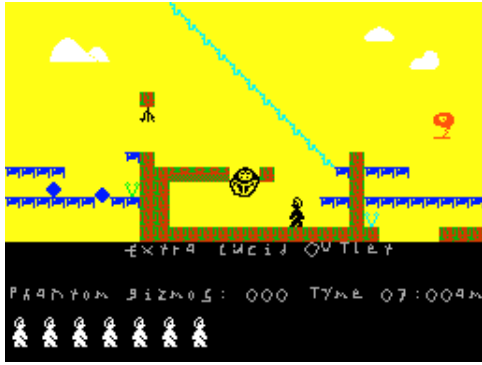

Jet Set Willy: Stupid (Nick Aldridge,2001)
Arcade



Jet Set Willy: The 2005 Megamix (Daniel Gromann,2005)
Arcade



Jet Set Willy: The '96 Remix (Paul Howard,1996)
Arcade



Jet Set Willy: The Colossal Cave (James Wyatt,2000)
Arcade



Jet Set Willy: The Continuing Adventures (Adam Britton,1998) Arcade



Jet Set Willy: The Deadly Mission (Adam Britton,1985)
Arcade



Jet Set Willy: The DrUnKeN mAsTeR!!! (BaSel PRoDUcTiOnZ,2002) Arcade



Jet Set Willy: The Fucked Internet Trilogy (,) Arcade



Jet Set Willy: The Sun Is No Longer Producing Heat (Nick Aldridge,2002) Arcade



Jet Set Willy: The Time Hole (Edward Martland,1999) Arcade



Jet Set Willy: The Utility Cubicles (Stuart J. Hill,2000) Arcade

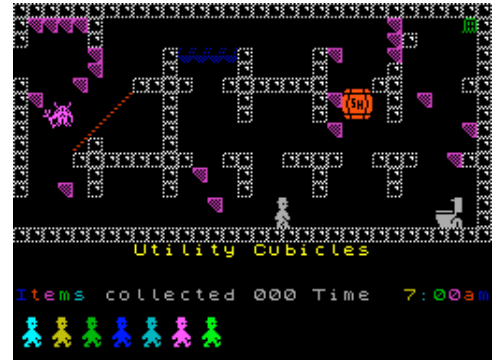

Jet Set Willy: We Pretty (Broadsoft,1999) Arcade



Jet Set Willy: Wet Sunday Afternoon Graphical Remix (Darren McCowan,2001) Arcade



Jet Set Willy: Where's Woody? (Sendy,2000) Arcade



Jet Set Willy: Willy Comes Home (Gawp!,2000)
Arcade



Jet Set Willy: Willy's Hoard (Daniel Gromann,2006)
Arcade



Jet Set Willy: Willy's New Mansion (Daniel Gromann,2004)
Arcade



Jet Set Willy: Willy the Rogue (BaSe1 PrOdUcTiOnZ,2002)
Arcade



Jet Set Willy: ylliW teS teJ (Broadsoft,2004)
Arcade



Jet Set Willy: Willy's Afterlife (Adban de Corcy,2000)
Arcade



Jet Set Willy: Willy's Holiday (Adam Britton,1985)
Arcade



Jet Set Willy: Willy Takes a Trip (Geoff Eddy,2000)
Arcade



Jet Set Willy: Willy to the Rescue! (Sentry,2000)
Arcade



Jet Set Willy: ZX Willy the Bug Slayer (Geoff Eddy,2002)
Arcade



Jet Set Willy: Willy's Flashback (JET_VISY,2001)
Arcade



Jet Set Willy: Willy's New Hat (,1985)
Arcade



Jet Set Willy: Willy the Hacker (Geoff Eddy,1999)
Arcade



Jet Set Willy: Willy vs. the Vampire Lord (Lee Tatlock,2001) Arcade



Jet Set Willy 1-1 (Nick Aldridge,2000)
Arcade



Jet Set Willy 128K (John Elliott,1996)

Arcade



Jet Set Willy 64: Dragon (John Elliott,2006)

Arcade



Jet Set Willy 64: Ultimate Manic Miner (Igor Makovsky,2006)

Arcade



Jet Set Willy Editor (.)

Arcade Game Development Tool



Jet Set Willy Editor Mk2 (Softricks,1984)

Arcade Game Development Tool



Jet Set Willy 5: The ZX Heroes (Igor Makovsky,2002)

Arcade



Jet Set Willy 64: Manic Miner (John Elliott,2005)

Arcade



Jet Set Willy 64: Willy on a Transatlantic Cruise (Herve Ast,2006)

Arcade



Jet Set Willy Editor (Richard Swann,1993)

Arcade Game Development Tool



Jet Set Willy II: The Final Frontier (Software Projects Ltd,1985)

Arcade



Jet Set Willy 64 (John Elliott,2005)

Arcade



Jet Set Willy 64: Manic Miner - Dragon (John Elliott,2006)

Arcade



Jet Set Willy Construction Kit (Broadsoft,2003)

Arcade Game Development Tool



Jet Set Willy Editor (Spectrum Computing,1985)

Arcade Game Development Tool

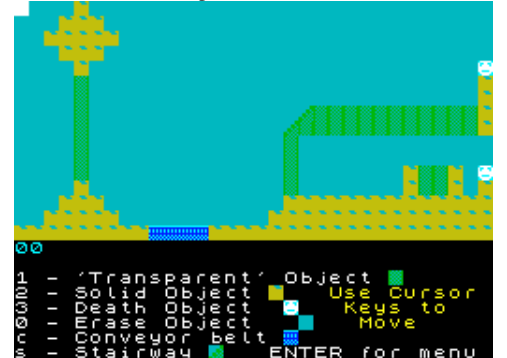

Jet Set Willy III (MB/APG Software,1985)

Arcade



Jet Set Willy Room Designer (R.D. Foord Software,1985)

Arcade Game Development Tool



Jet-Story (Ultrasoft,1992)

Arcade

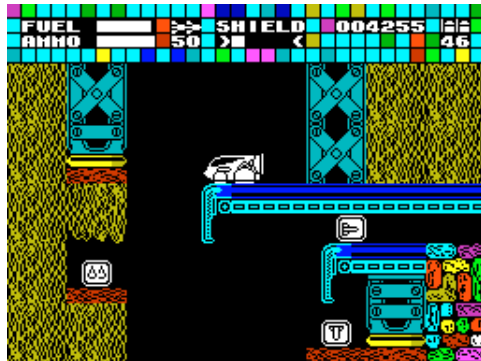

Jewel of Scotland (.)

Text Adventure



Jewels of Honour, The (Fantasy Leagues,1990)

Text Adventure

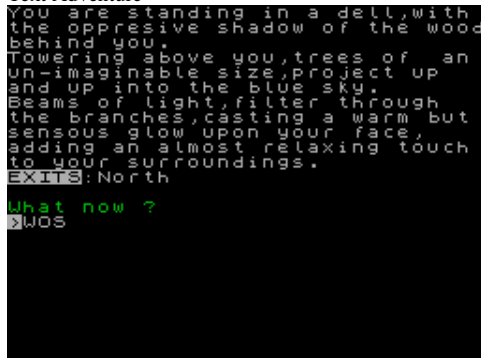

Jigsaw (Artic Computing Ltd,1983)

Board/Card Game



Jet Set Willy Sprite Library (R.D. Foord Software,1985)

Arcade Game Development Tool



Jewel of Power, The (Slogger Software,1985)

Text Adventure



Jewels of Babylon, The (Interceptor Micros Software,1985)

Text Adventure

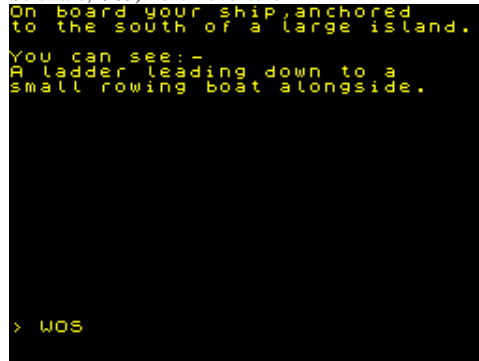

Jhony Vayna (Pedro Amador Lopez,1989)

Text Adventure



Jimmy's Soccer Manager (Beyond Belief,1991)

Simulation



Jetsons, The (Hi-Tec Software Ltd,1992)

Arcade



Jewel of Prophecy (Psychaedelic Hedgehog Software,1991)

Text Adventure



Jewels of Darkness (Rainbird Software Ltd,1986)

Compilation

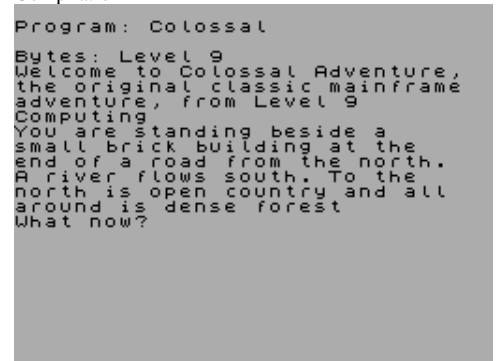

Jhothamia 6 (The Guild,1987)

Text Adventure

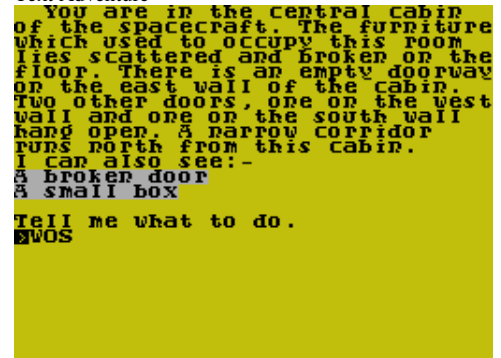

Jimmy's Super League (Beyond Belief,1992)

Simulation



Jinxter (Rainbird Software Ltd,1988)

Text Adventure

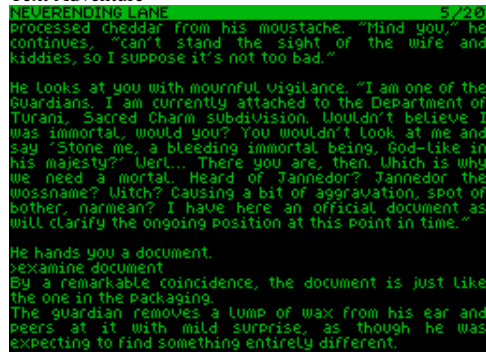

Jock and the Time Rings (Atlantis Software Ltd,1985)

Arcade



Jocurile Lui Cipi (SuperSoft [2],1999)

Scene Demo



Joe Blade III (Players Premier Software,1989)

Arcade



Joffe Plan, The (Mirrorsoft Ltd,1985)

Utility



Jmeno Ruze (Proxima Software,1991)

Arcade Adventure



Jocky Wilson's Compendium of Darts (Zeppelin Games Ltd,1991)

Sport

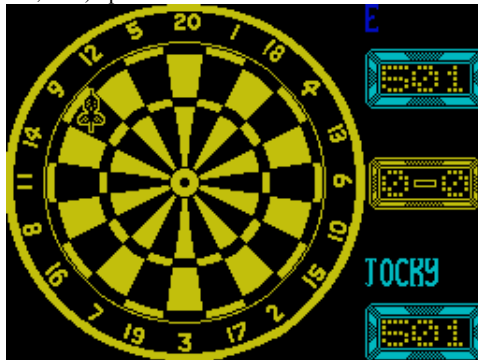

Joe Blade (Players Software,1987)

Arcade

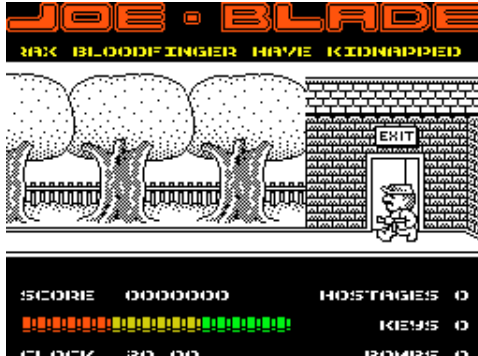

Joe Blade IV (Players Premier Software,)

Arcade



Jogger (Savern Software,1984)

Arcade



Jock and the Beanstalk (Armadillo Soft,1986)

Text Adventure



Jocky Wilson's Darts Challenge (Zeppelin Games Ltd,1989)

Sport

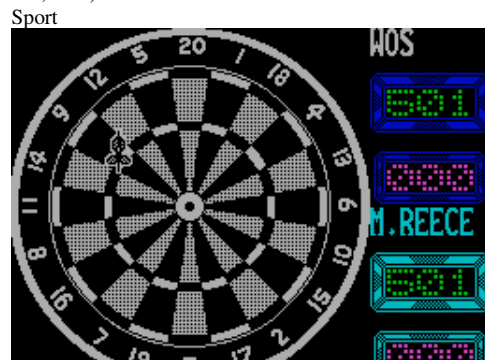

Joe Blade II (Players Software,1988)

Arcade



Joe's Drink Stand (.)

Arcade

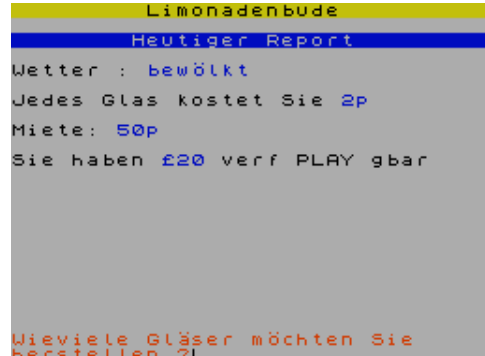

Joggers Diary (L. Chantler,1983)

Sport

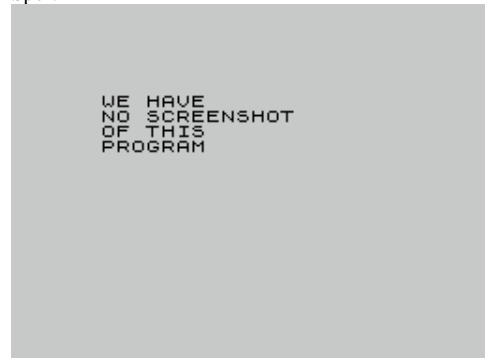

John Brown (ONIKLE,1986)
Utility

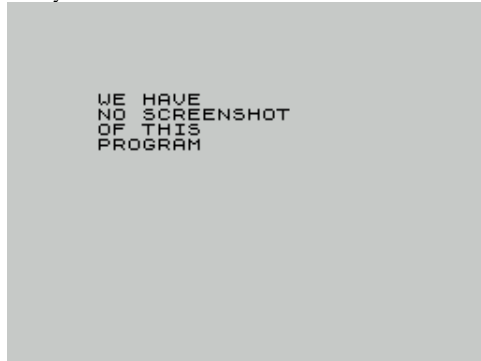

Johnny M (G.H. Suggitt,)
Text Adventure

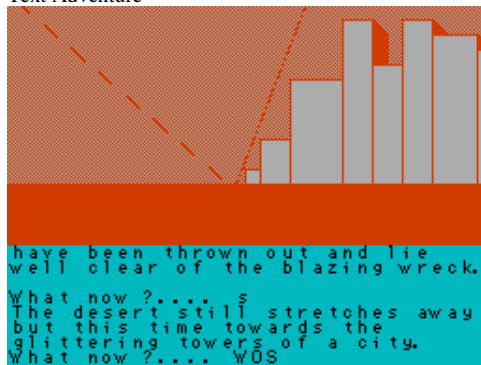

Johny Melabo (Whalkira Software,1987)
Text Adventure



Jolly Duplicator (Cobra Computer Software,1987)
Text Adventure

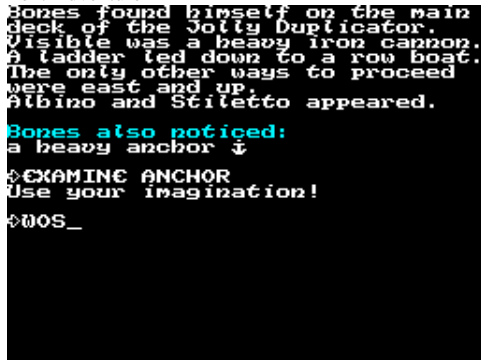

Jolly Roger (Rabbit Software Ltd.)
Arcade Adventure



John Caig Sailboat Racing (JCS ZX Software,1984)
Simulation

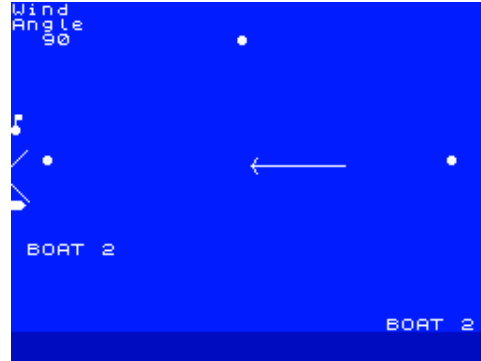

Johnny Reb (MC Lothlorien Ltd,1983)
Strategy



Joker (Flowchart Ltd,1982)
Simulation



Jolly Jack's Run Ashore (Harbour Soft,1984)
Text Adventure

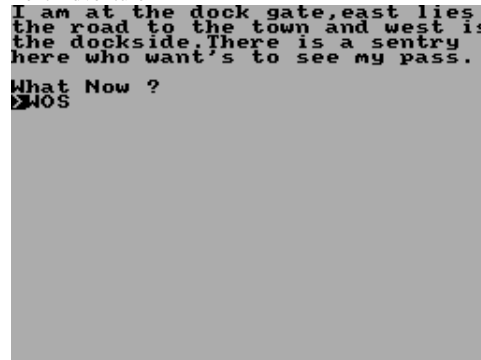

Jolly Roger (Video Vault Ltd,1984)
Arcade Adventure



Johnnie Verso (Wazertown Works,1991)
Text Adventure



Johnny Reb II (MC Lothlorien Ltd,1986)
Strategy

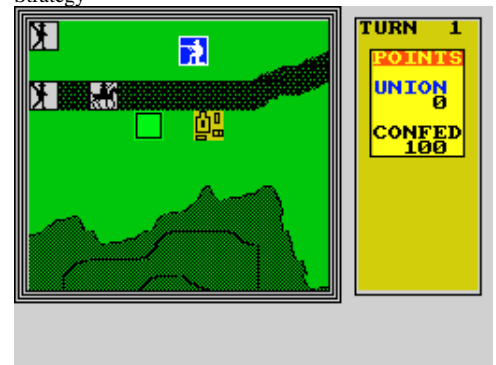

Jokers Wild (Phoenix Software,1984)
Arcade

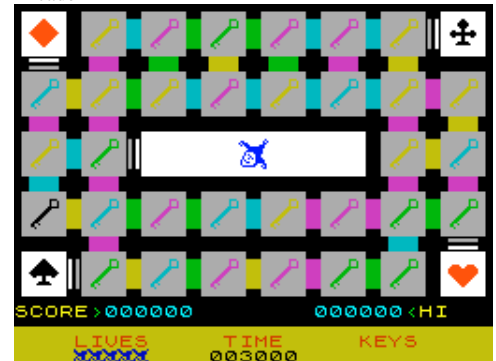

Jolly Lines (Jolly Mouse Ltd,1995)
Board/Card Game



Jonah Barrington's Squash (New Generation Software,1985)
Sport

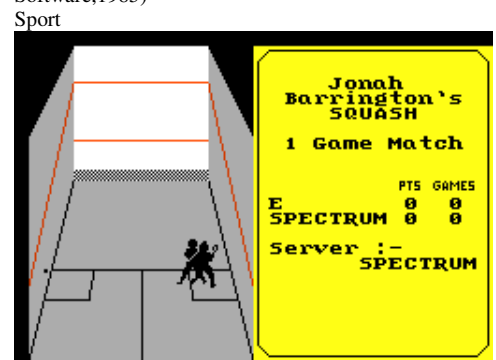

Jongleur (.)
Arcade



Journey into Danger (Sinclair Research Ltd,1982)
Arcade



Journey, The (Temptation Software,1985)
Text Adventure

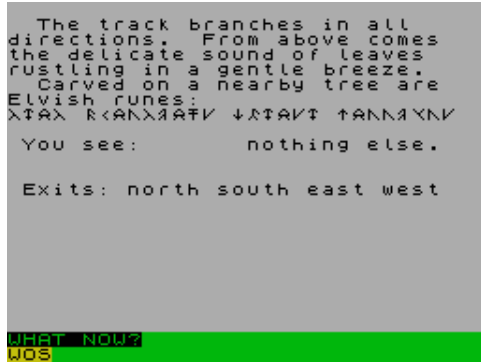

Journey to the Centre of the Earth (Carl Wilson,2005)
Text Adventure

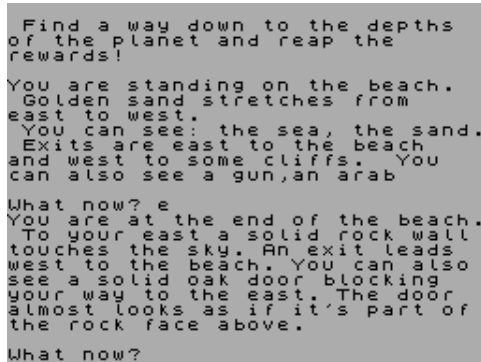

Joy Graph (Ltd,1985)
Utility: Drawing



Jonny Quest (Hi-Tec Software Ltd,1991)
Arcade Adventure



Journey One Spring, A (Isolated House,1988)
Text Adventure



Journey to Death (The Guild,1992)
Text Adventure

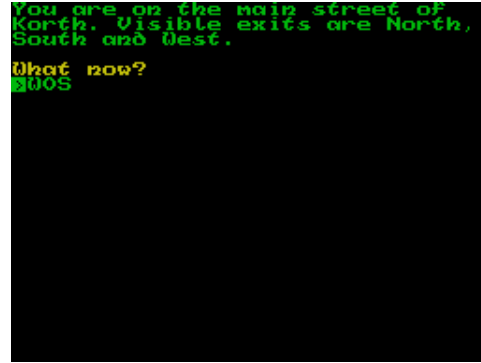

Joust (Softek Software International Ltd,1983)
Arcade



Joystick Adaptor (MI-Soft,1983)
Utility



Jon the Jany (Your Computer,1985)
Arcade

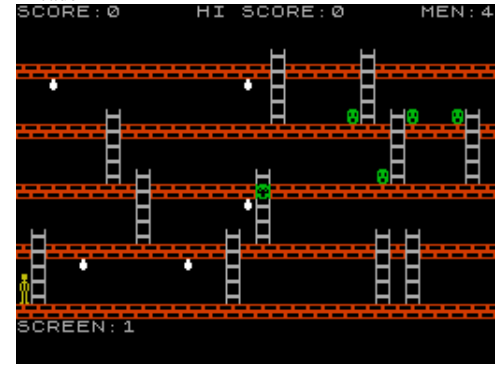

Journey's End (Games Workshop,1985)
Arcade Adventure

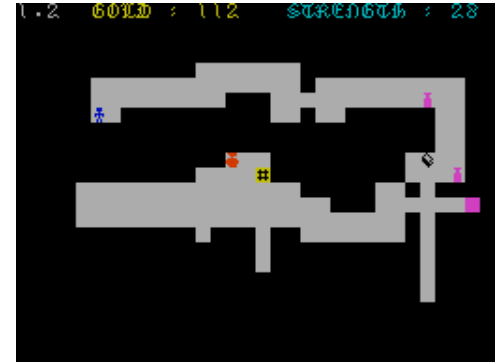

Journey to the Centre of Eddie Smith's Head (Players Software,1986) Text Adventure

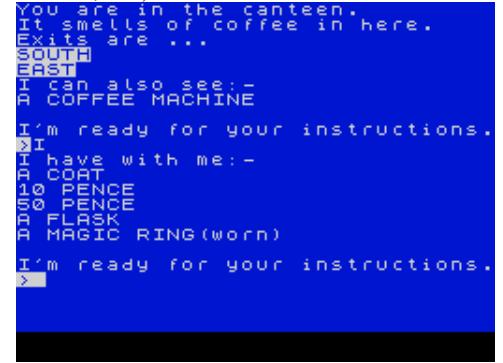

Joya Misteriosa, La (Ediciones Forum,1986)
Text Adventure

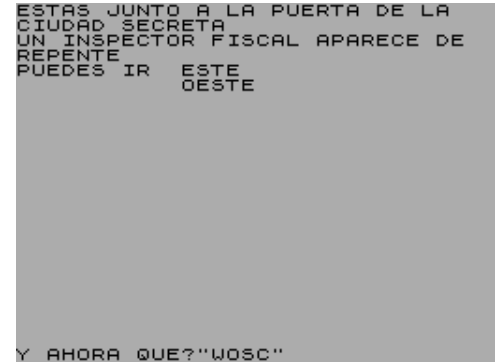

Joystick Conversion Tape I (Kempsoft,1983)
Utility

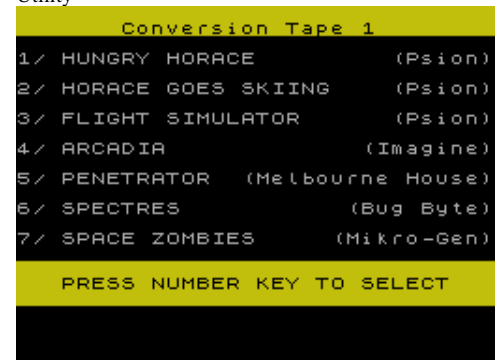

Joystick Conversion Tape II (Kempsoft,1983)
Utility

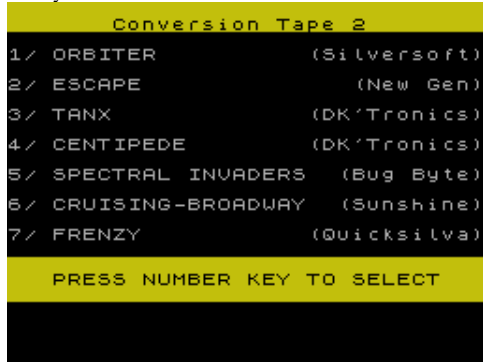

JP-Clone (Your Computer,1984)
Utility: Copier

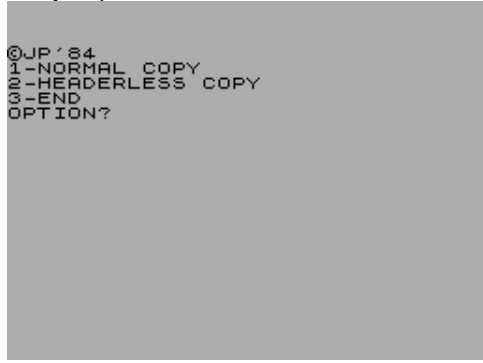

Juanito en Busca de su Baloncito (3P Soft,1989)
Text Adventure



Judge Dredd (Virgin Games Ltd,1990)
Arcade



Juego de la Vida, El (MicroHobby,1986)
Strategy



Joystick Conversion Tape III (Kempsoft,1983)
Utility



JSW Editor (Softricks,1984)
Arcade Game Development Tool



Judge Death (Piranha,)
Arcade Adventure



Judgement Day 3 (Pentagram,1992)
Scene Demo

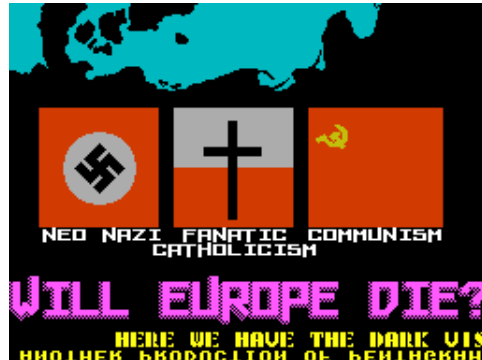

Juego Con Su Spectrum issue 01 (Grupo de Trabajo Software S.A.,1986) Covertape



Joystick Thunder (Hewson Consultants Ltd,1990)
Compilation

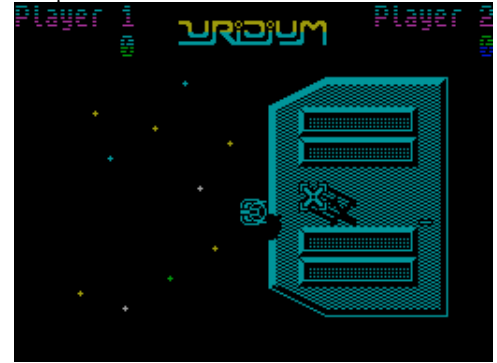

JSW Soaring Game, The (J.S. Williamson,1985)
Simulation

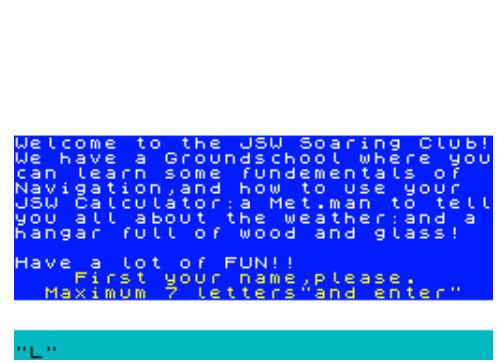

Judge Dredd (Melbourne House,1987)
Arcade



Juego de la Oca, El (Zafiro Software Division,1989)
Board/Card Game



Juego Con Su Spectrum issue 02 (Grupo de Trabajo Software S.A.,1987) Covertape

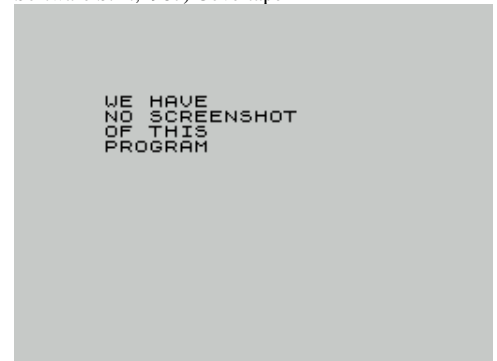

Juegue Con Su Spectrum issue 03 (Grupo de Trabajo Software S.A.,1987) Covertape



Juegue Con Su Spectrum issue 04 (Grupo de Trabajo Software S.A.,1987) Covertape

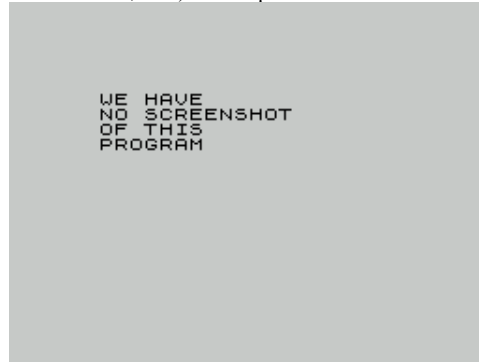

Juggernaut (CRL Group PLC,1985) Simulation

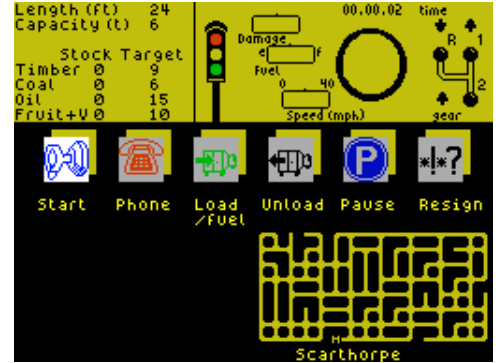

Juggly (Jorgen Bech,1985) Arcade



Jukebox (Your Sinclair,1987) Scene Demo



Jukebox Tranceport (Alfa Soft,1988) Scene Demo



Jum*bert (Norbert Roescher,1986) Arcade



Jumbler (Byron Software,1987) Board/Card Game



Jumbly (DK'Tronics Ltd,1983) Arcade

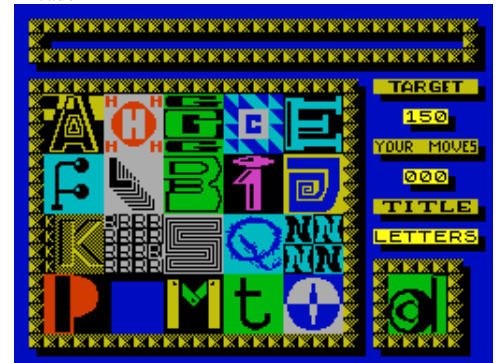

Jumbo, Stoomlok 3737 (Aacksoft,1984) Simulation

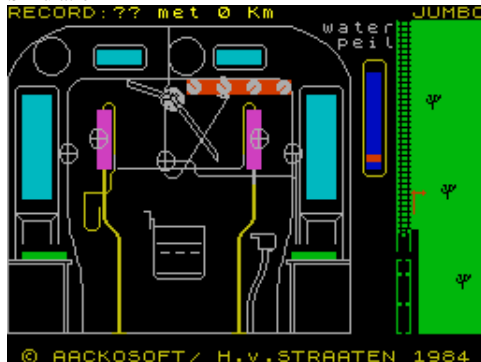

Jump (Ventamatic,1984) Arcade

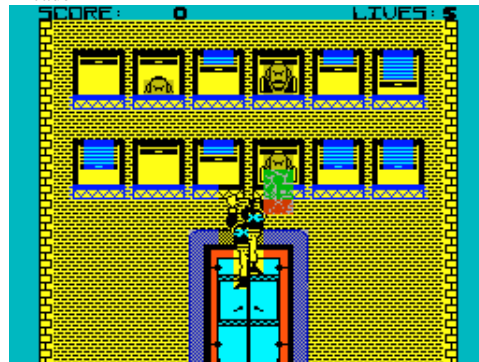

Jump (Zigurat Software,1991) Arcade

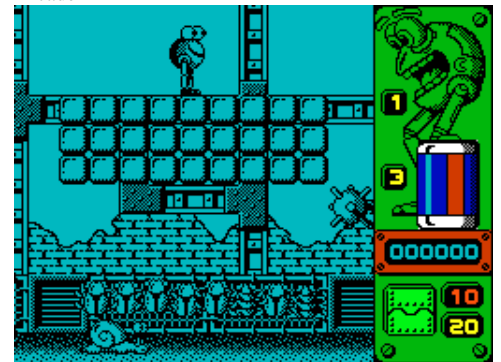

Jump About (Computronic,1984) Arcade



Jumpbug (Your Computer,1984) Arcade



Jump Frog (,) Arcade

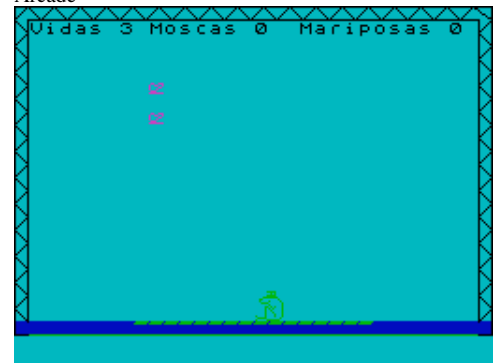

Jumping Jack (Imagine Software Ltd,1983)
Arcade



Jumpy Snake Blues (Software Cottage,1985)
Board/Card Game



Jungle Axe (Hipocrates Soft.)
Arcade



Jungle Job (Interface Publications Ltd,1984)
Arcade



Jungle Trouble (Durell Software Ltd,1983)
Arcade

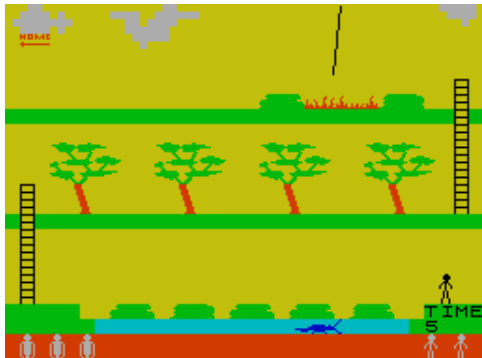

Jump Jet (Anirog Software,1985)
Arcade



Jumpy Snake Blues + Honky Tonk (Software Cottage,1985)
Compilation



Jungle Fever (A'n'F Software,1983)
Arcade



Jungle King (Load 'n' Run [Ita],1985)
Arcade

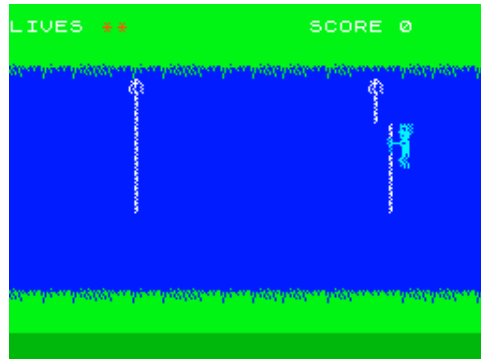

Jungle Warfare (Virgin Mastertronic Ltd,1989)
Arcade



Jump to the Future (Smash Soft,1993)
Scene Demo



Jungle Adventure (CCS,1984)
Arcade

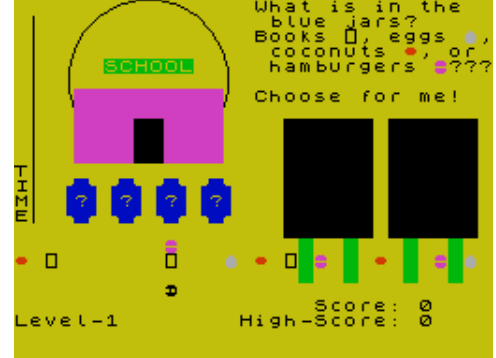

Jungle Jie (Gadtek Games,1985)
Arcade



Jungle Maths (Scisoft,1982)
Educational



Jungle Warrior (Zigurat Software,1990)
Arcade



Junior Education (Calpac Educational Software,1982)
Educational



Just a Mot: French Vocabulary (Sulis Software Ltd.)
Educational



Justin (CNGSoft,2007)
Arcade



K22 (Icabod,2000)
Scene Demo



Kaart van Nederland (Filosoft,1984)
Educational



Junior Maths Pack (Micro-Mart Software,1984)
Educational

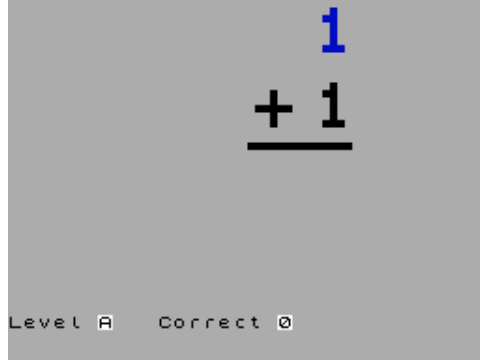

Just For Fun (Jacek Michalak/Cat Man.)
Scene Demo

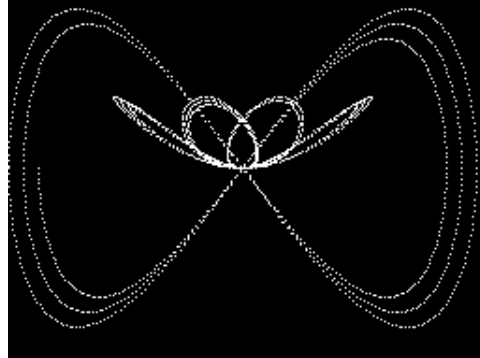

Just One of Those Days (Zenobi Software,1989)
Arcade Adventure

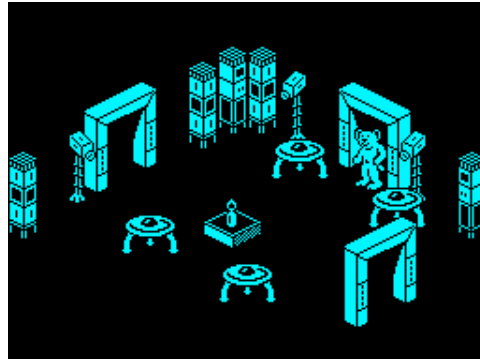

KA1 Assembler (Kobraisoft,1987)
Utility: Programming



Kaa's Kingdom (Edward Beck,1986)
Text Adventure

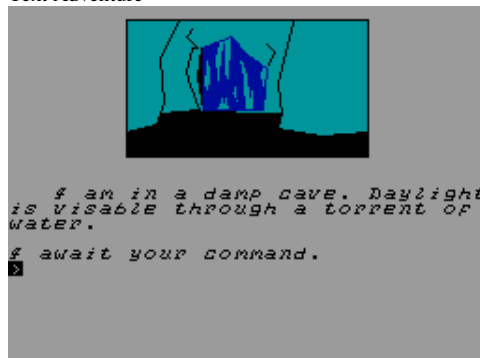

Junior Wordsplits (Sulis Software Ltd,1983)
Educational

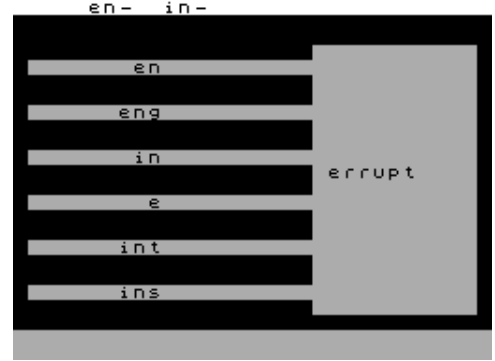

Just Imagine (Central Solutions,1986)
Simulation



Jux (SSS,)
Simulation



KA1 Assembler + KD1 Disassembler (Kobraisoft,1987)
Compilation



Kaboom! (Proxima Software,1986)
Arcade

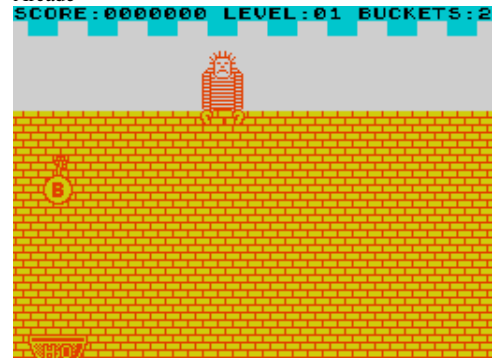

Kafer Anton (,1985)
Arcade



Kalaha (EMM Software,1983)
Board/Card Game



Kalendarz (Janusz Gajewicz,1984)
Utility

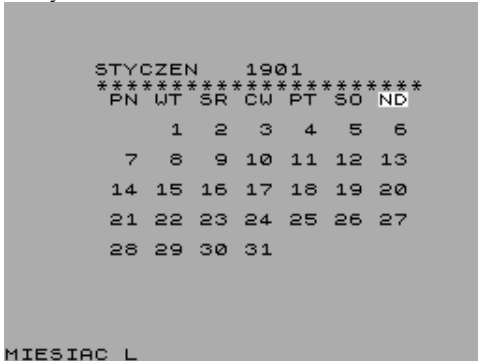

Kamel (Creative Computing,)
Arcade

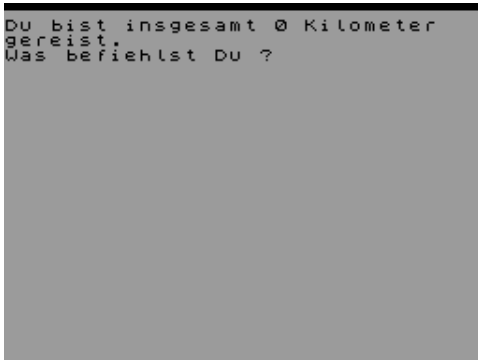

Kamikaze (A'n'F Software,1983)
Arcade

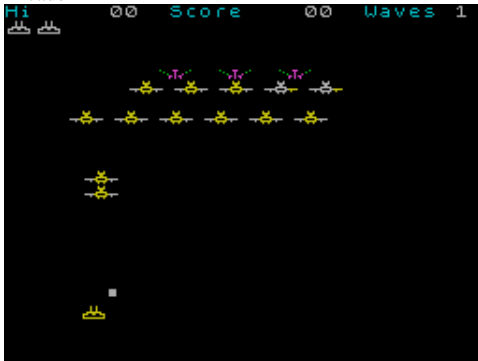

Kai Temple (Firebird Software Ltd,1986)
Arcade



Kalaha (ZX Data,1984)
Arcade



Kama Basic I (Kamasoft,1988)
Utility: BASIC Related



Kamelreiten (Rainbow Software,)
Text Adventure



Kamikaze (Astral Software Ltd,1982)
Arcade



Kalah (White Eagle,1997)
Board/Card Game



Kalendar (,)
Utility

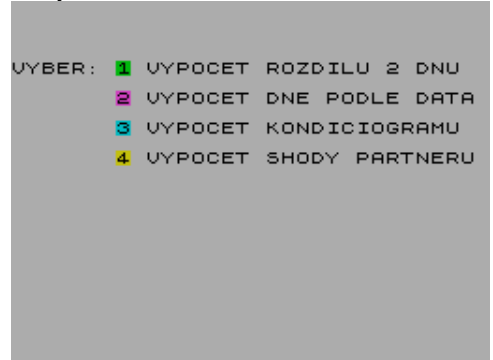

Kama Basic II (Kamasoft,1988)
Utility: BASIC Related



Kamicaces 2000 (MicroHobby,1985)
Arcade



Kamikaze (Code Masters Ltd,1991)
Arcade



Kamikaze (J.K. Greye Enterprises Ltd,1982)
Arcade

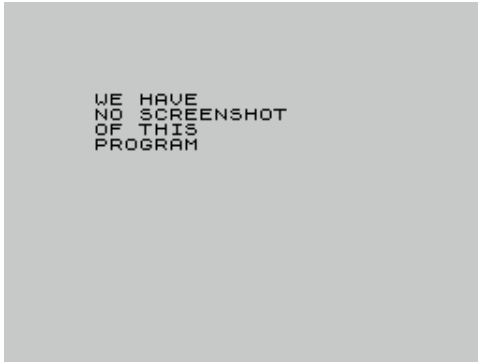

Kamikaze + Gopher (Block-Byte Computing,1983)
Compilation

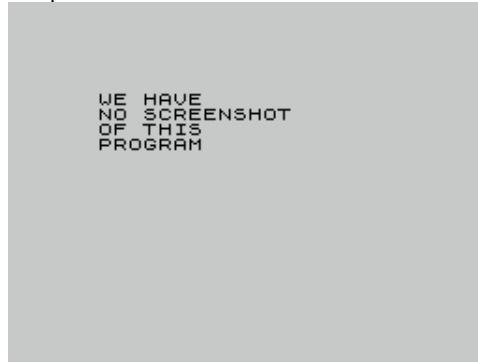

Kamikaze Buggie! (Tweety Soft Ltd,1984)
Arcade



Kamikaze Collector (Century City Software Ltd,1985)
Arcade

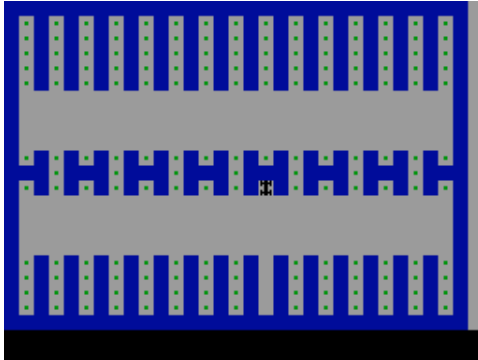

Kane (Mastertronic Ltd,1986)
Arcade



Karate Ace (Gremlin Graphics Software Ltd,1988)
Compilation



Karateka (Dro Soft,1990)
Arcade

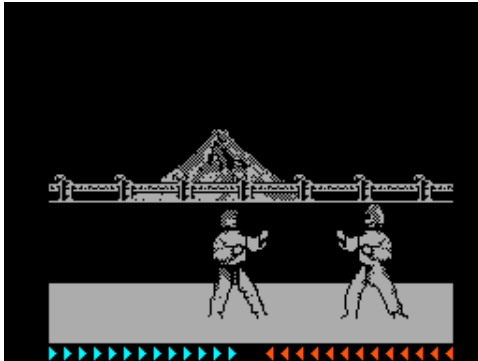

Karel 85 (Jan Ruppert,1985)
Utility: Programming



Karnaugh (Miguel Angel Rodriguez Jodar,1989)
Utility: Mathematics



Karnov (Electric Dreams Software,1988)
Arcade

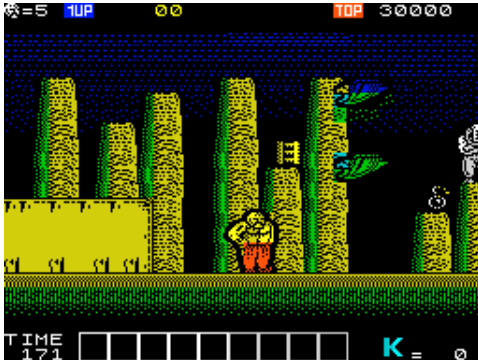

Kartagon 2 (Bluff Relay,1986)
Text Adventure



Kartoteka Szefa (Nowatech,1985)
Utility



Kartyas Jatek (NyitraiSOFT,2005)
Board/Card Game



Karyssia: Queen of Diamonds (Incentive Software Ltd,1987)
Text Adventure



Kassetten Inhalt (.)
Utility

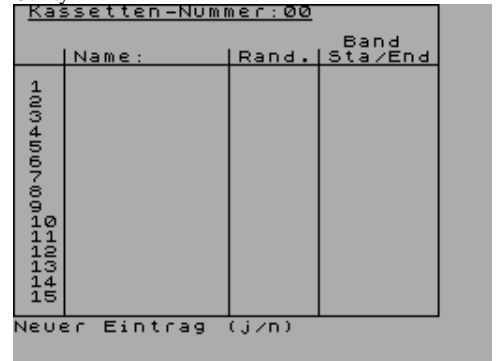

Kassette fur Benutzer (Goldstar,1984)
Compilation

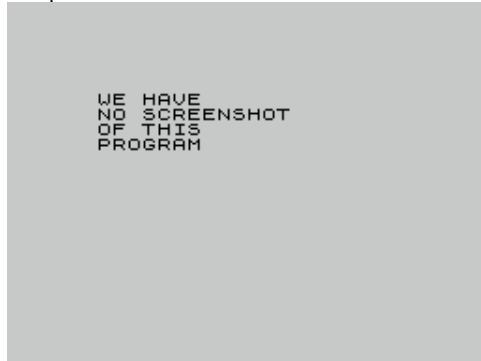

Katalog Print (A. Durych,)
Utility

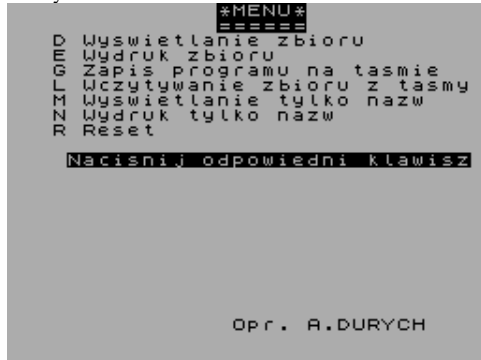

Kat Trap (Streetwise,1987)
Arcade



Kaz Demo 1 (Kassoft,1990)
Scene Demo



Kaz Demo 4 (Kassoft,1990)
Scene Demo

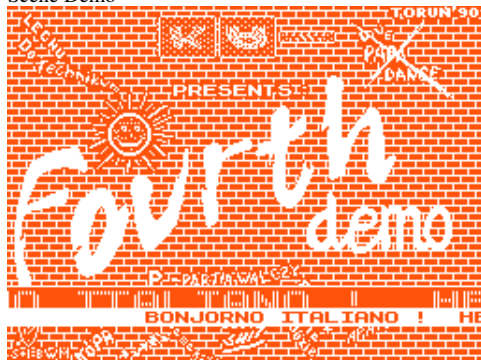

Katalog (Janusz Gajewicz,1985)
Utility

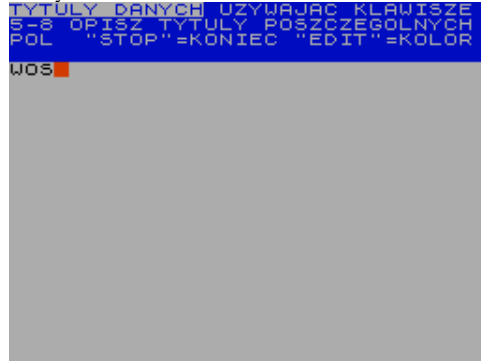

Katharsis (Master Home Computers Group,1998)
Scene Demo



Kawasaki (Zeppelin Games Ltd.)
Arcade



Kaz Demo 2 (Kassoft,1990)
Scene Demo



Kaz Demo 5 (Kassoft,1990)
Scene Demo



Katalog Kaset (A. Durych.)
Utility



Katoth (EP Software,)
Arcade

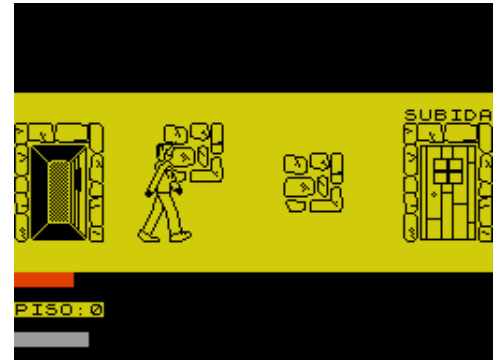

Kayleth (US Gold Ltd,1986)
Text Adventure



Kaz Demo 3 (Kassoft,1990)
Scene Demo



Kaz Demo 6 (Kassoft,1990)
Scene Demo



Kaz Demo 9 (Kassoft,1990)
Scene Demo



Kdo to Vi (Fuxoft,1988)
Utility



Kempston Centronics Interface S (Kempston Micro Electronics Ltd,1983) Utility

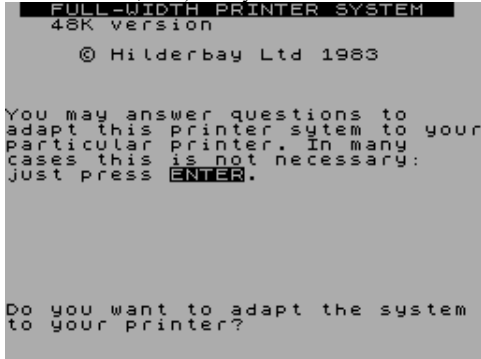

Kemshu (Cult Games,1989)
Board/Card Game

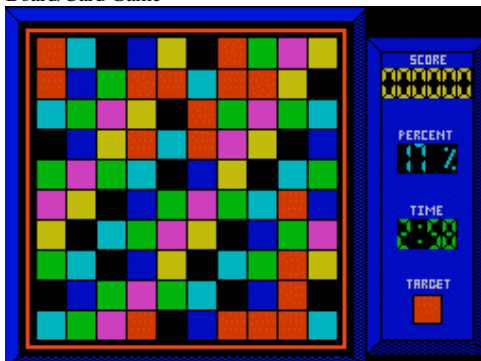

Kenny Dalglish Soccer Match (Impressions Software Ltd,1990) Sport



KD1 Disassembler (Kobraisoft,1987)
Utility: Programming



Kecal 2 (Oldsoft,1992)
Utility



Kempston Mouse Interface Driver (Chris Cowley,2003)
Utility

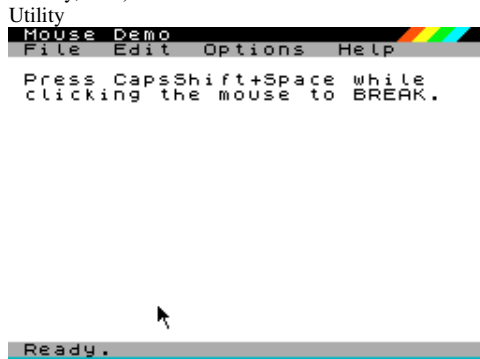

Kendo Warrior (Byte Back,1989)
Arcade



Kentilla (Micromega,1984)
Text Adventure



Kdo Jsi? (Fuxoft,1989)
Utility

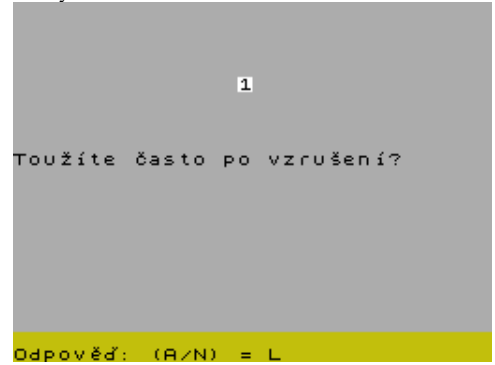

Keeper, The (Gordon Fong,1986)
Text Adventure

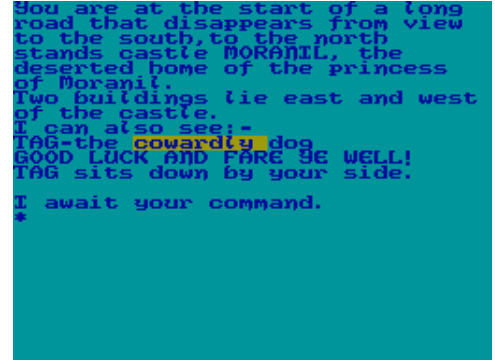

Kempston Toolkit (Kempston Micro Electronics Ltd,1987)
Utility



Kenny Dalglish Soccer Manager (Impressions Software Ltd,1990) Simulation



Kentucky Racing (Alternative Software Ltd,1991)
Arcade



Keops (Oscar Garcia Cagigas,)
Text Adventure



Kewin I (Kamasoft,1988)
Strategy



Keycode (CCS,1983)
Board/Card Game

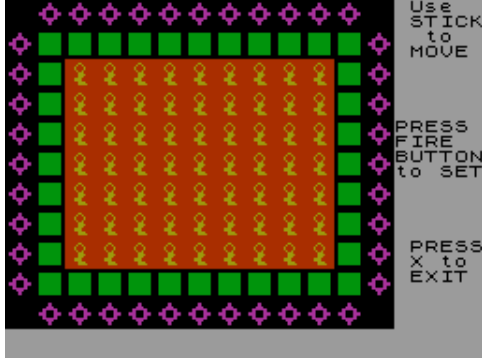

Key Fighter (JKK Research Limited,1984)
Text Adventure

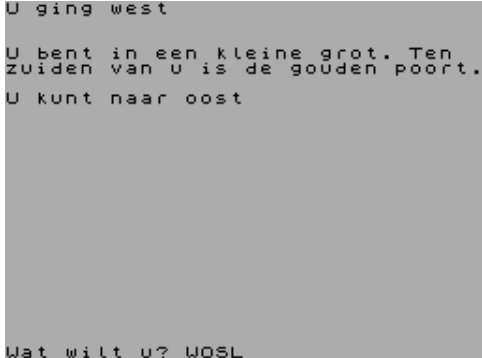

Keys of Time (.)
Text Adventure



Keop's Revenge (MicroHobby,1985)
Arcade



Kewin II (Kamasoft,1988)
Strategy



Keycode (Darryl LeCount,1993)
Board/Card Game

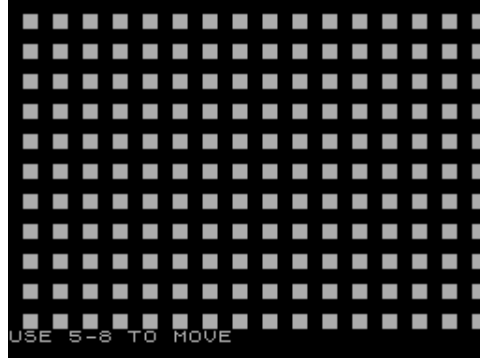

Keyfile (Keysoft,1984)
Utility

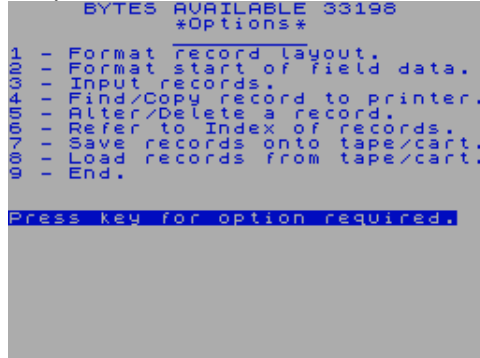

Key Speaker (S&G Software,1983)
Utility

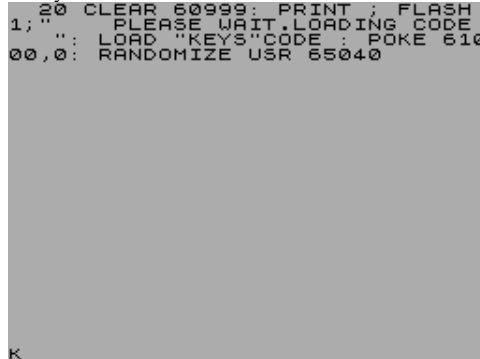

Ke Rulen Los Petas (Iber Software,1991)
Text Adventure



Keyboard (J. Enters Productions,1985)
Utility: Music Creation



Keydefine (Scientific Software,1984)
Utility: Programming



Key of Hope, The (Games Workshop,1985)
Text Adventure



Key, The (Keysoft,1983)
Utility: Copier



Key, The (unpublished,)
Text Adventure



Keywork (D-B Software, 1987)
Arcade

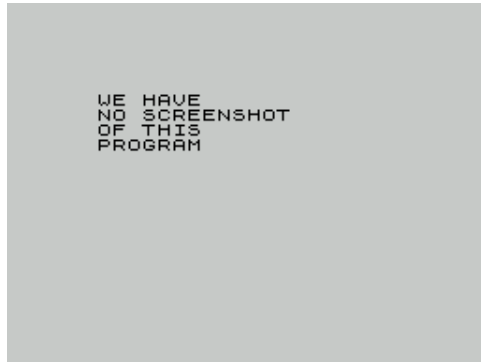

Khazzad-Dum (SPE, 1989)
Arcade



Kick Da Gaga (Avalon, 1999)
Arcade



Kick Off World Cup Edition (Anco Software Ltd, 1990)
Arcade

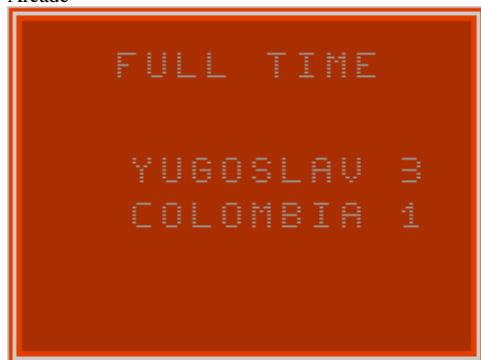

Key, The (Venny Software, 1983)
Utility: Copier

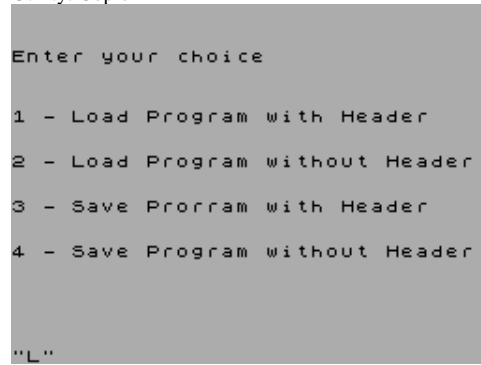

KGB Superspy (Code Masters Ltd, 1989)
Arcade



Kickboxing (Firebird Software Ltd, 1987)
Sport



Kick Off (Anco Software Ltd, 1989)
Arcade



Kickstart (Pete Tester, 1987)
Utility

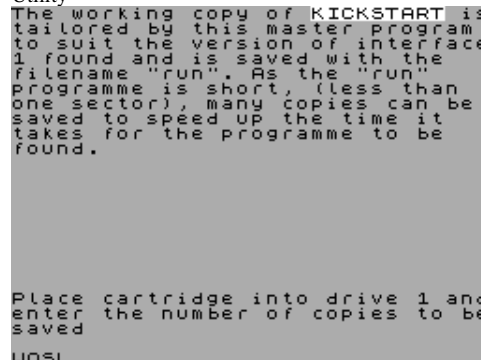

Key to Time, The (Lumpsoft, 1984)
Text Adventure

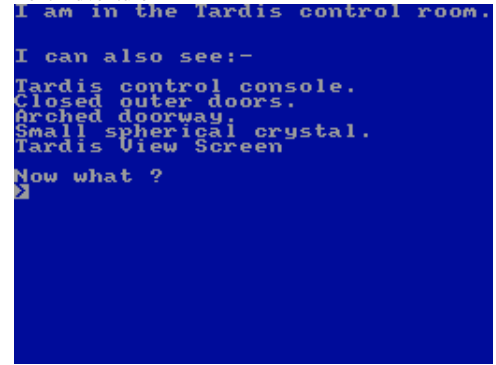

Khangrin Plans, The (Zenobi Software, 1992)
Text Adventure

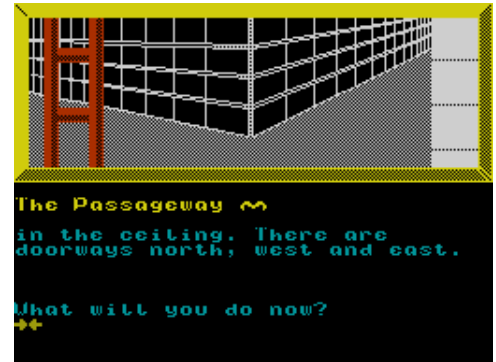

Kick-Box Vigilante (Zeppelin Games Ltd, 1991)
Arcade



Kick Off 2 (Anco Software Ltd, 1990)
Arcade



Kiddie Cubes (Younger Software, 1982)
Board/Card Game



Kiddisoft (Kiddisoft,1985)
Covertape



Kids on Keys (Spinnaker Software Corporation,1984)
Educational



Kidsplay (Activision Inc,1987)
Compilation



Kilburn Encounter (SCP Hackers,1989)
Text Adventure

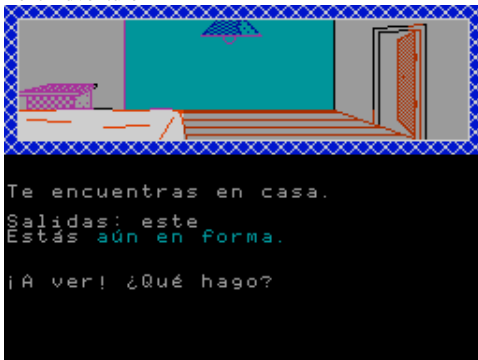

Killer Kong (Blaby Computer Games,1983)
Arcade

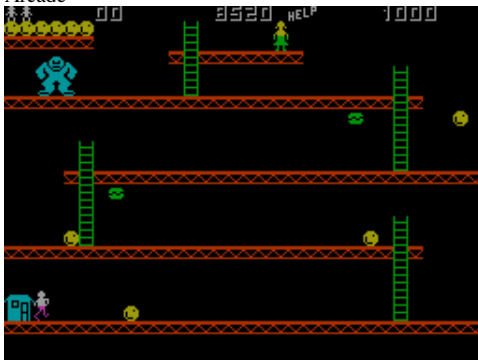

Kidnap (Sparklers,1985)
Arcade



Kids Pack 1 (Alternative Software Ltd,1992)
Compilation



Kijk (Mirrorsoft Ltd/Wolters Software,1984)
Educational

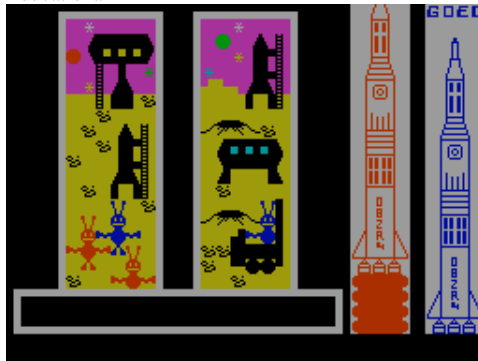

Killed Until Dead (US Gold Ltd,1987)
Text Adventure



Killer Ring (Reaktor,1987)
Arcade



Kidnapped (Zenobi Software,1993)
Text Adventure

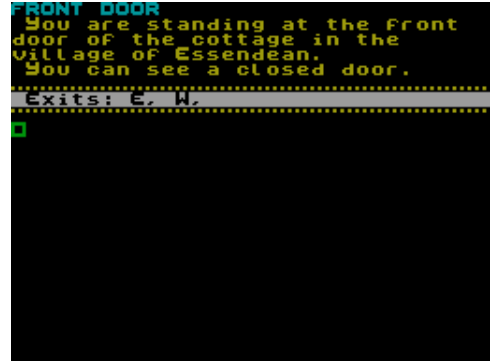

Kids Pack 2 (Alternative Software Ltd,1993)
Compilation

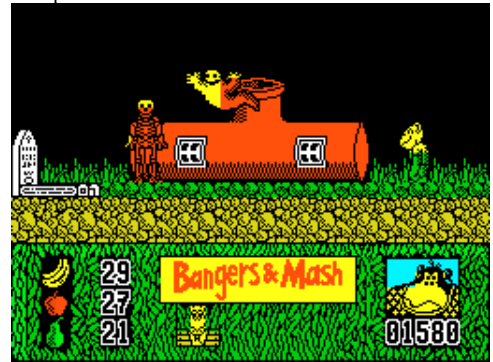

Kikstart 2 (Mastertronic Ltd,1988)
Arcade



Killer Knight (Phipps Associates,1984)
Arcade



Kill PC 2: Judgment Day (Rage Tech,1998)
Arcade



Kill PC 3 (Rage Tech,1999)
Arcade

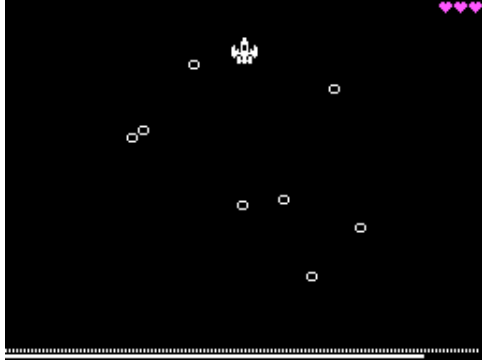

Kindercomp (Spinnaker Software Corporation,1984)
Educational



King (Destiny Software,)
Text Adventure



King Arthur (East Midland Software,1983)
Strategy



Kingdom (.)
Strategy

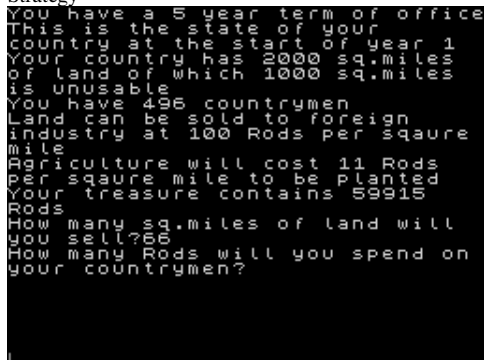

Kim (Sinclair Research Ltd,1982)
Arcade



Kinetik (Firebird Software Ltd,1987)
Arcade



King (Psychaedelic Hedgehog Software,1991)
Text Adventure

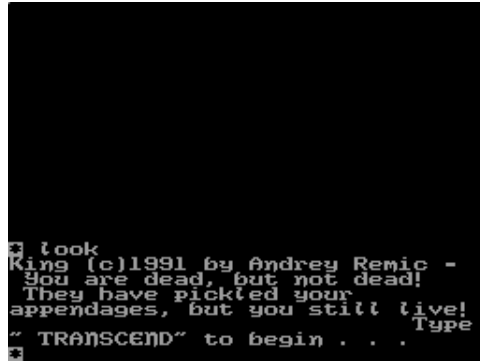

King Arthur's Quest (Hill MacGibbon,1984)
Text Adventure



Kingdom of Grain (THD,1992)
Text Adventure

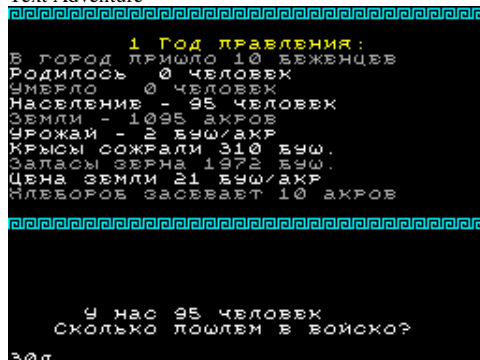

Kiming (Paraninfo Soft S.A.,)
Educational



King (Bsoft,1999)
Board/Card Game

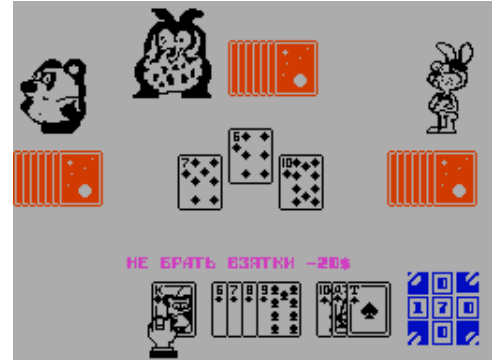

King Arthur (Chameleon,1983)
Strategy



King Chip (XYLYX Computer Entertainment,1986)
Board/Card Game



Kingdom of Hamil (Topologika,1988)
Text Adventure



Kingdom of Krell, The (Anco Software Ltd,1987)
Text Adventure



King Otto's Quest (Stephen Robertson,1996)
Text Adventure



King's Bounty (STRG,1998)
Strategy

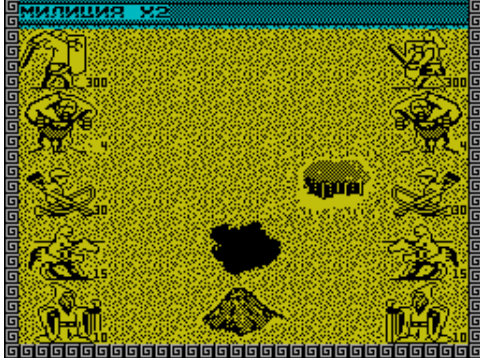

King's Keep (Firebird Software Ltd,1986)
Arcade Adventure



King Valley (WE [Belarus],1994)
Arcade



King Leonard (Mind Games Espana S.A.,1986)
Arcade

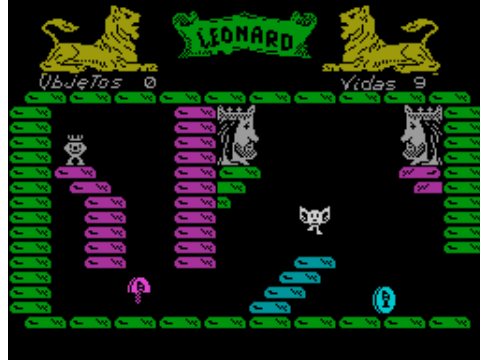

King's Bounty (EJB,1995)
Strategy



King's Bounty 3 (Magic Moon,1997)
Strategy



King's Ransom (Incentive Software Ltd,1986)
Text Adventure



Kirel (Addictive Games Ltd,1986)
Arcade

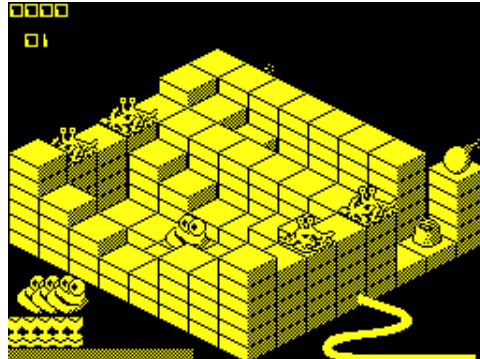

King of Time Super Turbo Killer (M.Coder,1994)
Arcade



King's Bounty (EnergO,1993)
Strategy



King's Bounty 3 (Oleg Parfenov,2001)
Strategy



King Tut's Treasure (Mirrosoft Ltd,1985)
Arcade Adventure



Kit-Tik Attack (JJK Research Limited,1984)
Arcade

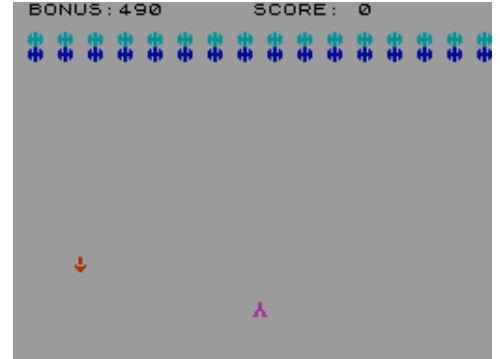

Kix 128K (Hacker Chris,1988)
Scene Demo



Klad: Part 1 (Technotime,1994)
Arcade



Klaverjas (.)
Board/Card Game



Kleuren Kubus (.)
Simulation

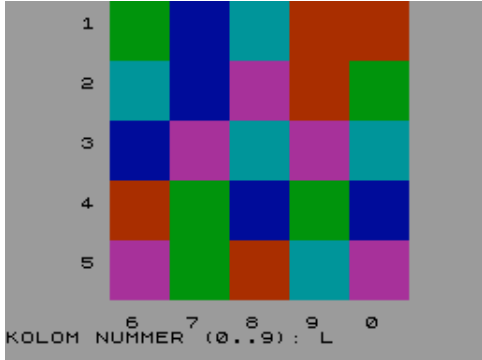

Klingsor the Evil Magician (.)
Text Adventure

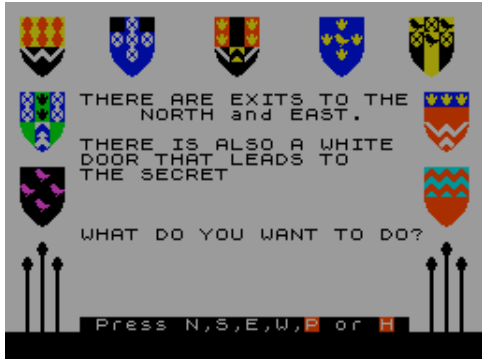

K'Laber (MicroHobby,1985)
Arcade

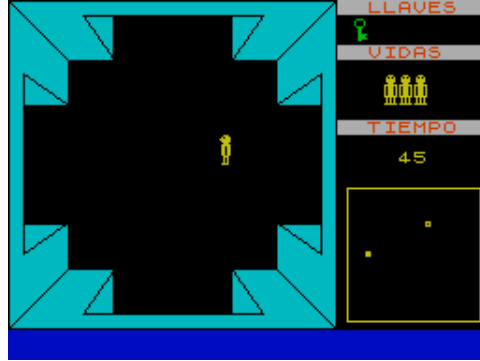

Klademiner (Bitmunchers,1996)
Arcade

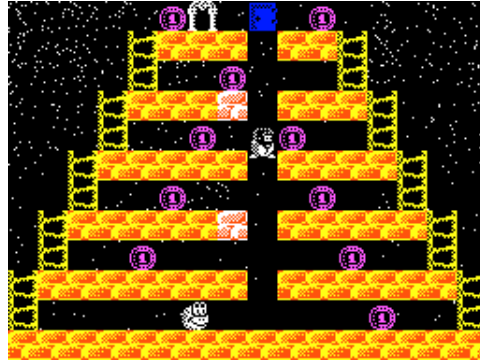

Klaverjas (YRS,2005)
Board/Card Game

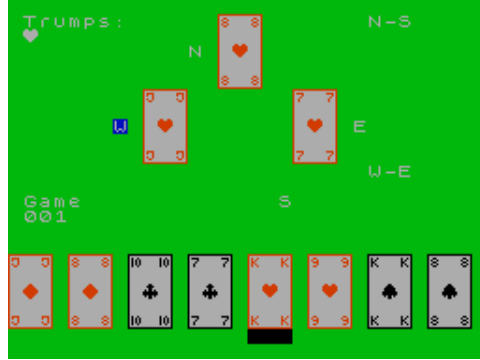

Kliatba Noci (Ultrasoft/Sintech,1993)
Arcade Adventure

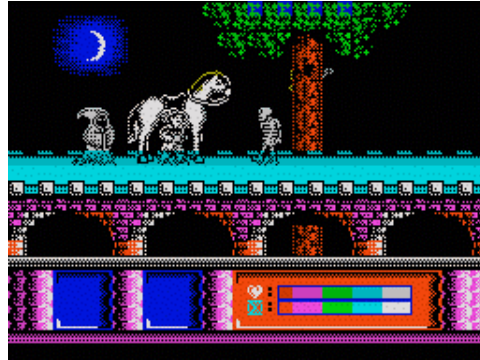

Klio 1 (Krajowe Wydawnictwo Czasopism,1987)
Educational



Klad (Raydac Soft,1997)
Arcade

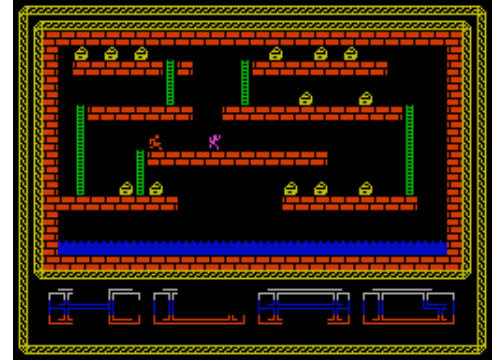

Klartz & the Dark Forces (Dragon Dungeon,)
Text Adventure



Klax (Domark Ltd,1990)
Arcade

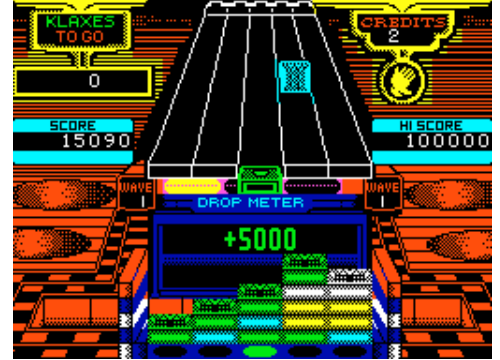

Klimax (Hewson Consultants Ltd,1990)
Arcade

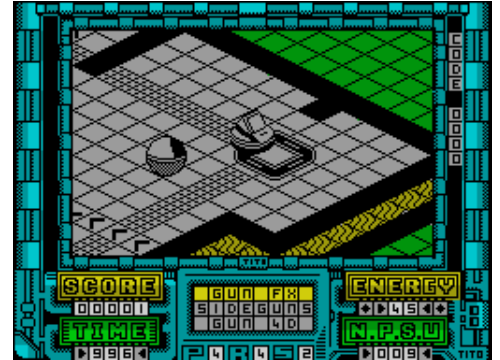

Klokkijken Analog + Klokkijken Digitaal (Primsoft,)
Educational



Klondike Bill (Brian Fitton,1985)
Strategy

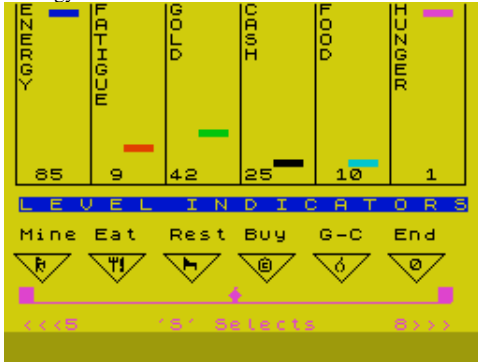

Kluxer (Jeez,1999)
Board/Card Game

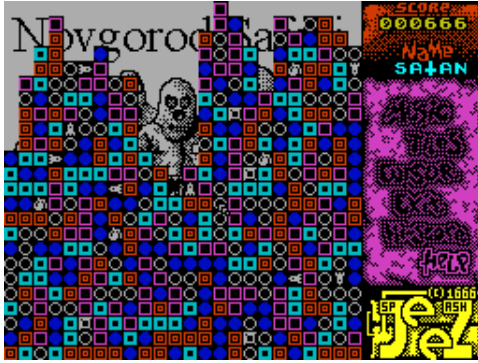

Knight Driver (Hewson Consultants Ltd,1984)
Arcade

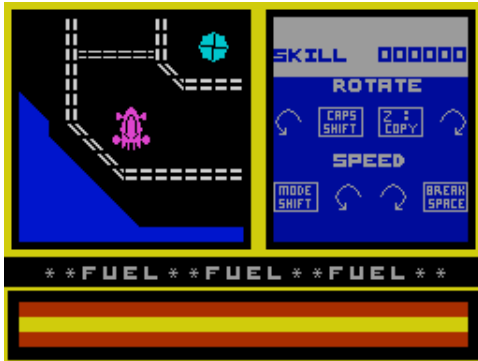

Knight Force (Titus,1990)
Arcade

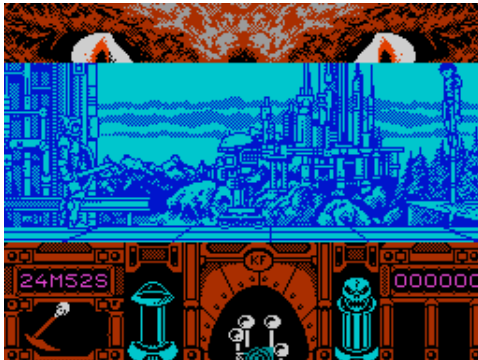

Knight Life (Stephen Boyd,1995)
Text Adventure



Kludo (Meow Micros,1983)
Board/Card Game

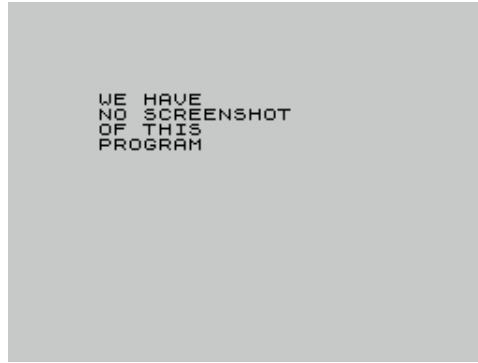

Kniffel (Ansgar Zerfass,1983)
Board/Card Game



Knight Fall (Pirate Software Ltd,1987)
Arcade



Knight Games 2 (Black Knight Software,1986)
Compilation



Knight Lore (Ultimate Play The Game,1984)
Arcade Adventure



Kludo + Battleships (Meow Micros,1983)
Compilation

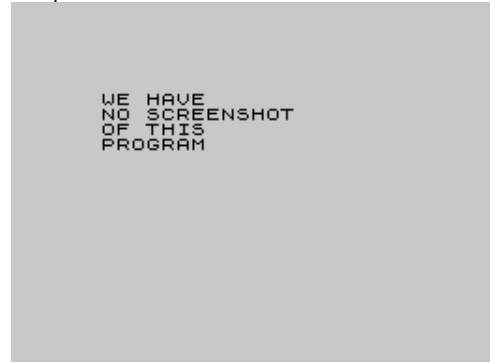

Knight Car (MicroHobby,1986)
Arcade



Knight Fight (Fontana Publishing,1982)
Arcade

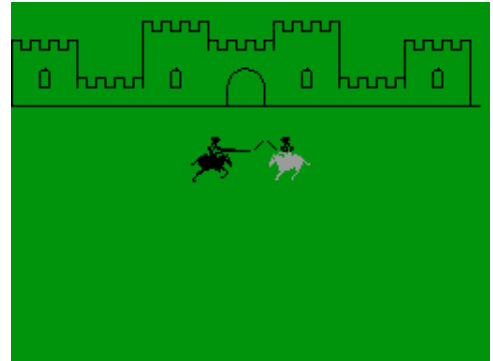

Knight Ghost (Dro Soft,1987)
Arcade



Knight Lore 2: Conquest of Fairlight (High Voltage,1985)
Arcade



Know Your Tables (Collins Educational,1983)
Educational

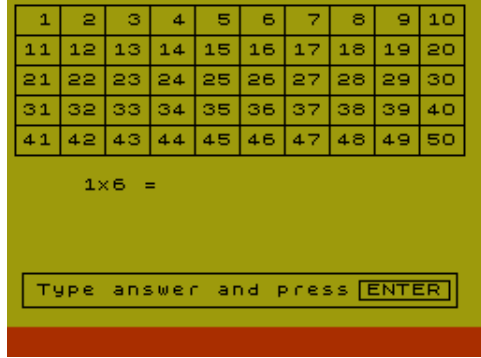

Kobyashi Naru (Mastertronic Ltd,1987)
Text Adventure



Kocka2004 (NyitraiSOFT,2004)
Board/Card Game

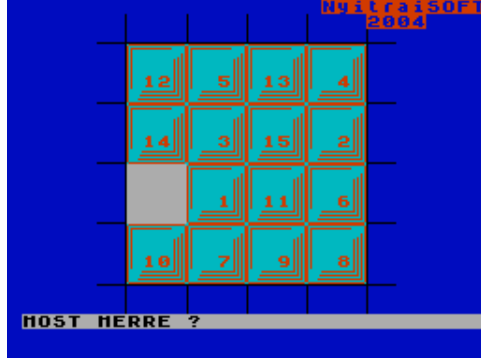

Kokotoni Wilf (Elite Systems Ltd,1984)
Arcade



Kolobok (A. Bazarkin,1996)
Arcade Adventure

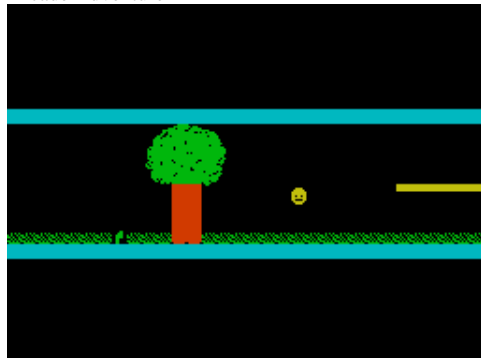

Knuckle Busters (Melbourne House,1987)
Arcade Adventure

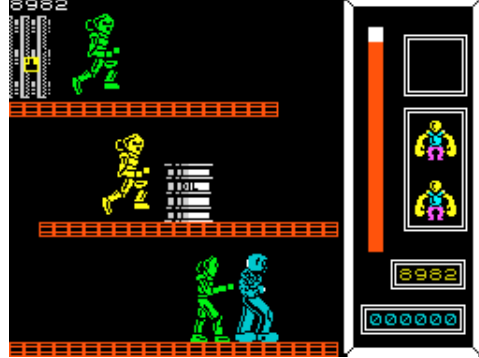

Kock (Scorpion Software,1994)
Scene Demo



Kockapoker (Laszlo Nyitrai,2003)
Board/Card Game



Koky (Proxima Software,1992)
Arcade



Kolobok (Softwarrior,1995)
Arcade Adventure



Kobyashi Ag'Kwo (Zenobi Software,1991)
Text Adventure

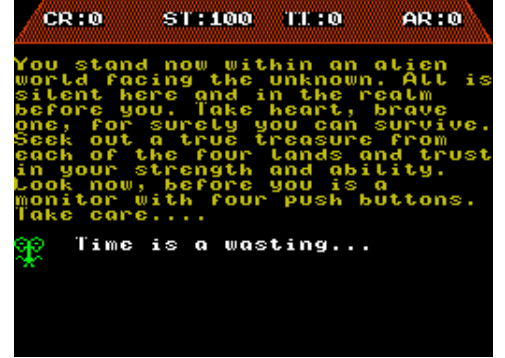

Kocka 2 (Jatekgyaros,2005)
Board/Card Game

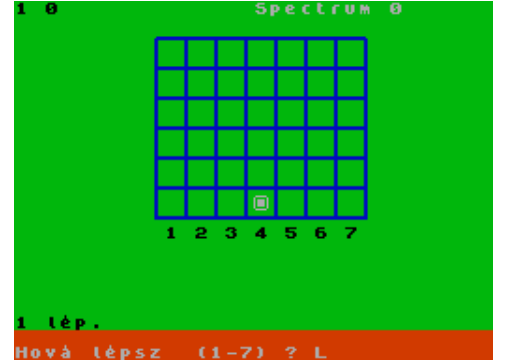

Koekoek - Koekoek (Edusystems,1984)
Educational



Koledy (Kicia,1989)
Scene Demo



Kolobok Zoom: Teenage Mutant Hero (Asphyxia,1998)
Arcade

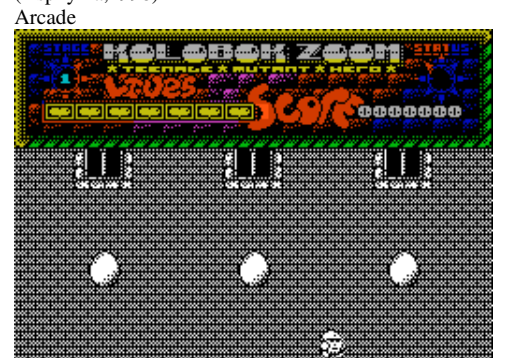

Kolobok Zoom 2: In The Unfair World (Asphyxia/Fatality,1998) Arcade



Komplex (Legend,1985) Arcade

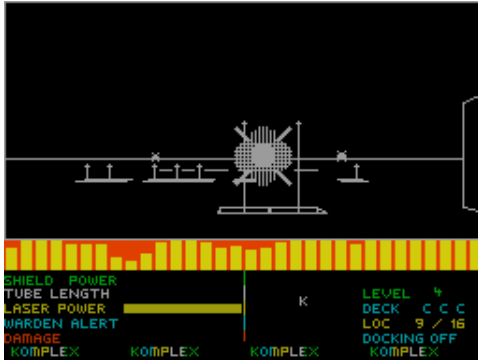

Konami's Arcade Collection (Imagine Software Ltd,1989) Compilation



Kondiciogram (JSC,1985) Utility



Kong (Stephen Hall/Nicholas Walmsley,) Arcade

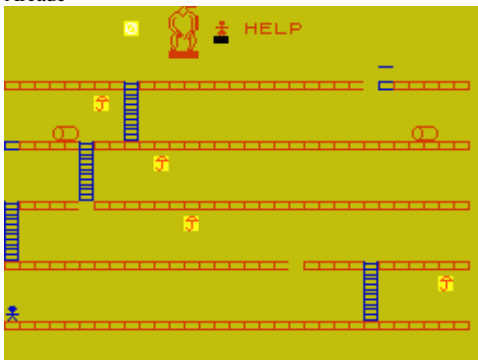

Komando II (Ultrasoft,1992) Arcade

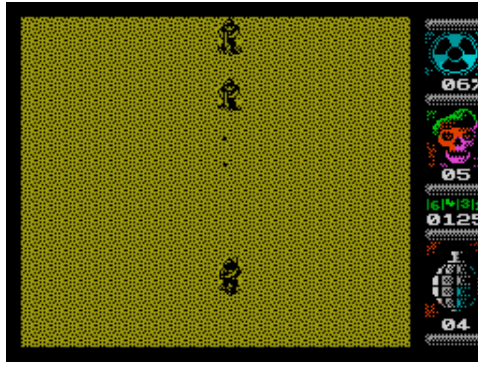

Komplex City (Legend,1985) Arcade

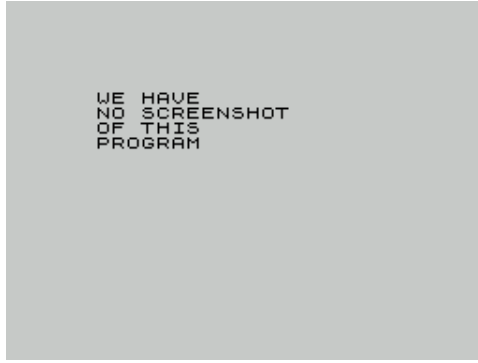

Konami's Coin-Op Hits (Imagine Software Ltd,1986) Compilation

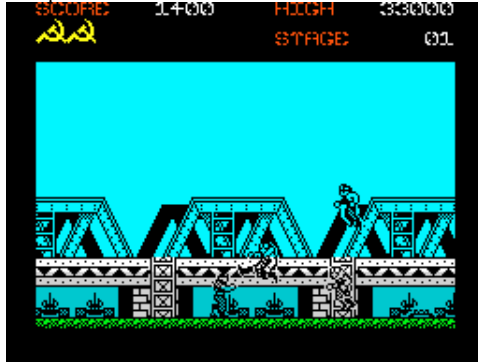

Kong (Anirog Software,1983) Arcade

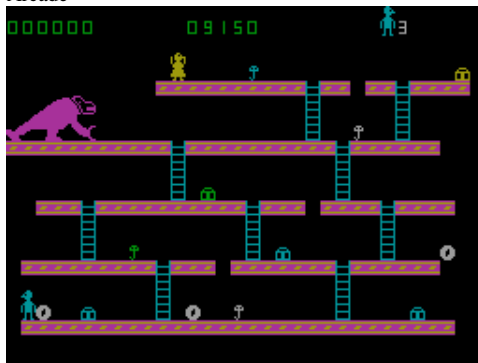

Kongedomme (.) Simulation



Kombatris (Kingdom Dreams,1996) Arcade

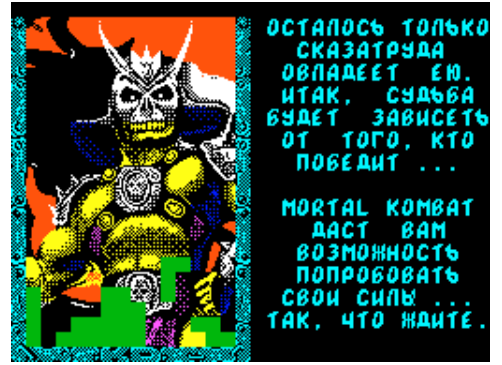

Komunist (.)

Utility: Font/UDGs

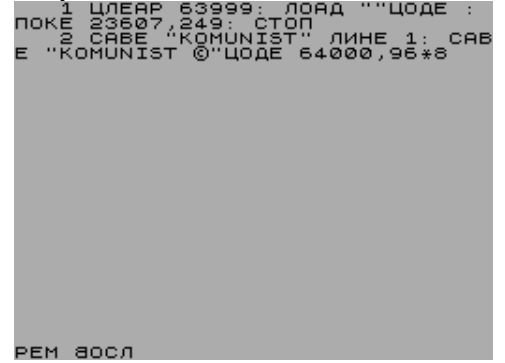

Konami's Golf (Imagine Software Ltd,1986) Sport



Kong (Ocean Software Ltd,1984) Arcade



Kongman (Memotronic,1984) Arcade



Kong's Revenge (Zigurat Software,1991)
Arcade

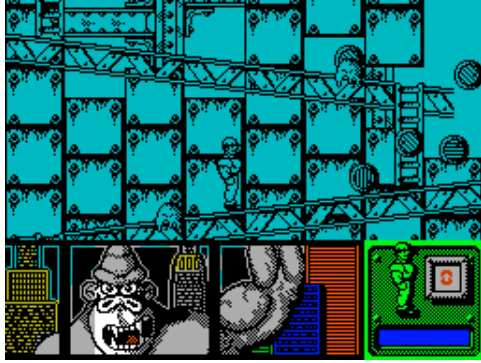

Kontrolor Kucnih Troskova (Svet Kompjutera,1985)
Utility: Spreadsheet



Kopierprogramm (E. Wedeking,1984)
Utility: Copier

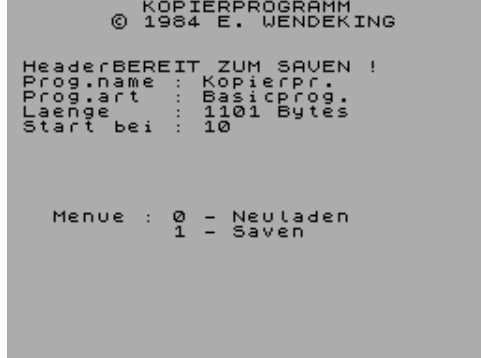

Koronis Rift (Activision Inc,1987)
Arcade



Korth Trilogy, The 3: Into the Empire (Penguin Books,1983)
Arcade Adventure



Kong Strikes Back (Ocean Software Ltd,1985)
Arcade



Kopiarka (.)
Utility: Copier
WOSL
BAJTY WOLNE: 42240



Kopy Kat (Medsoft,1984)
Utility: Copier



Korth Trilogy, The 1: Escape from Arkaron (Penguin Books,1983) Arcade Adventure



Kosci Rzucone (.)
Board/Card Game



Kontrabant (Radio Student,1984)
Text Adventure

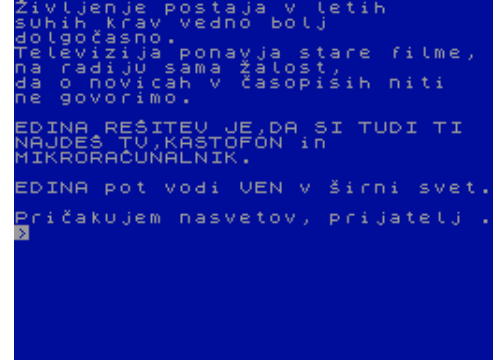

Kopierprogramm (D. Kraus,1983)
Utility: Copier



Korabliki (Alexander Sizenko,1999)
Board/Card Game



Korth Trilogy, The 2: Besieged (Penguin Books,1983) Arcade Adventure



Kosmic Kanga (Micromania,1984)
Arcade



Kosmic Pirate (Blaby Computer Games,1983)
Arcade



Kosti Poker (Auryn Creative Group,1996)
Board/Card Game



Kraal (Hewson Consultants Ltd,1990)
Arcade

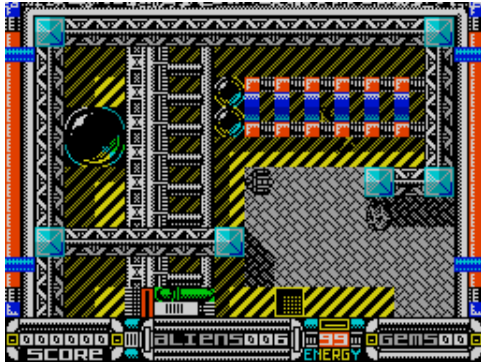

Kraheck (.)
Arcade



Krakatoa (MicroHobby,1986)
Arcade



Kosmik Pirate (Elephant Software,1984)
Strategy



K.O. Whist (16/48 Tape Magazine,1984)
Board/Card Game



Kraft Megademo (Extacy-3,1993)
Scene Demo

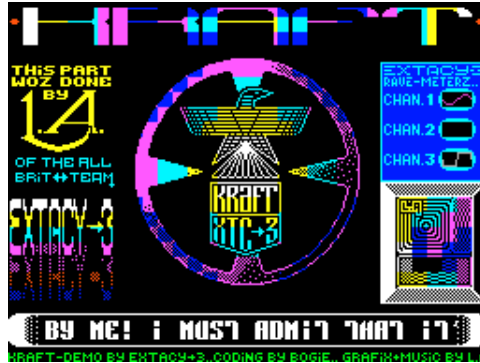

Kraj (EP Software,.)
Arcade

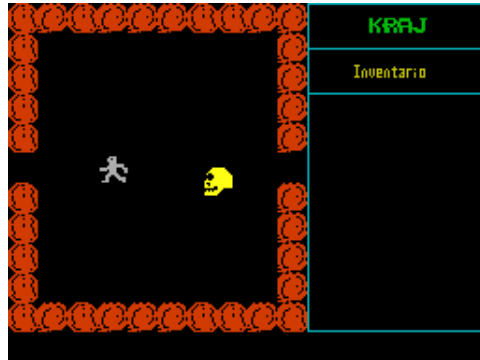

Krakatoa 2012 (Sinclair User,1986)
Arcade



Kosmos (Atlantis Software Ltd,1989)
Arcade



Kozel (Accept Corp,1999)
Board/Card Game



Krago Castle (Assassin Software,1983)
Text Adventure

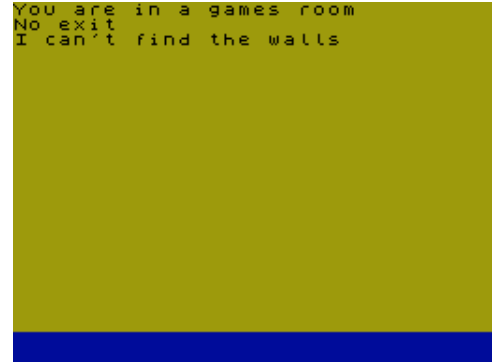

Krakatoa (Abbex Electronics,1984)
Arcade



Kraken (Kassoft,.)
Arcade



Krakit (Artic Computing Ltd,1982)
Text Adventure



Krazy Kartoonist Kaper + Grue-Knapped, The (FSF Adventures,1991) Compilation

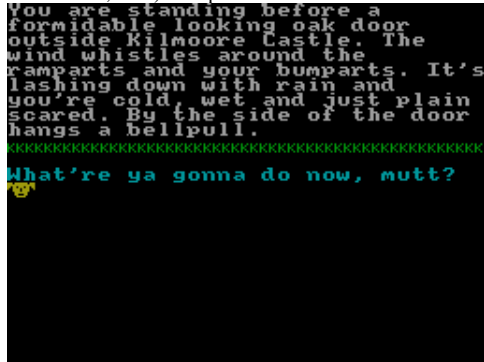

Krazy Kong (C-Tech,1982)
Arcade

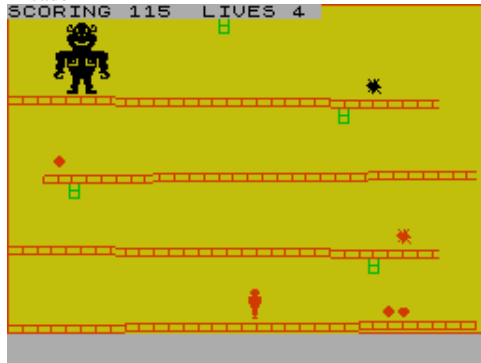

Kreds Alys (.)
Utility: Sound Manipulation
Antal Knp. (Excl.Ref.)



Kribedg (Inforcom,1992)
Board/Card Game



Krakout (Gremlin Graphics Software Ltd,1987)
Arcade

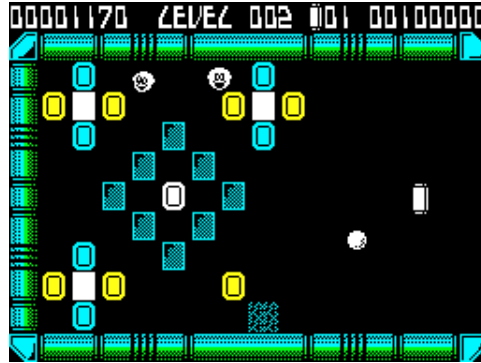

Krazy Kartoonist Kaper, The (FSF Adventures,1991)
Text Adventure



Krazy Kong (PSS,1983)
Arcade



Krestiki Noliki (Phantom Family Corp,1997)
Board/Card Game

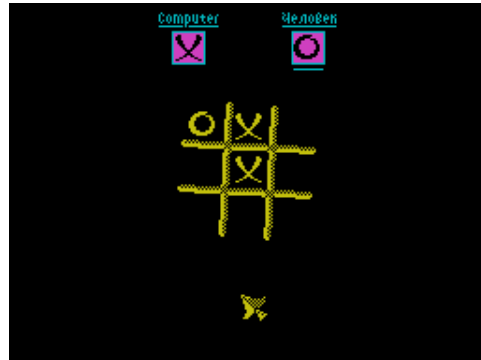

Krolewna Jebaczka (X-Prog,1984)
Arcade



Krazy Digger (Anco Software Ltd,1983)
Arcade

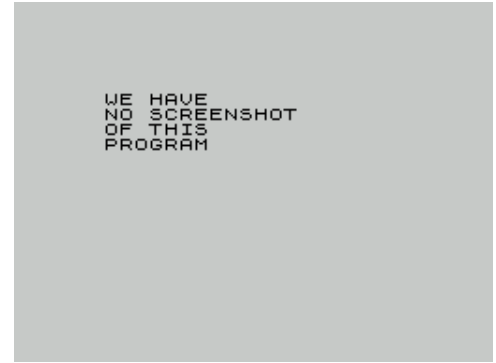

Krazy Kitchens (Jonathan Caldwell,1989)
Arcade

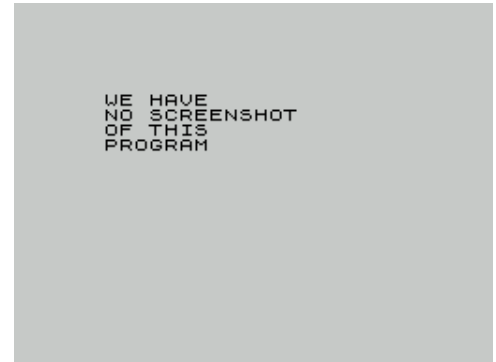

Krazy Kong + Panic Island (C-Tech,1982)
Compilation



Krestiki Noliki (Serachan,1997)
Board/Card Game

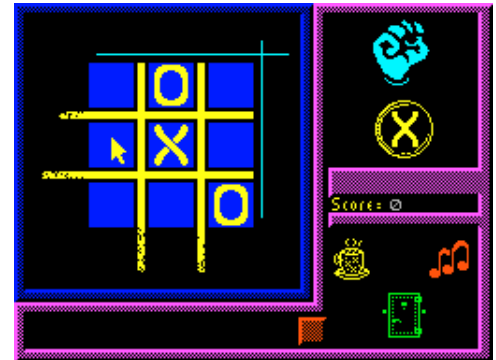

Krom el Guerrero (OMK Software S.L.,)
Arcade



Krtek (Proxima Software,1990)
Arcade



K'set issue 1 (Ediciones y Textos S.A.,1985)
Covertape



Kube's Maze (XFAWORLD Software,2004)
Arcade



Kubyk (MicroHobby,1986)
Arcade



Kulikovsky War (WE [Belarus],1994)
Strategy

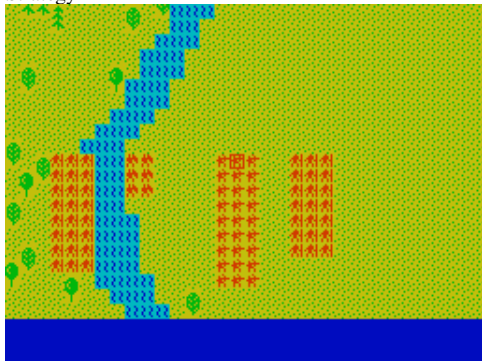

Krypton Factor, The (TV Games,1987)
Simulation



K'set issue 2 (Ediciones y Textos S.A.,1985)
Covertape



Kubiki Kossa (Vadim Bodrov,1995)
Educational



Kuhajmo (Radio Student,1985)
Educational

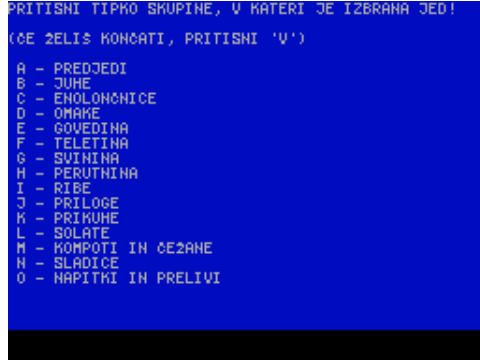

Kung-Fu (Bug-Byte Software Ltd,1984)
Sport



Krypton Raiders (Future Stars,1985)
Arcade

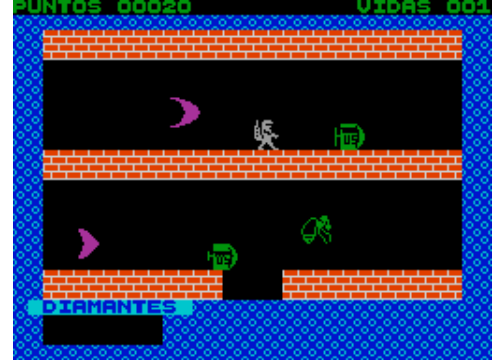

K'Thath (MicroHobby,1985)
Arcade



Kubtrubbel (Dennis Lindqvist,1986)
Board/Card Game

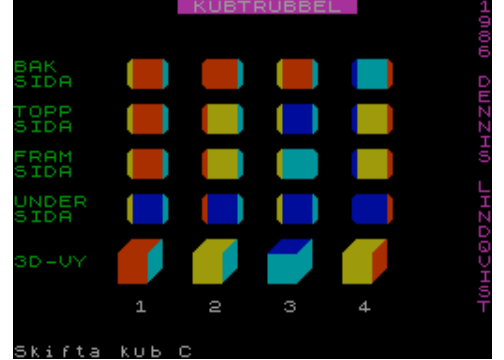

Ku-Ku (Micro Value,1988)
Arcade



Kung-Fu (MicroHobby,1985)
Arcade



Kung Fu Knights (Top Ten Software,1988)
Arcade

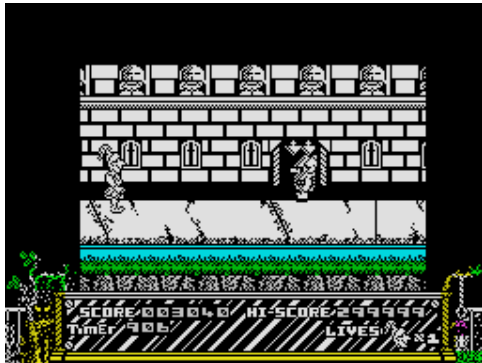

Kurven (Lutz Hoepfner,)

Utility: Mathematics

Welche Funktion $a(f)$ soll es denn sein ?

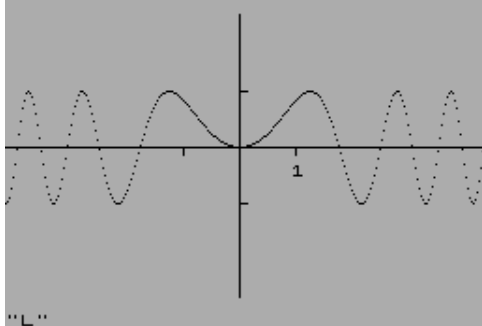

"L"

Kwah! (Melbourne House,1986)

Text Adventure

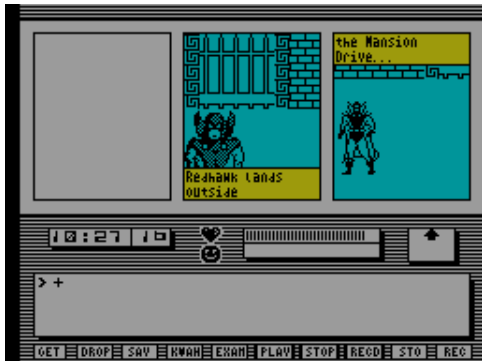

Kwik Snax (Code Masters Ltd,1990)

Arcade

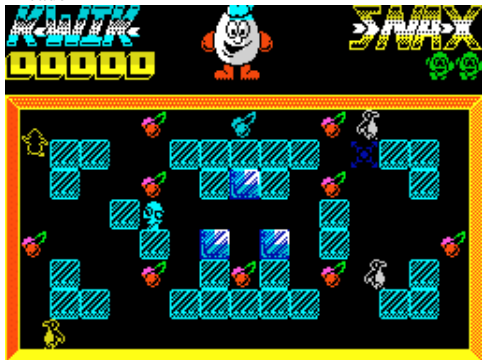

Labeller (16/48 Tape Magazine,1985)

Utility

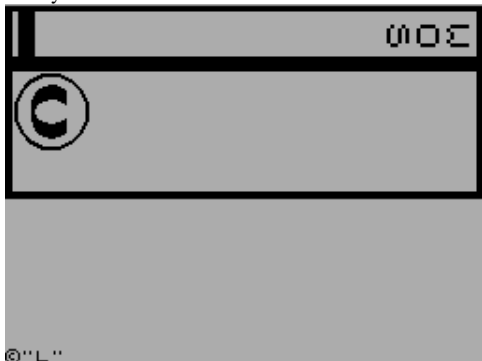

"L"

Kung-Fu Master (US Gold Ltd,1986)

Arcade

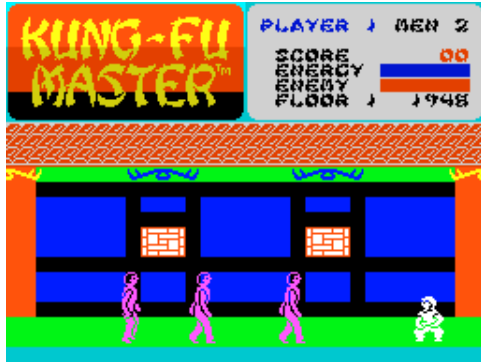

Kutya (Jatekgyaros,2005)

Board/Card Game

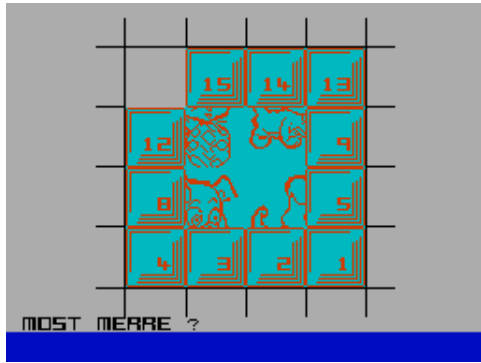

Kwikload (Foraits Software,1985)

Utility

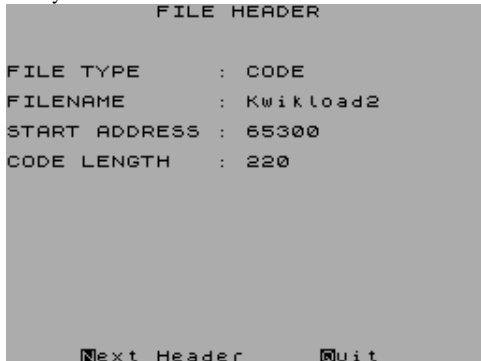

KX-5 (Claus Jahn,1987)

Utility: Music Creation

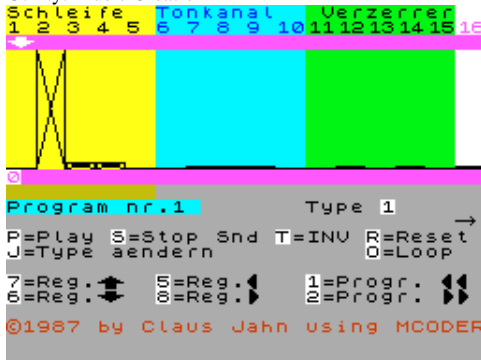

Laberinto (Jose Francisco Andani,)

Arcade



Kung-Fu Warriors (Beyond Belief,1992)

Arcade

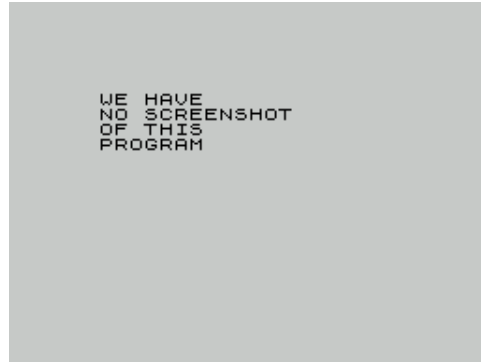

Kuzelky (.)

Arcade

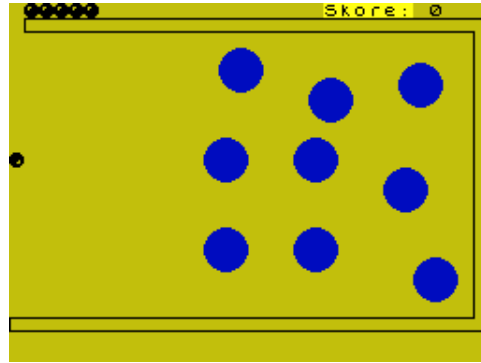

Kwikload 2 (Foraits Software,1985)

Utility

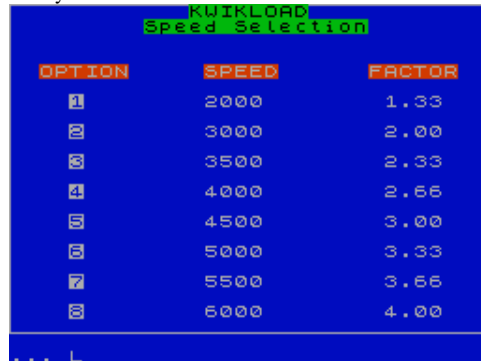

Labarinth (The Guild,1990)

Text Adventure

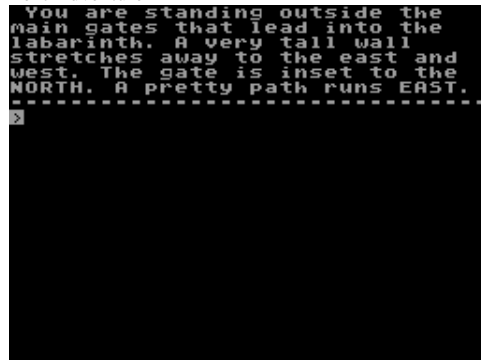

Laberinto (MicroHobby,1985)

Arcade

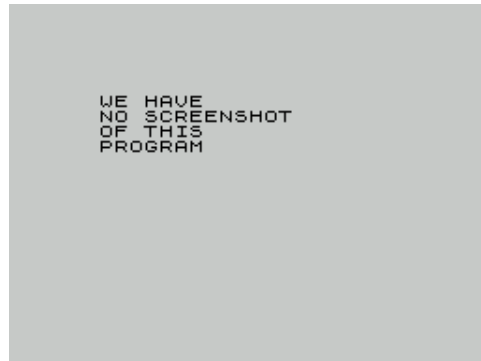

Laberinto de Knosos, El (MicroHobby,1986)
Arcade



Laberinto de Lemnos, El (MicroHobby,1986)
Arcade



Laberinto, El (MicroHobby,1985)
Arcade



Laberinto I (Rock'n'Soft,)
Arcade



Laberinto II (Rock'n'Soft,)
Arcade



Laberinto III (Rock'n'Soft,1990)
Arcade



Laberinto Matematico (MicroHobby,1985)
Educational



Labirint (SuperSoft [2],1998)
Arcade



Labirint 8 (Sergey Mesenov,)
Arcade



Labirinti Smerti (02-S Soft,1995)
Arcade

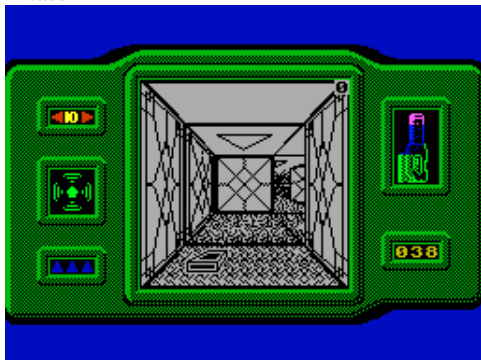

Labirintus (Laszlo Nyitrai,1998)
Arcade

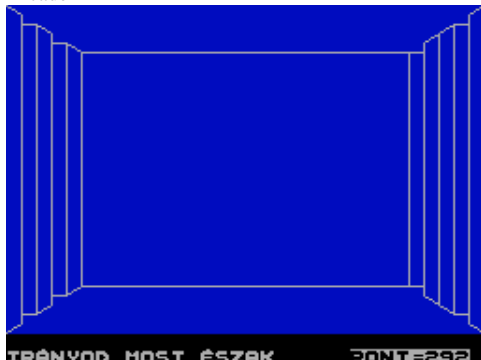

Labirintus (Tivadar Radacsy,1985)
Arcade

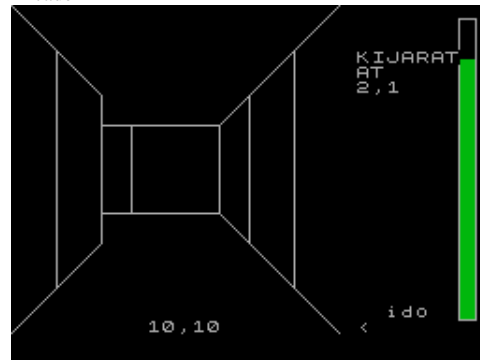

Labirynt (Bajtek 6/88 & P.Sz.,1988)
Arcade



Labour Pains (Zenobi Software,1996)
Text Adventure

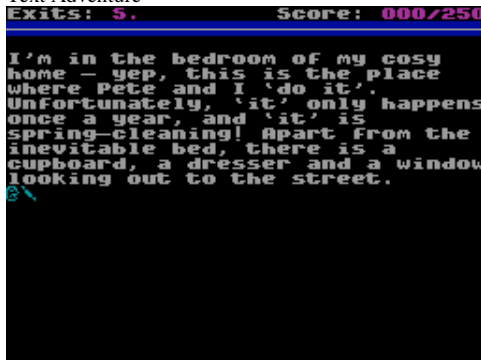

Labours of Hercules, The (Smart Egg Software,1987)
Text Adventure

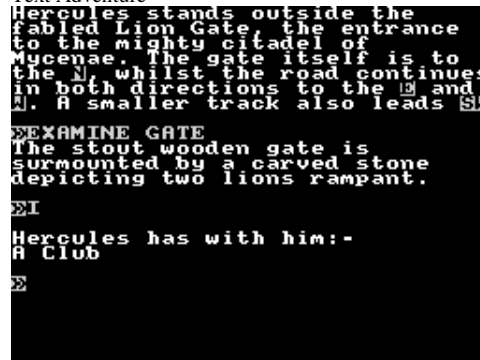

Labyrinth (Activision Inc.)
Arcade Adventure

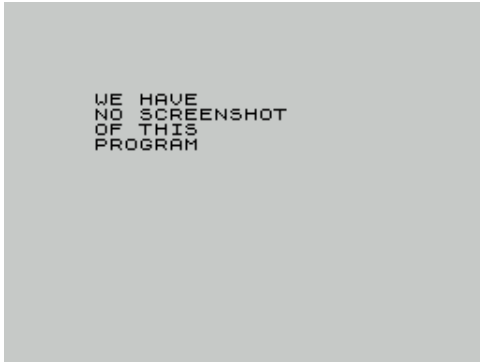

Labyrinth (Sinclair Programs,1984)
Arcade

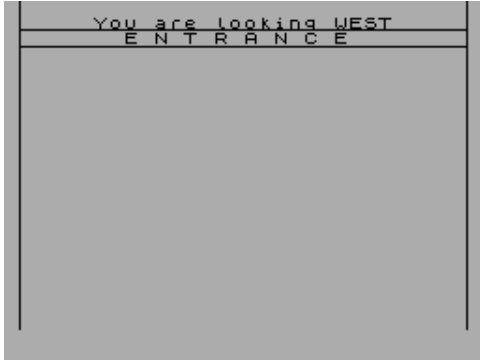

Labyrinth, 3D (Busy Software/Fuxoft,)
Arcade



Labyrinthion (Budgie Budget Software,1986)
Arcade



Ladeks (Cheese Freak Software,2004)
Arcade

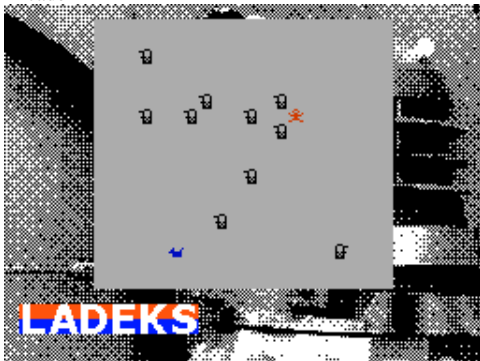

Labyrinth (Axis Software,1983)
Arcade

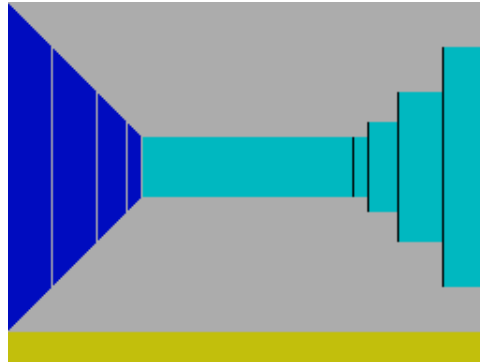

Labyrinth (Sinclair Research Ltd,1982)
Arcade



Labyrinth, 3D (Individual Software Service,1983)
Arcade



Labyrinthman (CV Software,1990)
Arcade

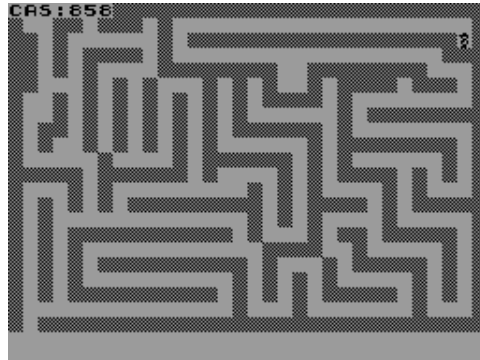

Ladron (MicroHobby,1985)
Arcade

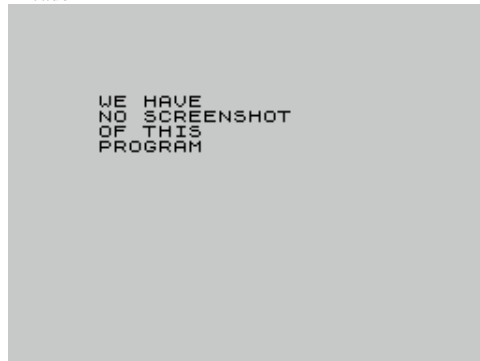

Labyrinth (Christor Buening,1983)
Arcade

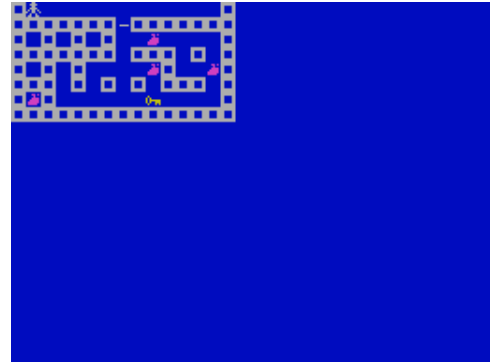

Labyrinth, 3D (.)
Arcade

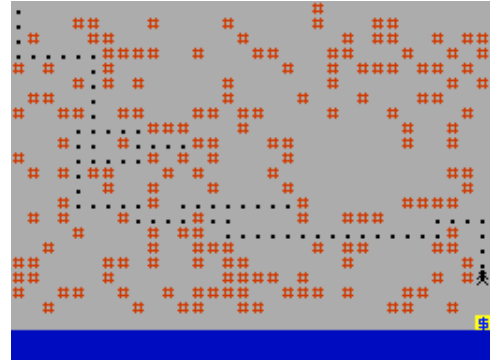

Labyrinth Games (Raxoft/Omikron Software [2],1990)
Arcade



Ladatologato Jatek (Laszlo Nyitrai,2000)
Board/Card Game

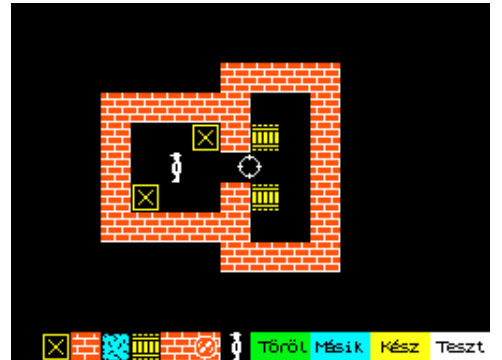

LA Drugs Bust (Players Software,1990)
Arcade



Lady Copy (Ladinek,1985)
Utility: Copier



Lancelot (Mandarin Software,1988)
Text Adventure

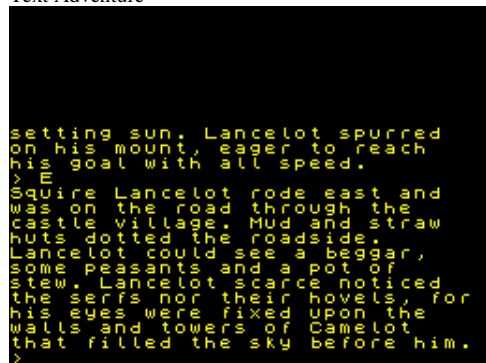

Lander (P.W. Norris,1983)
Arcade

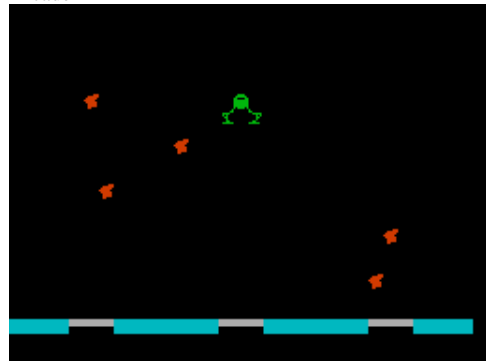

Land of Neverwhere (The Power House,)
Arcade

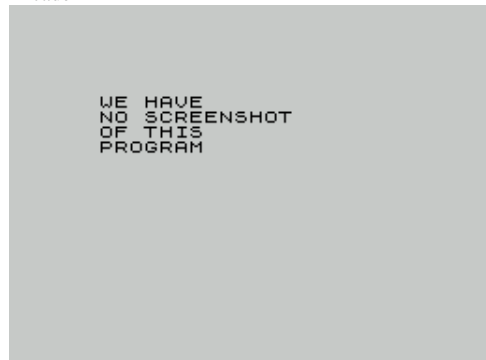

Language Development Series (Micro Master,1982)
Educational



Lagartijos (MicroHobby,1985)
Arcade



Lancer Lords (Rabbit Software Ltd,1983)
Arcade



Lander (R.D. Foord Software,)
Arcade



Land of No Return (Video Force,)
Text Adventure



Language Vocabularies (Options International,1986)
Educational



Lambda! (P.P. Minio,1990)
Scene Demo



Land Beyond Time, The (Simon Allan Software,2006)
Text Adventure

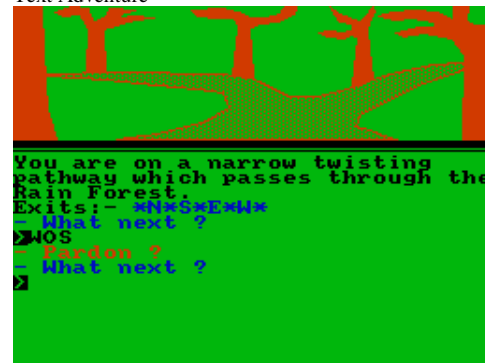

Landfall on Rollus (Clwyd Adventure Software,1987)
Text Adventure

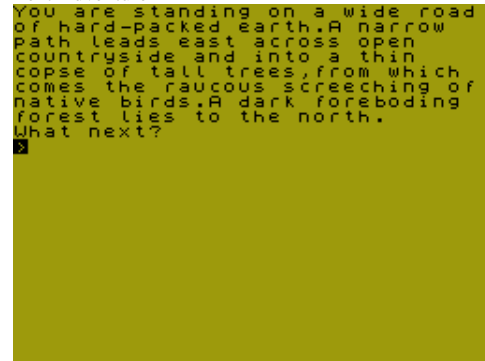

Land of Sagan (Mikro-Gen Ltd,1983)
Arcade Adventure



Lanzadera (MicroHobby,1985)
Arcade



Lap of the Gods (Mastertronic Ltd,1986)
Arcade



Laser Attack (.)
Arcade

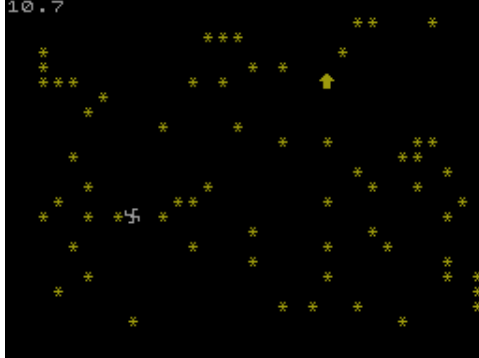

Laser Blast (Impact Software [1],1983)
Arcade



Laser II (Video Showcase,1984)
Arcade

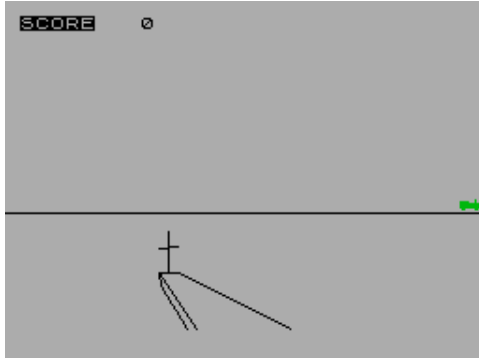

Laser Snaker (Poppy Soft,1983)
Arcade

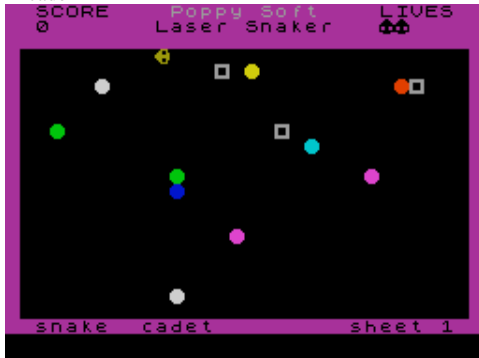

Larry (Luiz Cressoni Filho,1989)
Text Adventure



Laser Attack (Granada Publishing,1983)
Arcade

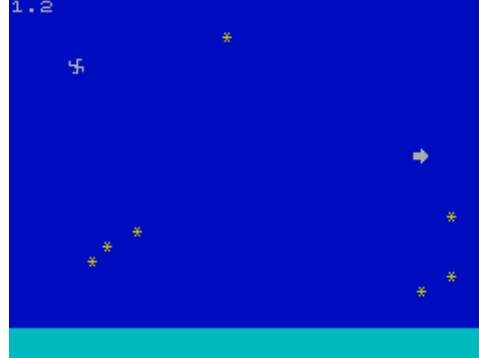

Laser Compiler (Ocean Software Ltd,1986)
Utility



Laser Lander (Cathedral Software,1983)
Arcade



Laser Squad (Blade Software Ltd,1988)
Strategy



Larry the Lemming's Urge for Extinction (Delbert the Hamster Software,1992) Text Adventure

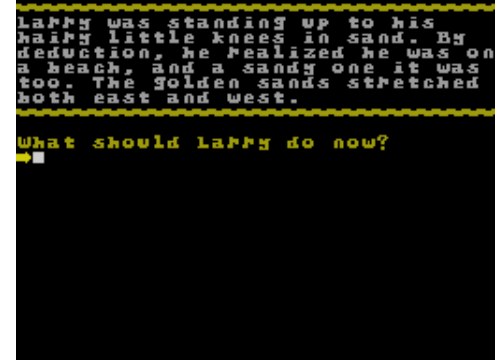

Laser Basic (Ocean Software Ltd,1986)
Utility



Laser Genius (Ocean Software Ltd,1986)
Utility: Programming



Laser Lord (Century City Software Ltd,1985)
Arcade



Laser Squad Expansion Kit One (Julian Gollop,1988)
Strategy



Laser Squad - Remix (Target Games,1988)
Strategy

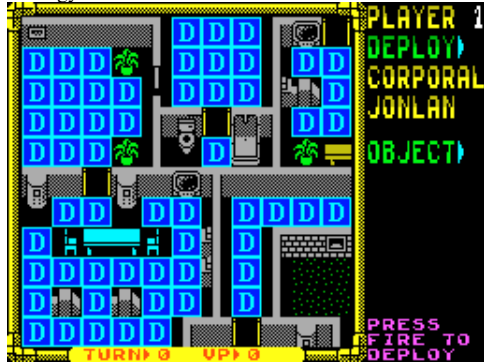

Laserwarp (Mikro-Gen Ltd,1983)
Arcade



Laskar's Return (Zenobi Software,1992)
Text Adventure

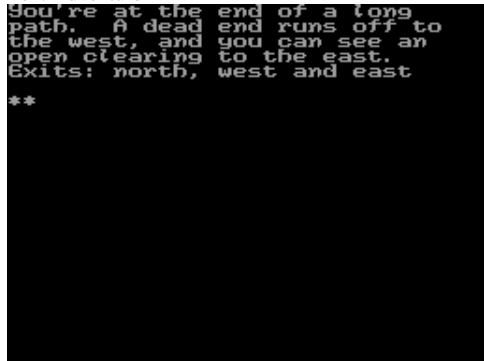

Last Believer, The (The Guild,1991)
Text Adventure

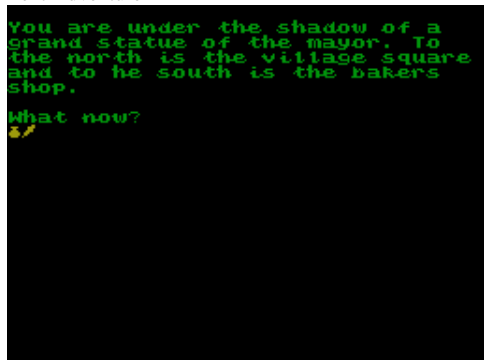

Last Demo, The (Terminator/Tango,1991)
Scene Demo

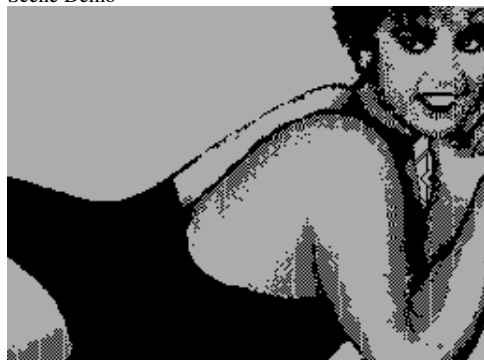

Laser Turret (Sinclair Programs,1984)
Arcade

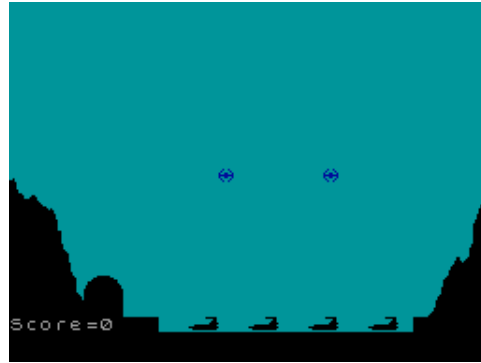

Laser Zone (Quicksilva Ltd,1983)
Arcade



Last Battle (Hackers Squad,1997)
Strategy



Last Courier, The (Perspective Group,1997)
Arcade

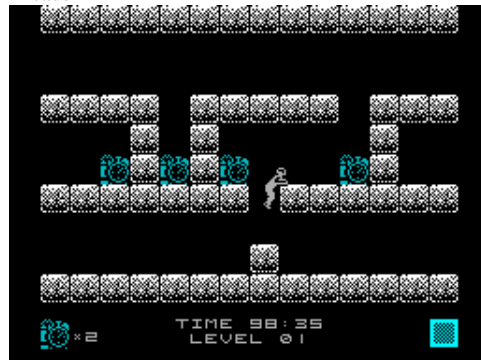

Last Duel (US Gold Ltd,1989)
Arcade

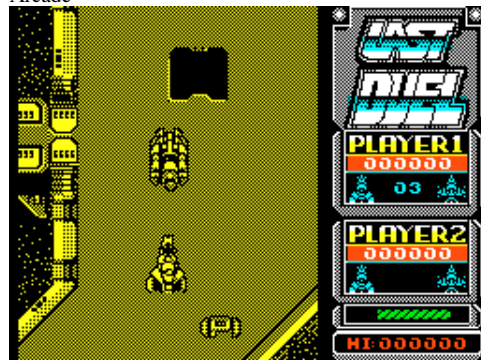

Laser War (Vinssoft,1990)
Arcade

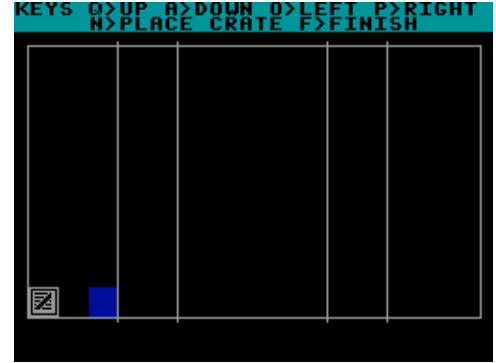

Laskar's Crystals (Zenobi Software,1992)
Text Adventure



Last Battle Mission Editor (Pro Hackers Dynasty,1997)
Arcade Game Development Tool



Last Days of Doom (Topologika,1988)
Text Adventure



Last Hero of The Light Force (Excess Team,1998)
Strategy

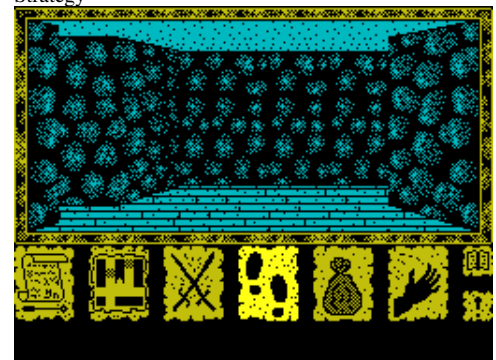

Last Jedi, The (Amazing Games,1984)
Text Adventure



Last Mohican (CRL Group PLC,1987)
Arcade Adventure

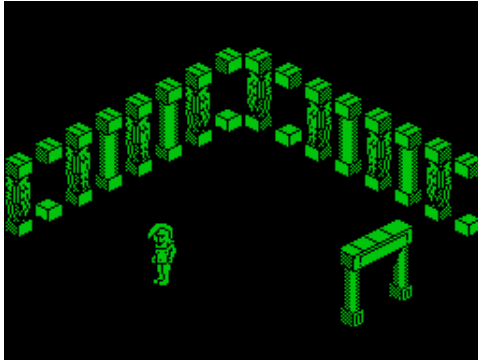

Last Ninja 3 (System 3 Software Ltd.)
Arcade



Last Ship of Zendok, The (Nova Software,1984)
Text Adventure



Last, The (Icabod,1994)
Scene Demo



Last Mission (US Gold Ltd,1987)
Arcade

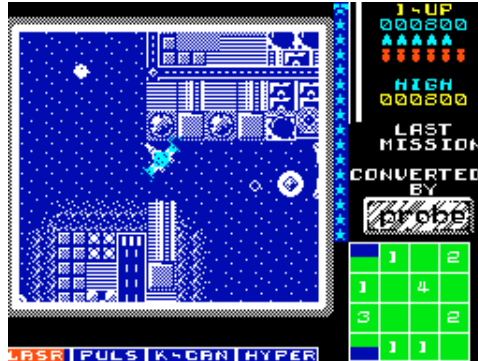

Last Ninja (System 3 Software Ltd.)
Arcade

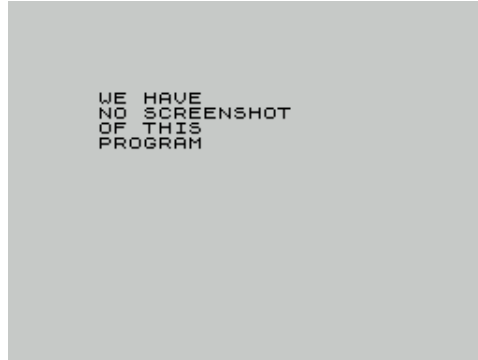

Last Ninja Remix (System 3 Software Ltd,1990)
Arcade Adventure

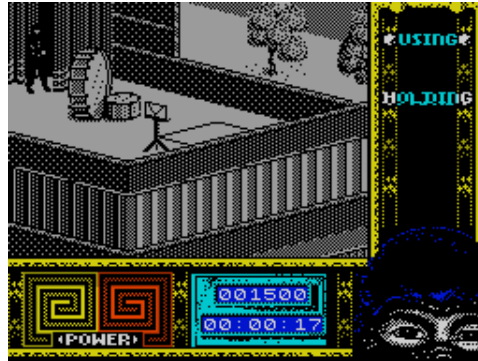

Last Sunset for Lattica (Arcade Software,1983)
Arcade



Last Vampire, The (Atlantis Software Ltd,1990)
Arcade Adventure



Last Mission, The (Opera Soft S.A.,1987)
Arcade



Last Ninja 2 (System 3 Software Ltd,1988)
Arcade Adventure

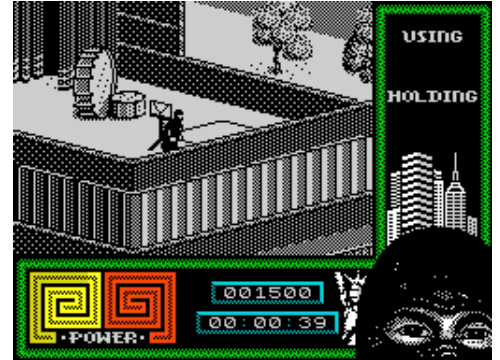

Last of the Big Disks (Zenobi Software,1993)
Compilation



Last, The (E.S.A. Productions,1998)
Scene Demo

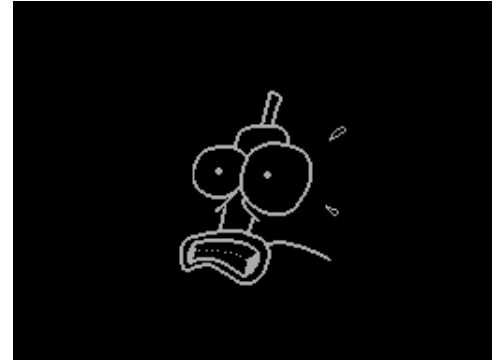

Last Warrior, The (Jorge Peralta/Luis Peralta,1991)
Text Adventure



Last Will and Testament, The (Central Solutions,1984)
Text Adventure

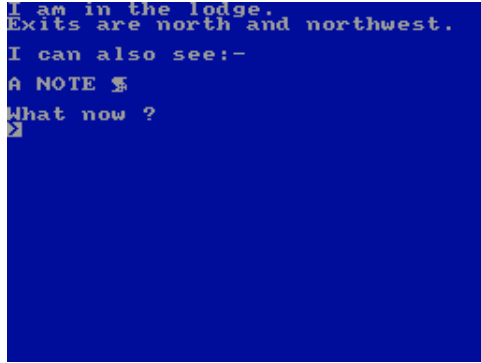

Las Vegas (Temptation Software,1983)
Board/Card Game

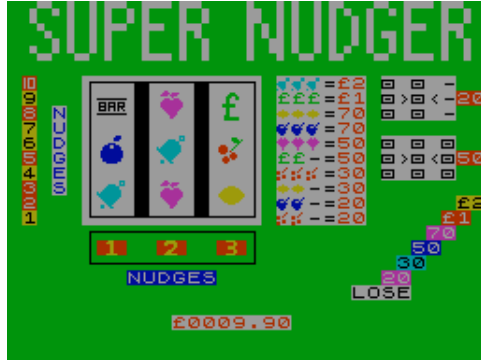

Las Vegas Lady (Mogul Communications Ltd,1983)
Arcade

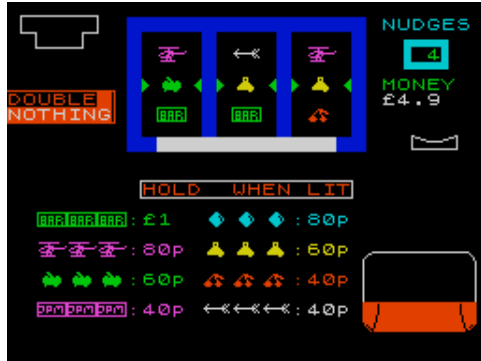

Lawn (Valuesoft,1983)
Arcade



Layout Plotter (Sinclair User,1984)
Utility: BASIC Related

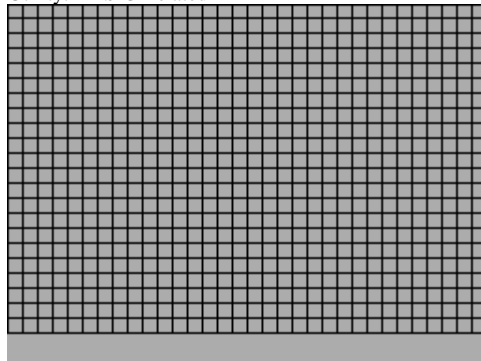

Last Will Dizzy (Oleg Moskalenko,1993)
Arcade Adventure

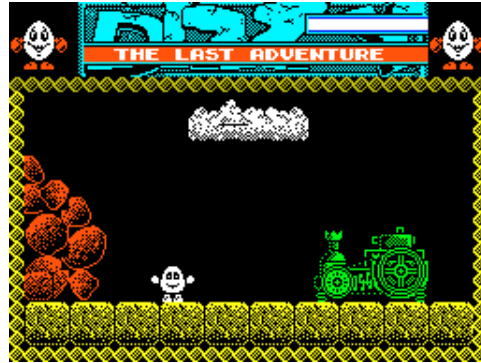

Las Vegas 2 ()
Arcade



Latin Training I (Kerbi Computers,1984)
Educational

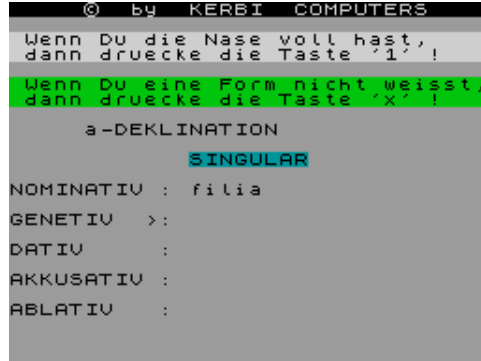

Lawn Mower (Sinclair Programs,1983)
Arcade

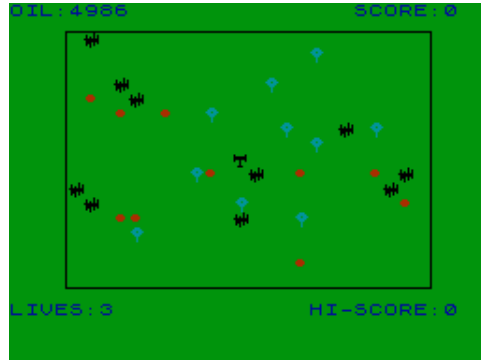

Lazarus (Claw,1998)
Scene Demo

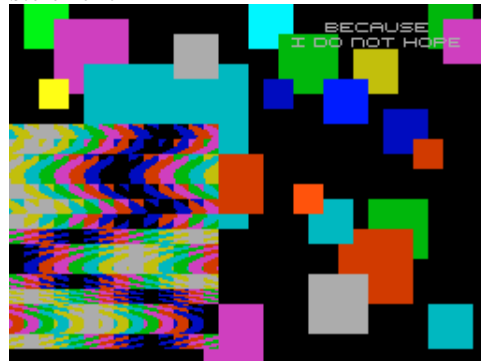

Last Word, The (Myrmidon Software,1985)
Utility: Word Processor



Las Vegas Casino (Zeppelin Games Ltd,1989)
Board/Card Game



Laufschritt ()



Layout 86 (Armin Urban,1986)
Utility: Electronics



Lazatron (Contrast Software,1983)
Arcade



Lazatron + Mazechase (Contrast Software,1983)
Compilation

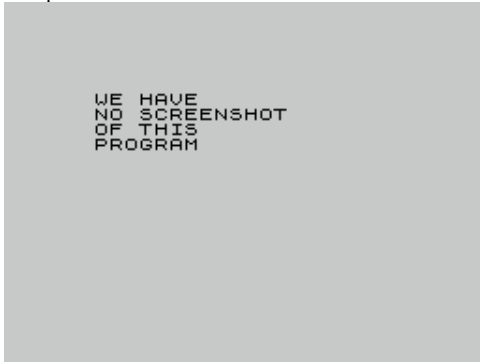

Laze Blaze (Amoeba Software,1983)
Arcade



Lazer Bykes (Wildest Dreams,1984)
Arcade

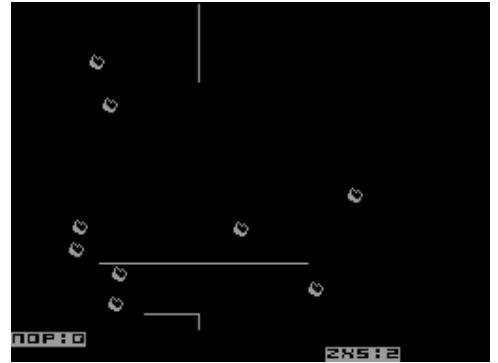

Lazer Defence (.)
Arcade



Lazer Fighter (Darryl LeCount,1993)
Arcade

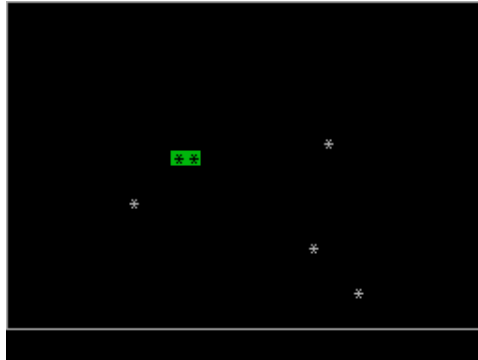

Lazer Fighter 2 (Darryl LeCount,1993)
Arcade

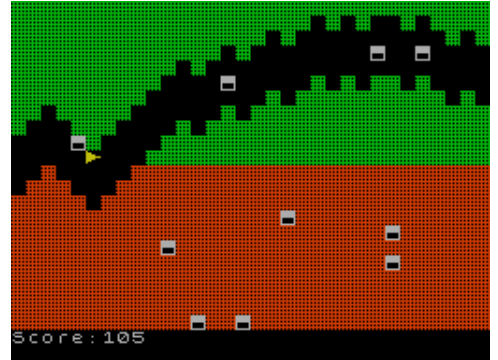

Lazeride (Bosoft,1984)
Arcade



Lazer Tag (Go!,1987)
Arcade

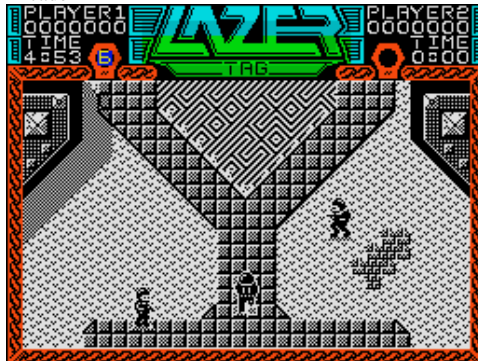

Lazer Wheel (Mastertronic Added Dimension,1987)
Arcade

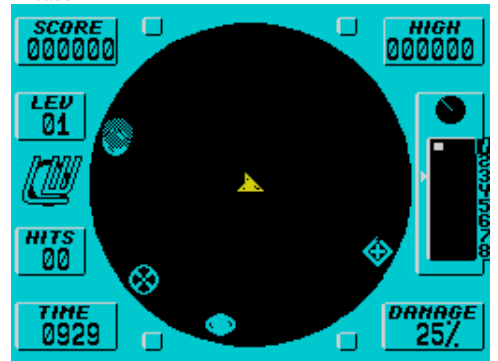

Lazy Jones (Terminal Software,1984)
Arcade



LCopy (INDUG,1988)
Utility



Leader Board (US Gold Ltd,1986)
Sport



Leader Board - Famous Courses of the World Volume 1 (US Gold Ltd,1987) Compilation



Leader Board Par 3 (US Gold Ltd,1988)
Compilation



Leader Board Tournament (US Gold Ltd,1988)
Sport



League Challenge (Atlantis Software Ltd,1988)
Simulation



League Winners (Top Spec,1986)
Simulation



Learn BASIC Programming on the Sinclair ZX Spectrum (Logic 3,1984) Educational
This program displays all the various colours the SPECTRUM can show, and lets you adjust your TV set for the best picture.

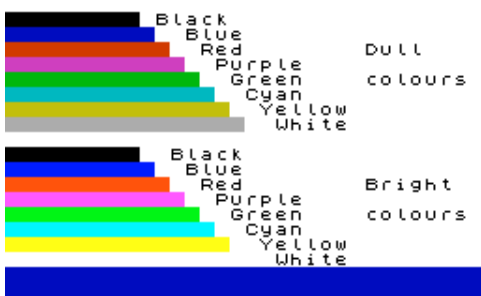

Learning (AVC Software,1982)
Educational

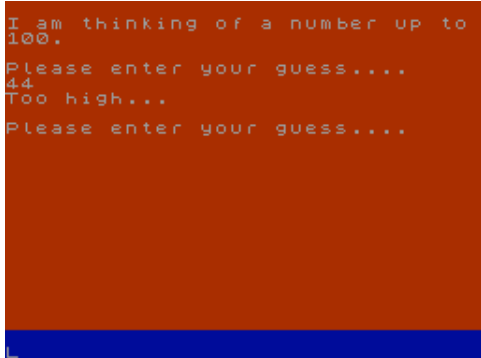

Learn to Play Guitar (Lasersound Ltd,1983)
Educational



League Football (Cult Games,1991)
Simulation

Division	PL	GN	DL	LO	GF	GA	PT
PORTSMOUTH	0	0	0	0	0	0	0
OXFORD UTD	0	0	0	0	0	0	0
HULL CITY	0	0	0	0	0	0	0
WATFORD	0	0	0	0	0	0	0
TORQUAY	0	0	0	0	0	0	0
BURNLEY	0	0	0	0	0	0	0
DONCASTER	0	0	0	0	0	0	0
STOCKPORT	0	0	0	0	0	0	0
DARLINGTON	0	0	0	0	0	0	0
HARTLEPOOL	0	0	0	0	0	0	0
ROCHDALE	0	0	0	0	0	0	0
SCARBOROUGH	0	0	0	0	0	0	0
NALSALL	0	0	0	0	0	0	0
SCUNTHORPE	0	0	0	0	0	0	0
MAIDSTONE	0	0	0	0	0	0	0
CARLISLE	0	0	0	0	0	0	0
HEREFORD	0	0	0	0	0	0	0
GILLINGHAM	0	0	0	0	0	0	0
LINCOLN C	0	0	0	0	0	0	0
LIVERPOOL	0	0	0	0	0	0	0

PRESS ENTER TO CONTINUE:

Leaky Roof (Virgin Books,1983)
Arcade



Learn Chess (Coxsoft,1987)
Educational



Learning to Read Music (Rose Software,1984)
Educational

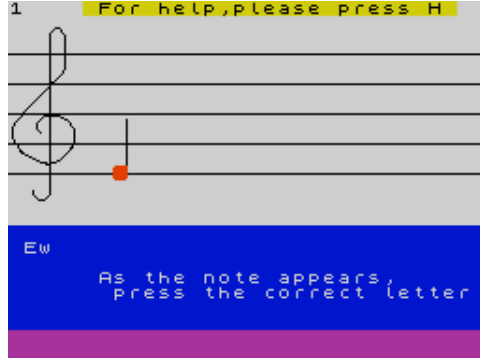

Learn to Program (St. Michael,1983)
Educational

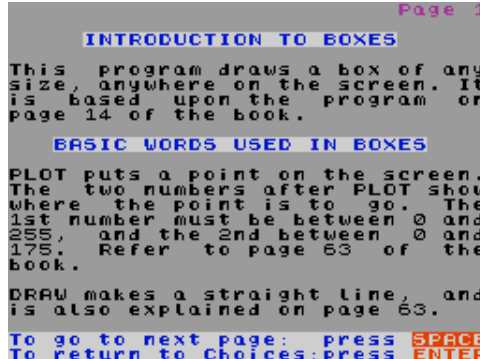

League Table (Hobby Software,1985)
Simulation

1	Everton	2	Spurs
3	Man United	4	Liverpool
5	Arsenal	6	Southampton
7	Chelsea	8	Sheff Wed
9	Notts For	10	Aston U
11	Watford	12	W B A
13	Leicester	14	West Ham
15	Newcastle	16	O P R
17	Luton T	18	Oxford Utd
19	Ipswich	20	Coventry
21	Birmingham	22	Man City

Enter no. of team:

Leapfrog (CDS Microsystems,1983)
Arcade

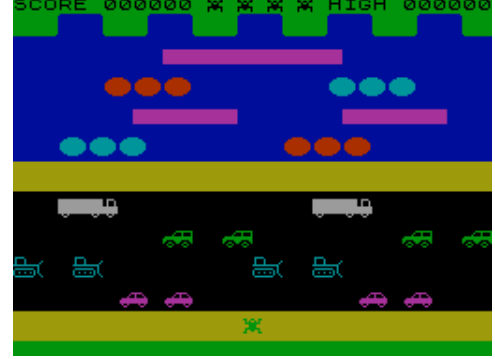

Learner Driver (ZX Computing,1983)
Arcade

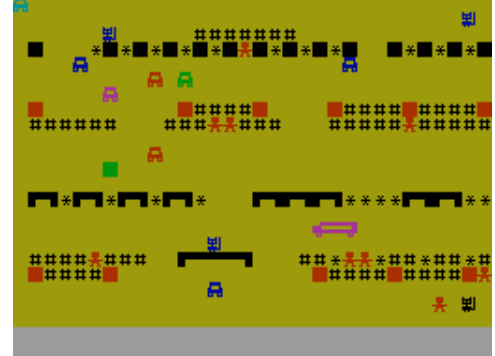

Learning with Leeper (Software Projects Ltd,1985)
Educational

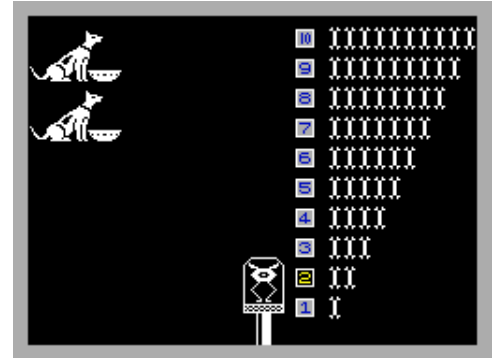

Learn to Read 1 (Macmillan Software Ltd/Sinclair Research Ltd,1983) Educational



Learn to Read 2 (Macmillan Software Ltd/Sinclair Research Ltd,1983) Educational

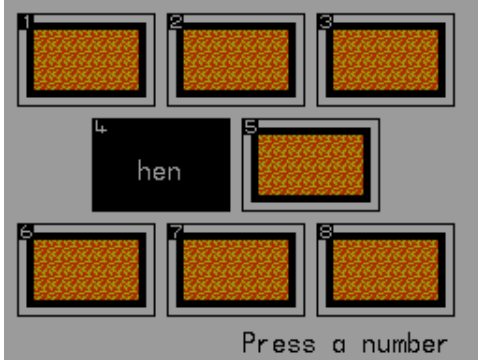

Learn to Read 5 (Macmillan Software Ltd/Sinclair Research Ltd,1983) Educational

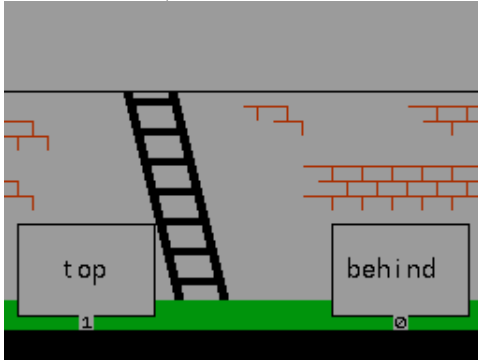

Lector de Cabeceras (Microparadise Software,1984) Utility



Leeds Powerbox (Ashley Greenup,1993) Simulation

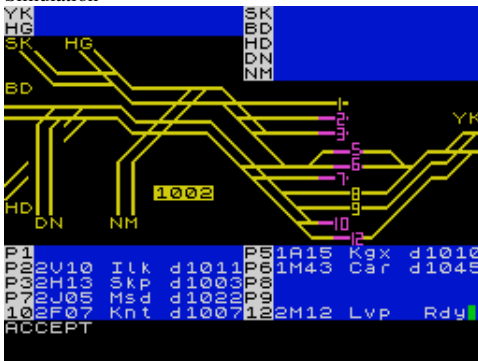

Left Right, Left Right (IEC Software,1986) Educational



Learn to Read 3 (Macmillan Software Ltd/Sinclair Research Ltd,1983) Educational



Learn to Read with Prof - Level 1 (Prisma Software,1990) Educational



Lectura Directa Desde Cinta (MicroHobby,1985) Utility



Lee Enfield Space Ace (Infogrames,1988) Arcade



Legacy (Sierra Charlie 04,1987) Text Adventure

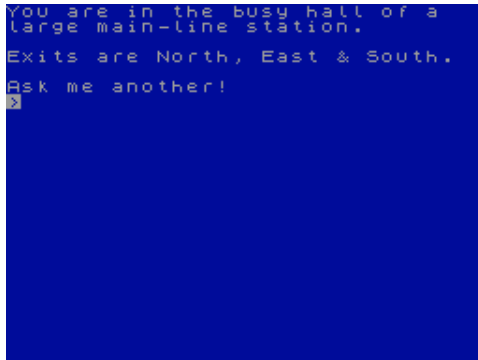

Learn to Read 4 (Macmillan Software Ltd/Sinclair Research Ltd,1983) Educational

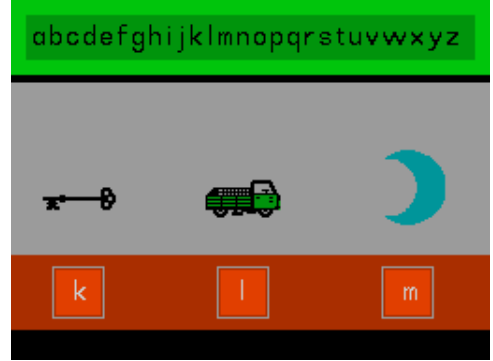

Lebenslauf (,) Utility

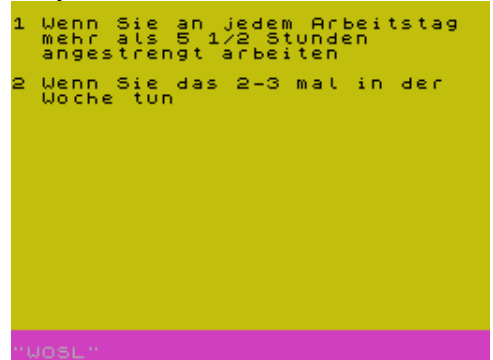

L.E.D. Storm (Go!,1988) Arcade

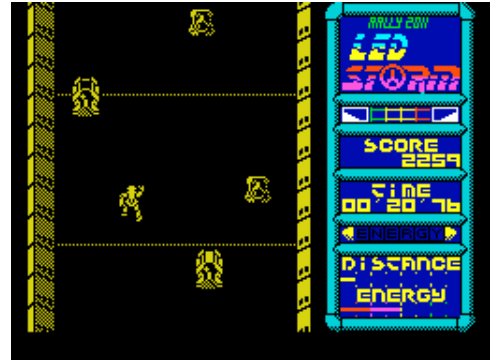

Left and Right (Peak Mathematics,) Educational



Legacy for Alaric, A (Zenobi Software,1989) Text Adventure

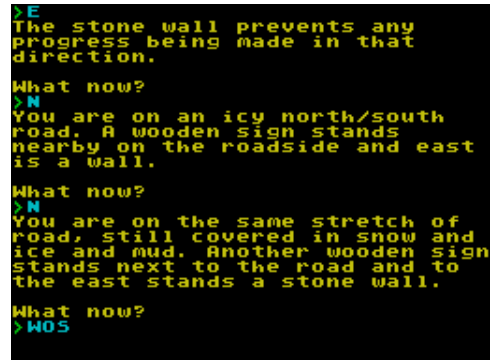

Legacy of Light, The (Mastervision,1985)
Text Adventure

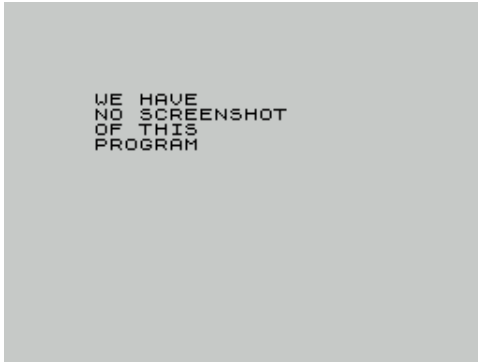

Legacy, The (The PResS Adventure,)
Text Adventure



Legacy, The (Zenobi Software,1990)
Text Adventure



Legend (Century Software [1],1984)
Text Adventure

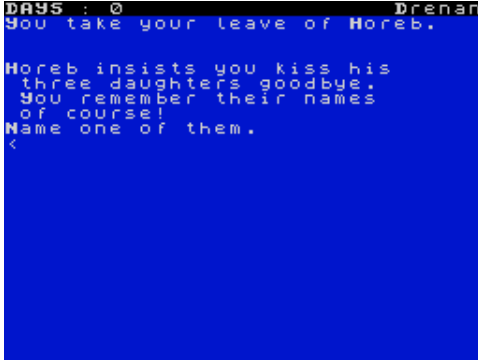

Legend (Zafiro Software Division,1990)
Text Adventure



Legend of Apache Gold, The (Incentive Software Ltd,1986)
Text Adventure



Legend of Claldons Creek, The (Eric Stewart,1987)
Text Adventure



Legend of Kage (Imagine Software Ltd,1986)
Arcade



Legend of the Amazon Women (US Gold Ltd,1986)
Arcade

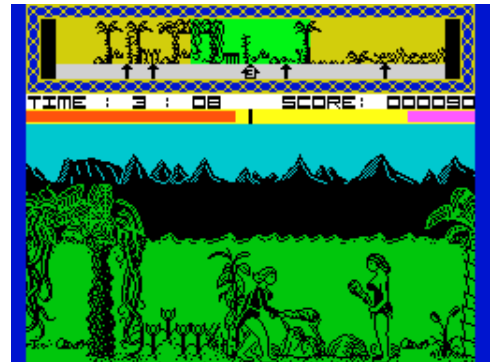

Legend of the Burgle! (XFAWORLD Software,2006)
Arcade



Legend of the Lost Kingdom, The (Dan B. Nielsen,1987)
Text Adventure



Legends of the Land, The (Matija Kostevc,1997)
Strategy



Legion (Alchemist Research,1995)
Scene Demo



Legions of Death (MC Lothlorien Ltd,1987)
Strategy



Legy Bator (Laszlo Nyitrai,1997)
Arcade



Leitin (Fenris Hugbunadur,1989)
Text Adventure



Lenguaje Maquina Spectrum issue 01 (Editorial Foglia)
Covertape



Lenguaje Maquina Spectrum issue 04 (Editorial Foglia,
Covertape



Lenguaje Maquina Spectrum issue 07 (Editorial Foglia,
Covertape



Leningrad 128K Animation Demo (Edlar Agaev,1994)
Scene Demo



Lemmings (Psygnosis Ltd,1991)
Arcade



Lenguaje Maquina Spectrum issue 02 (Editorial Foglia)
Covertape



Lenguaje Maquina Spectrum issue 05 (Editorial Foglia,
Covertape



Lenguaje Maquina Spectrum issue 08 (Editorial Foglia,
Covertape



Lenin in October (Phantom Ltd,1994)
Text Adventure

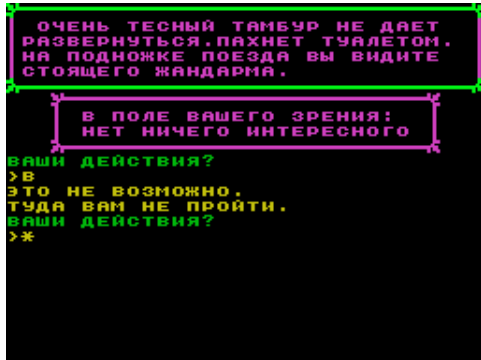

Lemmings Editor (.
Arcade Game Development Tool

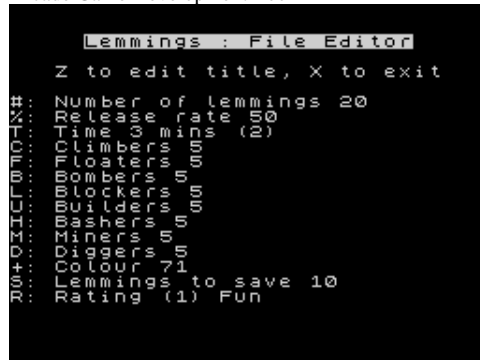

Lenguaje Maquina Spectrum issue 03 (Editorial Foglia)
Covertape



Lenguaje Maquina Spectrum issue 06 (Editorial Foglia,
Covertape



Lenguaje Maquina Spectrum issue 09 (Editorial Foglia,
Covertape



Lensray (16/48 Tape Magazine,1984)
Educational



Leo Contra Todos (Miguel Angel Rodriguez Jodar,2005)



Leopard Lord (Kayde Software Ltd,1983)
Text Adventure



Leprechaun's Gold (ZX Computing,1983)
Arcade

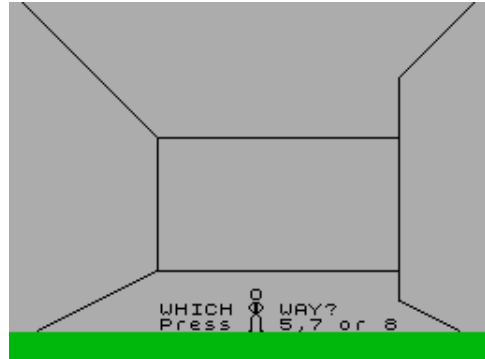

Lerm Bytes Mover (Lerm Software,1985)
Utility: Copier

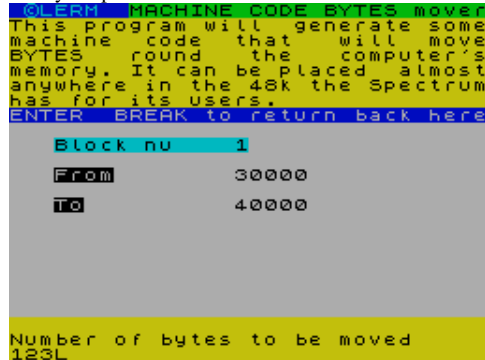

Lerm Minitape (Lerm Software,.)
Utility: Copier

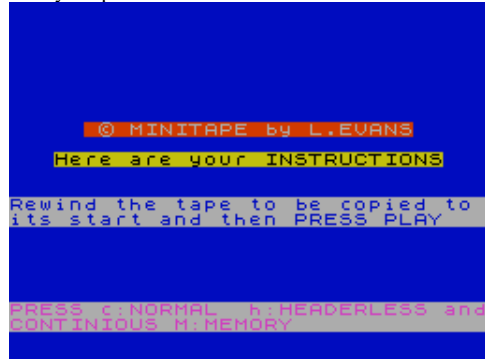

Leonardo (Creative Sparks,1985)
Utility: Drawing



Leopold the Minstrel (Zenobi Software,1994)
Text Adventure

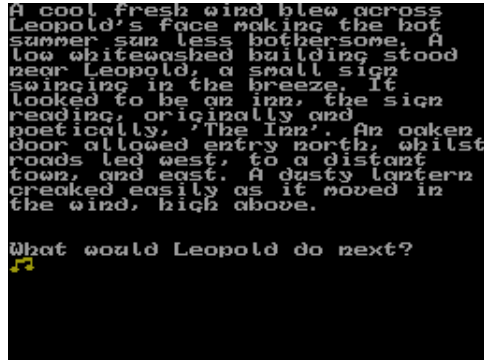

Leprekon (Omega Hackers Group,1998)
Arcade

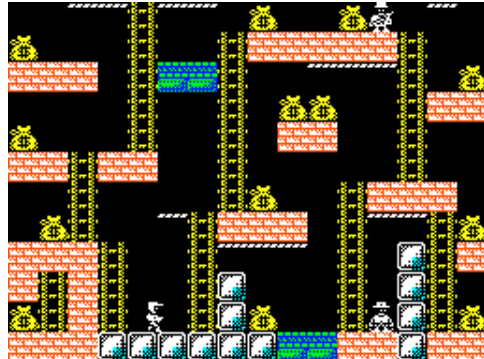

Lerm Conversion Utility 5F (Lerm Software,.)
Utility: Copier



Lerm MM2 (Lerm Software,.)
Utility: Copier



Leonardo (Smash Soft,1993)
Scene Demo



Leo Wanker's Quest (Peeny Pad Software PLC,1984)
Text Adventure

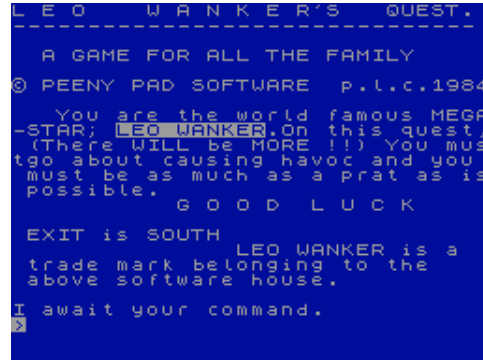

Lerm Advanced Header Reader (Lerm Software,1985)
Utility: Copier

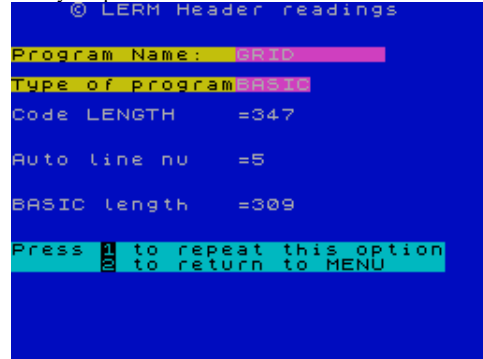

Lerm Header Creator (Lerm Software,1984)
Utility: Copier



Lerm Program Analysis (Lerm Software,1985)
Utility: Copier

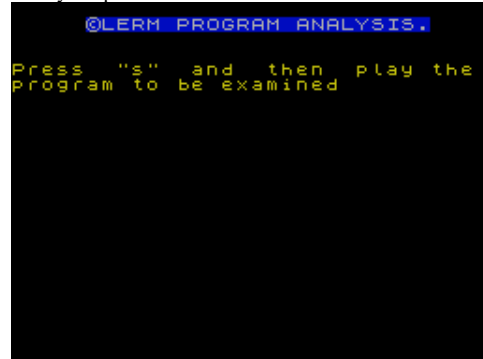

Lerm Run Utility (Lerm Software,)
Utility: Copier



Lerm Tape Copier 5M (Lerm Software,)
Utility: Copier



Lerm Tape Copier 8 (Lerm Software,1986)
Utility: Copier

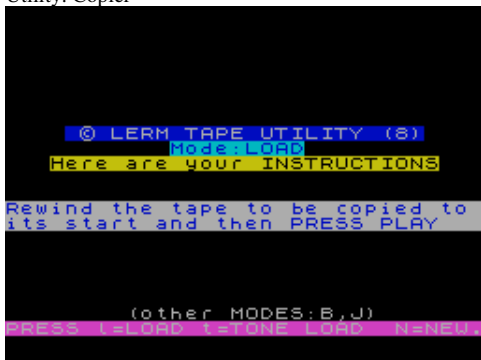

Lerm Tape Utility C (Lerm Software,1988)
Utility: Copier



Lerm Transpack 2 (Lerm Software,1990)
Utility: Copier



Lerm Tape Copier 4.2 (Lerm Software,1983)
Utility: Copier

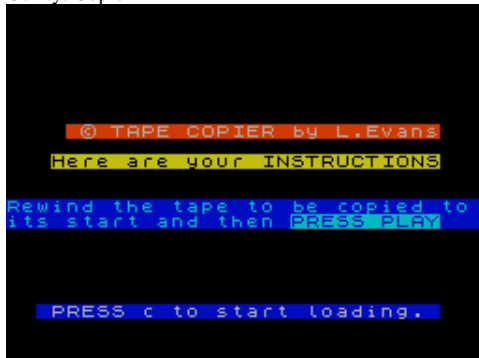

Lerm Tape Copier 6 (Lerm Software,1984)
Utility: Copier

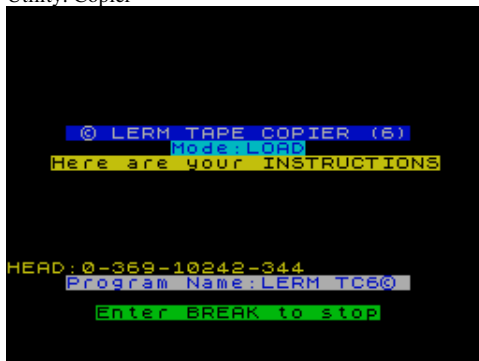

Lerm Tape Utility 9 (Lerm Software,)
Utility: Copier

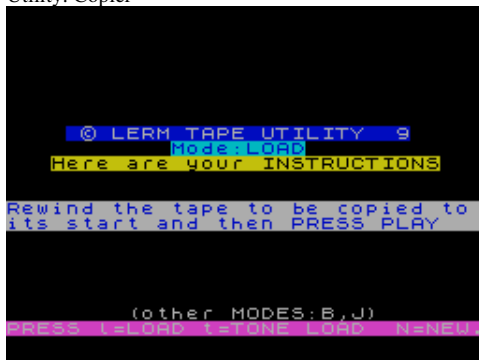

Lerm Tape Utility D (Lerm Software,1988)
Utility: Copier

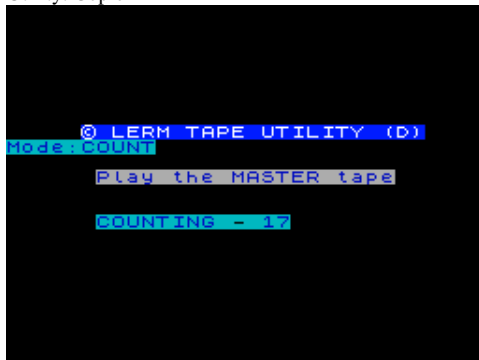

Lernon Esperanto (Lez Peranto Ltd,1986)
Educational



Lerm Tape Copier 5 (Lerm Software,)
Utility: Copier

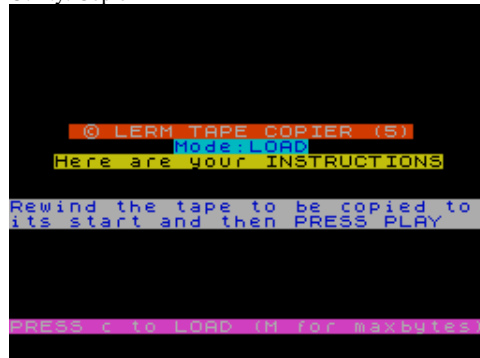

Lerm Tape Copier 7 (Lerm Software,1985)
Utility: Copier



Lerm Tape Utility B (Lerm Software,1988)
Utility: Copier

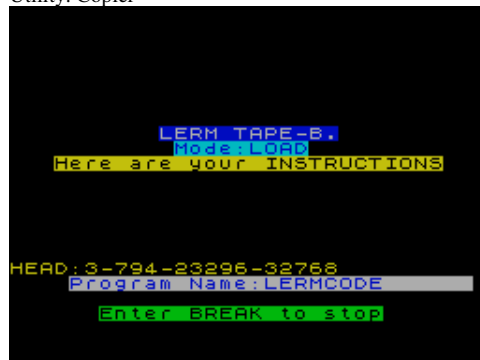

Lerm Transpack (Lerm Software,1989)
Utility: Copier



Les Flics (PSS,1984)
Arcade



Letaset (Eclipse Software,1985)
Utility



Lethargy: The Apathetic Dream (Studio Stall,2003)
Arcade Adventure



Letragorda (MicroHobby,1984)
Utility: Font/UDGs



Letras Gigantes (Microparadise Software,1984)
Utility: Font/UDGs



Letras y Graficos en Tres Dimensiones (MicroHobby,1985)
Utility



Letris (Proxima Software,)
Arcade

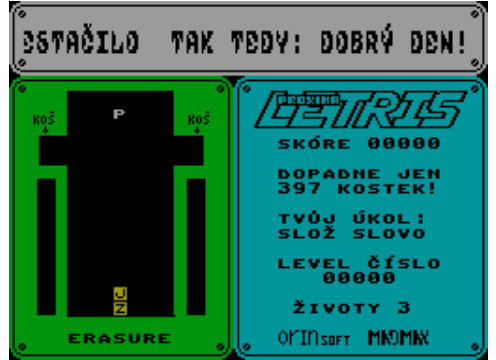

Letta-Head (Bradway Software,1985)
Utility



Letta-Head Plus (Bradway Software,1985)
Utility



Letter Bomb (River Software,1988)
Board/Card Game



Letterbox (Byron Software,1987)
Arcade



Letterfont (Allanson Computing,1984)
Utility



Letter Number Puzzle (16/48 Tape Magazine,1984)
Board/Card Game



Letters (Chalksoft Ltd,1984)
Educational



Letter Set (Alpha Computer Products,1987)
Utility



Letter Writer (Teacher's Pet Software,1988)
Educational



Let There Be Drums (Fudgepacker,1996)
Scene Demo

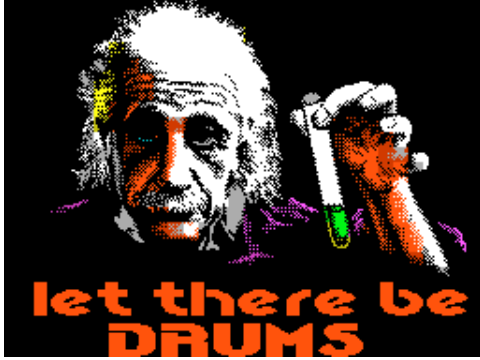

Ley del Mas Fuerte, La (PASA Soft,1989)
Text Adventure



L-Game (Taurus Computer Design,1982)
Board/Card Game



Liberator (Lyversoft,1984)
Arcade



Library of PCG Clip Art - Disc 32 (PCG Software,)
Utility



Level 5 (Mastertronic Ltd,1987)
Arcade



LFLIPI (Outlet Microdrive Magazine,1989)
Utility



Liba128K (NyitraiSOFT,2004)
Arcade



Liberator (Proein Soft Line,1989)
Arcade

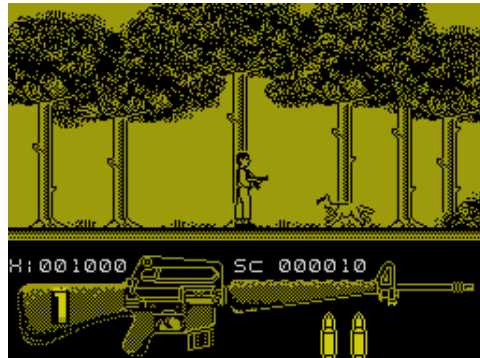

Libreria de Software Spectrum issue 01 (Grupo de Trabajo Software S.A.,1985) Covertape



Leviathan (English Software,1987)
Arcade



L-Game (Quicksilva Ltd,1982)
Board/Card Game

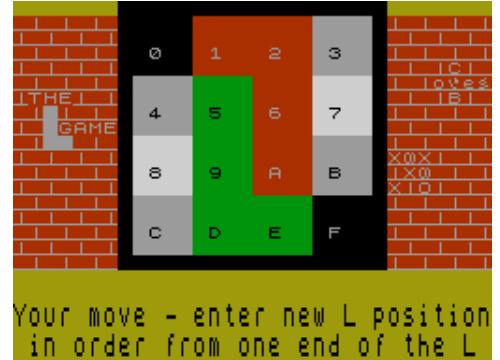

Liberator (Crash,1990)
Arcade



Library of PCG Clip Art - Disc 30 (PCG Software,)
Utility



Libreria de Software Spectrum issue 02 (Grupo de Trabajo Software S.A.,1985) Covertape

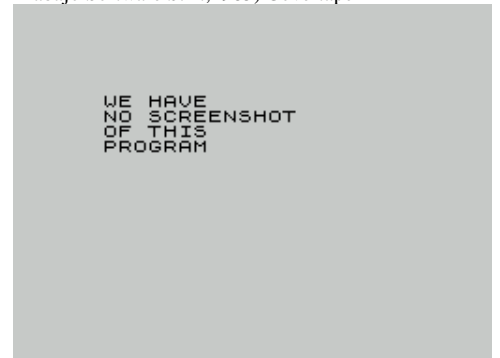

Libreria de Software Spectrum issue 03 (Grupo de Trabajo Software S.A.,1985) Covertape

```
WE HAVE  
NO SCREENSHOT  
OF THIS  
PROGRAM
```

Libreria de Software Spectrum issue 04 (Grupo de Trabajo Software S.A.,1985) Covertape

```
WE HAVE  
NO SCREENSHOT  
OF THIS  
PROGRAM
```

Libreria de Software Spectrum issue 05 (Grupo de Trabajo Software S.A.,1985) Covertape

```
WE HAVE  
NO SCREENSHOT  
OF THIS  
PROGRAM
```

Libreria de Software Spectrum issue 06 (Grupo de Trabajo Software S.A.,1985) Covertape

```
WE HAVE  
NO SCREENSHOT  
OF THIS  
PROGRAM
```

Libreria de Software Spectrum issue 07 (Grupo de Trabajo Software S.A.,1985) Covertape

```
WE HAVE  
NO SCREENSHOT  
OF THIS  
PROGRAM
```

Libreria de Software Spectrum issue 08 (Grupo de Trabajo Software S.A.,1985) Covertape

```
WE HAVE  
NO SCREENSHOT  
OF THIS  
PROGRAM
```

Libreria de Software Spectrum issue 09 (Grupo de Trabajo Software S.A.,1985) Covertape

```
WE HAVE  
NO SCREENSHOT  
OF THIS  
PROGRAM
```

Libreria de Software Spectrum issue 10 (Grupo de Trabajo Software S.A.,) Covertape

```
WE HAVE  
NO SCREENSHOT  
OF THIS  
PROGRAM
```

Libreria de Software Spectrum issue 11 (Grupo de Trabajo Software S.A.,) Covertape

```
WE HAVE  
NO SCREENSHOT  
OF THIS  
PROGRAM
```

Libreria de Software Spectrum issue 12 (Grupo de Trabajo Software S.A.,) Covertape

```
WE HAVE  
NO SCREENSHOT  
OF THIS  
PROGRAM
```

Libreria de Software Spectrum issue 13 (Grupo de Trabajo Software S.A.,) Covertape

```
WE HAVE  
NO SCREENSHOT  
OF THIS  
PROGRAM
```

Libreria de Software Spectrum issue 14 (Grupo de Trabajo Software S.A.,) Covertape

```
WE HAVE  
NO SCREENSHOT  
OF THIS  
PROGRAM
```

Libreria de Software Spectrum issue 15 (Grupo de Trabajo Software S.A.,) Covertape

```
WE HAVE  
NO SCREENSHOT  
OF THIS  
PROGRAM
```

Libreria de Software Spectrum issue 16 (Grupo de Trabajo Software S.A.,) Covertape

```
WE HAVE  
NO SCREENSHOT  
OF THIS  
PROGRAM
```

Libreria de Software Spectrum issue 17 (Grupo de Trabajo Software S.A.,1987) Covertape

```
WE HAVE  
NO SCREENSHOT  
OF THIS  
PROGRAM
```

Libreria de Software Spectrum issue 18 (Grupo de Trabajo Software S.A.,1987) Covertape

```
WE HAVE
NO SCREENSHOT
OF THIS
PROGRAM
```

Libreria de Software Spectrum issue 19 (Grupo de Trabajo Software S.A.,1987) Covertape

```
WE HAVE
NO SCREENSHOT
OF THIS
PROGRAM
```

Libreria de Software Spectrum issue 20 (Grupo de Trabajo Software S.A.,1987) Covertape

```
WE HAVE
NO SCREENSHOT
OF THIS
PROGRAM
```

Libreria de Software Spectrum issue 21 (Grupo de Trabajo Software S.A.,1987) Covertape

```
WE HAVE
NO SCREENSHOT
OF THIS
PROGRAM
```

Libreria de Software Spectrum issue 22 (Grupo de Trabajo Software S.A.,1987) Covertape

```
WE HAVE
NO SCREENSHOT
OF THIS
PROGRAM
```

Libreria de Software Spectrum issue 23 (Grupo de Trabajo Software S.A.,1987) Covertape

```
WE HAVE
NO SCREENSHOT
OF THIS
PROGRAM
```

Libreria de Software Spectrum issue 24 (Grupo de Trabajo Software S.A.,1987) Covertape

```
WE HAVE
NO SCREENSHOT
OF THIS
PROGRAM
```

Libreria de Software Spectrum issue 25 (Grupo de Trabajo Software S.A.,1987) Covertape

```
WE HAVE
NO SCREENSHOT
OF THIS
PROGRAM
```

Libreria de Software Spectrum issue 26 (Grupo de Trabajo Software S.A.,1987) Covertape

```
WE HAVE
NO SCREENSHOT
OF THIS
PROGRAM
```

Libro de Compras (Computer Software,1983) Utility

```
WE HAVE
NO SCREENSHOT
OF THIS
PROGRAM
```

Libro de Krown, El (Jose Antonio Fernandez Seguido,1989) Text Adventure

```
WE HAVE
NO SCREENSHOT
OF THIS
PROGRAM
```

Libro de Ventas (Computer Software,) Utility

```
WE HAVE
NO SCREENSHOT
OF THIS
PROGRAM
```

Libro Negro, El (Year Zero Software,1989) Text Adventure



Licence to Kill (Domark Ltd,1989) Arcade



Licensed to Chip (Futuresoft,) Text Adventure

```
WE HAVE
NO SCREENSHOT
OF THIS
PROGRAM
```

Lichtorgel (S&G Software,1984)
Utility

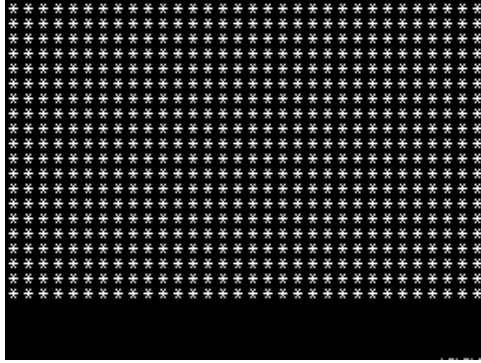

Life (Sinclair Research Ltd,1982)
Educational



Life (Supervisor,1997)
Board/Card Game

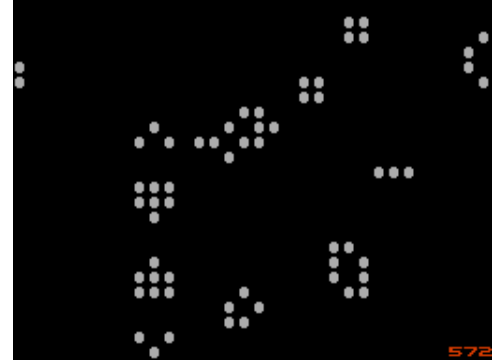

Lifeboat (River Software,1987)
Text Adventure

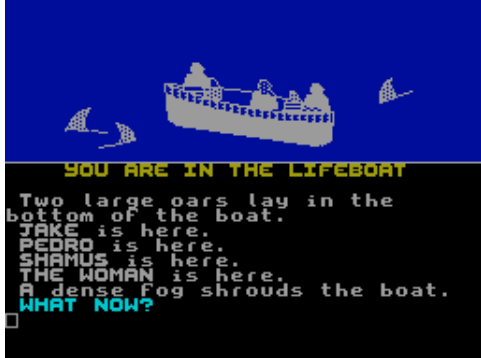

Life Force (CRL Group PLC.)
Arcade



Lifeguard (Romantic Robot UK Ltd,1987)
Utility

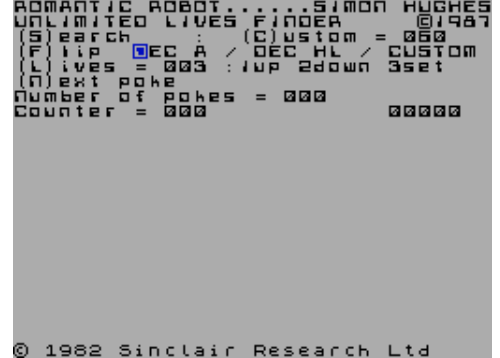

Lifeline (MC Lothlorien Ltd,1984)
Arcade



Lifeline (William Stuart Systems Ltd,1985)
Educational

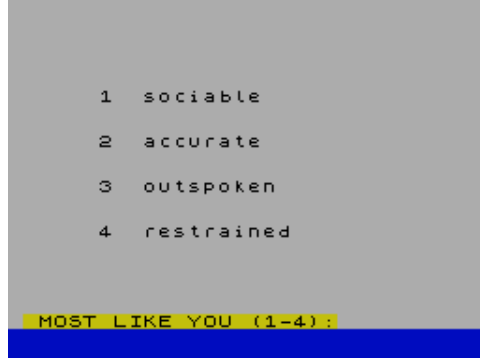

Life of a Lone Electron, The (Zenobi Software,1994)
Text Adventure

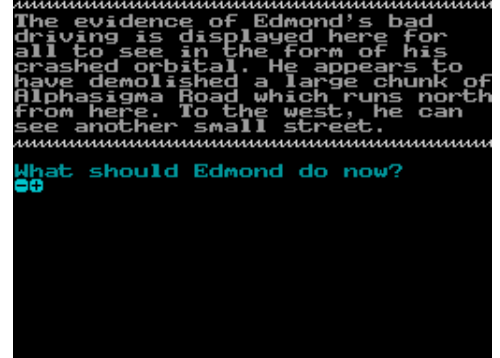

Life of Crime, A (G. Palin.)
Text Adventure



Life of Harry, The (Cascade Games Ltd,1985)
Arcade



Life-Term (Alternative Software Ltd,1987)
Text Adventure



Lifetime (.)
Text Adventure



Light and Sound Volume 10 (Theo Devil.)
Scene Demo

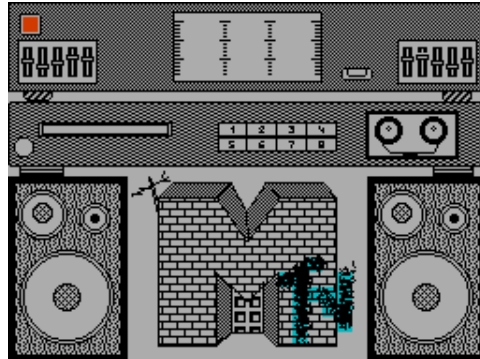

Light and Sound Volume 2 (Theo Devil.)
Scene Demo



Light and Sound Volume 3 (Theo Devil,)

Scene Demo

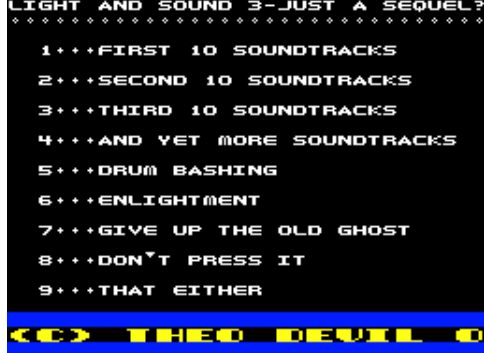

Light Cycle (PSS,1983)

Arcade



Lightforce (Mastertronic Added Dimension,1986)

Arcade



Lightly Fields (Magic Moon,1997)

Board/Card Game

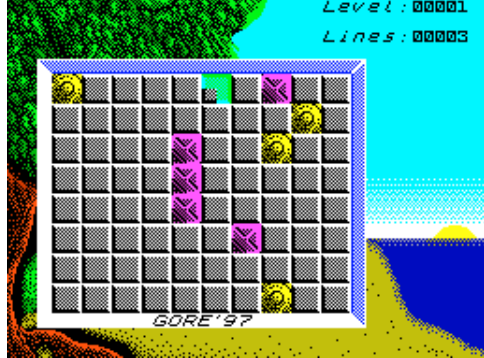

Lightning Simulator (Silverbird Software Ltd,1988)

Simulation



Light and Sound Volume 4 (Theo Devil,)

Scene Demo



Lightcycle (Spectrum Computing,1984)

Arcade

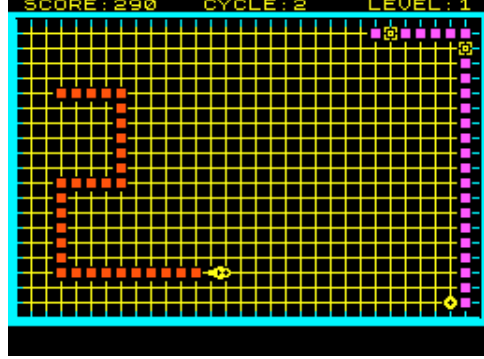

Light Force (Faster Than Light,1986)

Arcade



Light Magic (New Generation Software,1985)

Utility



Light Pen (Apina,1985)

Utility

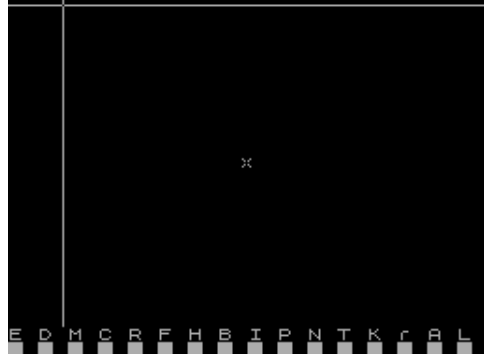

Light Corridor, The (Infogrames,1990)

Arcade

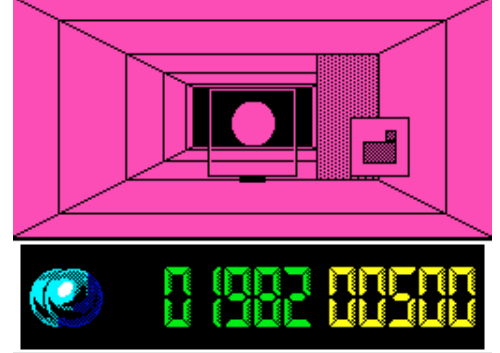

Light Cycle II (Rumatisoft,1992)

Arcade



Lightgun Games (Mastertronic Ltd,1989)

Compilation



Lightmare (Scott Johnston,1989)

Text Adventure



Light Show (Ziga Turk,1984)

Utility

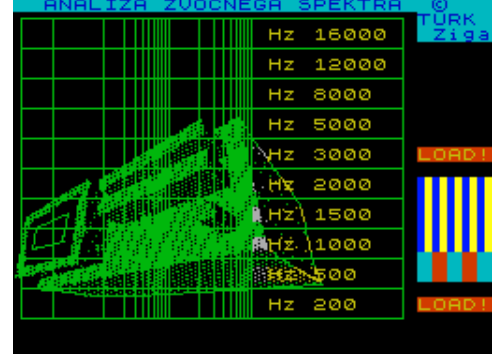

Light the Conk (Dominic Morris,1991)
Arcade

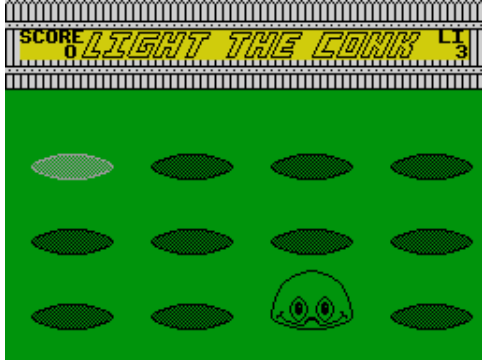

Limehouse Mystery + Survivor, The (Global Games [1],1989)

Compilation



Limited Overs (Micromor,1983)
Arcade



Line Plot (.)
Utility: Drawing



Linez (Extacy-3,1993)
Scene Demo



Lightwriter (Datel Electronics,1988)
Utility

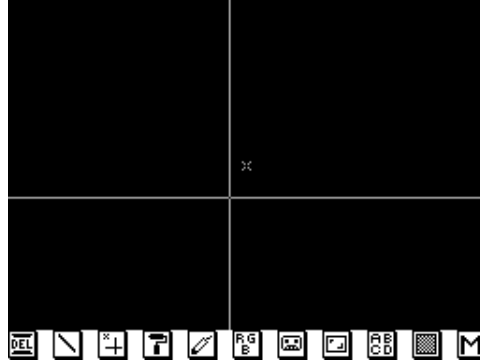

Limehouse Mystery, The (Global Games [1],1989)
Text Adventure



Lindrick (Hornby Software,1983)
Sport



Liner 67, The (Cesar Hernandez Bano,1994)
Utility



Lingote, El (Erbe Software S.A.)
Compilation

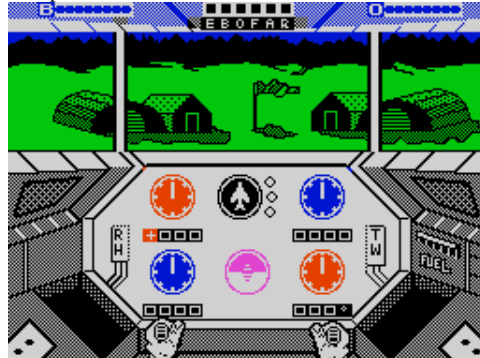

Lila Diva (Hands On Software,1984)
Board/Card Game



Limited Edition Chart Attack (US Gold Ltd.)
Compilation



Line of Fire (US Gold Ltd,1990)
Arcade



Lines, The (Hacker Demon,1992)
Scene Demo



Link Four (Spectrum Computing,1985)
Board/Card Game



Linkword French (Silversoft Ltd,1984)
Educational

```

The FRENCH for

RABBIT is LAPIN
(LAPAHn)

Imagine a rabbit LAPPING at a
bowl of water

<SPACE>to wait<ENTER>to continue

```

Linnet (Spectre,1983)

Utility: Electronics

CURRENT NETWORK TITLE: -

*****null*****

```

Type b to begin anew
e to execute analysis
c to change input data
o to run output routines
r to redefine analysis type
p to LPRINT input data
s to save program & state
q to quit program
"WOSL"

```

Lissajous (MicroHobby,1985)

Utility

```

WE HAVE
NO SCREENSHOT
OF THIS
PROGRAM

```

Listfile 3 (ZX-Guaranteed,1986)

Utility

```

WE HAVE
NO SCREENSHOT
OF THIS
PROGRAM

```

Listvars (16/48 Tape Magazine,1984)

Utility

```

WE HAVE
NO SCREENSHOT
OF THIS
PROGRAM

```

Linkword German (Silversoft Ltd,1984)
Educational

```

You will be presented with
words like this:

The German for
GENTLEMEN
is
HERREN (HERREN)

Imagine a large HERRING
dangling from the door of a
gentlemen's toilet.

What you do is to imagine this
picture in your mind's eye as
vividly as possible.

Press ENTER to continue.

```

Lin-O-Type (Bradway Software,1987)

Utility

```

WE HAVE
NO SCREENSHOT
OF THIS
PROGRAM

```

Listador de Cintas (MicroHobby,1984)

Utility

```

WE HAVE
NO SCREENSHOT
OF THIS
PROGRAM

```

Listin Telefonico (Microparadise Software,1984)

Utility

```

WE HAVE
NO SCREENSHOT
OF THIS
PROGRAM

```

Little Al (Sparklers,1987)

Arcade



Linkword Spanish (Silversoft Ltd,1984)
Educational

```

The Spanish for
CAT is GATO
(GATO)

Imagine a cat eating a large
GATEAU.

Press SPACE or ENTER.

```

LISP Interpreter (Serious Software,1983)

Utility: Programming

```

Speclisp 1.3
© 1983 Serious Software
Made in England
#WOS

```

Listfile (ZX-Guaranteed,1983)

Utility

```

CHAR 1 LISTFILE BLOCK 1

[BRASEPRINTTAPEDRIVENEWMENTINFO]
"C"

```

List Scroll (.)

Utility: BASIC Related

```

ON

TO START SCROLL ENTER: -
RANDOMIZE USR 32339
TO STOP SCROLL ENTER: -
RANDOMIZE USR 32397
TO PAUSE SCROLL PRESS: -
SYMBOL SHIFT TOGETHER WITH SPACE

PRESS ANY KEY TO SAVE
@ OK, @:1

```

Little Beau (Digital Magic Software,1991)

Arcade

```

WE HAVE
NO SCREENSHOT
OF THIS
PROGRAM

```

Little Boxes (Contrast Software,1983)
Board/Card Game

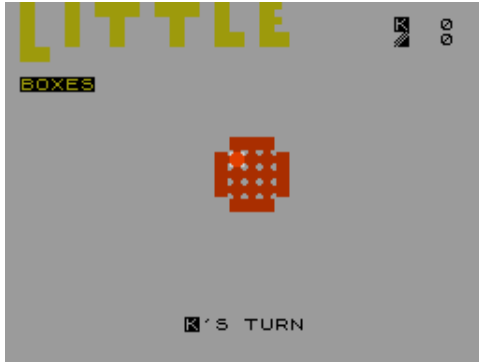

Little Demons: The Angel Hunt (XFAWORLD Software,2006)
Arcade



Little Miss Candymouth (Digital Design,1987)
Scene Demo

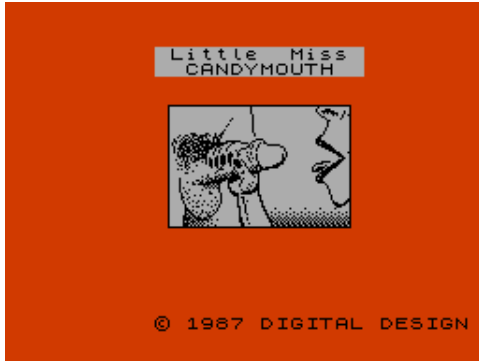

Little Puff (Cartoon Time,1990)
Arcade



Live and Let Die (Domark Ltd,1988)
Arcade



Little Computer People (Activision Inc,1986)
Arcade Adventure



Little Game (Satansoft,1987)
Arcade



Little Pac (.)
Arcade



Little Wandering Guru (Zenobi Software,1990)
Text Adventure



Live Demo Part I (Terminator,1990)
Scene Demo



Little Demo (Dynamite Duo.)
Scene Demo



Little Joke (The Lords,1989)
Scene Demo

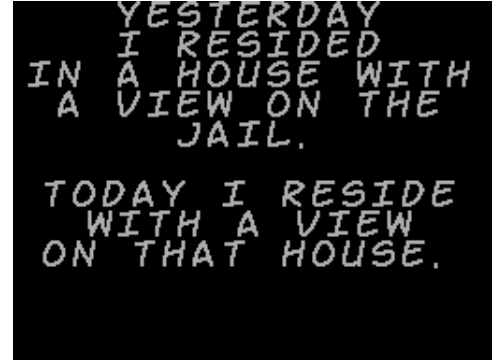

Little Pac II (Jujstronic,1984)
Arcade

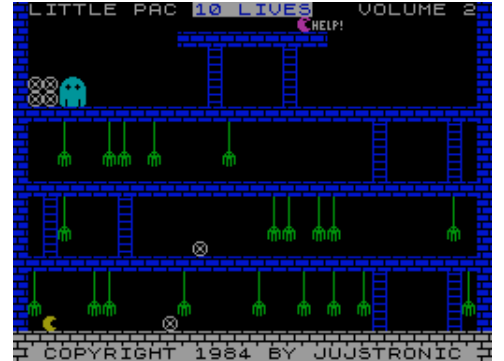

Live Ammo (Ocean Software Ltd,1987)
Compilation



Liverpool (D. Corbishley,1986)
Strategy



Liverpool (Grandslam Entertainments Ltd,1990)
Sport



Living Daylights, The (Domark Ltd,1987)
Arcade



Livingstone Supongo II (Opera Soft S.A.,1989)
Arcade



Load (Tomas Vlcek,1985)
Utility: Copier

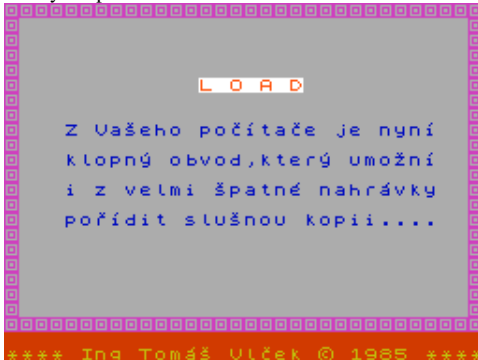

Loads of Laurence Vol. 1 (Zenobi Software,1996)
Compilation



Live Wire (16/48 Tape Magazine,1985)
Arcade

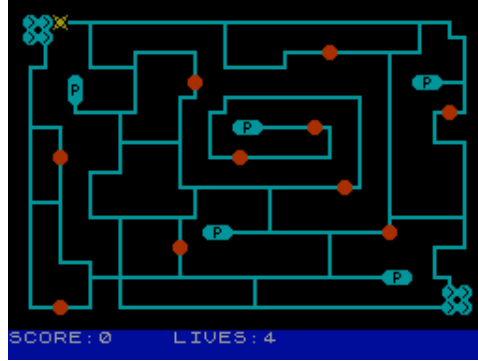

Living Shit, The (Kassoft,)
Scene Demo



Ilaves, Las (MicroHobby,1985)
Arcade



Load 48K (ZX-Power,1983)
Utility

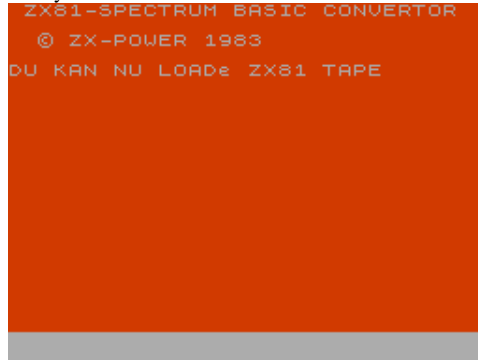

Loads of Laurence Vol. 2 (Zenobi Software,1996)
Compilation



Living Body, The (Martech Games Ltd,1986)
Educational

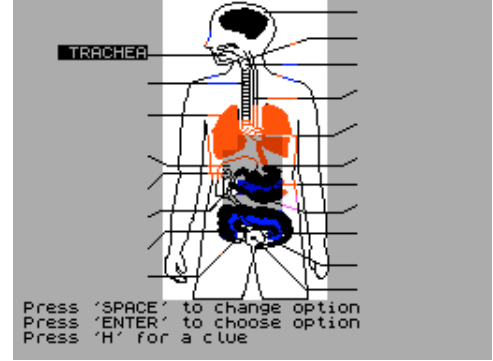

Livingstone Supongo (Opera Soft S.A.,1987)
Arcade



LLIST 642 (Radio Student,1984)
Utility: BASIC Related

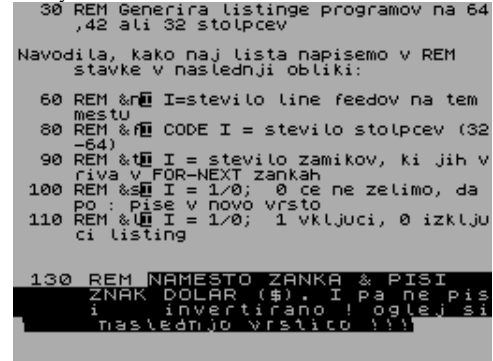

Loader (.)
Utility: Copier

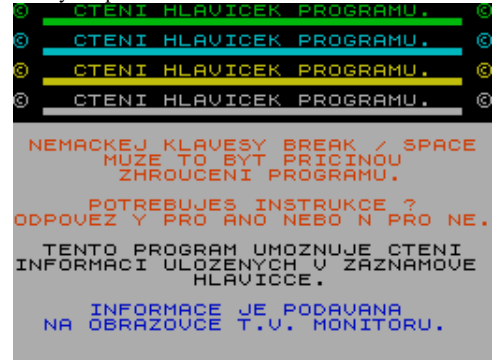

Loads of Midnight (CRL Group PLC,1987)
Text Adventure



Loch Ness Monsters (Romik Software,)
Arcade

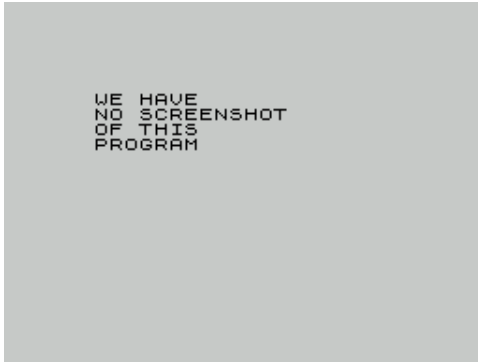

Lock-Save (Individual Software,1985)
Utility: Copier



Loco (Alligata Software Ltd,1986)
Arcade



Loco (Campbell Systems,1983)
Board/Card Game

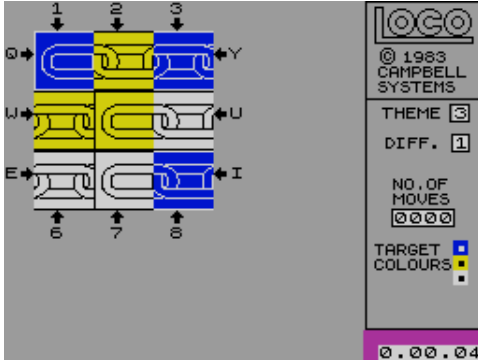

Loco Bingo (Cronosoft,2005)
Board/Card Game

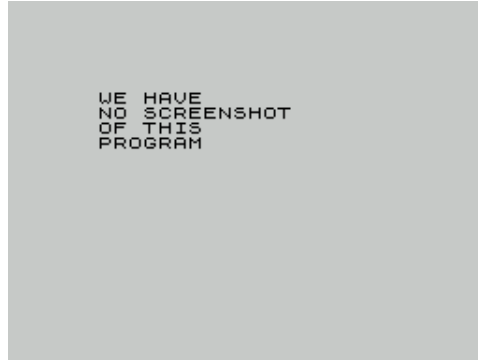

Locodriver (Ashley Greenup,1987)
Simulation

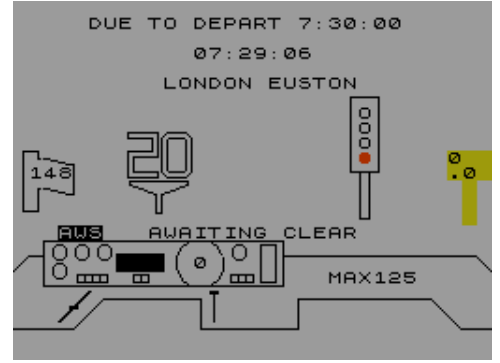

Locodriver 10 (Ashley Greenup,1989)
Simulation



Locodriver 11 (Ashley Greenup,1989)
Simulation

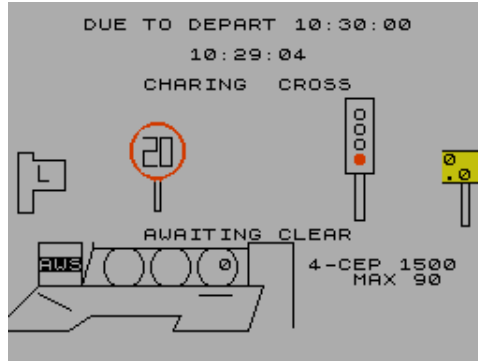

Locodriver 2 (Ashley Greenup,1987)
Simulation

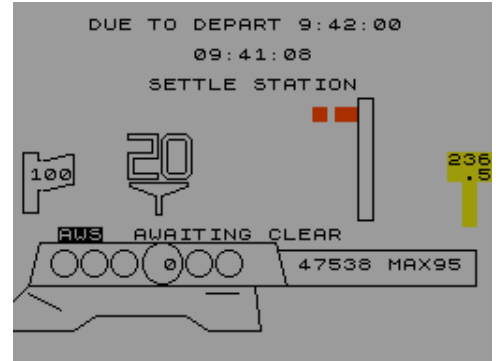

Locodriver 3 (Ashley Greenup,1987)
Simulation



Locodriver 4 (Ashley Greenup,1988)
Simulation



Locodriver 5 (Ashley Greenup,1988)
Simulation



Locodriver 6 (Ashley Greenup,1988)
Simulation



Locodriver 7 (Ashley Greenup,1988)
Simulation



Locodriver 8 (Ashley Greenup,1988)
Simulation

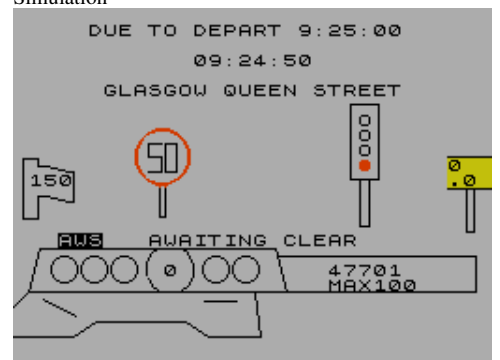

Locodriver 9 (Ashley Greenup,1988)
Simulation

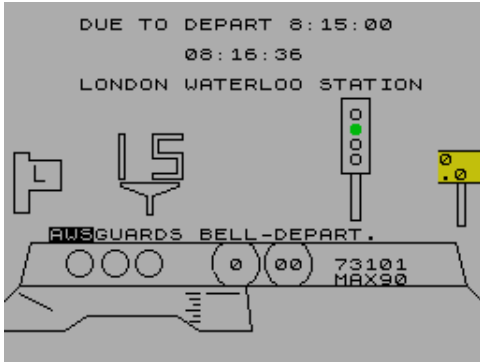

Loco Motion (Amazon Systems,1984)
Arcade



Lode Runner (Software Projects Ltd,1984)
Arcade



Lodicky (Handsoft,1987)
Arcade



Logic 1 (Technotime,1994)
Scene Demo



Loco, El (The Lords,1990)
Scene Demo



Loco-Motion (Mastertronic Ltd,1985)
Arcade

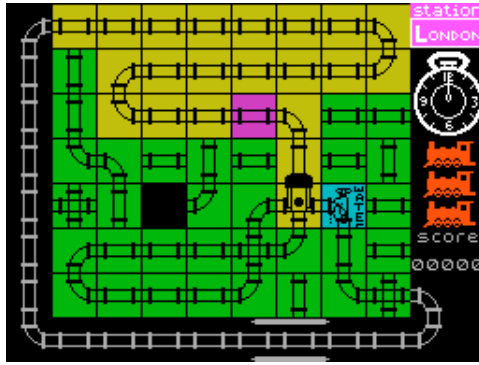

Lode Runner 3 (Biotech Software Inc,1995)
Arcade

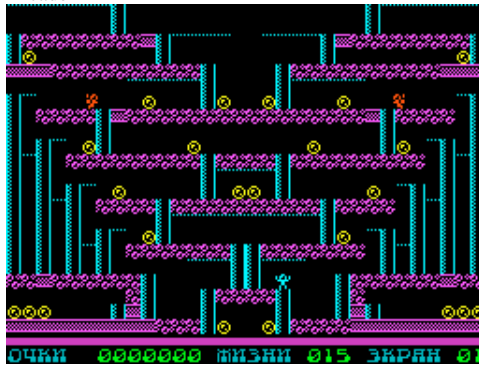

Logic (Scisoft,)
Utility: Mathematics

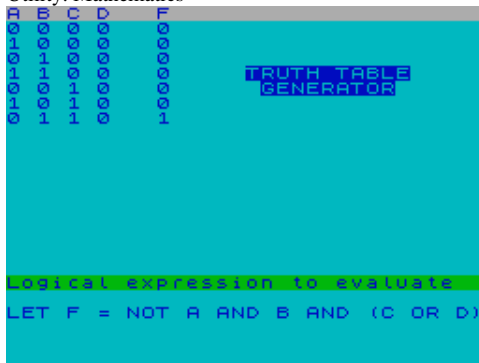

Logic 2 (Technotime,1994)
Scene Demo



Locofile (Seymour Systems,)
Simulation

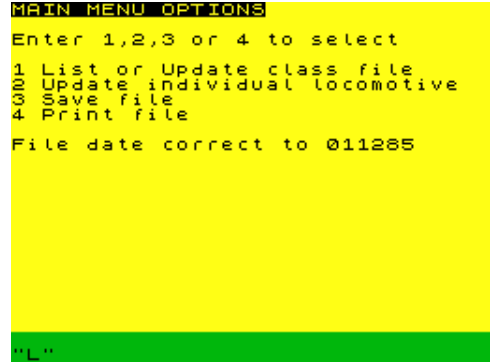

Locospotter (Ashley Greenup,1988)
Simulation



Lode Runner (New game set) (Software Projects Ltd,1984)
Arcade

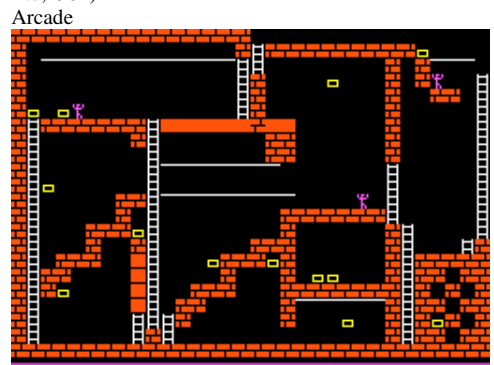

Logic (Ultrasoft,1990)
Board/Card Game



Logical Game (Peter Machala,1990)
Board/Card Game



Logic Games Collection (V. Minevsky,1995)
Board/Card Game

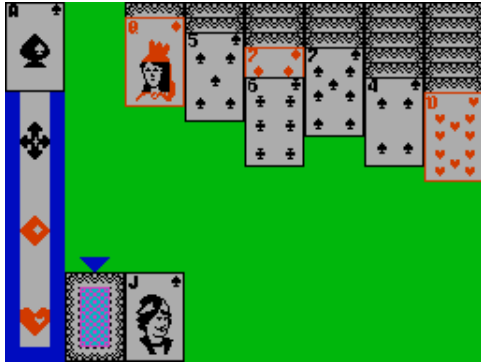

Logic Processor, The (Scisoft,1984)
Utility: Mathematics

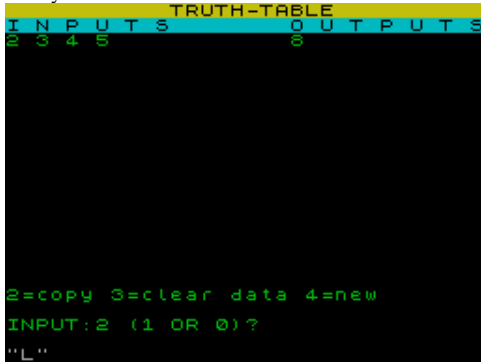

Logo (GCE Tutoring,1984)
Educational



Logo (Rainbow Dreams,1990)
Board/Card Game

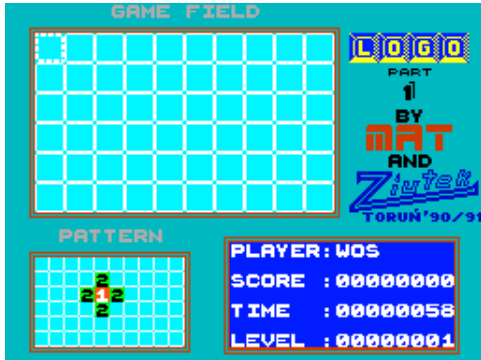

Lollipop (The Knuckle Girls,1994)
Scene Demo

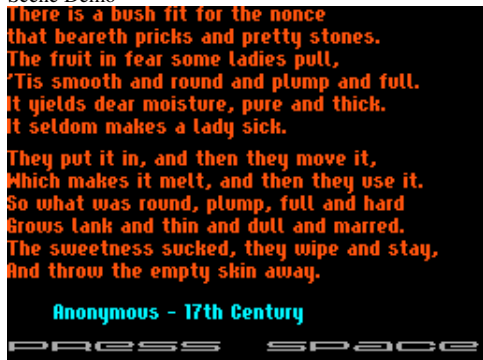

Logic II, The (Kassoft,1989)
Scene Demo

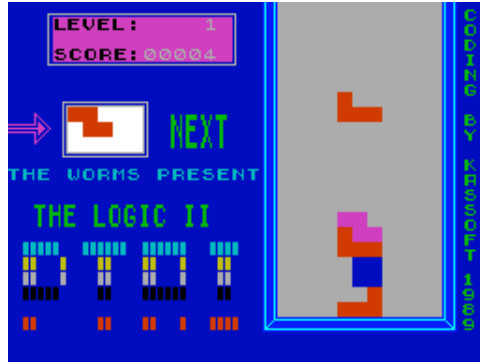

Logicube (R'n'H Microtec,1988)
Arcade



Logo (Kuma Computers Ltd,1984)
Utility: Programming

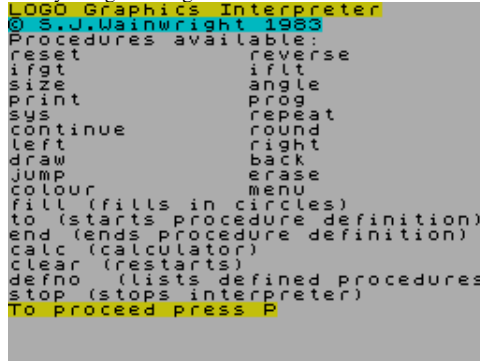

Logo Castellano (Ioshua S.A.,1985)
Educational

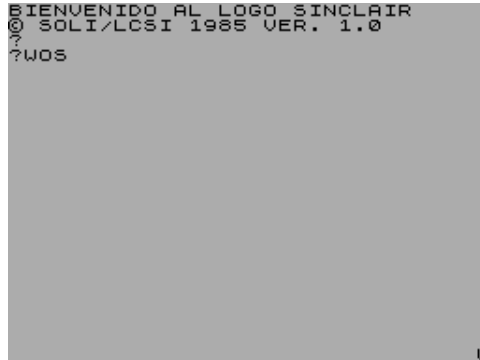

Lollipop: The Second Spunker (The Knuckle Girls,1995)
Scene Demo

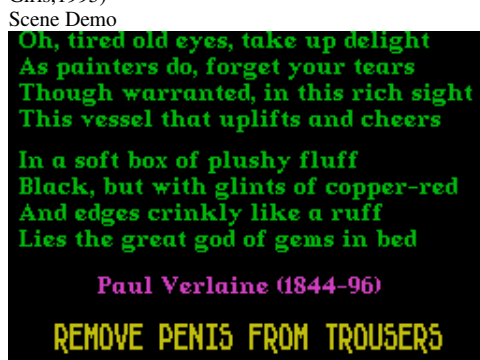

Logic Levels (Fisher-Price Learning Software,1984)
Educational

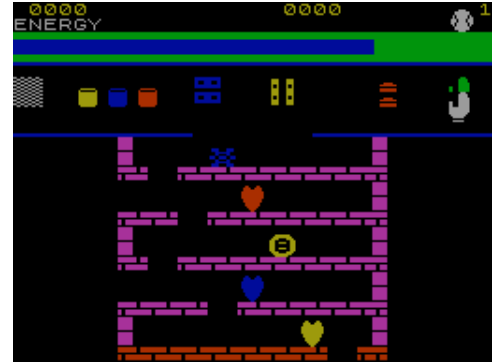

Logic V, The (Wojtus,1991)
Scene Demo

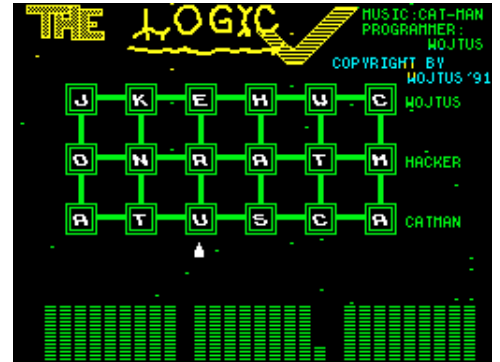

Logo (MicroHobby,1985)
Utility



Lojix (Virgin Games Ltd,1983)
Board/Card Game

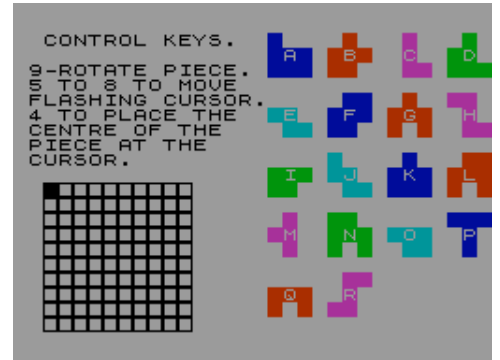

Lombrix (ERE Informatique,1984)
Arcade



Lo Mejor de Dinamic (Dinamic Software,1988)
Compilation



Lone Attacker (Sinclair Programs,1984)
Arcade



Long Division (Calpac Educational Software,1983)
Educational

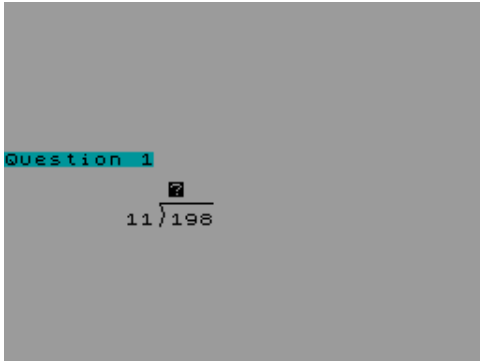

Long Way Home Volume 1 (16/48 Tape Magazine,1984)
Text Adventure



Look for the Pyramid's Treasure (Adventure Writer,1992)
Text Adventure



London Adventure (Fridaysoft,1985)
Text Adventure

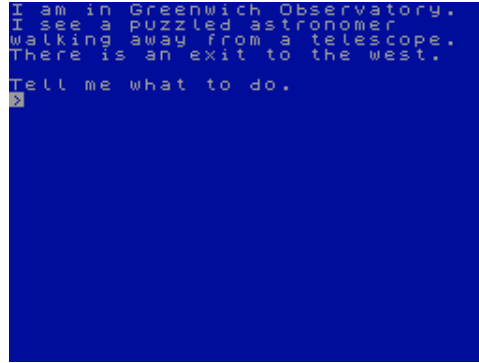

Lone Brave (.)
Text Adventure



Long Journey Home, The (unpublished.)
Text Adventure

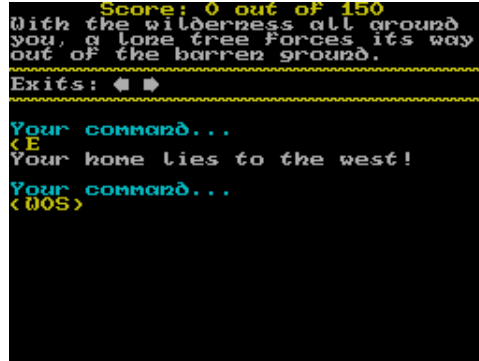

Long Way Home Volume 2: The Ludoids (16/48 Tape Magazine,1985) Text Adventure



Look Sharp! (Mirrorsoft Ltd,1984)
Educational

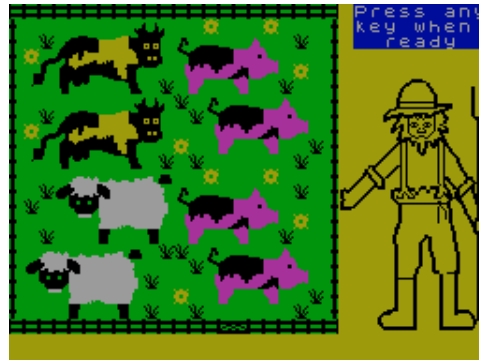

London Rally (.)
Arcade



Lone Wolf - The Mirror of Death (Audiogenic Software Ltd,1991) Arcade Adventure

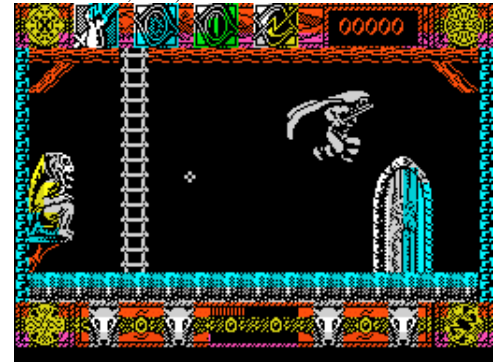

Long Turbo Copy (.)
Utility: Copier

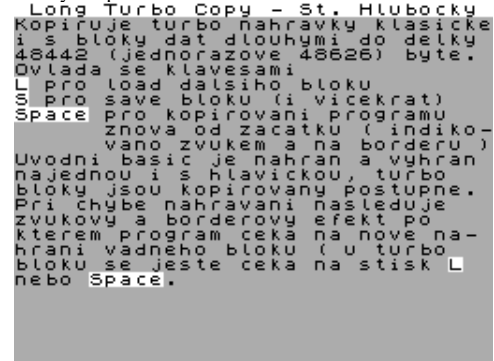

Look at All the Pretty Lights (Chris Ridings,1992)
Text Adventure



Loony Bin (Buffer Micro Ltd,1984)
Text Adventure



Loony Castle Quest, The (Futuresoft,1989)
Text Adventure



Looped Loop (.)
Arcade



Loopz Collection, The (Audiogenic Software Ltd,1991)
Compilation



Lord Bromley's Estate (Domark Ltd,1990)
Arcade



Lord of the Rings (Melbourne House,1986)
Text Adventure



Loony Lander (Software Super Savers Ltd,1984)
Arcade



Loop Synthesizer (Claus Jahn,1987)
Utility: Music Creation

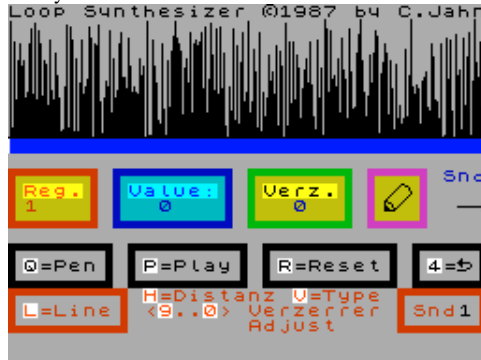

Loose Ends (Zenobi Software,1995)
Text Adventure

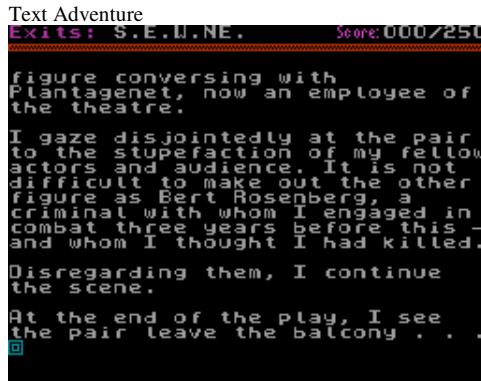

Lord Harry (Lotus-Soft,1984)
Arcade



Lords Demo 2, The (Wise Man/Cat Man,1990)
Scene Demo

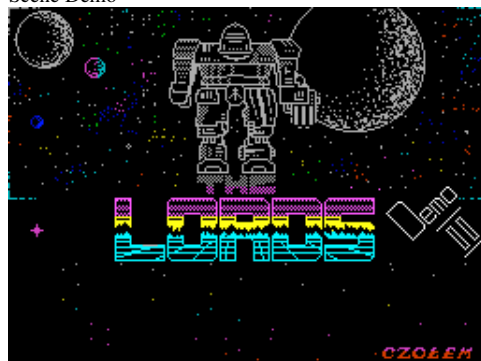

Loony Zoo (Phipps Associates,1983)
Arcade



Loopz (Audiogenic Software Ltd,1990)
Arcade

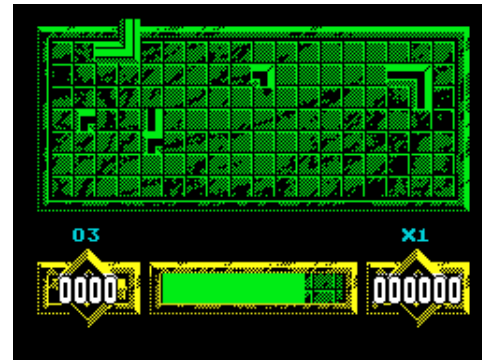

Lop Ears (Players Software,1991)
Arcade Adventure



Lord of Darkness (Triumph Game Labs,2003)
Text Adventure

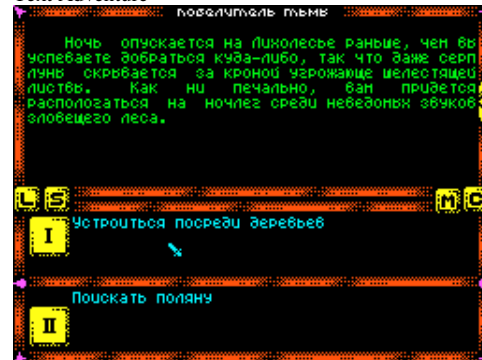

Lords Demo, The (Wise Man/Cat Man,1990)
Scene Demo



Lords of Chaos (Blade Software Ltd,1990)
Strategy



Lords of Midnight Editor, The (PDT,1984)
Arcade Game Development Tool



Lorigraph (Loricels,1985)
Utility: Drawing

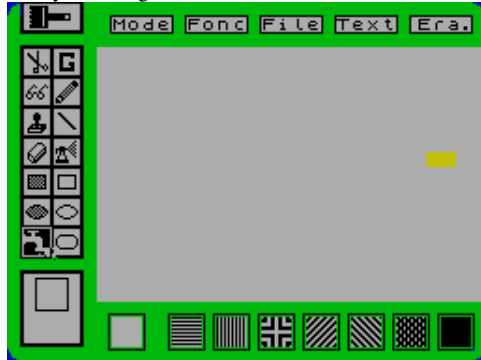

Lost (Virgin Games Ltd,1983)
Arcade



Lost Children, The (Adventure Probe Software,1997)
Text Adventure

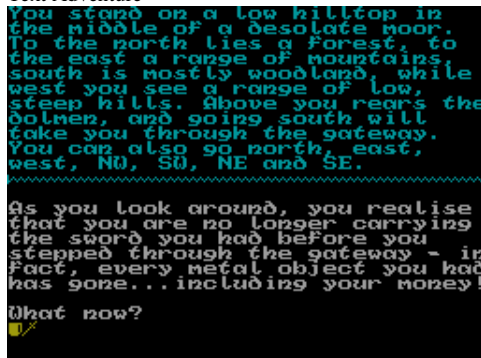

Lords of Chaos - Expansion Kit 1 (Blade Software Ltd,1991)
Strategy



Lords of Midnight, The (Beyond Software,1984)
Strategy



Lorna (Topo Soft,1990)
Arcade



Lost Caves (Players Premier Software,1989)
Arcade

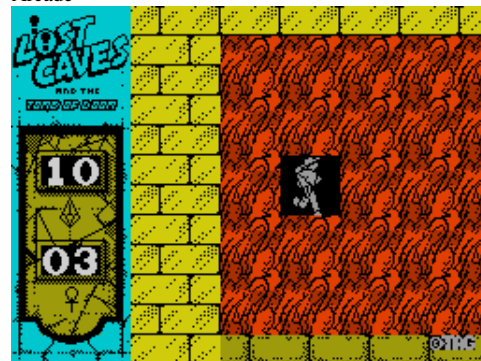

Lost City, The (Sinclair User,1989)
Text Adventure



Lords of Magic (The Guild,)
Text Adventure



Lords of Time (Level 9 Computing Ltd,1983)
Text Adventure



Los Angeles SWAT (Entertainment USA,1987)
Arcade

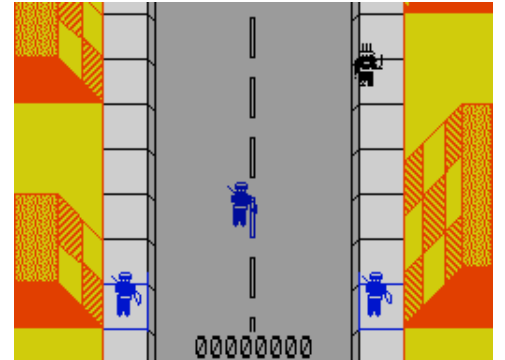

Lost Caves, The (Pryac Software,1985)
Text Adventure



Lost Dragon + Magic Treasure, The (Tartan Software,1991)
Compilation

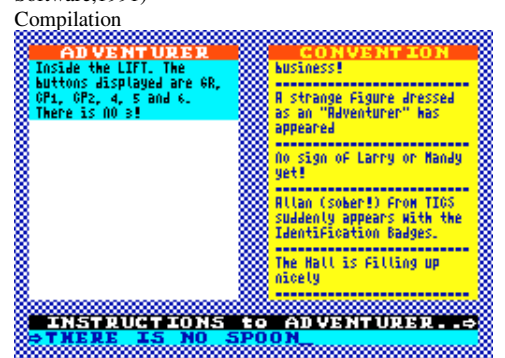

Lost Dragon, The (Tartan Software,1991)

Text Adventure



Lost in the Amazon (The Adventure Workshop,1996)

Text Adventure

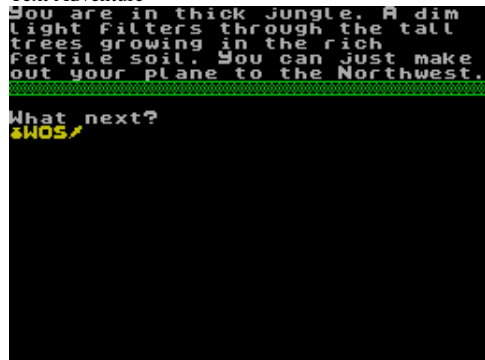

Lost Legacy of Xim, The (Skyslip Software,1988)

Text Adventure



Lost Orb, The (KW Computing,1984)

Text Adventure

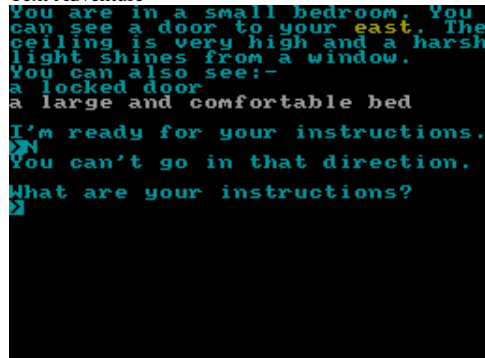

Lost Ruby, The (Wrightchoice Software,1987)

Text Adventure



Lost Gnomes, The (Eric Bean Adventures,1984)

Text Adventure

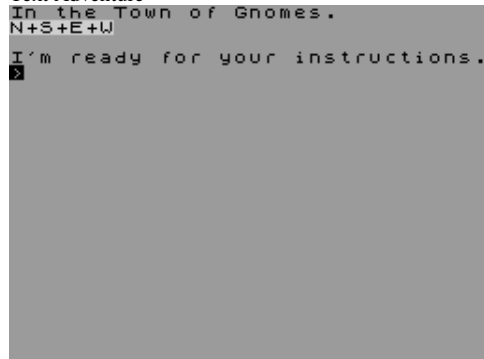

Lost in the Desert (The Guild,)

Text Adventure

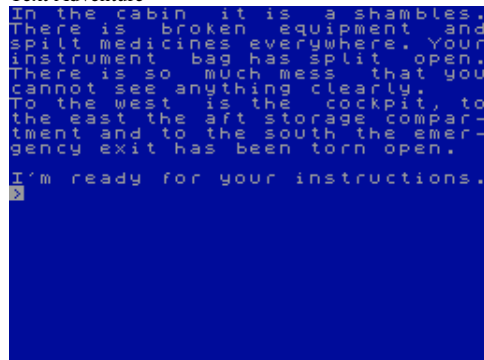

Lost Man Remember I (Rock'n'Soft,)

Arcade



Lost over Bermuda (Elfin Software Ltd,1983)

Text Adventure

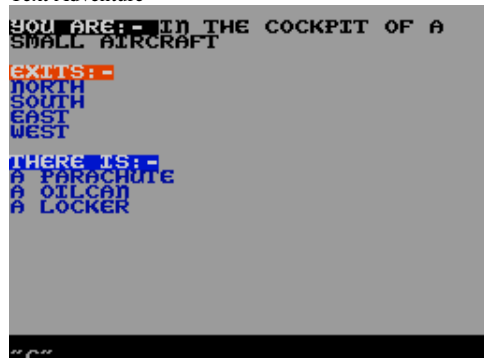

Lost Temple of Inca (Simon Wood,1989)

Text Adventure



Lost in Space (Salamander Software,1984)

Text Adventure



Lost in Time (Zenobi Software,1993)

Text Adventure

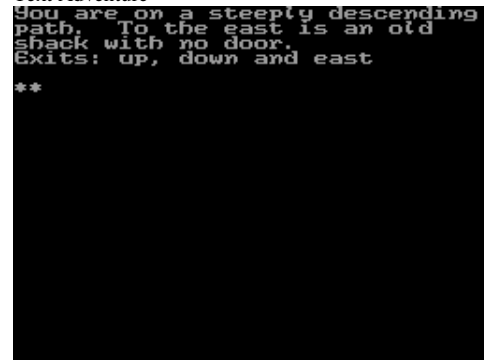

Lost Man Remember II (Rock'n'Soft,)

Arcade



Lost Phirious, The (Vidipix,1986)

Text Adventure



Lost Temple, The (Zenobi Software,1990)

Text Adventure

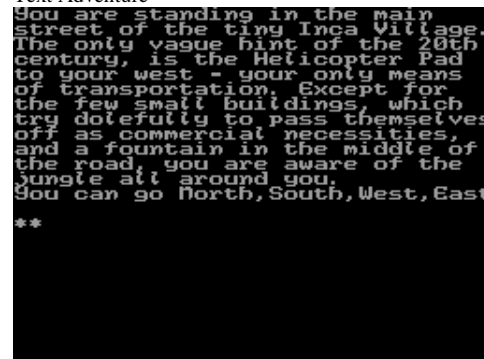

Lost Tomb of Ananka, The (Compass Software,1993)
Text Adventure

```
The door is solid bronze and has
a large ring handle in its
centre. At the top of the door!
you can see some hieroglyphics!

I need your advice.
EXAMINE RING
You don't see anything of
particular interest.

I need your advice.
EXAMIN HIERO
#*+<=>@ [unreadable symbols]
[unreadable symbols]

I need your guidance.
YOUR CHUNTEY? IS BROKEN?>
```

Lost Twilight, The (Zenobi Software,1990)
Text Adventure

```
[Screenshot of a 3D rendered room with a doorway and a picture on the wall.]

The grandness of the entrance
hall gave an initial feeling of
noble hospitality to the welcome
visitor. A connection corridor
ran to the east whilst north
led into the main hall. The
front door led onto the porch
to the south.

↑E
```

Loteria Primitiva (Erbe Software S.A.,1985)
Utility

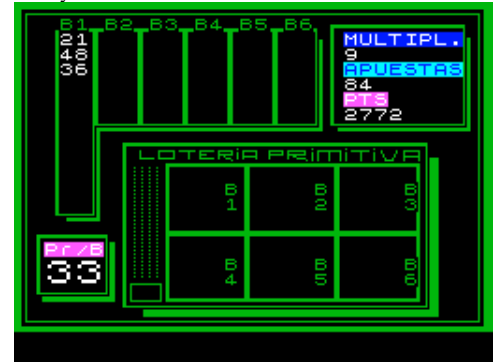

Loteria Primitiva (MicroHobby,1985)
Arcade

```
WE HAVE
NO SCREENSHOT
OF THIS
PROGRAM
```

Lothlorien (Micromania [2],1985)
Arcade

```
WE HAVE
NO SCREENSHOT
OF THIS
PROGRAM
```

Loto, El (Software Editores,1986)
Board/Card Game

```
WE HAVE
NO SCREENSHOT
OF THIS
PROGRAM
```

Loto Mania: Desarrollo de Combinaciones (Erbe Software S.A.,) Utility

```
WE HAVE
NO SCREENSHOT
OF THIS
PROGRAM
```

Lotto (Laussoftware,1984)
Utility

```
*****
* Der Aufsichtsbeamte hat sich
* vor dieser Sendung vom ord-
* nungsgemaessen Zustand des
* Gerates und der 49 Kugeln
* ueberzeugt.
*****

Karin
Tietze-
Ludwig
```

A screenshot of the 'Lotto' utility program. It shows a character sitting at a table with a clock on the wall. The character is Karin Tietze-Ludwig.

Lotus Esprit Turbo Challenge (Gremlin Graphics Software Ltd,1990) Arcade



Love (Remsoft Arcade Designs Ltd,1983)
Text Adventure

```
WE HAVE
NO SCREENSHOT
OF THIS
PROGRAM
```

Love Me Baby (Phil Hard Productions,1985)
Scene Demo



Love Oracle (Solar Publishing,1985)
Educational

```
CONVALESCENCE

1 Are we compatible ?

An old relationship has ended. A
new one looks promising.

To continue press:

1 to recall list of questions
2 to proceed to the lines
3 to read second hexagram
4 to read first hexagram again
5 to start again
```

Love Quiz 2 (Keith Burton,1983)
Simulation

```
LOVE QUIZ 2 - BY KEITH BURTON
© KEITH BURTON 1983
LOVE QUIZ

Do you think it is unwise to
borrow money from a friend ?

ENTER 0 for NO
ENTER 5 for YES
ENTER 1 to 4 for undecided
Eg. 4= almost yes.

?
```

Lover (Paolo Goglio,1985)
Strategy

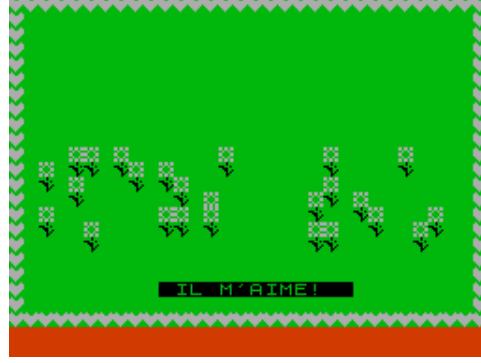

Lovetoy (PO Box 1520,1986)
Text Adventure

```
WE HAVE
NO SCREENSHOT
OF THIS
PROGRAM
```

Low Level Mission (Spectrum Computing,1983)
Arcade



LSDX (Ziga Turk,1985)
Utility

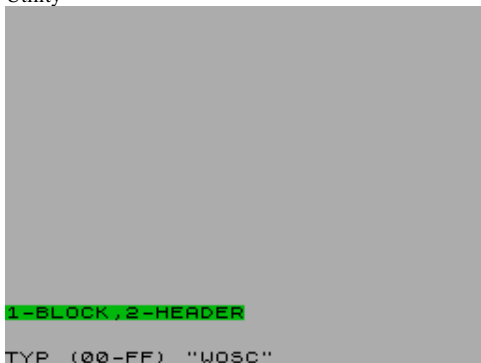

Luna Atac (Atlantis Software Ltd,1986)
Arcade

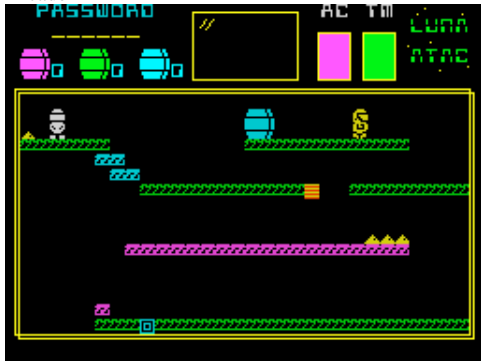

Luna Lander Games Pack (Program Direct,1982)
Arcade



Lunar Jetman (Ultimate Play The Game,1983)
Arcade



LSD (CRL Group PLC,1984)
Simulation



LSF (Impact Creative Group,1966)
Text Adventure



Luna Crabs (Micromega,1983)
Arcade



Lunar Attack (K'Soft Ltd,1983)
Arcade



Lunar Lander (.)
Arcade

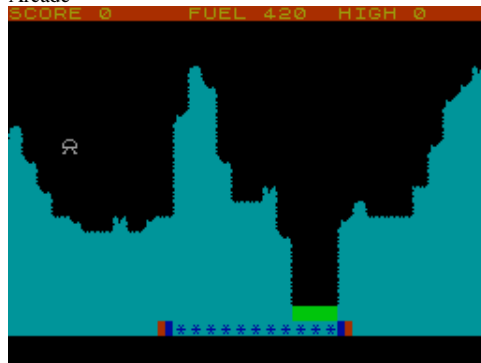

LSD Megademo (Pentagram,1992)
Scene Demo



Ludo (16/48 Tape Magazine,1985)
Board/Card Game

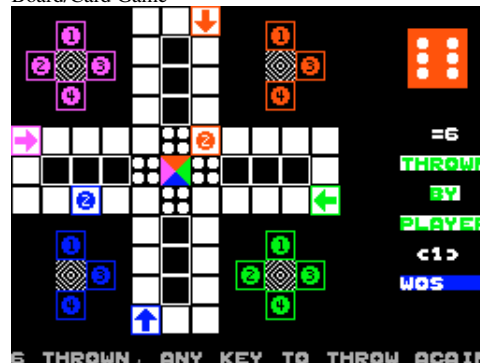

Luna Lander (Sonic Software,1982)
Arcade



Lunaris (Jonathan Cauldwell,2004)
Arcade

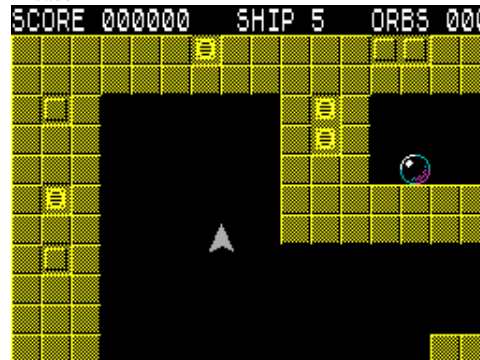

Lunar Lander (Anco Software Ltd,1983)
Arcade



Lunar Lander (C-Tech,1982)
Arcade

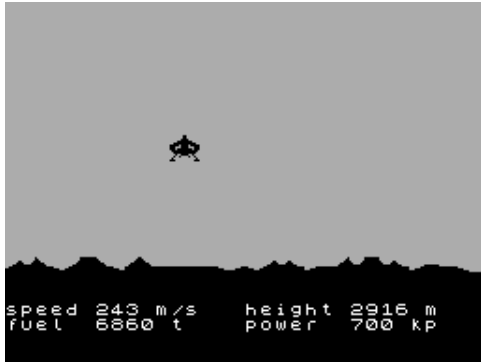

Luna-Rover (Data Design Systems,1985)
Arcade



Lunar Rescue (Popular Computing Weekly,1983)
Arcade

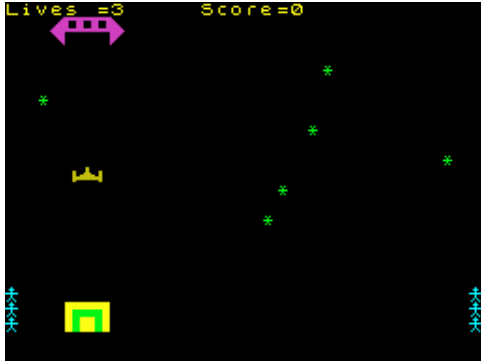

Lupa de Caracteres (MicroHobby,1985)
Utility: Font/UDGs



Lycanthropy (Zenobi Software,1993)
Text Adventure



Lunar Landing (Durell Software Ltd,1984)
Arcade



Lunar Rescue (CRL Group PLC,1983)
Arcade

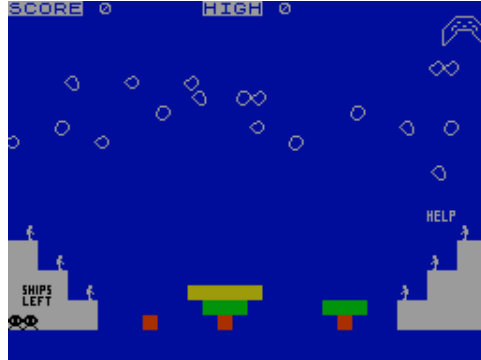

Lunattack, 3D (Hewson Consultants Ltd,1984)
Arcade



Lure (Sinclair Programs,1983)
Arcade

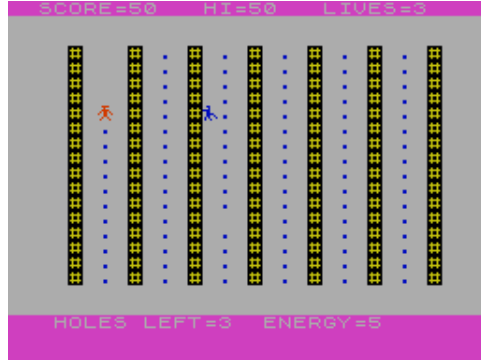

Lynchmob (Bridge Software,1982)
Educational



Lunar Letters (Longman Software,1983)
Educational

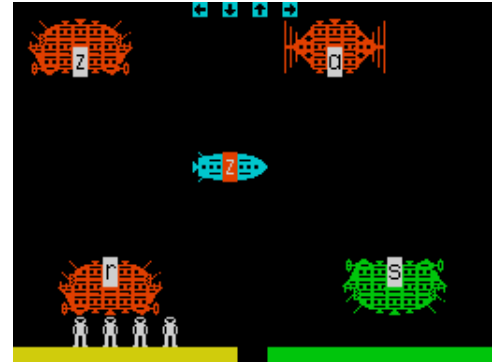

Lunar Rescue (Lyversoft,1983)
Arcade



Lunolet 2 (Alexey Baushkin,1992)
Arcade



Luxik na Bibrstějne (AK-Soft,1987)
Text Adventure

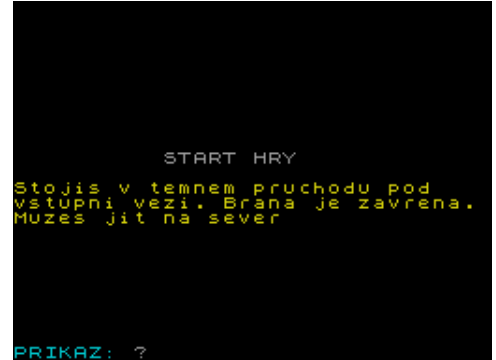

Lyra II Megademo, The (Sinclair User,1991)
Scene Demo

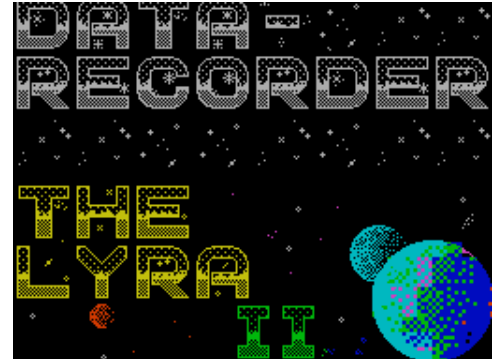

Lyra Megademo, The (Sinclair User,1991)
Scene Demo

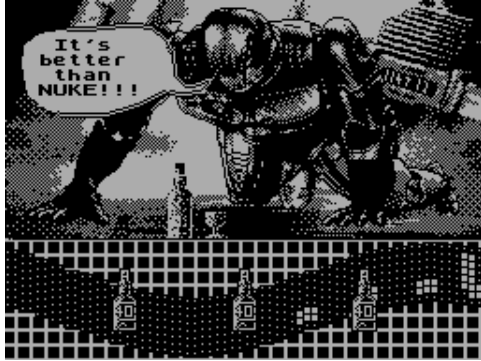

Macroids (Your Spectrum,1985)
Arcade

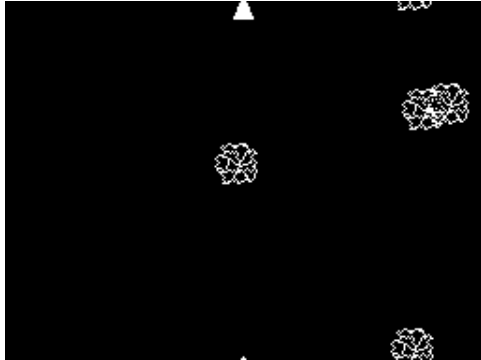

Machine Code Disassembler (16/48 Tape Magazine,1985)
Utility: Assembler/Disassembler/Monitor



Machine Code Relocator (Dr. M. P. SUn,1989)
Utility: Assembler/Disassembler/Monitor



Machine Code Tools (Phipps Associates,1982)
Utility

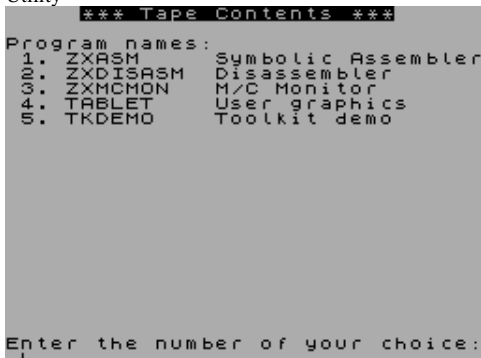

M4 (Virgin Books,1983)
Arcade



MacGyver - La Aventura (Rafael Vico Costa,1987)
Text Adventure

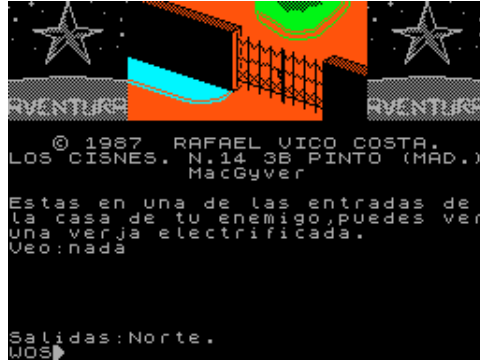

Machine Code For Beginners (Dream Software Ltd,1983)

Utility: Programming

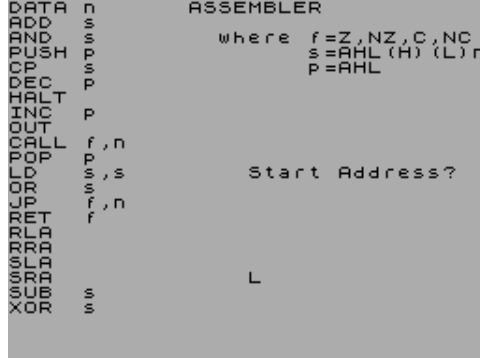

Machine Code Teacher (Peekay Software,1984)
Educational

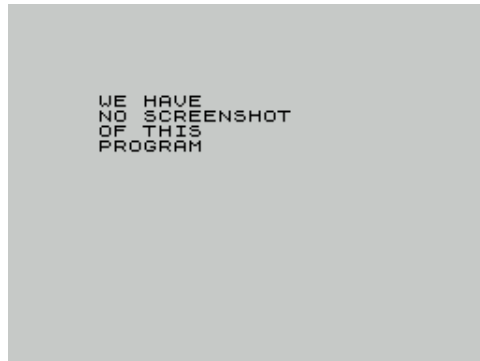

Machine Lightning (Oasis Software,1985)
Utility: Programming



Macadam Bumper (PSS,1985)
Simulation

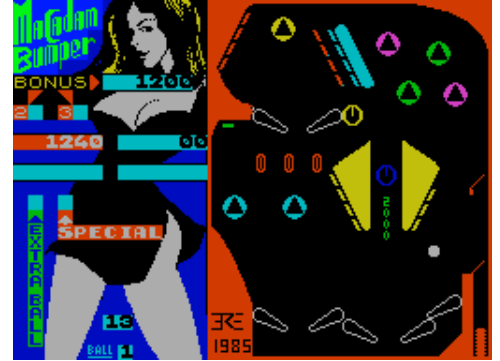

Mach 3 (Loricels,1989)
Simulation

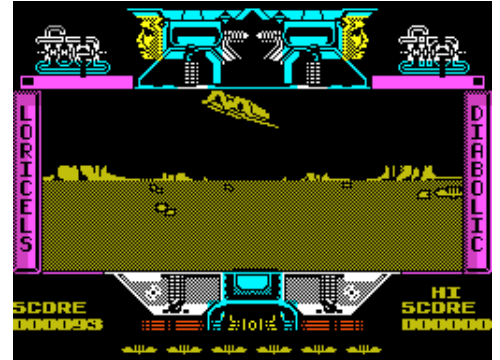

Machine Code Loader (,)
Utility



Machine Code Test Tool (Oxford Computer Publishing,1982)
Utility: Assembler/Disassembler/Monitor

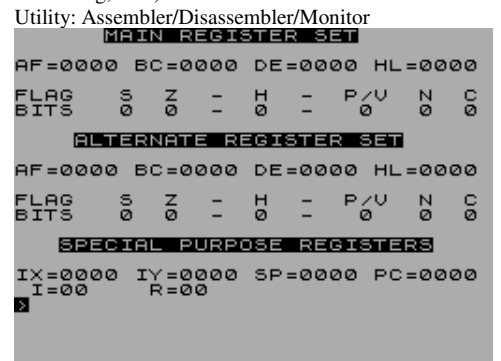

Mac Man (Your Spectrum,1985)
Arcade



MacMan and the Caber Eater (Macmillan Software Ltd/Sinclair Research Ltd,1985) Educational



MacMan's Magic Mirror (Macmillan Software Ltd/Sinclair Research Ltd,1984) Educational

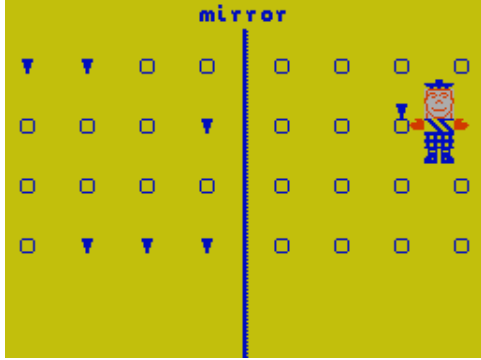

Madballs (Ocean Software Ltd,1988) Arcade

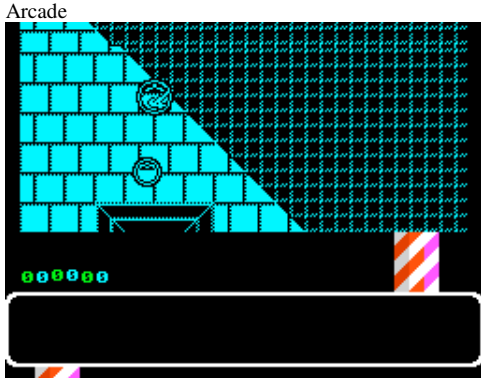

Mad Caverns (Your Computer,1985) Arcade



Made in Kazan (Excess Megagroup,1996) Scene Demo



MacMan and the Great Escape (Macmillan Software Ltd/Sinclair Research Ltd,1985) Educational

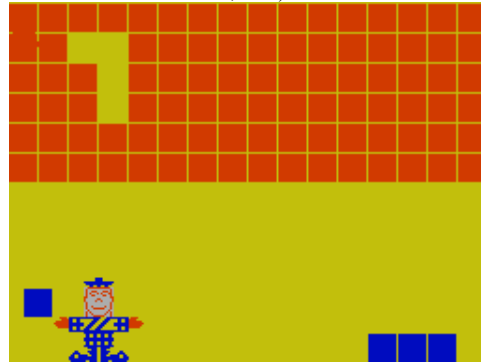

Macro for Construction and Animation (Pinehurst Data Studios,1983) Utility: Screen Manipulation



Madcap Manor (Gilsoft International,1985) Text Adventure

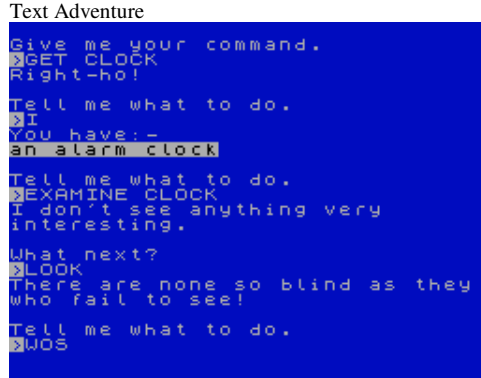

Madchicken (Oz Software,1983) Arcade



Made in Spain 5 Estrellas (Zigurat Software,) Compilation

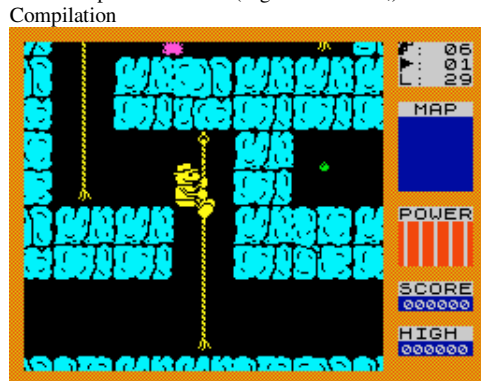

MacMan in the Treasure Caves (Macmillan Software Ltd/Sinclair Research Ltd,1985) Educational



Mad Arrows (Wompa Software,) Arcade

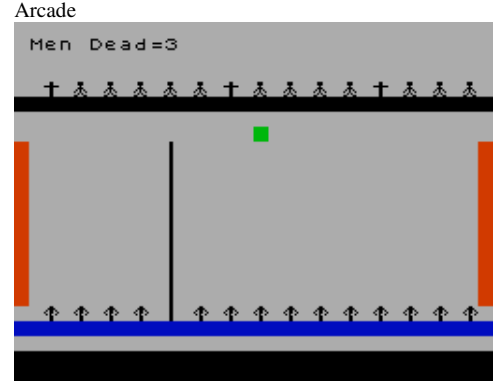

Mad Cars (Ventamatic,1984) Arcade

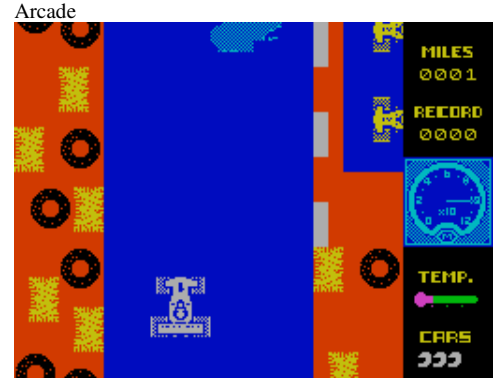

Mad Crusher, The (Spectrum Computing,1986) Arcade



Madhatter (Automata UK Ltd,1985) Arcade



Mad House (The Mad Guys,1992)
Scene Demo



Mad Load (Fuxoft,1986)
Utility

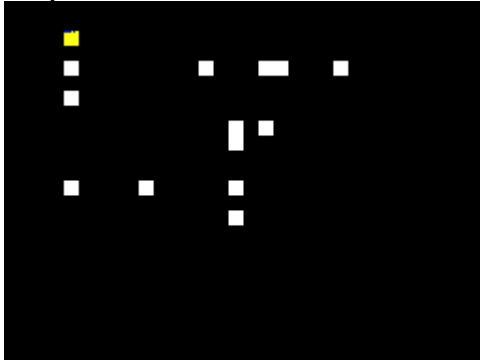

Mad-Man (Reinhard Wittkopf,)
Arcade



Mad Max (Micro Press [1],1983)
Arcade

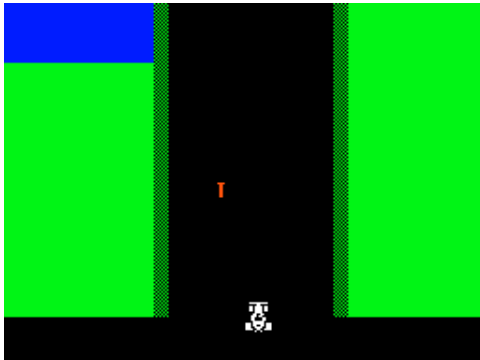

Madness Remix (The Mad Guys,1991)
Scene Demo



Mad in Cascais (Cascaismicro,1986)
Text Adventure



Mad Load 5 (TRC Software,)
Utility

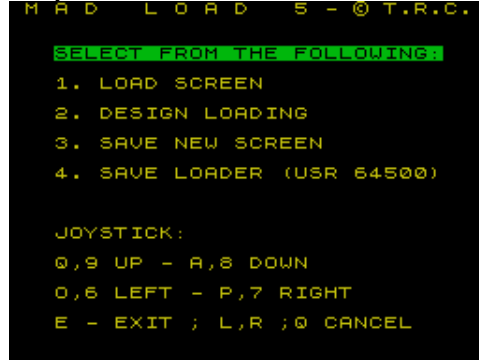

Mad Martha (Mikro-Gen Ltd,1983)
Text Adventure

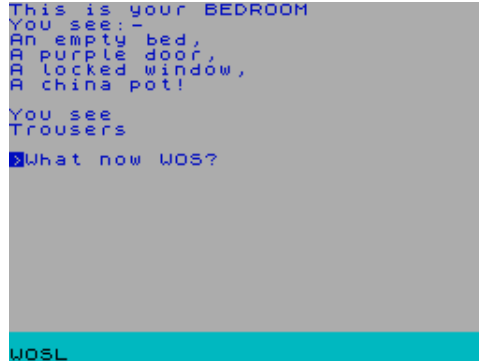

Mad Mix 2 (Topo Soft,1990)
Arcade

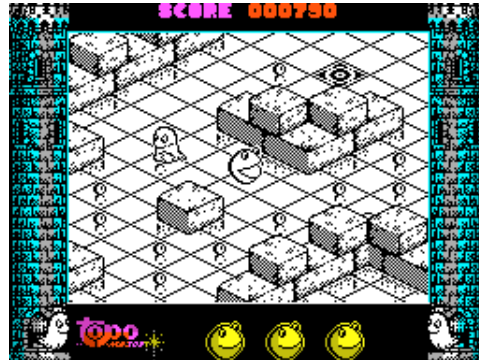

Madness Schach (Wittkopf Software,1984)
Board/Card Game



Mad Jumper (Sinclair Programs,1984)
Arcade



Mad Load '89 (Pevsoft,1989)
Utility



Mad Martha 2 (Mikro-Gen Ltd,1983)
Text Adventure

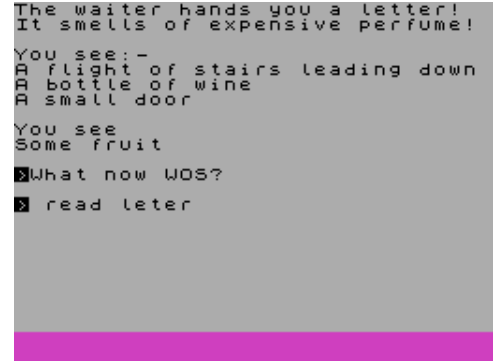

Mad Mix Game (Topo Soft,1988)
Arcade

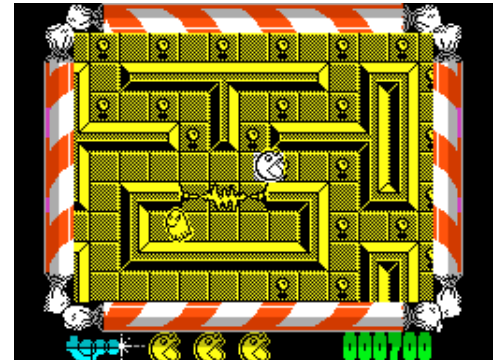

Mad Nurse (Firebird Software Ltd,1987)
Arcade



Maedchentest (.)
Simulation

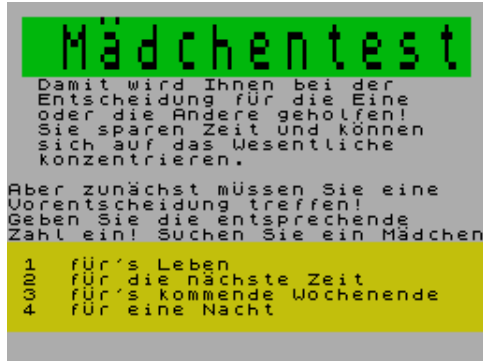

Mafia Contract (Atlantis Software Ltd,1984)
Text Adventure

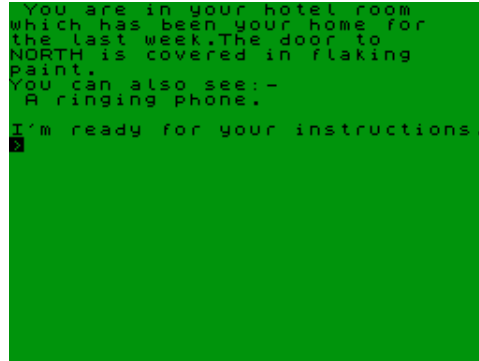

Mafia Contract II: The Sequel (Atlantis Software Ltd,1984)
Text Adventure

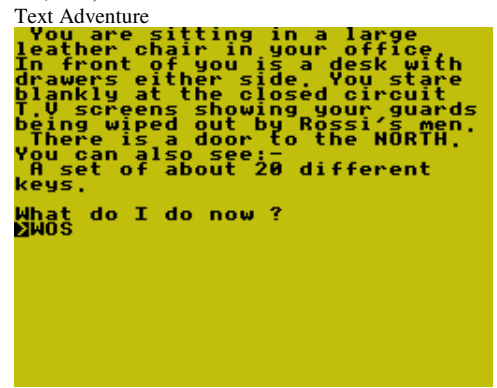

Mage Cage (.)
Arcade

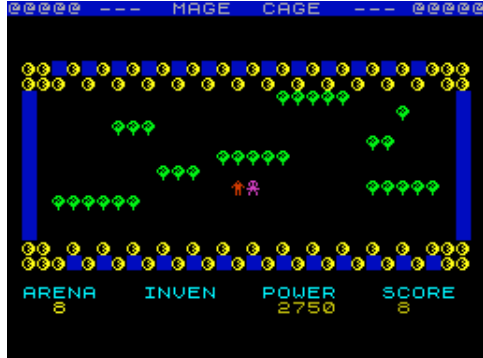

Maggot (Your Computer,1983)
Arcade



Magic (Electronica CS.)
Text Adventure



Magic (Macmillan Software Ltd,1985)
Educational

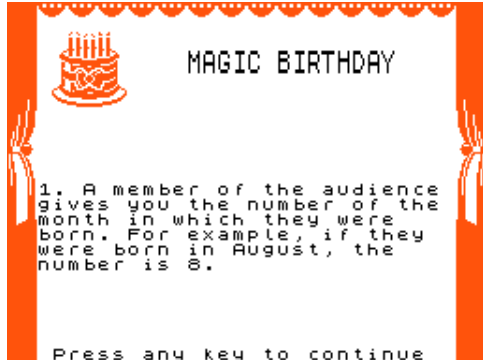

Magical Mystery Tour (Adventure Probe Software.)
Text Adventure



Magic Ball Trilogy (Spectec,1993)
Scene Demo

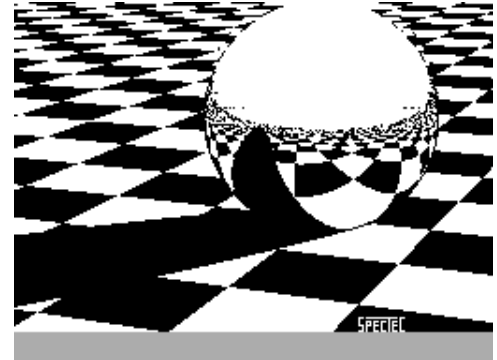

Magic Block (DAB Labs,1995)
Board/Card Game

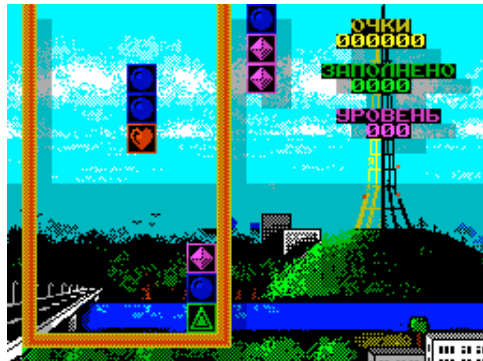

Magic Cards (Cornhill Services,1983)
Board/Card Game



Magic Carpet (Mastertronic Ltd,1985)
Arcade



Magic Castle (Gilsoft International,1983)
Text Adventure

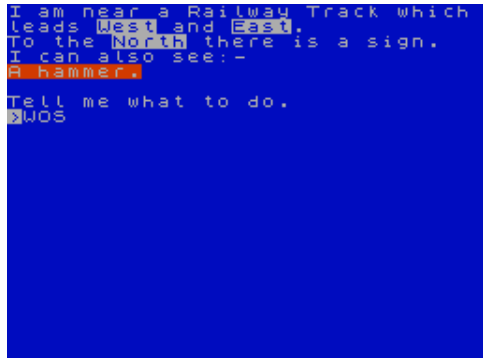

Magic Caves (Enigma Variations Ltd,1990)
Arcade



Magic Circle, The (.)
Text Adventure



Magic Dice (Proxima Software,1993)
Arcade

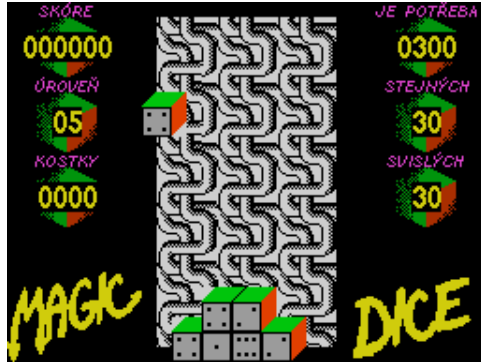

Magician's Apprentice, A (The Guild,1990)
Text Adventure

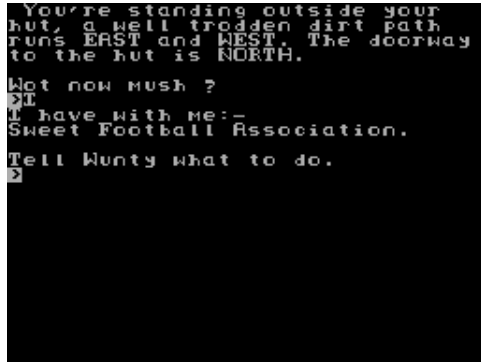

Magic Isle, The (Zenobi Software,1990)
Text Adventure

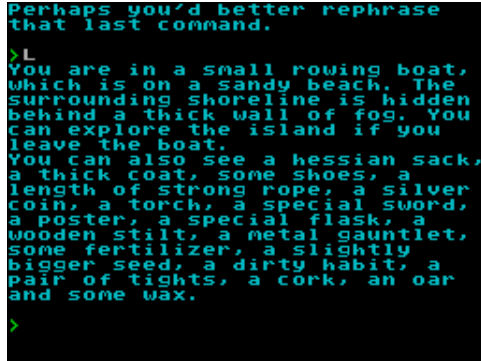

Magic Knight Trilogy (Mastertronic Ltd,1988)
Compilation



Magic Meanies (CDS Microsystems,1983)
Arcade

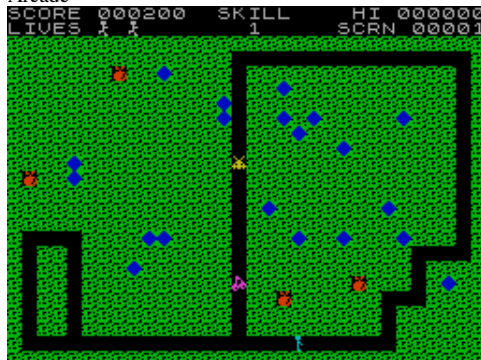

Magic Fields (Zack,1996)
Board/Card Game

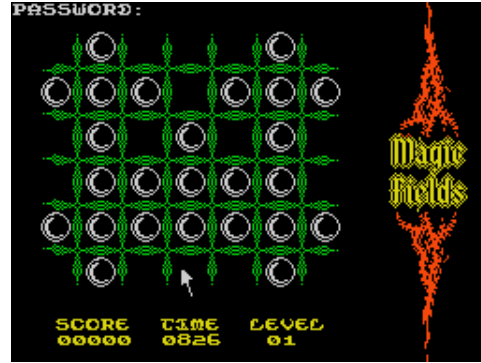

Magician's Ball, The (Global Software,1985)
Text Adventure



Magic Johnson's Basketball (Dro Soft,1990)
Arcade



Magiland Dizzy (Code Masters Ltd,1989)
Arcade



Magic Message (ZX-Guaranteed,1984)
Utility



Magic Forest (Shiva Publishing Ltd,1983)
Arcade



Magicians Land (Precision Group,1996)
Text Adventure



Magic Keys (Stefan Zyczkowski,1985)
Arcade



Magic Lines (Random Science Crew,1995)
Board/Card Game

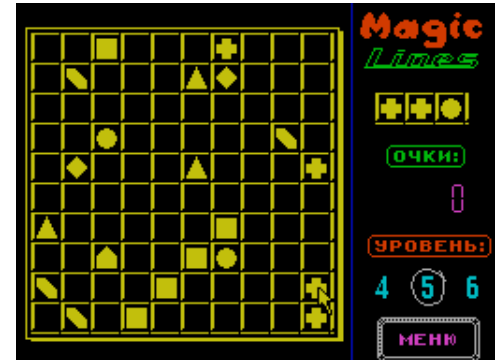

Magic Missile issue 01 (Matthew Wilson,1989)
Covertape



Magic Missile issue 02 (Matthew Wilson,1989)

Covertape

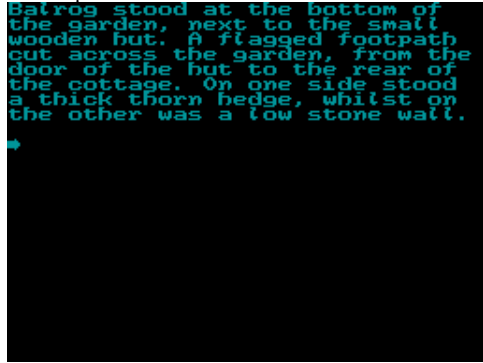

Magic Missile issue 05 (Matthew Wilson,1990)

Covertape



Magic of Logic, The (VVS/Dr. Mushroomer,1996)

Board/Card Game

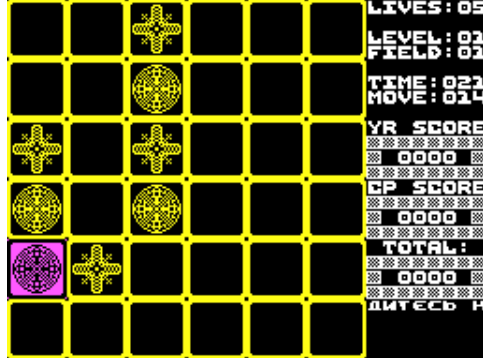

Magic Shop, The (Arrow,1984)

Educational



Magic Story (Bodrov Vadim,1994)

Text Adventure

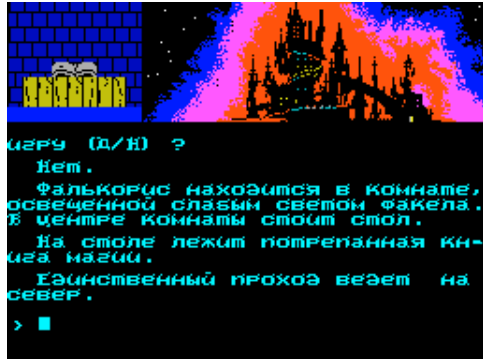

Magic Missile issue 03 (Matthew Wilson,1990)

Covertape



Magic Mountain (Phipps Associates,1983)

Text Adventure

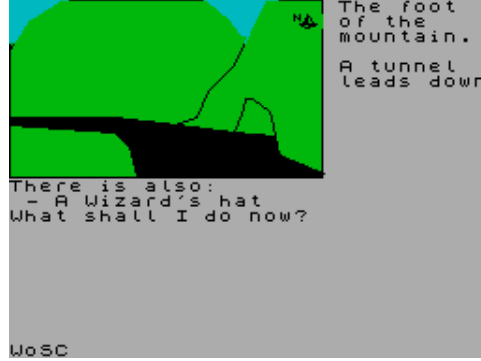

WoSC

Magic Orchard (Procom Software,1984)

Arcade



Magic Square (Sinclair Research Ltd,1982)

Arcade



Magic Stripes (Virtual Brothers,1997)

Board/Card Game

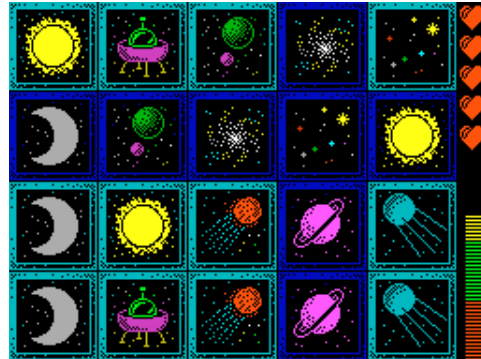

Magic Missile issue 04 (Matthew Wilson,1990)

Covertape



Magico (,)

Arcade



Magic Roundabout, The (CRL Group PLC,1984)

Arcade



Magic Squares (Your Computer,1982)

Arcade

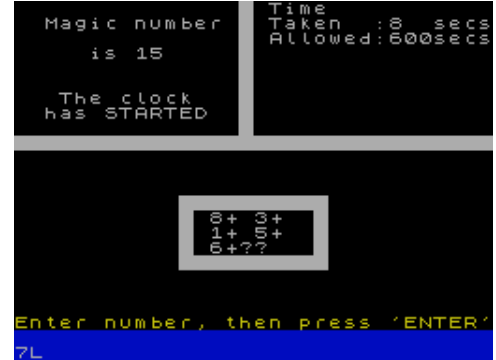

Magic Sword, The (Database Publications Ltd,1984)

Text Adventure



Magic Treasure Adventure (Tartan Software,1991)
Text Adventure



Magische, Das (Juergen Schroth/Georg Trietsch,)
Text Adventure



Mag Max (Imagine Software Ltd,1987)
Arcade



Magnetron (Firebird Software Ltd,1988)
Arcade



Magnum Light Pen (Magnum Electronics,1987)
Utility



Magic Treasure Island (,)
Text Adventure

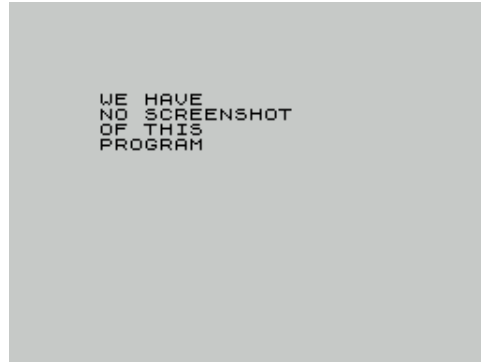

Maglaxians (Cybexlab Software,1985)
Arcade

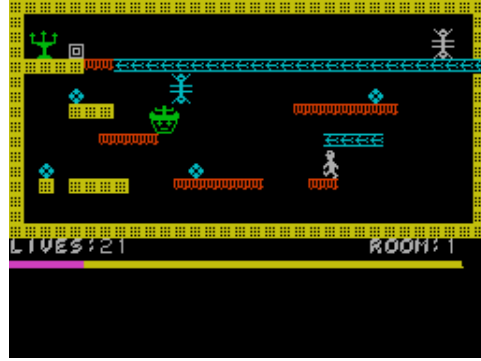

Magnetic Moon (FSF Adventures,1989)
Text Adventure



Magnets (Macmillan Software Ltd/Sinclair Research Ltd,1984) Board/Card Game

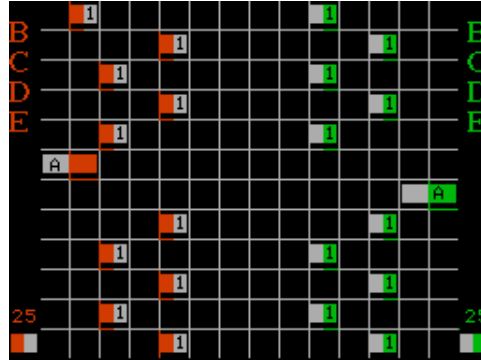

Magnum Pack Volume 1 (Silverbird Software Ltd,1989)
Compilation

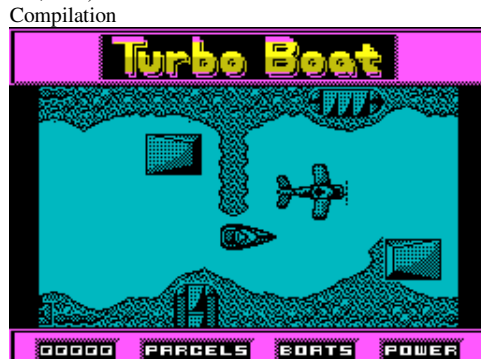

Magic Worm (Lyndenhurst Ltd,1983)
Arcade

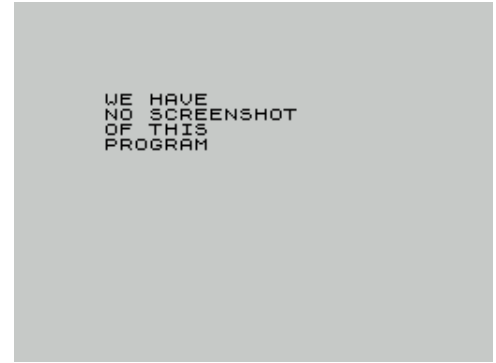

Magma Man (Spectraxx Tape Magazine,1987)
Text Adventure



Magnetic Scrolls Collection (Virgin Games Ltd,)
Compilation



Magnificent 7 (Ocean Software Ltd,1988)
Compilation



Mago, El (,)
Board/Card Game

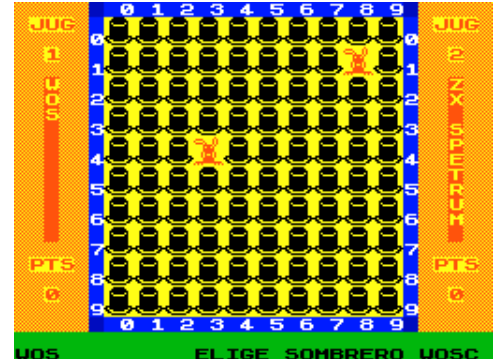

Magpie (Flexibase Software,1988)
Educational



Mah Jongg (Proxima Software,1992)
Board/Card Game

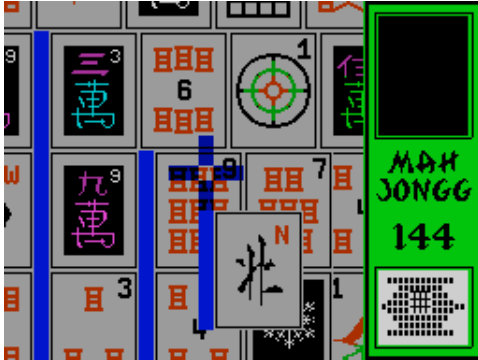

Mailstrom (Ocean Software Ltd,1986)
Arcade Adventure



Makao (A. Mielczarek,1985)
Board/Card Game

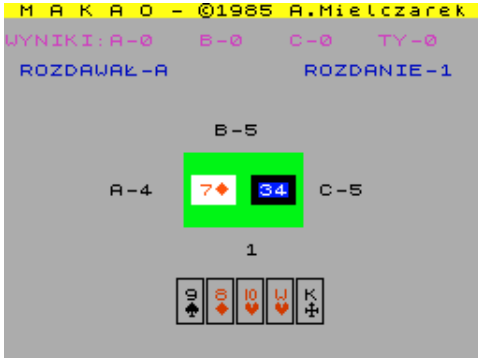

Make Music (Buffer Micro Ltd,1984)
Utility: Music Creation



Magus (D.N.D. Software,)
Text Adventure

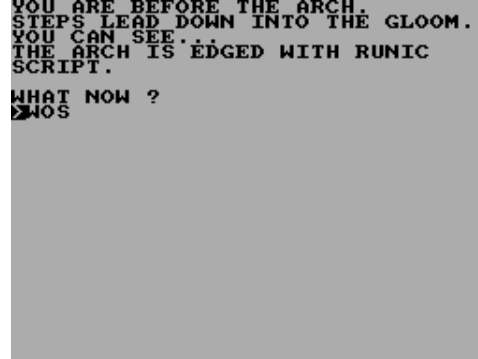

Mahn John 2 (Konstantin Teterin,1994)
Board/Card Game



Main Blow, The (Chip & Rokky,1994)
Arcade



Make-a-Chip (Sinclair Research Ltd,1984)
Utility: Electronics

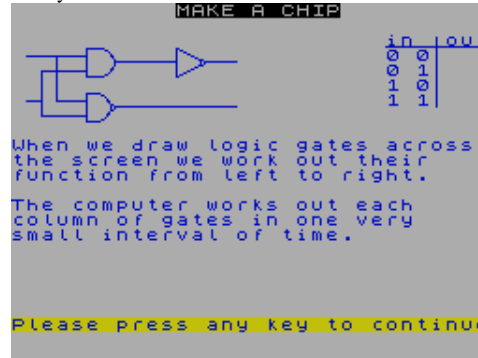

Maldicion de Aros, La (Carlos Moreno,1991)
Text Adventure



Mah Jong (Spectre,1984)
Board/Card Game

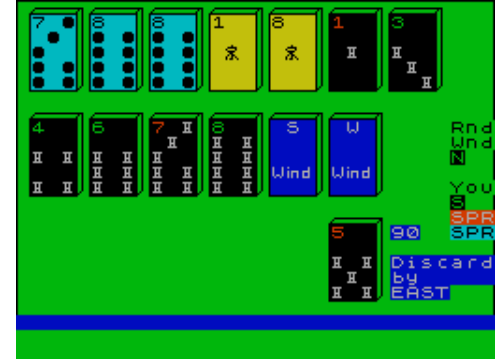

Mail (.)
Utility

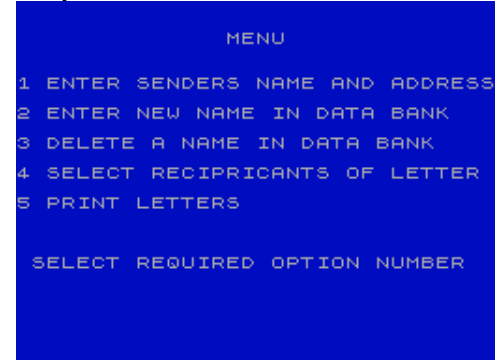

Majik (Mastertronic Ltd,1988)
Text Adventure



Make-a-Face (Spinnaker Software Corporation,1984)
Educational



Maldicion de Jarak, La (Grupo de Trabajo Software S.A.,1986) Arcade



Maldicion de los Mac Leod, La (Danisoft,1990)
Text Adventure

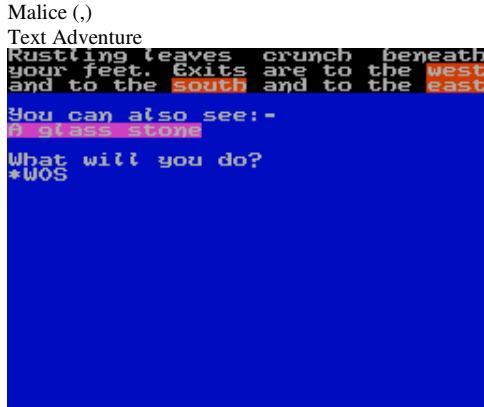

Malinsay Massacre, The (CRL Group PLC.)
Text Adventure



Mampfmann (.)
Arcade

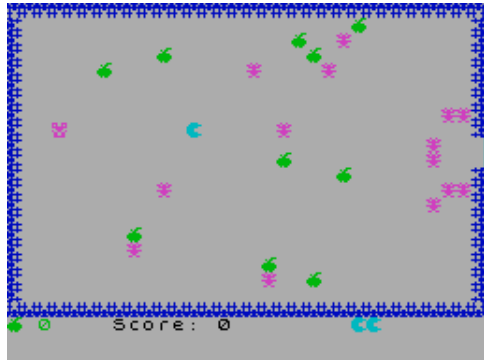

Manager (.)
Strategy

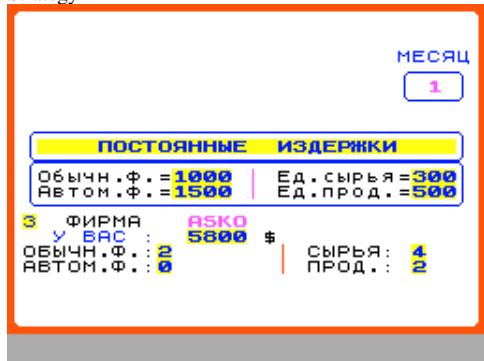

Maldita Escuela (Mega Soft [4],1989)
Text Adventure



Malice in Blunderland (The Guild,1985)
Text Adventure

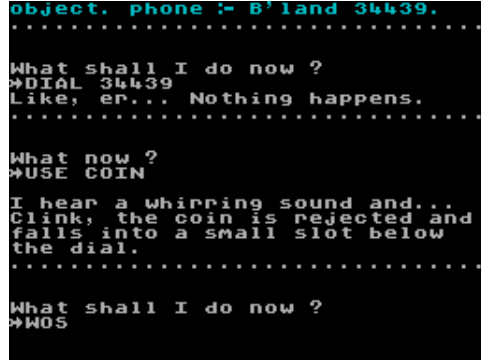

Mallard Basic (Locomotive Software,1988)
Utility: Programming



Man About the House (Zenobi Software,1994)
Text Adventure

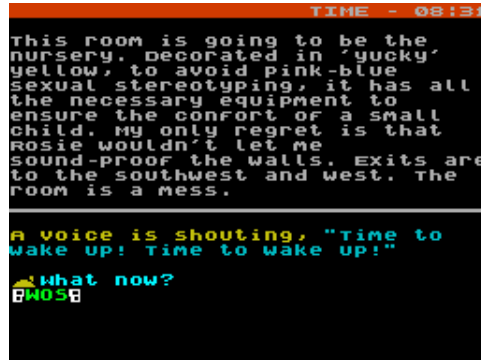

Manager (ERE Informatique,1984)
Strategy

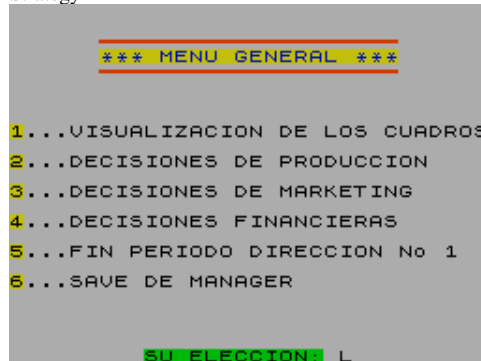

Malibu (GDP Software,1985)
Sport

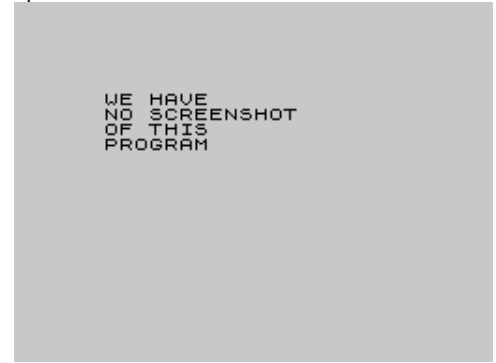

Malice in Wonderland (Lumpsoft,1985)
Text Adventure

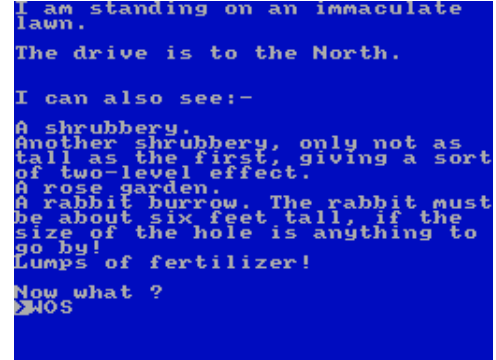

Mambo (Positive,1989)
Arcade

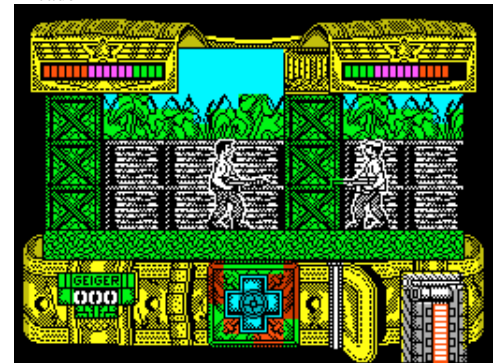

Manage (CCS,1983)
Educational

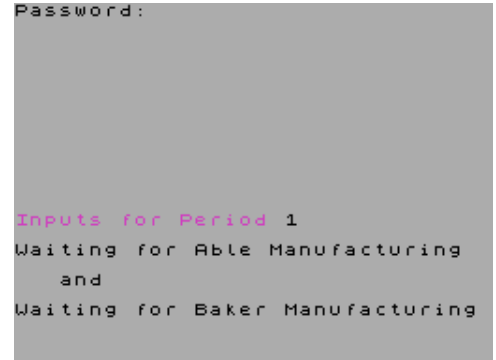

Manager, The (GTI Software,1990)
Simulation



Mancala (Haven Hardware,1983)
Board/Card Game



Manchester United (Krisalis Software Ltd,1990)
Simulation



Manchester United Europe (Krisalis Software Ltd,1991)
Simulation

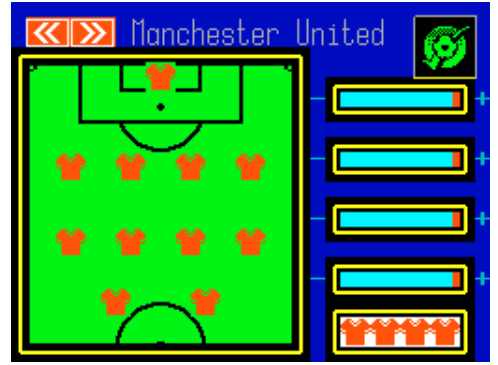

Mandelbrot (Computer Kontakt,1986)
Utility: Screen Manipulation

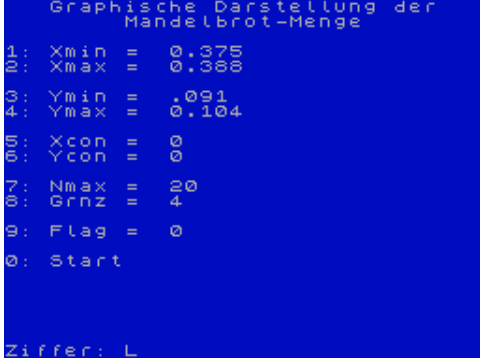

Mandel Demo (FaBRiXoft,1988)
Utility



Mandragore (Infogrames,1986)
Arcade Adventure



Mandroid (Robert Sibthorp,)
Text Adventure

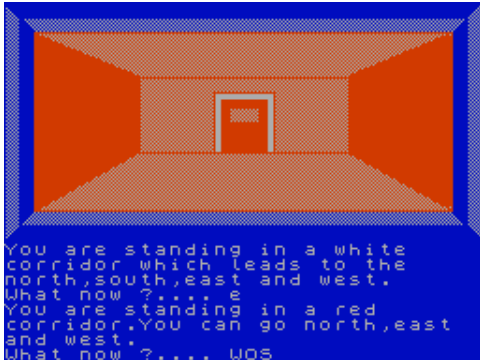

Mango Jones (Crash,1990)
Arcade



Manhattan (Evgeny Koprov/Michael Makarevich,1993)
Scene Demo



Manhattan Demo (Dynamic,1990)
Scene Demo



Man Hunt (Omen Software,1984)
Arcade

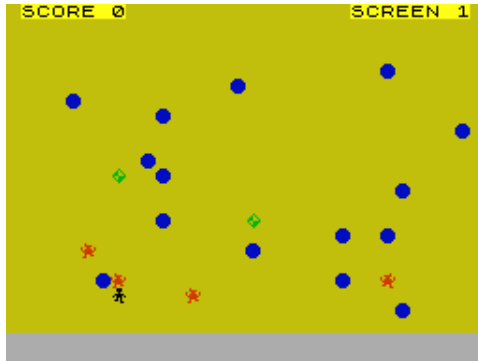

Mania (Icabod,1994)
Scene Demo



Maniac (Prospec.)
Arcade



Maniac Square (MicroHobby,1990)
Arcade

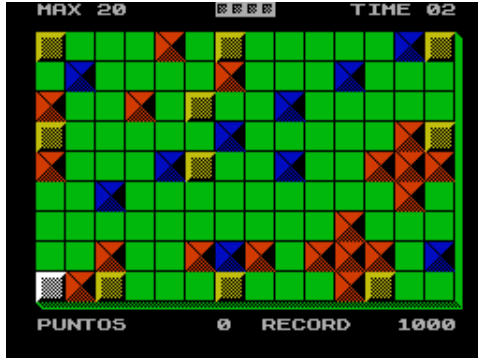

Manic Badger (Psychaedelic Hedgehog Software,1991)
Text Adventure

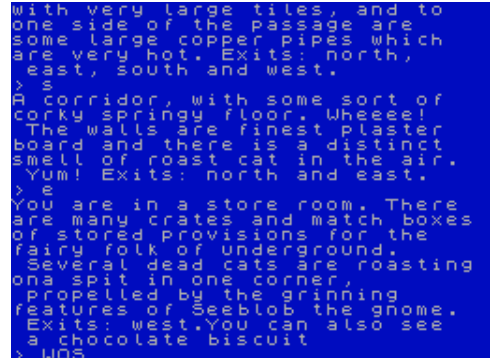

Manic Bugs (Andrew Davis,1987)
Arcade

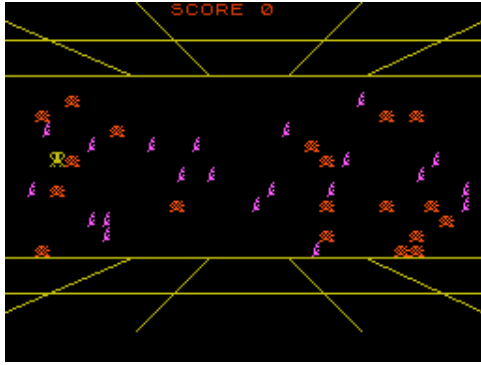

Manic Man (MicroHobby,1986)
Arcade



Manic Miner: Eugene - Lord of the Bathroom (Manic Miner Technologies,1999) Arcade



Manic Miner: Manic Scribbler (Darth Melkor,2005)
Arcade



Manic Miner: reniM cinaM (Broadsoft,2004)
Arcade



Manic Climber (Your Computer,1984)
Arcade

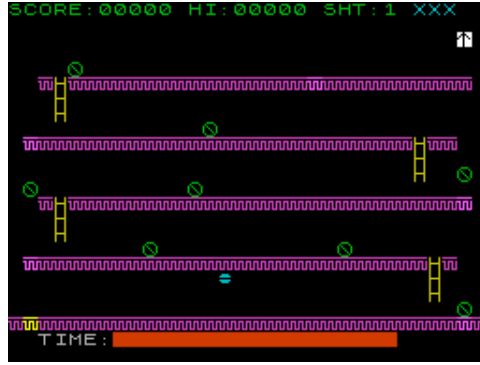

Manic Miner (Bug-Byte Software Ltd,1983)
Arcade



Manic Miner: Jet Set Willy (Broadsoft,2004)
Arcade



Manic Miner: Neighbours - Allana Truman (Broadsoft,2004)
Arcade



Manic Miner: The Hobbit (Broadsoft,2000)
Arcade



Manic Designer 2 (P&M Software,1984)
Arcade Game Development Tool



Manic Miner: comp.sys.sinclair (Nigel Fishwick,2002)
Arcade



Manic Miner: Ma Jolie (Broadsoft,2003)
Arcade



Manic Miner: Perpetual Motion (Darth Melkor,2005)
Arcade



Manic Miner: ZX81 (Alex Martinik,2003)
Arcade



Manic Miner #2 (R.D. Foord Software,1985)
Arcade



Manic Miner 2 (Schultze,1985)
Arcade



Manic Miner - 2000 (FELL,2000)
Arcade



Manic Miner 3: Tales from a Parallel Universe (Cheese Freak Software,1996) Arcade



Manic Miner 4 (Broadsoft,1997) Arcade



Manic Miner 5: Los Peligros del LSD (Ignacio Perez Gil,1998) Arcade



Manic Miner 6: The Buddha of Suburbia (Broadsoft,1998) Arcade



Manic Miner 7 (Craig Rothwell,1998) Arcade



Manic Miner Editor (Richard Swann,1992) Arcade Game Development Tool



Manic Miner Game Designer & Editor (R.D. Foord Software,1988) Arcade Game Development Tool



Manic Miner Patch (John Elliott,) Arcade



Manic Miner Screen Editor (Broadsoft,1998) Arcade Game Development Tool



Manic Miner Sprite Editor (Richard Swann,1992) Arcade Game Development Tool

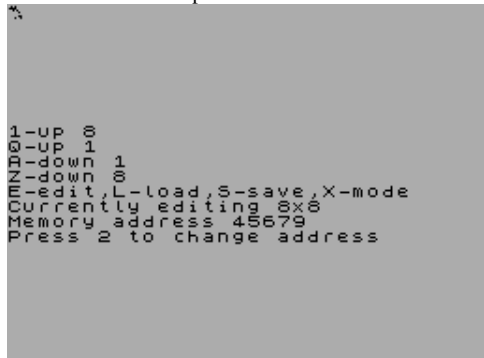

Manic Mower (Sinclair User,1992) Arcade

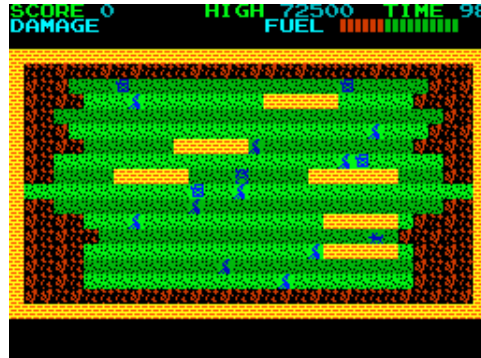

Manic Muslim (Boniosoft,2005) Arcade



Manje-Vise (.)
Educational

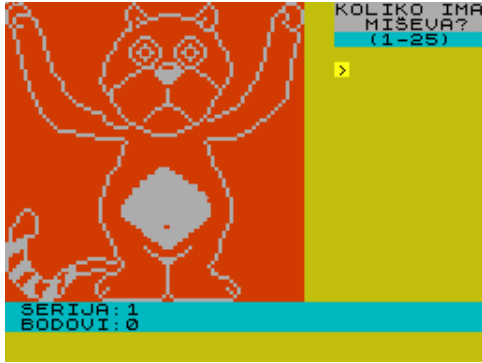

Manor of Doom, The (King Software,1984)
Text Adventure

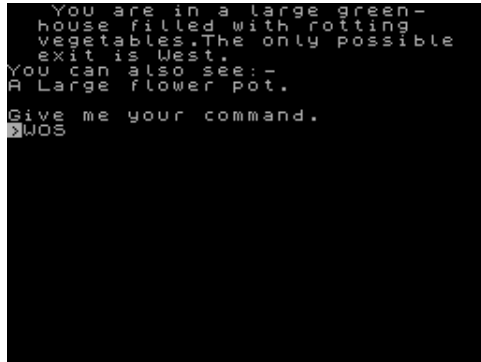

Mansion (MicroHobby,1985)
Arcade



Mans, Le (MicroHobby,1985)
Arcade



Man-Trap (Century City Software Ltd,1984)
Arcade

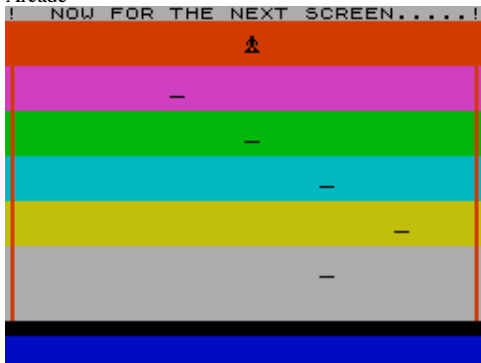

Manollo: El Cavernicola (Iber Software,1988)
Arcade Adventure



Manor of Madness (Celtic Software,1984)
Text Adventure

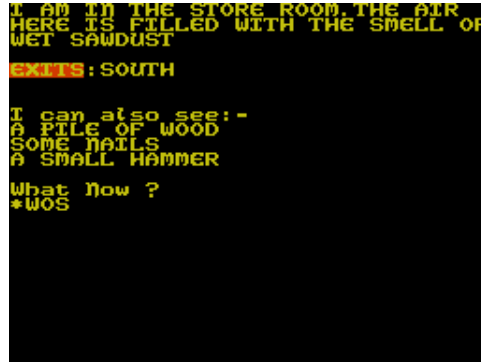

Mansion, La (Manuel Sanchez Castillo.)
Arcade



Mantis 1 (Raven Adventures,1990)
Text Adventure



Mantronix (Probe Software Ltd,1986)
Arcade Adventure

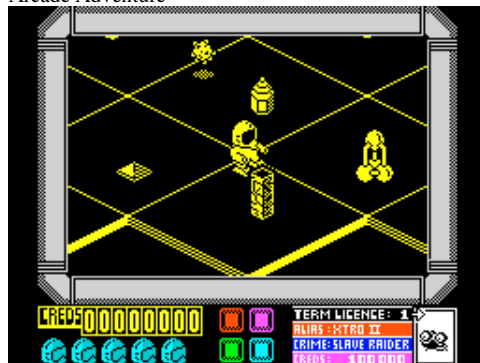

Manor Murder Case, The (.)
Text Adventure



Mansfield Park (Sussex Software,1984)
Educational



Mansion Quest (G.I. Games,1990)
Text Adventure

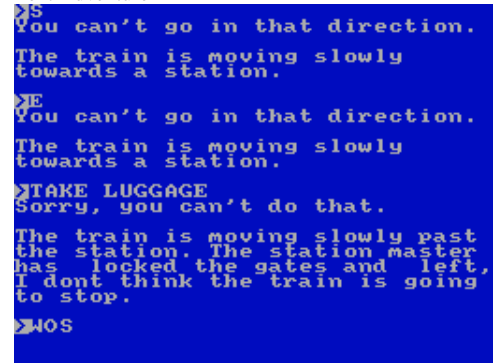

Mantis 2 (Raven Adventures,1990)
Text Adventure



Mapa de Sectores del Microdrive 1 (MicroHobby,1985)
Utility



Mapa de Sectores del Microdrive 2 (MicroHobby,1985) Utility



Mapeado de Graficos 1 (MicroHobby,1986) Utility



Mapeado de Graficos 2 (MicroHobby,1986) Utility

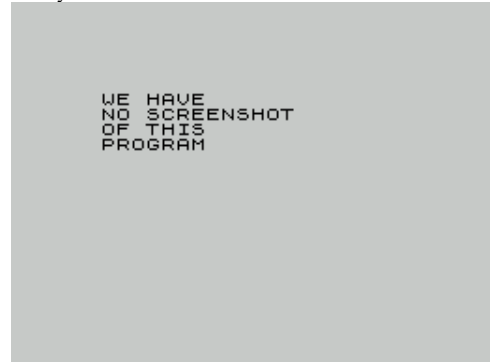

Mapeado de Graficos 3 (MicroHobby,1986) Utility



Map Game (Erbe Software S.A.,1985) Educational

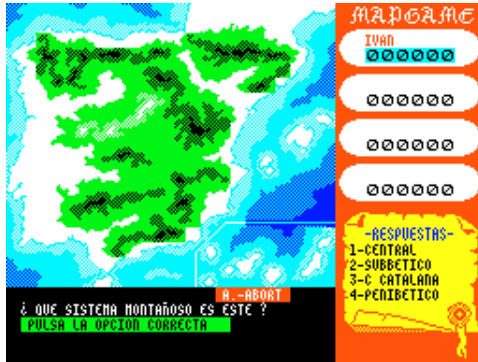

Map of the UK (Kuma Computers Ltd,1983) Educational



Mapper (.) Educational



Mapper, The (Zenobi Software,1992) Text Adventure Development Tool



Map Snatch (Dinamic Software,1985) Strategy



Maquina del Amor, La (Creativos Editoriales S.A.,1985) Arcade

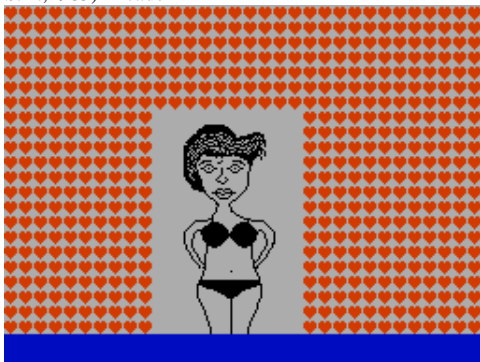

Maquina del Tiempo, La (MicroHobby,1986) Arcade

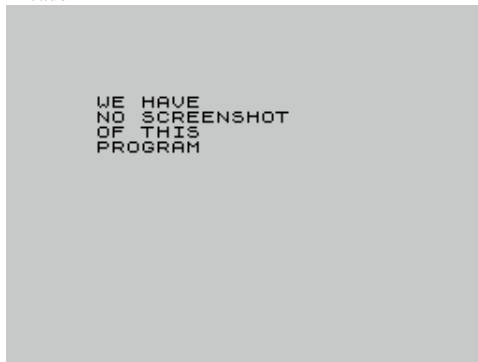

Maquina Tragaperras (MicroHobby,1985) Simulation



Marauder (Hewson Consultants Ltd,1988) Arcade

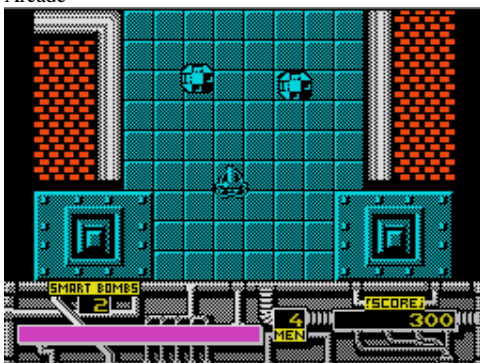

Marble Madness Construction Set (Melbourne House,1986) Arcade Game Development Tool

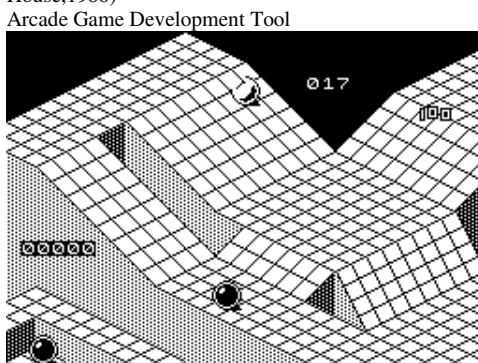

Marble Madness DeLuxe Edition (Melbourne House,1986) Arcade

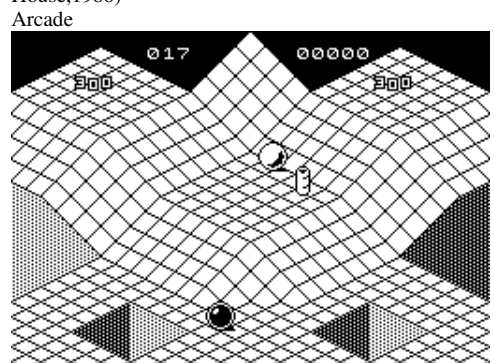

Marbles (Blade Software Inc,1999)
Board/Card Game

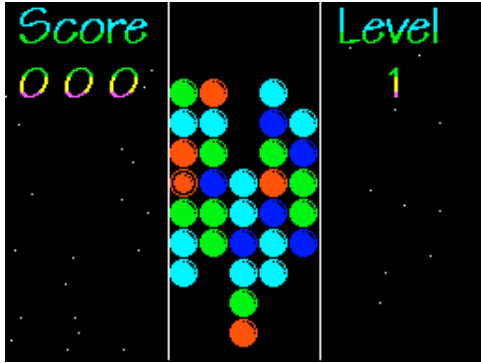

Margo Puzzle (Fatality,1997)
Board/Card Game

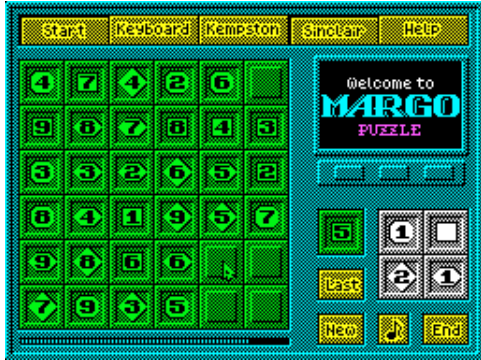

Maria's Christmas Box (Anco Software Ltd,1988)
Board/Card Game



Mariemba (Ediciones y Textos S.A.,1985)
Utility



Marioso (Milous Soft,1989)
Arcade

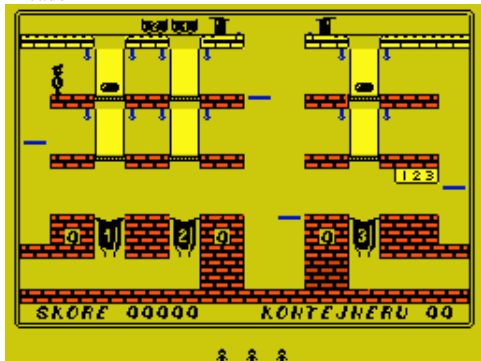

Marcas (Pepsi Soft,1992)
Board/Card Game



Margot's Magic Colouring Book (Gremlin Graphics Software Ltd,1992) Utility: Drawing

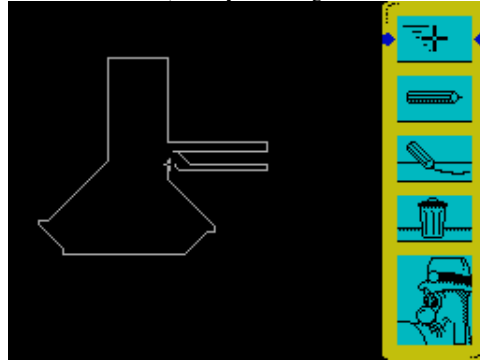

Marie Celeste (Atlantis Software Ltd,1984)
Text Adventure

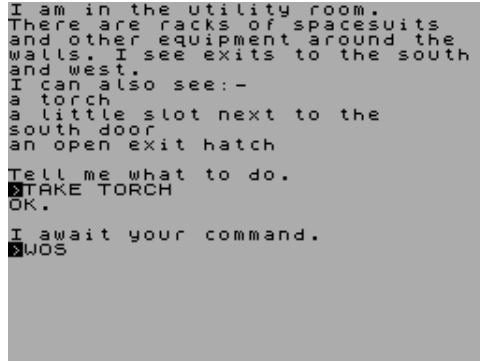

Mario Bros (Ocean Software Ltd,1987)
Arcade

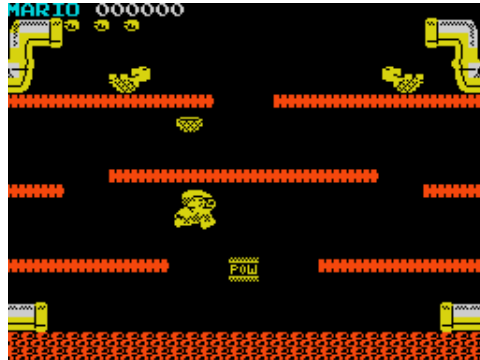

Mark (MicroHobby,1986)
Arcade

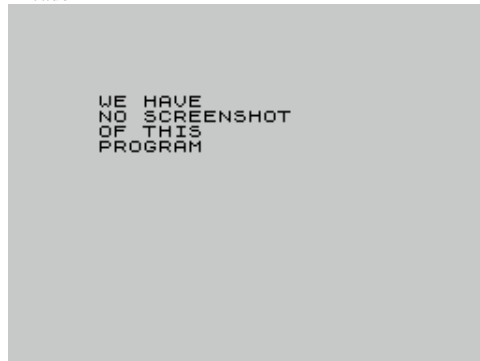

Margana (Longman Software,1983)
Educational

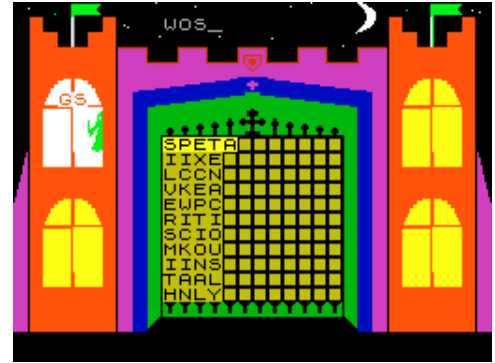

Maria (.)
Scene Demo



Marie Celeste Adventure (Walrus Computing,)
Text Adventure

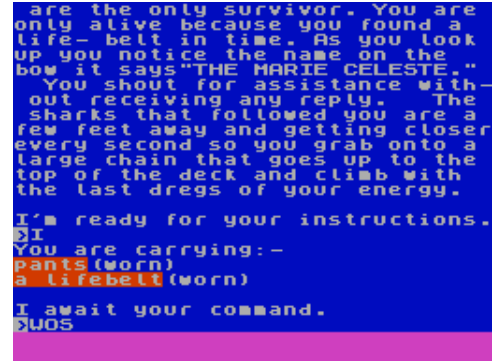

Mario Islands (Omega Hackers Group,1997)
Arcade



Mark Book (Scisoft,1984)
Educational



Markoff (Astra Software,1984)
Strategy



Marsport (Gargoyle Games,1985)
Arcade

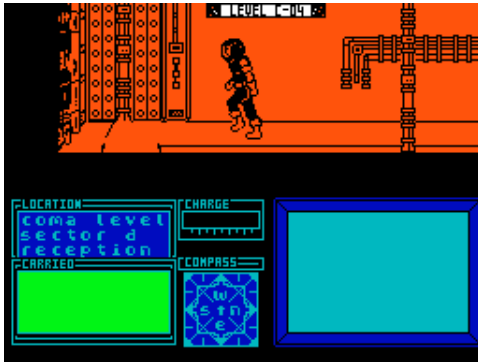

Marte Necesita Vacas (ALEAsoft,2004)
Arcade



Martianoids Map Editor (Matthew Carrier,2002)
Arcade Game Development Tool



MASK (Gremlin Graphics Software Ltd,1987)
Arcade

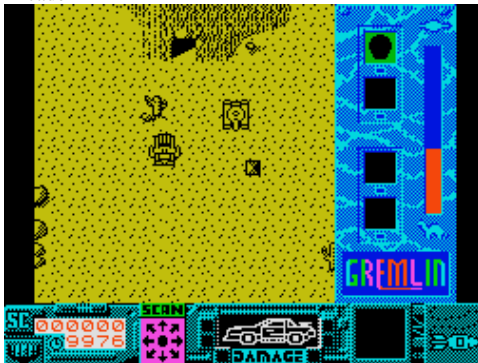

Marooned! (Outlet Microdrive Magazine.)
Text Adventure



Mars Red (THD,1992)
Arcade

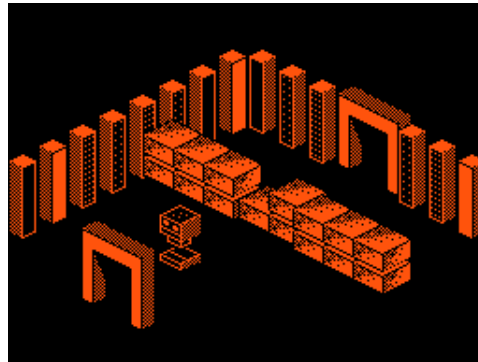

Martian KO (Sinclair Research Ltd,1982)
Arcade

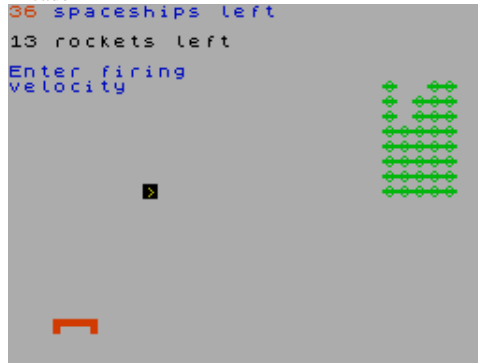

Maru-ja (Beyker Soft,2006)
Arcade

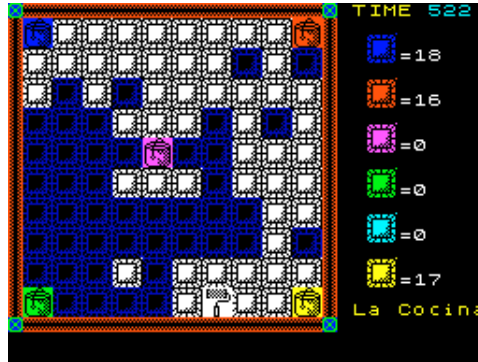

MASK II (Gremlin Graphics Software Ltd,1987)
Arcade



Marooned (Zenobi Software,1992)
Text Adventure

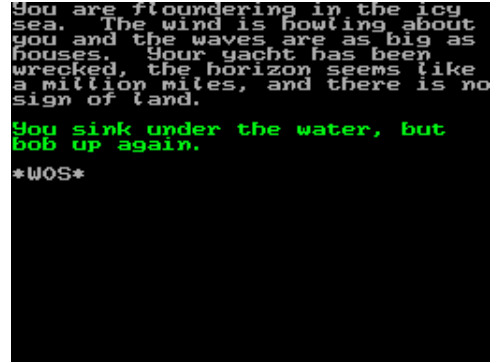

Marte (MicroHobby,1986)
Arcade



Martianoids (Ultimate Play The Game,1987)
Arcade

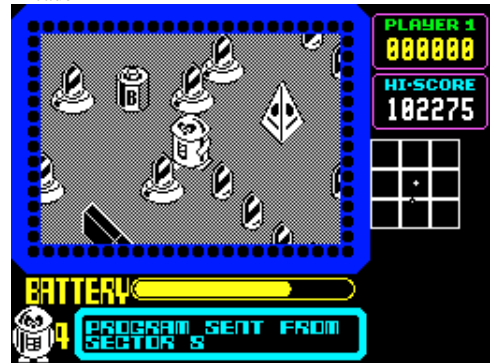

Marwin's Gallery (K3L Corp,1997)
Scene Demo

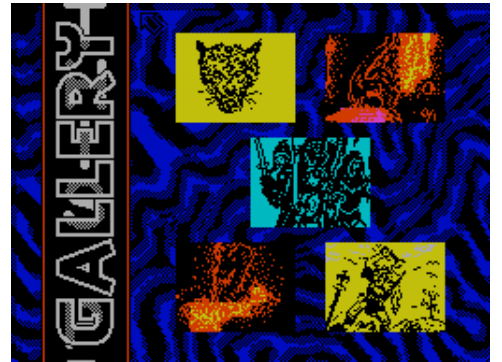

MASK III: VENOM Strikes Back (Gremlin Graphics Software Ltd,1988) Arcade



Master 4 (.)
Board/Card Game

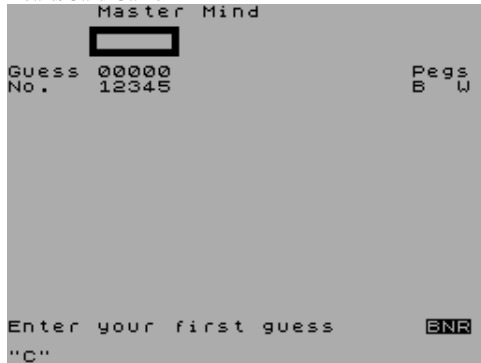

Master Brain (Crash,1991)
Board/Card Game

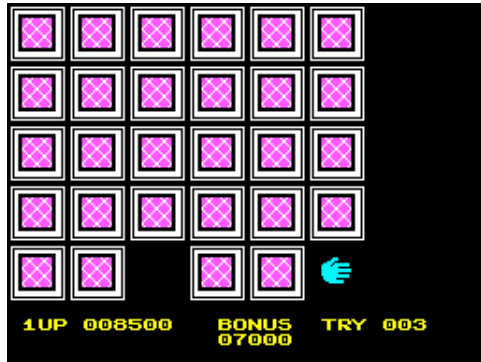

Masterclass (Trinity Software,1985)
Text Adventure

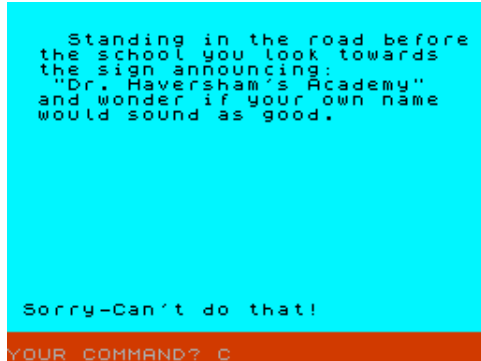

Mastercopy (Vatroslav Sobot,) Utility: Copier

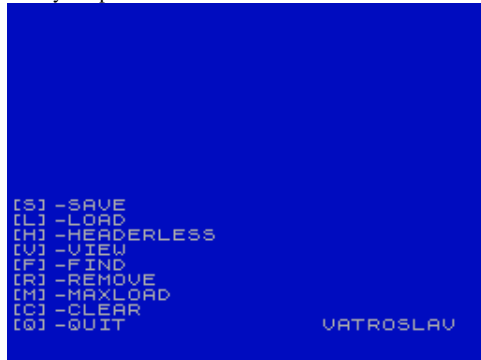

Master Face (MicroHobby,1986)
Arcade



Master and Servant (Atlantis Software Ltd,1985)
Arcade Adventure



Master Chess (Mastertronic Ltd,1987)
Board/Card Game

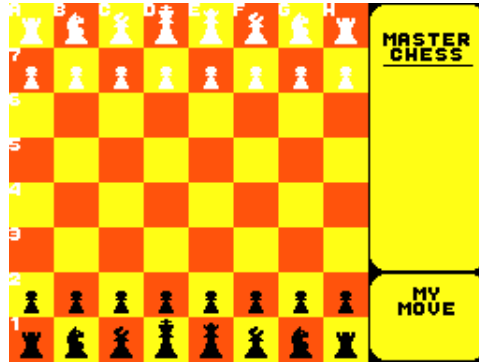

Mastercode (Bamby Software,1983)
Arcade

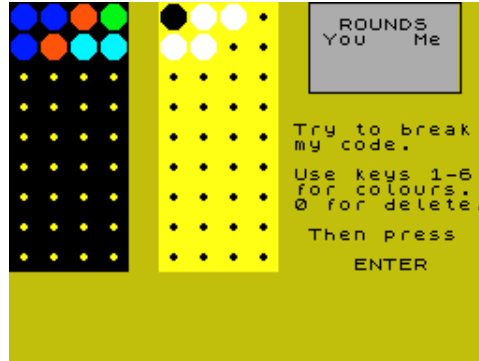

Mastercopy128 (Vatroslav Sobot,1994)
Utility: Copier



Masterfile (Campbell Systems,1982)
Utility: Database



Master Blaster (Crash,1990)
Arcade



Masterchess (Mikro-Gen Ltd,1983)
Board/Card Game

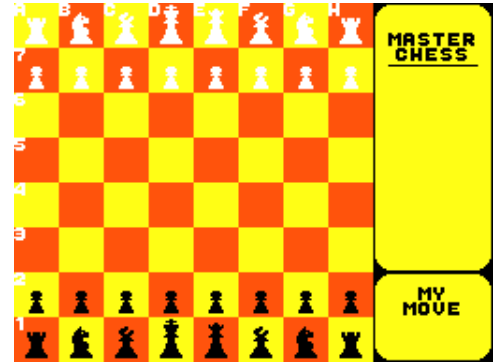

Master-Copy (.)
Utility: Copier



Master Cutler (Dee-Kay Systems,1984)
Simulation

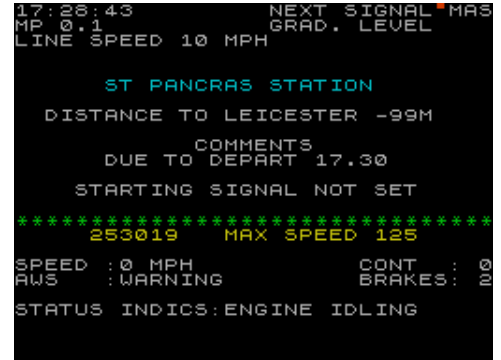

Masterfile +3 (Campbell Systems,1987)
Utility: Database

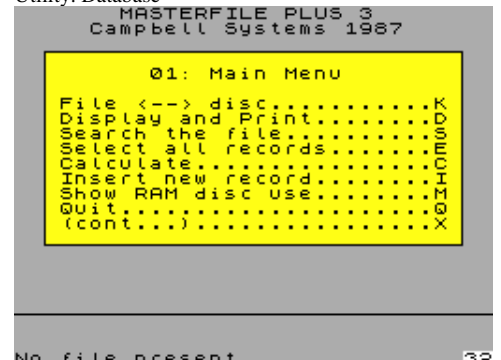

Master Game, 3D (Supersoft,1983)
Board/Card Game

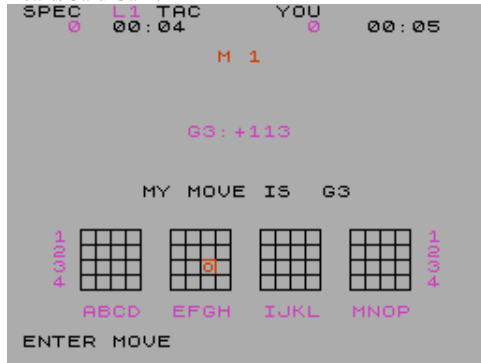

Master Mariner (Atlantis Software Ltd,1984)
Simulation

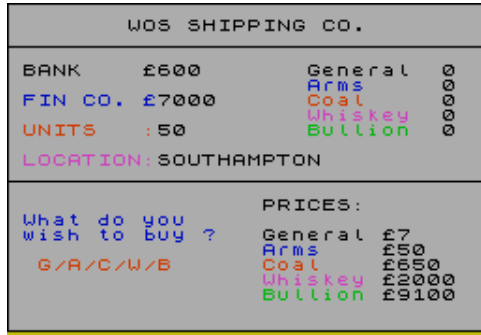

Master Mind (Ediciones y Textos S.A.,1985)
Board/Card Game



Mastermind (Laszlo Nyitrai,1998)
Board/Card Game



Mastermind (Purple Studios,2006)
Board/Card Game



Master Golf (MicroHobby,1986)
Arcade



Mastermat (Nikolaus Sollinger,)
Utility: Mathematics

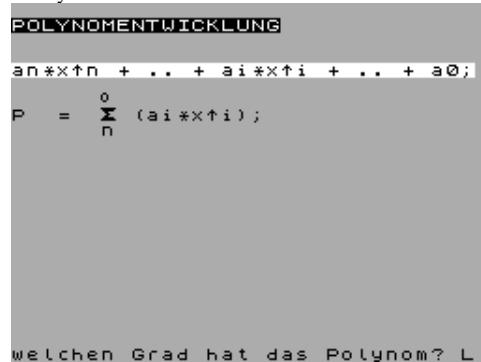

Mastermind (Granada Publishing,)
Strategy

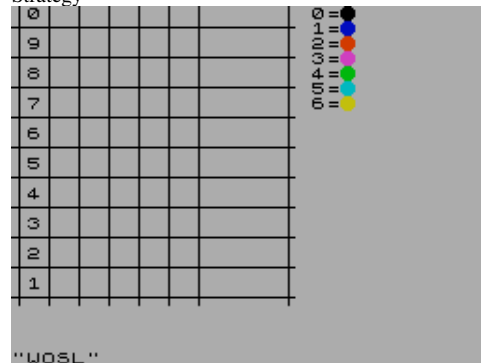

Mastermind (Mama Software,1986)
Board/Card Game



Mastermind (Taurus Computer Design,1982)
Board/Card Game



Master Logic (Bartle Electronics,1986)
Board/Card Game



Mastermind (Contrast Software,1983)
Board/Card Game

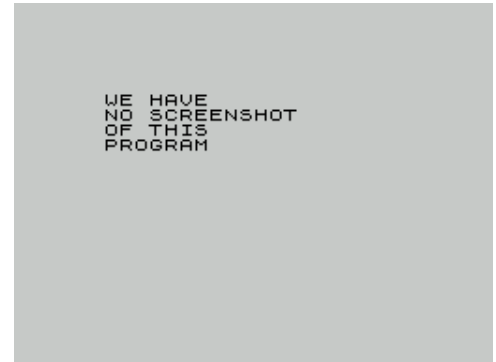

Mastermind (Gustavo Brown Rodriguez,2003)
Arcade



Mastermind (M.S. Boboli M.Sc.,1983)
Board/Card Game



Master Mind (Werner Spahl,1983)
Board/Card Game

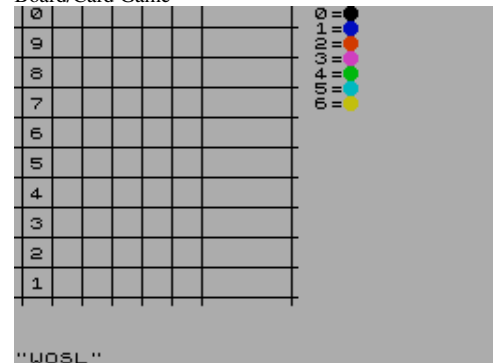

Mastermind 128K (Laszlo Nyitrai,1998)
Board/Card Game

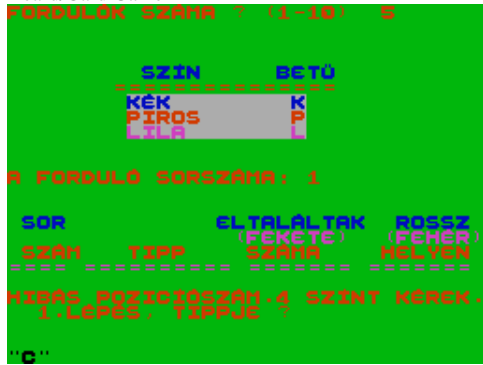

Mastermide (.)
Board/Card Game

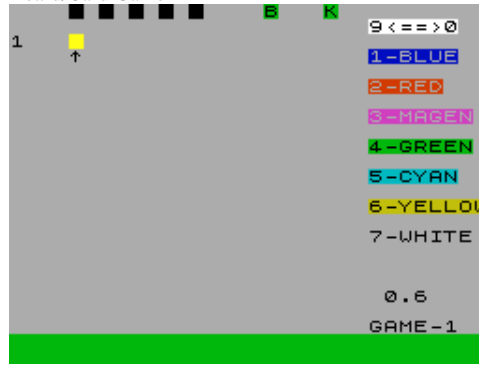

Master of Magic (Mastertronic Added Dimension,1986)
Arcade



Master of Orion (Phantom Family Corp,1997)
Arcade

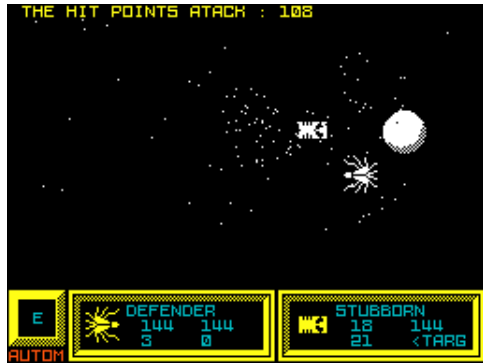

Master of the Rings (Meow Micros,1983)
Arcade



Masters of Serebal (MC Lothlorien Ltd,1984)
Strategy

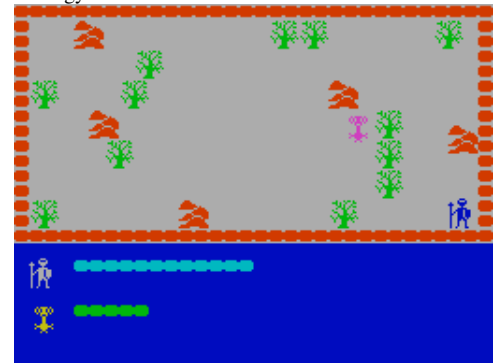

Masters of the Universe - The Arcade Game (US Gold Ltd,1987) Arcade



Masters of the Universe - The Movie (Gremlin Graphics Software Ltd,1987) Arcade Adventure



Masters of the Universe - The Super Adventure (US Gold Ltd,1987) Text Adventure

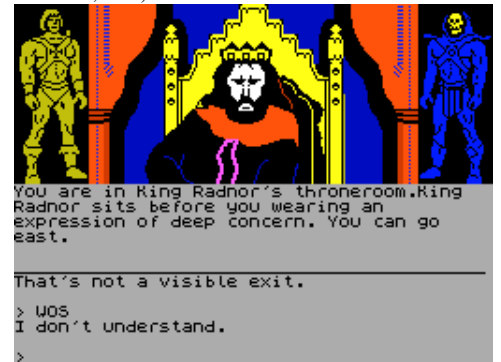

Master, The (Artic Computing Ltd,1986)
Arcade



Master Toolkit (Oxford Computer Publishing,1983)
Utility



Mastertronic Collection 1 (Woolworths.)
Compilation



Mastertronic Collection 10 (Woolworths.)
Compilation

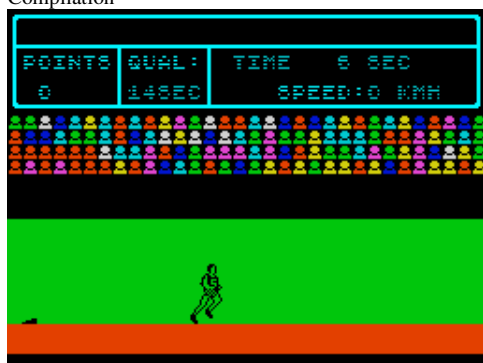

Mastertronic Collection 11 (Woolworths.)
Compilation



Mastertronic Collection 12 (Woolworths.)
Compilation



Mastertronic Collection 2 (Woolworths.)
Compilation



Mastertronic Collection 5 (Woolworths.)
Compilation



YOU STAND ON A VAST PLAIN. A MYRIAD OF TINY CREATURES SCURRY ABOUT. THE PLACE IS TEEMING WITH LIFE. A SWEET SMELL IN THE AIR. THE SCIMITAR LIES ON A MOSSY PLINTH.

Mastertronic Collection 8 (Woolworths.)
Compilation



Mastertronic Compilation 4 (Mastertronic Ltd.)
Compilation



Match Day (Ocean Software Ltd, 1985)
Sport



Mastertronic Collection 3 (Woolworths.)
Compilation



Mastertronic Collection 6 (Woolworths.)
Compilation



Mastertronic Collection 9 (Woolworths.)
Compilation



Mastertronic Compilation 4 (Mastertronic Ltd.)
Compilation

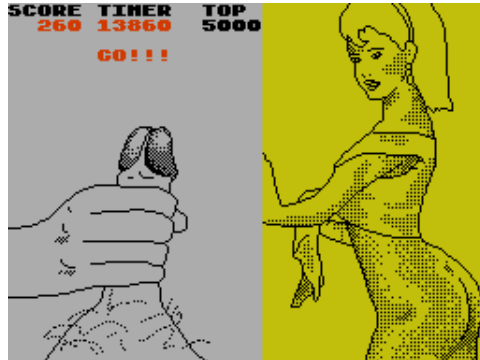

Match Day II (Ocean Software Ltd, 1987)
Sport



Mastertronic Collection 4 (Woolworths.)
Compilation

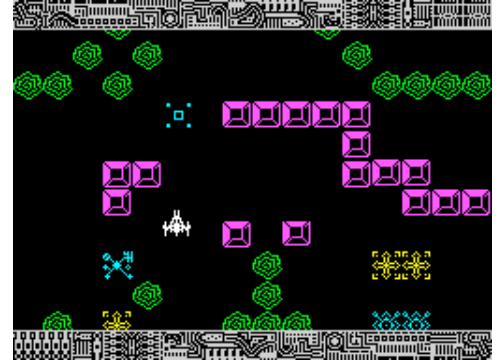

Mastertronic Collection 7 (Woolworths.)
Compilation



Mastertronic Compilation (Mastertronic Ltd.)
Compilation

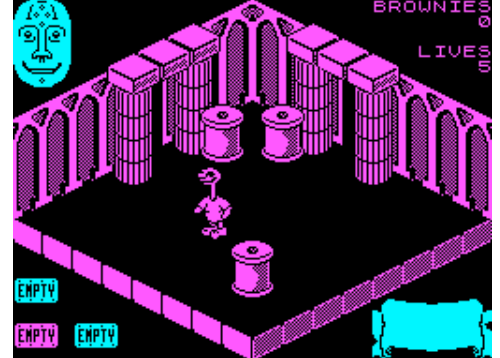

Master Word (Hill MacGibbon, 1984)
Strategy



Matching Pairs (CCS, 1984)
Board/Card Game

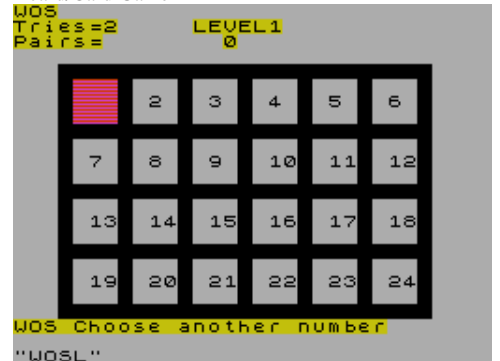

Matching Pairs (Tartan Software,) Board/Card Game



Match of the Day (Zeppelin Games Ltd,1992) Sport



Matematicas (Investronica S.A.,1983) Educational



Matematyka (Janusz Gajewicz,1986) Utility: Mathematics



Mathematics (Homestudy Ltd,1984) Educational



Matchmaker (River Software,1987) Text Adventure

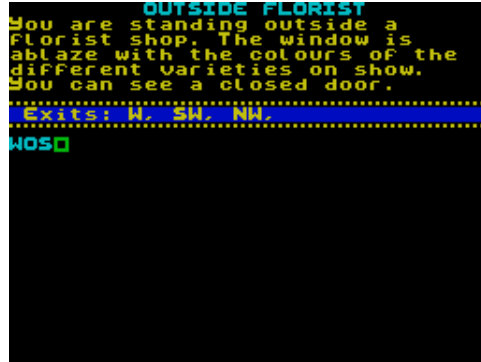

Match Point (Sinclair Research Ltd,1984) Sport

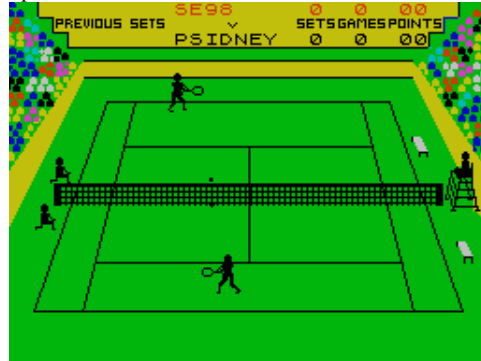

Matematik (ZX Data,1984) Utility: Mathematics

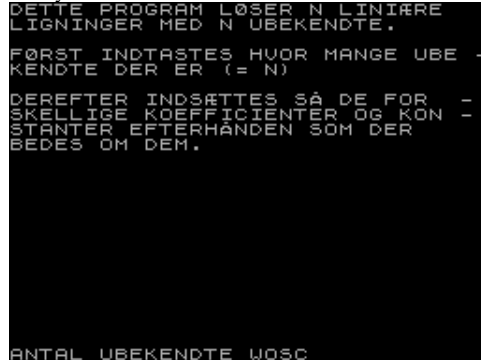

Math (Rarari Software,1983) Educational

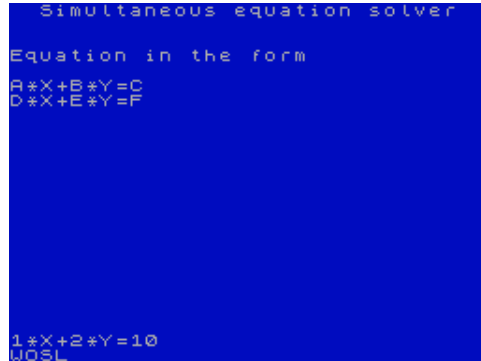

Mathematics (University Software,1983) Utility: Mathematics

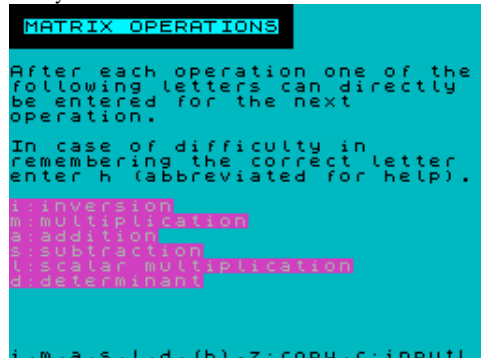

Matchmaze (BIBLEchip,1985) Board/Card Game

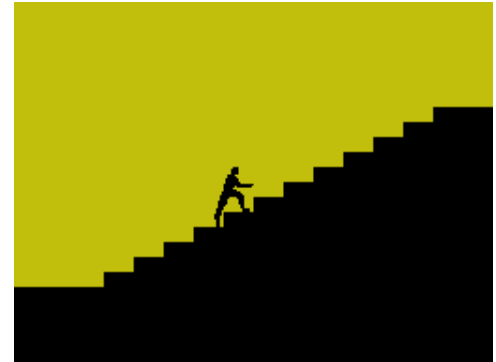

Match, The (Cult Games,1991) Simulation



Matematika (,1983) Utility: Mathematics

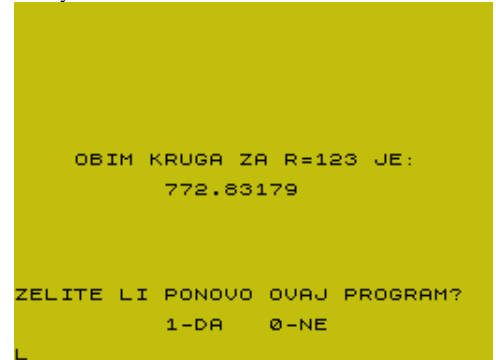

Mathematics (Charles Letts & Co,1985) Educational



Mathematics 1 (Roy Eastwood,1985) Utility: Mathematics



Mathematics - 8-11 Yrs (Micro-De-Bug Consultancy,1984) Educational



Mathematics - O-Level Revision and CSE (Longman Software,1984) Educational

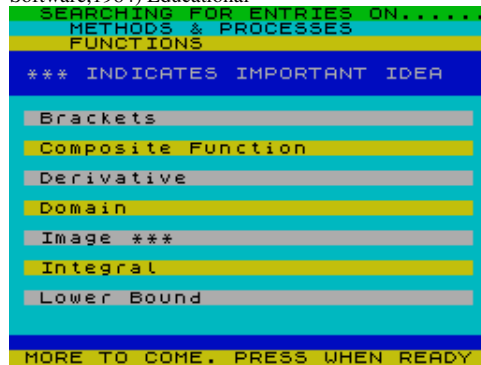

Maths (Hill MacGibbon,1986) Educational

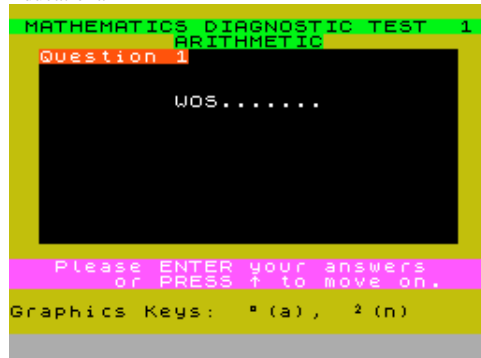

Maths Box 1 (Boxoft,1987) Educational



Maths Farm (Sinclair Programs,1984) Educational



Mathematics - Examination Practice & Tests O Level (Sphere Software,) Educational

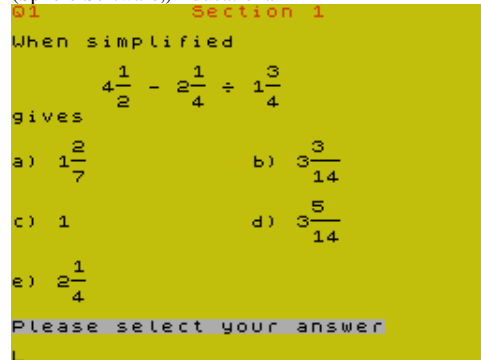

Mathematik (Uwe Haferland,1984) Educational

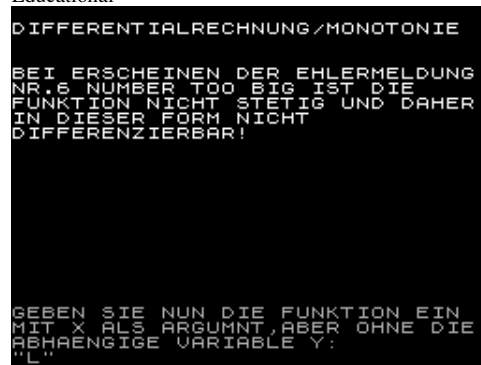

Maths (Longman Software,1984) Educational



Maths Box 2 (Boxoft,1987) Educational



Maths Invaders (Stell Software,1984) Educational



Mathematics 'O' Level (Calisto,1983) Educational

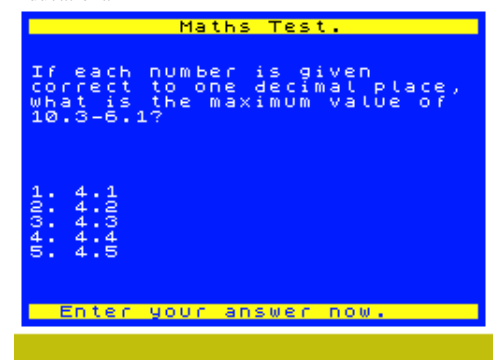

Maths (Educational Software,1985) Educational



Maths - 12-14 Yrs (Micro-De-Bug Consultancy,1984) Educational



Maths - CSE (Micro-De-Bug Consultancy,1984) Educational



Mathskills I (Griffin Software,1984) Educational

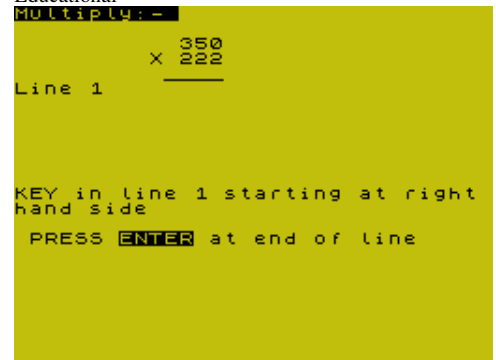

Mathskills II (Griffin Software,1984)

Educational

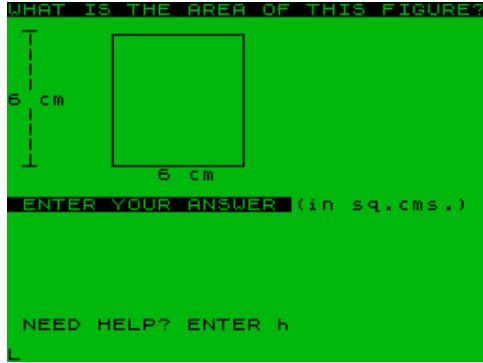

Matma (Elkor Software,)

Educational



Matrices y Sistemas Lineales (ABC Soft,1984)

Educational

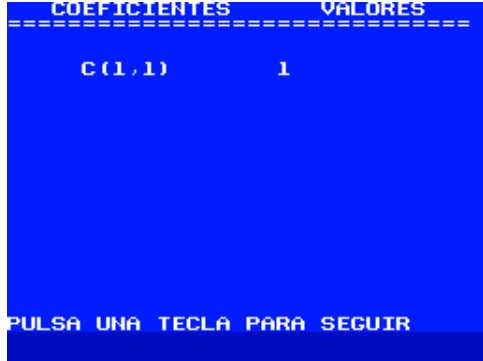

Matrix (MicroHobby,1986)

Board/Card Game



Maverick (CCS,1985)

Board/Card Game



Mathsted (CCS,1983)

Simulation

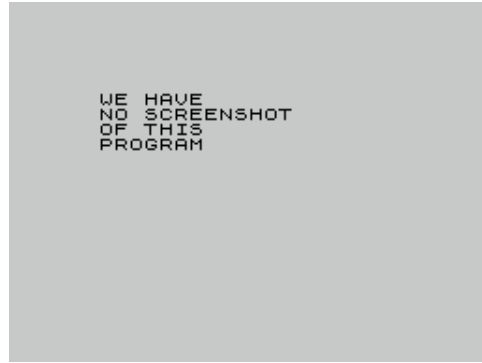

Matrices (MicroHobby,1985)

Utility: Mathematics



Matrix (DKTronics Ltd,1983)

Arcade



Matrix Operations (University Software,1983)

Utility: Mathematics

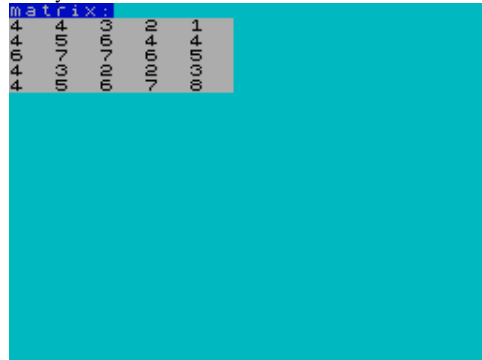

MAX (US Gold Ltd,1991)

Compilation



Maths Tutor for the Spectrum (Century Communications Ltd,1984)

Educational



Matrices y Ecuaciones (MicroHobby,1986)

Educational



Matrix (James Marrow,)

Board/Card Game

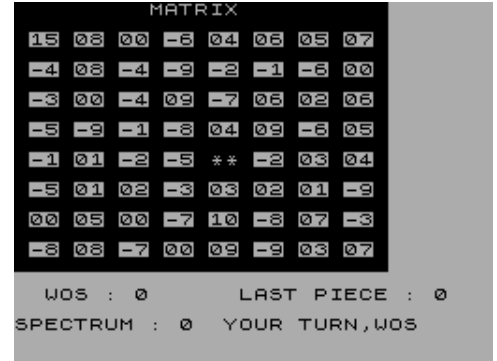

Matt Lucas (Players Software,1986)

Text Adventure



Max Demo (Tornado,1991)

Scene Demo



Max Desktop (Advanced Memory Systems Ltd,1987)
Utility



Maxim (Gogosoft,1986)
Utility: Copier



Mayhem (The Power House,1987)
Arcade

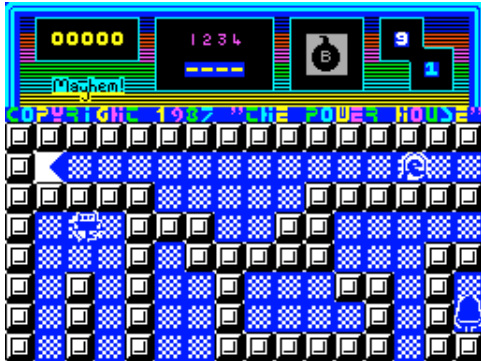

Maze (Timedata Ltd,1982)
Arcade

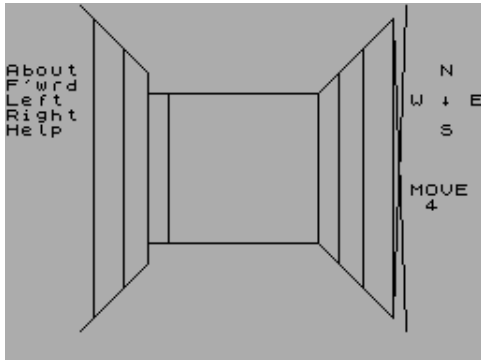

Maze, 3D (Impact Software [1],1982)
Arcade



Max Headroom (Quicksilver Ltd,1986)
Arcade Adventure



Maya Awari (Laszlo Nyitrai,2001)
Arcade



Maze (.)
Arcade

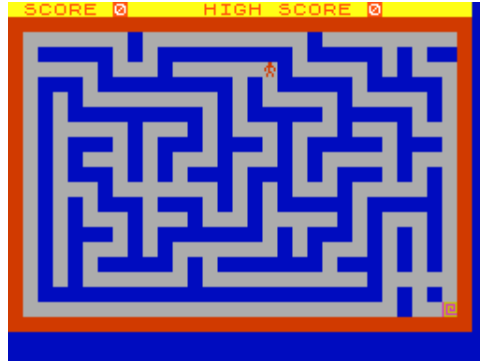

Maze, 3D (16/48 Tape Magazine,1984)
Arcade



Maze, 3D (Phipps Associates,1982)
Arcade



Maxicopy 1 (S.C.I.U.C.,1985)
Utility: Copier

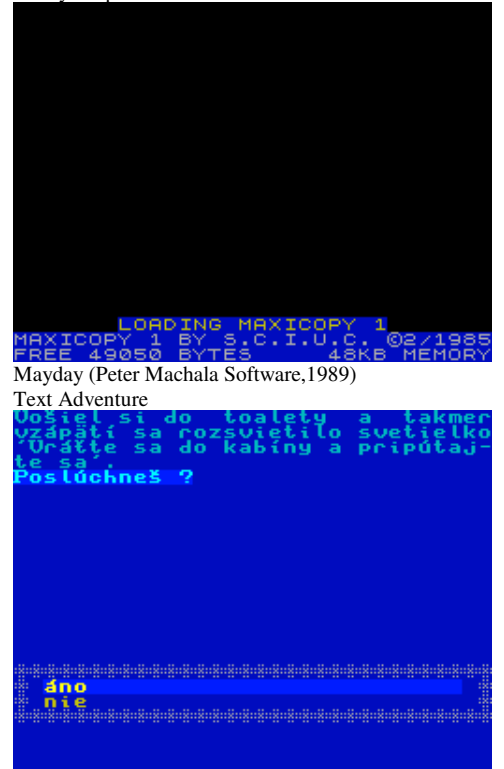

Mayday (Peter Machala Software,1989)
Text Adventure



Maze (Stell Software,.)
Arcade

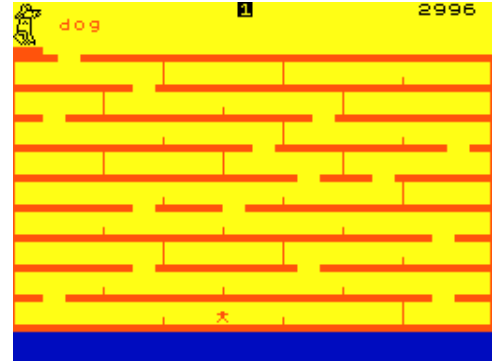

Maze, 3D (Fontana Publishing,1982)
Arcade

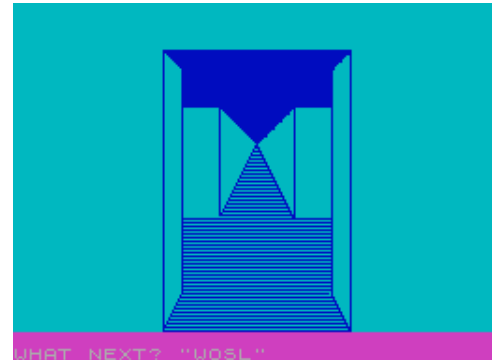

Maze, 3D (Spectrum Computing,1985)
Arcade

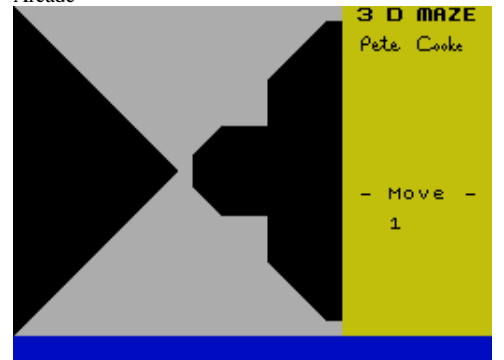

Mazeball (Wildest Dreams,1984)
Board/Card Game

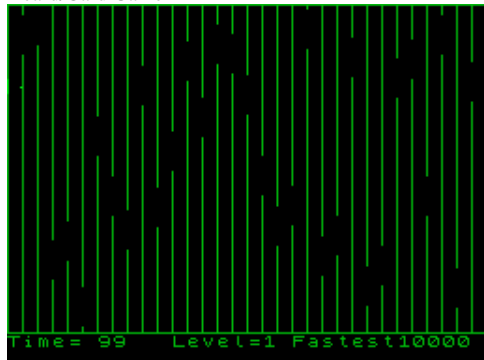

Maze Chase (Hewson Consultants Ltd,1983)
Arcade



Maze Death Race (PSS,1983)
Arcade



Mazeman (Abersoft,1983)

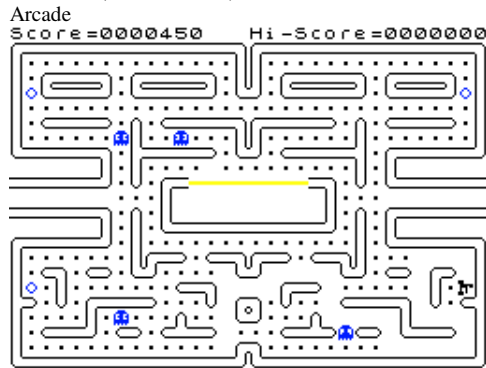

Maze Mania (Hewson Consultants Ltd,1989)
Arcade

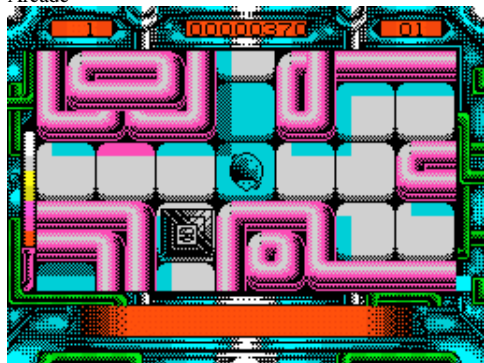

Mazechase (Contrast Software,1983)
Arcade

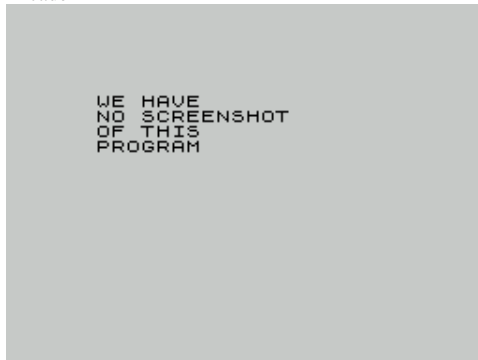

Maze Craze (Partyline Ltd,1985)
Arcade



Maze Fantasy (Spectre Soft,1984)
Arcade



Mazeman (Sinclair Programs,1984)

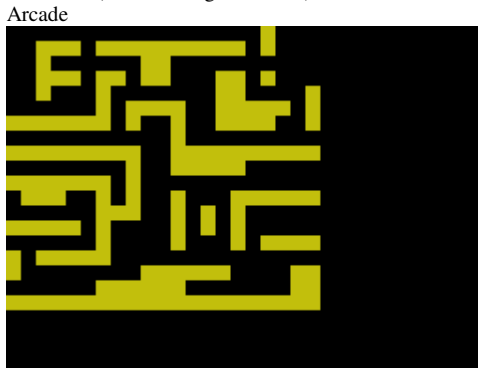

Maze Muncher (Wintersoft,1983)
Arcade



Maze Chase (Dorling Kindersley Software,1984)
Arcade



Mazecube (Pal Software,1984)
Arcade



Maze Generator (Spectrum Computing,1985)
Utility



Maze-man (ZX Computing,1982)

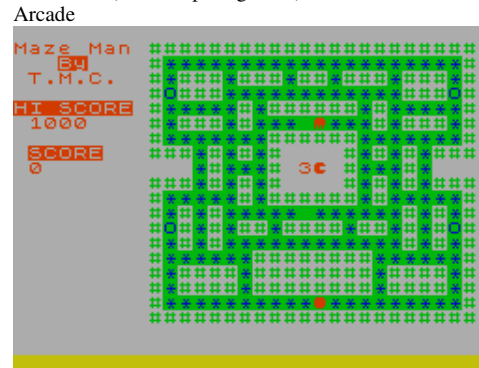

Mazenture, 3D (Softek Software International Ltd,1982)
Arcade



Maze of Darkness (16/48 Tape Magazine,1985)
Simulation

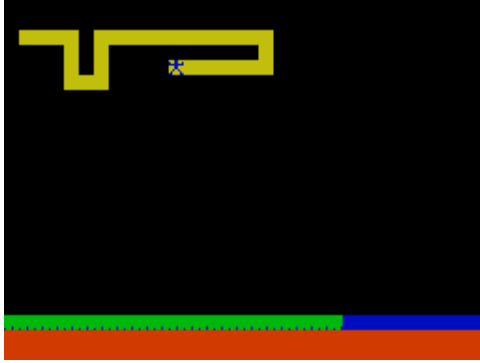

Maze of Gold, 3D (Gilsoft International,1982)
Arcade

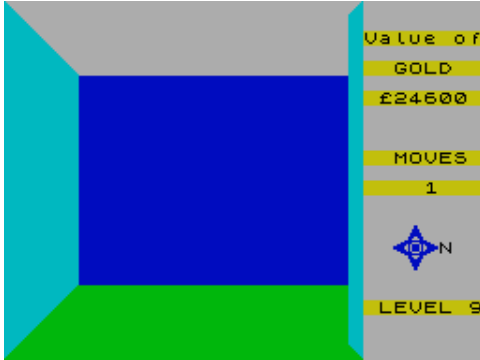

Maze, The (Clasic Software.)
Arcade



Maziacs (DK'Tronics Ltd,1983)
Arcade



M-C Library (R.D. Foord Software.)
Utility: Programming



Maze of Death, The (Spectrum Computing,1985)
Arcade

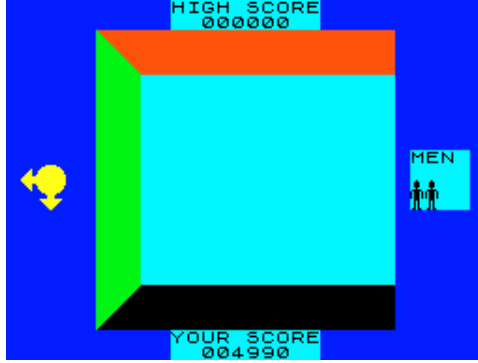

Maze of Terror (Kevin Hillyer,1986)
Text Adventure

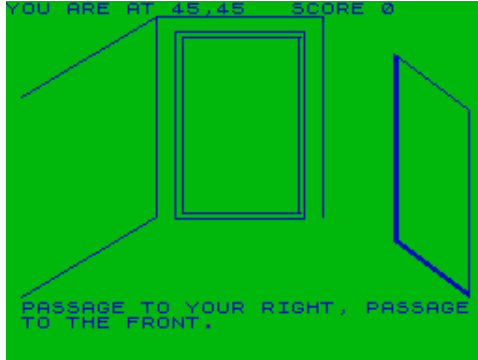

Maze, The (Your Computer,1985)
Strategy

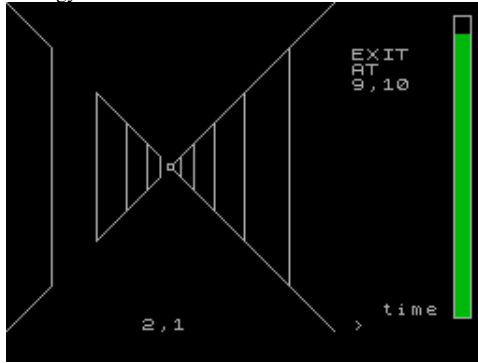

Mazing (Spectre Soft,1983)
Arcade

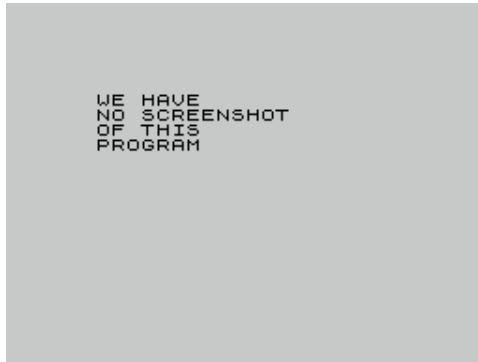

MC Monitor (.)
Utility: Assembler/Disassembler/Monitor



Maze of Delon, The (Kaisoft,1984)
Arcade

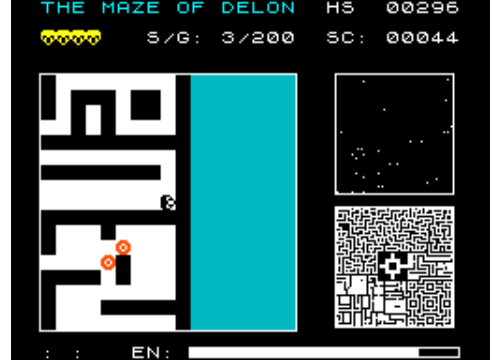

Maze Runner (Fontana Publishing,1984)
Arcade

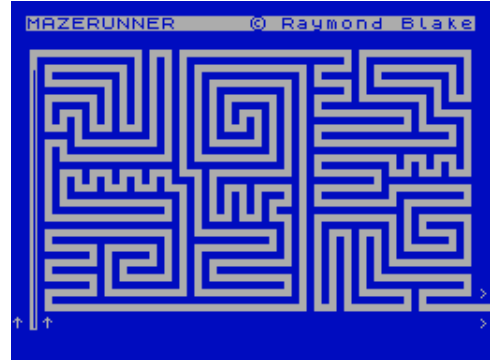

MazezaM (Malcolm Tyrrell,2002)
Arcade

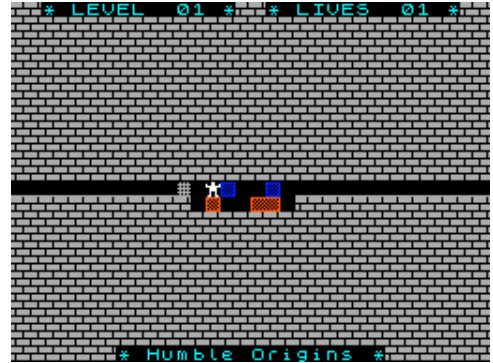

McKenzie (Software Projects Ltd,1983)
Text Adventure

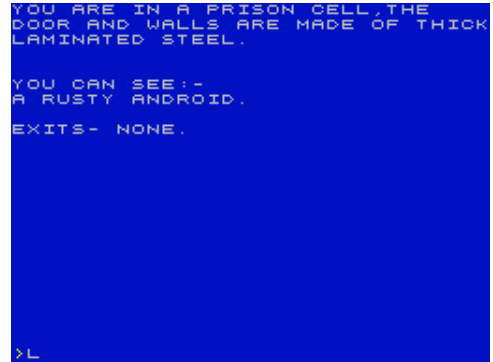

M/Code Library 1: Screen Compression (16/48 Tape Magazine,1985) Utility: Screen Manipulation

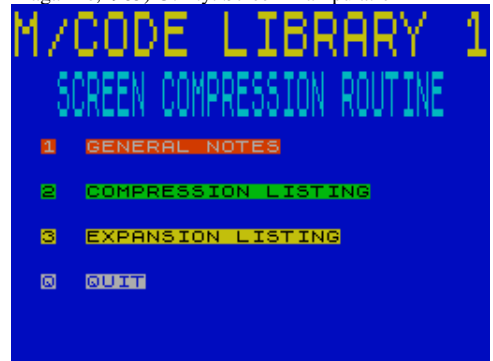

M/Code Library 2: Window Scrolling (16/48 Tape Magazine, 1985) Utility: Screen Manipulation

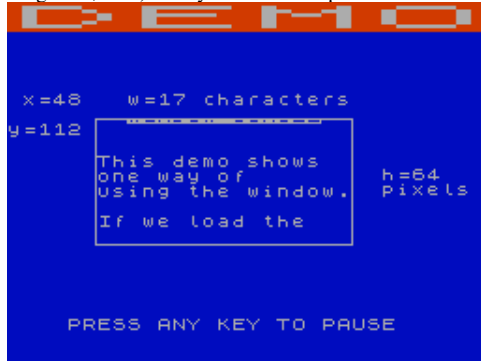

M/Code Library 5: Search and Find Routines (16/48 Tape Magazine, 1986) Utility: Programming



MCoder II (PSS, 1983) Utility: Programming

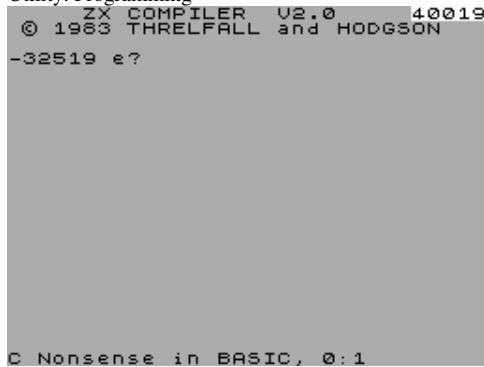

MC Trace (.)

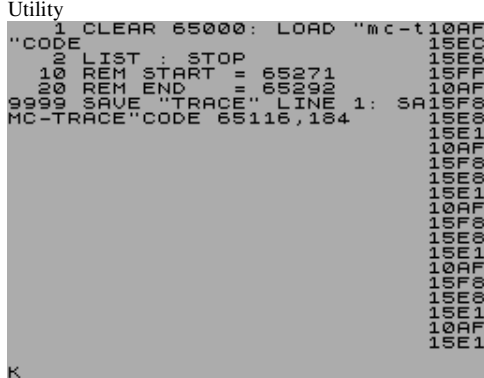

Mc Wash Goes Bathing (AC Data Games,)

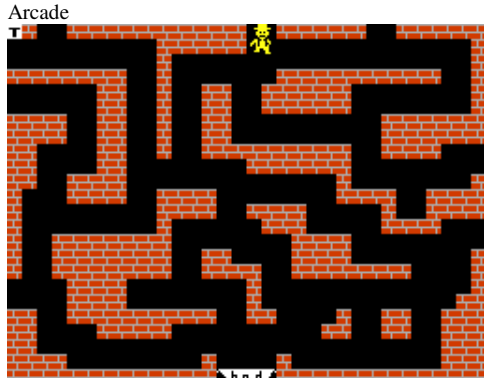

M/Code Library 3: Interrupt Driven Trace (16/48 Tape Magazine, 1985) Utility: Screen Manipulation

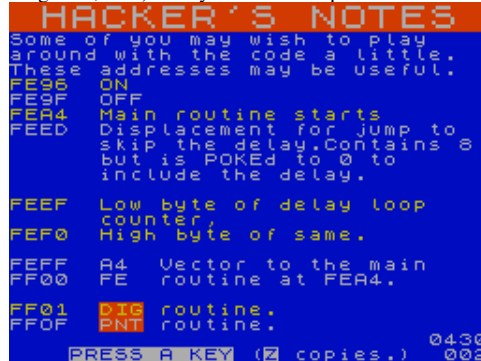

M/Code Library 6: Delete BASIC (16/48 Tape Magazine, 1986) Utility: BASIC Related



MCoder III (PSS, 1985) Utility: BASIC Related



MC Tutor (HanSoft, 1985)

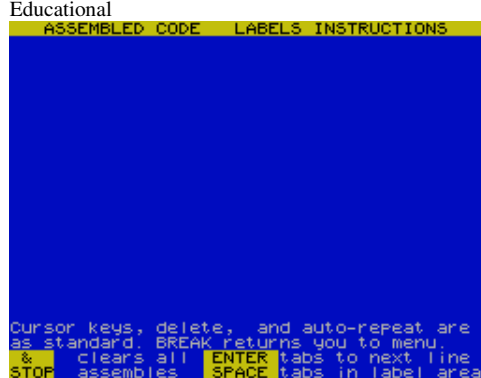

MDA Demo (Busy Software, 1991)

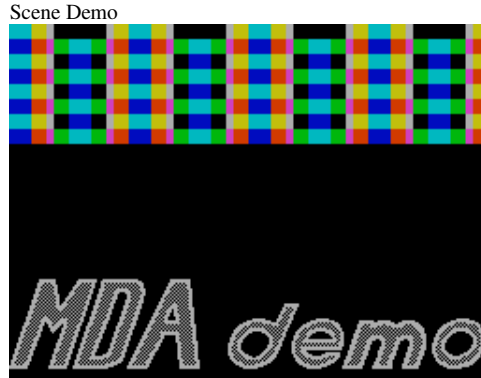

M/Code Library 4: Screen Swapping (16/48 Tape Magazine, 1985) Utility: Screen Manipulation



MCoder (PSS, 1983)

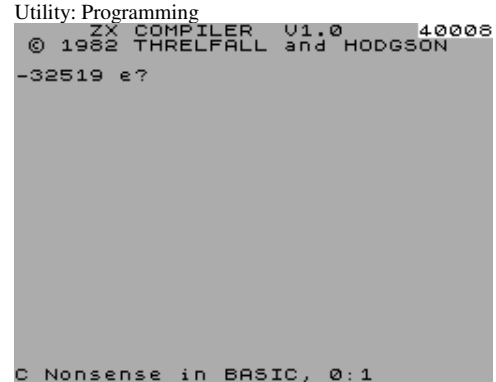

MCoder II Linker (Zeljko Juric, 1988) Utility: BASIC Related

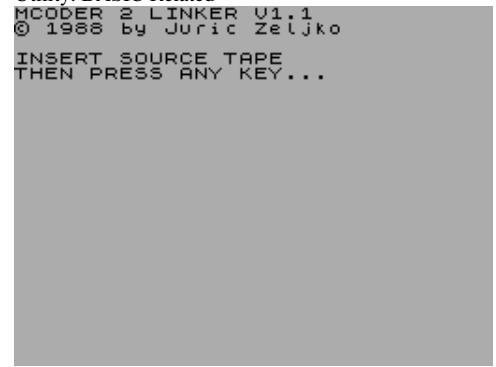

Mc Wash (Bensoft, 1985)

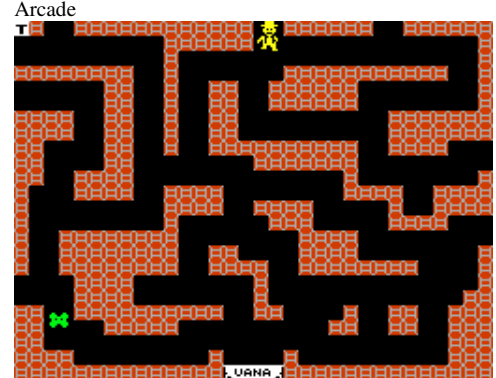

M-Doc (Seven Stars Publishing, 1985)

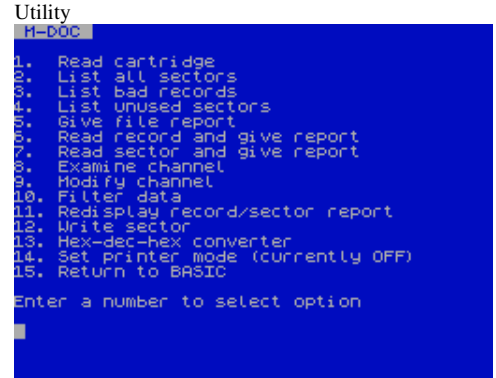

MD Spy (ZX-Guaranteed,1985)
Utility

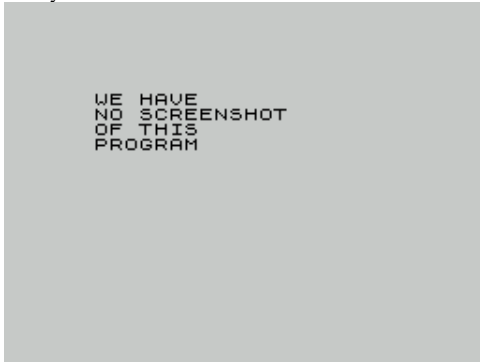

Mecanico, El (Software Editores,1986)
Utility



Mega 4 (Topo Soft,1991)
Compilation



Mega Bert (Your Sinclair,1986)
Arcade

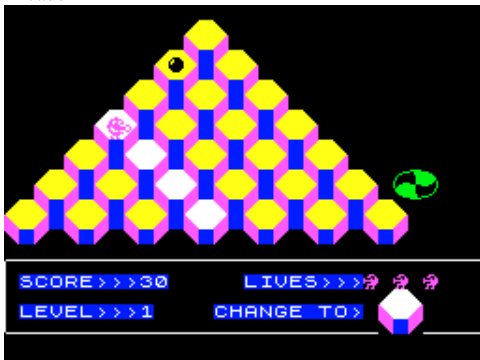

Mega Box (Dinamic Software,1990)
Compilation



Mean Machines (Code Masters Ltd.)
Arcade

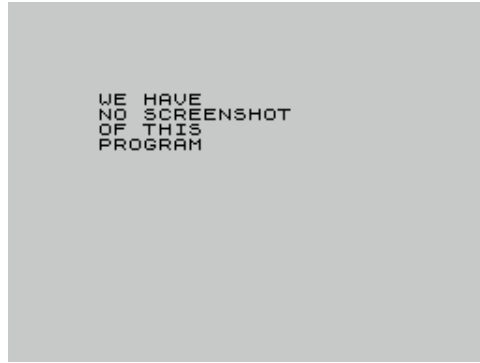

Mechanic Harry (Questsoft,1984)
Text Adventure

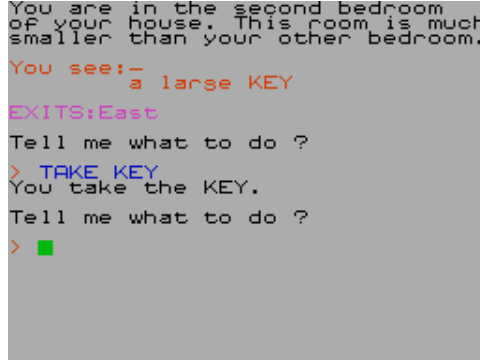

Mega-Apocalypse (Martech Games Ltd,1988)
Arcade



Megablast! (Your Sinclair,1990)
Arcade

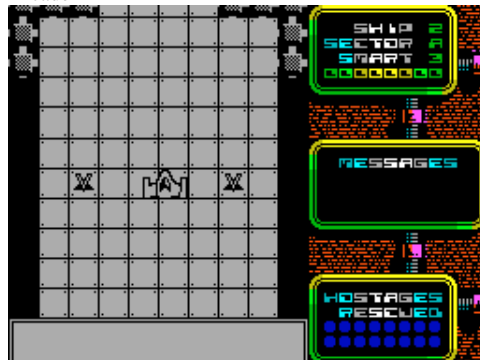

Mega Box 2: McWiril Collection (Dinamic Software,1992)
Compilation



Mean Streak (Mirrorsoft Ltd,1987)
Arcade

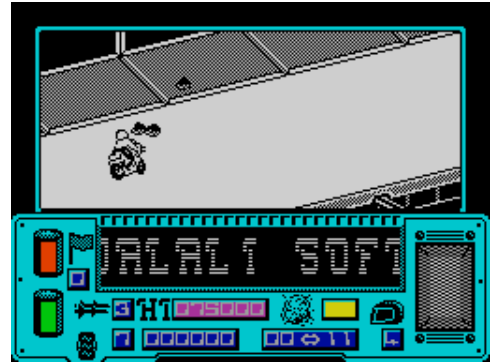

Meeting (The Unbelievables,1993)
Scene Demo



Megaball (Digital Reality [2],1996)
Arcade

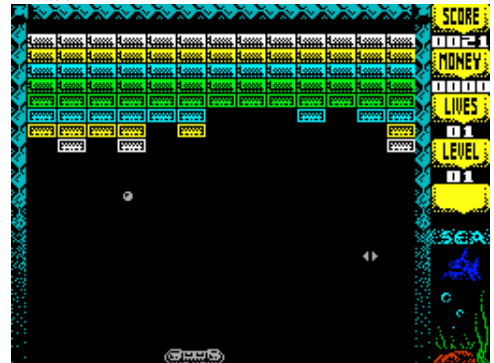

Mega Boom (Alliance Team,1999)
Arcade

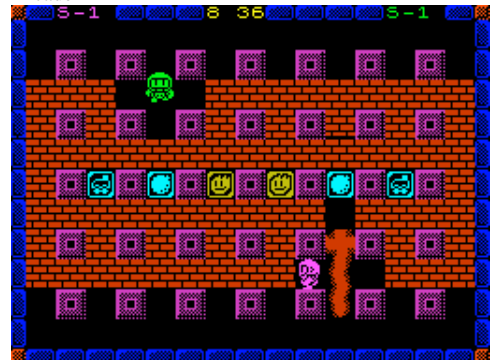

Mega-Bucks (Firebird Software Ltd,1986)
Arcade Adventure



Mega Chess (Iber Software,1988)
Board/Card Game



Mega Color Lines (Mortal Kombat Hackers Group,1995)
Board/Card Game

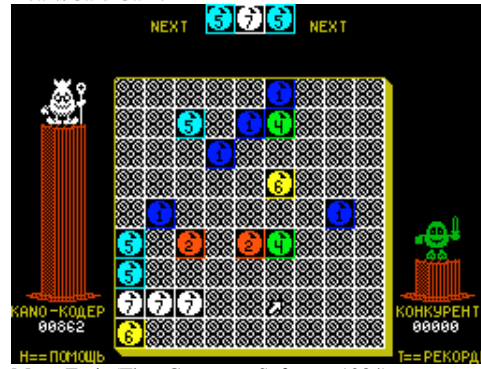

Mega-Corp (Dinamic Software,1987)
Text Adventure



Megadisk (KobraSoft,1991)
Utility: Copier



Mega Fruit (Thor Computer Software,1984)
Simulation

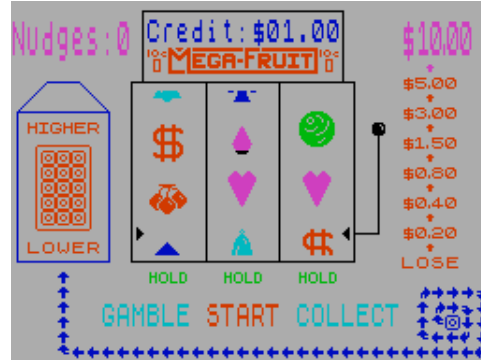

Mega-Hot (Code Masters Ltd.)
Compilation

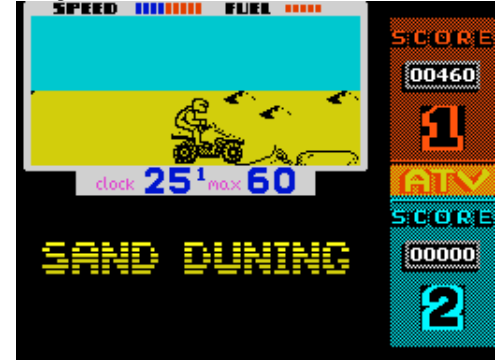

Megalith Man (Goltek Publications,1985)
Text Adventure



Megalomania (The Mad Guys,1993)
Scene Demo



Mega-Mazing (Data Design Systems,1985)
Compilation



Mega Mix (Ocean Software Ltd,1990)
Compilation



Meganova (Dinamic Software,1988)
Arcade



Megapede (Softek Software International Ltd,1983)
Arcade



Megaphoenix (Dinamic Software,1991)
Arcade

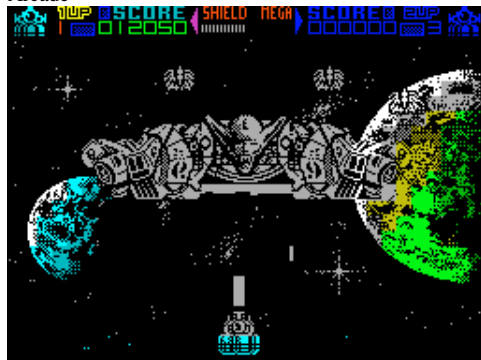

Megaplay 1 (Mastertronic Ltd,1988)
Compilation



Megaplay 2 (Virgin Mastertronic Ltd.)
Compilation



Megaplex (Cronosoft,2006)
Arcade



Mega Sports (Kixx,1992)
Compilation

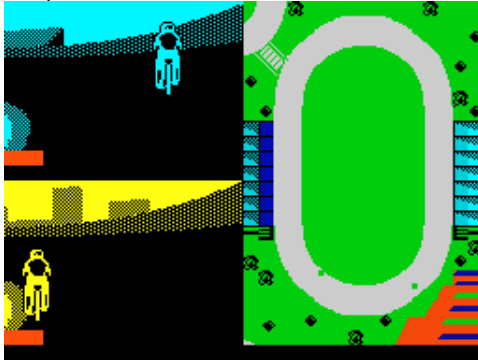

Mega Tron (Wizard Software,1993)
Arcade

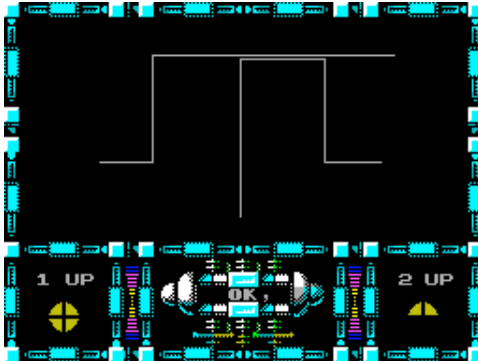

Mega Zone (,1984)
Arcade



Melody Music (Unisoft,1987)
Scene Demo



Mega Sound I (Studio Computerowe Koala,1991)
Scene Demo



Megasub Command (Ntd Software,1985)
Arcade

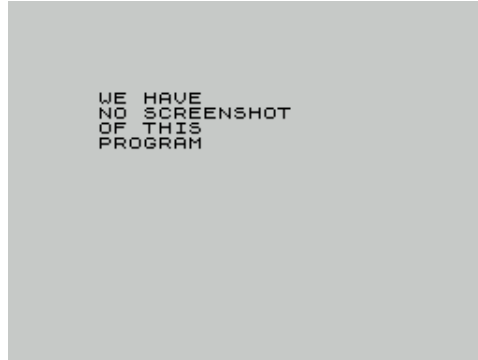

Mega Twins (US Gold Ltd.)
Arcade



Melbourne Draw (Melbourne House,1983)
Utility: Drawing

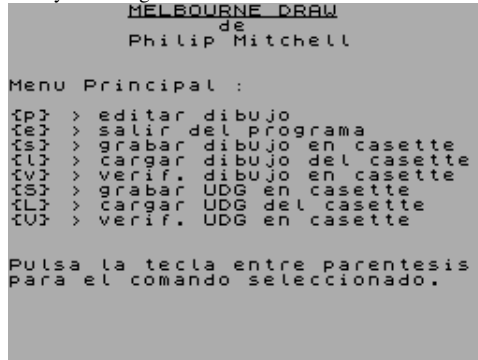

Melotron (Investronica S.A.,1985)
Utility



Mega Sound III (Studio Computerowe Koala,1991)
Scene Demo



Mega Tetris 2000 (Push & DGMS,1999)
Arcade

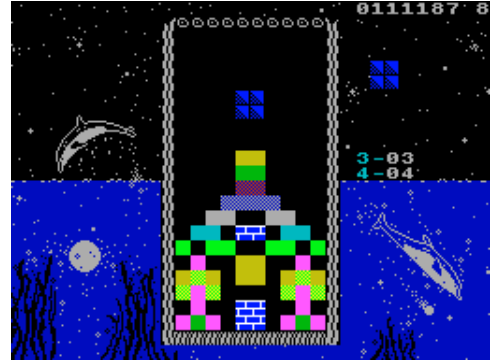

Mega Xonix (Dimitry Volvach,1994)
Arcade

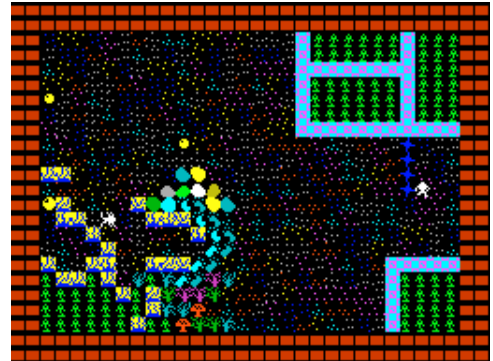

Melodian (Music Soft,1984)
Utility: Music Creation

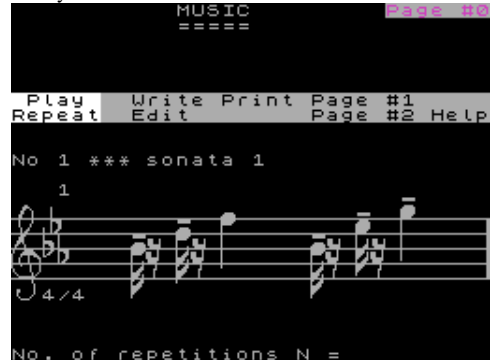

Meltdown (Kerian UK Ltd,1984)
Arcade



Meltdown (Zenobi Software,1993)

Text Adventure

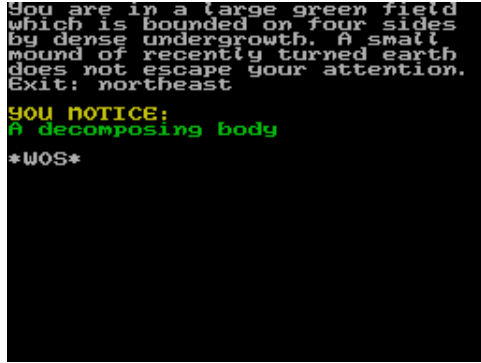

Memorias de un Hobbit (JSJ Soft Ltd,1989)

Text Adventure



Memoriom (MicroHobby,1985)

Board/Card Game

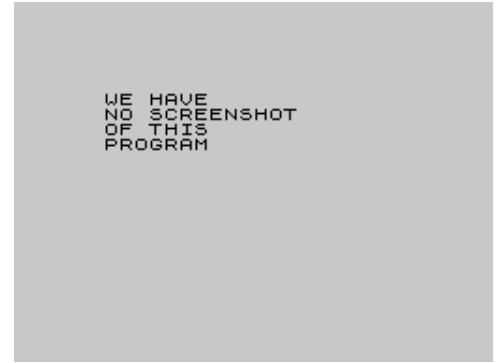

Memorion (MicroHobby,1986)

Arcade



Memory (Chris Gandler,1985)

Board/Card Game



Memory Blocks (Excellent Four Software,)

Board/Card Game

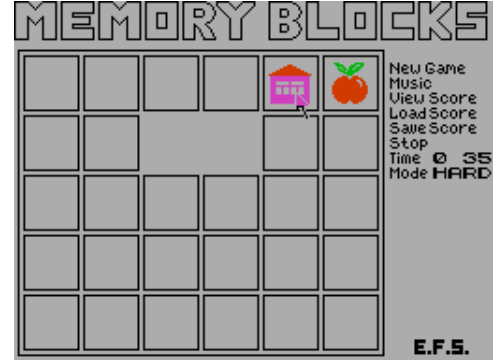

Memotest (.)

Utility



Mem-Test for Super-80 Spectrum (.)

Utility

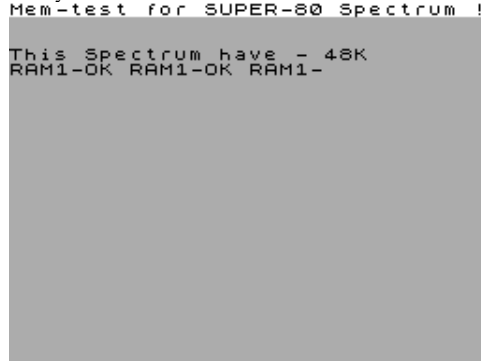

Me & My Micro (National Extension College Trust Ltd,1984)

Compilation

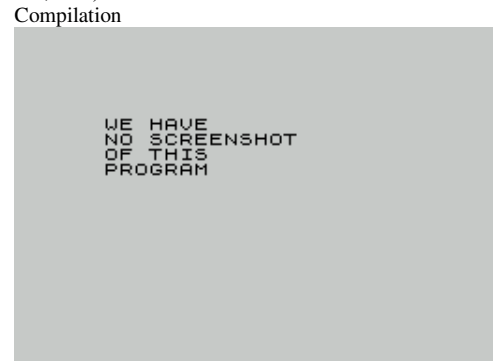

Menace (Fashionsoft,1983)

Arcade

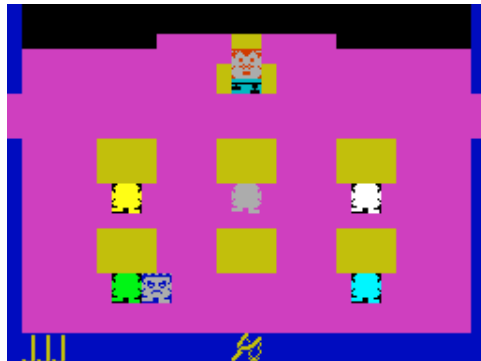

Menagerie, The (Stormbringer Software,1990)

Text Adventure

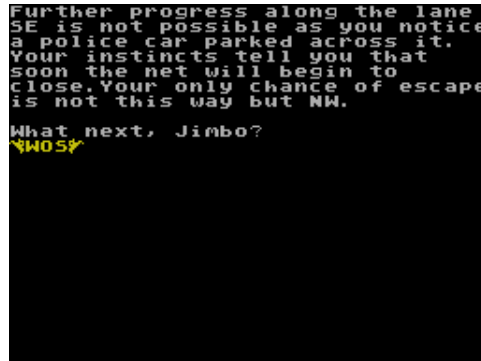

Mental Arithmetic (Griffin Software,1984)

Educational

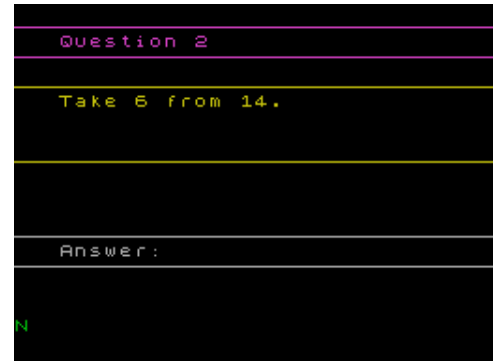

Mental Block (Your Sinclair,1992)

Board/Card Game



Mental Blocks - Frustration 2 (Impact Software [2],1995)

Board/Card Game

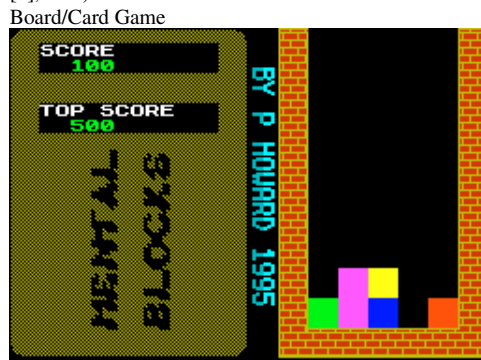

Mental Masturbation (Dream Makers Software,1996)

Scene Demo



Mentor (JK Gosden Software,1983)
Utility: Programming



Mercado (MicroHobby,1986)
Strategy



Mercs (US Gold Ltd,1991)
Arcade



Merkur Disc (Thomas Krueger,)
Simulation

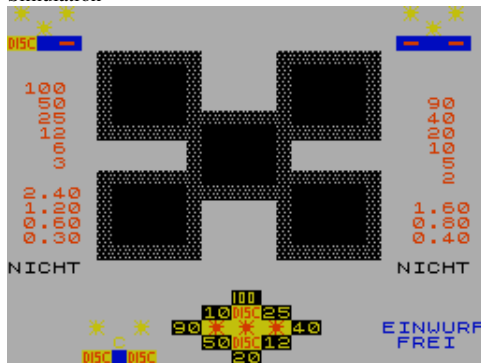

Merlin (The Guild,1992)
Text Adventure

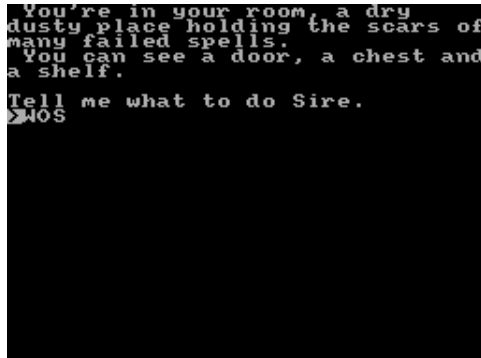

Mentura (Phantom Ltd,1994)
Text Adventure

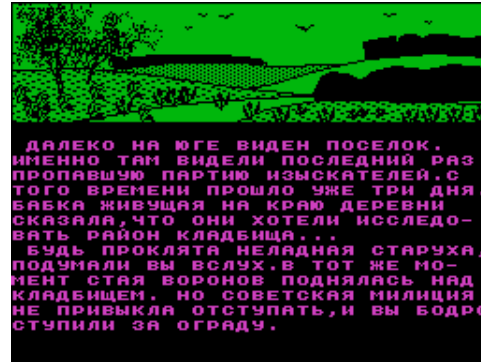

Mercenary: Escape from Targ (Novagen Software
Ltd,1987)
Arcade Adventure

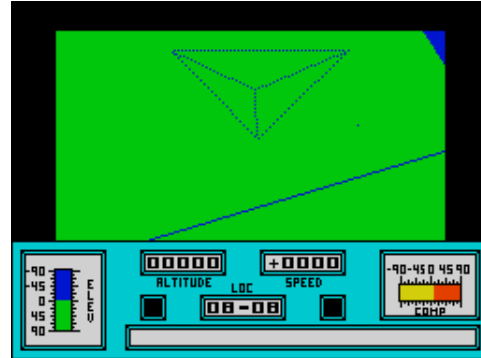

Merhownie's Light (K-Soft,1986)
Text Adventure

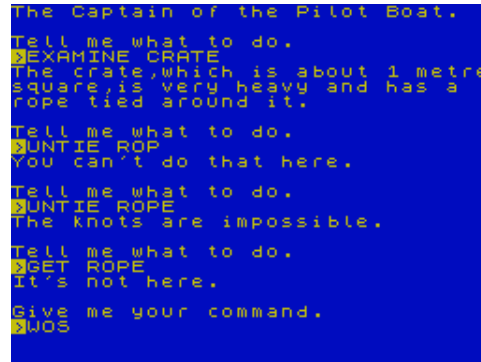

Merlin (Firebird Software Ltd,1988)
Arcade Adventure

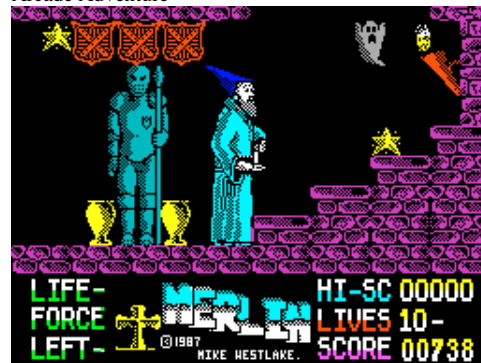

Merlock the Mede (Terminal Software,1985)
Text Adventure

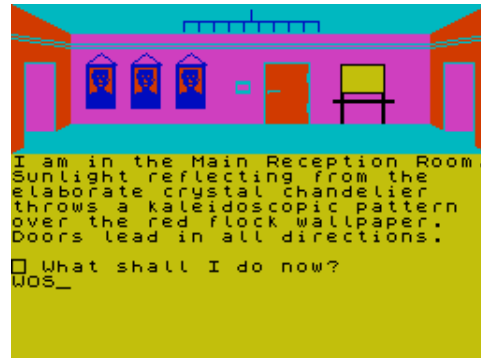

Menzer Syntezer (Dbiubanek Software,)
Utility: Music Creation

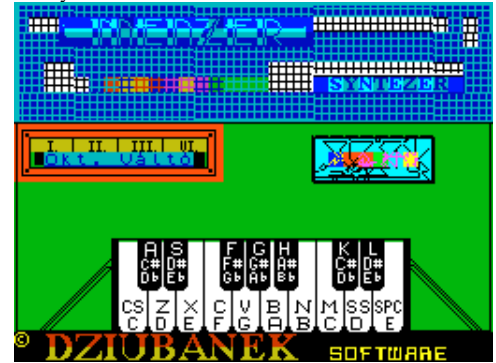

Mercenary: The Second City (Novagen Software
Ltd,1988)
Arcade Adventure

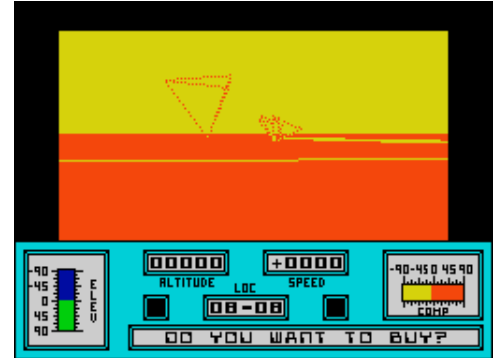

Merkkisaannot Ja Potenssit (Otava,)
Educational

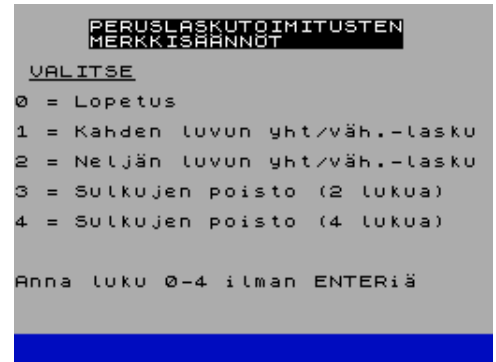

Merlin (Hobby Press S.A.,1988)
Arcade



Mermaid Madness (Electric Dreams Software,1986)
Arcade

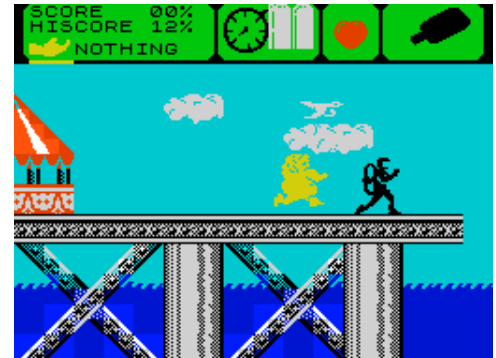

Merry Christmas (.)
Scene Demo



Message from Andromeda (Interceptor Micros Software,1986)
Text Adventure



Mesto Robotu (Zenitcentrum HZ UV SSM,1989)
Text Adventure

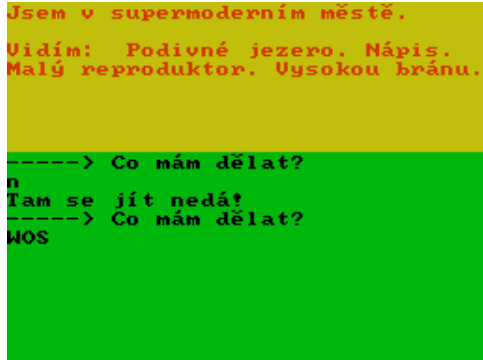

Metal Action (Dinamic Software,1989)
Compilation

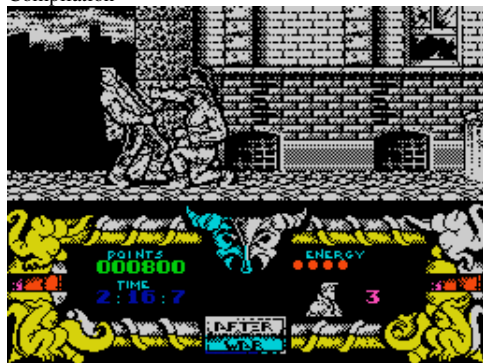

Metalyx (Alternative Software Ltd,1987)
Arcade



Merry Go Round (Dee-Kay Systems,1985)
Simulation

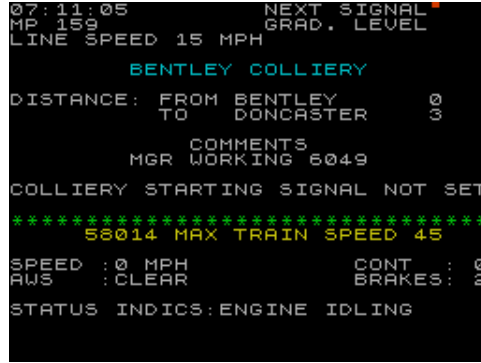

Messier List (Eclipse Software,1985)
Educational



Metabolis (Gremlin Graphics Software Ltd,1985)
Arcade



Metal Army (Players Software,1988)
Arcade

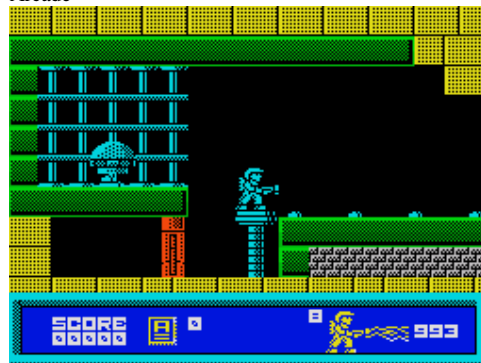

Metaplex (Addictive Games Ltd,1988)
Arcade



Merry Xmas Santa (Icon Software Ltd,1984)
Arcade



Mesta (Otto Adametz,1983)
Strategy



Meta-Galactic Llamas Battle at the Edge of Time (Salamander Software,1984)
Arcade



Metaldrone (Sparklers,1987)
Arcade

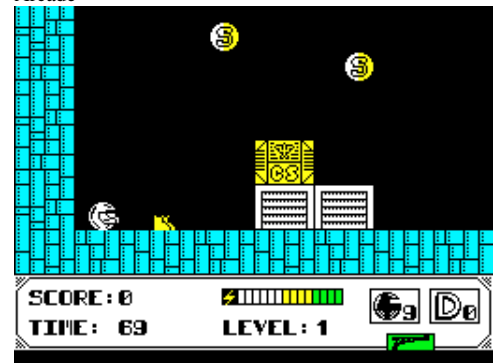

Metedatos (Sift,1984)
Utility



Meteor (Roland G. Hulsmann,1983)
Arcade

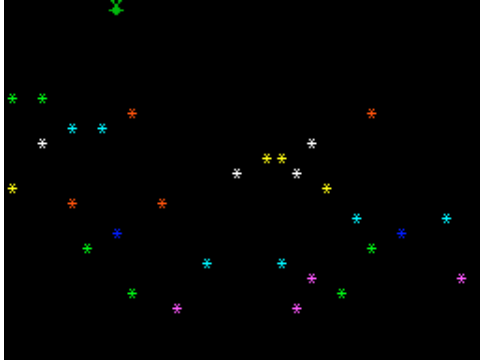

Meteor (Stephan Slabihoud,1986)
Arcade

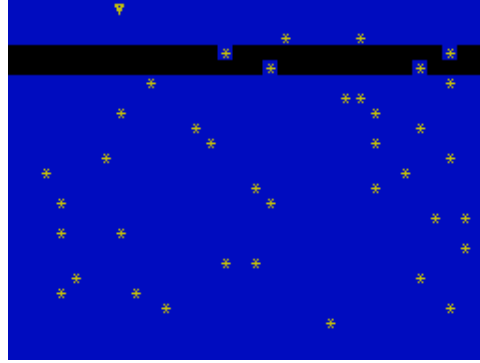

Meteorit (Birger Larsson,1986)
Arcade



Meteorite Strike (Kelsoft,1988)
Text Adventure



Meteoritos (Monser S.A.,1985)
Arcade



Meteor Mission (.)
Arcade



Meteoro (MicroHobby,1985)
Arcade



Meteoroids (DK'Tronics Ltd,1982)
Arcade

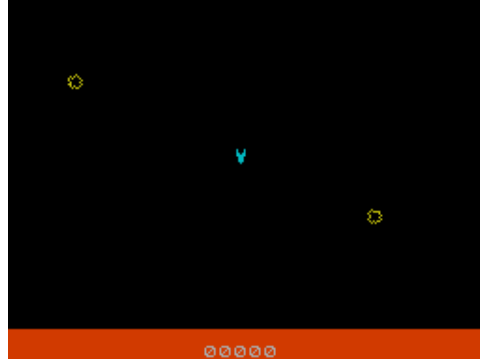

Meteoroids (Softek Software International Ltd,1982)
Arcade

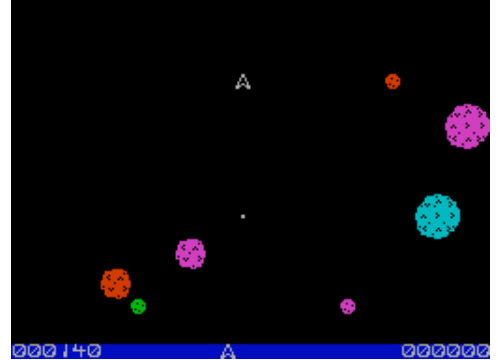

Meteor Showers (Eclipse Software,1985)
Educational



Meteor Storm (Quicksilva Ltd,1982)
Arcade



Meteor Storm + Space Invaders (Investronica S.A.,)
Compilation

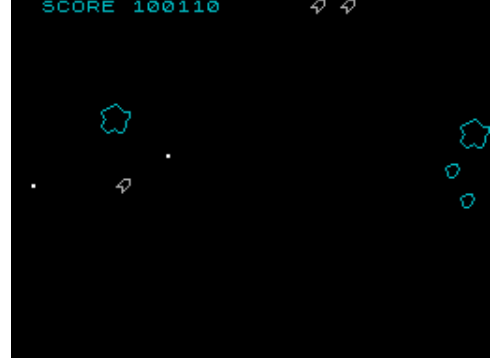

Methyhel (The Guild,1990)
Text Adventure



Metrics Quiz (Chalksoft Ltd,1983)
Educational

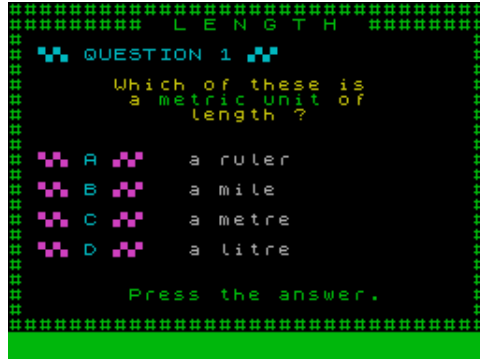

Metro-Cross (US Gold Ltd,1987)
Arcade



Metropolis (Zafiro Software Division,1988)

Board/Card Game



Metsys (Duo Soft,1989)

Text Adventure



Mexico '86 (Top Spec,1986)

Simulation



MF Ramdisk (Human Waste Company,1986)

Utility

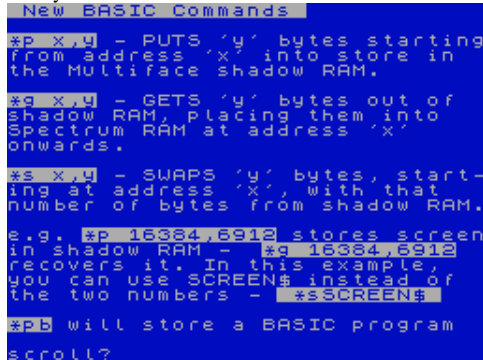

Miami Dice (Bug-Byte Software Ltd,1986)

Board/Card Game



Metropolis (The Power House,1988)

Arcade Adventure



Mex (Ian Collier,)

Arcade



Mezi Vezemi (Gama Software,1994)

Arcade



Miami Chase (Code Masters Ltd,1991)

Arcade

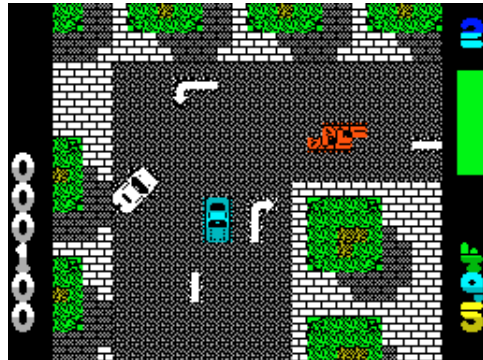

Miami Vice (Ocean Software Ltd,1986)

Arcade

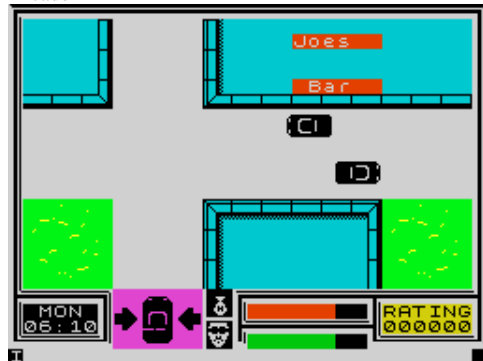

Metropolis (Topo Soft,1989)

Arcade



Mexico '86 (Qualsoft,1985)

Sport



Add which player? (Initials) L

MF-Print (Campbell Systems,1984)

Utility

Report geometry

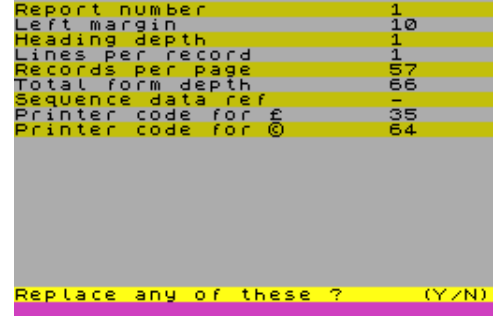

Replace any of these ? (Y/N)

Miami Cobra GT (Players Software,1991)

Arcade



Mic (Progress,1996)

Scene Demo

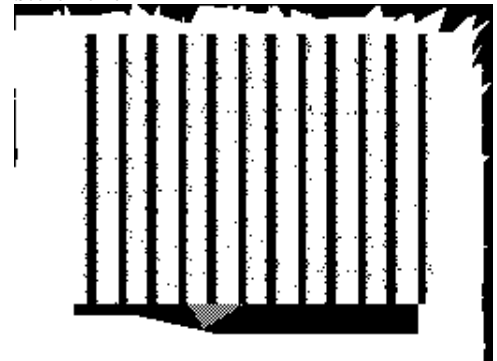

Michel Futbol Master (Dinamic Software,1989)
Arcade

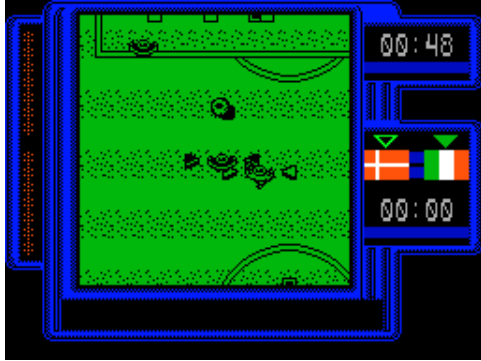

Mickey Mouse Demo (Eddy/Tom,1991)
Scene Demo



Micro at Work Software Cassette 1, The (Granada Publishing,1985) Compilation



Microbase (MicroHobby,1985)
Utility



Microbridge (Stellar Software,1983)
Board/Card Game



Michel Super Skills (Dinamic Software,1991)
Arcade



Mickey's Runaway Zoo (Disney Software,1991)
Educational



Micro at Work Software Cassette 2, The (Granada Publishing,1985) Compilation



Microbot (Softek Software International Ltd,1983)
Arcade

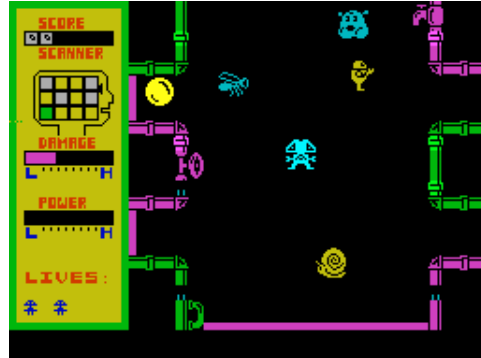

Microbug (Arnold Wheaton Software,1983)
Educational

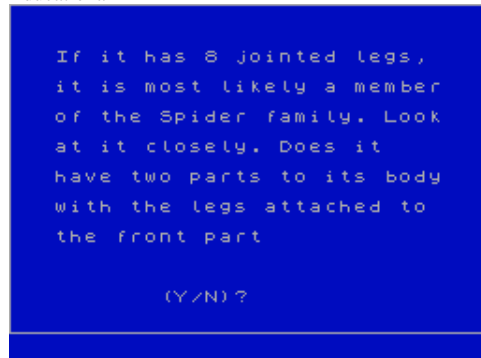

Mickey Mouse (Gremlin Graphics Software Ltd,1988)
Arcade



Micro Arts (Micro Arts,1985)
Utility



Microball (Alternative Software Ltd,1988)
Arcade



Micro Bowl (Gabi Soft,1992)
Arcade



Micro-Calc (MicroHobby,1985)
Utility



Microcat (MicroHobby,1985)
Utility



Micro Command Cassette (Orion Data,1984)
Utility

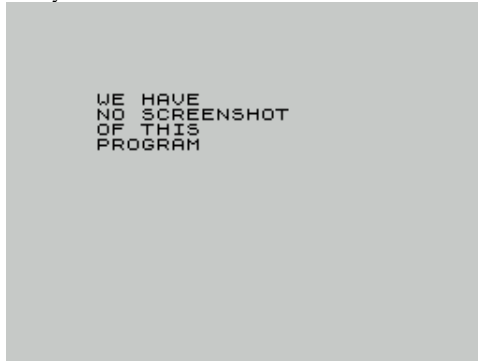

Microcopi (MicroHobby,1984)
Utility: Copier



Micro Draw (MicroHobby,1988)
Utility: Drawing

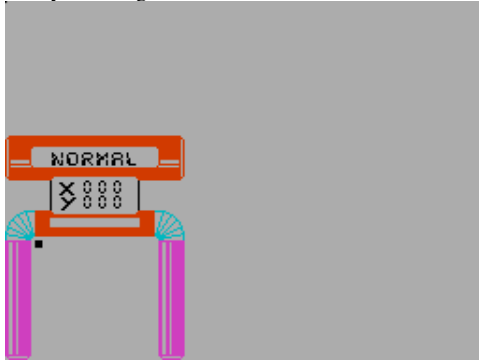

Micro Draw (Micro-Mart Software,1984)
Utility: Drawing

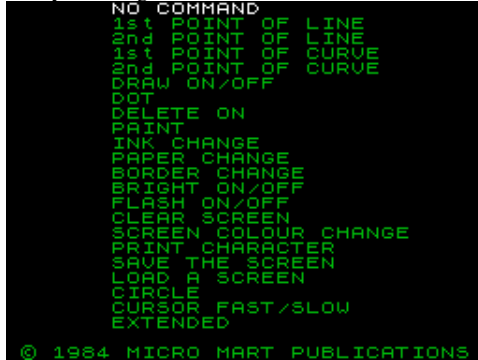

MicroDrive 1 (Lerm Software,1985)
Utility: Copier



Microdrive Copycat (Rarari Software,1984)
Utility: Copier



Microdrive Doctor (Seven Stars Publishing,1985)
Utility

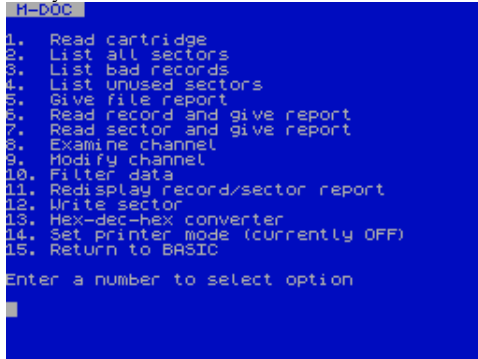

Microdrive Doctor (Softschool,1986)
Utility



Microdrive FIG Forth (Semaphore,1985)
Utility: Programming



Microdrive Kopykat (Medsoft,1984)
Utility: Copier



Microdrive Recovery (Roybot,1986)
Utility



Microdrive Repair Utility (K.S. Beddoe,1988)
Utility

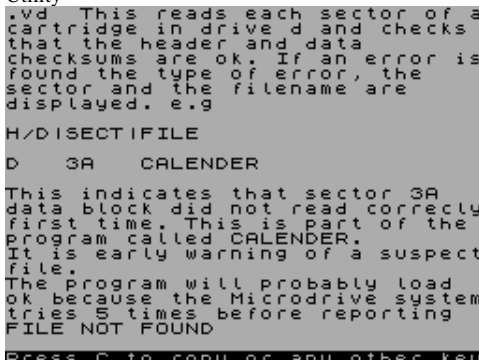

Micro Drivin' (Softel Software,1984)
Text Adventure

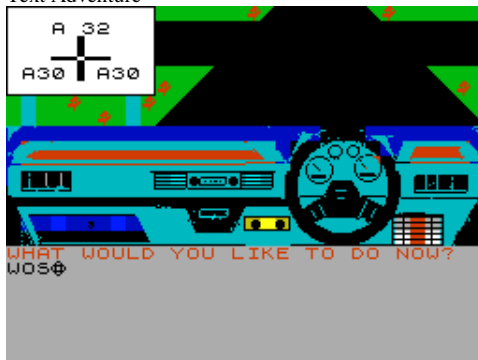

Microfair Madness (Delbert the Hamster Software,1991)
Text Adventure



Microfair Madness Plus (Zenobi Software,1991)
Compilation

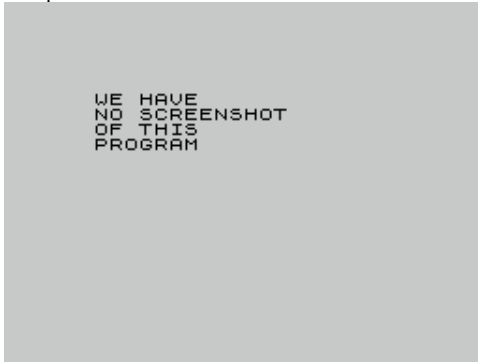

Microfile 1 (MicroHobby,1985)
Utility



Microfile 2 (MicroHobby,1985)
Utility



Microfile 3 (MicroHobby,1985)
Utility



Microfitness (VO2,1985)
Educational

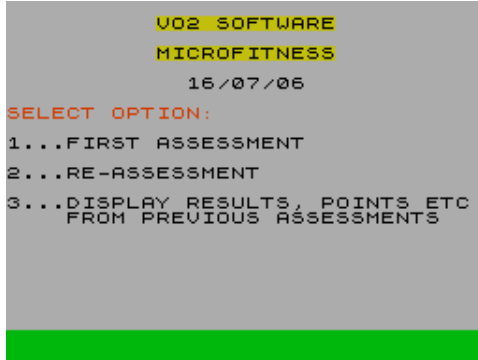

MicroHobby Cassette 01 (MicroHobby,1985)
Compilation



MicroHobby Cassette 02 (MicroHobby,1985)
Compilation

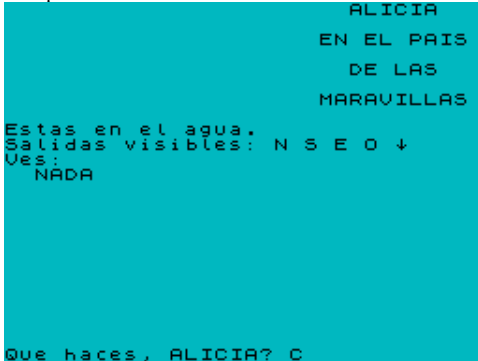

MicroHobby Cassette 03 (MicroHobby,1985)
Compilation



MicroHobby Cassette 04 (MicroHobby,1985)
Compilation



MicroHobby Cassette 05 (MicroHobby,1985)
Compilation



MicroHobby Cassette 06 (MicroHobby,1985)
Compilation

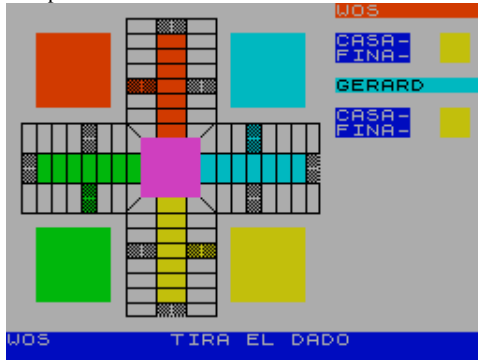

MicroHobby Cassette 07 (MicroHobby,1985)
Compilation

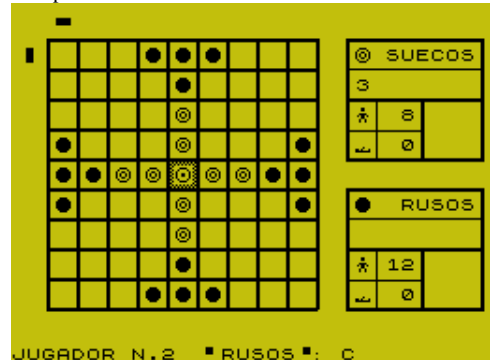

MicroHobby Cassette 08 (MicroHobby,1985)
Compilation



MicroHobby Cassette 09 (MicroHobby,1985)
Compilation



MicroHobby Cassette 10 (MicroHobby,1985)
Compilation



MicroHobby Cassette 11 (MicroHobby,1986)
Compilation

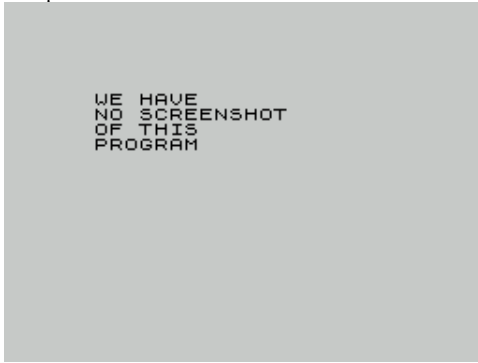

MicroHobby Cassette 12 (MicroHobby,1986)
Compilation

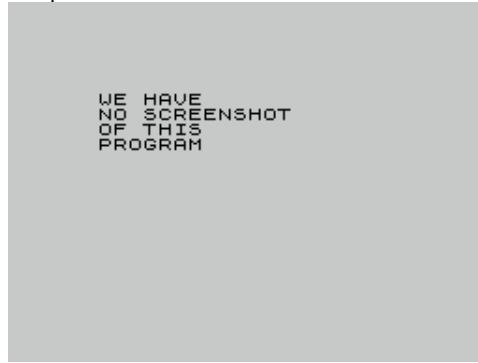

MicroHobby Cassette 13 (MicroHobby,1986)
Compilation

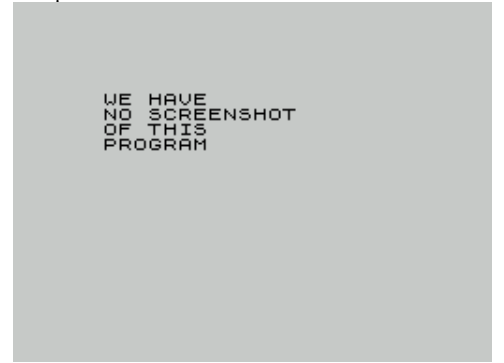

MicroHobby issue 182: Tape 1 (MicroHobby,1988)
Covertape



MicroHobby issue 183: Tape 2 (MicroHobby,1988)
Covertape

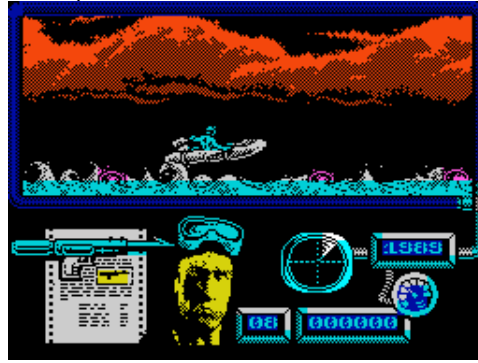

MicroHobby issue 184: Tape 3 (MicroHobby,1989)
Covertape



MicroHobby issue 185: Tape 4 (MicroHobby,1989)
Covertape



MicroHobby issue 186: Tape 5 (MicroHobby,1989)
Covertape



MicroHobby issue 187: Tape 6 (MicroHobby,1989)
Covertape



MicroHobby issue 188: Tape 7 (MicroHobby,1989)
Covertape



MicroHobby issue 189: Tape 8 (MicroHobby,1989)
Covertape



MicroHobby issue 190: Tape 10 (MicroHobby,1989)
Covertape

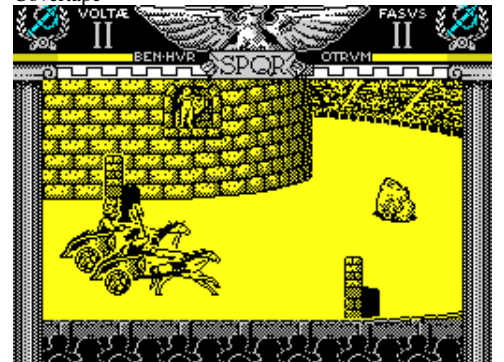

MicroHobby issue 190: Tape 9 (MicroHobby,1989)
Covertape



MicroHobby issue 191: Tape 11 (MicroHobby,1989)
Covertape



MicroHobby issue 192: Tape 12 (MicroHobby,1989)
Covertape

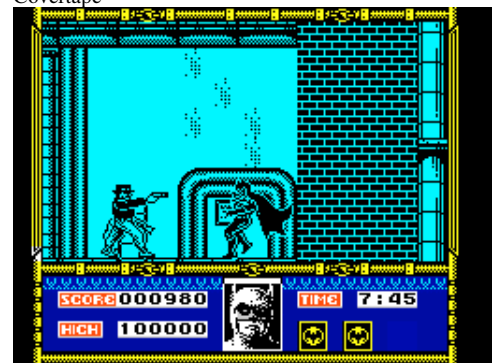

MicroHobby issue 192: Tape 13 (MicroHobby,1989)
Covertape



MicroHobby issue 194: Tape 16 (MicroHobby,1989)
Covertape

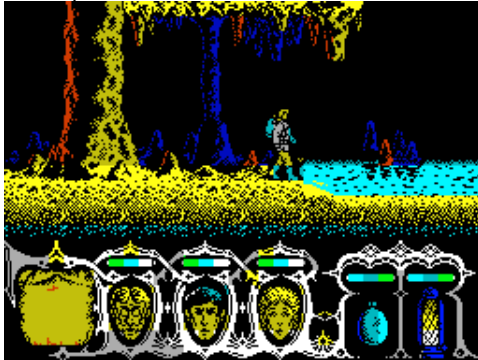

MicroHobby issue 196: Tape 19 (MicroHobby,1990)
Covertape

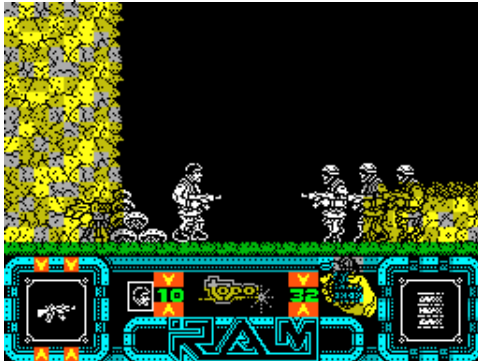

MicroHobby issue 199: Tape 22 (MicroHobby,1990)
Covertape

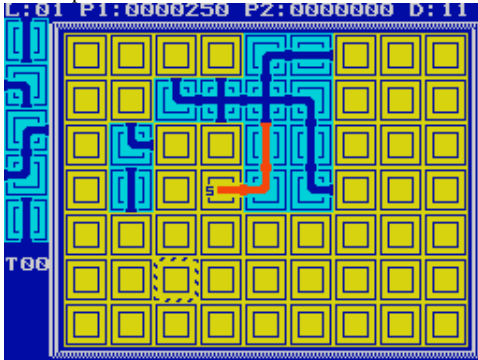

MicroHobby issue 201: Tape 25 (MicroHobby,1990)
Covertape



MicroHobby issue 193: Tape 14 (MicroHobby,1989)
Covertape

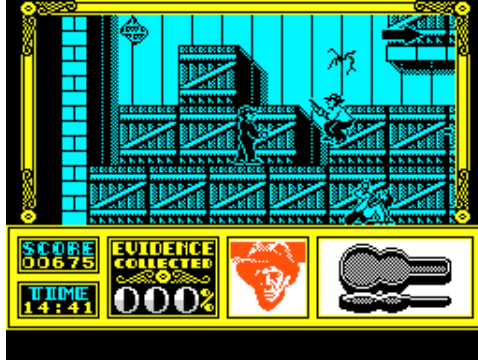

MicroHobby issue 195: Tape 17 (MicroHobby,1990)
Covertape



MicroHobby issue 197: Tape 20 (MicroHobby,1990)
Covertape

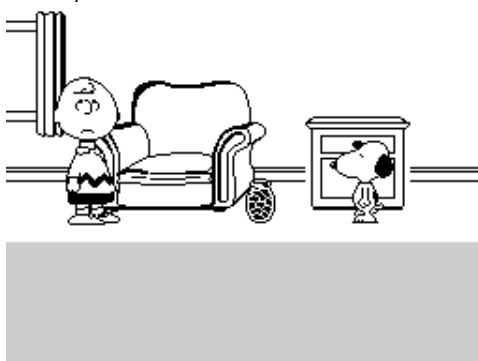

MicroHobby issue 200: Tape 23 (MicroHobby,1990)
Covertape

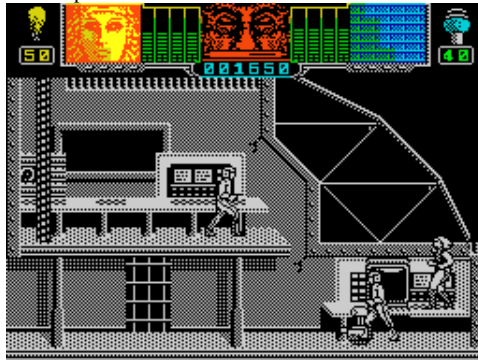

MicroHobby issue 201: Tape 26 (MicroHobby,1990)
Covertape



MicroHobby issue 194: Tape 15 (MicroHobby,1989)
Covertape

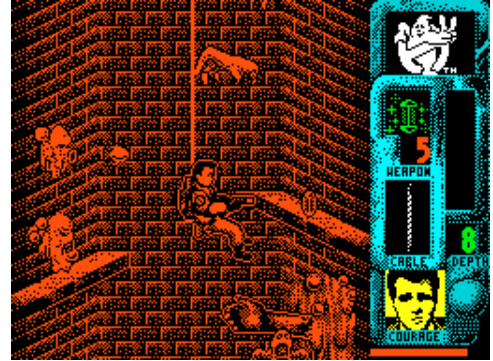

MicroHobby issue 195: Tape 18 (MicroHobby,1990)
Covertape



MicroHobby issue 198: Tape 21 (MicroHobby,1990)
Covertape

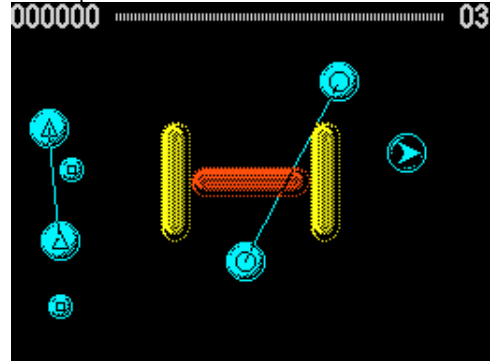

MicroHobby issue 200: Tape 24 (MicroHobby,1990)
Covertape



MicroHobby issue 202: Tape 27 (MicroHobby,1990)
Covertape



MicroHobby issue 203: Tape 28 (MicroHobby,1990)
Covertape

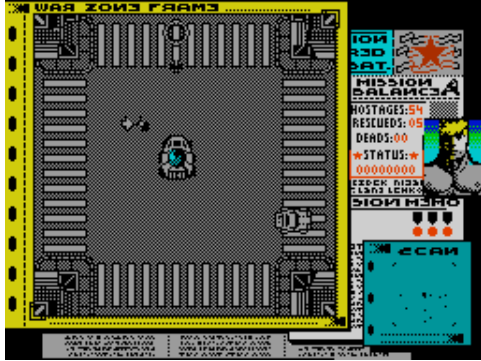

MicroHobby issue 205: Tape 31 (MicroHobby,1990)
Covertape

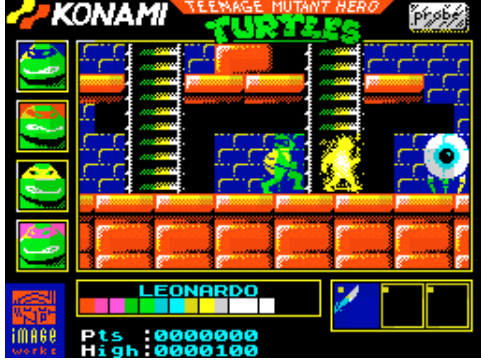

MicroHobby issue 207: Tape 34 (MicroHobby,1991)
Covertape



MicroHobby issue 210: Tape 37 (MicroHobby,1991)
Covertape

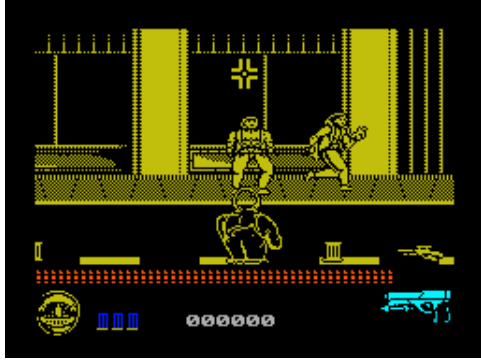

MicroHobby issue 212: Tape 40 (MicroHobby,1991)
Covertape

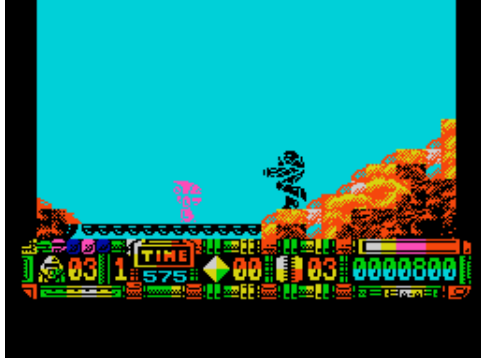

MicroHobby issue 204: Tape 29 (MicroHobby,1990)
Covertape

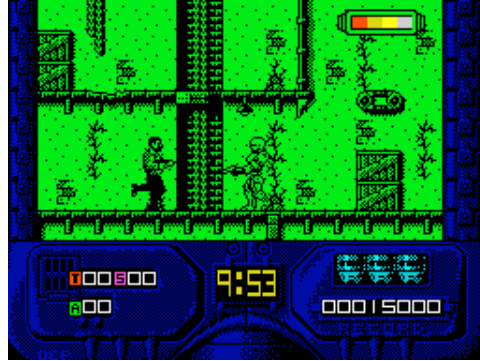

MicroHobby issue 205: Tape 32 (MicroHobby,1990)
Covertape

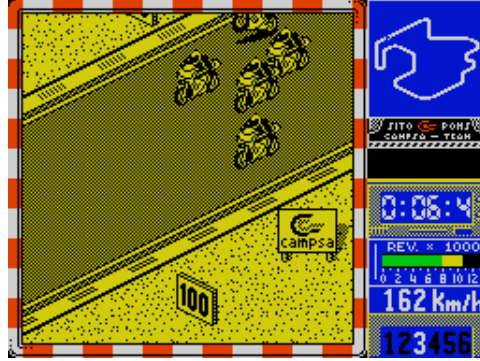

MicroHobby issue 208: Tape 35 (MicroHobby,1991)
Covertape

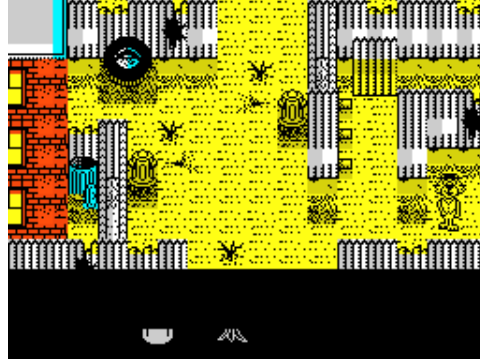

MicroHobby issue 211: Tape 38 (MicroHobby,1991)
Covertape



MicroHobby issue 212: Tape 41 (MicroHobby,1991)
Covertape

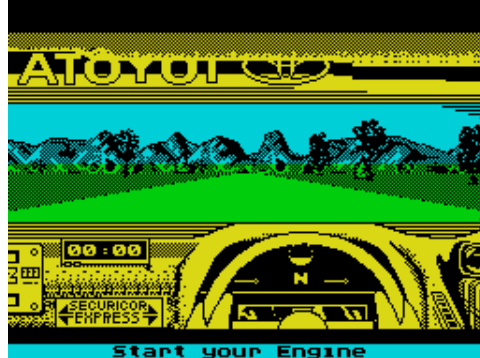

MicroHobby issue 204: Tape 30 (MicroHobby,1990)
Covertape

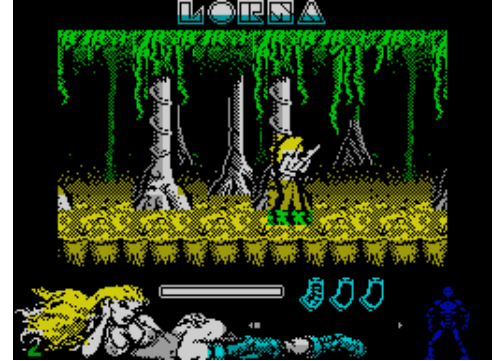

MicroHobby issue 206: Tape 33 (MicroHobby,1991)
Covertape



MicroHobby issue 209: Tape 36 (MicroHobby,1991)
Covertape



MicroHobby issue 211: Tape 39 (MicroHobby,1991)
Covertape



MicroHobby issue 213: Tape 42 (MicroHobby,1991)
Covertape



MicroHobby issue 214: Tape 43 (MicroHobby,1991)
Covertape



MicroHobby issue 216: Tape 46 (MicroHobby,1991)
Covertape

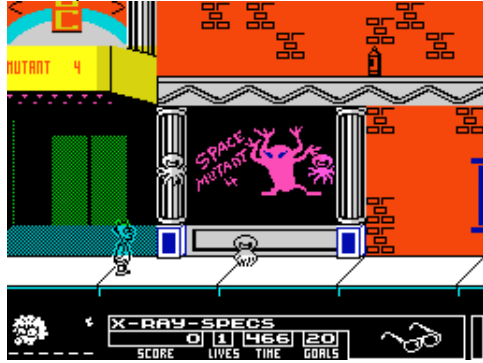

MicroHobby Semanal 001-004 (MicroHobby,1984)
Compilation



MicroHobby Semanal 013-016 (MicroHobby,1985)
Compilation



MicroHobby Semanal 025-028 (MicroHobby,1985)
Compilation



MicroHobby issue 215: Tape 44 (MicroHobby,1991)
Covertape



MicroHobby issue 216: Tape 47 (MicroHobby,1991)
Covertape



MicroHobby Semanal 005-008 (MicroHobby,1984)
Compilation



MicroHobby Semanal 017-020 (MicroHobby,1985)
Compilation



MicroHobby Semanal 029-032 (MicroHobby,1985)
Compilation



MicroHobby issue 215: Tape 45 (MicroHobby,1991)
Covertape



MicroHobby issue 217: Tape 48 (MicroHobby,1992)
Covertape



MicroHobby Semanal 009-012 (MicroHobby,1985)
Compilation



MicroHobby Semanal 021-024 (MicroHobby,1985)
Compilation



MicroHobby Semanal 033-036 (MicroHobby,1985)
Compilation



MicroHobby Semanal 037-040 (MicroHobby,1985)
Compilation

WE HAVE
NO SCREENSHOT
OF THIS
PROGRAM

MicroHobby Semanal 041-044 (MicroHobby,1985)
Compilation

WE HAVE
NO SCREENSHOT
OF THIS
PROGRAM

MicroHobby Semanal 045-048 (MicroHobby,1985)
Compilation

WE HAVE
NO SCREENSHOT
OF THIS
PROGRAM

MicroHobby Semanal 049-052 (MicroHobby,1985)
Compilation

WE HAVE
NO SCREENSHOT
OF THIS
PROGRAM

MicroHobby Semanal 053-056 (MicroHobby,1985)
Compilation

WE HAVE
NO SCREENSHOT
OF THIS
PROGRAM

MicroHobby Semanal 057-060 (MicroHobby,1985)
Compilation

WE HAVE
NO SCREENSHOT
OF THIS
PROGRAM

MicroHobby Semanal 061-064 (MicroHobby,1986)
Compilation

WE HAVE
NO SCREENSHOT
OF THIS
PROGRAM

MicroHobby Semanal 065-068 (MicroHobby,1986)
Compilation

WE HAVE
NO SCREENSHOT
OF THIS
PROGRAM

MicroHobby Semanal 069-072 (MicroHobby,1986)
Compilation

WE HAVE
NO SCREENSHOT
OF THIS
PROGRAM

MicroHobby Semanal 073-076 (MicroHobby,1986)
Compilation

WE HAVE
NO SCREENSHOT
OF THIS
PROGRAM

MicroHobby Semanal 077-080 (MicroHobby,1986)
Compilation

WE HAVE
NO SCREENSHOT
OF THIS
PROGRAM

MicroHobby Semanal 081-084 (MicroHobby,1986)
Compilation

WE HAVE
NO SCREENSHOT
OF THIS
PROGRAM

MicroHobby Semanal 085-088 (MicroHobby,1986)
Compilation

WE HAVE
NO SCREENSHOT
OF THIS
PROGRAM

MicroHobby Semanal 089-092 (MicroHobby,1986)
Compilation

WE HAVE
NO SCREENSHOT
OF THIS
PROGRAM

MicroHobby Semanal 093-096 (MicroHobby,1986)
Compilation

WE HAVE
NO SCREENSHOT
OF THIS
PROGRAM

MicroHobby Semanal 097-100 (MicroHobby,1986)
Compilation

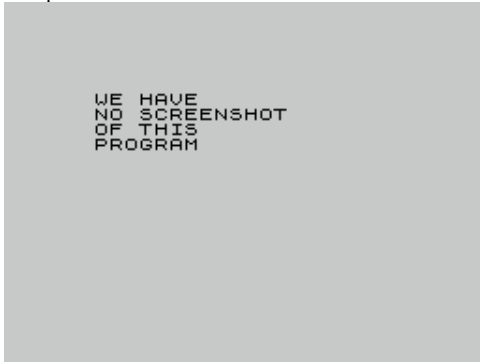

MicroHobby Semanal 101-104 (MicroHobby,1986)
Compilation



MicroHobby Semanal 105-108 (MicroHobby,1986)
Compilation

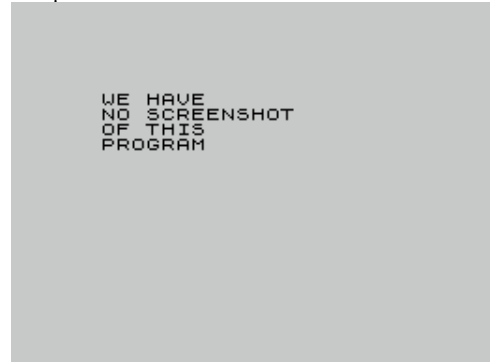

MicroHobby Semanal 109-112 (MicroHobby,1986)
Compilation



MicroHobby Semanal 113-116 (MicroHobby,1987)
Compilation

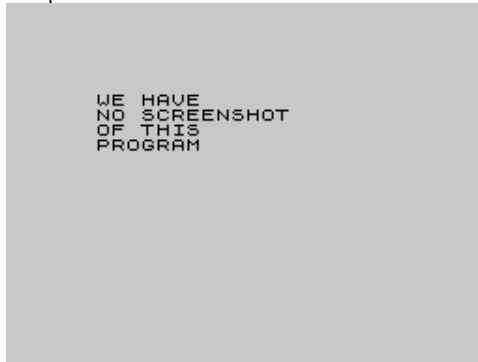

MicroHobby Semanal 117-120 (MicroHobby,1987)
Compilation



MicroHobby Semanal 121-124 (MicroHobby,1987)
Compilation



MicroLink (Soft 2000,1985)
Text Adventure



Micromaker (16/48 Tape Magazine,1985)
Simulation

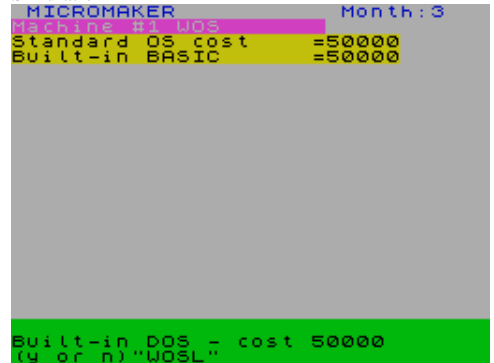

Micro Man + The O Zone, The (Compass Software,1986)
Compilation



MicroMate (Lerm Software,1987)
Utility: Copier

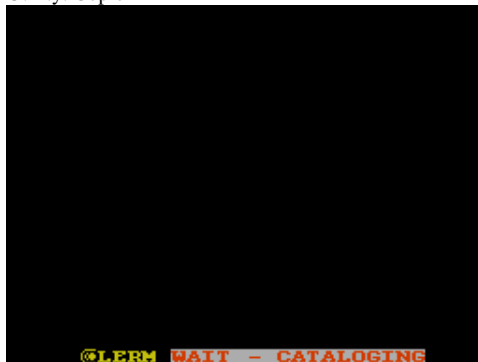

Micro Maths (LCL,1984)
Educational

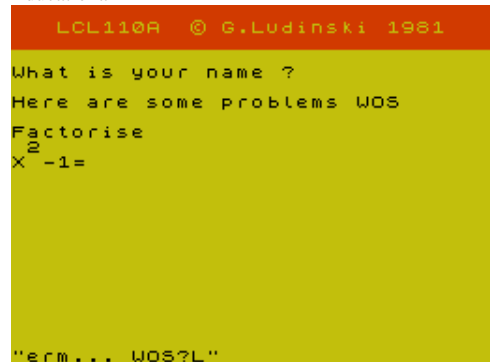

Micromaze (King Software,)
Arcade

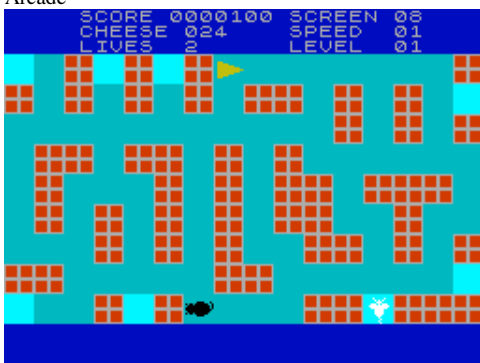

Micro-Mira Electronica (MicroHobby,1986)
Utility



Micro Mouse (Mastertronic Plus,1989)
Arcade

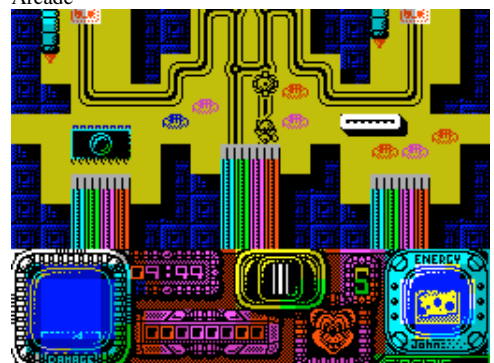

Micro Mouse Goes De-bugging (MC Lothlorien Ltd,1983)

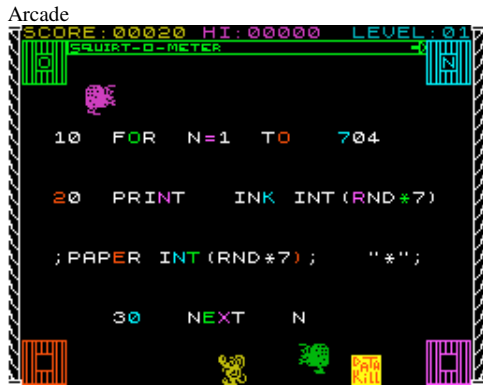

Micronet (Scicon/DFP,1984)
Utility

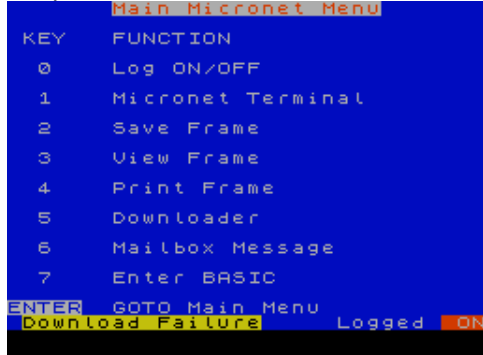

Micro Olympics (Database Publications Ltd,1984)
Sport



Micro-print (Myrmidon Software,1984)
Utility: Screen Manipulation

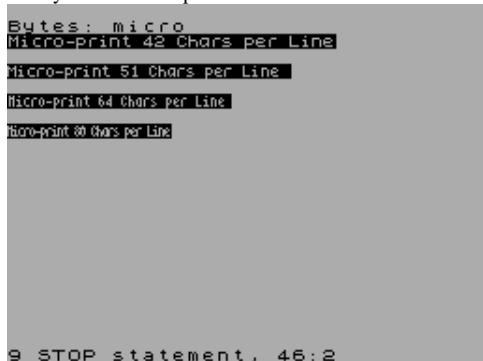

Micro-Prolog (Sinclair Research Ltd,1983)
Utility: Programming

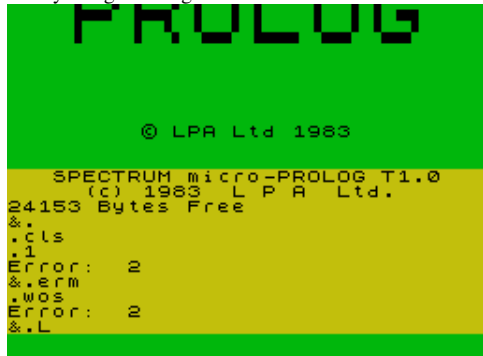

Micro Mutant, The (Compass Software,1991)
Text Adventure

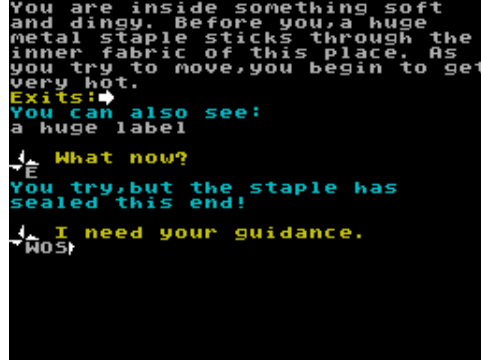

Micronet Christmas Card (Spectrum Microbase,) Simulation



MicroPen (Contrast Software,1983)
Utility: Word Processor

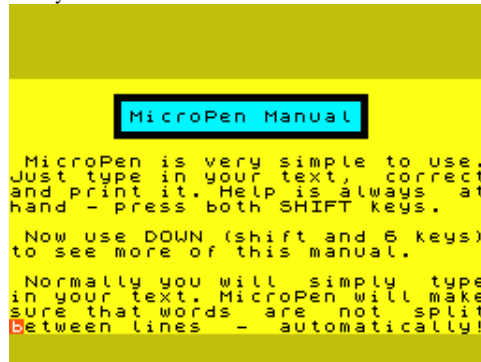

Micro-print 42/51 (Myrmidon Software,1984)
Utility



Microprose Soccer (Microprose Software Ltd,1989)
Arcade



Micronaut One (Nexus Productions Ltd,1987)
Arcade

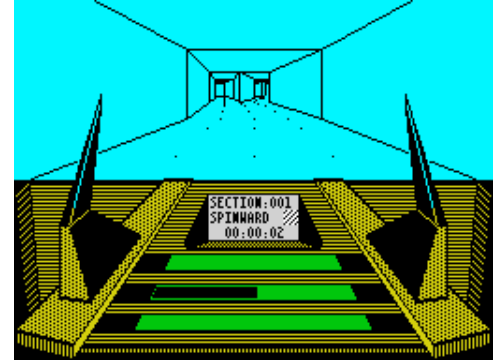

Micro Office (SD Micro Systems,1985)
Utility



Micro Primer Microelectronics Education Programme (Tecmedia,1983) Educational

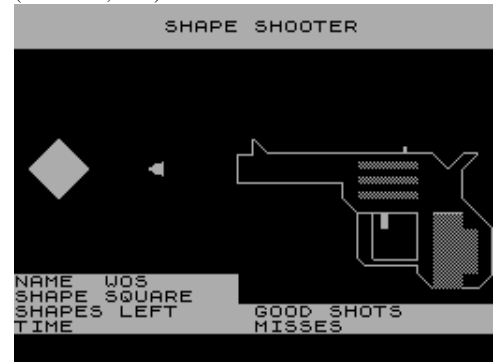

Micro-print 85 (Myrmidon Software,1984)
Utility: Screen Manipulation

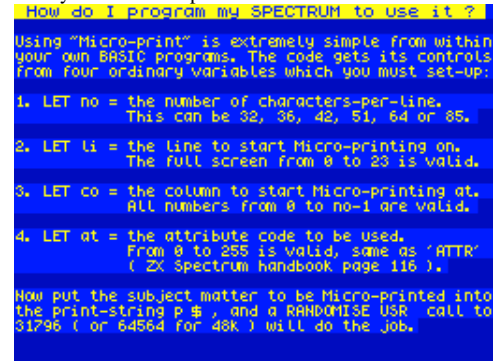

Micros for Children (Stell Software,1983)
Educational



Micro Simulation (Dream Software Ltd,1984)
Utility: Programming



Microsoftware Magazine No 1 (Infinite Software,1983)
Covertape



Microsoftware Magazine No 2 (Infinite Software,1983)
Covertape



Microsoftware Magazine No 3 (Infinite Software,1983)
Covertape



Microsoftware Magazine No 4 (Infinite Software,1983)
Covertape



Microsoftware Magazine No 5 (Infinite Software,1984)
Covertape



Microsoftware Magazine No 6 (Infinite Software,1984)
Covertape



Microsoftware Magazine No 7 (Infinite Software,1984)
Covertape



Microsoftware Magazine Vol 2 No 1 (Infinite Software,1984)
Covertape



Microsoftware Magazine Vol 2 No 2 (Infinite Software,1985)
Covertape

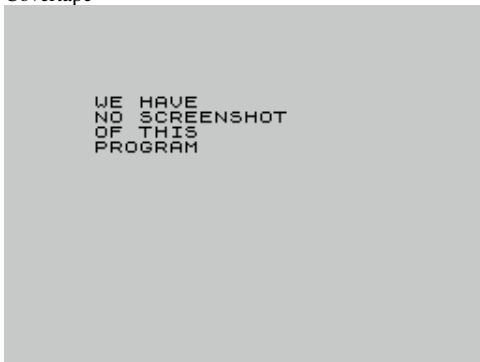

Microsoftware Magazine Vol 2 No 3 (Infinite Software,1985)
Covertape



Micro Sound 128K Part I (Inxs Software,1989)
Scene Demo



Micro Sound 128K Part II (Inxs Software,1989)
Scene Demo



Micro Sound 128K Part III (Inxs Software,1989)
Scene Demo



MicroTax 1982/83 (Microtax Ltd,1983)
Utility

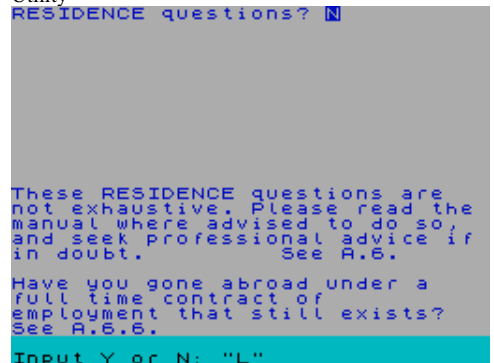

Micro Trivia (Harold Gale Software,1987)
Board/Card Game

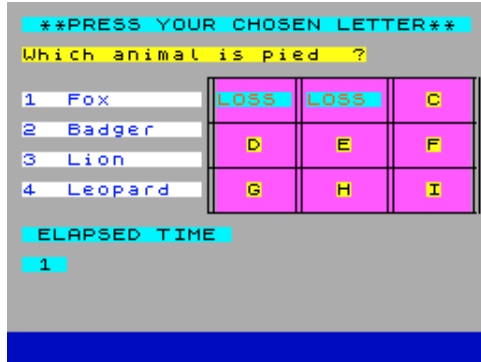

Microvalue Vol. 2 (Tynesoft,)
Compilation



Middle Earth Roleplaying (Iron Crown
Enterprises,1984)
Board/Card Game



Midrail (Dee-Kay Systems,1984)
Simulation



Midwinter (Channel 8 Software,1984)
Text Adventure



Microvalue 6 Pack (Tynesoft,1987)
Compilation



Microvalue Vol. 3 (Tynesoft,)
Compilation



Midnight (Wazertown Works,1989)
Text Adventure



Midsummer Days Dream, A (The Adventure
Workshop,1994)
Text Adventure



Mig Busters (Players Premier Software,1990)
Arcade



Microvalue Pack (Tynesoft,1987)
Compilation



Microweight (Little Softie Ltd,1983)
Utility

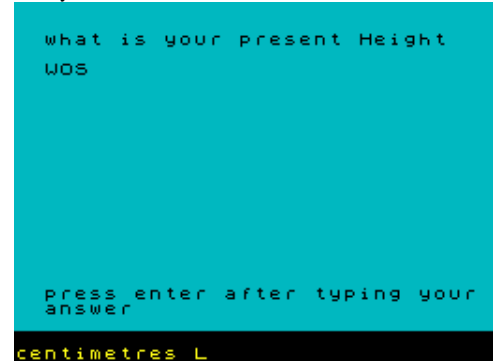

Midnight Resistance (Ocean Software Ltd,1990)
Arcade

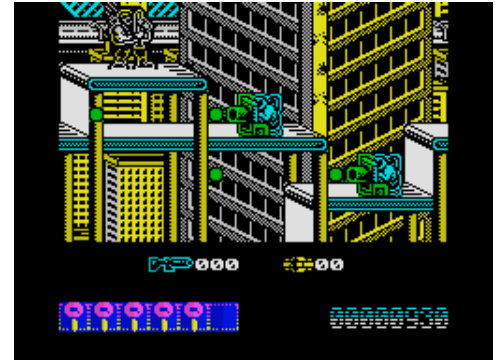

Midway (KW Software,1983)
Strategy



Mighty Magus (Quicksilver Ltd,1985)
Arcade Adventure

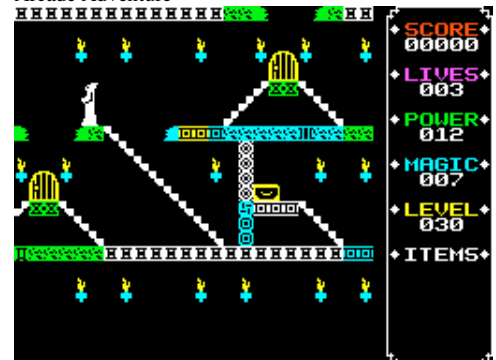

Mighty Missile (Granada Publishing,1983)



Mihotabpa (,) Arcade Adventure



Mike Gunner (Dinamic Software,1988) Arcade

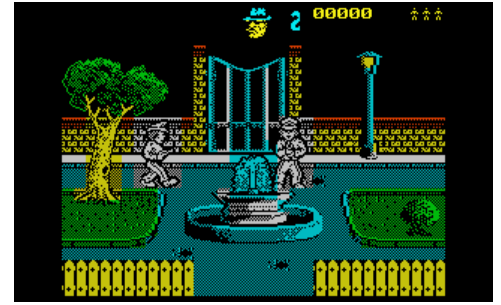

Mike Read's Pop Quiz (Elite Systems Ltd,1989) Simulation



Mikie (Imagine Software Ltd,1985) Arcade



Mil Caras, Las (MicroHobby,1985) Board/Card Game



Milk Race (Mastertronic Ltd,1987) Arcade



Milky Way 1 (Flash Inc,1994) Scene Demo



Milky Way 2 (Flash Inc,1994) Scene Demo

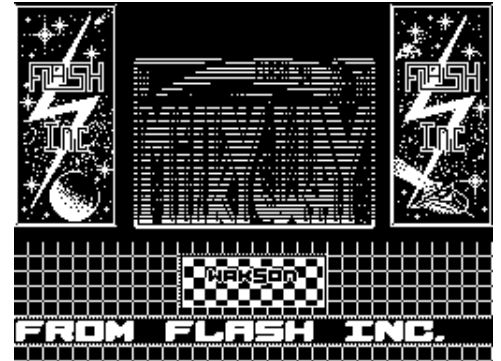

Mill (V.D.G.,1984) Arcade

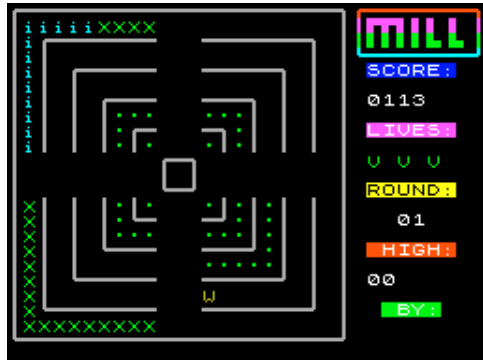

Millimon (Artic Computing Ltd,1984) Arcade

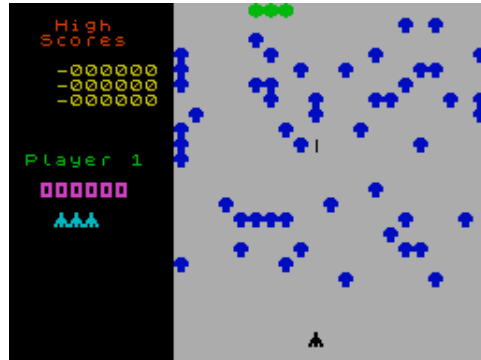

Millimon + Wally Kong (Dixons,1984) Compilation

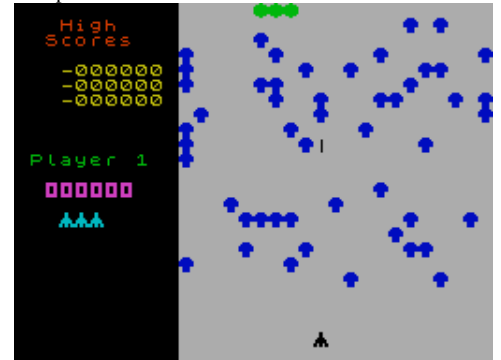

Millionaire (Incentive Software Ltd,1984) Simulation



Million Dollar Great Jewel Heist, The (The Guild,1992) Text Adventure



Millpede (Softek Software International Ltd,1983) Arcade



Millipede (Spectrum Computing,1986)
Arcade



Millipede (Add-On Electronics Ltd,1984)
Arcade

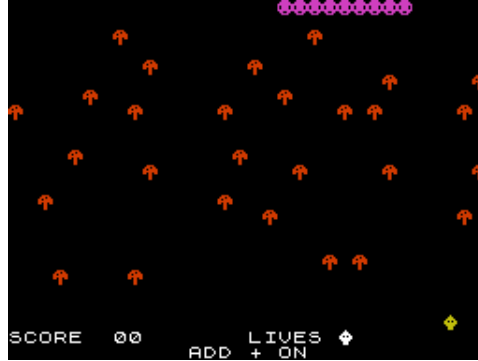

Mimic (Trius Software,1984)
Utility: Copier



Mimzoid Death Dude (Grant Jaquest,1988)
Arcade



Mina Control (Comse,)
Arcade



Minas Perdidas, Las (Aventuras AM,1989)
Text Adventure

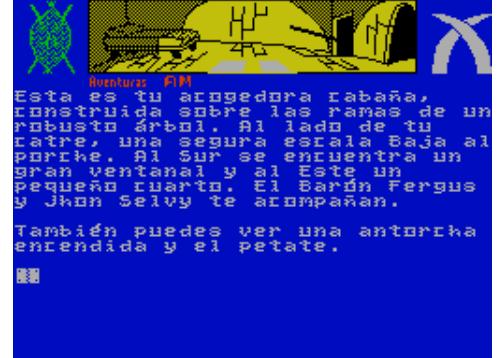

Mindbender (Gilssoft International,1984)
Text Adventure

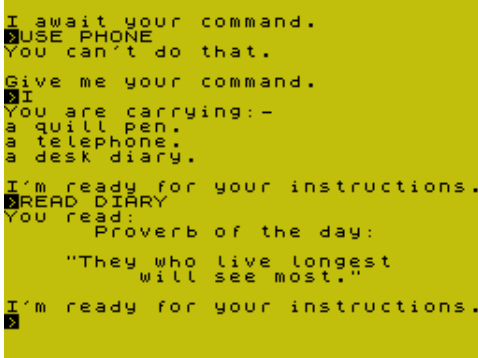

Mindboggling (Sinclair Research Ltd,1982)
Arcade



Mind Cross War (The Smart Soft,1993)
Board/Card Game



Minder (DK'Tronics Ltd,1985)
Simulation



Mindfighter (Activision Inc,1988)
Text Adventure

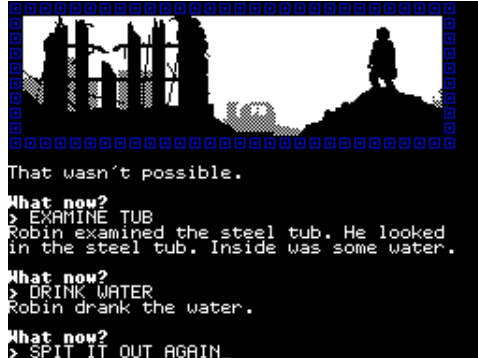

Mind Games (Oasis Software,1984)
Compilation

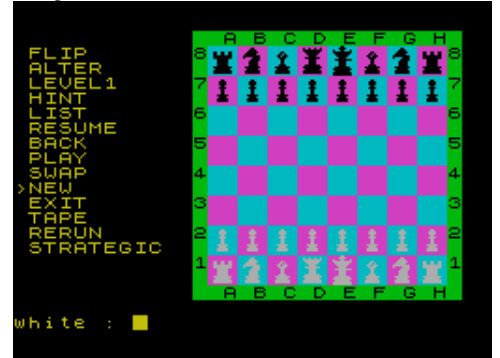

Mindless (Extacy-3,1994)
Scene Demo



Mindshadow (Activision Inc,1985)
Text Adventure



Mindstone (The Edge Software,1986)
Arcade Adventure



Mind-Stretchers (Virgin Mastertronic Ltd.)
Compilation

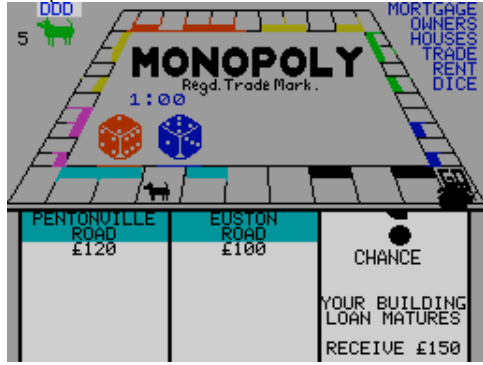

Mind-Warp (Extacy-3,1993)
Scene Demo



Mine (SCG,2001)
Arcade



Minefield (Stephen Corry,1987)
Arcade



Miner (Alexey Kuznecov,1994)
Board/Card Game

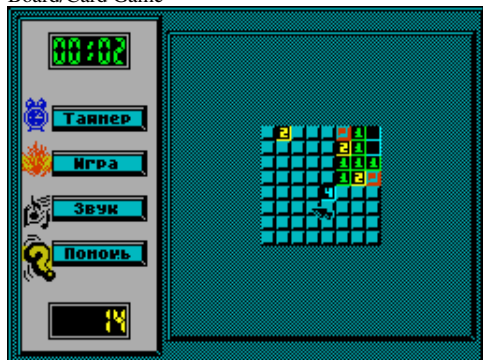

Mind the Meteors! (Sinclair Research Ltd,1982)
Arcade



Mind Your Head (Tynesoft,1986)
Arcade

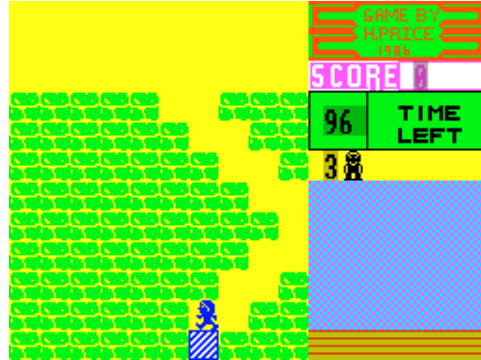

Mined-Out (Quicksilva Ltd,1983)
Arcade



Mineman 2 (Triumph Game Labs,2005)
Arcade

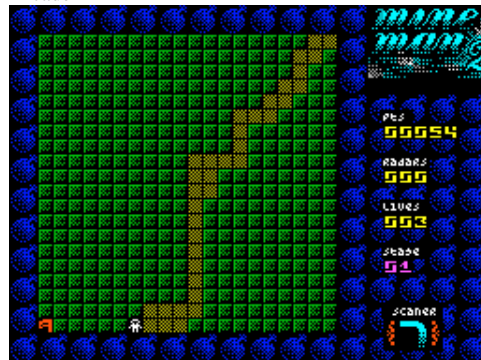

Miner (MiPH&T Hackers Club,1995)
Board/Card Game

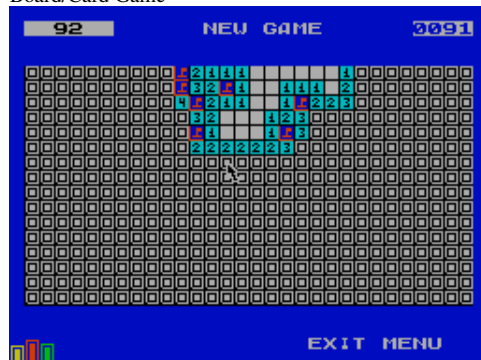

Mindtrap (Mastertronic Ltd,1989)
Board/Card Game



Mine (Ivan Benishek.)
Board/Card Game

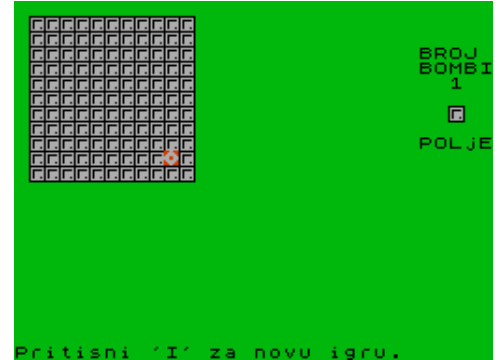

Minefield (J.K. Greye Enterprises Ltd,1982)
Arcade

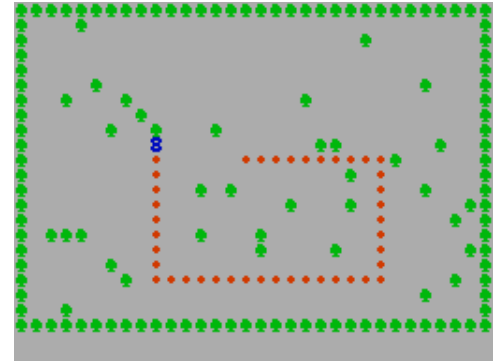

Minefeld (Roland G. Hulsmann,1983)
Arcade

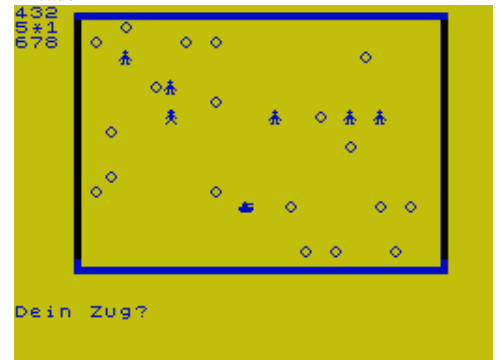

Miner (Mix Soft.)
Board/Card Game

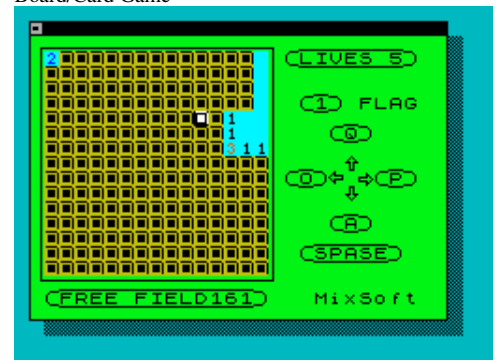

Miner (Sergey Kurganov),
Board/Card Game



Miner (Vlad Corp,1994)
Board/Card Game



Mines of Moriez (Hektic Software,1986)
Arcade



Minesweeper (Dr. Li/Tiger Core,1995)
Board/Card Game

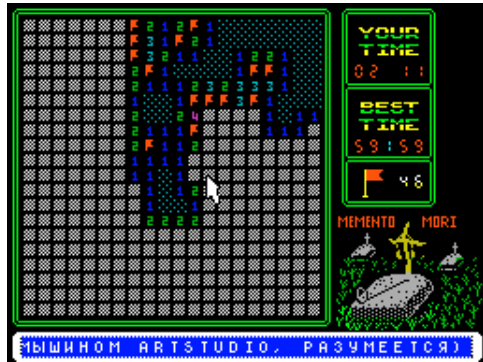

Minesweeper (Softhouse Ltd,1996)
Board/Card Game



Miner (Simple Company,1995)
Board/Card Game



Mines of Lithiad, The (Zenobi Software,1992)
Text Adventure

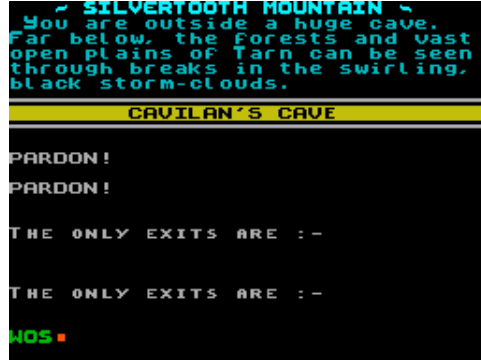

Mines of Saturn (Saturnsoft,1982)
Text Adventure

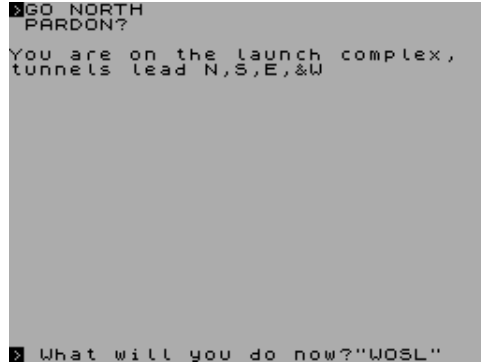

Minesweeper (Evgeny Chudinov,1994)
Board/Card Game

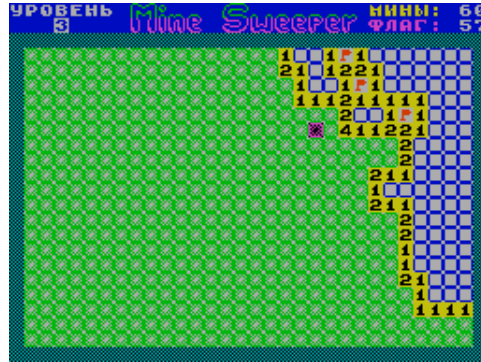

Mine, The (GFC Soft,1983)
Arcade



Miner (Vitamin,1998)
Board/Card Game



Mines of Moria (Savern Software,1983)
Arcade Adventure

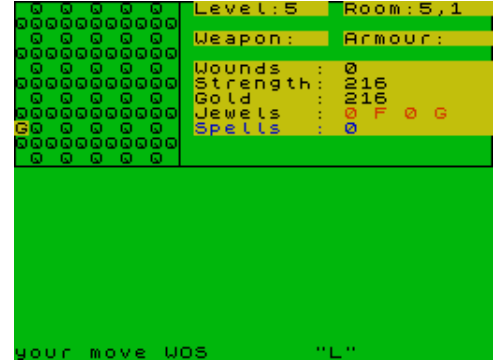

Mines of Saturn + Return to Earth (Saturnsoft,1982)
Compilation

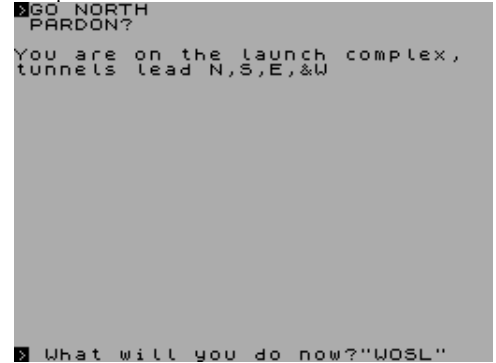

Minesweeper (Panc Software,1997)
Board/Card Game

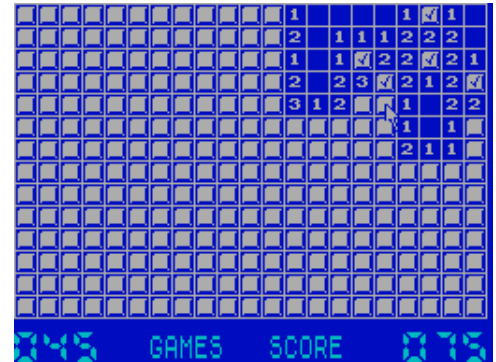

Mini Adventure (Werner Spahl,1984)
Text Adventure

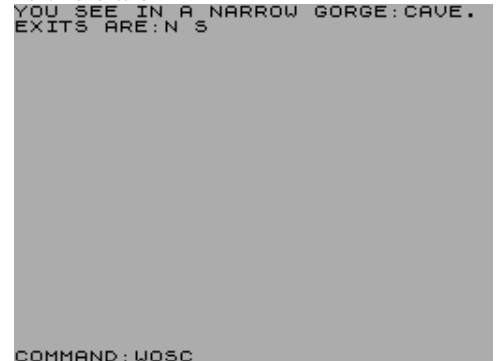

Mini Adventures (The Scripture Union.)
Compilation



Mini Compositor (Music Soft,1984)
Utility: Music Creation



Mini Language Aid (Rainbow Research,1983)
Educational



Mini-Putt (Accolade Inc,1988)
Arcade

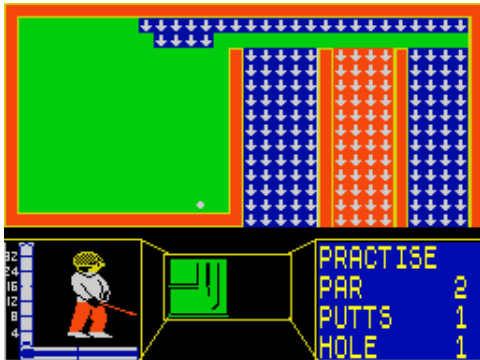

Minister for Alien Affairs, The (Mandarin Software,1986)
Text Adventure



Mini Bank Raid (Sinclair Programs,1983)
Strategy

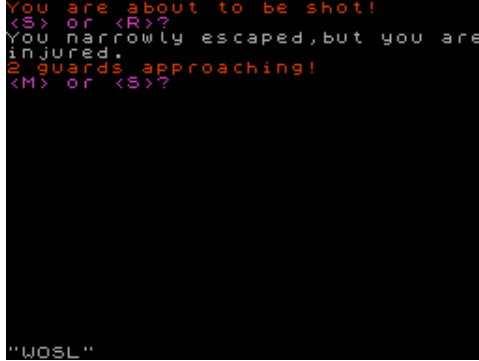

Mini Fly (Galaxy Ltd,1994)
Arcade



Minileague (Top Spec,1986)
Simulation



Mini Sector (Roland G. Hulsmann,1983)
Educational



Mini Studio (ZX Computing,1987)
Utility: Sound Manipulation

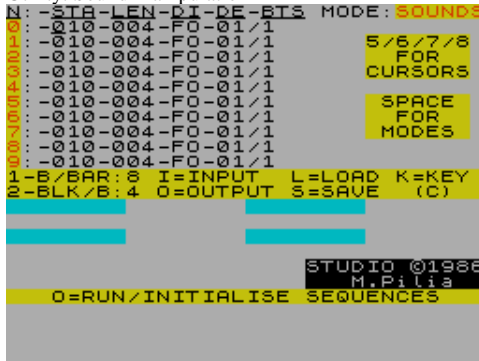

Minicalc (Aackosoft.)
Utility



Mini Infor (???) (Aackosoft,1983)
Utility: Database

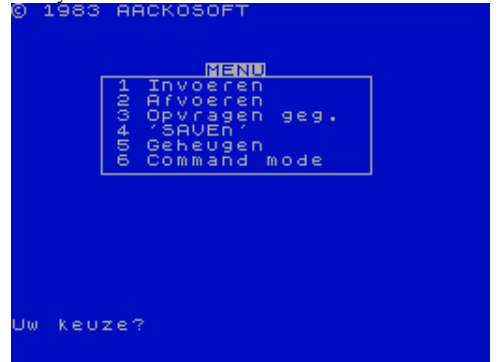

Mini Office (Database Software,1985)
Utility



Mini Solfeo (Music Soft,1984)
Utility: Music Creation

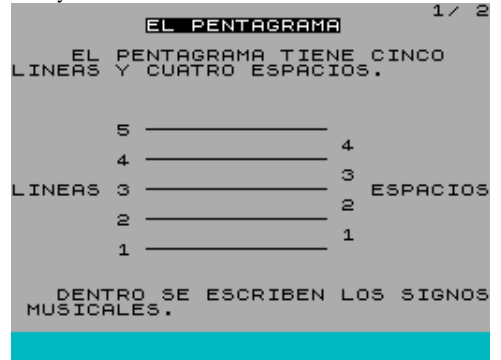

Mini Synth, The (Cheetah Marketing Ltd,1986)
Utility: Music Creation

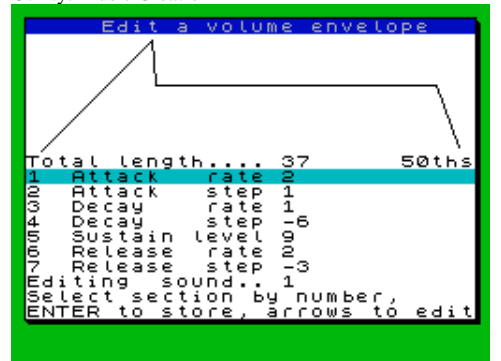

Minitext (MicroHobby,1985)

Utility: Word Processor

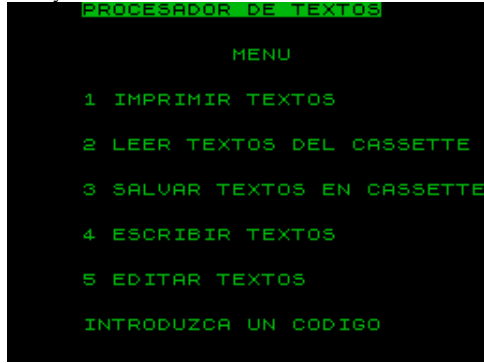

Minutz (Your Computer,1983)

Board/Card Game

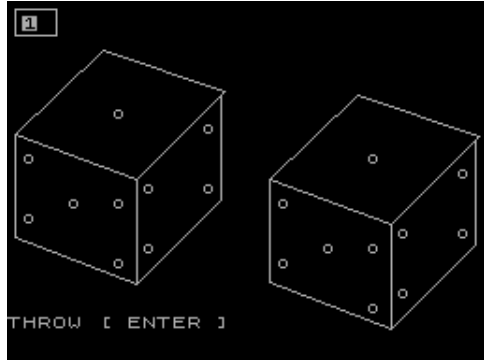

Miracle, The (Mac,1989)

Scene Demo

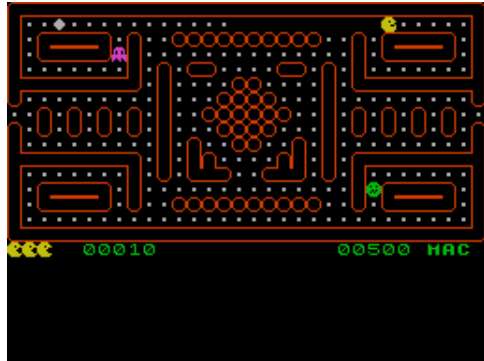

Mirage 2 (Hacker Chris,1989)

Scene Demo



Mire Mare (Ultimate Play The Game,)

Arcade



Minitextos (Investronica S.A.,1984)

Utility: Word Processor

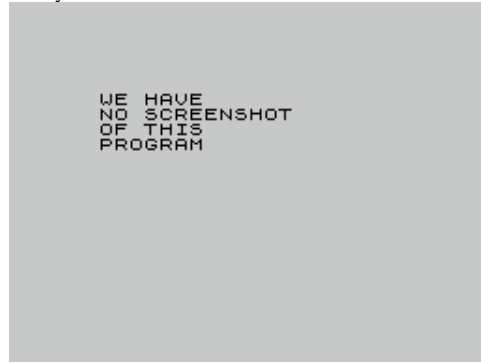

Minutos Musicales (MicroHobby,1984)

Utility: Music Creation



Mira Fortran (Mira Software,1987)

Utility: Programming



Mirage 2 (RAF,1989)

Scene Demo



Mirror (Artwork,1998)

Text Adventure



Minotaur's Labyrinth (Newsoft Products,1982)

Arcade

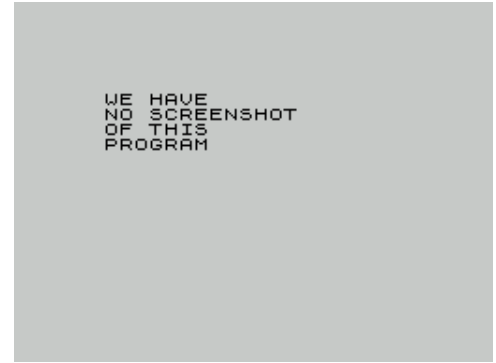

Miracle (Warlocks,1996)

Scene Demo



Mirage (Hacker Chris,1989)

Scene Demo



Mira Pascal (Mira Software,1987)

Utility: Programming



Mirrordraw (Cowl Systems,1988)

Utility: Drawing



Mirror Tile (Granada Publishing,1983)
Arcade

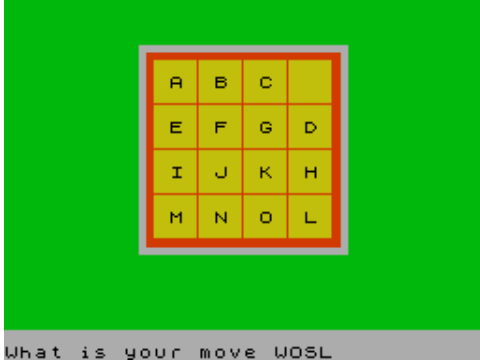

What is your move WOSL
Mision 5 (MicroHobby,1985)
Arcade



Mision Lunar (MicroHobby,1985)
Arcade



Mision Subterranea (EP Software,)
Arcade



Missile (Sinclair Research Ltd,1982)
Arcade



Miser, The (River Software,1990)
Text Adventure

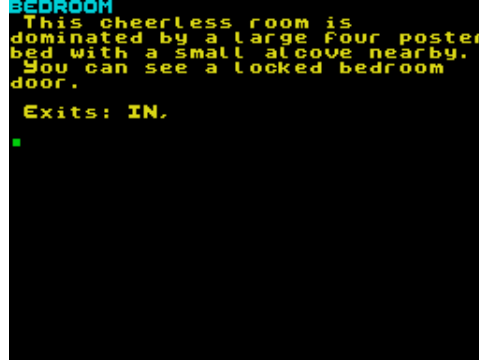

Mision Espacial (Beyker Soft,2006)
Text Adventure



Mision Sobrevivir (David Fraile,)
Text Adventure



Missile (B+H,)
Arcade

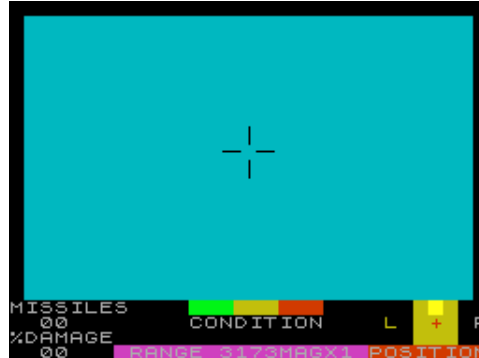

Missile Command (Cascade Games Ltd,1984)
Arcade



Misiles (Microparadise Software,1984)
Arcade

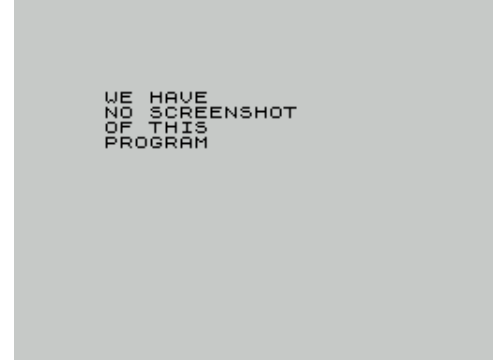

Mision Imposible (MicroHobby,1984)
Arcade



Mision Submarina (MicroHobby,1985)
Simulation

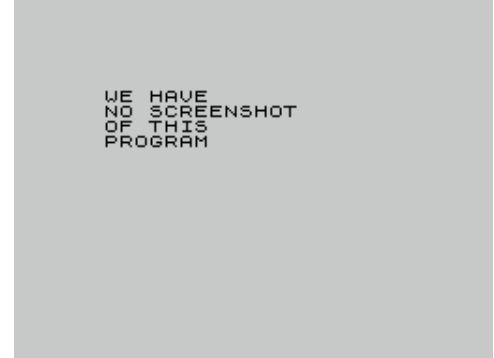

Missile (Sinclair Programs,1984)
Arcade



Missile Command (C-Tech,1982)
Arcade

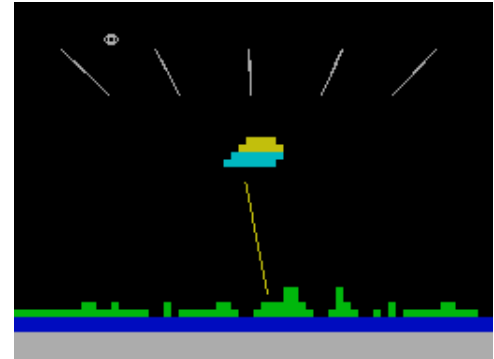

Missile Command (Precision Software Engineering,1983)
Arcade

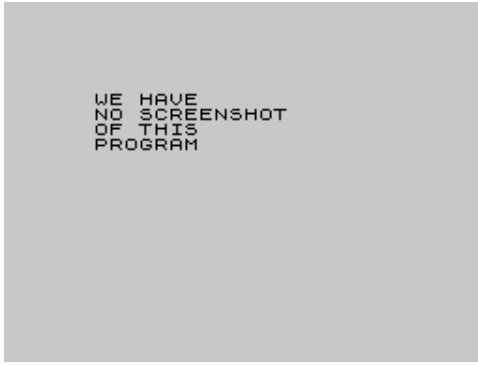

Missile Command (Sinclair Programs,1985)
Arcade

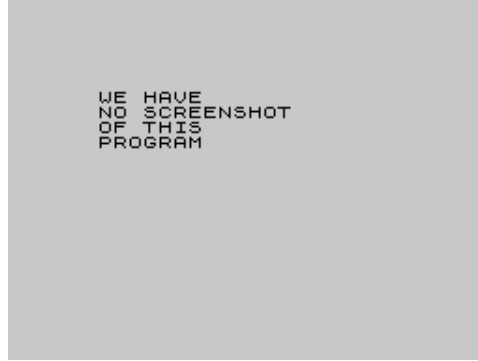

Missile Command Base (Futuresoft,1990)
Text Adventure



Missile Defence (16/48 Tape Magazine,1985)
Arcade



Missile Defence (Anirog Software,1983)
Arcade



Missile Defence (CPL Computing,1982)
Arcade



Missile Ground Zero (Software Creations,1989)
Arcade



Missing: 007 (Predator Software,1990)
Text Adventure



Missing Words (Stell Software,1983)
Educational



Mission 1: Project Volcano (Mission Software,1984)
Text Adventure

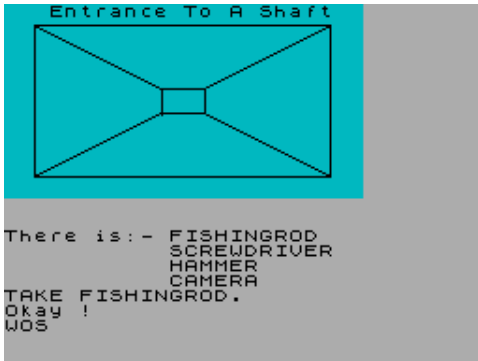

Mission 12 (Sinclair User,1986)
Arcade



Mission 2: Project Gibraltar (Mission Software,1984)
Text Adventure



Mission Collision (David J. Gommeren,1987)
Arcade



Mission Elevator (Kixx,1988)
Arcade Adventure



Mission Fallout (Crash,1990)
Arcade



Mission Genocide (Firebird Software Ltd.)
Arcade



Mission Impossible (Silversoft Ltd,1983)
Arcade

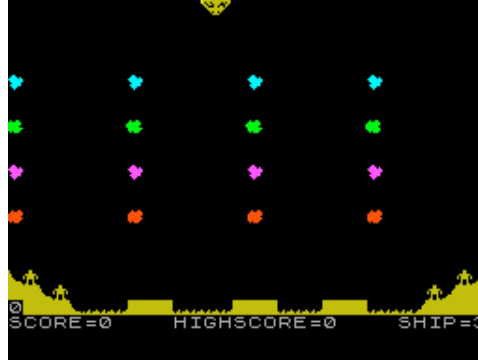

Mission Impossible (Synacroop Software.)
Arcade

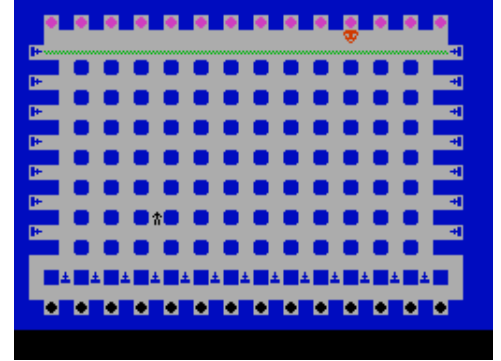

Mission Jupiter (Code Masters Ltd,1987)
Arcade



Mission Mars (Kempsoft,1983)
Arcade

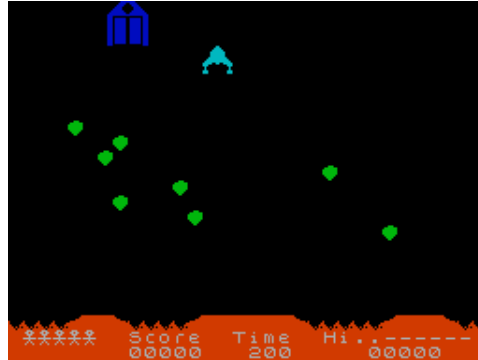

Mission Ninety One (Newdata Software,1986)
Arcade



Mission Omega (Mind Games,1986)
Arcade



Mission Omega (Pulsonic,1983)
Arcade



Mission Possible (Anik Microsystems,1984)
Arcade



Mission, The (Techno Space,1997)
Strategy

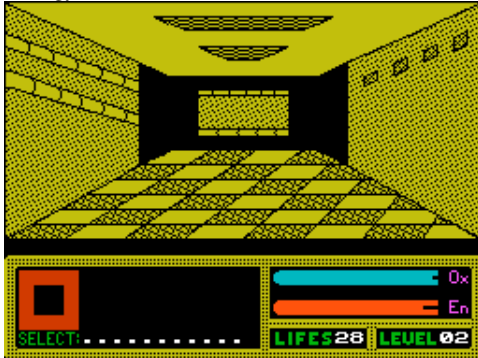

Mission Venom (Nigel Woods,1991)
Arcade



Mission X (G.I. Games,1991)
Text Adventure

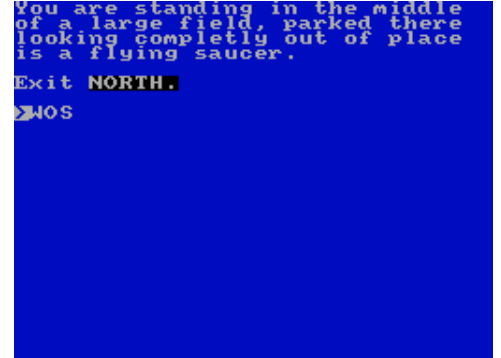

Misterio del Nilo, El (Zigurat Software,1987)
Arcade Adventure

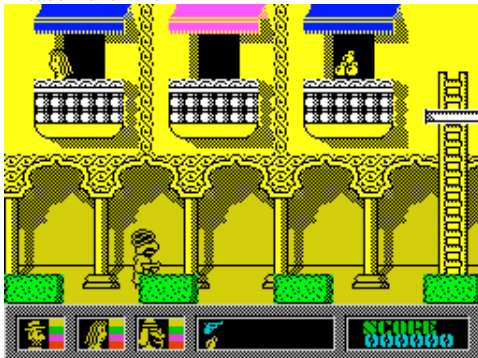

Misterios del Gusano, Los (Videofex,1993)
Text Adventure

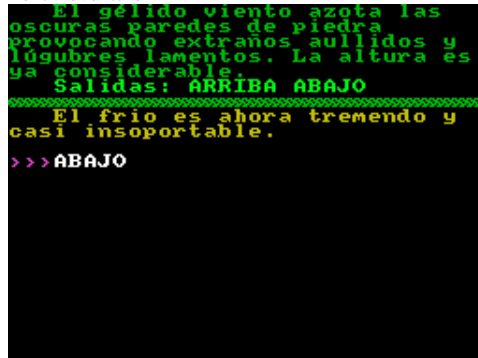

Misterioso Programa (Marcos Escudeiro/Antonio Mosquera,1989) Text Adventure



Mister Mac's Day (Arrow,1984)
Educational

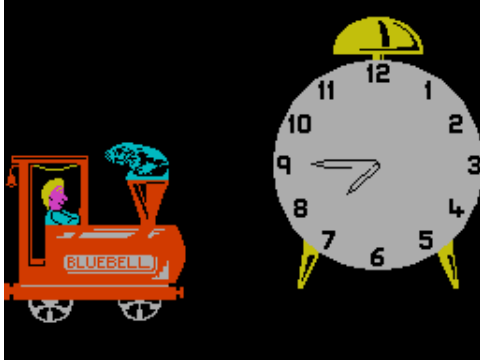

Mithos (Opera Soft S.A.,1990)
Arcade



Mix and Match with Maggie (Scetlander,1991)
Educational



MJ Demo (Mark R. Jones,1988)
Demo

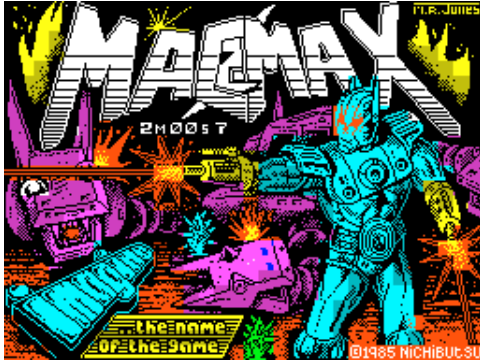

M. M. 6 Zije (Ninja Soft,1995)
Text Adventure



Mistermind (Hartland Software,1984)
Board/Card Game



Mitterwelle (F. Gutjahr,1984)
Educational

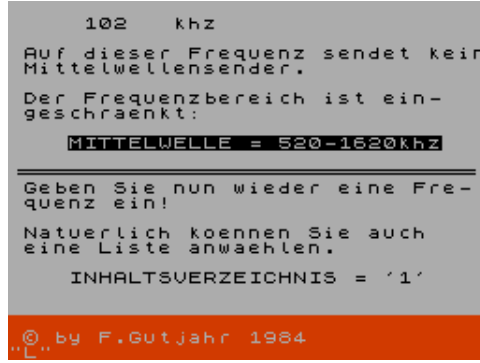

Mix Demo, The (Rafii Soft,1990)
Scene Demo



M*Loader (16/48 Tape Magazine,1984)
Utility



Mobile Wars (Mythos,1998)
Arcade

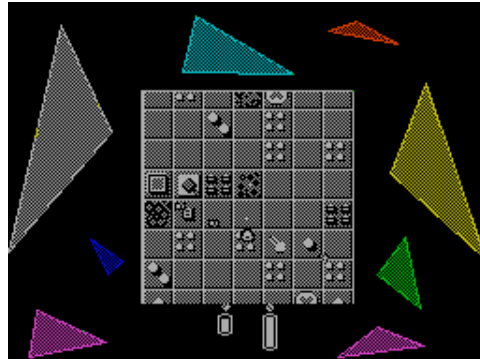

Misty Island (Dorothy Millard,1995)
Text Adventure



Mix 2 (Szafran Soft,1988)
Utility: Music Creation

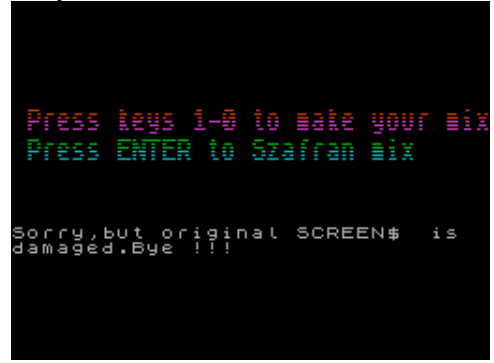

Mix-MSX (Gotef Ltd,1993)
Scene Demo



Mluvici Balik (Proxima Software,1992)
Text Adventure

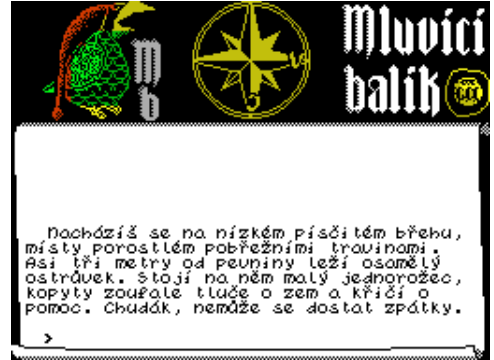

Modeller X (CCS,1983)
Utility



Model Maths (Jive Software,1983)
Educational

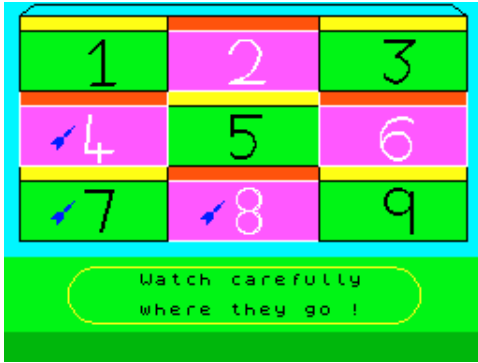

Modern Day Locospotter (Ashley Greenup,1988)
Simulation

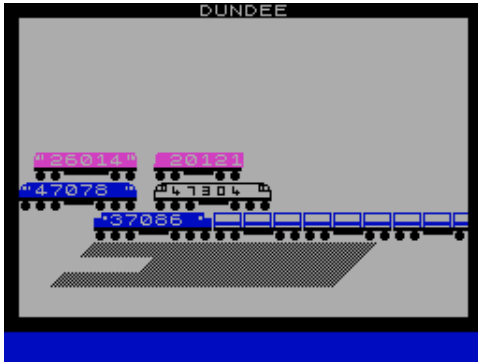

Molar Maul (Imagine Software Ltd,1983)
Arcade

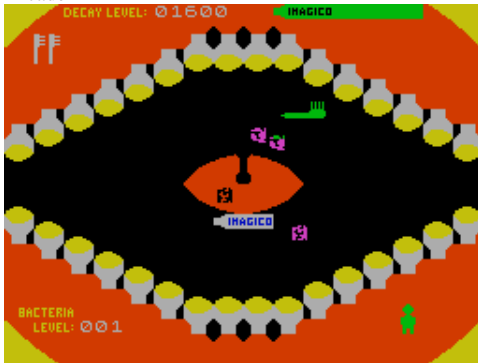

Molecule Man (Mastertronic Ltd,1986)
Arcade



Mole on the Dole (Gadtek Games,1986)
Arcade

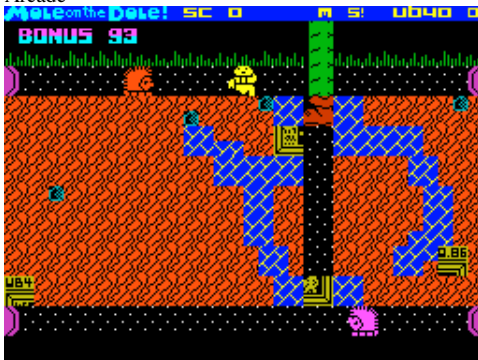

Modem (Happy-Computer,1985)
Utility

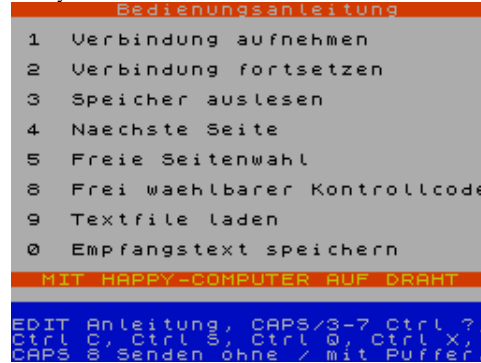

Modula-2 (Mira Software,1991)
Utility: Programming

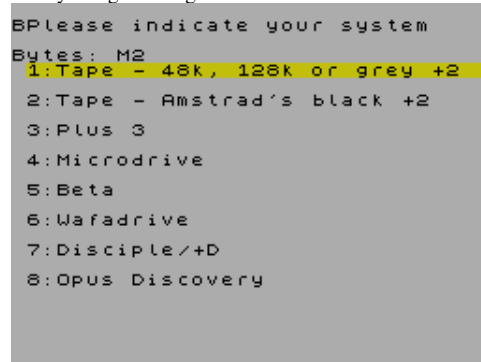

Mole (Cloud 9 Software,1984)
Educational



Molecule Man Designer (R.D. Foord Software.)
Arcade Game Development Tool

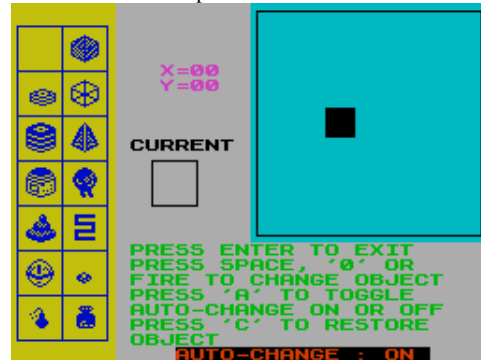

Molesworth (Ian Aldridge,1999)
Text Adventure

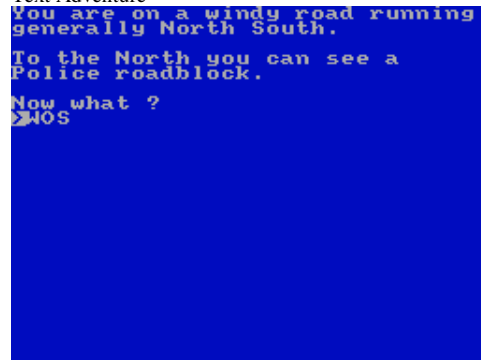

Moder-80 (Seven Stars Publishing,1984)
Utility: Assembler/Disassembler/Monitor

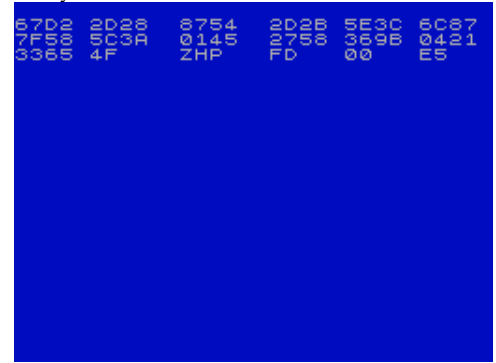

Moggy (Computer Emuzone,2005)
Arcade



Mole Attack (Spectrum Computing,1985)
Arcade



Mole, La (MicroHobby,1985)
Arcade



Moley Christmas (Your Sinclair,1987)
Arcade

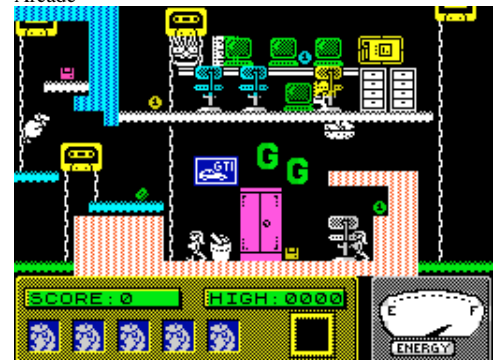

Molgrum (Ian Hughes,1989)

```

Utility
Name Res X Y Z
WOS 48 48.000 128.000 48.000

```

Name (up to 4 chars): C
 Money (Kassoft,)
 Scene Demo



Money Bags (Sinclair Programs,1984)



Monitor (.)
Utility: Assembler/Disassembler/Monitor

```

Ramtop: 00001000
MC-Bereich: 00000000
Daten: 00000000 bis 71999
RUN USR: 00000000

```

Monitor (Sinclair User,1992)
Utility: Programming

```

>E-LINE
6D2B LOAD

```

Momentos Electricos (MicroHobby,1985)

```

Utility: Electronics

```

```

WE HAVE
NO SCREENSHOT
OF THIS
PROGRAM

```

Money (Poppy Programs,1983)
Educational

```

WE HAVE
NO SCREENSHOT
OF THIS
PROGRAM

```

Money Manager (Creative Sparks,1984)
Utility: Spreadsheet

```

MENU : Main
1 New Year
2 Set Up Budgets/Categories
3 Opening Cash Balance
4 Interest Calculation
5 Change Actuals
6 Analysis
7 Save
8 End Program

```

Monitor (16/48 Tape Magazine,1986)
Utility: Assembler/Disassembler/Monitor

```

WE HAVE
NO SCREENSHOT
OF THIS
PROGRAM

```

Monitor 2 (.)
Utility: Assembler/Disassembler/Monitor

```

>WIND from 23296C

```

Mondphasen (.)

```

Utility: Astronomy/Astrology
MONDPHASEN
ANFANGSDATUM?

```

Money (Stell Software,1983)
Educational

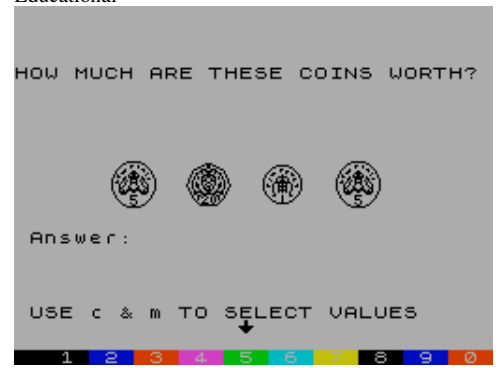

Mongoose (Gilsoft International,1982)
Arcade

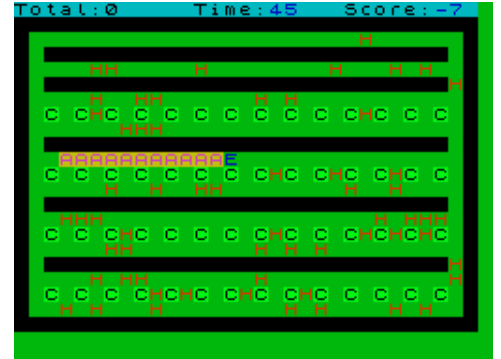

Monitor (MicroHobby,1985)
Utility

```

WE HAVE
NO SCREENSHOT
OF THIS
PROGRAM

```

Monitor and Disassembler (Crystal Computing,1982)
Utility: Assembler/Disassembler/Monitor

```

READY
>

```

Monitor de Código Máquina (MicroHobby,1991)
Utility: Programming



Monitor de Código Máquina +3 (MicroHobby,1990)
Utility: Programming

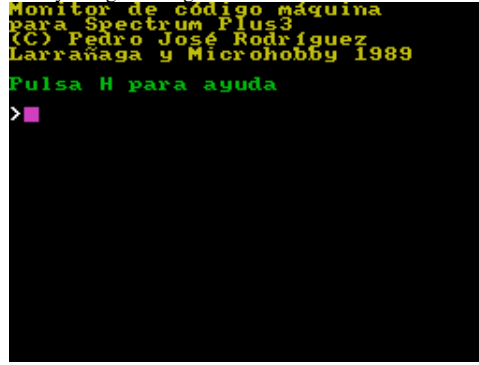

Monkey (16/48 Tape Magazine,1984)
Board/Card Game



Monkey Biznes (Artic Computing Ltd,1983)
Arcade

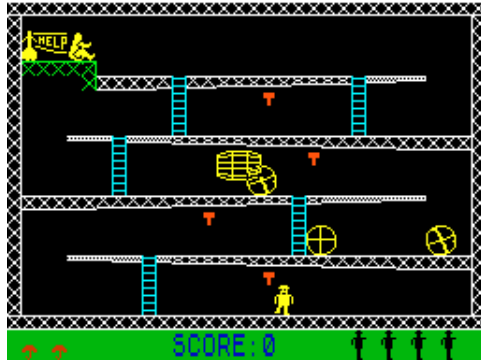

Monkey Run (.)
Arcade

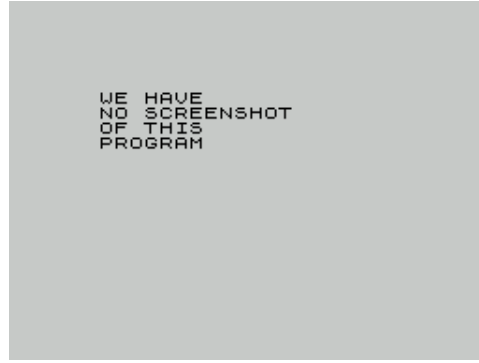

Mono (Rolf Strecker,1984)
Utility: Assembler/Disassembler/Monitor

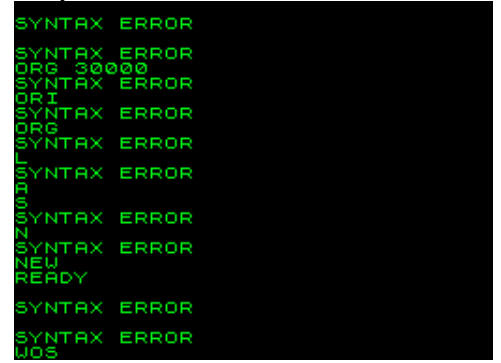

Monopol (Andres Garcia,2006)
Board/Card Game

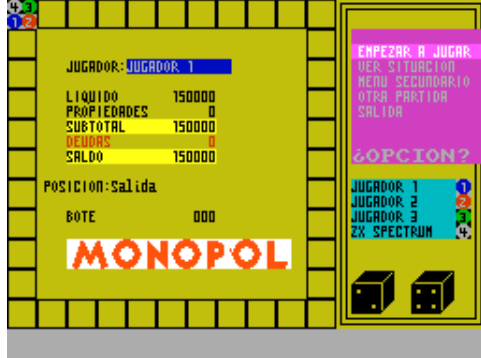

Monopoly (Leisure Genius,1985)
Board/Card Game



Monopoly (MicroHobby,1985)
Board/Card Game



Mono Saltarin, El (MicroHobby,1985)
Arcade



Monster (Haggisoft,1988)
Text Adventure



Monster (Machinecroft,1982)
Arcade



Monster + Star Reporter (Haggisoft,1987)
Compilation



Monster Chase, 3D (Romik Software,1984)
Arcade

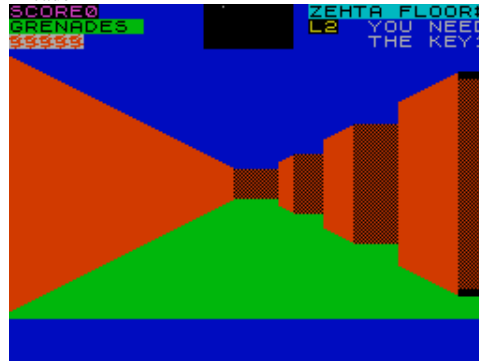

Monster Copy (.)
Utility: Copier

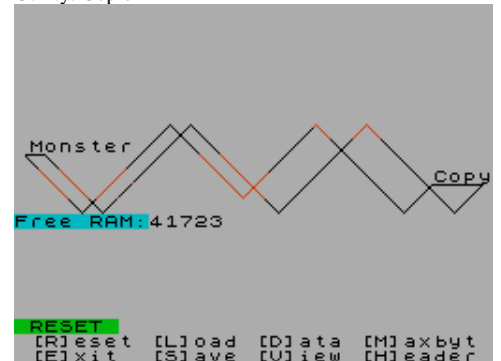

Monster Copy 2 (Jeremic Nebojsa,1985)
Utility: Copier

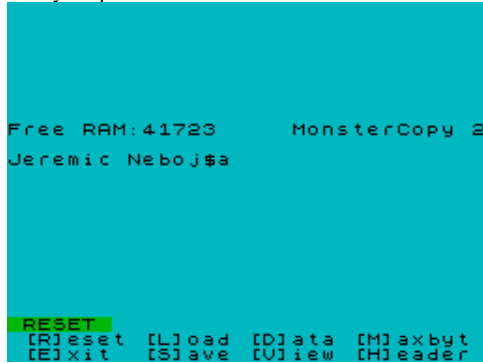

Monster Mine (Richard Shepherd Software Ltd,1982)
Arcade



Monster Muncher (Spectrum Games Ltd,1983)
Arcade



Monstrland: Testimony of The Ancient (Rage Creative Group,1998) Strategy

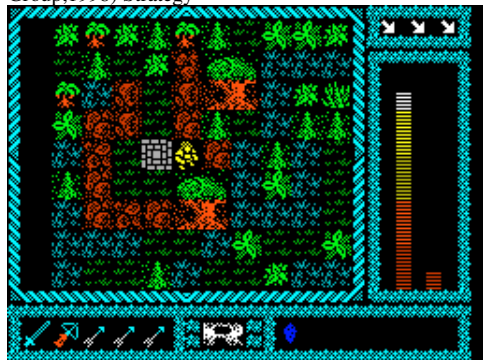

Montana Jones II (Home Masters,1994)
Arcade



Monster Maze, 3D (Russell Marks,) Arcade

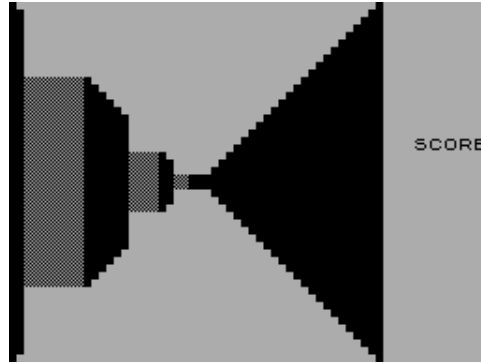

Monster Mines (Impact Software [1],1983)
Arcade



Monster Pit (16/48 Tape Magazine,1983)
Text Adventure

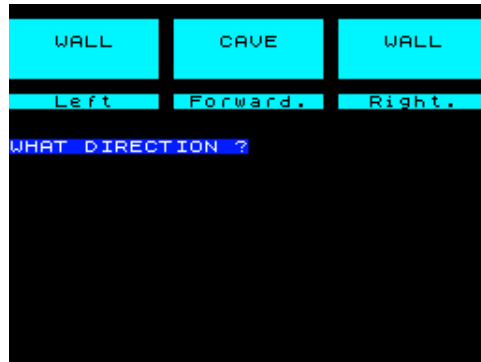

Monstrland 2: Mist (Rage Creative Group,1999) Strategy

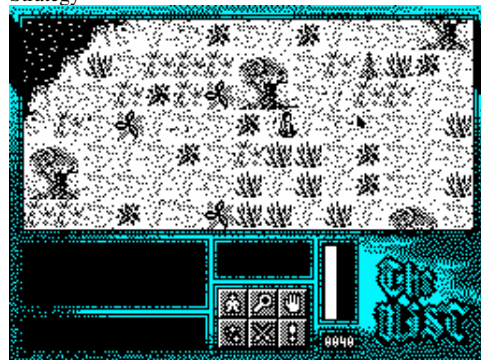

Montecarlo (MicroHobby,1985)
Arcade



Monster Mine (Gem Software,1982)
Arcade

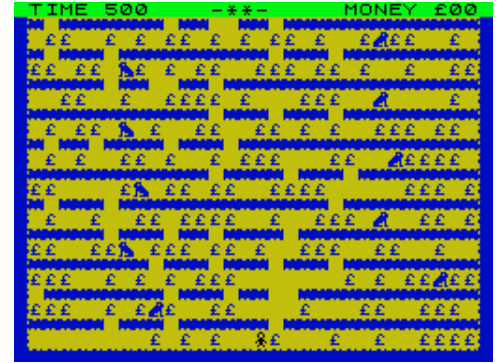

Monster Munch (Psychaedelic Hedgehog Software,1990)
Arcade Adventure



Monsters in Hell (Softek Software International Ltd,1983)
Arcade

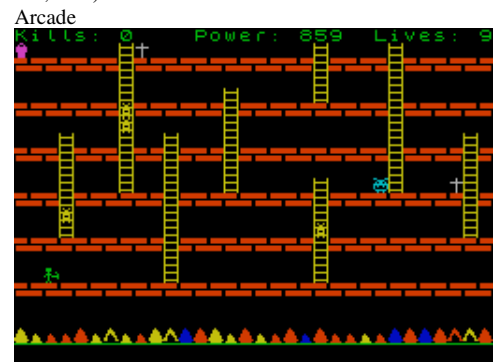

Montagne Magique, La (.1986) Text Adventure



Monte Carlo (Micromega,1983)
Compilation



Monte Carlo (Sinclair Research Ltd,1982)
Educational

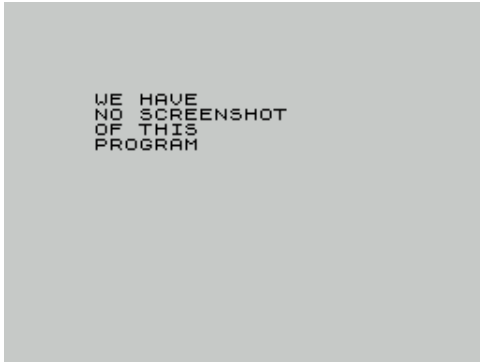

Monty is Innocent (Gremlin Graphics Software Ltd,1985)
Arcade



Monty the Python (Sinclair User,1985)
Arcade

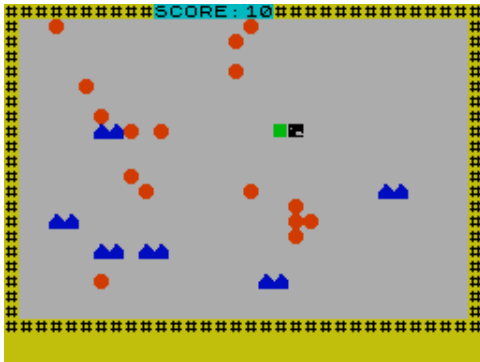

Moon Alert (Ocean Software Ltd,1984)
Arcade



Moon Buggy (Visions Software Factory,1983)
Arcade



Monte Carlo Casino (Code Masters Ltd,1989)
Simulation



Monty on the Run (Gremlin Graphics Software Ltd,1985)
Arcade



Moon (RinsSoft,1994)
Scene Demo



Moon Battle (.)
Arcade



Moon-Cargo (.)
Arcade



Monte, El (Sift,1984)
Board/Card Game

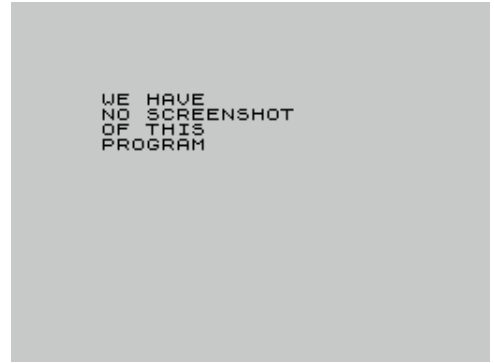

Monty Python's Flying Circus (Virgin Games Ltd,1990)
Arcade

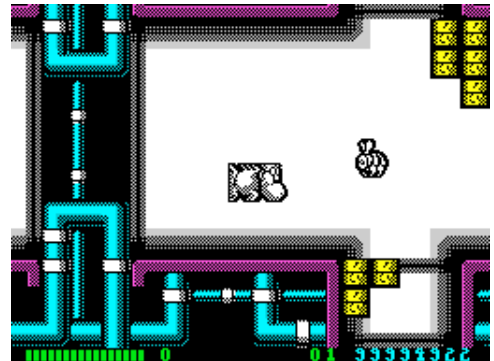

Moon 2 (RinsSoft,1994)
Scene Demo



Moon Buggy (Anirog Software,1983)
Arcade



Moon Cresta (Incentive Software Ltd,1985)
Arcade



Moon Defenders (Wizard Software,1984)
Arcade



Moonlander (Fun for Ever Soft,1984)
Arcade



Moonlander (WB Software,1983)
Arcade



Moonlight Magic (ESP Software,1984)
Arcade



Moon Patrol (.)
Arcade



Mooniron (Your Sinclair,1986)
Arcade

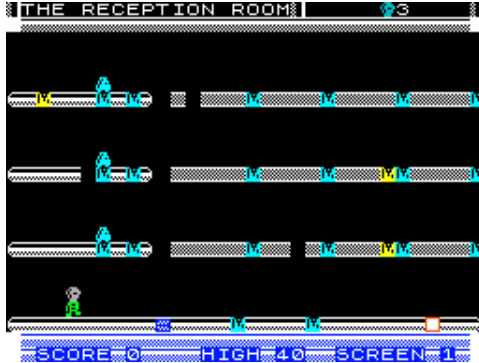

Moonlander (Orion Software,1983)
Arcade



Moonlighter (Software Super Savers Ltd,1984)
Arcade



Moon Magic (Psychaedelic Hedgehog Software,1989)
Text Adventure



Moon Patrol (Atarisoft,1984)
Arcade



Moon Lander (Abacus Programs,1984)
Arcade

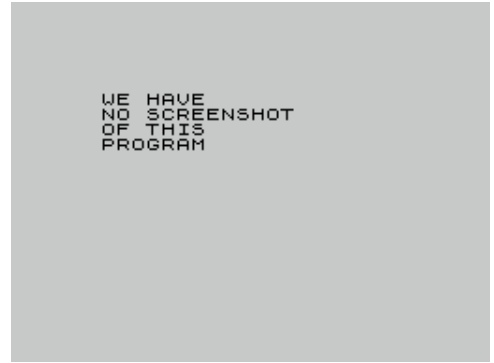

Moonlander (Spectrum Computing,1984)
Arcade



Moonlight Madness (Bubblebus Software,1986)
Arcade



Moon Magic 2: Sponge (Psychaedelic Hedgehog Software,1989)
Text Adventure



Moon Patrol (Jose Maria Gonzalez Ondina,2003)
Arcade



Moonquake (Laurence Creighton,1989)

Text Adventure



Moon Rescue (.)

Arcade



Moons of Tantalus (Cornhill Services,1984)

Arcade



Moontorc (Atlantis Software Ltd,1991)

Arcade Adventure



Moose (Rainbird Software Ltd.)

Arcade



Moonraker (Assassin Software,1984)

Arcade

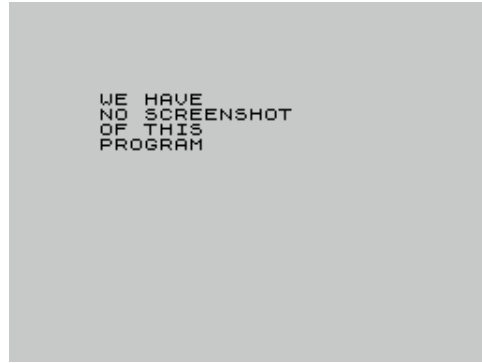

Moonrover (Gamesoft [2],1985)

Arcade



Moon Strike (Mirrorsoft Ltd,1987)

Arcade

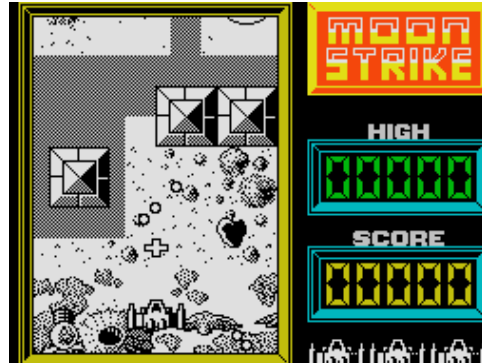

Moonwalker (US Gold Ltd,1989)

Arcade Adventure

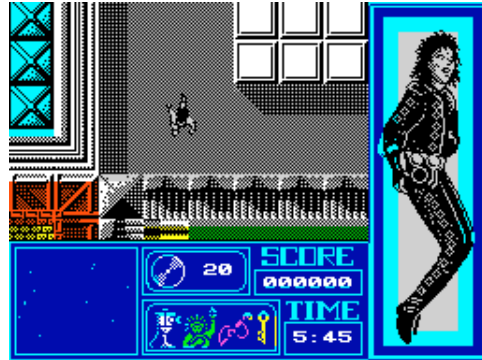

Moozik 1 (Anthraxx Developments,1990)

Scene Demo



Moonraker (Black Knight Software,1986)

Strategy



Moonshards of Sacrimore (Mark Beech,1989)

Text Adventure



Moonsweeper (Cheetahsoft Ltd,1983)

Arcade

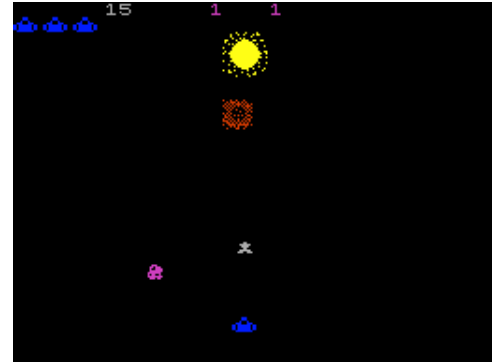

Moorhuhn: First Blood (Triebkraft/Fourth Dimension,2002)

Arcade



Moozik 2 (Anthraxx Developments,1990)

Scene Demo



Morbid Visions (Asphyxia,1997)

Scene Demo

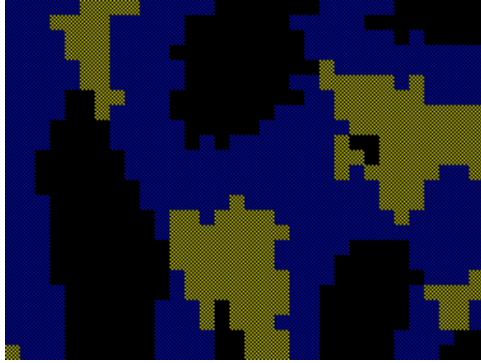

Moreby Jewels, The (Double Play Adventures,1986)

Text Adventure

```

vivid details of the previous
night's adventure. I get ready
for work and take my coat from
the coatstand by the front door
thinking how nice it would be
to embark on a real adventure
for a change instead of having
to trudge off to the office!
It's bitterly cold outside.
I can also see:-
A WALLET

Tell me what to do.
TAKE WALLET
OK.

I'm ready for your instructions.
EXAMINE WALLET
I see nothing special.
I await your command.
WOS

```

Moron (Atlantis Software Ltd,1986)

Text Adventure

```

A TELEPORT ROOM IN THE U.K.
You can also see:-
a SPACESUIT
a TELEPORT BUTTON marked PRESS

Next command please.
EXAMINE TORCH
You see nothing special.

Next command please.
TORCH ON
Sorry! Incorrect command.

Next command please.
WOS

```

Morse Code (Sinclair User,1985)

Educational

```

MENU
1 HEAR MORSE WHEN KEY IS PRESSED
OR ENTER MORE THAN ONE LETTER,
DIGIT TO HEAR MORSE 'PLAYBACK'
2 SEE MORSE - PRESS CORRECT KEY
3 HEAR MORSE -PRESS CORRECT KEY
4 PRESS KEY - WATCH ALDIS LAMP
5 READ SIMULATED MORSE CIPHER
(i.e.) CONTINUOUS GROUPS OF
FIVE RANDOM AUDIBLE SYMBOLS
6 AS 5 BUT READ ALDIS LAMP
7 QUIT
BEGINNERS ROUTINES SHOWN IN RED

ENTER KEY 1 TO 7"Q"

```

Morse Code Tutor (Your Sinclair,1986)

Educational

```

LISTEN TO YOUR MESSAGES.
ENTER TO RETURN TO MENU.
MESSAGE IS 17 CHARACTERS LONG
MESSAGE:-WORLD OF SPECTRUM
WORLD OF SPECTRUM

```

Mordon's Quest (Melbourne House,1985)

Text Adventure

```

You are on a parquet landing, to your
west a fine mahogany staircase with an
ornate banister sweeps down to an oak
pannelled hallway. To the north lies the
entrance to a bedroom, another entrance
lies to the east and a locked door leads
to the south wing.

e

You have entered a lavish if somewhat
unusually decorated bathroom. Through a
window to the east you can see a moss
covered drainpipe.

WOS

Pardon?

go east

You can't go that way.

```

More Than Nop (Jacek Michalak,1994)

Scene Demo

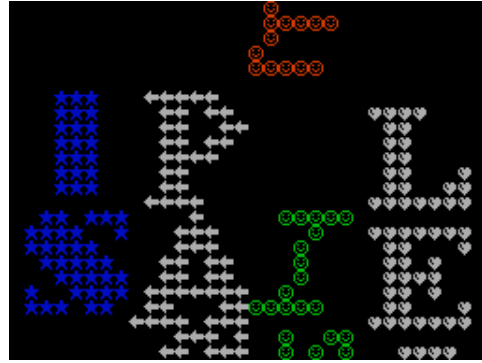

Morris Meets the Bikers (Automata UK Ltd,1983)

Arcade



Morse Code Practice (.)

Educational

```

WE HAVE
NO SCREENSHOT
OF THIS
PROGRAM

WOS

```

Morse Decoder (Michael Schramm,1984)

Utility

```

WE HAVE
NO SCREENSHOT
OF THIS
PROGRAM

```

More (Dominic Morris,1996)

Utility: Word Processor

```

More v1.4 - 15.5.96
-----

Okay, so I got bored one day, I needed a 64 column text viewer
that was quick, and worked, and didn't have to be told how
long a file was, and also gave me an indicator as to how much
of the file I'd read...I looked on my discs, but there wasn't
one...

So I wrote this little program - it's 2.75k (including font),
which I've decided to call More, because it looks like the UNIX
viewer of the same name (also ported to every machine on the
Earth as well I think...), even though it's very cut down...but
it works and you can feel free to use it as a standardish text
viewer. The following keys are used:

Usage:

Space - scroll screen down
N      - scroll screen down
B      - scroll screen up
Enter  - scroll line down

More (11%)

```

Morgan's Seal (The Guild,1992)

Text Adventure

```

Do you want the five day limit
(Y/N)

What now?...n
You are standing outside a
small croft. The dead body of
Thomas Goodley lies beside you.
Looking around, you see a track
to the west, farm land to the
east and the open door to the
croft to the south.

What now?...s
You are inside an old but
comfortable croft. Flames from
the small fire burning in the
grate cast flickering shadows
around the room. A table, chair
and bed are the only visible
features of the room.

What now?...WOS

```

Morse (R.E. Stephens,)

Utility

```

WE HAVE
NO SCREENSHOT
OF THIS
PROGRAM

```

Morse Coder (.)

Utility

```

MORSE-CODER

Geben = 30

Sendetext :

WOS

```

Morselandia (MicroHobby,1985)

Utility

```

WE HAVE
NO SCREENSHOT
OF THIS
PROGRAM

```

Morse Manipulator (Spectrum Computing,1983)
Utility

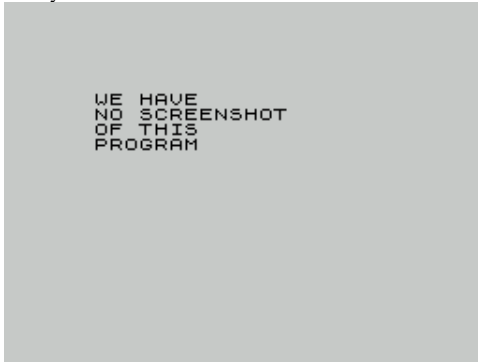

Morse Transceive (G4OIK/G4OIL,1985)
Utility

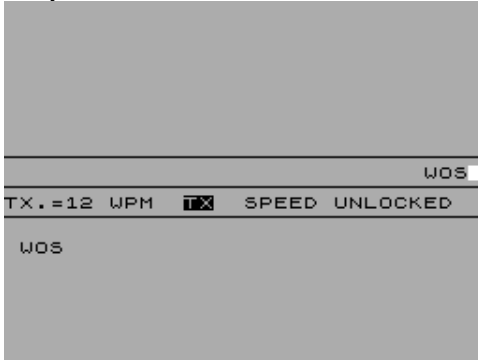

Mortadelo y Filemon II (Dro Soft,1990)
Arcade Adventure



Moscow-Paris (Marck Kiszakiewicz/Jacek Mering,1987)
Text Adventure



Mosquitos Revenge (MicroHobby,1986)
Arcade



Morse Reader (G4OIK/G4OIL,1984)
Utility



Morse Tutor (G4OIK/G4OIL,1984)
Utility

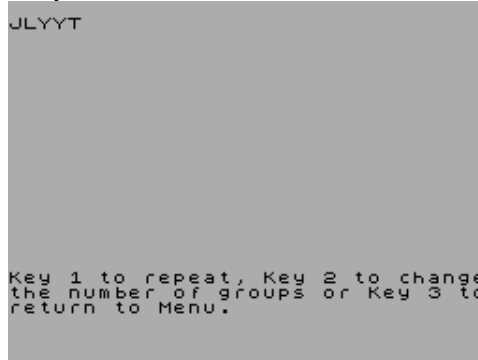

Mortal Kombat (AWS/Mafia P.C.,1997)
Arcade



Moscow Raid (Sinclair Programs,1983)
Arcade

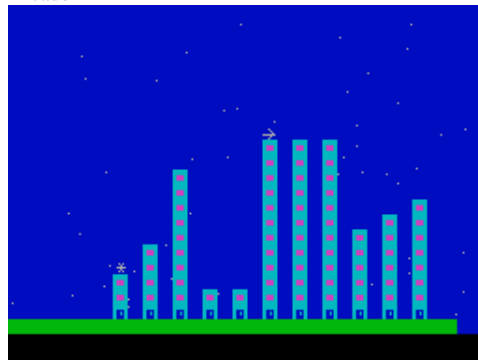

Mot (Opera Soft S.A.,1989)
Arcade Adventure



Morse Trainer (.)
Utility



Morsezeichengenerator (.)
Utility

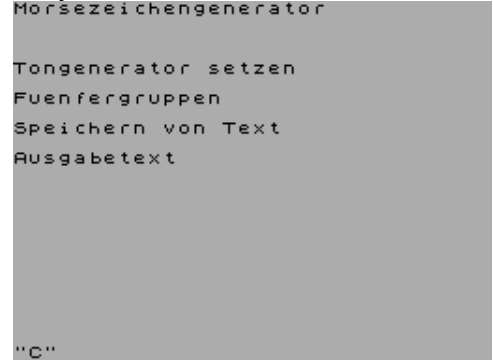

Mortal Kombat (XL-Design Inc,1997)
Arcade



Mosquito (Sinclair User,1984)
Arcade



Mothership (Artic Computing Ltd,1984)
Arcade



Motion (SciCAL Software Ltd,1983)
Educational

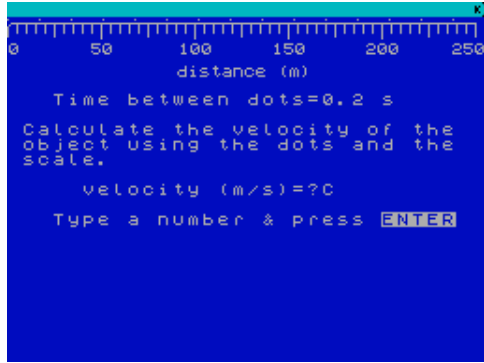

Motorbike Madness (Mastertronic Ltd,1988)
Arcade

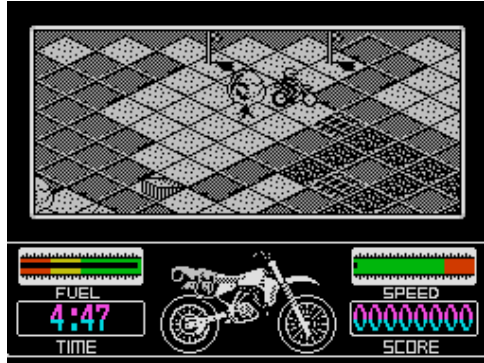

Motor Mania (EMS Software,1984)
Arcade

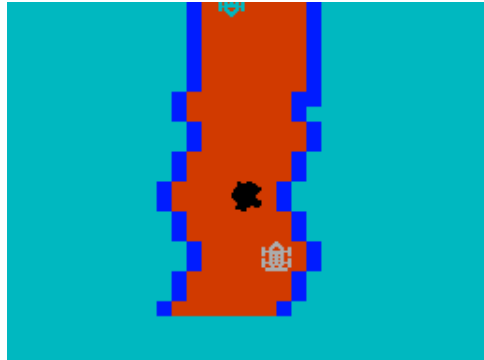

Motos (Mastertronic Added Dimension,1987)
Arcade

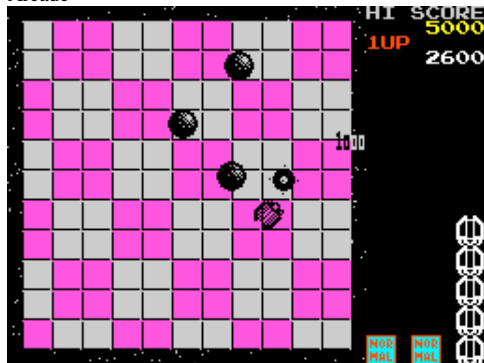

Mountain Bike Racer (Positive,1990)
Arcade

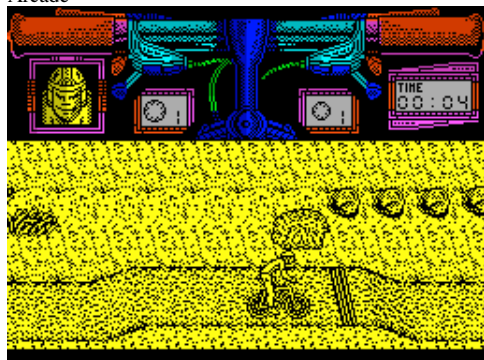

Moto Cross Simulator (Code Masters Ltd,1989)
Arcade

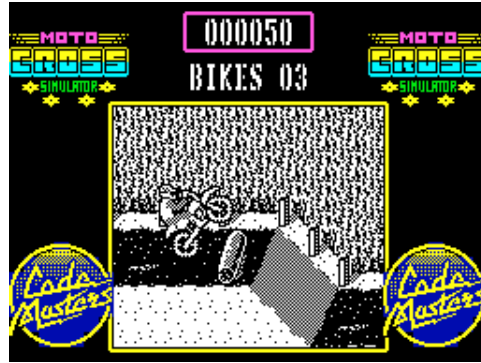

Motorcycle 500 (Cult Games,1990)
Simulation



Motor Massacre (Gremlin Graphics Software Ltd,1989)
Arcade

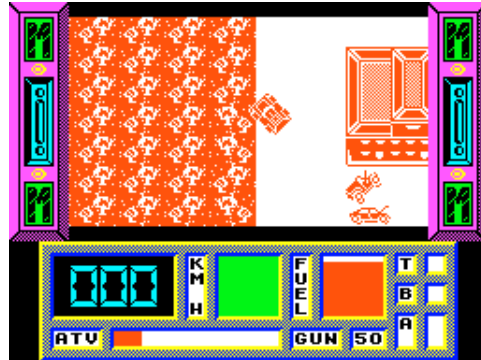

Mototron (Andromeda Inc.)
Arcade



Mountain Bike Racer (Zeppelin Games Ltd,1990)
Arcade



Motojet (Jorge Perez Barreiro,1986)
Arcade



Motorcycle Crazy! (Kerian UK Ltd,1984)
Text Adventure



Motorway Mastermind (West Midlands County Council,1985)
Educational



Mountain Bike 500 (Code Masters Ltd,1991)
Simulation



Mountains of Ket (Incentive Software Ltd,1983)
Text Adventure

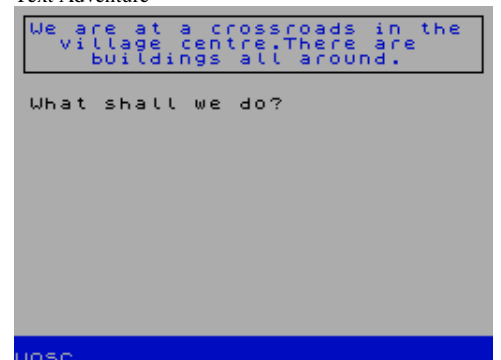

Mount Challenge (Aasvoguelle Productions,1985)



Mouse Man (Northern Underground,1990)



Move'em All! (Key Soft,1996)

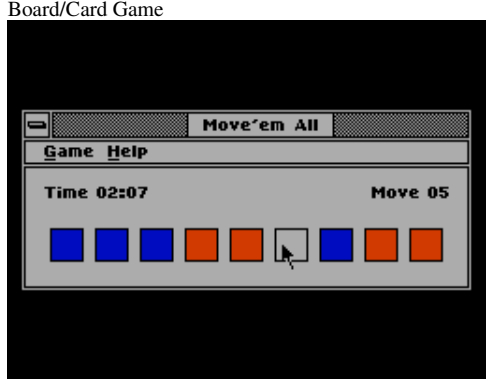

Movie (Imagine Software Ltd,1986)

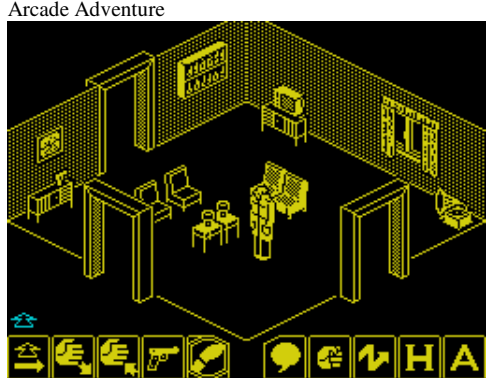

Movimiento Parabolico (MicroHobby,1985)



Mountie Mick's Death Ride (Reaktor,1987)

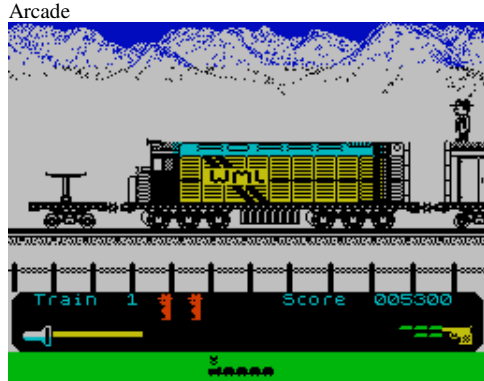

Mouse, The (J. Griffiths,1985)



Move It! (Sinclair Programs,1983)

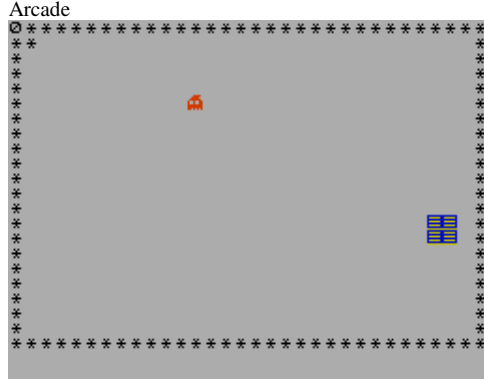

Movie Premiere (Elite Systems Ltd,1992)



Moving Target (Players Premier Software,1989)



Mouse (WB Software,1983)

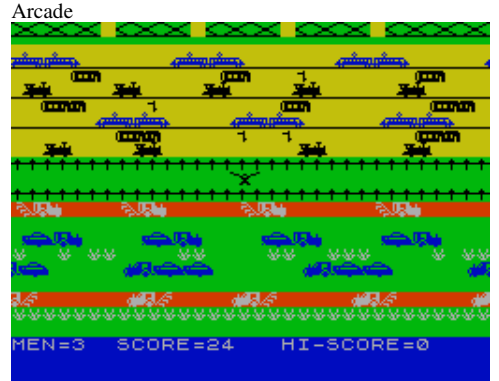

Mouse Trap (Spectrum Computing,1984)



Mover, 3D (ERE Informatique,1984)



Moviles (MicroHobby,1985)

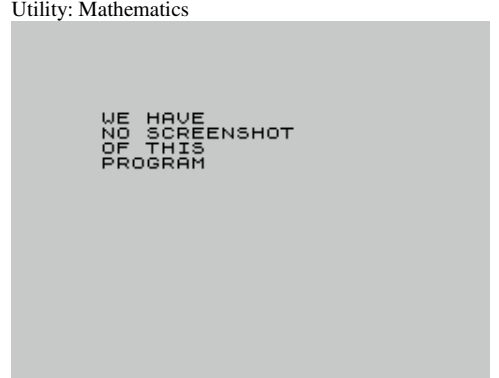

Mow the Lawn (Sinclair Programs,1984)

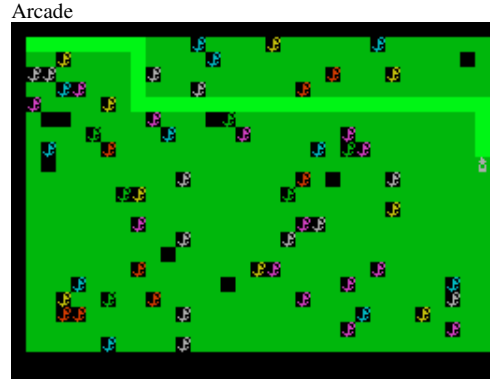

Mozart (Octopus Software,1984)
Music



MQM 4 (MQM Team,1993)
Scene Demo

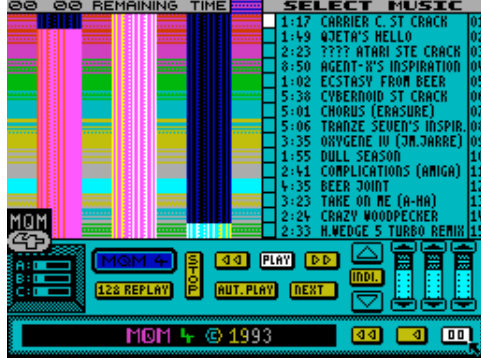

MQM Demo II (MQM Team,1992)
Scene Demo



Mr. Copy + (P. Kreybig,1986)
Utility: Copier

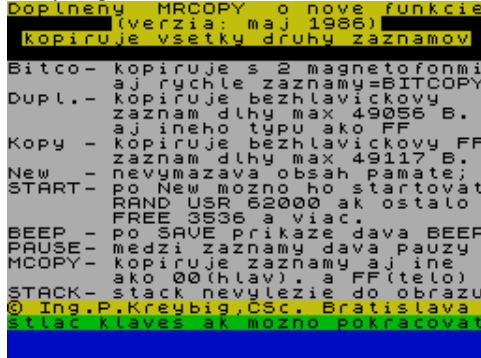

Mr. Grumpy (Garry Rowland,1993)
Simulation

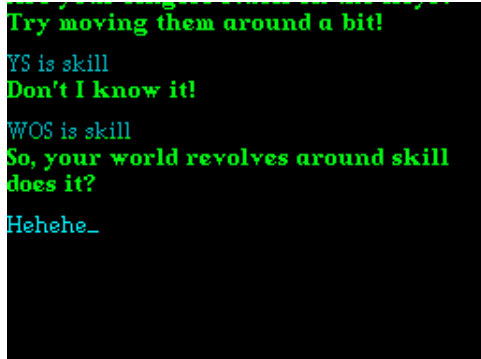

Mozg Processor (Computer Adventure Studio,1989)
Text Adventure



MQM 5 (MQM Team,1993)
Scene Demo



Mrazik '88 (Phalas,1988)
Text Adventure



Mr. Freeze (Firebird Software Ltd,1984)
Arcade



Mr. Gulp (Wizard Software,1984)
Arcade



Mpthrilla: The Metal Miner (Cronosoft,2006)
Arcade



MQM Demo (MQM Team,1992)
Scene Demo



Mr. Copy (L. van Sonderen,1983)
Utility: Copier



Mr. Gas (Xortrapa Soft,1990)
Arcade

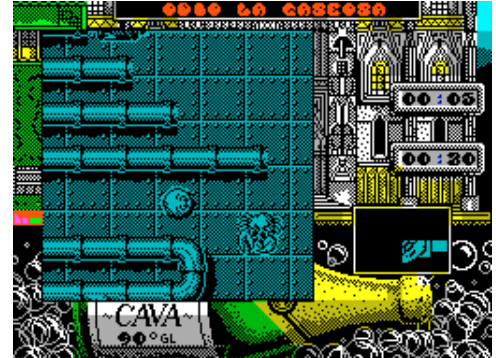

Mr. Heli (Firebird Software Ltd,1989)
Arcade

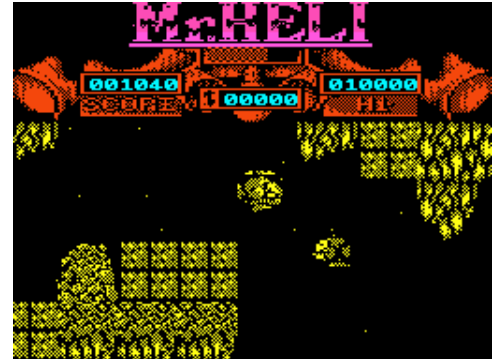

MR Jones Basic Progs Tape 20 (Mark R. Jones,) Compilation

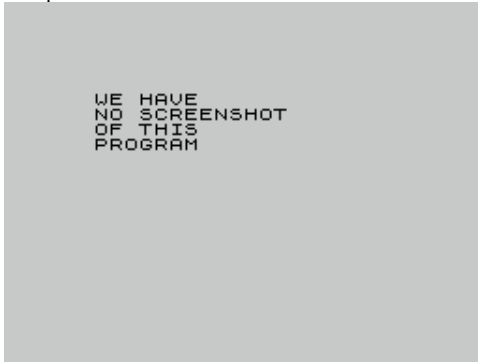

MR Jones Computer Games Tape 40 (Mark R. Jones,) Compilation

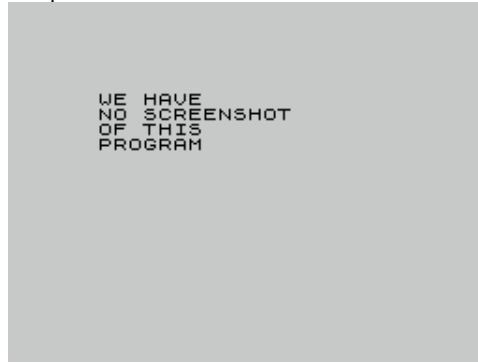

MR Jones Development Tape 1 (Mark R. Jones,) Compilation



MR Jones Development Tape 2 (Mark R. Jones,) Compilation



Mr. Pack I (Mixoft,1991) Utility



Mr. Pack II (Proxima Software,1991) Utility



Mrs Mopp (Computasolve,1984) Arcade



Mr T Meets His Match (Ebury Software,1984) Educational



Mr T's Alphabet Games (Ebury Software,1985) Educational



Mr T's Jungle Stories (Ebury Software,1984) Educational

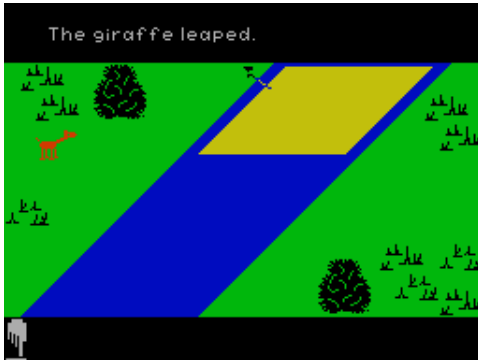

Mr T's Measuring Games (Ebury Software,1984) Educational

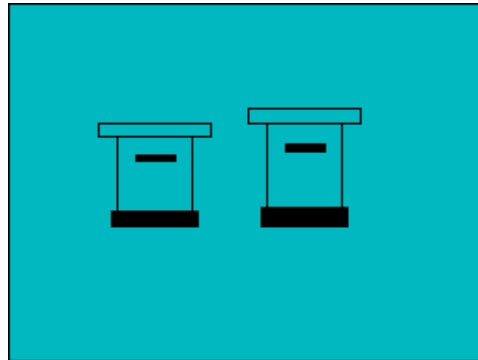

Mr T's Money Box (Ebury Software,1983) Educational

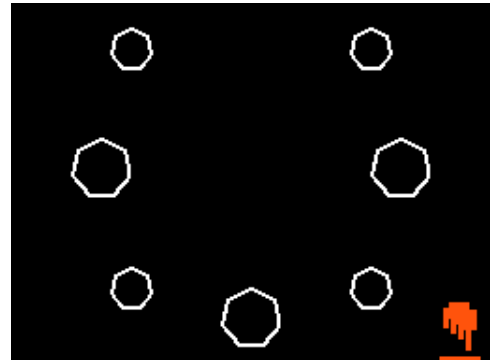

Mr T's Number Games (Ebury Software,1983) Educational

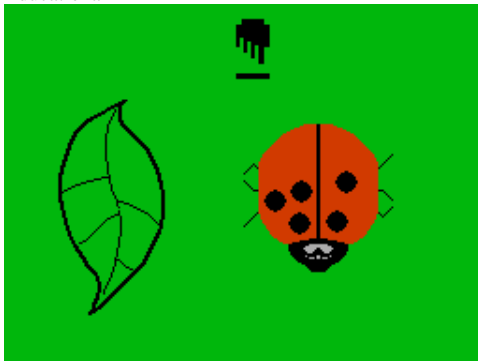

Mr T's Shape Games (Ebury Software,1984) Educational

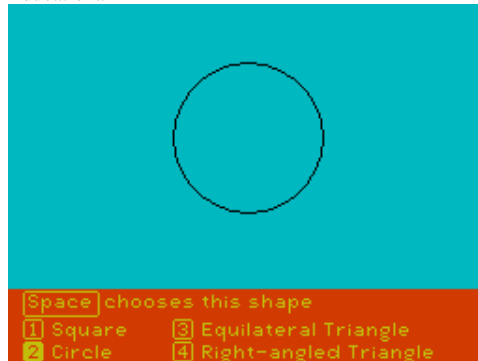

Mr T's Simple Sums (Ebury Software,1984) Educational



Mr T Tells The Time (Ebury Software,1983)
Educational

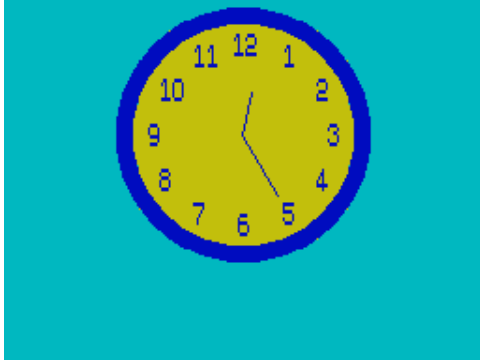

Mr. Wimpy (Ocean Software Ltd,1984)
Arcade

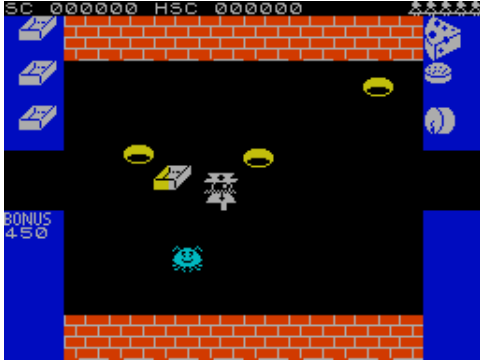

Mr. Zufus (Luca Bordonni,1986)
Arcade

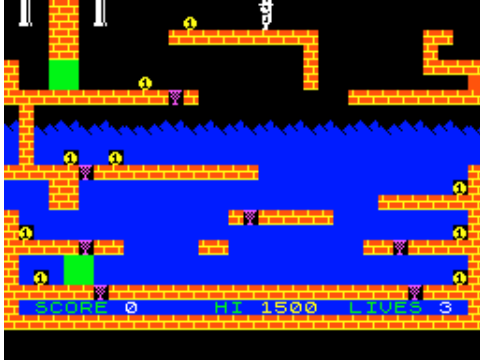

MSX 1 (Klav,1992)
Scene Demo



MSX 2 (Klav,1992)
Scene Demo

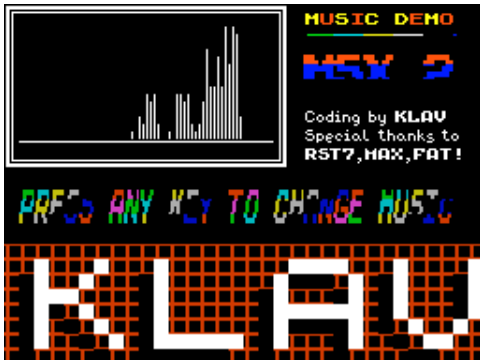

Mr. Vain (Culture Beat,1993)
Scene Demo



Mr. Wino (Silverbird Software Ltd,1988)
Arcade

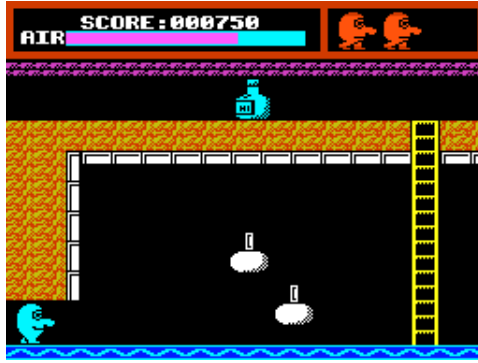

Ms. Pac-Man (Atarisoft,1984)
Arcade



Msx 10 (Max Iwamoto/RST7,1993)
Scene Demo

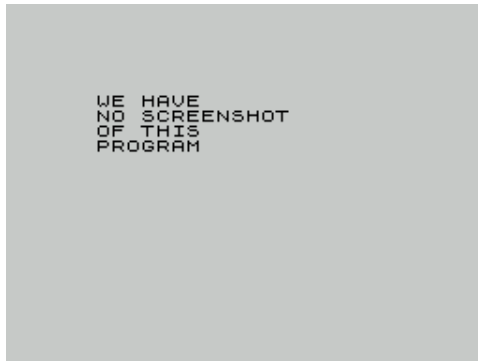

MSX 3 (Klav,1992)
Scene Demo



Mr. Weems and the She Vampires (Piranha,1987)
Arcade



Mr. Wong's Loopy Laundry (Artic Computing Ltd,1984)
Arcade

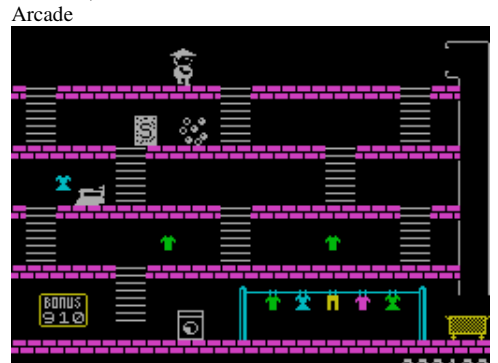

M.SPLASH (Flash Inc,1994)
Scene Demo



Msx 12 (Max Iwamoto/RST7,1993)
Scene Demo



MSX 4 (Klav,1992)
Scene Demo



MSX 8 (Klav,1992)
Scene Demo



MSX VI (Klav,1992)
Scene Demo



Mudanza de las Hormigas, La (MicroHobby,1984)
Board/Card Game



Mugsy's Revenge (Melbourne House,1984)
Text Adventure

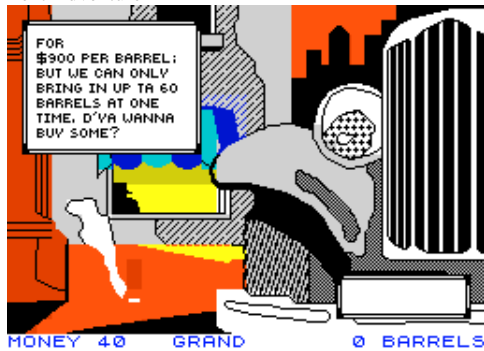

Multi-Copy (INDUG,1988)
Utility



MSX 9 (Klav,1992)
Scene Demo



MT1 Microdrive Toolkit (Kobrahssoft,)
Utility



Muggins the Spaceman (Firebird Software Ltd,1987)
Arcade



Multi-Chop (ZX-Guaranteed,)
Utility



Multi Disk (CNS,1985)
Utility



Msx 9 (Max Iwamoto/RST7,1993)
Scene Demo

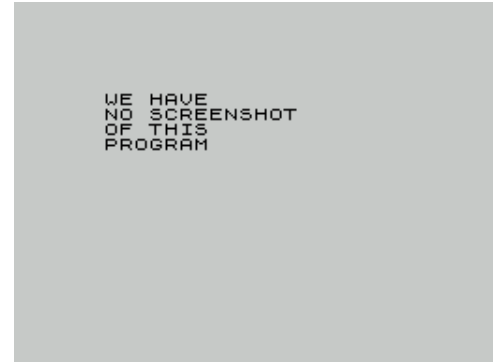

Mucroid Run (,)
Arcade

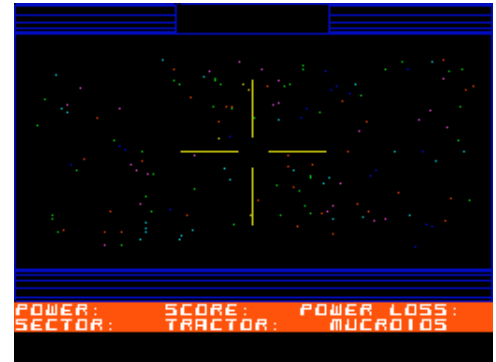

Mugsy (Melbourne House,1984)
Text Adventure



Multi-Coloured Sprite Graphics (B.Sides Software,1983)
Utility



Multiface Three in One Utility (Khalid Rafiq,1988)
Utility



Multi File (CNS,1984)
Utility



Multiload (Foraits Software,1986)
Utility

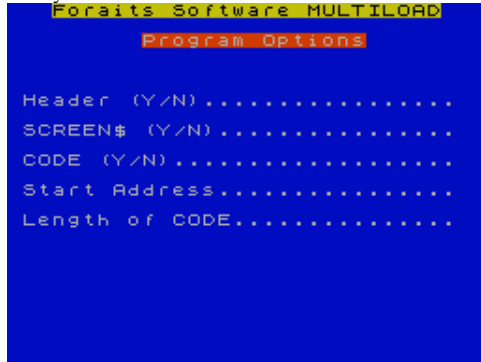

M-Ultimate (Britannia Software Ltd,1985)
Board/Card Game



Multimixx 3 (Kixx,1991)
Compilation

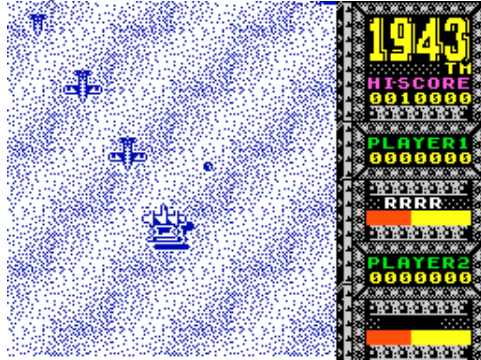

Multipaint (Touchmaster Ltd,1984)
Utility: Drawing



Multi File, The (Interactive Software People,1984)
Utility

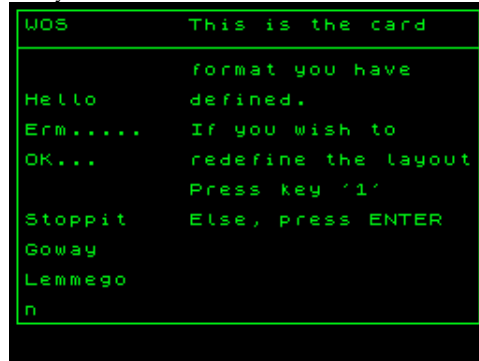

Multi-Load (Your Sinclair,1989)
Utility

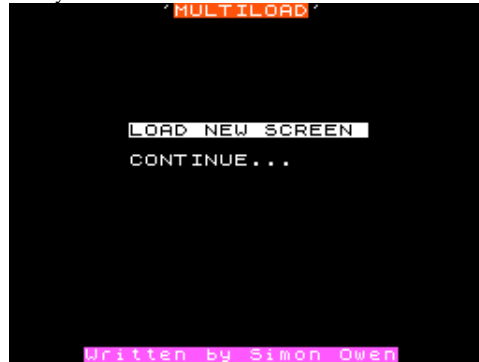

Multimixx 1 (Kixx,1991)
Compilation



Multimixx 4 (Kixx,1992)
Compilation



Multi-Player Soccer Manager (D&H Games,1991)
Simulation



Multifont (Image Systems,1983)
Utility



Multi Mania (Simon Owen,1989)
Cheat



Multimixx 2 (Kixx,1991)
Compilation



Multimixx 5 (Kixx,1992)
Compilation



Multiple Choice (Data-Skip Software,1985)
Simulation



Multiplication Tables (Calpac Educational Software,1983)
Educational

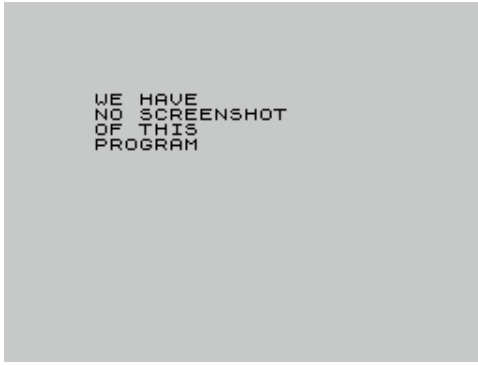

Multisports 2: Opera vs. Dinamic (Opera Soft S.A./Dinamic Software,1992) Compilation



Multi-User Dungeon (.)
Text Adventure

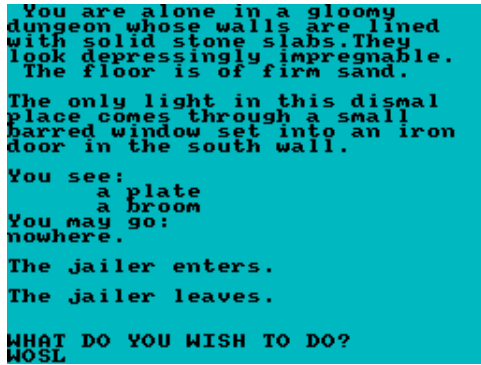

Muncher (Siversoft Ltd,1982)
Arcade

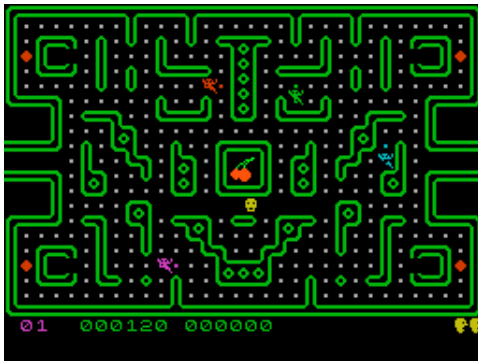

Munchie Man (Virgin Books,1983)
Arcade

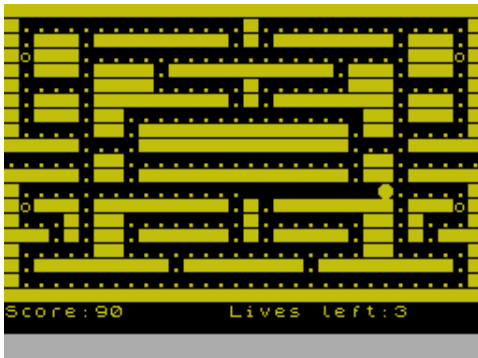

Multi Prog (.)
Utility: BASIC Related

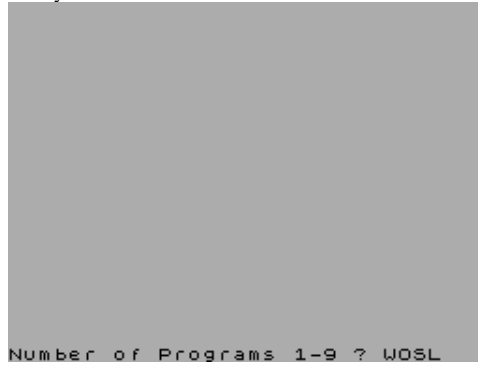

Multistore (Sinclair User,1992)
Utility



Mummy! Mummy! (MC Lothlorien Ltd,1984)
Arcade



Muncher Compo, The (Sinclair User,1988)
Arcade

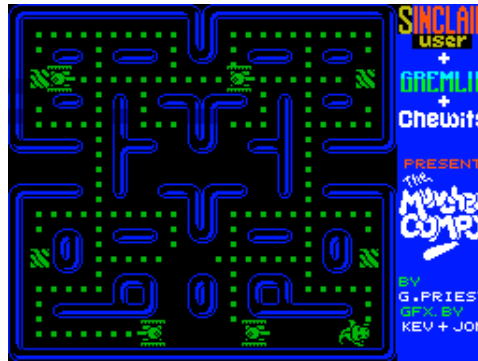

Munchman (Contrast Software,1983)
Arcade

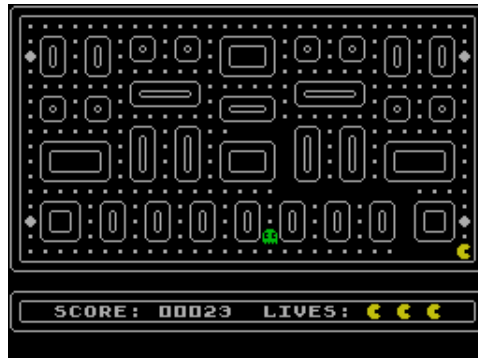

Multi Sports (Dinamic Software,1991)
Compilation

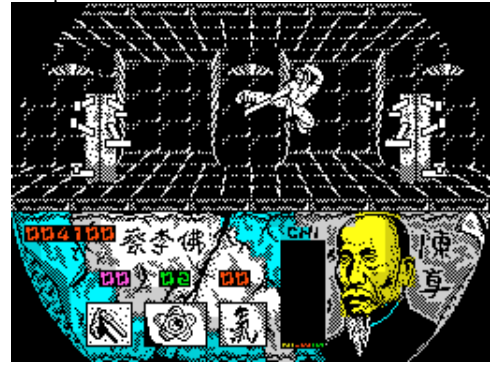

Multitracker (XRI Systems,1987)
Utility



Mummy's Crypt, The (Laurence Creighton,1992)
Text Adventure

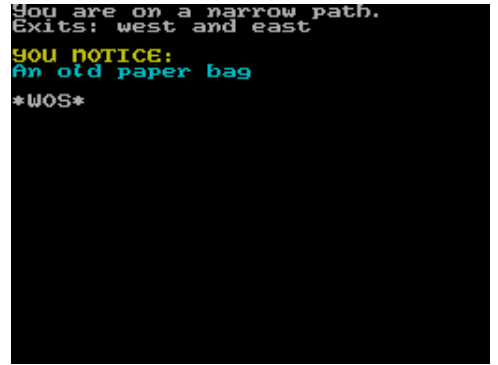

Muncher, The (Gremlin Graphics Software Ltd,1988)
Arcade



Munch Man (DK'Tronics Ltd,1983)
Arcade

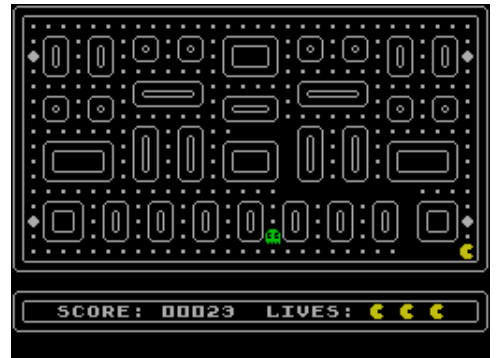

Munch Man (Gilsoft International,1982)
Arcade



Mundo de Mister Emulator, El (Javier Ortiz Carrasco,1998)
Arcade Adventure

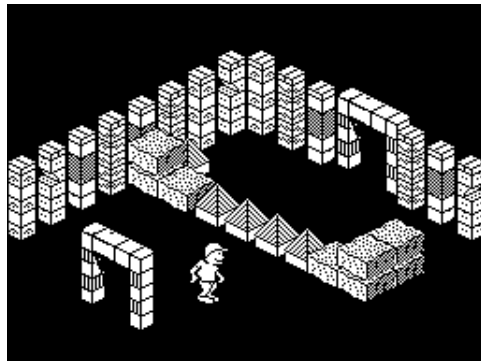

Munnery's Mergatroids (Abacus Programs,1984)
Arcade



MUP (JC Jumbo Data,1984)
Utility

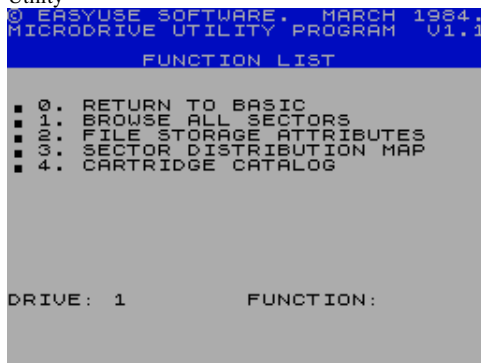

Murder at Hamilton Halls (The Fly On The Wall,)
Text Adventure



Munch Man (Neptune Computing,1983)
Arcade



Mundo Fantastico (DT Soft,1989)
Text Adventure



Munnery's Mergatroids + Night Driver (Abacus Programs,1983) Compilation



Murder (Central Solutions,1986)
Text Adventure

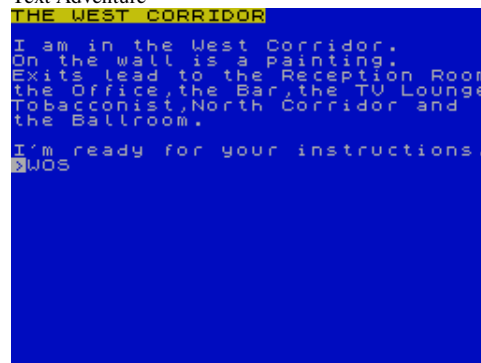

Murder at the Manor (Gemtime,1983)
Text Adventure



Mundial de Futbol (Opera Soft S.A.,1990)
Sport

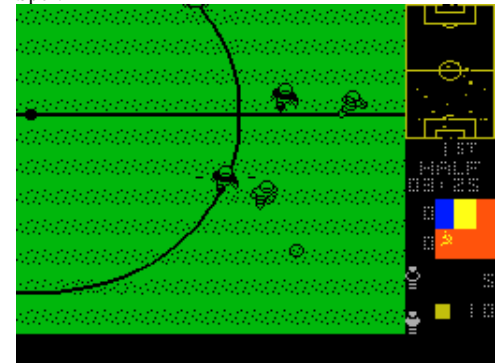

Mundo Magico (Aventuras Espanolas,1991)
Text Adventure



Munsters, The (Again Again,1989)
Arcade Adventure



Murder! (Rabbit Software Ltd,1983)
Text Adventure



Murder - He Said (Zenobi Software,1993)
Text Adventure

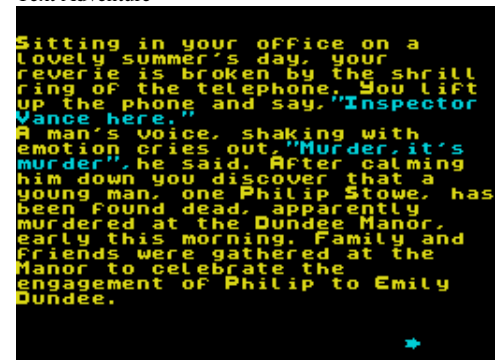

Murder Hunt (Bodkin Software,1986)

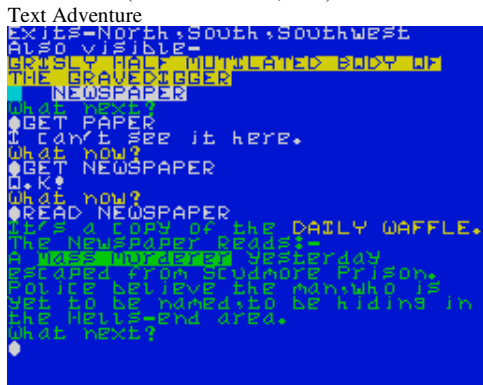

Murder, Mystery (Grant Wilson,1986)



Murder on the Atlantic (Infogrames,1986)



Muren (Micro Limit,1984)

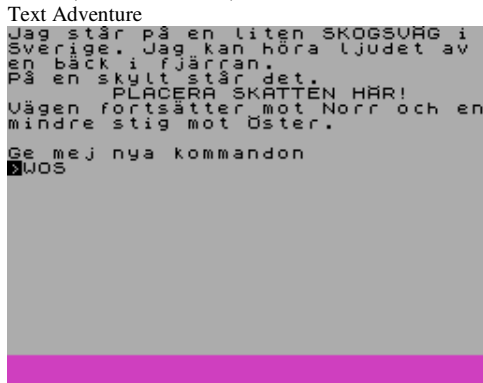

Murphy (Pirate Software Ltd,1988)



Murder Hunt II (Zenobi Software,1992)



Murder Mystery Weekend (Zenobi Software,1997)

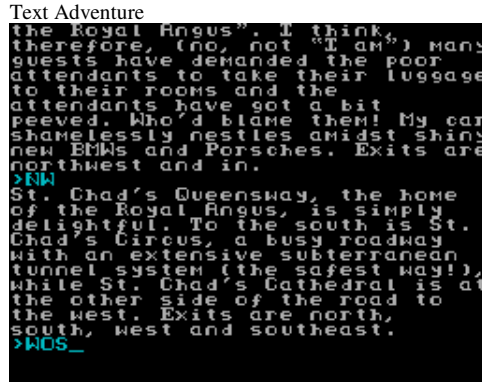

Murders in the Rue Morgue (Karl Crawford,1987)

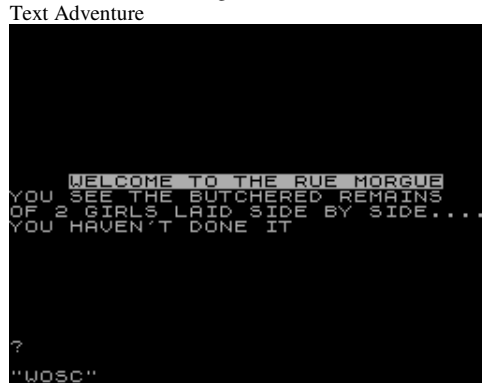

Murk 3320 (Wanderer,1996)



Murphy's Murder Hunt (.)



Murder Most Foul (Teacher's Pet Software,1988)

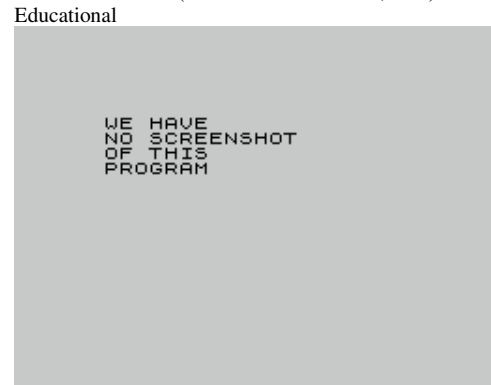

Murder Off Miami (CRL Group PLC,1987)



Murder, The (William Bell,)



Murk 3327: Invade of Black Warriors (Wanderer,1996)



Murray Mouse Supercop (Code Masters Ltd,1992)



Musculos (MicroHobby,1985)
Utility



Mushrooms from Mars (Scorpio Gamesworld,1984)
Arcade



Music 1 (Sinclair Research Ltd,1982)
Educational

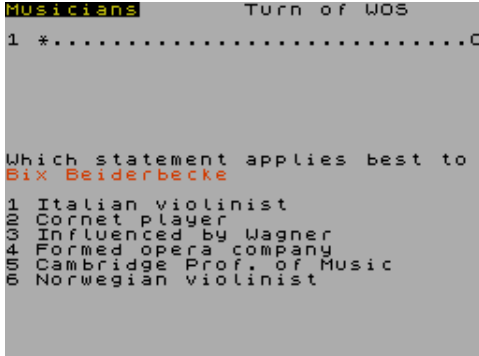

Musical Explosion, The (The Nightman,1990)
Scene Demo



Musical Megademo 2, The (The Octopus,.)
Scene Demo

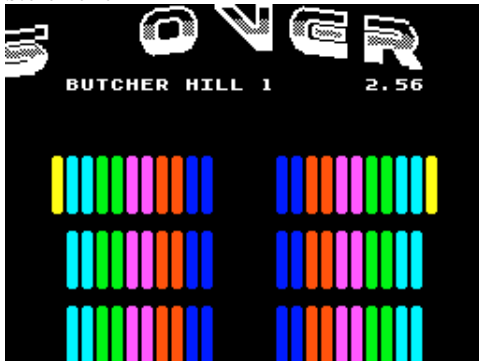

Mushroom Alley (Mogul Communications Ltd,1984)
Arcade



Music (R.D. Foord Software,1986)
Utility: Music Creation



Musica (.)
Utility: Music Creation



Musical Extravaganza, The (The Nightman,1990)
Scene Demo



Musical Snowmen, The (Brown Software,.)
Music



Mushroom Mania (Arcadia,1988)
Arcade



Music (Scotsoft,.)
Utility: Music Creation

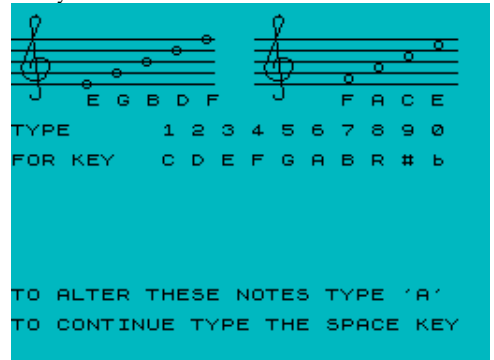

Musical Christmas Greeting (Alchemist Research,.)
Music



Musical Megademo 1, The (The Octopus,1988)
Scene Demo

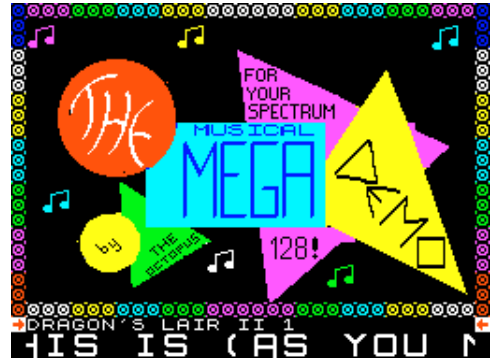

Musica Simultanea (MicroHobby,1991)
Utility: Music Creation

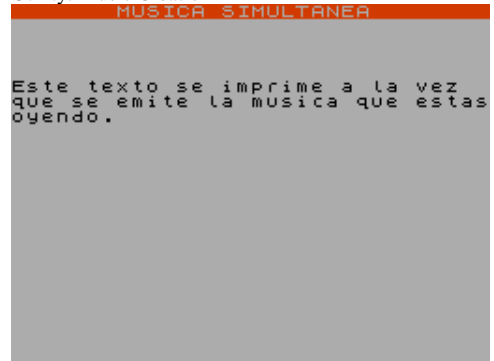

Music Bank 1 (The Jokers,1993)
Scene Demo



Music Bank 4 (Agent-X,1992)
Scene Demo

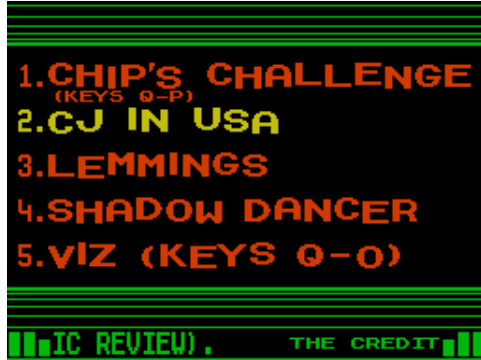

Music-Champ, The (Snoopysoft,1985)
Utility: Music Creation



Music Composer + Music Writer (R.D. Foord Software,1987)
Compilation



Musicfile (.)
Utility: Database

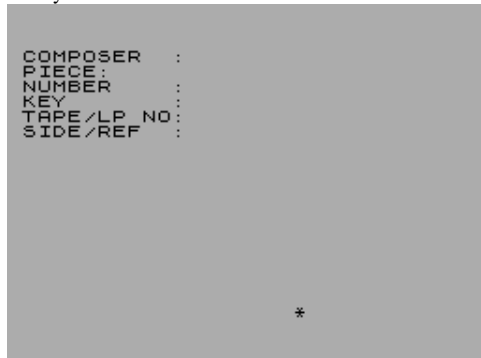

Music Bank 2 (Mat & Muad'Dib,)
Scene Demo

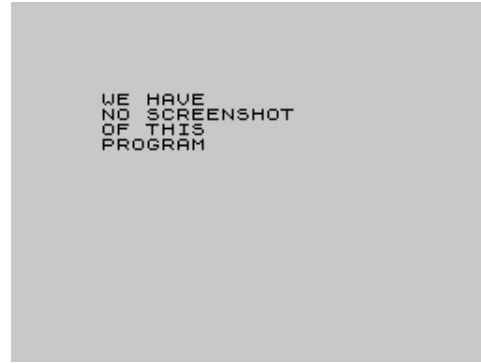

Music Bank 5 (ESI,1992)
Scene Demo

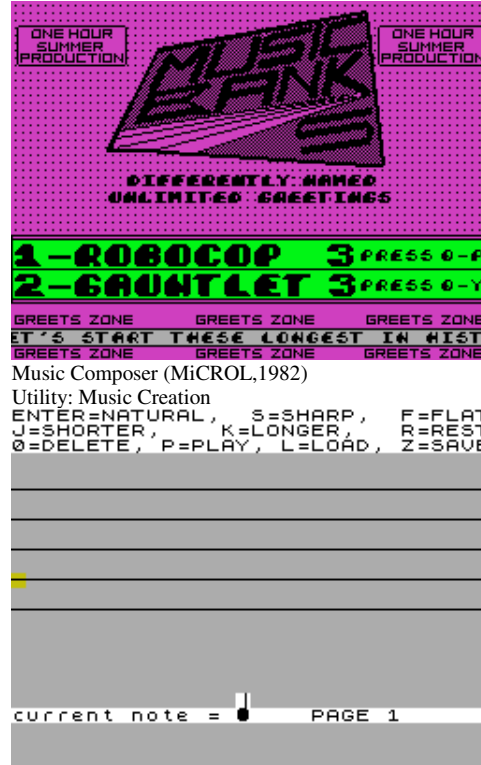

Music-Computer (.)
Utility: Music Creation



Musicfile (Contrast Software,)
Utility: Music Creation



Music Bank 3 (Pentagram,1991)
Scene Demo



Music Box, The (Melbourne House,1986)
Utility: Music Creation

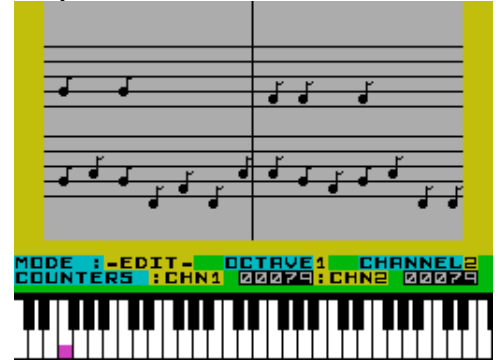

Music Composer (R.D. Foord Software,1988)
Utility: Music Creation



Music Entertainer (.1984)
Utility: Music Creation

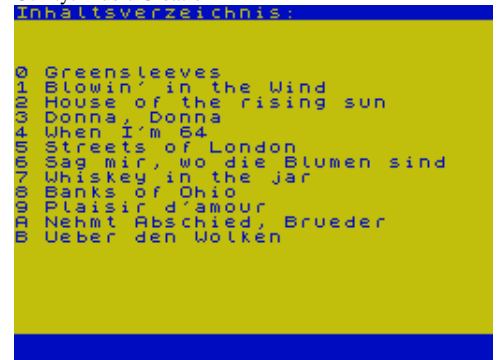

Music Logic (Proxima Software,1990)
Arcade



Music Machine (Ram Electronics Ltd,1986)

Utility: Music Creation



Music Maker (Malan Associates,1984)

Utility: Music Creation



Music Monitor (Space Age Software,1984)

Utility: Music Creation



Music on Interrupts (Spectrum Computing,1985)

Utility: Music Creation



Music Studio (Activision Inc,1985)

Utility: Music Creation



Music Maestro (Torchraven Ltd,1989)

Utility: Music Creation



Music Master (Sinclair Research Ltd,1984)

Utility: Music Creation

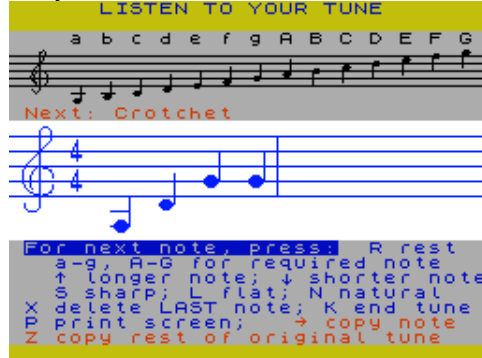

Music Monitor + Star Chess (Space Age Software,1984)

Compilation



Musicroma (Garry Rowland,)

Utility: Music Creation

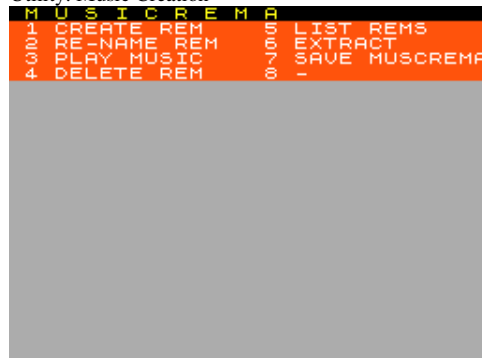

Music Studio, The (MS-CID,1989)

Utility: Music Creation

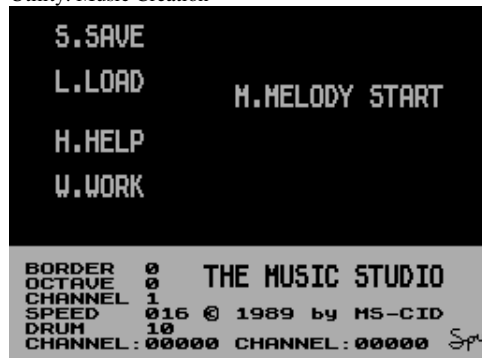

Music Maker (Bellflower Software,1983)

Utility: Music Creation



Music Menu (Tomaz Iskra,)

Music

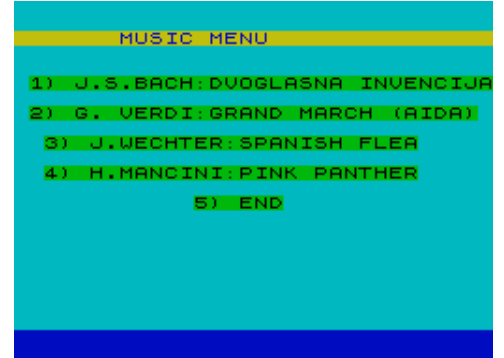

Music on Interrupt (Enlight Party 1996,1996)

Scene Demo



Music Snapshots (Garry Rowland,)

Music



Music Supercode 1 (Softhouse Ltd,1991)

Scene Demo



Music Synth (Your Sinclair,1993)
Utility: Music Creation

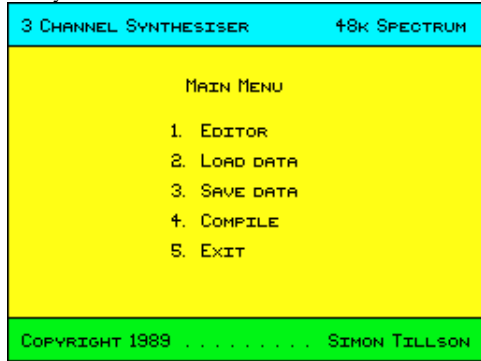

Music Writer (Garry Rowland,1991)
Educational



Muster Fill (Thomas Bertoldo,)
Utility: Screen Manipulation

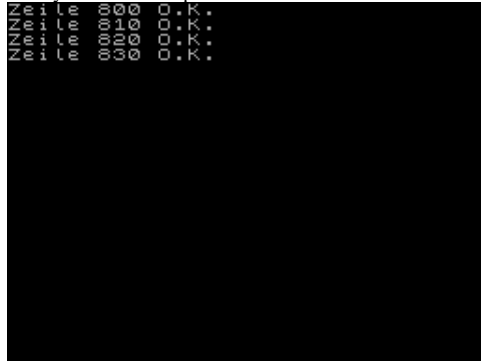

Mutant Arachnid (Sinclair Programs,1984)
Arcade

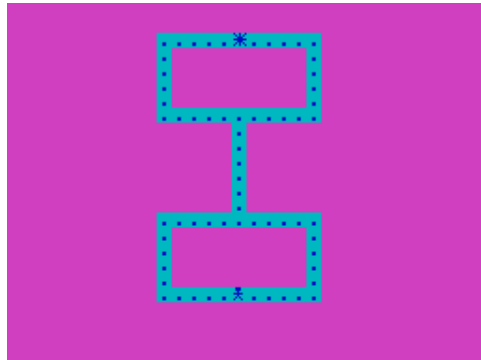

Mutant Monty and the Temple of Doom (Artic Computing Ltd,1986) Arcade



Music Teacher 1&2 (Childsplay Software,1986)
Educational



Music Writer (R.D. Foord Software,1986)
Utility: Music Creation



Mutant (River Software,1987)
Text Adventure

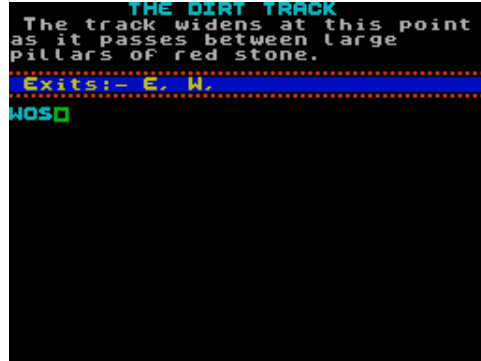

Mutant Fortress (Players Premier Software,1989)
Arcade



Mutants (Ocean Software Ltd,1987)
Strategy

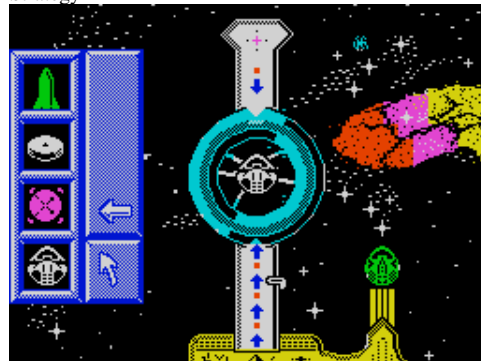

Music Top 10 (Sinclair User,1992)
Scene Demo



Music Writer Data Tape (R.D. Foord Software,1986)
Utility: Music Creation



Mutant Ant Attack (Calisto,1984)
Arcade

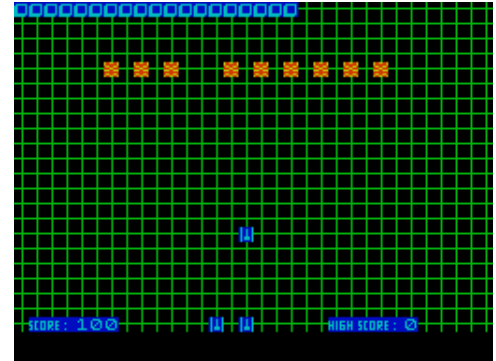

Mutant Monty (Artic Computing Ltd,1984)
Arcade



Mutan Zone (Opera Soft S.A.,1989)
Arcade



Mutations (IJK Software Ltd,1986)
Arcade

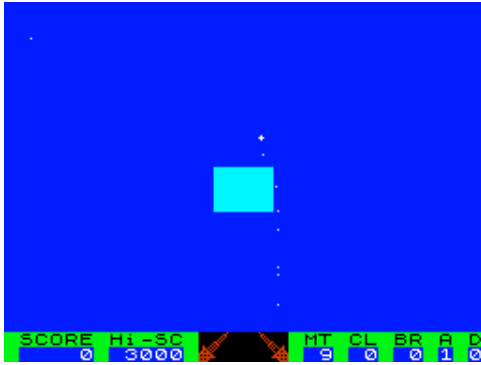

MX Attack (GDP Software,1985)
Arcade



My Name is Uncle Groucho ... You Win a Fat Cigar (Automata UK Ltd,1983) Simulation



Mysterious Fairground (Buffer Micro Ltd,1984)
Text Adventure

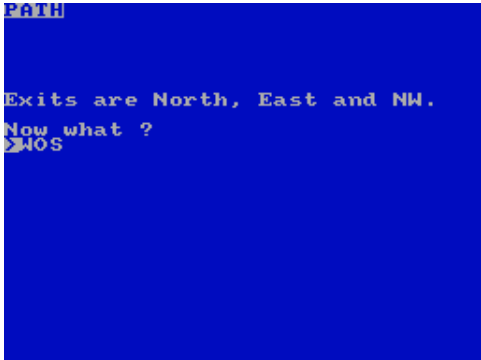

Mystery Manor (Bamby Software,1984)
Arcade Adventure



Mutiny! (Zenobi Software,1996)
Text Adventure

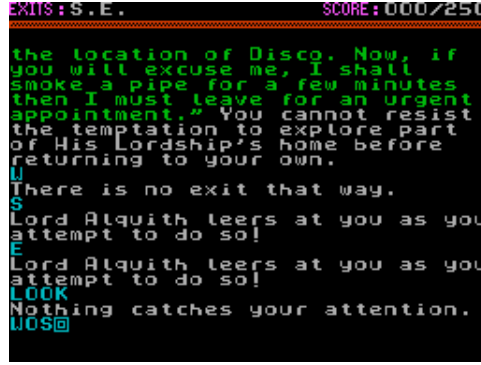

My Copy (Oldsoft,1991)
Utility: Copier

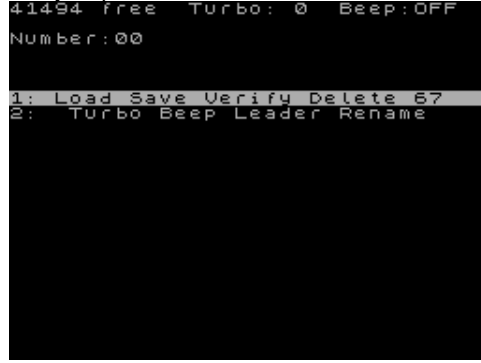

My Secret File (Mosaic Publishing Ltd,1984)
Utility: Database

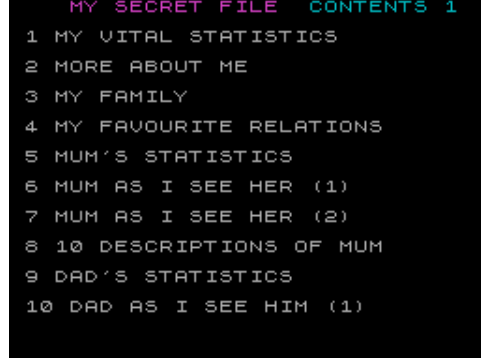

Mystery Forest (Games Machine Ltd.)
Strategy



Mystery of Ancient Castle (Art Studio,1996)
Arcade Adventure



MW Demo (Garry Rowland.)
Scene Demo



Myla Di'Kaich (Global Software,1986)
Arcade

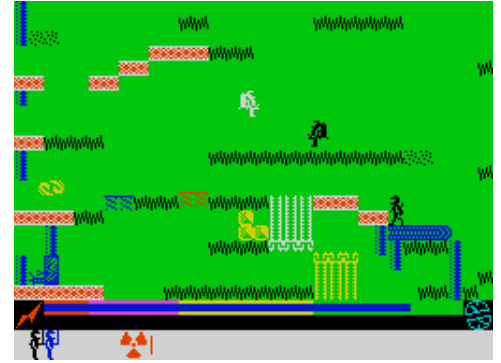

Myself and Us (Keysoft,1987)
Educational



Mystery Fun House (Adventure International,1984)
Text Adventure



Mystery of Arkham Manor, The (Melbourne House,1987)
Arcade Adventure



Mystery of Captain Shelton (Wave,1997)
Text Adventure

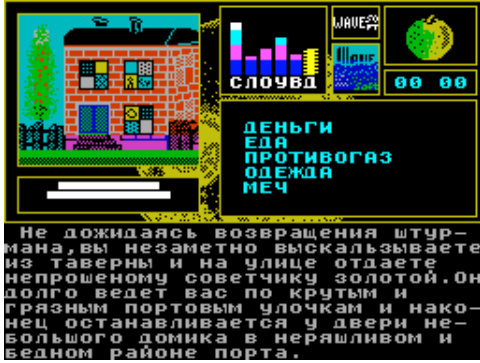

Mystery of Silver Mountain, The (Usborne Publishing Ltd,1984) Text Adventure

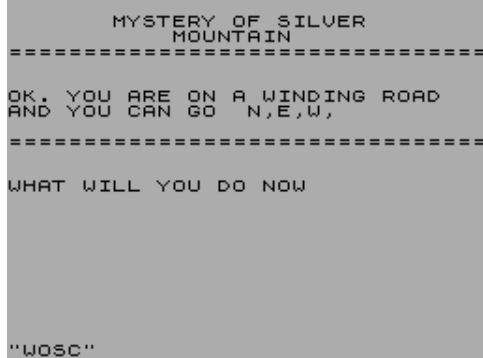

Mystic Tower (Aardvark Software,1983)
Arcade Adventure



Myth: History in the Making (System 3 Software Ltd,1989)
Arcade Adventure



Na Balkanu Nista Novo (Samir Ribic/Zeljko Juric,1989)
Text Adventure

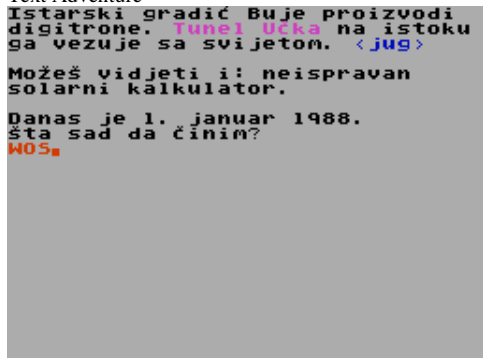

Mystery of Maud Manor, The (Soft 2000,1987)
Text Adventure



Mystery of the Indus Valley (Alternative Software Ltd,1988) Text Adventure



My Story (Faon,)
Scene Demo



My Word! (Papillon Software,1983)
Educational



Naked Aggression (R'n'H Microtec,1990)
Board/Card Game

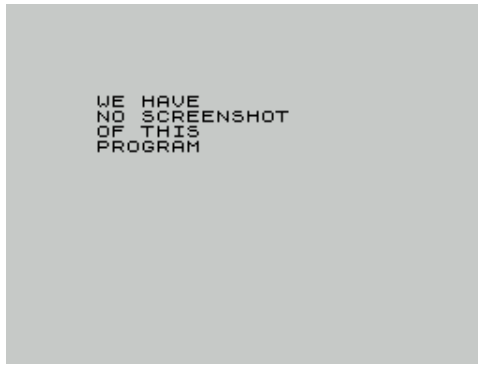

Mystery of Monroe Manor, The (.)
Text Adventure



Mystical (Infogrames,1991)
Arcade

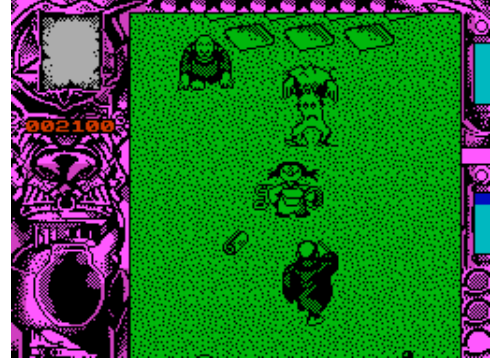

Myth (Rainbird Software Ltd,1989)
Text Adventure



Naanas (Mikro-Gen Ltd,1983)
Arcade



Nameless Demo, The (The Knights,1995)
Scene Demo



Nameless One, The (Adventure Probe Software,1999)
Text Adventure



Nanodrive [2] (MicroHobby,1985)
Utility



Napoleon at War (CCS,1986)
Strategy



Narco Police (Dinamic Software,1991)
Arcade



Nationale Beursspel, Het (MCN Software,1985)
Simulation



Nanako in Classic Japanese Monster Castle (Computer Emuzone,2007) Arcade

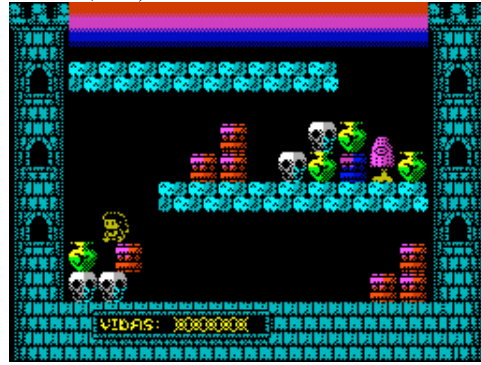

Nano-Up 2.2 (CoMAD Soft,1990)
Utility: Copier



Napoleon's Army (Newsoft Products,1982)
Arcade

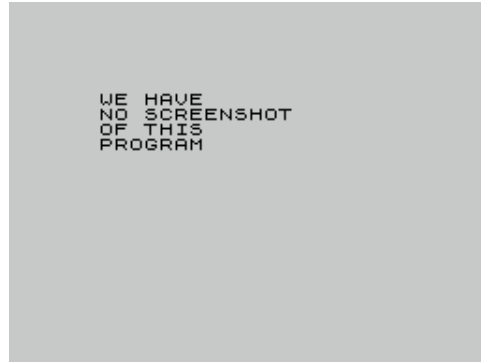

Naslov, 3D (SAM Svoj Majdtor,1984)
Utility: Screen Manipulation



Nationale Smo Ondernemingspel (MCN Software,1985)
Simulation



Nanodrive [1] (MicroHobby,1985)
Utility

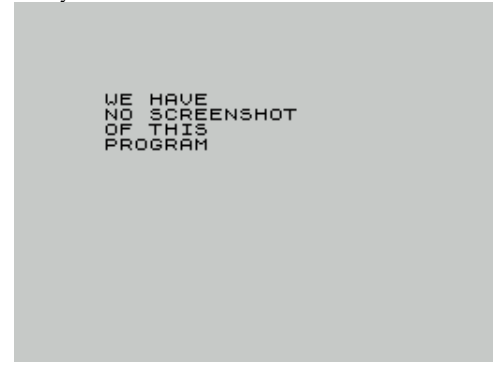

Napoleon (Pw,1985)
Board/Card Game



NARC (Ocean Software Ltd,1990)
Arcade Adventure

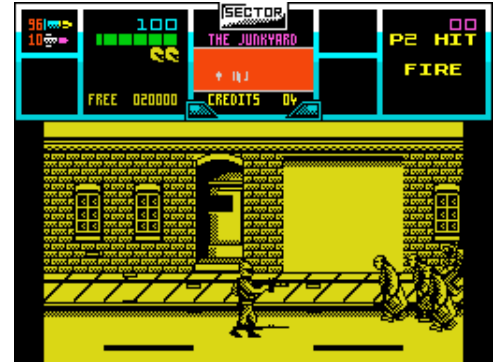

Nasty Invaders (Giltrole Ltd,1982)
Arcade



National Flags (Softhouse Ltd,1990)
Educational



National Hunt Race Ratings (Sport And Racing Software,1984) Utility

ENTER THE WEIGHT IN lbs

st.	lbs	=	lbs.	st.	lbs	=	lbs
10.	0	=	1700	11.	0	=	1800
10.	0	=	1700	11.	4	=	1800
10.	0	=	1700	11.	8	=	1800
10.	4	=	1700	11.	12	=	1800
10.	8	=	1700	11.	16	=	1800
11.	0	=	1700	11.	20	=	1800
11.	4	=	1700	11.	24	=	1800
11.	8	=	1700	11.	28	=	1800
12.	0	=	1700	11.	32	=	1800
12.	4	=	1700	11.	36	=	1800
12.	8	=	1700	11.	40	=	1800
13.	0	=	1700	11.	44	=	1800
13.	4	=	1700	11.	48	=	1800
13.	8	=	1700	11.	52	=	1800
14.	0	=	1700	11.	56	=	1800
14.	4	=	1700	11.	60	=	1800
14.	8	=	1700	11.	64	=	1800
15.	0	=	1700	11.	68	=	1800
15.	4	=	1700	11.	72	=	1800
15.	8	=	1700	11.	76	=	1800
16.	0	=	1700	11.	80	=	1800
16.	4	=	1700	11.	84	=	1800
16.	8	=	1700	11.	88	=	1800
17.	0	=	1700	11.	92	=	1800
17.	4	=	1700	11.	96	=	1800
17.	8	=	1700	11.	100	=	1800

NATO Assault (Astros Productions,1987) Simulation



Nat West Trophy (Byron Software,1985) Sport

Preliminary Round Derby

LANCASHIRE		TOTAL	23-1	WKTS
1	FOULDER	NAT WEST	OVERS	11
2	MENDIS	BOWLERS		
3	JESTY	HOLDING		
4	F/BROTH	FINNEY		
5	WATKINS	FINNEY		
6	HUGHES	FINNEY		
7	HEGG	FINNEY		
8	SIMMONS	FINNEY		
9	HAYHUST	FINNEY		
10	BALLOTT	FINNEY		
11	MATHEWS	FINNEY		
Extras		FALL OF WKTS		
		1st inns		
		RUN RATE		
LANCASHIRE				
DERBYSHIRE				

Nauta (EP Software,) Arcade

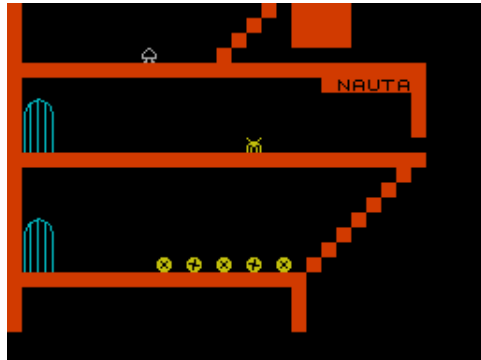

Navex (RYA,1983) Educational

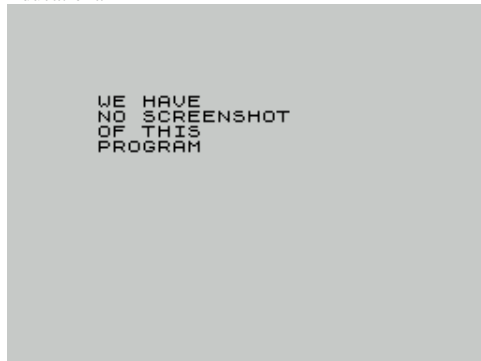

National, The (D&H Games,1988) Simulation



NATO Assault Course (CRL Group PLC,1988) Arcade Adventure



Naughty Crew Info (Naughty Crew,1997) Scene Demo

Obyvatel vašeho počítače právě obsahuje program, jehož cílem je seznámit vás s DEMOMAKERSKÝM týmem Naughty Crew (pro čestnáře nezbedná posádka). Já jsem Johnny X, hlavní koder tohoto mini-programku. Dnes je 30.7. 1997 0:06 a jáme (já a Schiva) v mém rodném městě - TEPLICE. Pokusím se tedy stručně (snad se vejdu do 20 kb... :-)).

Takže: Na začátku to byl Megasoft ve složení ZIP (Schiva)+ Kato (pry neschopný grafik), asi tak v roce 1995. Po čase Schiva zkontaktoval hudebníka - Chrysgona. Ti pak začátkem roku 1997 založili Naughty Crew (dále jen N.C.). N.C. je momentálně v této sestavě: 3-kodéři - Jardasoft, Johnny X a Schiva; 2-crackéři - Matssoft (Ltd.), Schiva; hudebník - Chrysgon.

Já jsem v N.C. asi půl roku, Jardasoft a Matssoft jsou tu nově. Následují informace o jednotlivých členech (ABECEDONĚ).....

'D' - UP; 'A' - DOWN

NAUGHTY CREW

SI ASI NEZNÁTE NĚJAK NO A PŘÁVĚ I

Nautilus (MicroHobby,1986) Arcade



Navidad 84 (MicroHobby,1985) Utility



NATO Alert (CCS,1984) Strategy

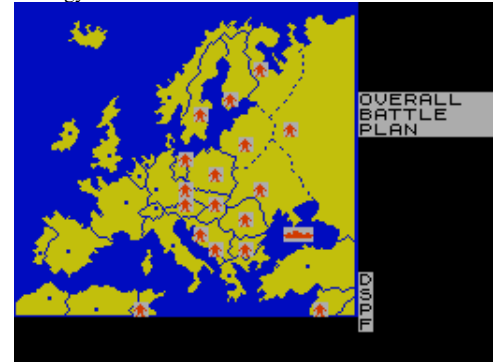

Nature Trail (Coxsoft,1988) Educational

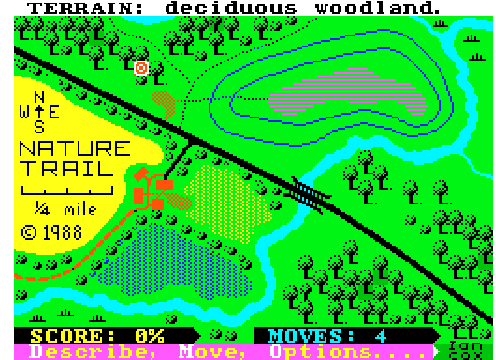

Nauka Jazdy (K. Wysocki,1986) Educational



Nave, La (MicroHobby,1985) Arcade



Navy Moves (Dinamic Software,1989) Arcade Adventure



Navy SEALs (Ocean Software Ltd,1991)
Arcade Adventure



Nebula (Red Shift Ltd,1984)
Strategy

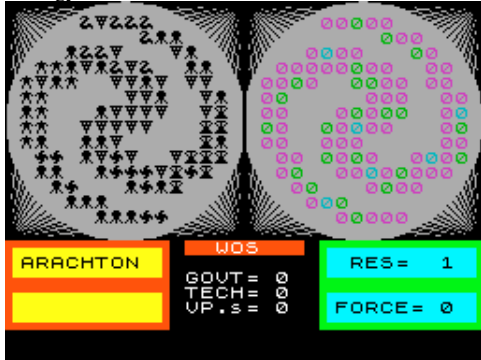

Necris Dome (Code Masters Ltd,1987)
Text Adventure

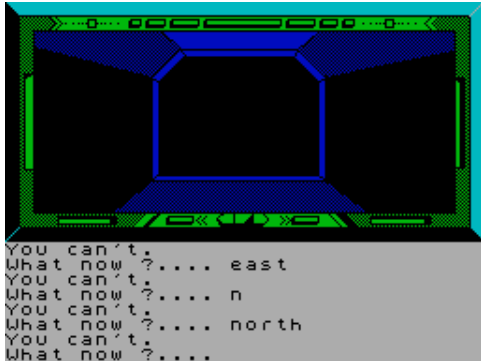

Ned's Garden (16/48 Tape Magazine,1985)
Arcade

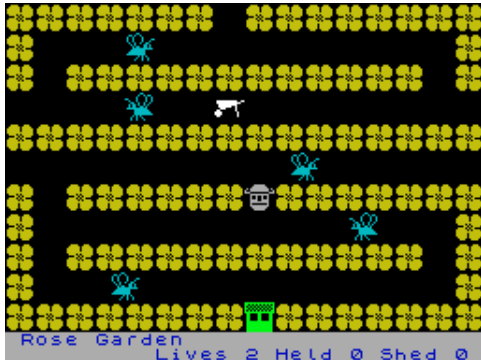

N.E.I.L. Android (Alternative Software Ltd,1988)
Arcade Adventure



Nazi Demo (Marysin/Jack Davis,)
Scene Demo

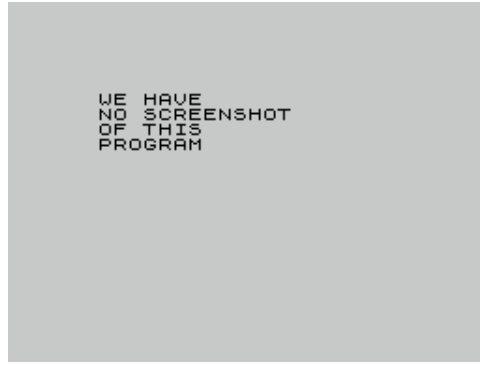

Nebulus (Hewson Consultants Ltd,1987)
Arcade

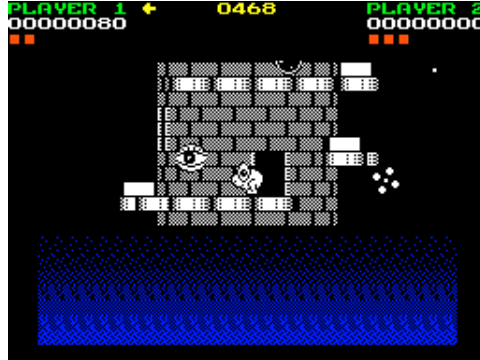

Necronomycon, The (Oblique Strategy.)
Text Adventure

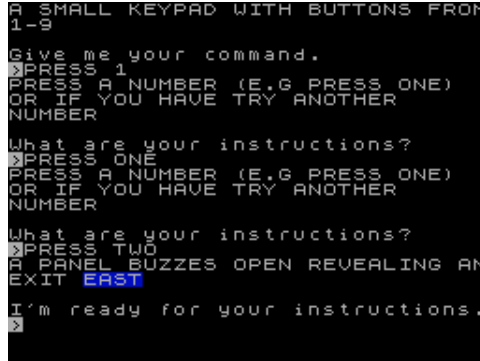

Negy a Nyero (Laszlo Nyitrai,1998)
Board/Card Game

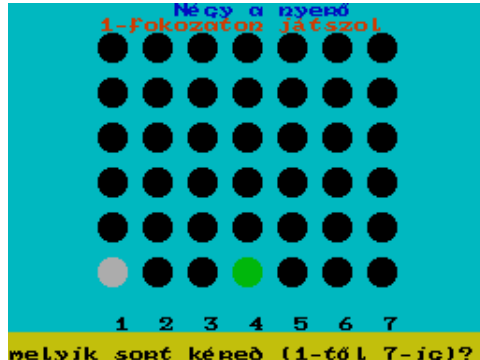

Nemcina 1 (VD Program,1988)
Educational



Nazwa Dnia (Janusz Gajewicz,1985)
Educational



Necks Please... (Automata UK Ltd,1985)
Arcade



Necro Plasm (Grant Jaquest,1989)
Arcade

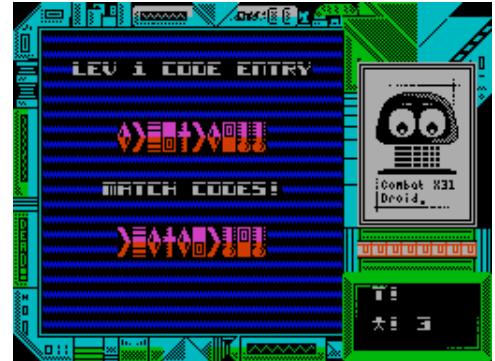

Neighbours (Impulze,1992)
Arcade



Nemesis (Konami Ltd,1987)
Arcade



Nemesis the Warlock (Martech Games Ltd,1987)
Arcade



Neolite Wordbase Catalogue Manager (Softhouse Ltd,1995)
Utility: Database

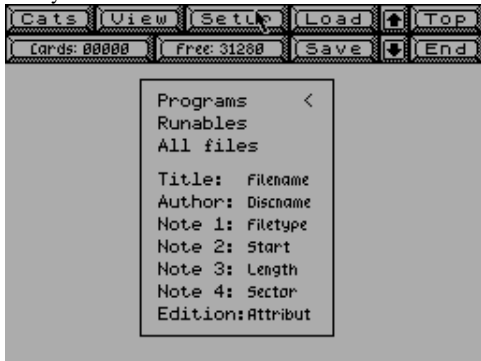

Nessie (Virgin Books,1983)
Arcade



Nether Earth Editor (V.O.software,1996)
Arcade Game Development Tool



Network (Faceoff Association,1999)
Board/Card Game

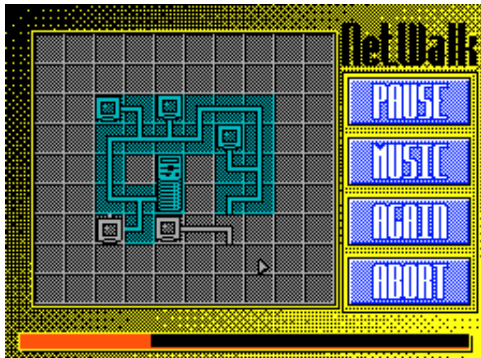

Nemo's Island (Walrus Computing,)
Text Adventure

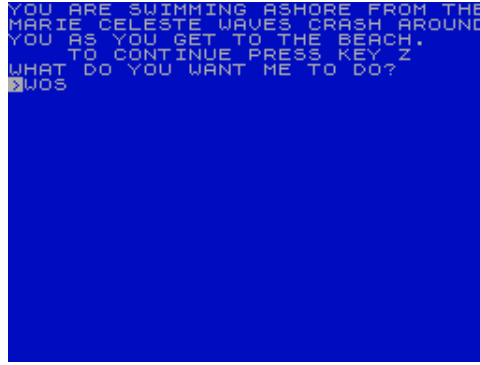

Neptune's Caverns (Watts Franklin,1985)
Text Adventure

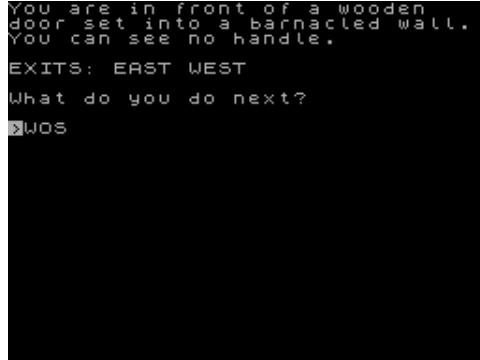

Nest of Bastards, The (Greg Fox,1991)
Arcade

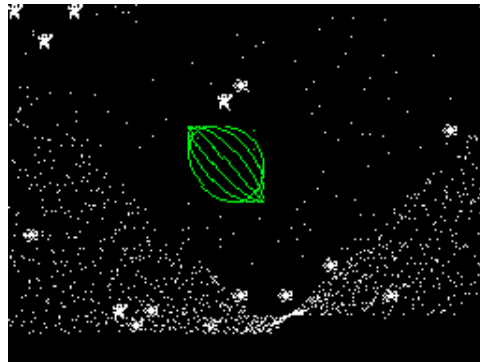

Nether Poppleton Treasure Hunt, The (Adventure Probe Software,2001) Text Adventure



Network (Style Group.)
Arcade

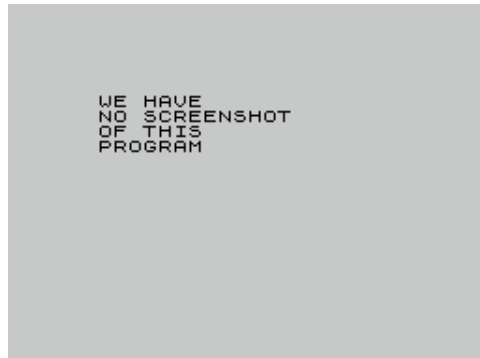

Neolite Wordbase 1.1 (Softhouse Ltd,1994)
Utility: Database

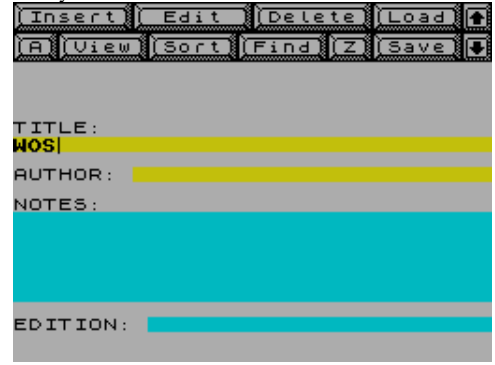

Nervos This Position (Hektic Software,1986)
Arcade

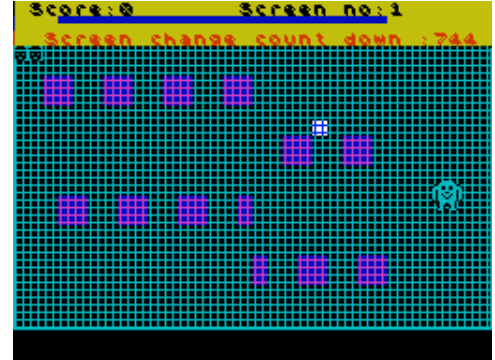

Nether Earth (Argus Press Software Ltd,1987)
Arcade



Netherworld (Hewson Consultants Ltd,1988)
Arcade

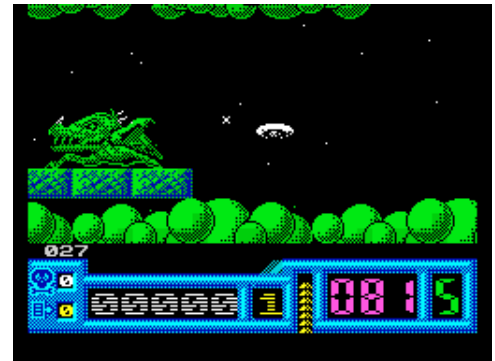

Network (Your Sinclair,1987)
Board/Card Game

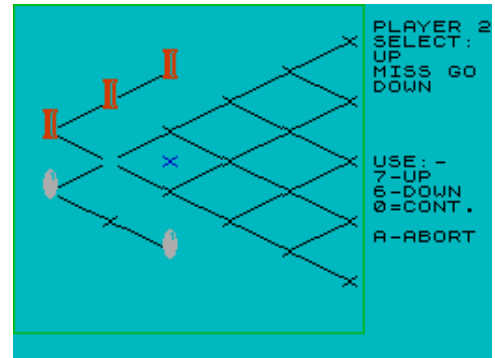

Network Analyser (Number One Systems,1983)

Utility: Electronics

```

PRESS (ENTER) TO EXIT WITHOUT
CHANGING P
ENTER DATA IN  FORMAT SHOWN;
R, C, L      :A, B, VALUE
F (FET)      :G, D, S, GM(A/V)
Q (BIPOLAR TR.):B,C,E,hfe,IC(mA)
A (OP.AMP)   :+IN, -IN, O/P
T (TRANSFORMER):A, B, C, D,RATIO
P (PORTS)    :I/P, O/P, GND

COMPONENT NAME ;
C

```

Neuron Warriors (A-Soft [1],1992)

Arcade

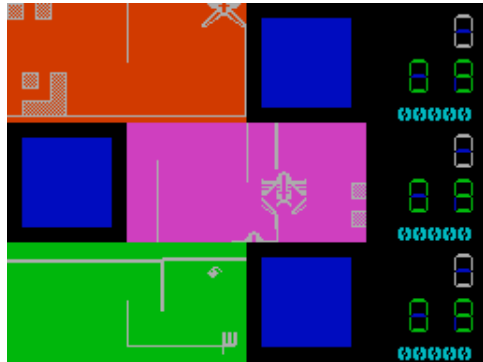

Never Go with Strangers (Theftord Crime Prevention Panel,1987) Educational



New Angles (Sinclair User,1992)

Utility: Screen Manipulation



New Community, The (Scetlander,1988)

Educational



Network Exeter (Dee-Kay Systems.)

Simulation

```

12:20:09 NEXT SIGNAL CL
MP 0.1 GRAD. LEVEL
LINE SPEED 30 MPH
NEXT LINE SPEED: 60MPH AT MP1

EXETER ST. DAVID'S STATION
DISTANCE TO SALISBURY 88M

COMMENTS
NEXT STOP EXETER CENTRAL
RIGHT AWAY.DEPART WHEN READY.

*****
33001 MAX SPEED 85
*****

SPEED :0 MPH CONT :0
AWS :CLEAR BRAKES: 2
STATUS INDICS:ENGINE IDLING

```

Neverending Story II, The (Linell Software,1990)

Arcade Adventure

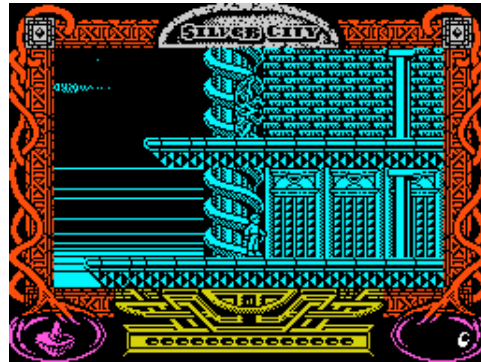

Nevermind (The Unbelievables,1995)

Scene Demo



New Birkdale (Hornby Software,1984)

Sport

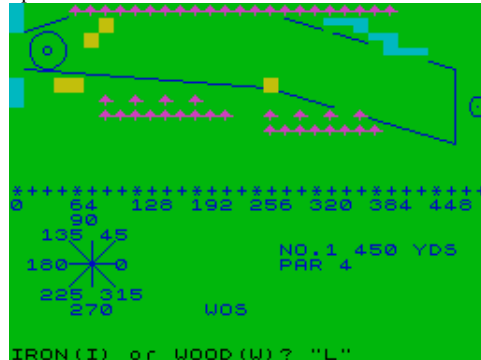

New Cylon Attack (A'nF Software,1984)

Arcade



Network Waterloo (Dee-Kay Systems.)

Simulation

```

10:12:02 NEXT SIGNAL CL
MP 0 GRAD. LEVEL
LINE SPEED 20 MPH
NEXT LINE SPEED: 60MPH AT MP0.1

SALISBURY STATION
DISTANCE TO WATERLOO 83M

COMMENTS
DUE TO DEPART 10.14
STARTING SIGNAL NOT SET

*****
50001 MAX SPEED 100
*****

SPEED :0 MPH CONT :0
AWS :WARNING BRAKES: 2
STATUS INDICS:ENGINE IDLING

Dreadnought

```

Neverending Story, The (Ocean Software Ltd,1985)

Text Adventure

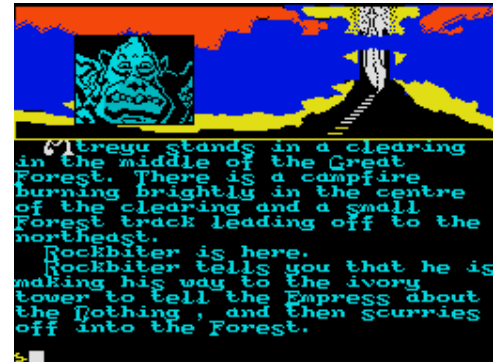

Never Trust a Blonde (Add-On Electronics Ltd,1983)

Text Adventure

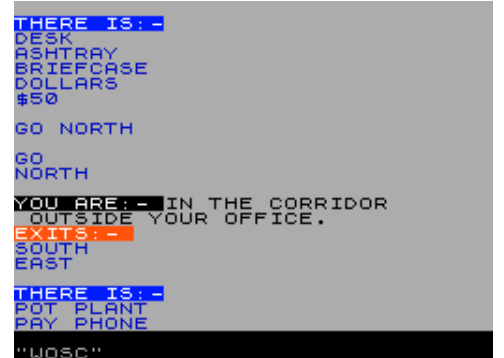

Newcastle Upon Tyne Powerbox (Ashley Greenup,1991)

Simulation

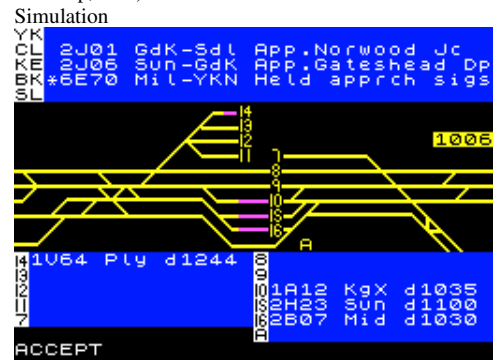

New Dizzy (N. Kutin/D. Paltusov,1993)

Arcade Adventure

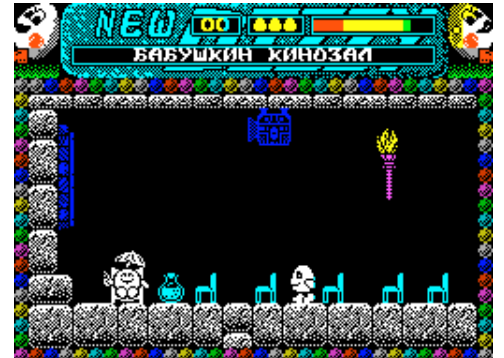

New Format Copy (Tadeusz Wilczek,1984)

Utility: Copier



Newsdesk 1 (Venturesoft,1993)

Compilation



New-Supercode (J. Gajdecki Software,1986)

Utility



New Venture (Falcon Computing,1984)

Simulation



New Year's Special (Hacker Chris,1989)

Scene Demo



New Frogger + Specman (C-Tech,1982)

Compilation

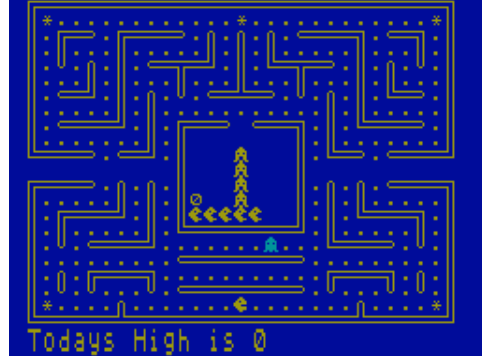

Newsdesk 2 + What Now 4 (Venturesoft,1994)

Compilation



Newterm (Microsource NL,1986)

Utility

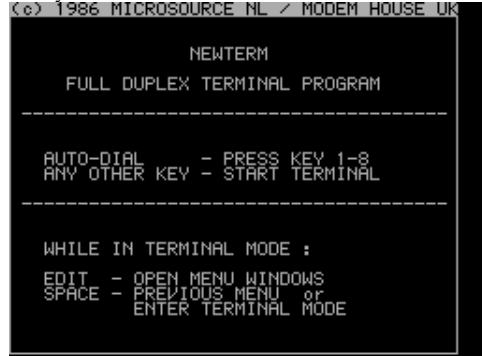

New Wheels John? (Automata UK Ltd,1985)

Simulation

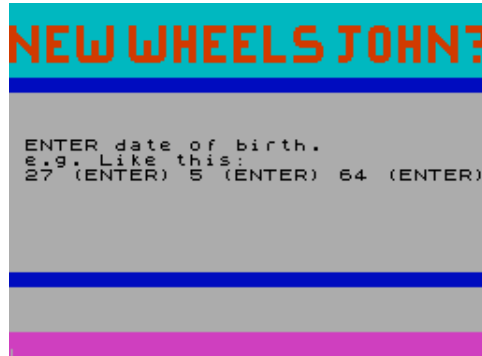

New York Music Review, The (The Jokers,1990)

Scene Demo



New POKE Magazin 6 (ZB,1985)

Cheat

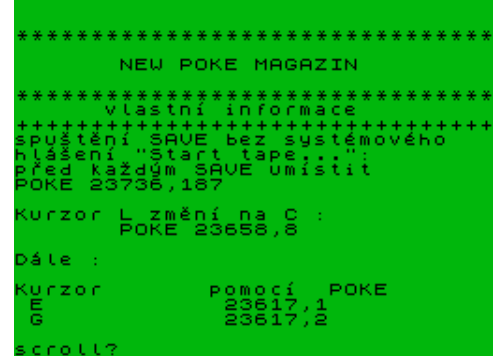

News of The World (Ptushka,1995)

Board/Card Game



New Testament Background (BIBLEchip,1985)

Educational

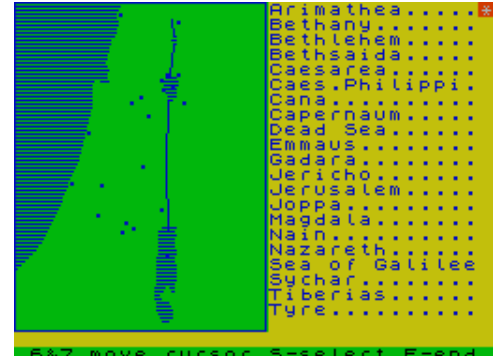

New Year 1985 (Samir Ribic,1984)

Arcade



New York Warriors (Virgin Games Ltd,1990)

Arcade

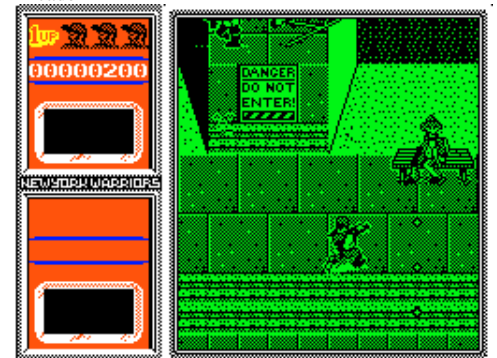

New Zealand Story, The (Ocean Software Ltd,1989)
Arcade

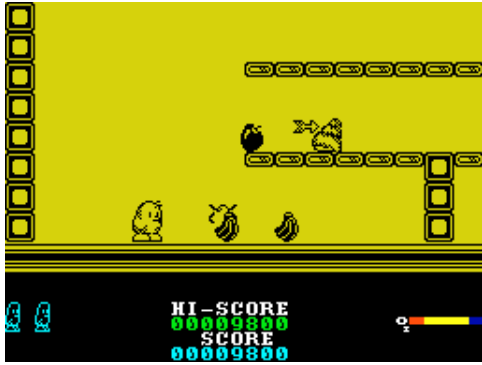

N.E.X.U.S. (Nexus Productions Ltd,1986)
Arcade



Nick Faldo Plays the Open (Mind Games,1985)
Sport



Nifty Fifty (Visions Software Factory,1984)
Arcade



Nightboat (Karl Crawford,1986)
Text Adventure



N.E.X.O.R. (Design Design Software,1986)
Arcade

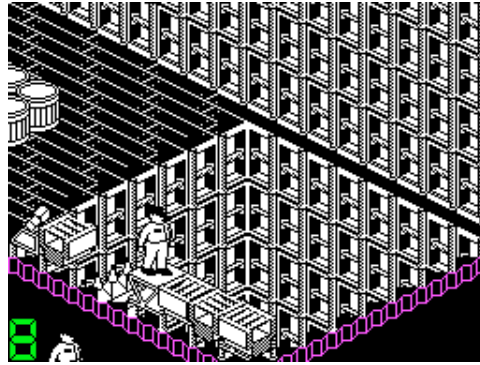

Nibble Dreams (Tankard/Hammer/Kamikaze,)
Scene Demo

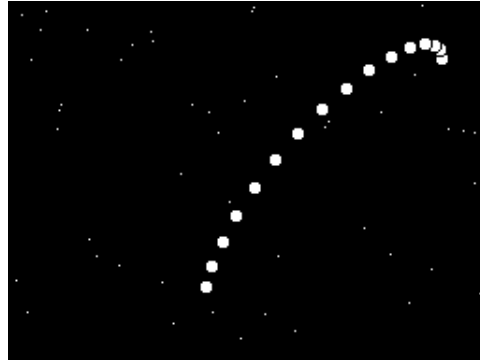

Nick Tracy (3P Soft/Beja Soft,)
Text Adventure



Nigel Mansell's Grand Prix (Martech Games Ltd,1988)
Sport



Night Bomber (Krypton Force,1984)
Arcade



Next War (Assassin Software,1984)
Strategy

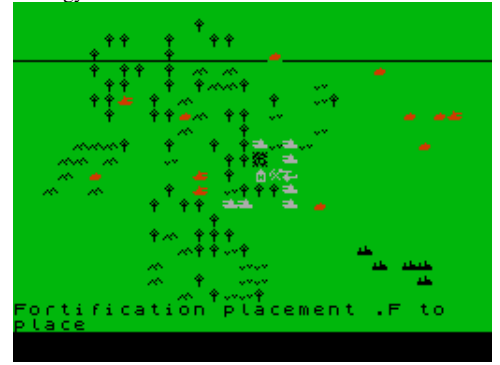

Nice Dog (John Dalthon,1990)
Scene Demo



Nicotine Nightmare (Atlantis Software Ltd,1985)
Simulation

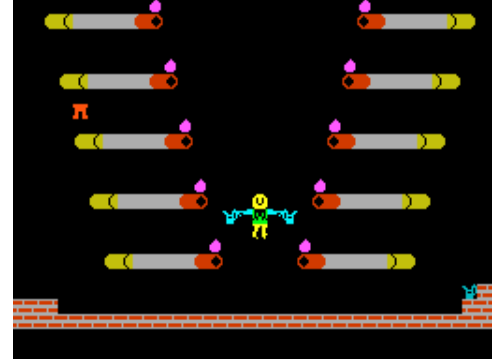

Nigel Mansell's World Championship (Gremlin Graphics Software Ltd,1993)
Sport

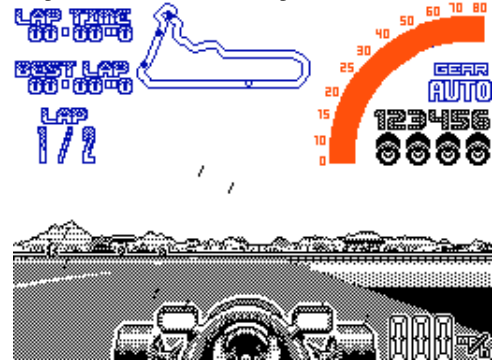

Night Breed (Ocean Software Ltd,1990)
Arcade



Night Fighter (Precision Software Engineering,1983)
Arcade

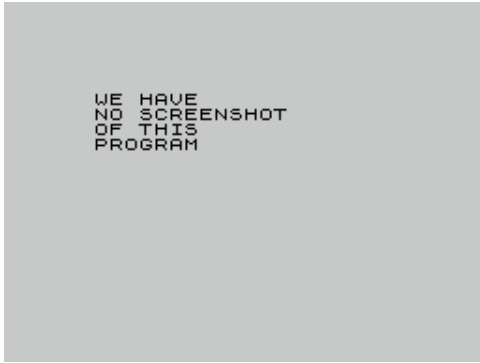

Night Gunner (Digital Integration,1983)
Simulation



Night Landing (Andromeda Inc,1984)
Simulation

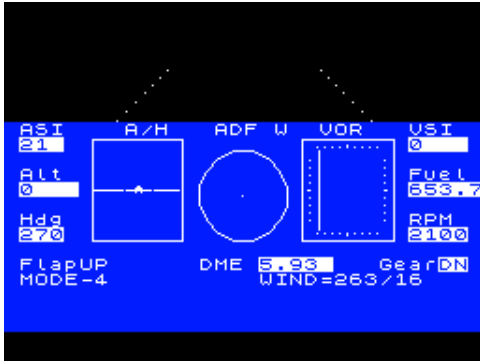

Nightmare (The Guild,1986)
Text Adventure

```
I am in the Lounge.Its large and
very dusty...Spiders climb down
and crawl all over you. UGH !!!
The Dining room is to the East.

I can also see:-
A green umbrella
A television set.

Now what ?
>NOS
```

Nightmare on Robinson Street, A (Your Sinclair,1990)
Arcade



Nightflite (Hewson Consultants Ltd,1982)
Simulation

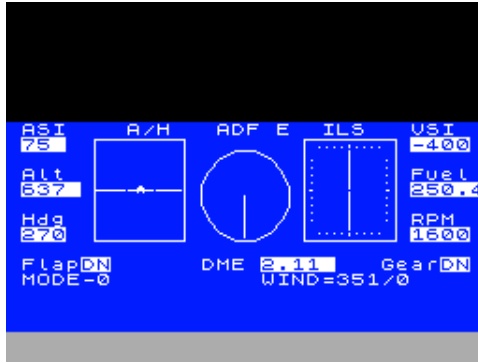

Night Gunner (E. Reittmann,1984)
Simulation

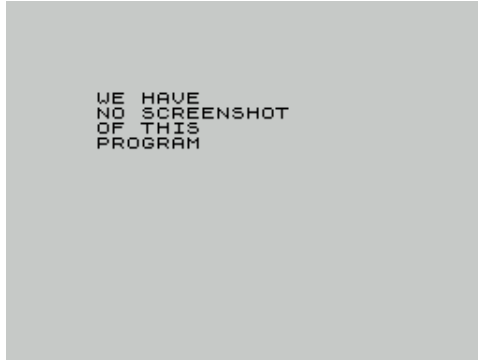

Nightmare (K'Soft Ltd,1986)
Arcade



Nightmare! (William Quinn,1992)
Text Adventure

```
stumbling out of bed, you
discover that something is
wrong... Your room is TIDY...

TYPE:QUEST
Dream on... w
That cannot be done.
Dream on... e

You go East. As you stumble
through the door you tread on
your skateboards and fly down
the stairs. You stand up dazed.
You are standing at the foot
of the now innocent looking
stairs (well, I know it was the
skateboards fault, but it was
the stairs that actually beat
you up). Hiding underneath is
the coat rack. Exits are S,E,W.
You can see a stick of blood-
tack
Dream on...
```

Nightmare Park (Breadhill,1982)
Arcade



Nightflite II (Hewson Consultants Ltd,1983)
Simulation



Night Hunter (Ubi Soft Ltd,1990)
Arcade Adventure

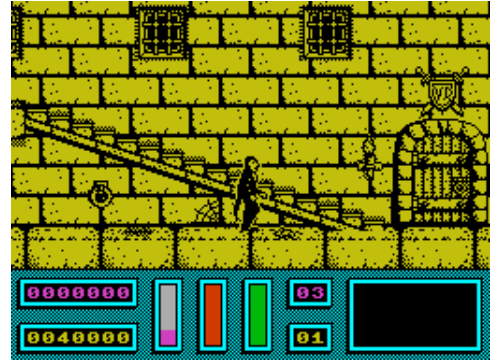

Nightmare (Southway Software,1986)
Text Adventure



Nightmare + Potholer (Southway Software,1986)
Compilation



Nightmare Rally (Ocean Software Ltd,1986)
Arcade

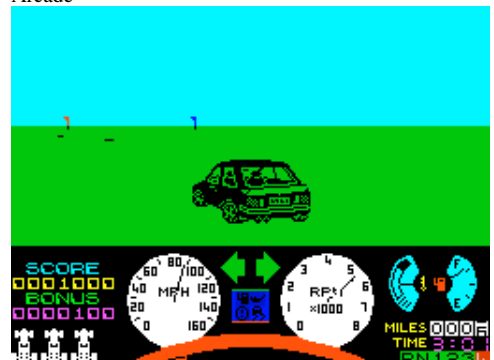

Night of the Aliens, The (.)
Text Adventure

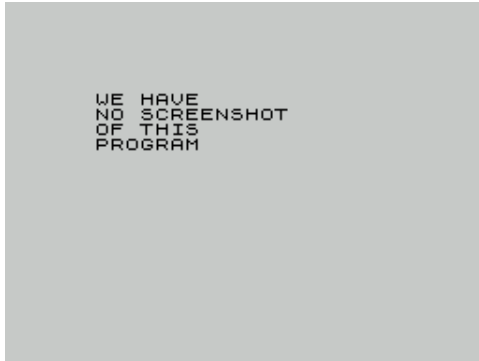

Night Raider (Gremlin Graphics Software Ltd,1988)
Arcade

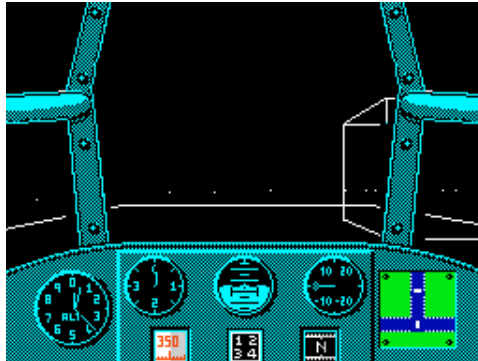

Night Raiders (Machineroft,1982)
Arcade



Nightshade (Ultimate Play The Game,1985)
Arcade



Night Shift (US Gold Ltd,1991)
Arcade

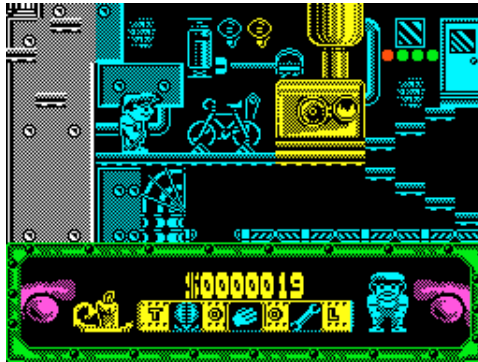

Night Sky, The (Bridge Software,1983)
Educational



Night Stalker (Thor Computer Software,1984)
Arcade

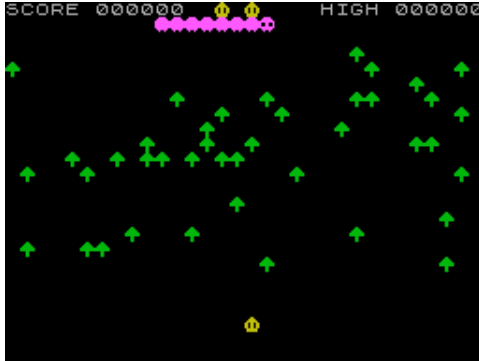

Night Walker (Compass Software,.)
Text Adventure



Nightwing (Softel Software,1989)
Text Adventure

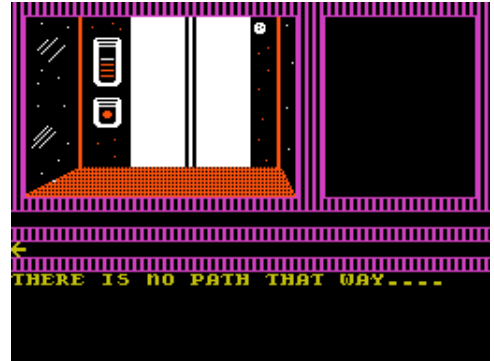

Nightwing + Solaris (Softel Software,1989)
Compilation

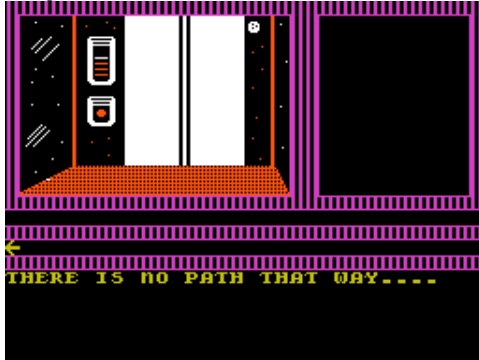

Nihilist (Electric Dreams Software,1987)
Arcade

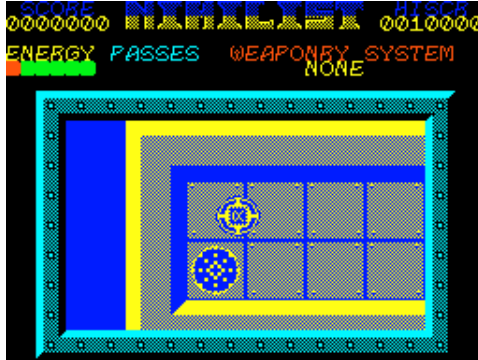

NIM (MicroHobby,1985)
Board/Card Game



Nim (Sinclair Research Ltd,1982)
Arcade

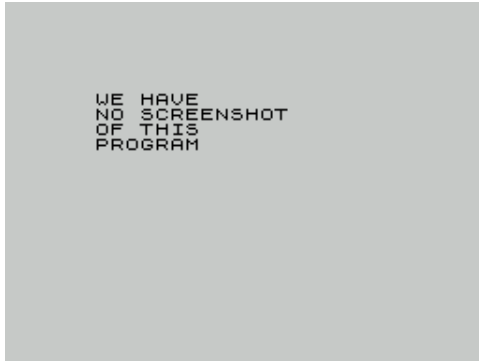

Nimm (.)
Board/Card Game

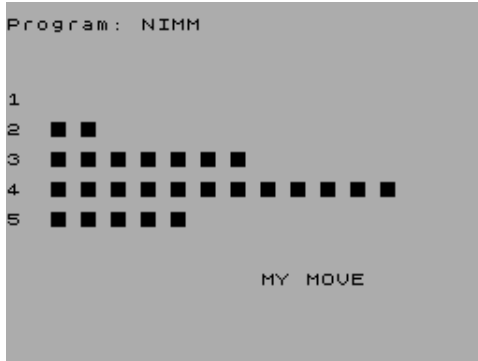

Nine Currant Buns (Arrow,1985)
Educational



Nine Hole Golf (Granada Publishing,1983)
Arcade



which club (1 to 8)WOSL
Ninja (Entertainment USA,1987)
Arcade Adventure



Ninja Hamster (CRL Group PLC,1987)
Arcade



Ninja Scooter Simulator (Silverbird Software Ltd,1988)
Arcade



Niszny Novgorod (Profsoft,1993)
Scene Demo



Nines (16/48 Tape Magazine,1986)
Board/Card Game

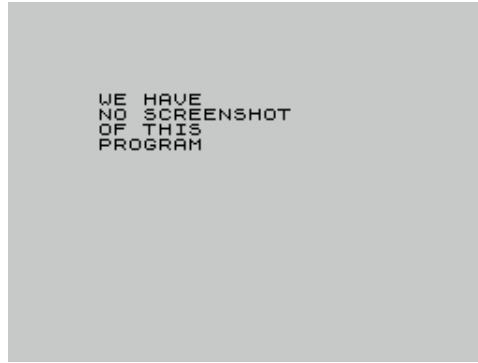

Ninja Collection (Ocean Software Ltd,1992)
Compilation

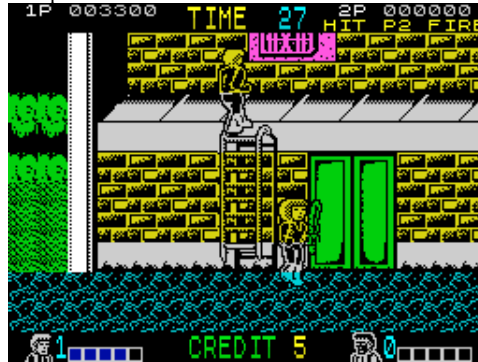

Ninja Massacre (Code Masters Ltd,1989)
Arcade

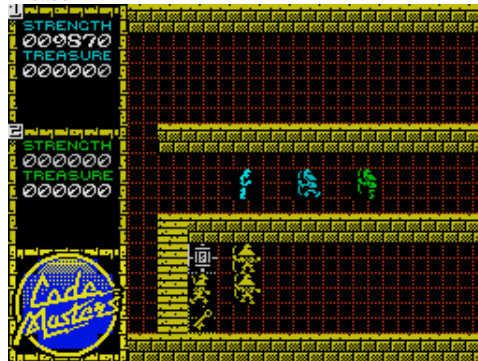

Ninja Spirit (Activision Inc,1990)
Arcade

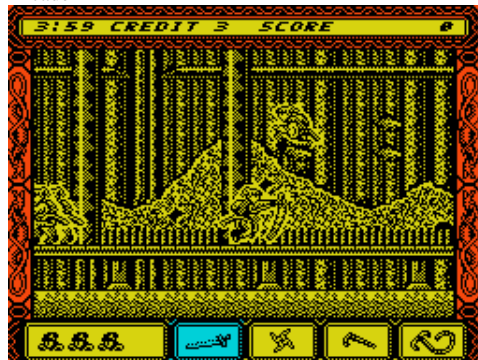

Nite-life (The United Minds,1995)
Scene Demo



Nineteenth Century England (Sussex Software,1984)
Educational



Ninja Commando (Zeppelin Games Ltd,1989)
Arcade

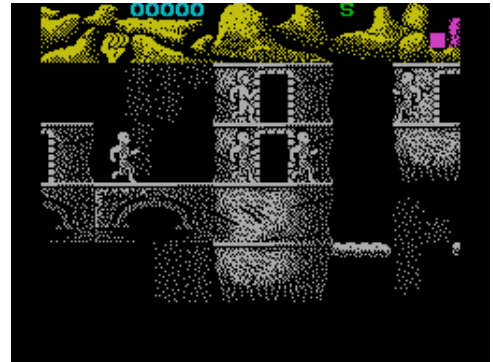

Ninja Master (Firebird Software Ltd,1986)
Arcade



Ninja Warriors, The (Virgin Games Ltd,1989)
Arcade

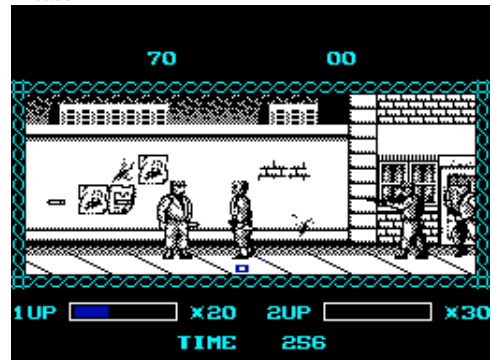

Nitro Joe (Computer Kontakt,1985)
Arcade



Nnnudger (DGF Software,1985)
Simulation



Noah (Lotus-Soft,1984)
Text Adventure

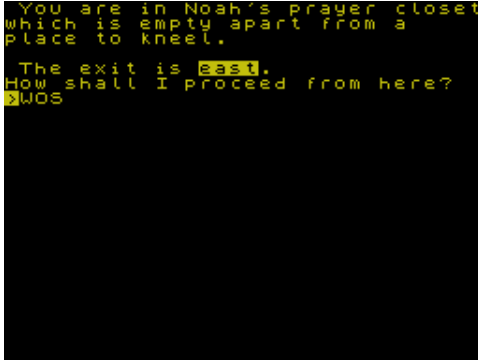

Nodes of Yesod (Odin Computer Graphics Ltd,1985)
Arcade



N.O.M.A.D. (Ocean Software Ltd,1986)
Arcade

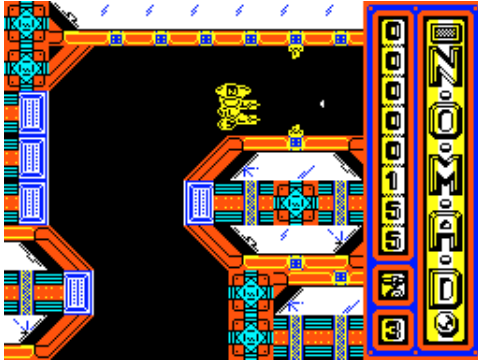

No More Intelligence 2 (Dynamite Dynasty,1993)
Scene Demo



No 1 (Bug-Byte Software Ltd,1985)
Arcade

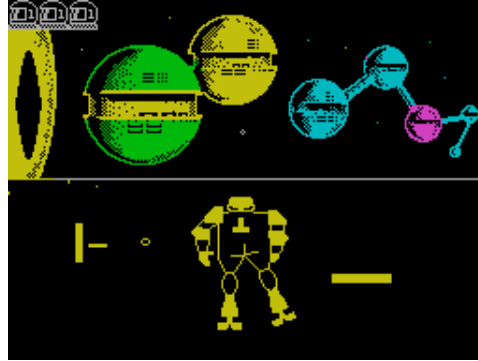

No Break (Flemming R. Pedersen,1986)
Utility: BASIC Related

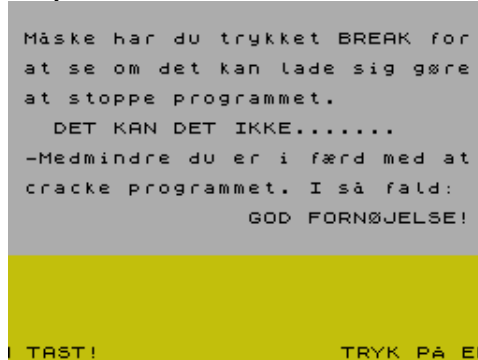

No Insight View (The Lords,)
Scene Demo

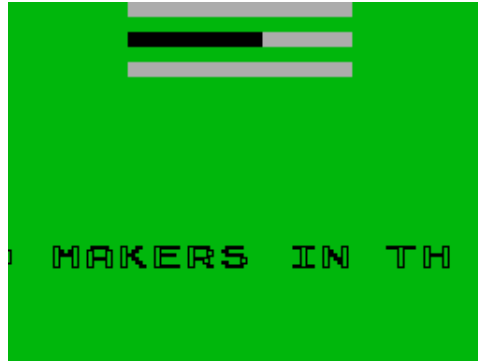

Noma della Rosa, Il (Perpetum,1993)
Arcade Adventure

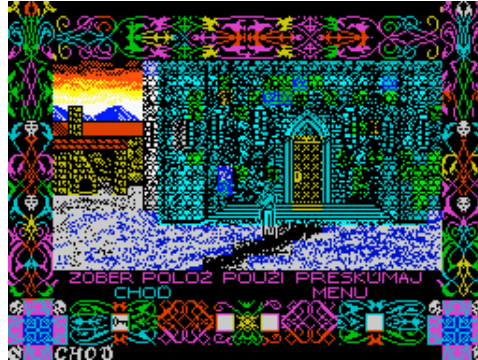

No More Intelligence 3: No Panic (Dynamite Dynasty,1991)
Scene Demo



Noah (ESP Software,1984)
Arcade Adventure



Noche Agitada (Trilog Software,1989)
Arcade Adventure



No Limits (US Gold Ltd.)
Compilation



Nominas (Investronica S.A.,1984)
Utility

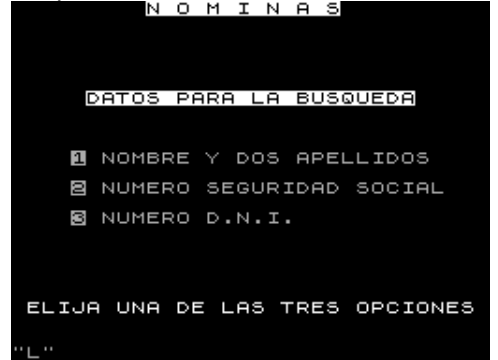

Nonamed (Dinamic Software,1987)
Arcade



No Nazis (The Mad Guys,1993)
Scene Demo



No Nonsense (The United Minds,1995)
Scene Demo



Nope Here's Another One (Zenobi Software,1993)
Compilation



North American Indians (Calpac Educational Software,1983)
Educational

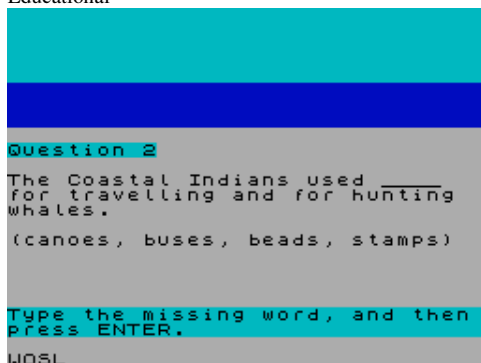

North Wales 47 Fleet Manager (Ashley Greenup,)
Simulation



Non Compos Mentis (Your Sinclair,1991)
Board/Card Game

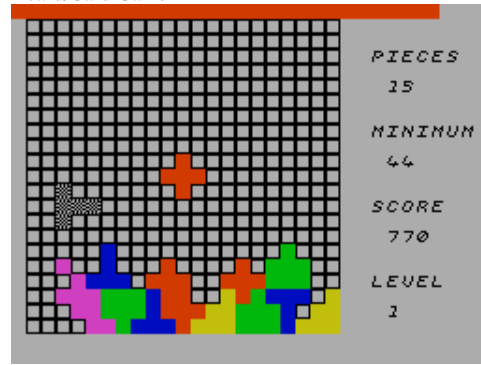

Nontarraqueous (Mastertronic Ltd,1985)
Arcade

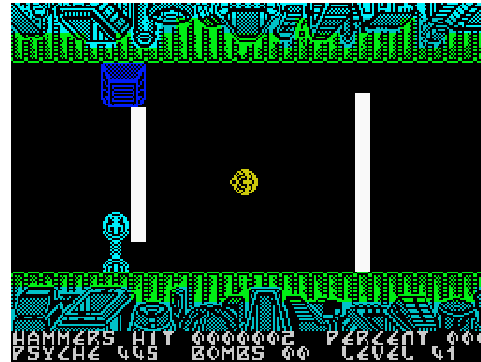

Norman (The Power House,1988)
Arcade

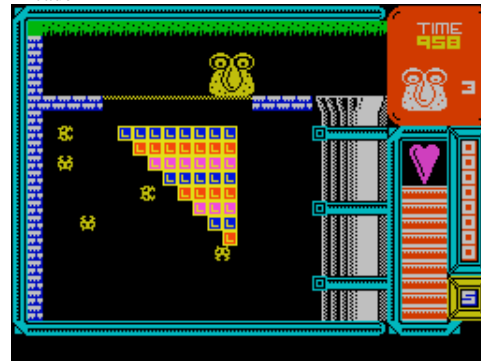

North & South (Infogrames,1991)
Strategy

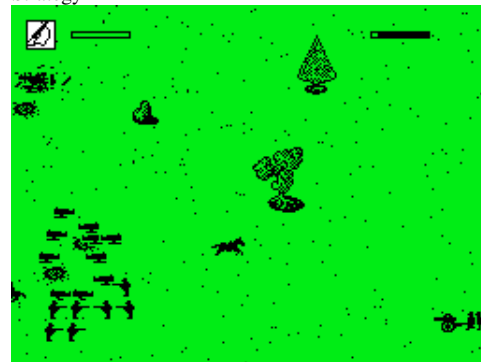

Norton Commander, The (Bill Gilbert,1989)
Scene Demo

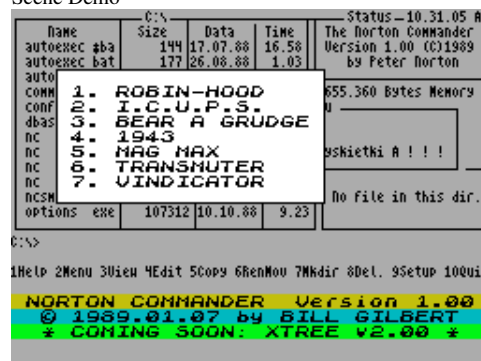

Non Compos Mentis 2: Pleasure Beyond Pain (Your Sinclair,1991)
Board/Card Game

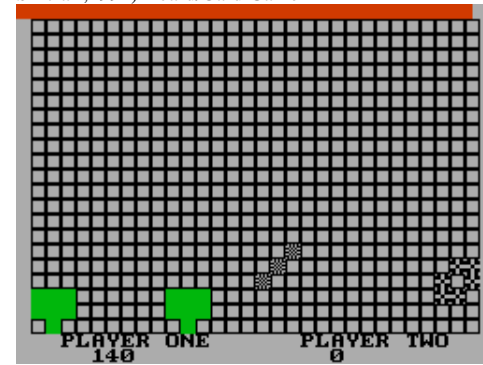

Nop Demo (NOP,)
Scene Demo



Norman's Lament (Zenobi Software,1990)
Text Adventure

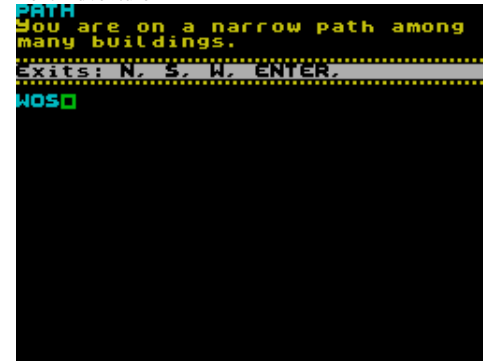

North Star (Gremlin Graphics Software Ltd,1988)
Arcade

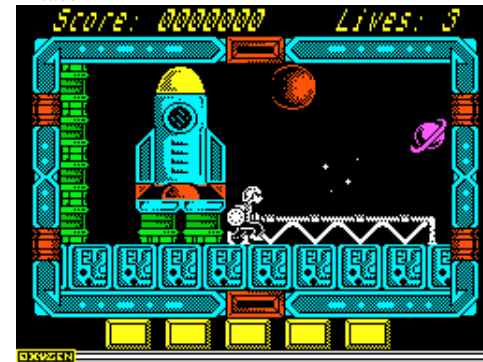

Nosferatu: Quest for the Vampire (Omni Software,1984)
Text Adventure

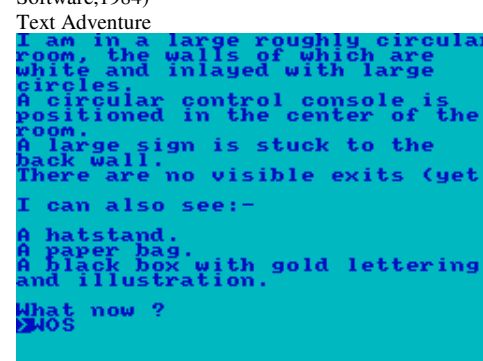

Nosferatu the Vampyre (Piranha,1986)
Arcade Adventure



Not Another Big Disk (Zenobi Software,1992)
Compilation



Not Dead Demo (Datasoft,1994)
Scene Demo



Notepad (Christian Grecu,2004)
Utility

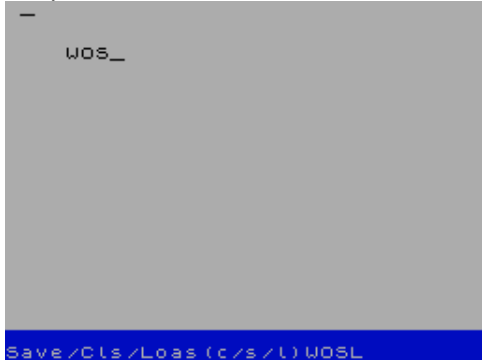

Not Lords of Midnight (.)
Text Adventure



No Siempre Sera Asi (Individual Software Service/Hueber Software,) Educational



Not a Penny More, Not a Penny Less (Domark Ltd,1987)
Text Adventure



Note Invaders (Chalksoft Ltd,1983)
Educational

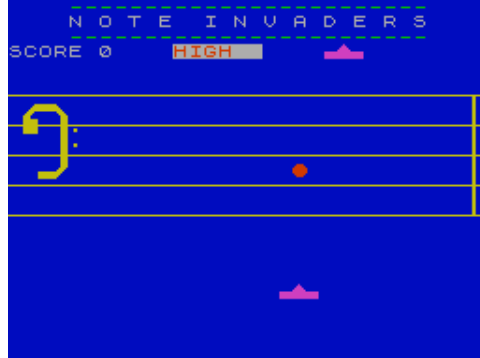

Not For Children (Tiger's Claw,1996)
Scene Demo



Notorik (Ultrasoft,1992)
Arcade Adventure



Not Another Big Desk (.)
Text Adventure



Not a Research Lab in Cambridge (Spectrum Computing,1985)
Demo



Notemaker (Sinclair User,1983)
Utility: Music Creation

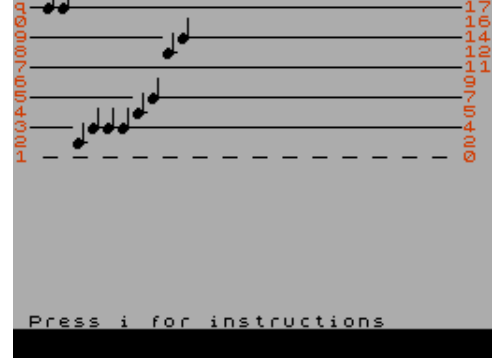

Notlandung (Gerold Schneider,1985)
Text Adventure

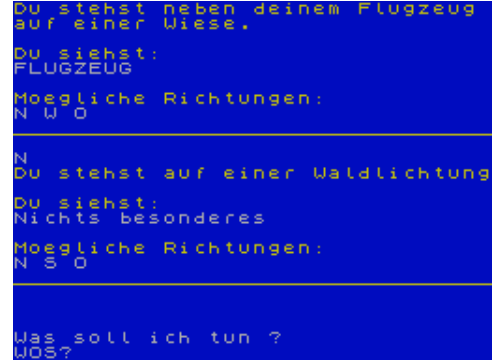

Not the Lord of the Rings (Psychaedelic Hedgehog Software,1991) Text Adventure



Noughts and Crosses (Granada Publishing,1983)
Board/Card Game

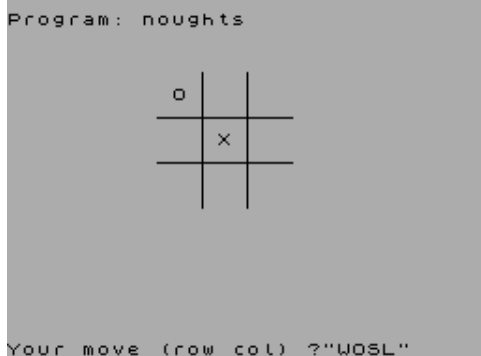

Noughts and Crosses, 3D (Machinecrot,1982)
Board/Card Game

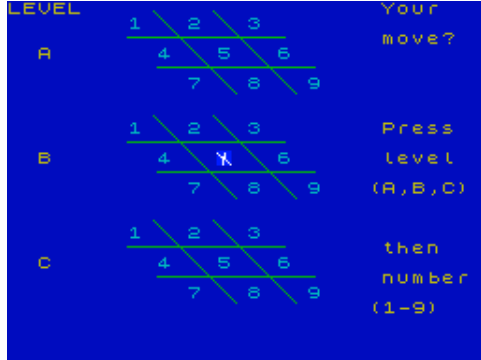

Nouns, Verbs, Adjectives and Adverbs (Calpac Educational Software,1983) Educational



Novotron 8 (.)
Arcade



Now Games 3 (Virgin Games Ltd,1986)
Compilation



Noughts and Crosses (JA Software,)
Board/Card Game



Noughts and Crosses, 3D (Spectrum Computing,1985)
Board/Card Game



Nous (Sinclair User,1991)
Board/Card Game

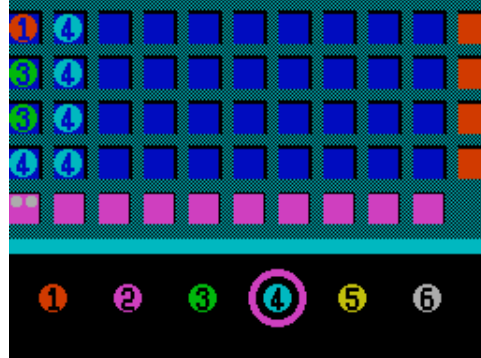

Now Games (Virgin Games Ltd,1985)
Compilation



Now Games 4 (Virgin Games Ltd,1987)
Compilation

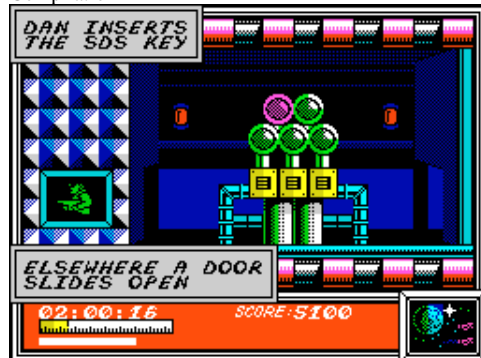

Noughts and Crosses (Sinclair Programs,1983)
Board/Card Game

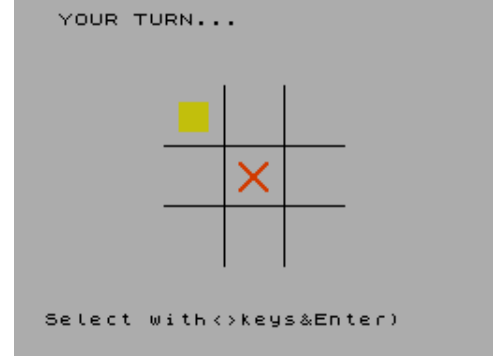

Noumenon (Noumenon Team,1997)
Scene Demo

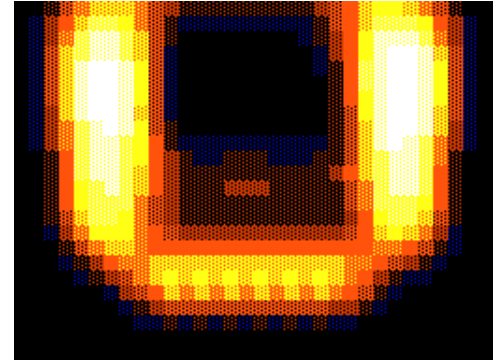

Novogodnaya Istoriya (Binary Masters,1996)
Board/Card Game



Now Games 2 (Virgin Games Ltd,1985)
Compilation



Now Games 5 (Virgin Games Ltd,1988)
Compilation



Nowotnik Puzzle, The (Phipps Associates,1983)
Board/Card Game

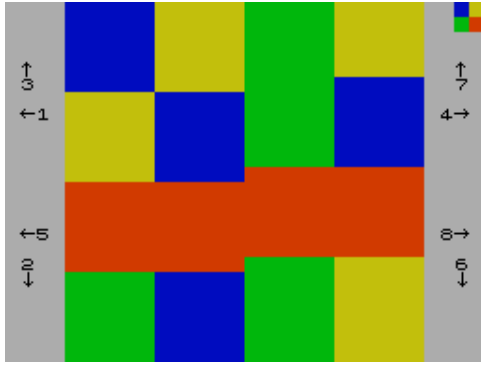

Nuclear Bowls (Zigurat Software,1986)
Arcade

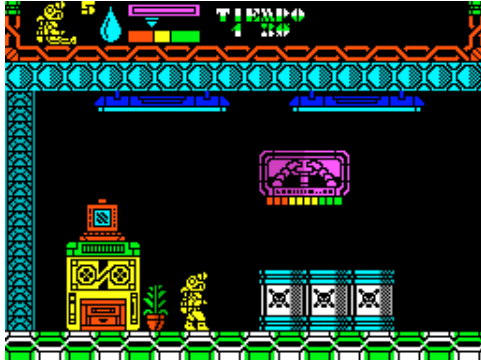

Nudget (Automata UK Ltd,1985)
Arcade

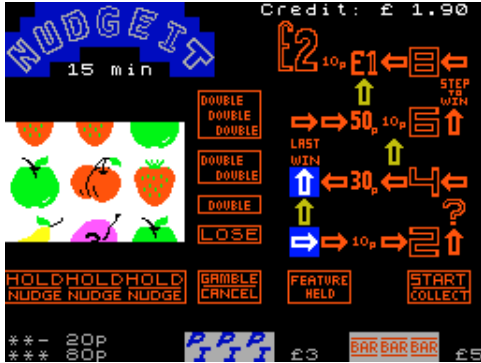

Nuevo Cargador Universal deCodigo Maquina
(MicroHobby,1991) Utility

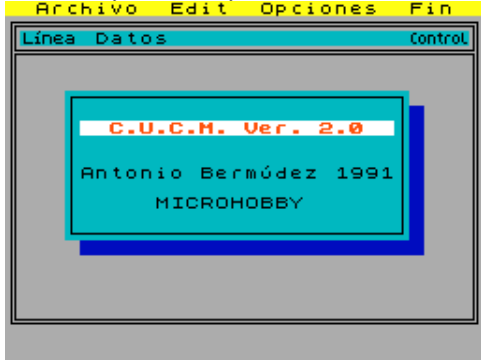

Nukescan (Minatron Computing,1983)
Simulation



Nth Zone (Automata UK Ltd,1985)
Arcade

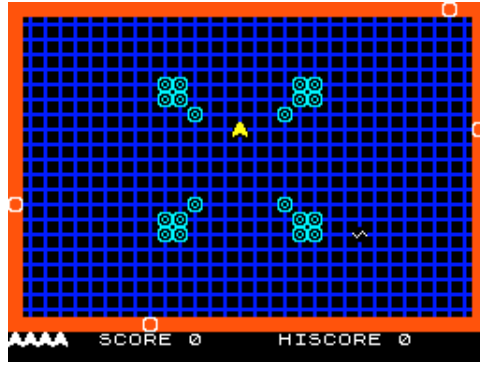

Nuclear Countdown (Atlantis Software Ltd,1987)
Arcade

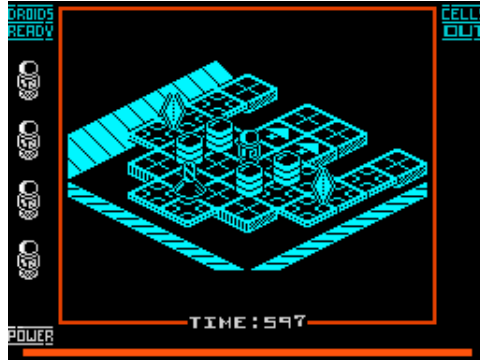

Nudger (Hitech Games Plus.)
Simulation

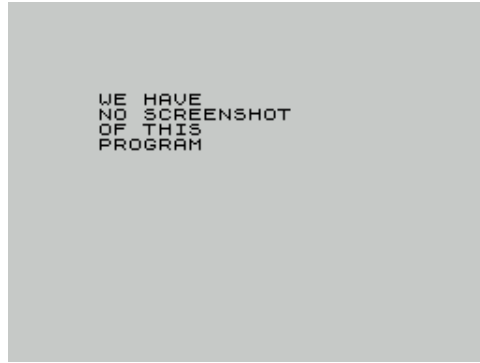

Nuevo Cargador Universal deCodigo Maquina +3
(MicroHobby,1991) Utility



Numb Cars (Triumph Game Labs,2001)
Arcade

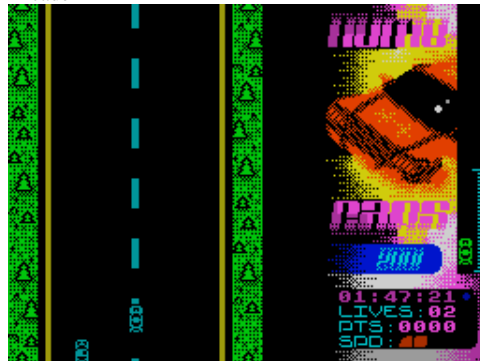

Nuclear Attack (EMS Software,1984)
Simulation



Nuclear Waste (Enigma Variations Ltd,1990)
Arcade



Nueve de Cada Diez Lapidas Estan Cambiadas
(Sindicato del Software,1993) Text Adventure

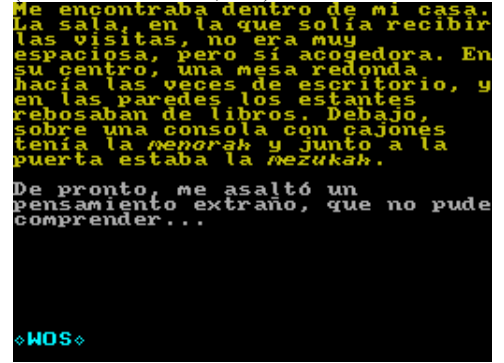

Nuke Lear (CCS,1984)
Arcade

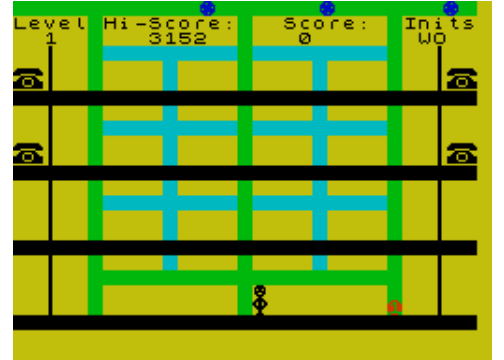

Number 6 in the Village (Philip Richmond,1987)
Text Adventure

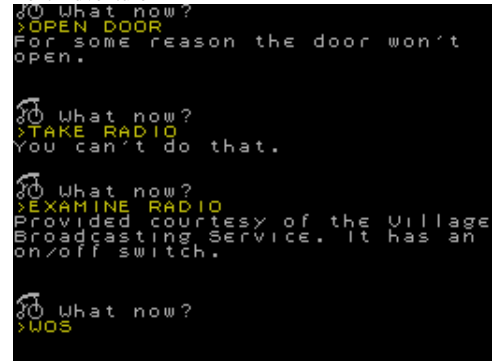

Number Bases (16/48 Tape Magazine,1985)

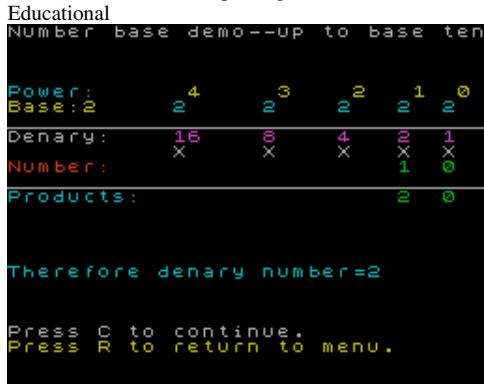

Number Cruncher (The Home Computer Advanced Course,)

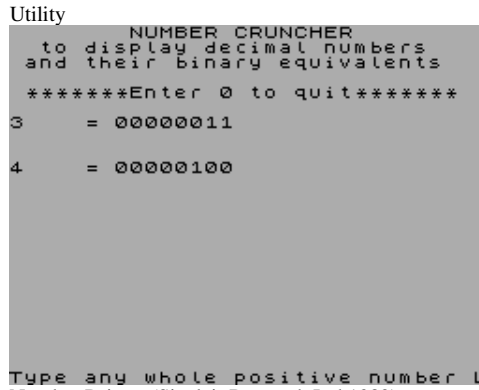

Numberfun (Griffin Software,1982)



Number of the Beast, The (Bluff Relay,1987)

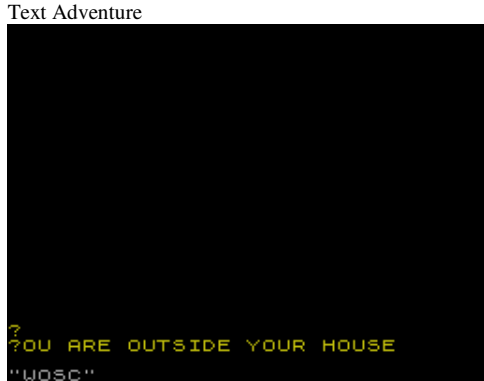

Number Painter (Sinclair Research Ltd,1983)

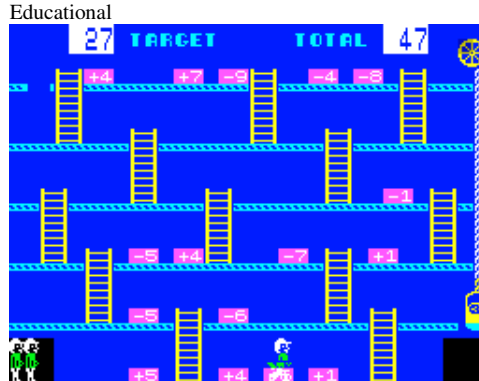

Numbers (R.D. Foord Software,)

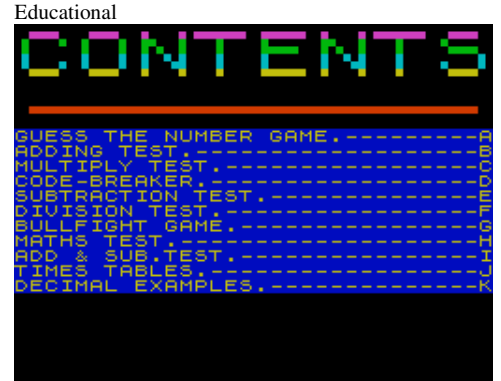

Numbers at Work (Collins Educational,1985)



Number Smash (Cowl Systems,1988)

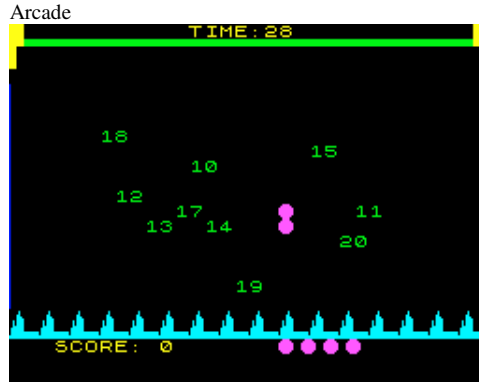

Number Tumblers (Fisher-Price Learning Software,1984)

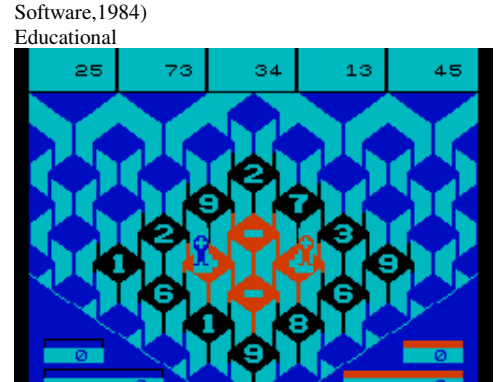

Numeros Complejos (MicroHobby,1985)



Nu, Pagadi (Omega,)

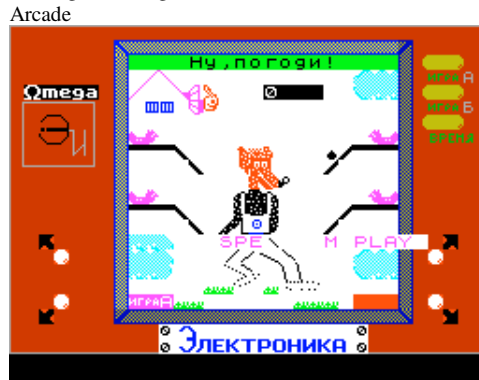

Nu, Pogodi! (Titanic,1995)



Nursery Rhyme Adventure (Collins Educational,1984)



Nursery Rhymes (Softlee Systems,1985)



Nutrition (Spectre Soft,1983)

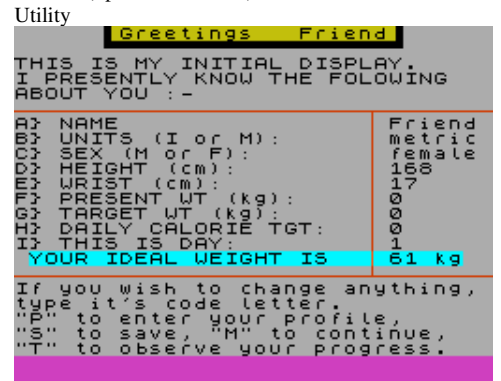

Nuty (.)
Utility: Music Creation

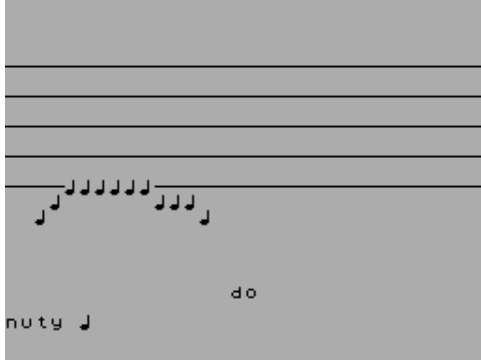

Nyitrai Matrix (Laszlo Nyitrai,1996)
Utility: BASIC Related



Oberon 69 (G.LL. Software,1990)
Arcade

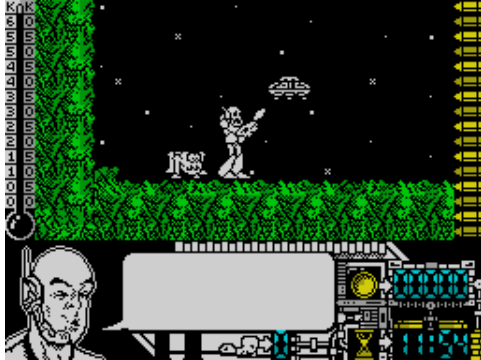

Obliterator (Melbourne House,1989)
Arcade Adventure

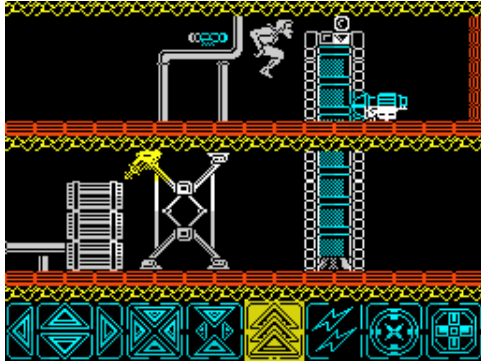

O'Brian (MicroHobby,1986)
Arcade



n Vaders (Add-On Electronics Ltd,1983)
Arcade



Nythyhel (The Guild,1987)
Text Adventure



Objetivo: La Moncloa (Software Center S.A.,1985)
Strategy



Oblivion (Alpha-Omega Software,1986)
Arcade



Obs. Prog (.)
Utility

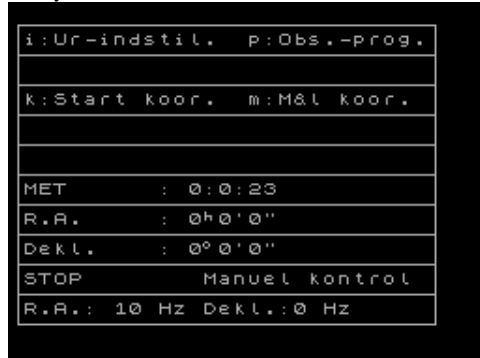

Nyitrai Basic (Laszlo Nyitrai,1998)
Utility: BASIC Related



Oasis 1 (Alex Kiselev,1993)
Scene Demo



Objetivo: Madrid - Parte 1 (Galo Alcolea,1989)
Text Adventure



OBR: Squad Quick Reaction (Chip & Rokky,1994)
Arcade



Obstaculos (MicroHobby,1985)
Arcade



Ocean Conqueror (Rack-It,1987)
Simulation



Ocean's Greatest Hits (Ocean Software Ltd,1986)
Compilation



Octagon (Budgie Budget Software,1987)
Board/Card Game

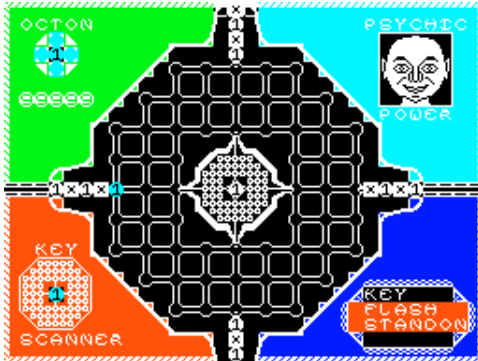

Octipede (16/48 Tape Magazine,1985)
Arcade

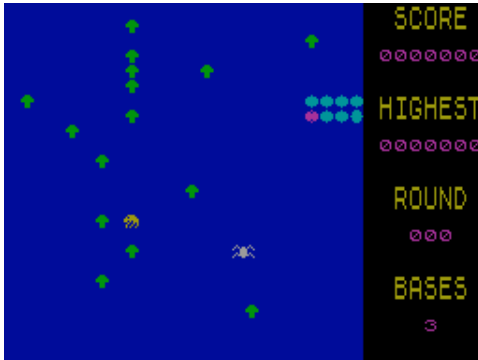

Odd Ball (The Power House,1987)
Arcade

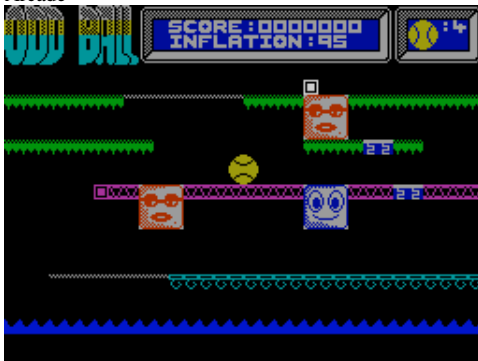

Ocean Dancer (King Software,1984)
Text Adventure

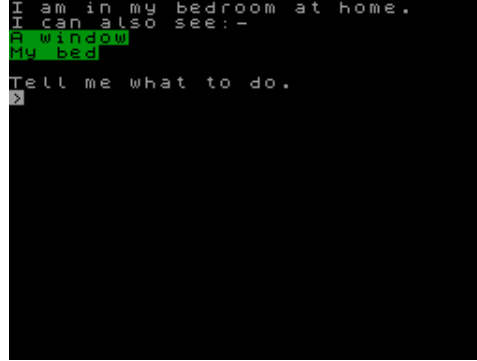

Ochko (ITP Universal,1991)
Board/Card Game



Octagon Squad (Mastertronic Ltd,1986)
Arcade

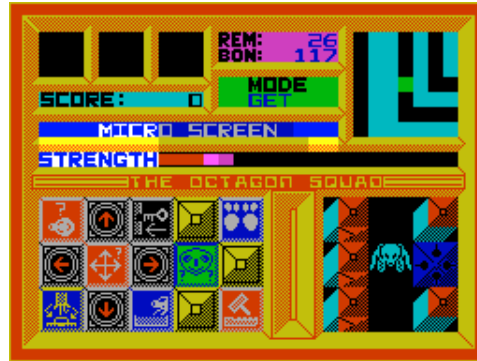

Octopus (Hanesoft GmbH,1984)
Arcade



Odd Job Eddie (Strobe,1985)
Arcade



Ocean Racer (Hill MacGibbon,1987)
Sport

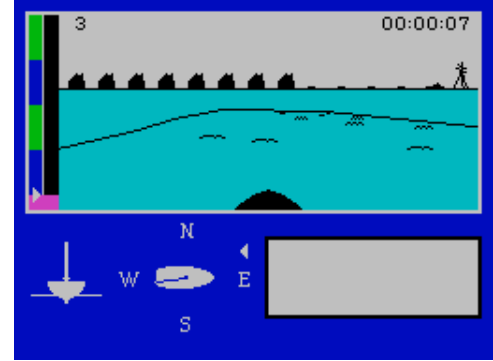

O-Copy (Martin Moracek,1988)
Utility: Copier



Octan (Silverbird Software Ltd,1987)
Arcade

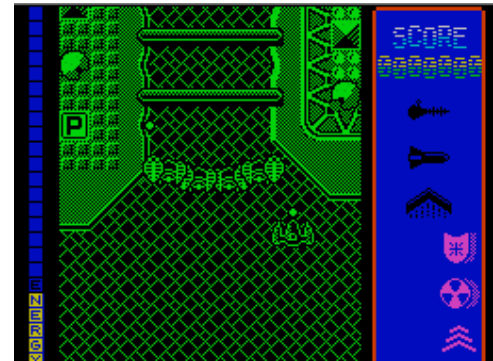

Octopussy (Ultrasoft,1992)
Arcade Adventure



Odd One Out (Griffin Software,1984)
Educational



Odds on (Ram Scan Design,1982)
Simulation

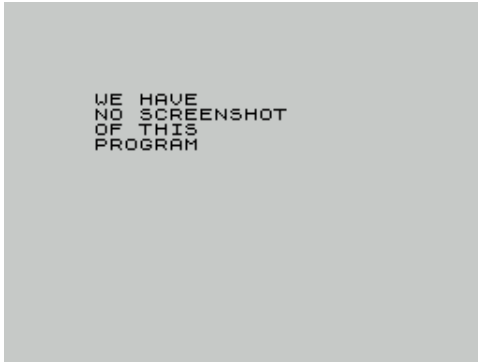

Odysseus Party Minishow (,1996)
Scene Demo



Oei (Eros.)
Scene Demo



Off the Hook (Electric Dreams Software,1986)
Compilation



Oh Mummy (Gem Software,1984)
Arcade

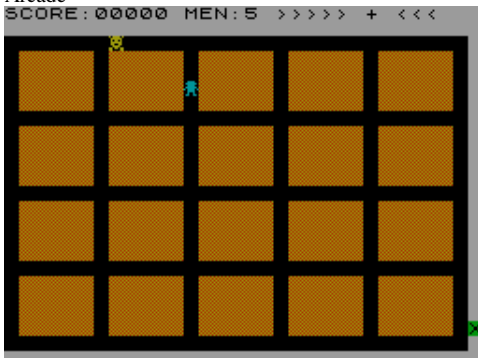

Odisea (Juana Pueblo Soft,1990)
Text Adventure



Odyssey 1 (Perfection Software,1983)
Arcade

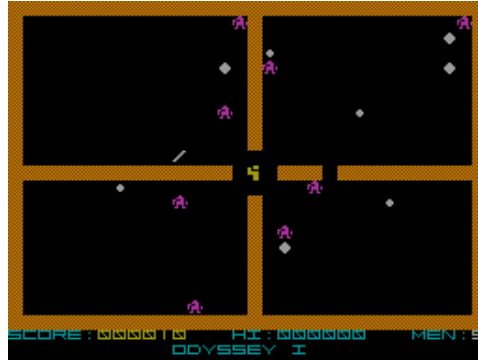

Office Master (Gemini Marketing Ltd,1986)
Utility



Off Topic (Hacker Olav/Igoval,1997)
Scene Demo



Ohota na Krotov (Asphyxia,1998)
Arcade



Odyssey (MicroHobby,1985)
Arcade

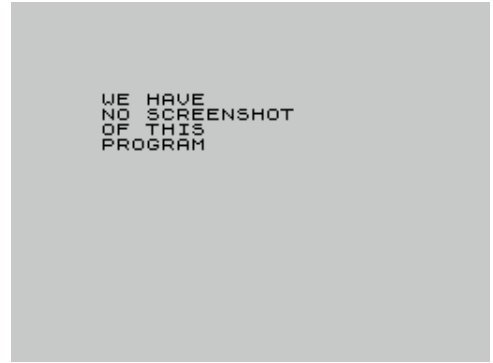

Odyssey of Hope, The (Martech Games Ltd,1984)
Text Adventure

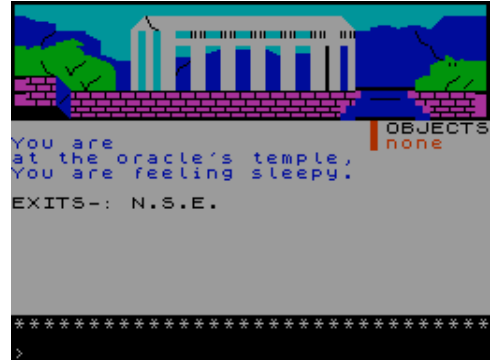

Official Father Christmas Game, The (Alternative Software Ltd,1989) Arcade Adventure



Ognom (MicroHobby,1985)
Arcade



Oh! P-Toon (Leon Noel,1984)
Board/Card Game



Oh Sh!t Another Big Disk (Zenobi Software,1993)
Compilation

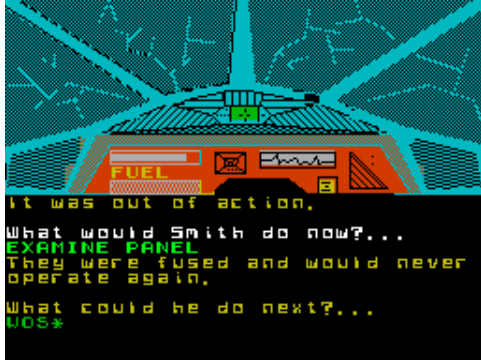

Oi! (Convention,1995)
Scene Demo

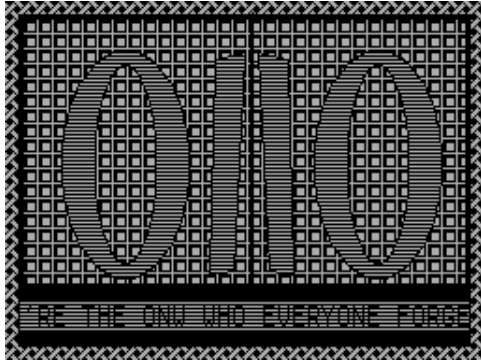

Oink! (CRL Group PLC,1987)
Arcade

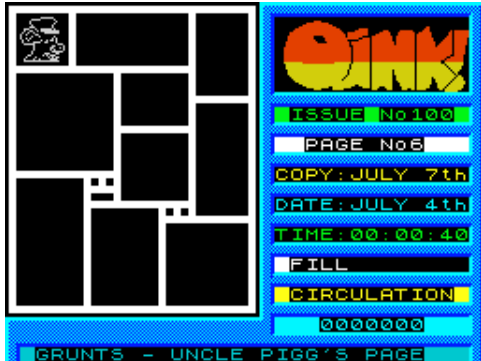

O.K. Yah! (Pirate Software Ltd,1988)
Arcade



Oleoducto (MicroHobby,1985)
Arcade



Oh Shit (Aackosoft,1984)
Arcade



Oil Strike (Macmillan Software Ltd/Sinclair Research Ltd,1984) Strategy

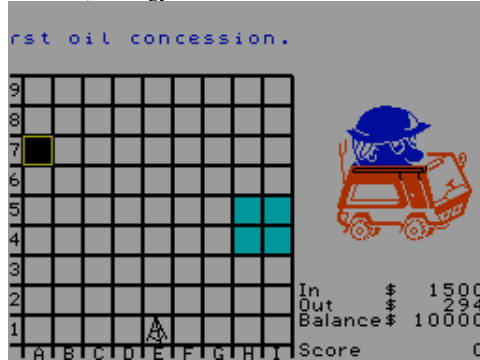

OiX (Jaroslaw Cichocki,1984)
Board/Card Game

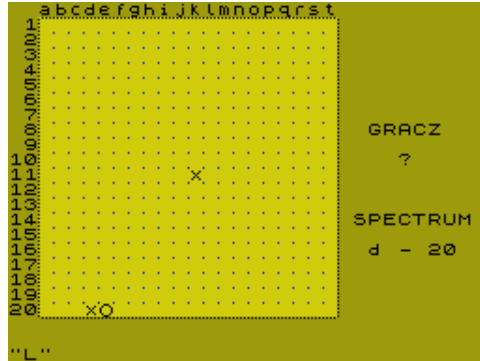

Oldman (Crazy Soft,2005)
Arcade



Ole, Toro (Dinamic Software,1985)
Arcade



Oh Shit! (Dominic Morris,1991)
Text Adventure

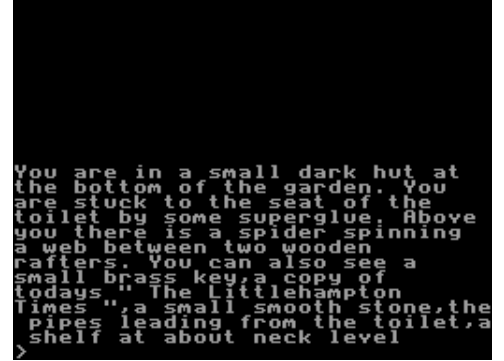

Oil Tycoon (Global Games [2],1985)
Simulation



Ojo del Dragon, El (Wazertown Works,1990)
Text Adventure

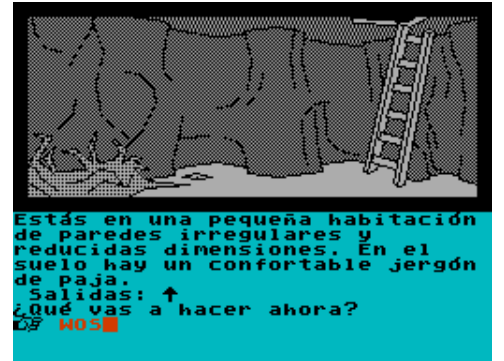

Old Scores (Global Software,1985)
Text Adventure



O'Level Biology (GCE Tutoring,1984)
Educational



O'Level Chemistry (GCE Tutoring,1984)
Educational

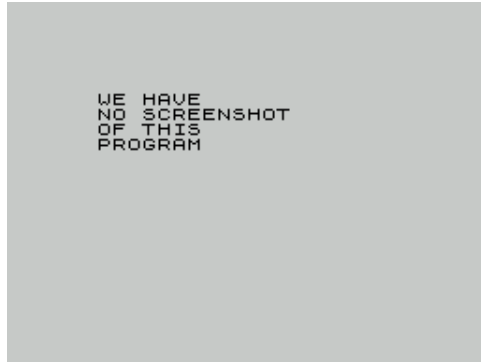

O'Level Computer Science (GCE Tutoring,1984)
Educational

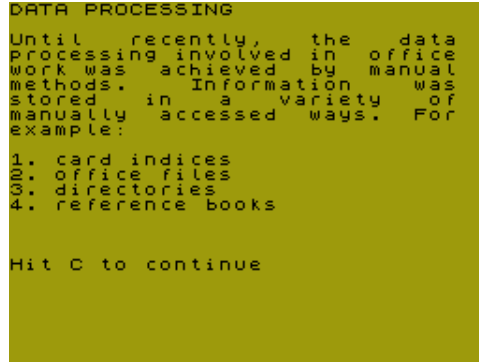

O'Level - CSE Chemistry (Calpac Educational Software,1982)
Educational

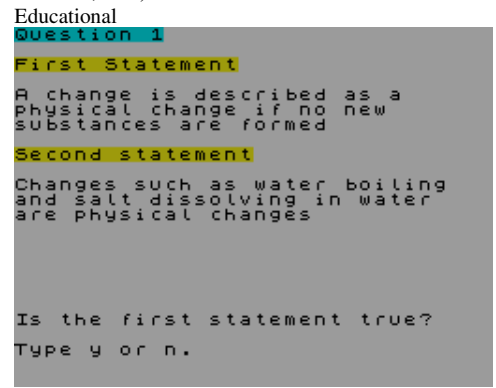

O'Level Electronics (GCE Tutoring,1984)
Educational



O'Level French (GCE Tutoring,1984)
Educational



O'Level French Revision: Vocabulary (Rose Software,1985)
Educational

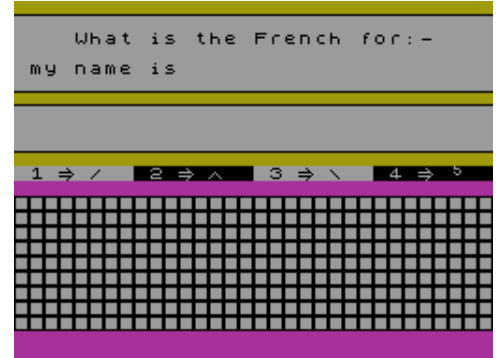

O'Level Maths (GCE Tutoring,1986)
Educational

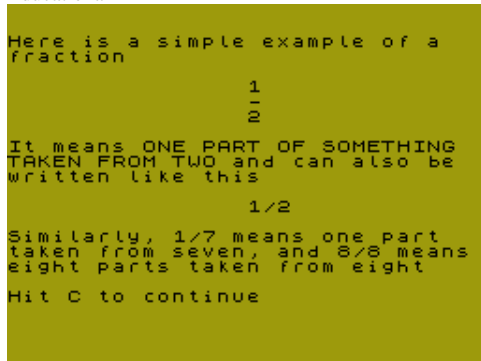

O'Level Maths Revision: Equations & Inequalities (Rose Software,1984) Educational

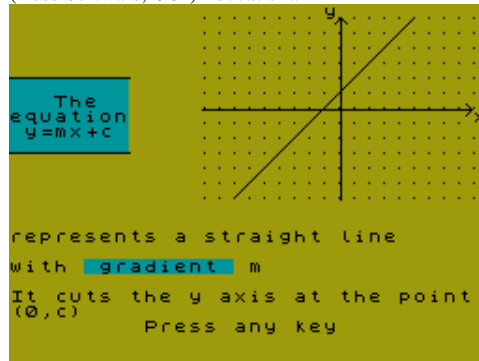

O'Level Maths Revision: Geometry (Rose Software,1983) Educational

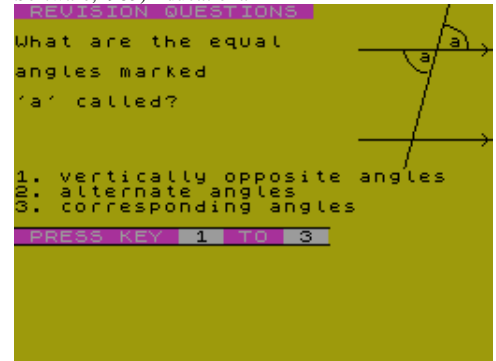

O'Level Maths Revision: Trigonometry (Rose Software,1983) Educational

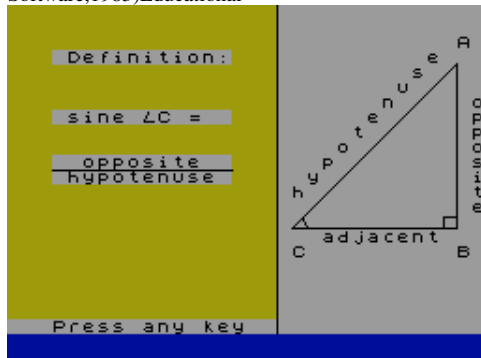

O'Level Maths Sprint (GCE Tutoring,1984)
Educational



O'Level Physics (GCE Tutoring,1984)
Educational



O'Level Physics Revision: Light and Heat (Rose Software,1984) Educational

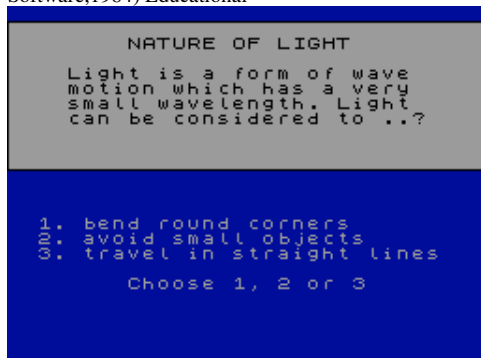

O'Level Principles of Computing (GCE Tutoring,1984)
Educational



O'Level Technical Drawing (GCE Tutoring,1984)
Educational



Oligopoly (CCS,1983)

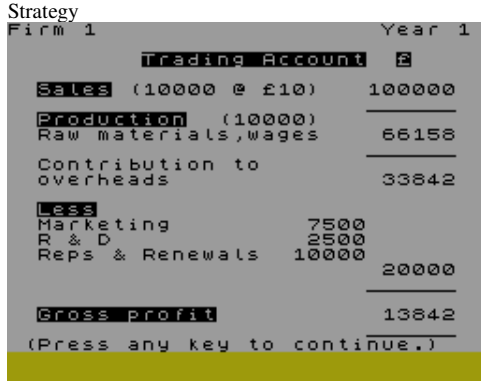

Olimpo en Guerra (Eduardo Jose Villalobos,1989)



Ollie Octopus' Sketchpad (Storm Software [1],1983)

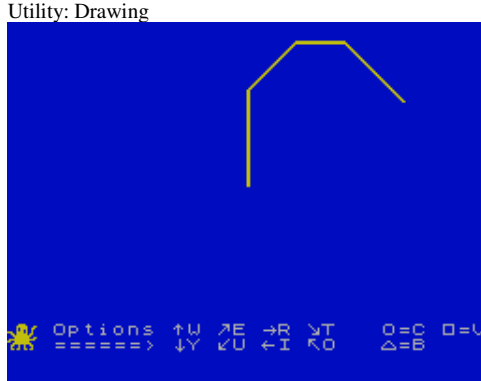

Olli & Lissa II: Halloween (Silverbird Software Ltd,1987)



Olympicon (Mitec,1984)



Olimpiadas (MicroHobby,1985)



Olimpus (MicroHobby,1985)



Olli & Lissa: The Ghost of Shilmoore (Firebird Software Ltd,1986)



Olympiad '86 (Atlantis Software Ltd,1986)

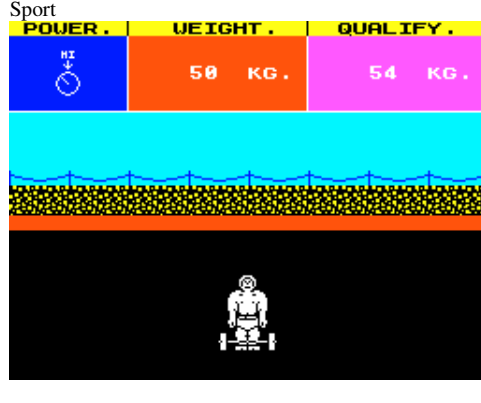

Olympics (CRL Group PLC,1984)

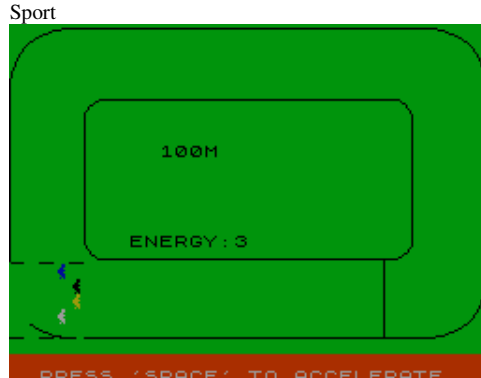

Olimpic (MicroHobby,1986)



Oliver's Music Box (Cosmic Pop,1986)



Olli & Lissa 3: The Candlelight Adventure (Cartoon Time,1989)



Olympic Challenge (Century City Software Ltd,1985)



Olympics '84 (Storm Software [1],1984)

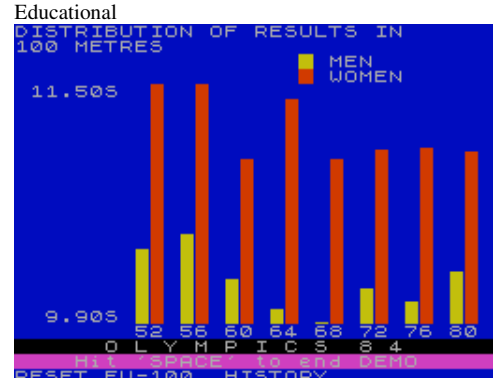

Olympimania (Automata UK Ltd,1984)
Sport

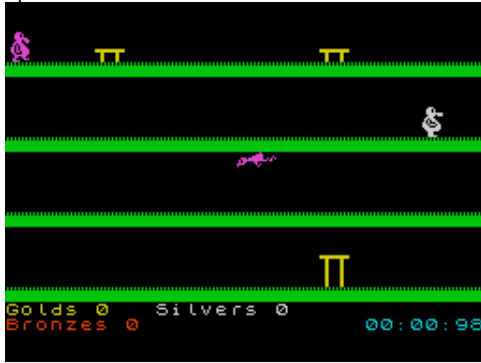

Omega Run (CRL Group PLC,1983)
Arcade

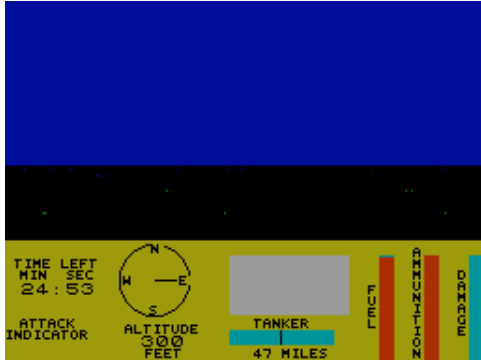

Ometron (Software Projects Ltd,1983)
Arcade



Omnicalc 2 (Microsphere,1983)
Utility: Spreadsheet

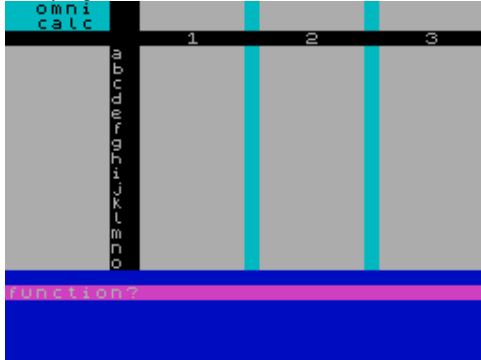

Once Upon a Lily Pad (Global Games [1],1989)
Text Adventure



Omadan Attack (Avalon Software,1984)
Arcade

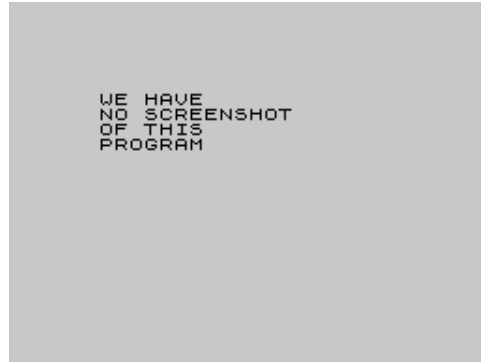

Omegatrom (MicroHobby,1985)
Arcade

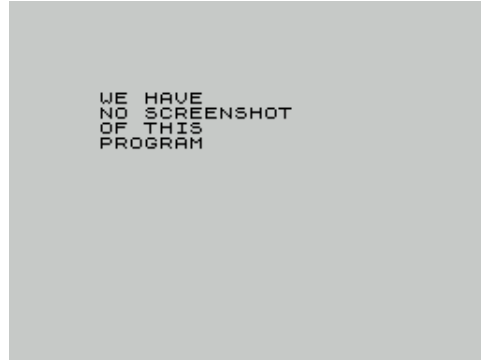

Ommadawn (Ignacio Prini Garcia,2001)
Music



Omnicalc 2 Expansion Tape (Microsphere,1985)
Utility: Spreadsheet



On-Court Tennis (Procin Soft Line,)
Sport



Omega 1 (Mastertronic Ltd,1987)
Arcade

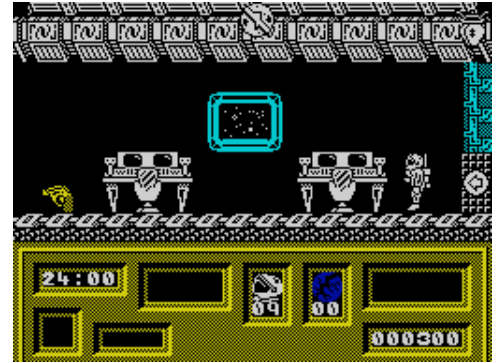

Omega Zone, The (Crash,1991)
Arcade

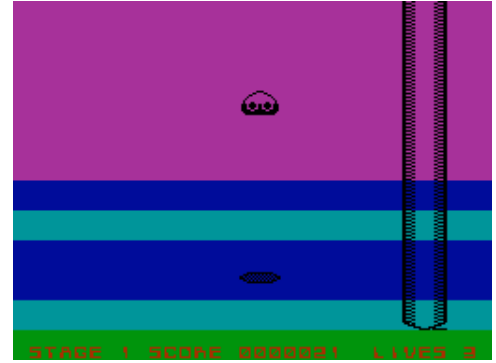

Omnicalc (Microsphere,1983)
Utility: Spreadsheet

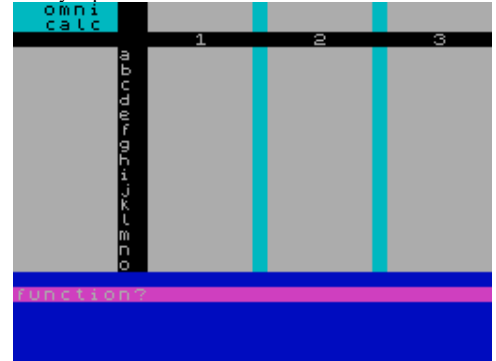

Omnicalc 2 Expansion Tape (Microsphere,1985)
Utility: Copier

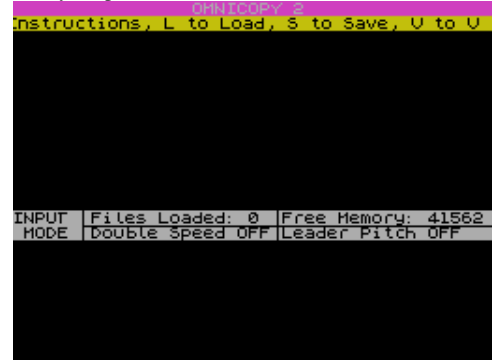

On Cue (Mastertronic Added Dimension,1987)
Arcade



One-Arm Bandit (Add-On Electronics Ltd,1983)
Simulation

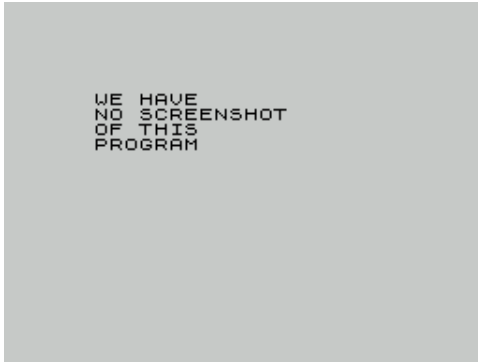

One Arm Bandit (Argus Press Software Ltd,1985)
Simulation



One Dark Night (Paul Brunyee,1988)
Text Adventure

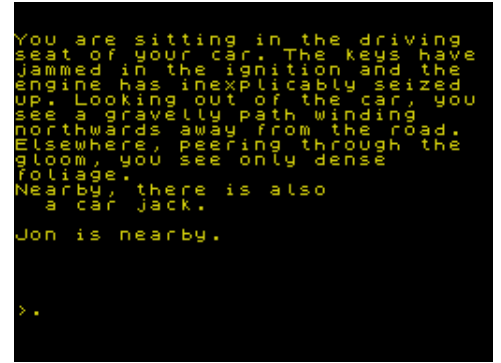

One Day Cricket (CRL Group PLC,1983)
Simulation



One Day Demo (7 Gods,1985)
Scene Demo



One for the Road (Tynesoft,1986)
Arcade

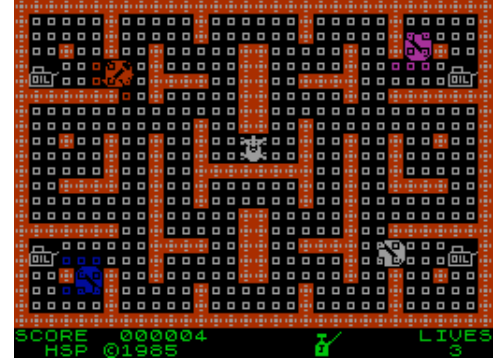

One for the Road + Mutations (Tynesoft,1986)
Compilation



Oneiroid (Action,2005)
Arcade Adventure

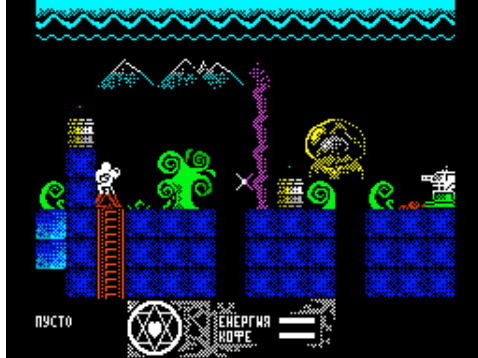

Oneiroid (Triumph Game Labs,)
Arcade Adventure



One Man and His Droid (Mastertronic Ltd,1985)
Arcade



One Man and His Droid II (Clive Brooker,2001)
Arcade

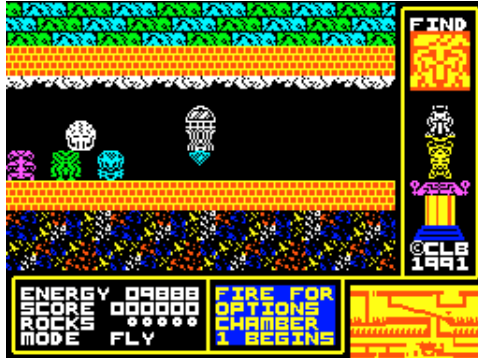

One More Big Disk (Zenobi Software,1992)
Compilation

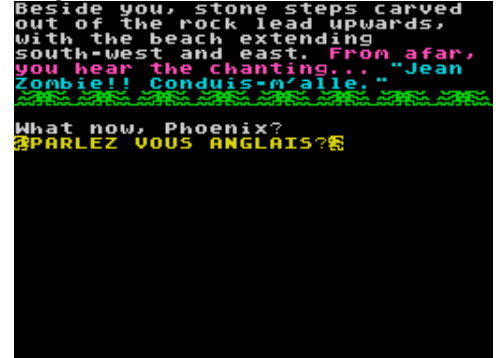

One of our Wombats is Missing (Zenobi Software,1990)
Text Adventure

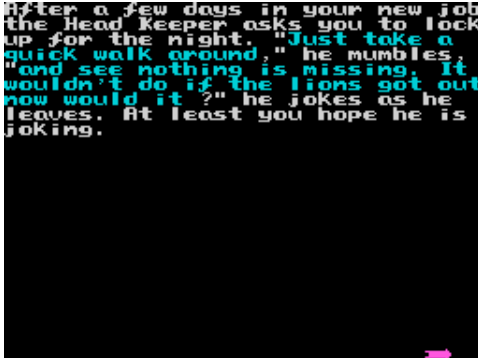

One on One (Ariolasoft UK Ltd,1985)
Arcade

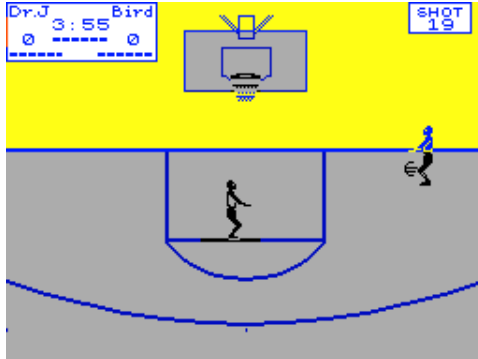

On Error Goto (,
Utility: BASIC Related

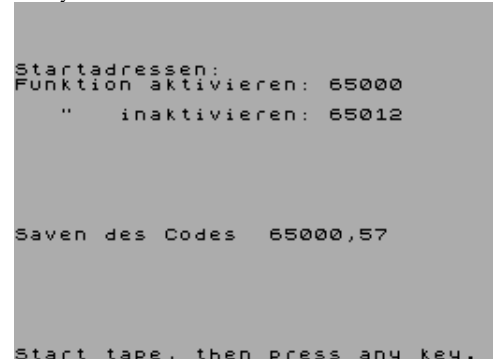

On-Error-Goto (Spectrum Computing,1985)
Utility: BASIC Related



On the Bench (Cult Games,1988)
Simulation

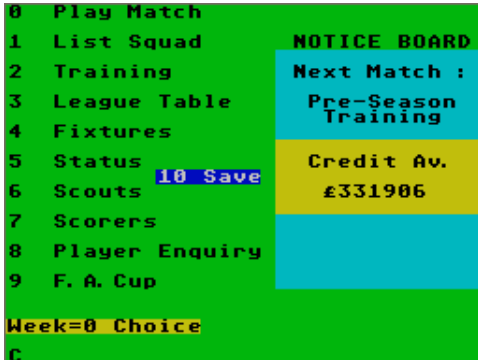

On the Oche (Artic Computing Ltd,1984)
Sport

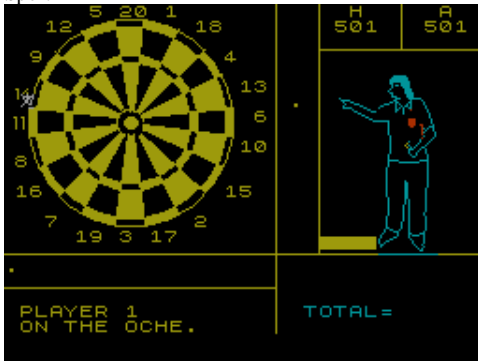

Oops (The Big Apple Entertainment Company,1988)
Arcade

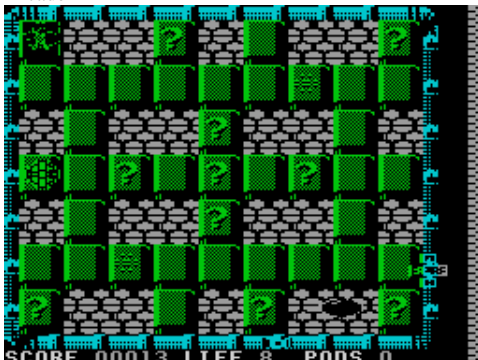

Opens (Studio Stall,2001)
Board/Card Game



One Too Many 2: The Total Piss-Up (Extacy-3,1994)
Scene Demo

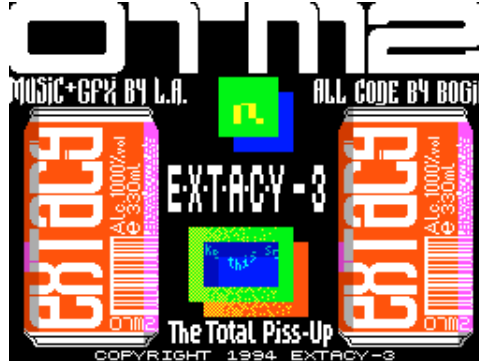

On the Burgle! (XFAWORLD Software,2005)
Arcade



On the Ropes II (Lambourne Games,1987)
Simulation

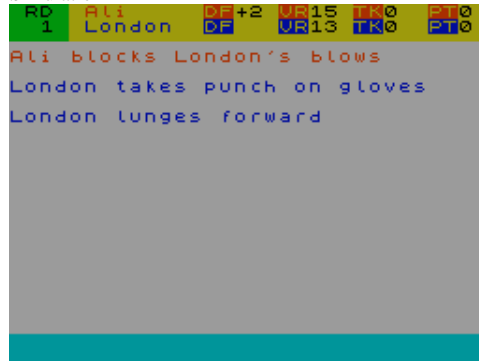

Open Door, The (Tartan Software,1988)
Text Adventure

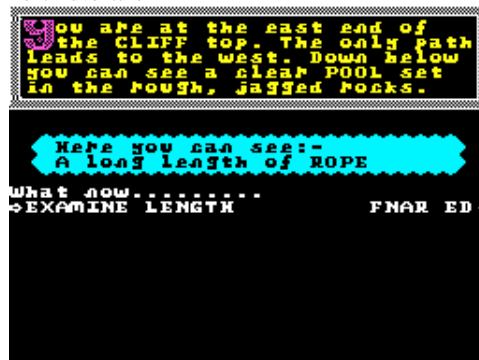

Opensafe (,1999)
Board/Card Game



One Too Many 3 (Extacy-3,1996)
Scene Demo



On the Flat (Lambourne Games,1993)
Strategy



On the Run (Design Design Software,1985)
Arcade



Open IT! (Hazard Dreams,1995)
Board/Card Game

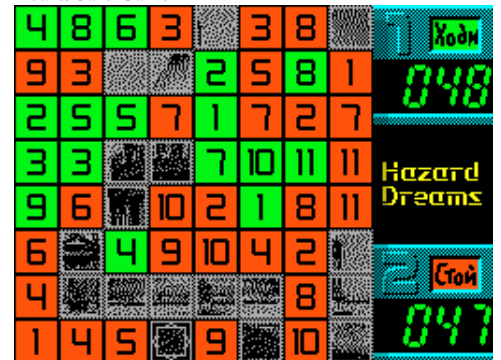

Open Tennis (Hipocrates Soft.)
Arcade



Open, The (CCS,1985)
Sport



Operadores Logicos 1, Los (MicroHobby,1985)
Utility



Operadores Logicos 4, Los (MicroHobby,1985)
Utility



Operadores Logicos 7, Los (MicroHobby,1985)
Utility



Operation Alignment (Global Software,1986)
Utility

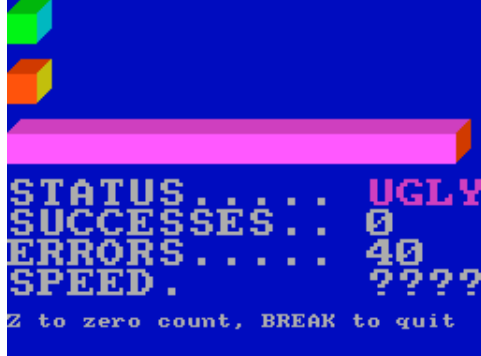

Operacion Conquista (Pepsi Soft,1992)
Text Adventure

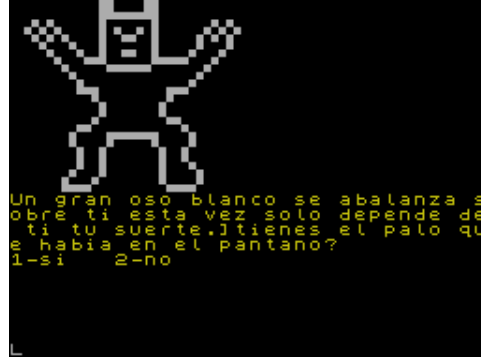

Operadores Logicos 2, Los (MicroHobby,1985)
Utility



Operadores Logicos 5, Los (MicroHobby,1985)
Utility



Opera Storys 1 (Opera Soft S.A.,1989)
Compilation



Operation Aquatrash (Pro Hackers Dynasty,1997)
Text Adventure



Operaciones Matematicas (,) Educational

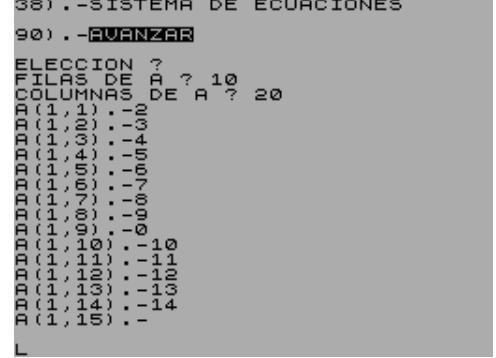

Operadores Logicos 3, Los (MicroHobby,1985)
Utility



Operadores Logicos 6, Los (MicroHobby,1985)
Utility



Opera Super Sports (Opera Soft S.A.,) Compilation



Operation Berlin (Wrightchoice Software,1987)
Text Adventure

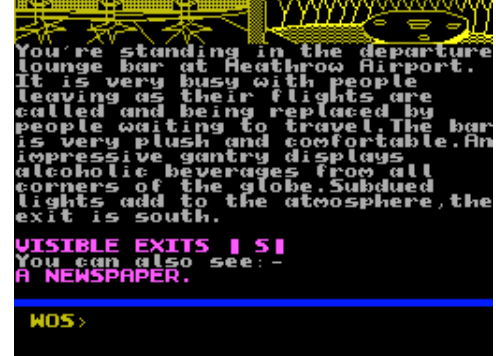

Operation Caretaker (Global Software,1985)
Utility

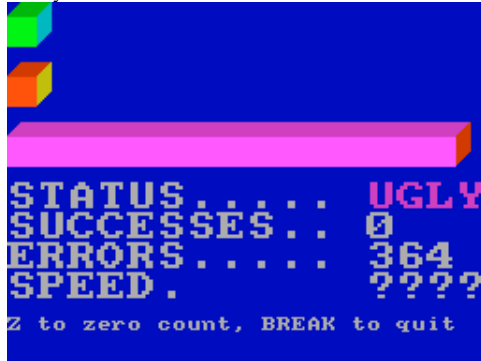

Operation Gunship (Code Masters Ltd,1989)
Arcade



Operation Hormuz (Again Again,1989)
Arcade



Operation Roman Gaul (Specsoft,.)
Text Adventure



Operation Thunderbolt (Ocean Software Ltd,1989)
Arcade

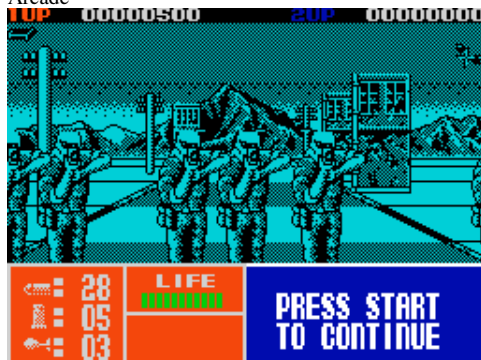

Operation Cerberus (Colin Bishop,1985)
Strategy



Operation Gunshot (Creative Micro Stimulation,1989)
Arcade



Operation Nightingale (Softly Softly,1985)
Text Adventure

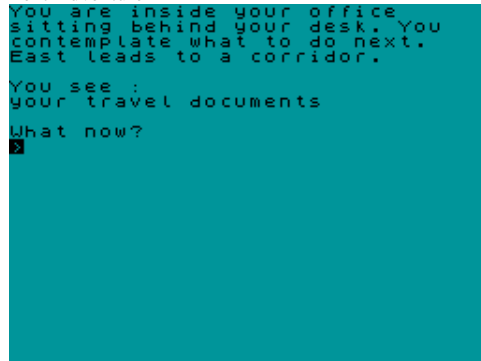

Operation Sirius (Achim Kern,.)
Arcade



Operation Thunderbowl (Sacred Scroll Software,1988)
Text Adventure



Operation Colossus (16/48 Tape Magazine,1986)
Text Adventure



Operation Hanoi (Players Premier Software,1990)
Arcade

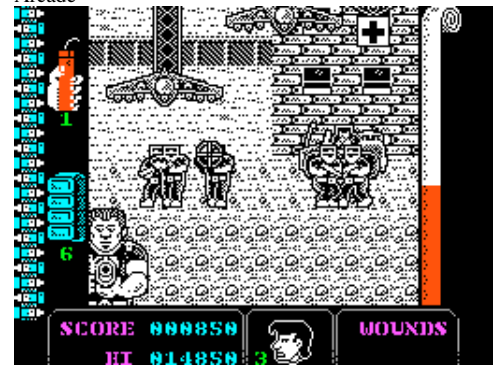

Operation Red Refrigerator (Galaxy Inc,1997)
Arcade Adventure



Operation Stallion (Wrightchoice Software,1987)
Text Adventure

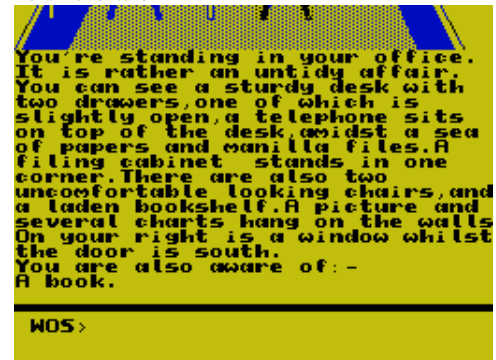

Operation Turtle (Pocket Money Software,1984)
Text Adventure

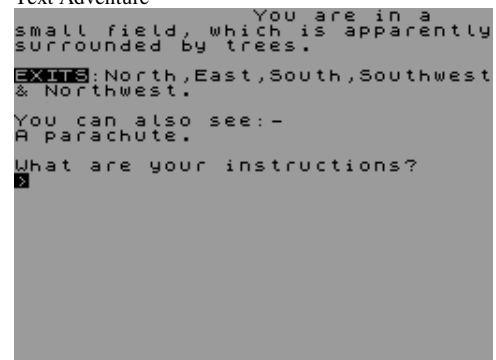

Operation Wolf (Ocean Software Ltd,1988)
Arcade

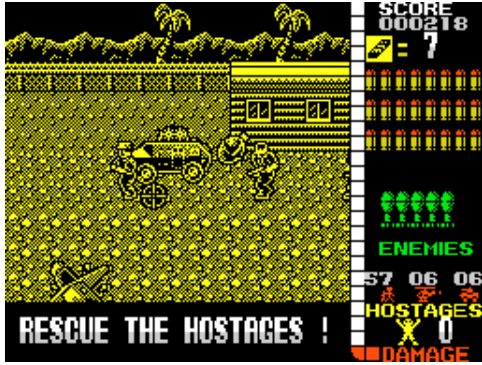

Oppressed Land, The (Zenobi Software,1990)
Text Adventure

Zachra looks around. He seems to be just outside an ancient, vast castle. In front of him, there is an ancient, vast castle! The countryside around here is flat and barren, with undulating hills to the West, a town to the EAST, and a forest to the SOUTH. The castle itself is to the NORTH.

Also to be seen :-
A Log.

E*

Oraculo, El (Ediciones y Textos S.A.,1985)
Utility

WE HAVE
NO SCREENSHOT
OF THIS
PROGRAM

Orb (Impact Software [1],1982)
Text Adventure

You move east but it is a dead-end, so you return to where you were before.

What next? "L"

Orbit of Doom (Dave Watson,)
Text Adventure

The crew's Quarters

You can also see:-
A large locker

What are your instructions?
*

Opium 4K (Steel Falcons,1998)
Scene Demo

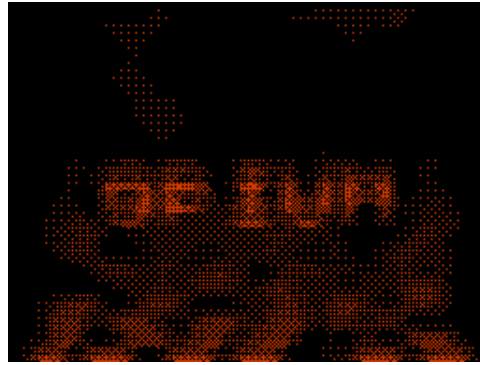

Oracle's Cave, The (Doric Computer Services,1984)
Arcade Adventure



Orajatek (NyitraiSOFT,2003)
Board/Card Game



Orbit (B.Sides Software,1984)
Arcade

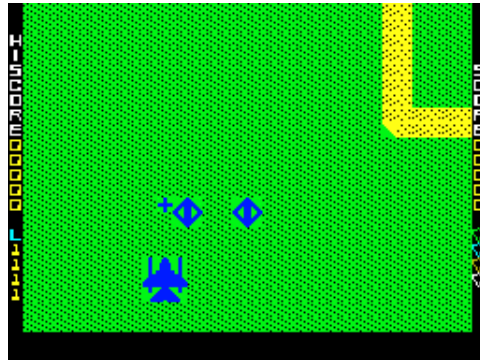

Orbix the Terrorball (Streetwise,1986)
Arcade

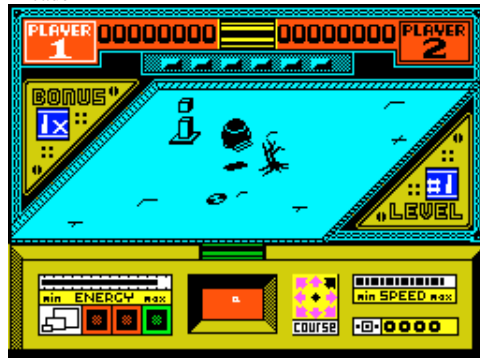

Opposition (Pulsonic,1984)
Board/Card Game

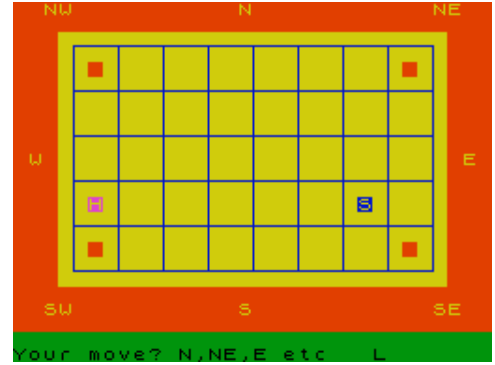

Oraculo (,1990)
Text Adventure



Orange Demo (Dennis van Berkel,)
Scene Demo

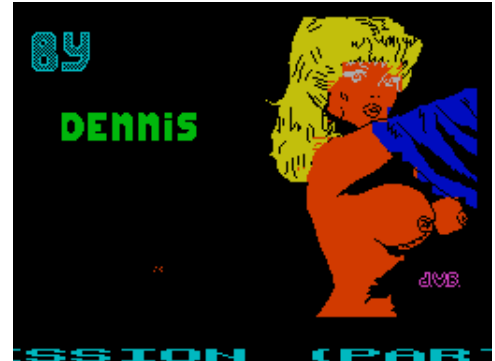

Orbiter (Silversoft Ltd,1982)
Arcade

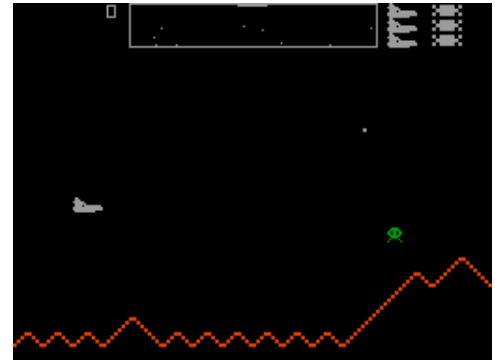

Orb Quest (The Guild,1991)
Text Adventure

You are standing on a jetty around which are docked a number of boats of all sizes and colours. Drunken seamen are sprawled everywhere, singing, drinking and some even sporing. The jetty leads North to the fishing port of Mirekemp. A swarthy captain is looking at you intently.

What next?
*

Orb, The (CRL Group PLC,1983)
Arcade Adventure



Orchard (Sinclair Programs,1983)
Arcade



Orc Slayer (Gamma Software,1984)
Text Adventure

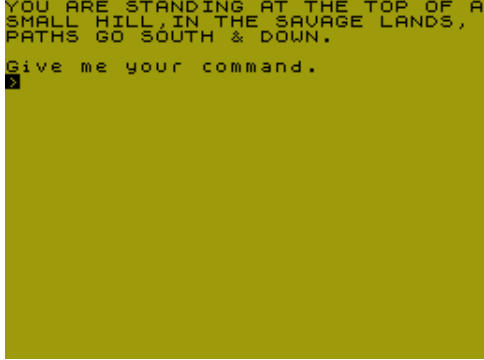

Ordenador Educativo issue 03 (Monser S.A.,1985)
Covertape



Ordenador Educativo issue 06 (Monser S.A.,1985)
Covertape



Orcamento Domestico (Microideia,)
Utility: Database

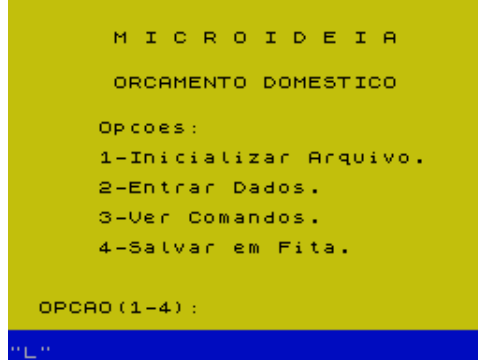

Orchard Thief (Virgin Books,1983)
Arcade

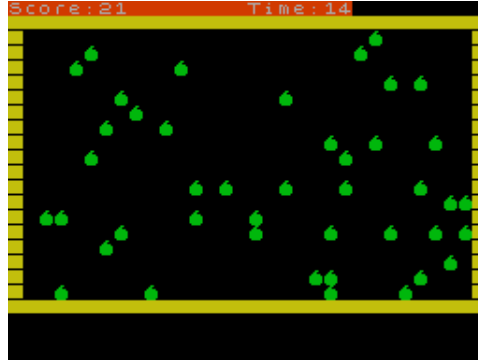

Ordenador Educativo issue 01 (Monser S.A.,1985)
Covertape



Ordenador Educativo issue 04 (Monser S.A.,1985)
Covertape

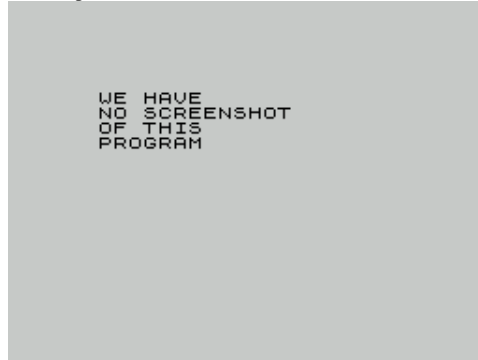

Ordenador Educativo issue 07 (Monser S.A.,1985)
Covertape



Orc Attack (Creative Sparks,1984)
Arcade

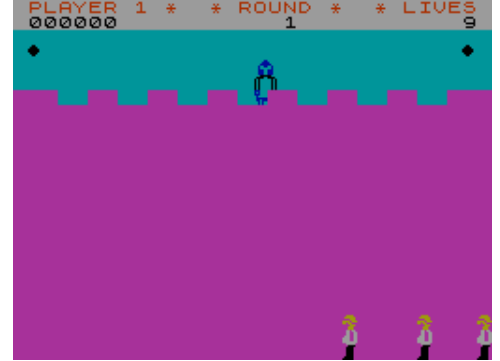

Orc Island (,1984)
Text Adventure



Ordenador Educativo issue 02 (Monser S.A.,1985)
Covertape



Ordenador Educativo issue 05 (Monser S.A.,1985)
Covertape



Ordenaletras (MicroHobby,1985)
Board/Card Game



Orfeus Music Assembler (Proxima Software,1990)
Utility: Music Creation

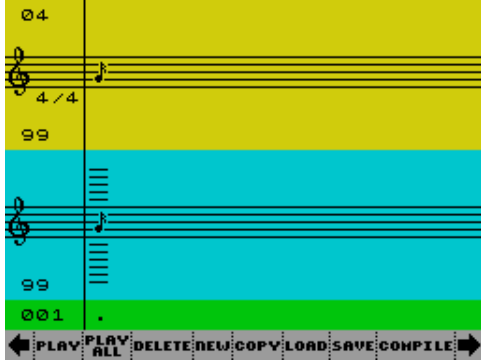

Organo Musical (MicroHobby,1985)
Utility



Orion (Proxima Software,1993)
Arcade



Orm and Cheep: Narrow Squeaks (Macmillan Software Ltd,1985) Educational

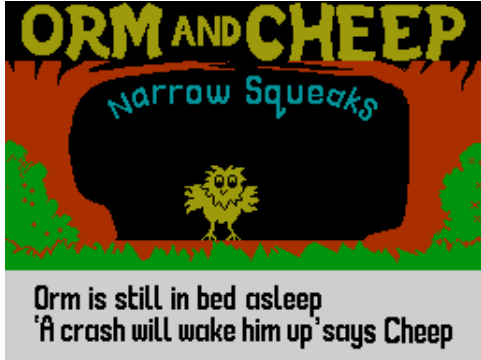

Oroset (MicroHobby,1986)
Arcade



Organ Master (Currys,1986)
Utility: Music Creation



Oriental Games (Micro Style,1990)
Sport

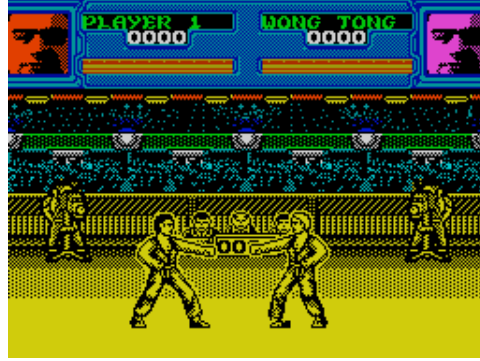

Orion (Software Projects Ltd,1983)
Arcade

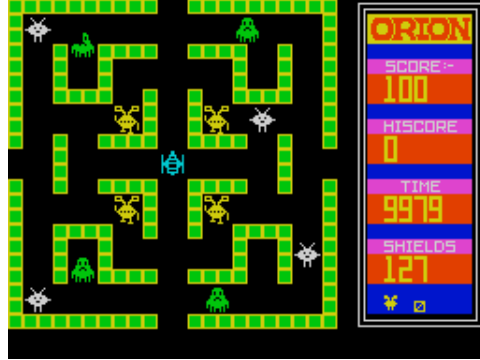

Orm and Cheep: The Birthday Party (Macmillan Software Ltd,1985) Educational

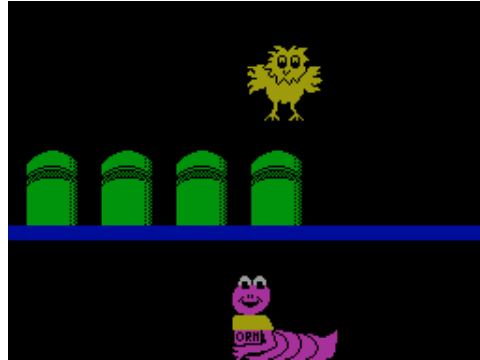

Orpheus (Visions Software Factory,1983)
Arcade

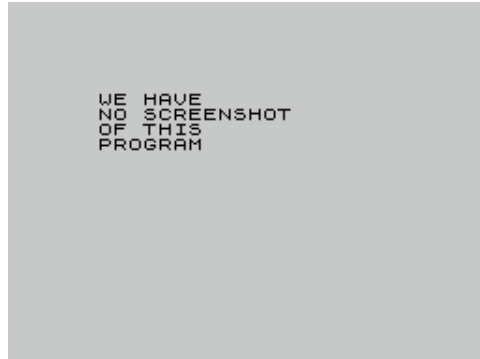

Organo (Microparadise Software,1984)
Utility: Music Creation



Oriental Hero (Firebird Software Ltd,1987)
Arcade

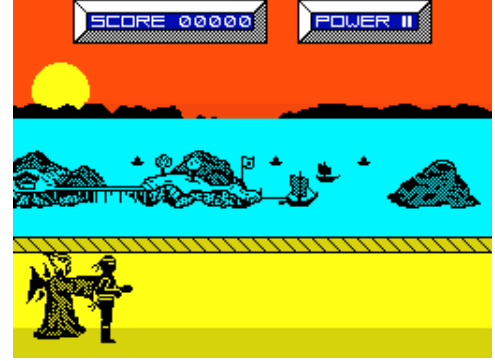

Orion-7 (EP Software,)
Arcade

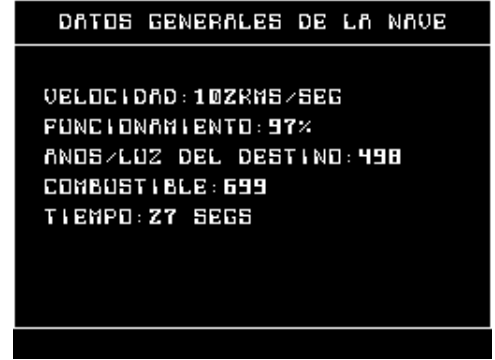

Ormuz (Iber Software,1988)
Simulation



Orpheus in the Underworld (CRL Group PLC,1984)
Arcade



Orsis (Freaky Fruitbat Software,1989)
Simulation

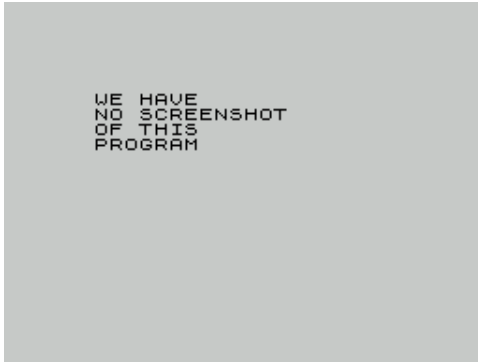

Oso Bobo (MicroHobby,1985)
Arcade



Ostron (Softek Software International Ltd,1983)
Arcade

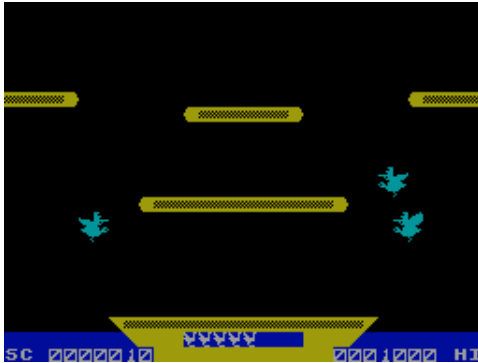

Otdel 8: Agent Larry & Lisa vs Dr.X (Action,2000)
Arcade

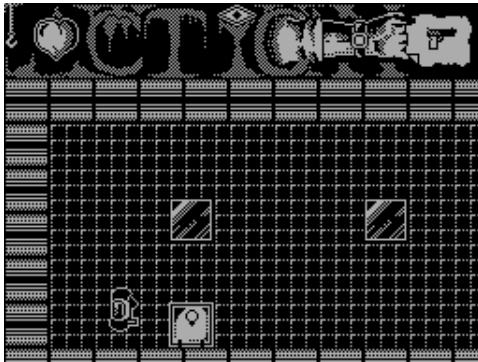

Othello (,) Board/Card Game

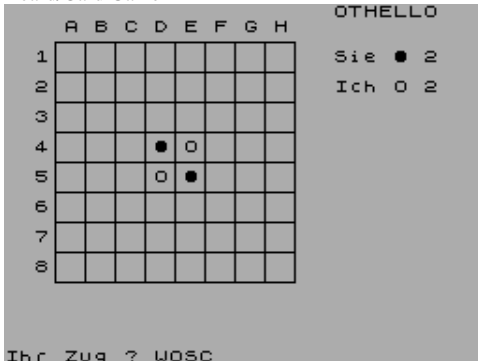

Ortografia (Coral Software,1985)
Utility

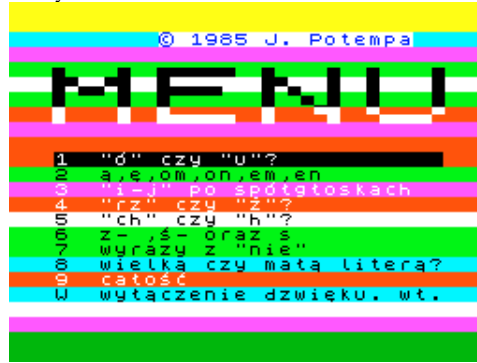

O.S. Quiz (Arnold Wheaton Software,1983)
Educational



Osvajanje Zvezda (,) Arcade

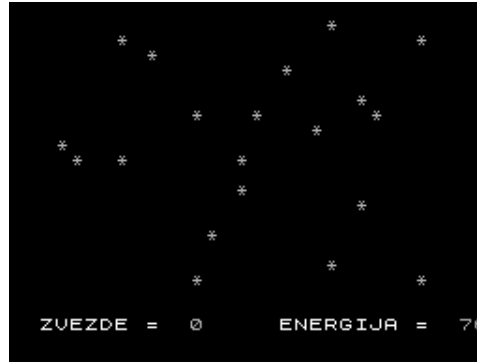

Ot Egy Sorban (Laszlo Nyitrai,1998)
Board/Card Game



Othello (CDS Microsystems,1983)
Board/Card Game

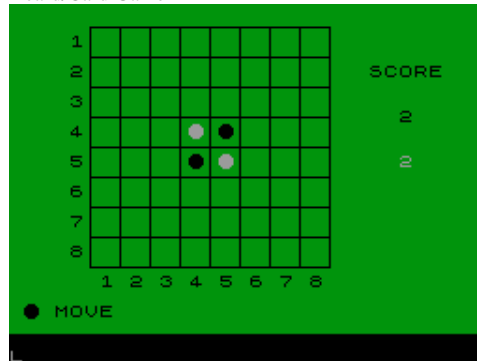

Oscar 10 (YU3TRC,)
Utility

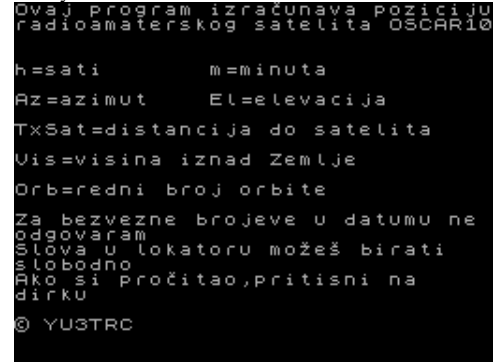

Osten (JC Jumbo Data,1984)
Arcade

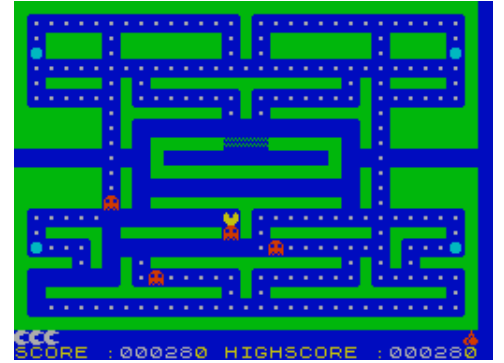

OTAN Alerta!+ War Zone (Juegos & Estrategia,1985)
Compilation

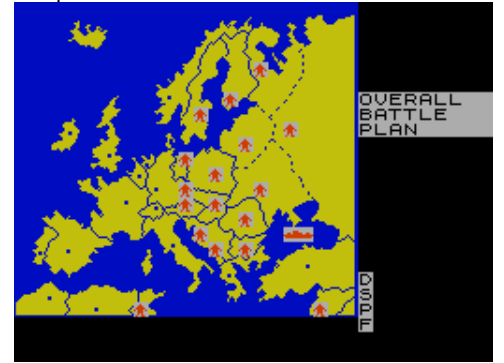

Otelo (MicroHobby,1985)
Board/Card Game



Othello (ERE Informatique,)
Board/Card Game

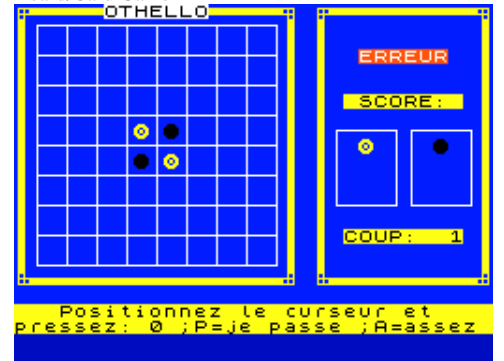

Othello (Laszlo Nyitrai,1998)
Board/Card Game

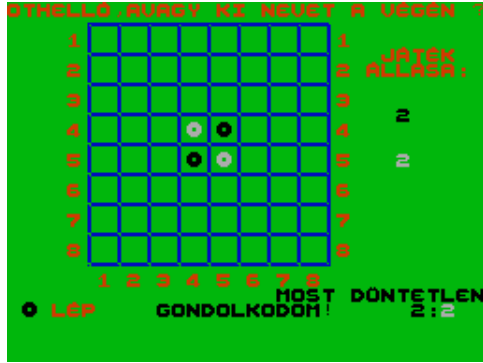

O'Thelo (DIMensionNEW/Idealogic S.A.,1984)
Board/Card Game

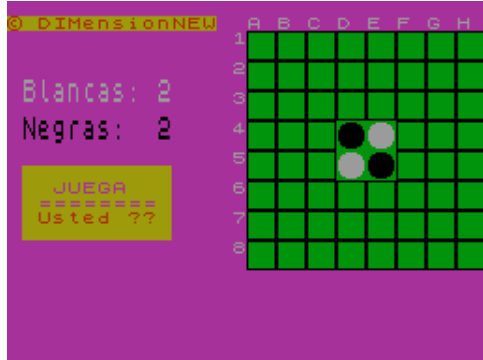

Our Class (Teacher's Pet Software,1988)
Educational



Our Life 3 (Flash Inc,1994)
Scene Demo



Out Demo (Jusoft,1992)
Scene Demo

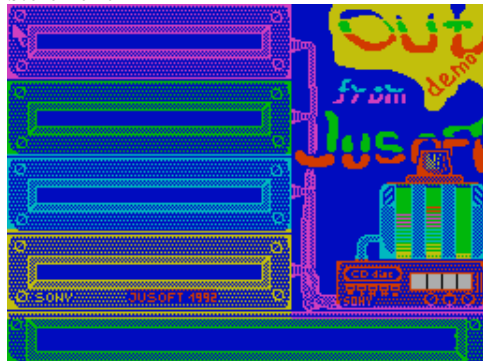

Othello (Professional Software,1983)
Board/Card Game

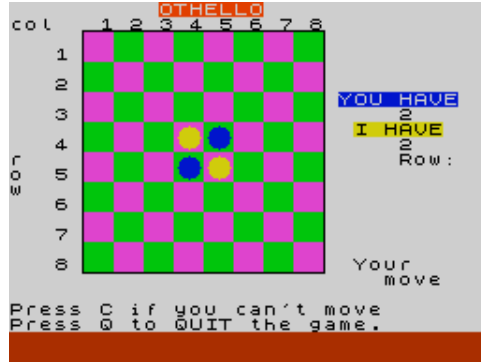

Otodolo 2 (Laszlo Nyitrai,2005)
Board/Card Game

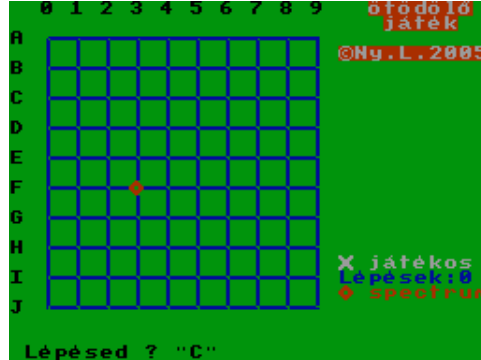

Our Life 1 (Flash Inc,1994)
Scene Demo



Outcast (CRL Group PLC,1987)
Arcade Adventure



Out for the Count (Dynamite Designs,1989)
Arcade



Othello 2005a (NyitraiSOFT,2005)
Board/Card Game

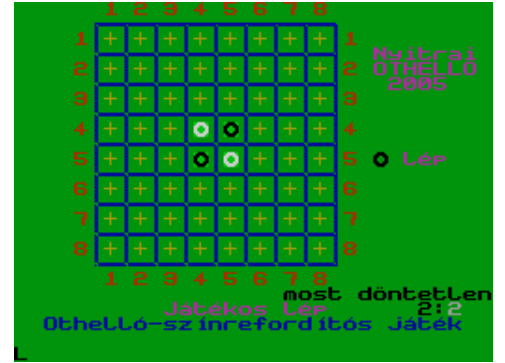

OTWOC (Thomas Busse,)
Arcade



Our Life 2 (Flash Inc,1994)
Scene Demo



Out Copy (.)
Utility: Copier



Outlaw (Players Premier Software,1990)
Arcade



Outlet Clipper 001, The (Chezron Software,) Utility

WE HAVE
NO SCREENSHOT
OF THIS
PROGRAM

Outlet Clipper 002, The (Chezron Software,) Utility

WE HAVE
NO SCREENSHOT
OF THIS
PROGRAM

Outlet Clipper 003, The (Chezron Software,) Utility

WE HAVE
NO SCREENSHOT
OF THIS
PROGRAM

Outlet Clipper 004, The (Chezron Software,) Utility

WE HAVE
NO SCREENSHOT
OF THIS
PROGRAM

Outlet Clipper 005, The (Chezron Software,) Utility

WE HAVE
NO SCREENSHOT
OF THIS
PROGRAM

Outlet Clipper 006, The (Chezron Software,) Utility

WE HAVE
NO SCREENSHOT
OF THIS
PROGRAM

Outlet Clipper 007, The (Chezron Software,) Utility

WE HAVE
NO SCREENSHOT
OF THIS
PROGRAM

Outlet Clipper 008, The (Chezron Software,) Utility

WE HAVE
NO SCREENSHOT
OF THIS
PROGRAM

Outlet issue 001 (Outlet Microdrive Magazine,1987) Covertape

WE HAVE
NO SCREENSHOT
OF THIS
PROGRAM

Outlet issue 002 (Outlet Microdrive Magazine,1987) Covertape

WE HAVE
NO SCREENSHOT
OF THIS
PROGRAM

Outlet issue 003 (Outlet Microdrive Magazine,1987) Covertape

WE HAVE
NO SCREENSHOT
OF THIS
PROGRAM

Outlet issue 004 (Outlet Microdrive Magazine,1987) Covertape

WE HAVE
NO SCREENSHOT
OF THIS
PROGRAM

Outlet issue 005 (Outlet Microdrive Magazine,1988) Covertape

WE HAVE
NO SCREENSHOT
OF THIS
PROGRAM

Outlet issue 006 (Outlet Microdrive Magazine,1988) Covertape

WE HAVE
NO SCREENSHOT
OF THIS
PROGRAM

Outlet issue 007 (Outlet Microdrive Magazine,1988) Covertape

WE HAVE
NO SCREENSHOT
OF THIS
PROGRAM

Outlet issue 008 (Outlet Microdrive Magazine,1988)
Covertape

WE HAVE
NO SCREENSHOT
OF THIS
PROGRAM

Outlet issue 009 (Outlet Microdrive Magazine,1988)
Covertape

WE HAVE
NO SCREENSHOT
OF THIS
PROGRAM

Outlet issue 010 (Outlet Microdrive Magazine,1988)
Covertape

WE HAVE
NO SCREENSHOT
OF THIS
PROGRAM

Outlet issue 011 (Outlet Microdrive Magazine,1988)
Covertape

WE HAVE
NO SCREENSHOT
OF THIS
PROGRAM

Outlet issue 012 (Outlet Microdrive Magazine,1988)
Covertape

WE HAVE
NO SCREENSHOT
OF THIS
PROGRAM

Outlet issue 013 (Outlet Microdrive Magazine,1988)
Covertape

WE HAVE
NO SCREENSHOT
OF THIS
PROGRAM

Outlet issue 014 (Outlet Microdrive Magazine,1988)
Covertape

WE HAVE
NO SCREENSHOT
OF THIS
PROGRAM

Outlet issue 015 (Outlet Microdrive Magazine,1988)
Covertape

WE HAVE
NO SCREENSHOT
OF THIS
PROGRAM

Outlet issue 016 (Outlet Microdrive Magazine,1988)
Covertape

WE HAVE
NO SCREENSHOT
OF THIS
PROGRAM

Outlet issue 017 (Outlet Microdrive Magazine,1989)
Covertape

WE HAVE
NO SCREENSHOT
OF THIS
PROGRAM

Outlet issue 018 (Outlet Microdrive Magazine,1989)
Covertape

WE HAVE
NO SCREENSHOT
OF THIS
PROGRAM

Outlet issue 019 (Outlet Microdrive Magazine,1989)
Covertape

WE HAVE
NO SCREENSHOT
OF THIS
PROGRAM

Outlet issue 020 (Outlet Microdrive Magazine,1989)
Covertape

WE HAVE
NO SCREENSHOT
OF THIS
PROGRAM

Outlet issue 021 (Outlet Microdrive Magazine,1989)
Covertape

WE HAVE
NO SCREENSHOT
OF THIS
PROGRAM

Outlet issue 022 (Outlet Microdrive Magazine,1989)
Covertape

WE HAVE
NO SCREENSHOT
OF THIS
PROGRAM

Outlet issue 023 (Outlet Microdrive Magazine,1989)
Covertape

WE HAVE
NO SCREENSHOT
OF THIS
PROGRAM

Outlet issue 024 (Outlet Microdrive Magazine,1989)
Covertape

WE HAVE
NO SCREENSHOT
OF THIS
PROGRAM

Outlet issue 025 (Outlet Microdrive Magazine,1989)
Covertape

WE HAVE
NO SCREENSHOT
OF THIS
PROGRAM

Outlet issue 026 (Outlet Microdrive Magazine,1989)
Covertape

WE HAVE
NO SCREENSHOT
OF THIS
PROGRAM

Outlet issue 027 (Outlet Microdrive Magazine,1989)
Covertape

WE HAVE
NO SCREENSHOT
OF THIS
PROGRAM

Outlet issue 028 (Outlet Microdrive Magazine,1989)
Covertape

WE HAVE
NO SCREENSHOT
OF THIS
PROGRAM

Outlet issue 029 (Outlet Microdrive Magazine,1990)
Covertape

WE HAVE
NO SCREENSHOT
OF THIS
PROGRAM

Outlet issue 030 (Outlet Microdrive Magazine,1990)
Covertape

WE HAVE
NO SCREENSHOT
OF THIS
PROGRAM

Outlet issue 031 (Outlet Microdrive Magazine,1990)
Covertape

WE HAVE
NO SCREENSHOT
OF THIS
PROGRAM

Outlet issue 032 (Outlet Microdrive Magazine,1990)
Covertape

WE HAVE
NO SCREENSHOT
OF THIS
PROGRAM

Outlet issue 033 (Outlet Microdrive Magazine,1990)
Covertape

WE HAVE
NO SCREENSHOT
OF THIS
PROGRAM

Outlet issue 034 (Outlet Microdrive Magazine,1990)
Covertape

WE HAVE
NO SCREENSHOT
OF THIS
PROGRAM

Outlet issue 035 (Outlet Microdrive Magazine,1990)
Covertape

WE HAVE
NO SCREENSHOT
OF THIS
PROGRAM

Outlet issue 036 (Outlet Microdrive Magazine,1990)
Covertape

WE HAVE
NO SCREENSHOT
OF THIS
PROGRAM

Outlet issue 037 (Outlet Microdrive Magazine,1990)
Covertape

WE HAVE
NO SCREENSHOT
OF THIS
PROGRAM

Outlet issue 038 (Outlet Microdrive Magazine,1990)
Covetape

WE HAVE
NO SCREENSHOT
OF THIS
PROGRAM

Outlet issue 039 (Outlet Microdrive Magazine,1990)
Covetape

WE HAVE
NO SCREENSHOT
OF THIS
PROGRAM

Outlet issue 040 (Outlet Microdrive Magazine,1990)
Covetape

WE HAVE
NO SCREENSHOT
OF THIS
PROGRAM

Outlet issue 041 (Outlet Microdrive Magazine,1991)
Covetape

WE HAVE
NO SCREENSHOT
OF THIS
PROGRAM

Outlet issue 042 (Outlet Microdrive Magazine,1991)
Covetape

WE HAVE
NO SCREENSHOT
OF THIS
PROGRAM

Outlet issue 043 (Outlet Microdrive Magazine,1991)
Covetape

WE HAVE
NO SCREENSHOT
OF THIS
PROGRAM

Outlet issue 044 (Outlet Microdrive Magazine,1991)
Covetape

WE HAVE
NO SCREENSHOT
OF THIS
PROGRAM

Outlet issue 045 (Outlet Microdrive Magazine,1991)
Covetape

WE HAVE
NO SCREENSHOT
OF THIS
PROGRAM

Outlet issue 046 (Outlet Microdrive Magazine,1991)
Covetape

WE HAVE
NO SCREENSHOT
OF THIS
PROGRAM

Outlet issue 047 (Outlet Microdrive Magazine,1991)
Covetape

WE HAVE
NO SCREENSHOT
OF THIS
PROGRAM

Outlet issue 048 (Outlet Microdrive Magazine,1991)
Covetape

WE HAVE
NO SCREENSHOT
OF THIS
PROGRAM

Outlet issue 049 (Outlet Microdrive Magazine,1991)
Covetape

WE HAVE
NO SCREENSHOT
OF THIS
PROGRAM

Outlet issue 050 (Outlet Microdrive Magazine,1991)
Covetape

WE HAVE
NO SCREENSHOT
OF THIS
PROGRAM

Outlet issue 051 (Outlet Microdrive Magazine,1991)
Covetape

WE HAVE
NO SCREENSHOT
OF THIS
PROGRAM

Outlet issue 052 (Outlet Microdrive Magazine,1991)
Covetape

WE HAVE
NO SCREENSHOT
OF THIS
PROGRAM

Outlet issue 053 (Outlet Microdrive Magazine, 1992)
Covetape

WE HAVE
NO SCREENSHOT
OF THIS
PROGRAM

Outlet issue 054 (Outlet Microdrive Magazine, 1992)
Covetape

WE HAVE
NO SCREENSHOT
OF THIS
PROGRAM

Outlet issue 055 (Outlet Microdrive Magazine, 1992)
Covetape

WE HAVE
NO SCREENSHOT
OF THIS
PROGRAM

Outlet issue 056 (Outlet Microdrive Magazine, 1992)
Covetape

WE HAVE
NO SCREENSHOT
OF THIS
PROGRAM

Outlet issue 057 (Outlet Microdrive Magazine, 1992)
Covetape

WE HAVE
NO SCREENSHOT
OF THIS
PROGRAM

Outlet issue 058 (Outlet Microdrive Magazine, 1992)
Covetape

WE HAVE
NO SCREENSHOT
OF THIS
PROGRAM

Outlet issue 059 (Outlet Microdrive Magazine, 1992)
Covetape

WE HAVE
NO SCREENSHOT
OF THIS
PROGRAM

Outlet issue 060 (Outlet Microdrive Magazine, 1992)
Covetape

WE HAVE
NO SCREENSHOT
OF THIS
PROGRAM

Outlet issue 061 (Outlet Microdrive Magazine, 1992)
Covetape

WE HAVE
NO SCREENSHOT
OF THIS
PROGRAM

Outlet issue 062 (Outlet Microdrive Magazine, 1992)
Covetape

WE HAVE
NO SCREENSHOT
OF THIS
PROGRAM

Outlet issue 063 (Outlet Microdrive Magazine, 1992)
Covetape

WE HAVE
NO SCREENSHOT
OF THIS
PROGRAM

Outlet issue 064 (Outlet Microdrive Magazine, 1992)
Covetape

WE HAVE
NO SCREENSHOT
OF THIS
PROGRAM

Outlet issue 065 (Outlet Microdrive Magazine, 1993)
Covetape

WE HAVE
NO SCREENSHOT
OF THIS
PROGRAM

Outlet issue 066 (Outlet Microdrive Magazine, 1993)
Covetape

WE HAVE
NO SCREENSHOT
OF THIS
PROGRAM

Outlet issue 067 (Outlet Microdrive Magazine, 1993)
Covetape

WE HAVE
NO SCREENSHOT
OF THIS
PROGRAM

Outlet issue 068 (Outlet Microdrive Magazine,1993)
Covertape

WE HAVE
NO SCREENSHOT
OF THIS
PROGRAM

Outlet issue 069 (Outlet Microdrive Magazine,1993)
Covertape

WE HAVE
NO SCREENSHOT
OF THIS
PROGRAM

Outlet issue 070 (Outlet Microdrive Magazine,1993)
Covertape

WE HAVE
NO SCREENSHOT
OF THIS
PROGRAM

Outlet issue 071 (Outlet Microdrive Magazine,1993)
Covertape

WE HAVE
NO SCREENSHOT
OF THIS
PROGRAM

Outlet issue 072 (Outlet Microdrive Magazine,1993)
Covertape

WE HAVE
NO SCREENSHOT
OF THIS
PROGRAM

Outlet issue 073 (Outlet Microdrive Magazine,1993)
Covertape

WE HAVE
NO SCREENSHOT
OF THIS
PROGRAM

Outlet issue 074 (Outlet Microdrive Magazine,1993)
Covertape

WE HAVE
NO SCREENSHOT
OF THIS
PROGRAM

Outlet issue 075 (Outlet Microdrive Magazine,1993)
Covertape

WE HAVE
NO SCREENSHOT
OF THIS
PROGRAM

Outlet issue 076 (Outlet Microdrive Magazine,1993)
Covertape

WE HAVE
NO SCREENSHOT
OF THIS
PROGRAM

Outlet issue 077 (Outlet Microdrive Magazine,1994)
Covertape

WE HAVE
NO SCREENSHOT
OF THIS
PROGRAM

Outlet issue 078 (Outlet Microdrive Magazine,1994)
Covertape

WE HAVE
NO SCREENSHOT
OF THIS
PROGRAM

Outlet issue 079 (Outlet Microdrive Magazine,1994)
Covertape

WE HAVE
NO SCREENSHOT
OF THIS
PROGRAM

Outlet issue 080 (Outlet Microdrive Magazine,1994)
Covertape

WE HAVE
NO SCREENSHOT
OF THIS
PROGRAM

Outlet issue 081 (Outlet Microdrive Magazine,1994)
Covertape

WE HAVE
NO SCREENSHOT
OF THIS
PROGRAM

Outlet issue 082 (Outlet Microdrive Magazine,1994)
Covertape

WE HAVE
NO SCREENSHOT
OF THIS
PROGRAM

Outlet issue 083 (Outlet Microdrive Magazine, 1994)
Covetape

WE HAVE
NO SCREENSHOT
OF THIS
PROGRAM

Outlet issue 084 (Outlet Microdrive Magazine, 1994)
Covetape

WE HAVE
NO SCREENSHOT
OF THIS
PROGRAM

Outlet issue 085 (Outlet Microdrive Magazine, 1994)
Covetape

WE HAVE
NO SCREENSHOT
OF THIS
PROGRAM

Outlet issue 086 (Outlet Microdrive Magazine, 1994)
Covetape

WE HAVE
NO SCREENSHOT
OF THIS
PROGRAM

Outlet issue 087 (Outlet Microdrive Magazine, 1994)
Covetape

WE HAVE
NO SCREENSHOT
OF THIS
PROGRAM

Outlet issue 088 (Outlet Microdrive Magazine, 1994)
Covetape

WE HAVE
NO SCREENSHOT
OF THIS
PROGRAM

Outlet issue 089 (Outlet Microdrive Magazine, 1995)
Covetape

WE HAVE
NO SCREENSHOT
OF THIS
PROGRAM

Outlet issue 090 (Outlet Microdrive Magazine, 1995)
Covetape

WE HAVE
NO SCREENSHOT
OF THIS
PROGRAM

Outlet issue 091 (Outlet Microdrive Magazine, 1995)
Covetape

WE HAVE
NO SCREENSHOT
OF THIS
PROGRAM

Outlet issue 092 (Outlet Microdrive Magazine, 1995)
Covetape

WE HAVE
NO SCREENSHOT
OF THIS
PROGRAM

Outlet issue 093 (Outlet Microdrive Magazine, 1995)
Covetape

WE HAVE
NO SCREENSHOT
OF THIS
PROGRAM

Outlet issue 094 (Outlet Microdrive Magazine, 1995)
Covetape

WE HAVE
NO SCREENSHOT
OF THIS
PROGRAM

Outlet issue 095 (Outlet Microdrive Magazine, 1995)
Covetape

WE HAVE
NO SCREENSHOT
OF THIS
PROGRAM

Outlet issue 096 (Outlet Microdrive Magazine, 1995)
Covetape

WE HAVE
NO SCREENSHOT
OF THIS
PROGRAM

Outlet issue 097 (Outlet Microdrive Magazine, 1995)
Covetape

WE HAVE
NO SCREENSHOT
OF THIS
PROGRAM

Outlet issue 098 (Outlet Microdrive Magazine, 1995)
Covetape

WE HAVE
NO SCREENSHOT
OF THIS
PROGRAM

Outlet issue 099 (Outlet Microdrive Magazine, 1995)
Covetape

WE HAVE
NO SCREENSHOT
OF THIS
PROGRAM

Outlet issue 100 (Outlet Microdrive Magazine, 1995)
Covetape

WE HAVE
NO SCREENSHOT
OF THIS
PROGRAM

Outlet issue 101 (Outlet Microdrive Magazine, 1996)
Covetape

WE HAVE
NO SCREENSHOT
OF THIS
PROGRAM

Outlet issue 102 (Outlet Microdrive Magazine, 1996)
Covetape

WE HAVE
NO SCREENSHOT
OF THIS
PROGRAM

Outlet issue 103 (Outlet Microdrive Magazine, 1996)
Covetape

WE HAVE
NO SCREENSHOT
OF THIS
PROGRAM

Outlet issue 104 (Outlet Microdrive Magazine, 1996)
Covetape

WE HAVE
NO SCREENSHOT
OF THIS
PROGRAM

Outlet issue 105 (Outlet Microdrive Magazine, 1996)
Covetape

WE HAVE
NO SCREENSHOT
OF THIS
PROGRAM

Outlet issue 106 (Outlet Microdrive Magazine, 1996)
Covetape

WE HAVE
NO SCREENSHOT
OF THIS
PROGRAM

Outlet issue 107 (Outlet Microdrive Magazine, 1996)
Covetape

WE HAVE
NO SCREENSHOT
OF THIS
PROGRAM

Outlet issue 108 (Outlet Microdrive Magazine, 1996)
Covetape

WE HAVE
NO SCREENSHOT
OF THIS
PROGRAM

Outlet issue 109 (Outlet Microdrive Magazine, 1996)
Covetape

WE HAVE
NO SCREENSHOT
OF THIS
PROGRAM

Outlet issue 110 (Outlet Microdrive Magazine, 1996)
Covetape

WE HAVE
NO SCREENSHOT
OF THIS
PROGRAM

Outlet issue 111 (Outlet Microdrive Magazine, 1996)
Covetape

WE HAVE
NO SCREENSHOT
OF THIS
PROGRAM

Outlet issue 112 (Outlet Microdrive Magazine, 1996)
Covetape

WE HAVE
NO SCREENSHOT
OF THIS
PROGRAM

Outlet issue 113 (Outlet Microdrive Magazine, 1997)
Covetape

WE HAVE
NO SCREENSHOT
OF THIS
PROGRAM

Outlet issue 114 (Outlet Microdrive Magazine, 1997)
Covetape

WE HAVE
NO SCREENSHOT
OF THIS
PROGRAM

Outlet issue 115 (Outlet Microdrive Magazine, 1997)
Covetape

WE HAVE
NO SCREENSHOT
OF THIS
PROGRAM

Outlet issue 116 (Outlet Microdrive Magazine, 1997)
Covetape

WE HAVE
NO SCREENSHOT
OF THIS
PROGRAM

Outlet issue 117 (Outlet Microdrive Magazine, 1997)
Covetape

WE HAVE
NO SCREENSHOT
OF THIS
PROGRAM

Outlet issue 118 (Outlet Microdrive Magazine, 1997)
Covetape

WE HAVE
NO SCREENSHOT
OF THIS
PROGRAM

Outlet issue 119 (Outlet Microdrive Magazine, 1997)
Covetape

WE HAVE
NO SCREENSHOT
OF THIS
PROGRAM

Outlet issue 120 (Outlet Microdrive Magazine, 1997)
Covetape

WE HAVE
NO SCREENSHOT
OF THIS
PROGRAM

Outlet issue 121 (Outlet Microdrive Magazine, 1997)
Covetape

WE HAVE
NO SCREENSHOT
OF THIS
PROGRAM

Outlet issue 122 (Outlet Microdrive Magazine, 1997)
Covetape

WE HAVE
NO SCREENSHOT
OF THIS
PROGRAM

Outlet issue 123 (Outlet Microdrive Magazine, 1997)
Covetape

WE HAVE
NO SCREENSHOT
OF THIS
PROGRAM

Outlet issue 124 (Outlet Microdrive Magazine, 1997)
Covetape

WE HAVE
NO SCREENSHOT
OF THIS
PROGRAM

Outlet issue 125 (Outlet Microdrive Magazine, 1998)
Covetape

WE HAVE
NO SCREENSHOT
OF THIS
PROGRAM

Outlet issue 126 (Outlet Microdrive Magazine, 1998)
Covetape

WE HAVE
NO SCREENSHOT
OF THIS
PROGRAM

Outlet issue 127 (Outlet Microdrive Magazine, 1998)
Covetape

WE HAVE
NO SCREENSHOT
OF THIS
PROGRAM

Outlet issue 128 (Outlet Microdrive Magazine, 1998)
Covetape

WE HAVE
NO SCREENSHOT
OF THIS
PROGRAM

Outlet issue 129 (Outlet Microdrive Magazine, 1998)
Covetape

WE HAVE
NO SCREENSHOT
OF THIS
PROGRAM

Outlet issue 130 (Outlet Microdrive Magazine, 1998)
Covetape

WE HAVE
NO SCREENSHOT
OF THIS
PROGRAM

Outlet issue 131 (Outlet Microdrive Magazine, 1998)
Covetape

WE HAVE
NO SCREENSHOT
OF THIS
PROGRAM

Outlet issue 132 (Outlet Microdrive Magazine, 1998)
Covetape

WE HAVE
NO SCREENSHOT
OF THIS
PROGRAM

Outlet issue 133 (Outlet Microdrive Magazine, 1998)
Covetape

WE HAVE
NO SCREENSHOT
OF THIS
PROGRAM

Outlet issue 134 (Outlet Microdrive Magazine, 1998)
Covetape

WE HAVE
NO SCREENSHOT
OF THIS
PROGRAM

Outlet issue 135 (Outlet Microdrive Magazine, 1998)
Covetape

WE HAVE
NO SCREENSHOT
OF THIS
PROGRAM

Outlet issue 136 (Outlet Microdrive Magazine, 1998)
Covetape

WE HAVE
NO SCREENSHOT
OF THIS
PROGRAM

Outlet issue 137 (Outlet Microdrive Magazine, 1999)
Covetape

WE HAVE
NO SCREENSHOT
OF THIS
PROGRAM

Outlet issue 138 (Outlet Microdrive Magazine, 1999)
Covetape

WE HAVE
NO SCREENSHOT
OF THIS
PROGRAM

Outlet issue 139 (Outlet Microdrive Magazine, 1999)
Covetape

WE HAVE
NO SCREENSHOT
OF THIS
PROGRAM

Outlet issue 140 (Outlet Microdrive Magazine, 1999)
Covetape

WE HAVE
NO SCREENSHOT
OF THIS
PROGRAM

Outlet issue 141 (Outlet Microdrive Magazine, 1999)
Covetape

WE HAVE
NO SCREENSHOT
OF THIS
PROGRAM

Outlet issue 142 (Outlet Microdrive Magazine, 1999)
Covetape

WE HAVE
NO SCREENSHOT
OF THIS
PROGRAM

Outlet issue 143 (Outlet Microdrive Magazine,1999)
Covertape



Outlet issue 144 (Outlet Microdrive Magazine,1999)
Covertape



Outlet issue 145 (Outlet Microdrive Magazine,1999)
Covertape



Outlet issue 146 (Outlet Microdrive Magazine,1999)
Covertape



Outlet issue 147 (Outlet Microdrive Magazine,1999)
Covertape



Outlet issue 148 (Outlet Microdrive Magazine,1999)
Covertape



Outline (Contrast Software,1983)
Arcade



Out of the Limelight (Zenobi Software,1992)
Text Adventure



Out of the Shadows (Mizar Computing,1984)
Arcade Adventure



Out of This World (Reaktor,1987)
Arcade



Out of This World Vol. 1 (The Guild,)
Compilation



Out of Time (Software Amaters,1991)
Scene Demo



Out of ZSL (TAD,1992)
Scene Demo



Out Run (US Gold Ltd,1988)
Arcade



Out Run Europa (US Gold Ltd,1991)
Arcade



Outworld (Sapphire Software,1986)
Strategy



Overdog (Mega-Soft [2],1989)
Text Adventure



Overkill (Atlantis Software Ltd,1988)
Arcade



Overlander (Elite Systems Ltd,1988)



Overload (Sinclair User,1985)

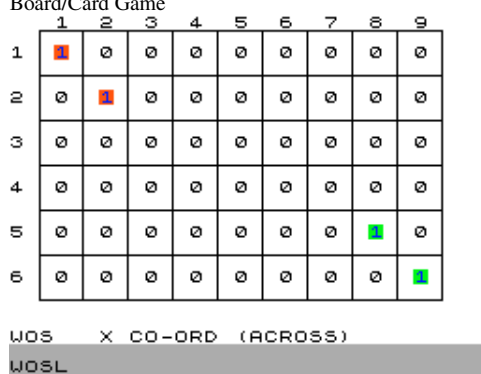

Overlord (CCS,1988)



Overlords (MC Lothlorien Ltd,1985)



Overscan Demo (Busy Software,1991)



Oversun 4K (Global Corporation,1998)

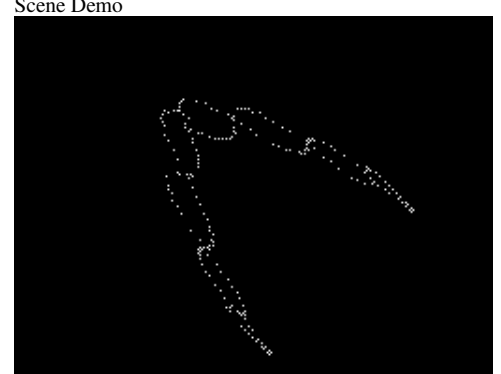

Over the Jumps (GDP Software,1985)



Over the Spectrum Cassette 1 (Melbourne House,1983)



Over the Spectrum Cassette 2 (Melbourne House,1983)



Over the Spectrum Cassette 3 (Melbourne House,1983)

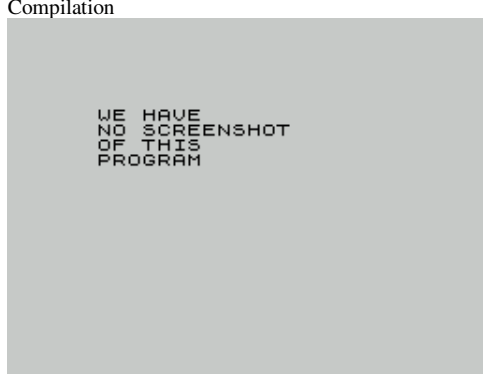

OWD vs NATO (Larri Group,1999)



Oxo, 3D (Oasis Software,1983)

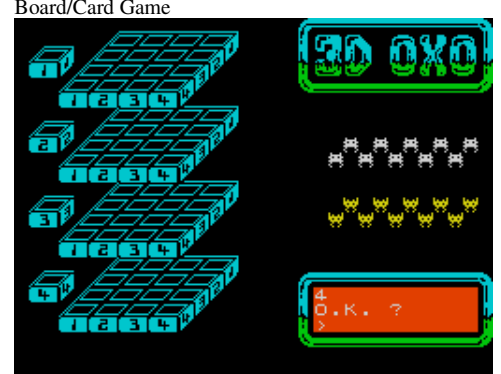

Ozone (Ignacio Prini Garcia,1989)
Music



O Zone, The (Compass Software,1986)
Text Adventure



Pack Angel Garcia Delgado (Grupo de Trabajo Software S.A.,1987) Compilation



Packhouse Pete (Spartan Software,1983)
Arcade

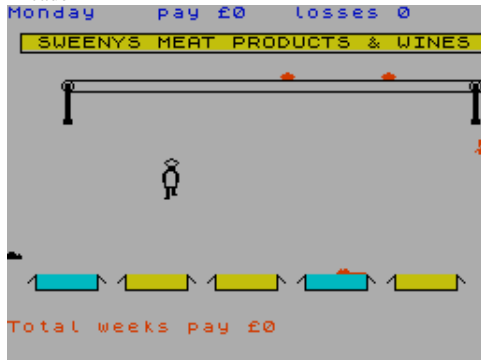

Pack of Aces (Paxman Promotions,1987)
Compilation



Ozone (Simon Roche,1990)
Arcade

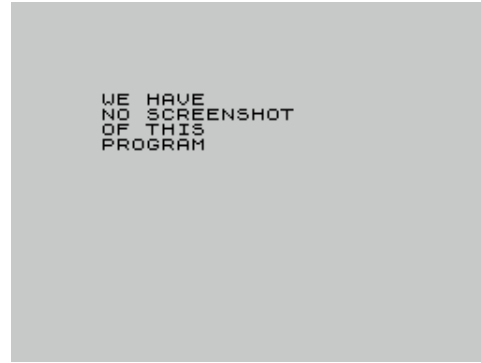

P-47 Thunderbolt (Firebird Software Ltd,1990)
Arcade



Pack Army Moves + Dustin (Dinamic Software,1987)
Compilation



Pack-Maker (Mixoft,1989)
Utility



Pack Regalo Sinclair +3 (Dinamic Software,1989)
Compilation



O Zone + Intruder Alert, The (Compass Software,1989)
Compilation



Pacific War (KW Software,1984)
Strategy

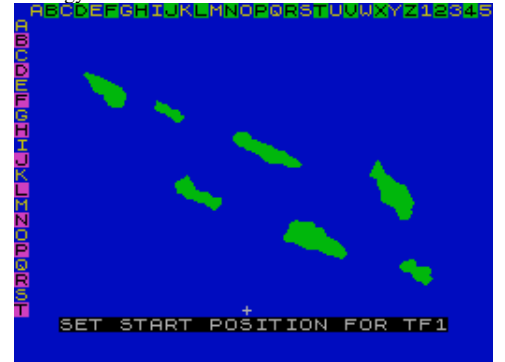

Pack Ferpecto (Compiler Software,2005)
Compilation

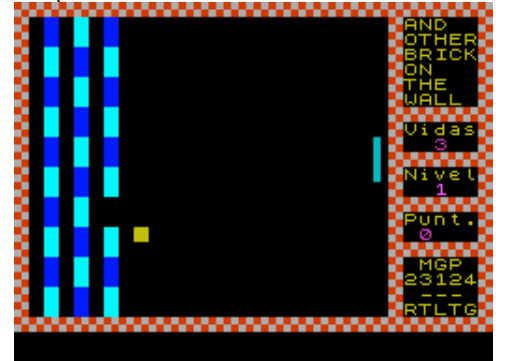

Pack Monstruo (Dinamic Software,1987)
Compilation



Pack Stilla (Rock'n'Soft,1995)
Arcade



Packy (A. Kollross,1985)
Arcade



Pacman (Anco Software Ltd,1983)
Arcade



Pacman 2: Razbunarea lui Phantom (SuperSoft [2],2001)
Arcade



Pacman Construction Set, The (Tweety Soft Ltd,1985)
Arcade Game Development Tool



Pacmanikf (Codex Software,1999)
Arcade



Pac-Land (Grandslam Entertainments Ltd/Quicksilva Ltd,1989) Arcade



Pac-Man (Atarisoft,1984)
Arcade



Pacman, 3D (Freddy Kristiansen,1983)
Arcade



Pac Man Game Pack (Program Direct,1982)
Arcade



Pacman's Revenge (Idem Soft,1988)
Arcade Adventure



Pac-Man (,)
Arcade

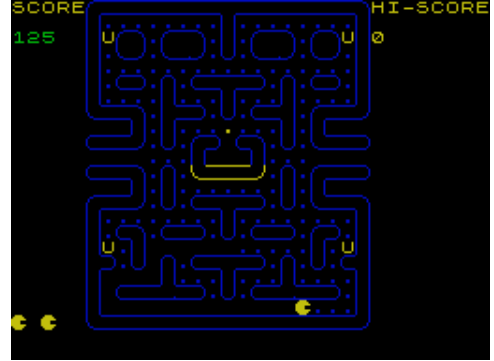

Pacman (SuperSoft [2],2000)
Arcade



Pacman 96 (Laszlo Nyitrai,1996)
Arcade



Pac-Mania (Grandslam Entertainments Ltd,1988)
Arcade

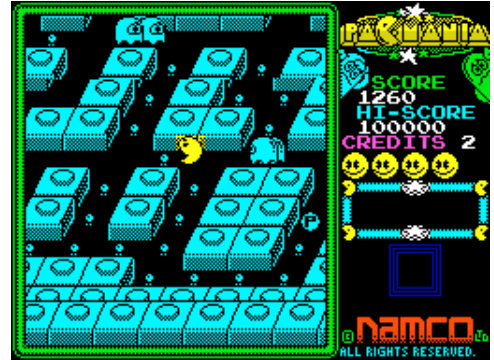

Paco Jones (Wanderer Soft,1987)
Arcade



Paddington and the Disappearing Ink (Collins Educational,1983) Educational

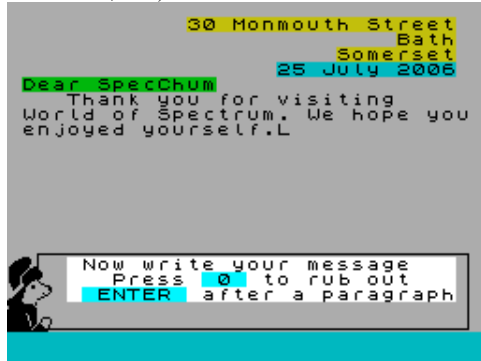

Paddington's Problem Picture (Collins Educational,1983) Educational

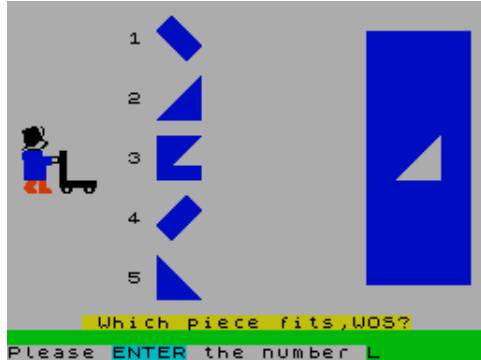

Paddy (Dollarsoft,1984) Arcade



Paganini Horror (Olive-Branch,1998) Arcade

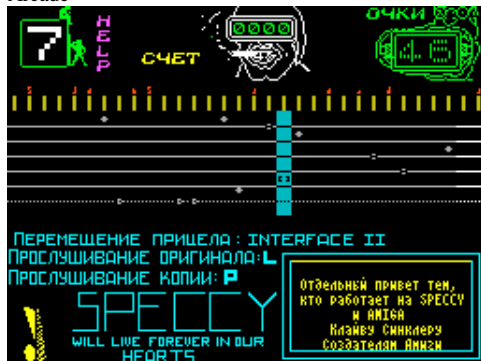

Page System Word Processor (Sinclair User,1992) Utility



Paddington's Early Visit (Collins Educational,1983) Educational

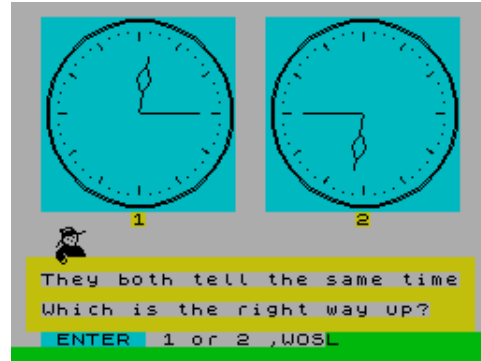

Paddington's Shopping Mix-Up (Collins Educational,1983) Educational



Paddywack (Activision Inc,1987) Arcade



Pageant of Life (Softfirm,1987) Board/Card Game



Pains of a Window Cleaner, The (Shulwater Ltd,1985) Text Adventure



Paddington's Garden Game (Collins Educational,1984) Arcade Adventure



Paddington to Exeter (Dee-Kay Systems,1990) Simulation



Pad Painter (Green Fish Software Enterprise,1984) Arcade



Page Maker (Softechnics,1986) Utility: Word Processor

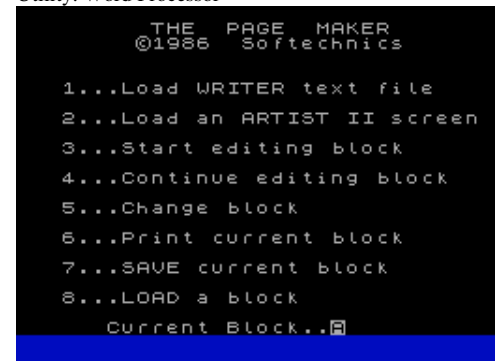

Paint, 3D (Roland G. Hulsmann,1983) Utility: Drawing

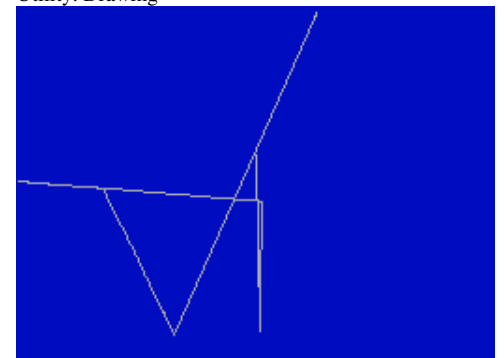

Paintbox (Print'n'Plotter Productions,1983)
Utility: Drawing

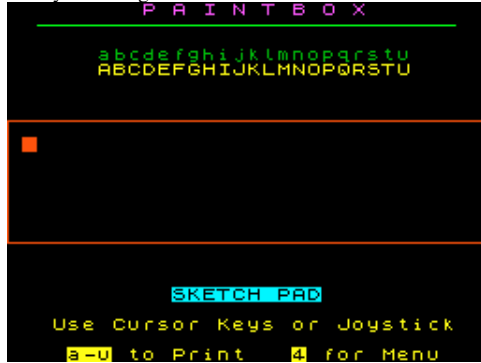

Paint-Demo (Profisoft,)



Painter, 3D (CDS Microsystems,1984)
Arcade

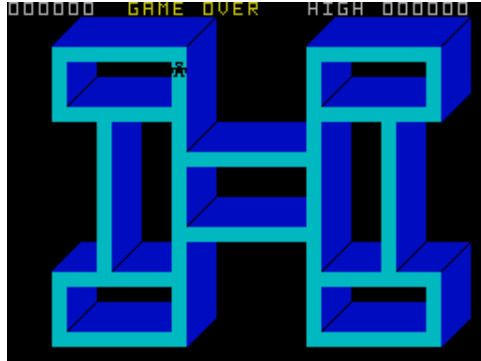

Paintpot (.1985)
Utility: Drawing



Palace Hotel (Carlos Garcia de Paredes Ucero,1990)
Text Adventure

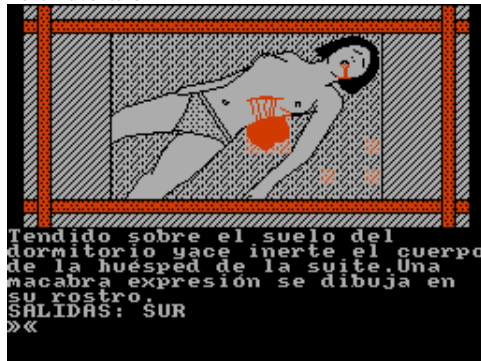

Painteraze! (5D Software,1984)
Arcade

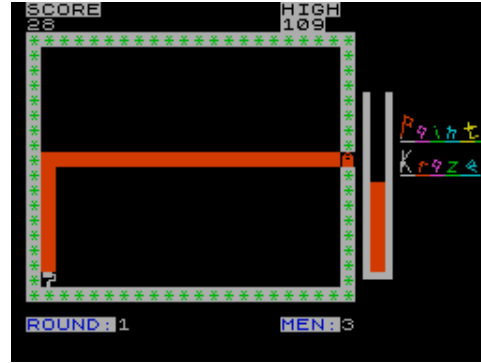

Painter (A'n'F Software,1983)
Arcade

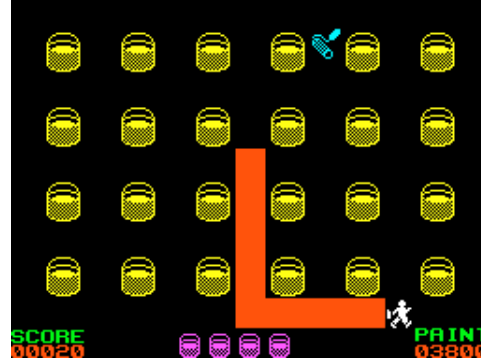

Painter 58, The (Cesar Hernandez Bano,1993)
Utility

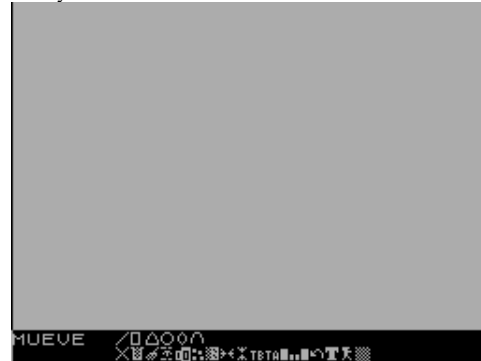

Pajaros de Bangkok, Los (Dinamic Software,1988)
Text Adventure



Palomas (MicroHobby,1985)
Arcade



Painteraze! + Battle of Broken Bridge + Icarus Igginbotham, The (5D Software,1984) Compilation



Painter (C-Tech,1983)
Arcade



Paint Plus (Print'n'Plotter Productions,1985)
Utility: Drawing

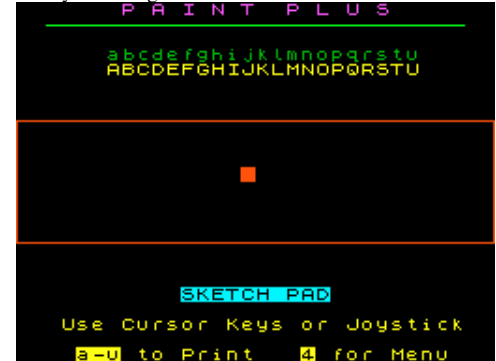

Pakacuda (Rabbit Software Ltd,1983)
Arcade

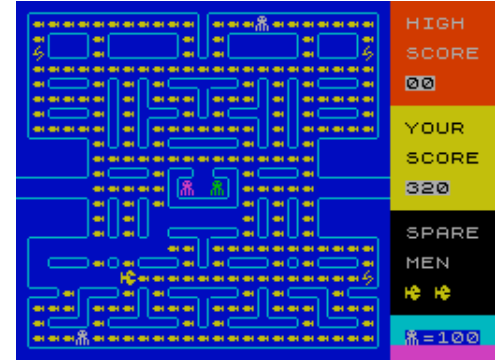

Panama Joe (Parker Software/Sinclair Research Ltd,1984)
Arcade

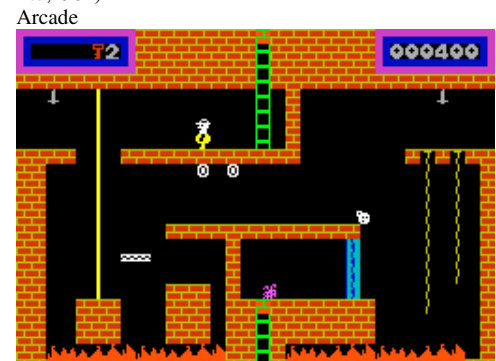

Pancake (Lodz City Coders,1991)
Scene Demo



Pandora (.)
Arcade



Pan-Galactic Cocktail Mixer (Brian Gaff.)
Utility



Panic (Ian Collier,1984)
Arcade

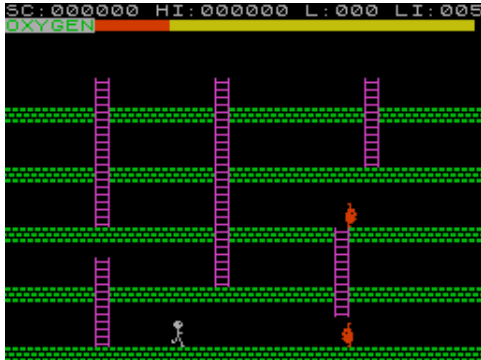

Panic Dizzy (Code Masters Ltd,1991)
Arcade



Pandemia (OCTOCOM,2006)
Arcade



Pane Damage (Anik Microsystems,1984)
Arcade



Pangolin (.)
Simulation

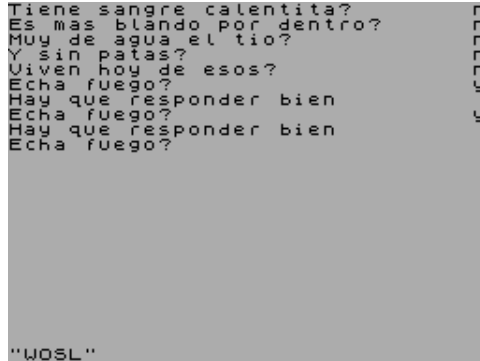

Panic (Mikro-Gen Ltd,1983)
Arcade

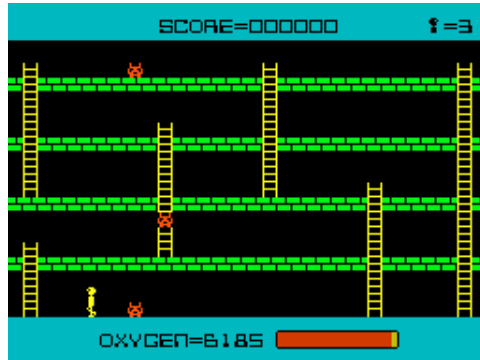

Panic Island (C-Tech,1982)
Arcade

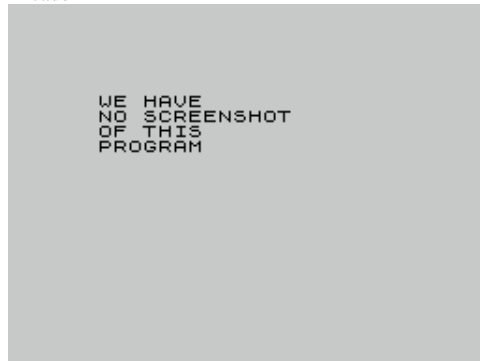

Pandemonia (CRL Group PLC,1983)
Arcade



Pang (Ocean Software Ltd,1990)
Arcade



Pangolins (Sinclair Research Ltd,1982)
Simulation

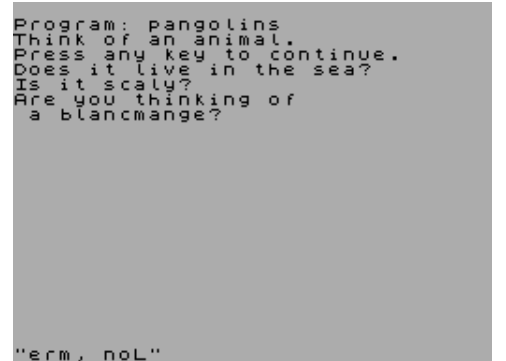

Panic (PSS,1983)
Arcade



Panic Stations (Gremlin Graphics Software Ltd,1989)
Arcade



Pantagruel (Universum,1988)
Utility: Copier

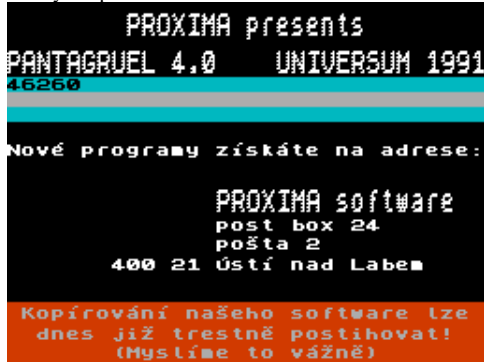

Panther (Mastertronic Ltd,1989)
Arcade

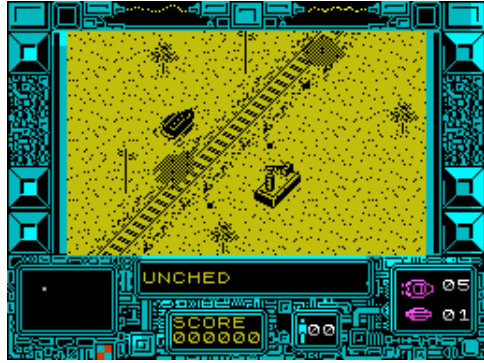

Panzer Schlacht (Steffen Schader,)
Arcade

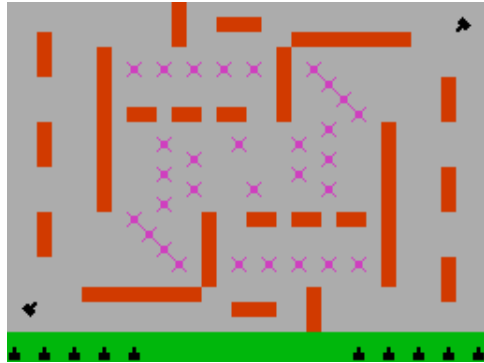

Paper Book (J. Soft,)
Compilation



Paper Chase (Orijon Software,)
Arcade

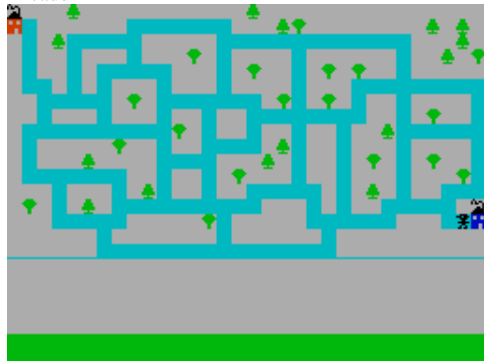

Pantalla (MicroHobby,1985)
Utility



Panzadrome (Ariolasoft UK Ltd,1985)
Arcade

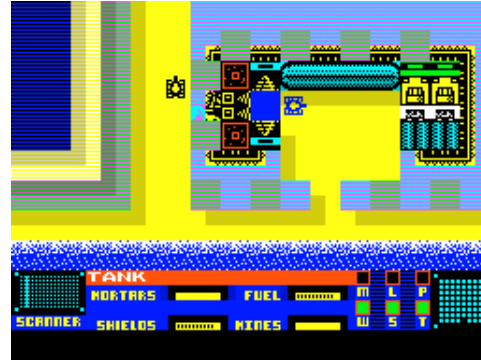

Papa Dance (Arston,1987)
Arcade



Paperboy (Elite Systems Ltd,1986)
Arcade



Paperound (E. Marchant,1986)
Text Adventure

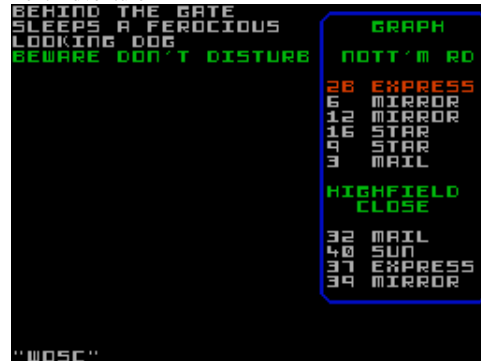

Pantallas (MicroHobby,1985)
Utility

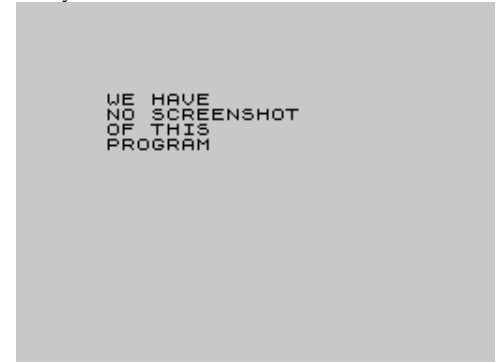

Panzer Attack (MC Lothlorien Ltd,1984)
Strategy

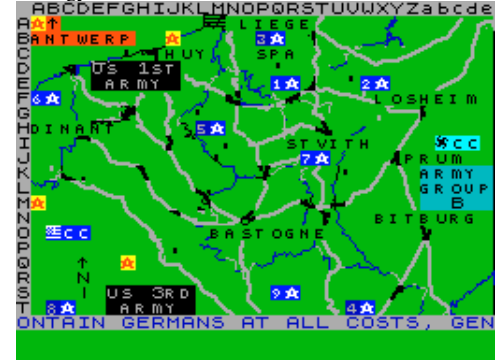

Papa Noel (Pepsi Soft,1991)
Text Adventure



Paperboy 2 (Mindscape International Inc,1992)
Arcade



Para Academy (Zeppelin Games Ltd,1990)
Sport



Para Assault Course (Zeppelin Games Ltd,1988)
Arcade

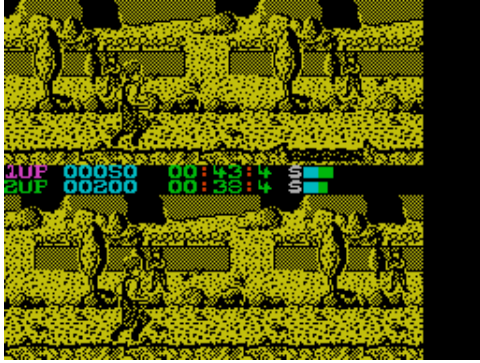

Paracaidista (Microparadise Software,1984)
Arcade



Paradise Connection, The (Birdseed Software,1986)
Text Adventure

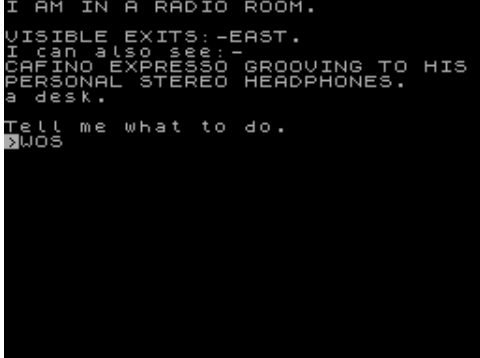

Paradox (Runesoft,1984)
Text Adventure

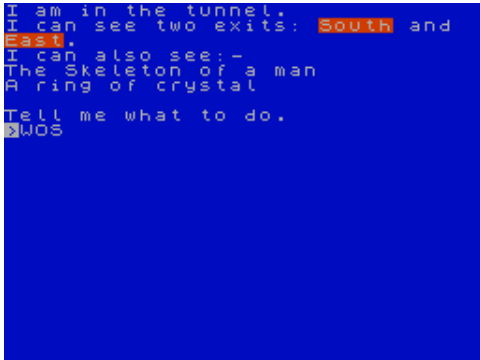

Paragram (Elephant Software,1983)
Board/Card Game

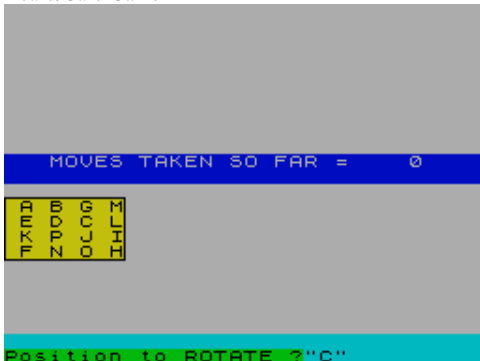

Parabel (JWE Software,)
Educational

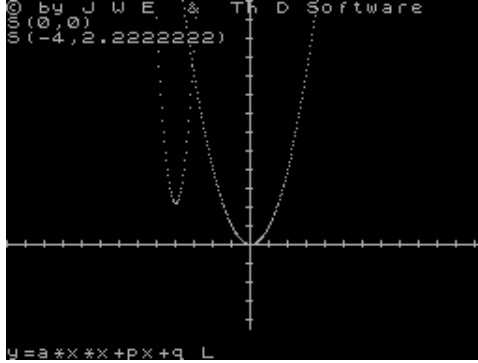

Parachute Drop (Sinclair Programs,1983)
Arcade

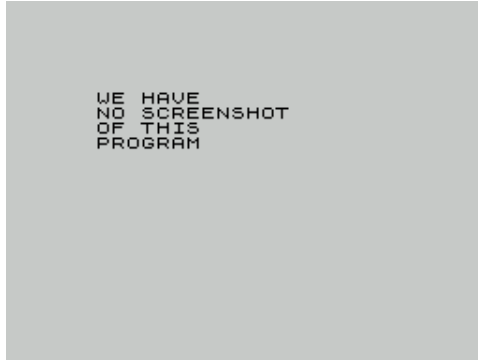

Paradise in Microdot (Automata UK Ltd,1985)
Text Adventure



Paradox Angle (Paradox,1999)
Board/Card Game

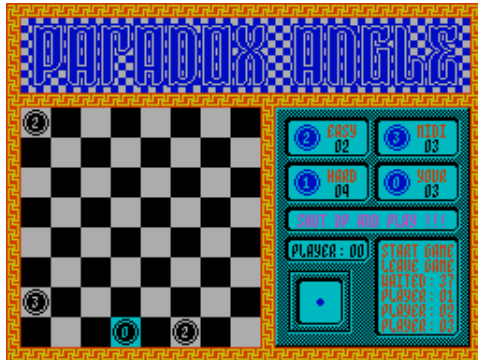

Paranoia (SCP '86,1986)
Text Adventure



Parabola (Firebird Software Ltd,1987)
Arcade



Paradise Cafe (Damatta,1985)
Arcade



Paradise Lost (Digital Reality [2],1996)
Arcade Adventure

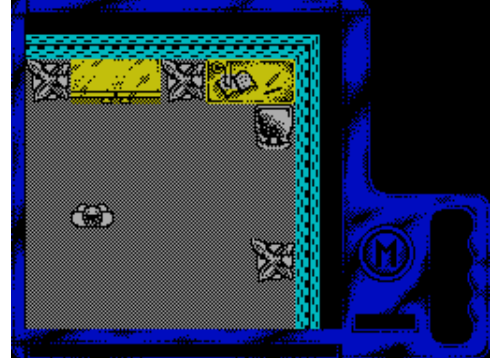

Pararoids (Mikro-Gen Ltd,1984)
Arcade



Paranoia Complex, The (Gremlin Graphics Software Ltd,1989)
Arcade

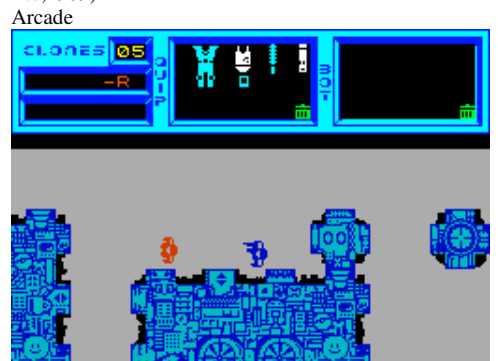

Paranoid Pete (Ubik Software,1984)

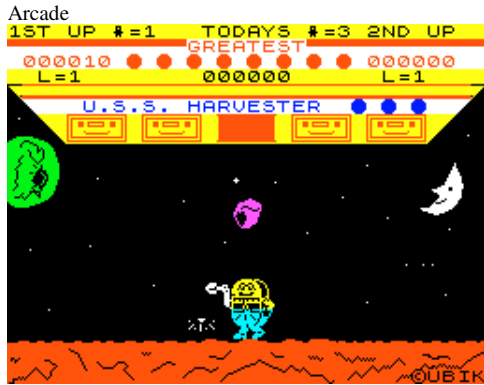

Paratroopers (Rabbit Software Ltd,1983)



Pareja Ideal, La (MicroHobby,1985)



Paris Dakar (Zigurat Software,1988)



Paris Trip (Garland Software,1983)

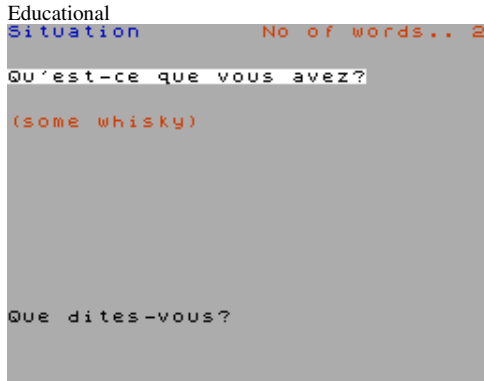

Parap Shock (MicroHobby,1989)



Parchis (Investronica S.A.,1984)

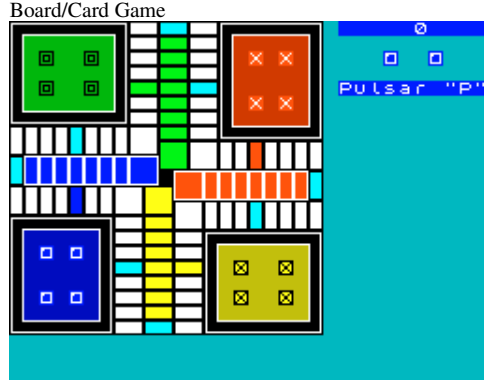

Parejas (Software Center S.A.,1984)



Parisian Knights (Abstract Concepts,1989)



Park Patrol (Firebird Software Ltd,1987)



Paras (MC Lothlorien Ltd,1983)

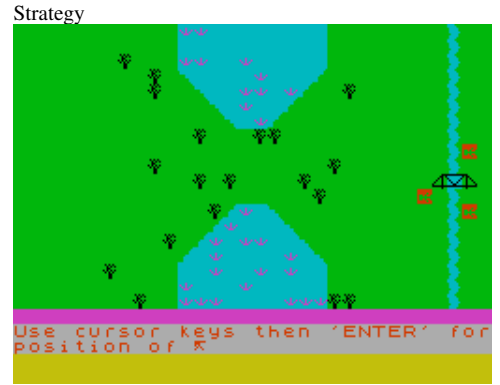

Parchis (MicroHobby,1985)



Parejas (Software Editores,1986)



Paris to Dakar (Code Masters Ltd,1991)

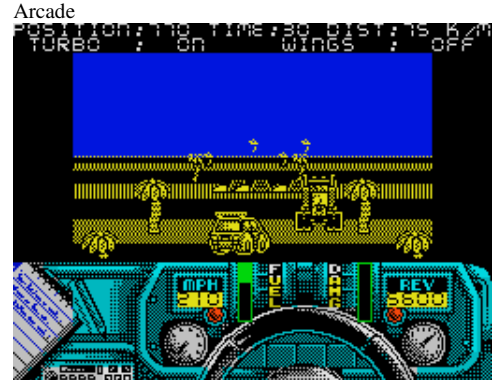

Parole (Northern Underground,1992)



Paroxym (Dream Makers Software,)
Scene Demo

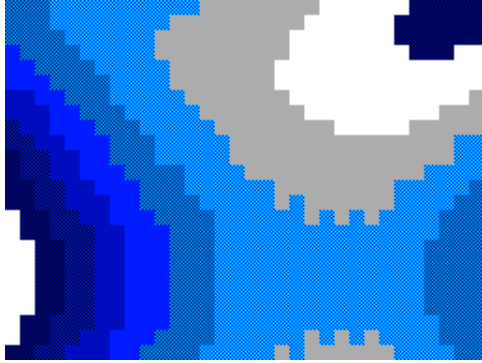

Pasaje (Microparadise Software,1984)
Arcade



Pascal's Triangle (Chalksoft Ltd,1983)
Educational



Pasion por el Water (Pepsi Soft,1991)
Text Adventure

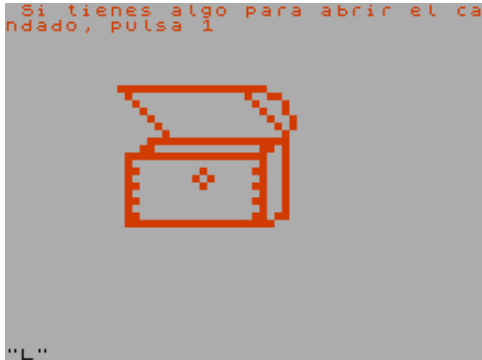

Passiance (Digital Reality [2],1996)
Board/Card Game

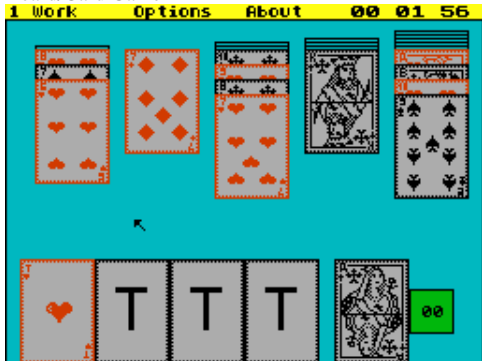

Party Program (JWE Software,)
Simulation



Pascal (GCE Tutoring,1984)
Educational



Paseman (Pasesoft,1984)
Arcade



Paso, El (Ciudadela Software,1987)
Arcade

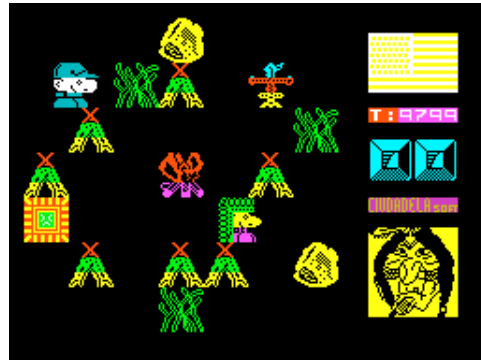

Passiance (D. Rykov,1995)
Board/Card Game

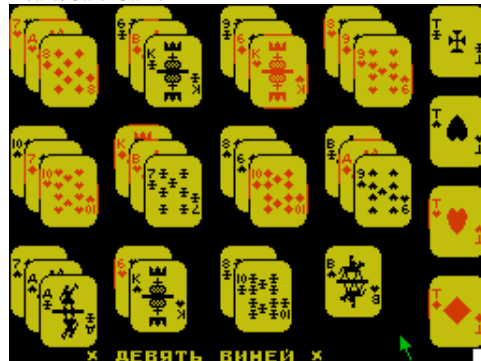

Pasdisk (MicroHobby,1990)
Utility: Copier



Pascal Compiler (.)
Utility: Programming



Pasians (Regent Software,1991)
Board/Card Game

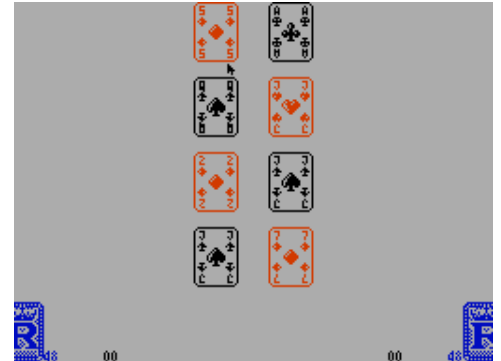

Passage 3D (Cathedral Software,1983)
Arcade



Passing Shot (Image Works,1988)
Sport



Pass Your Driving Test (Audiogenic Software Ltd,1986)

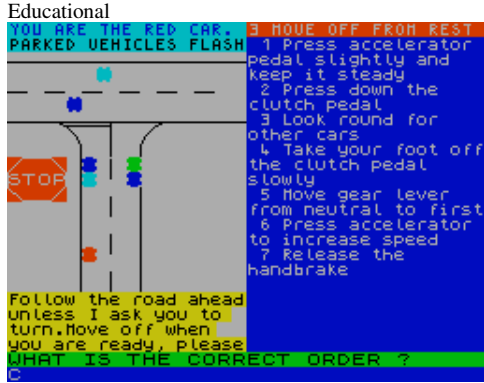

Pastime II (Kuznetsov,1993)
Board/Card Game

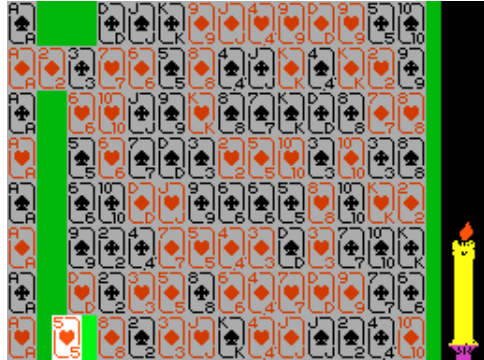

Pastor, El (MicroHobby,1985)
Arcade



Patagoras issue 1 (Ediciones SM S.A.,1985)
Covertape

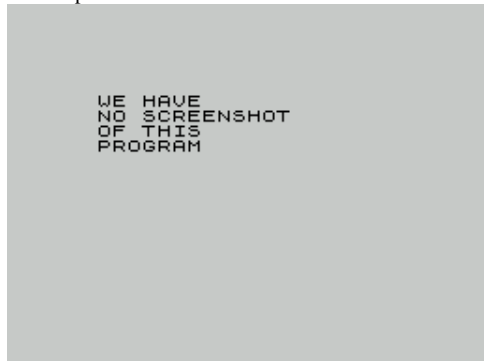

Patagoras issue 4 (Ediciones SM S.A.,1985)
Covertape



Pasteman Pat (Silverbird Software Ltd,1989)
Board/Card Game



Pastimes 1 (Sinclair Research Ltd,1982)
Compilation



Past the Cyclops Lair (Matthew Wilson.)
Text Adventure



Patagoras issue 2 (Ediciones SM S.A.,1985)
Covertape



Patagoras issue 5 (Ediciones SM S.A.,1985)
Covertape



Pastime (Kuznetsov,1993)
Board/Card Game



Pastimes 2 (Sinclair Research Ltd,1982)
Compilation



Pasyance (V. Cheprasov,1999)
Board/Card Game

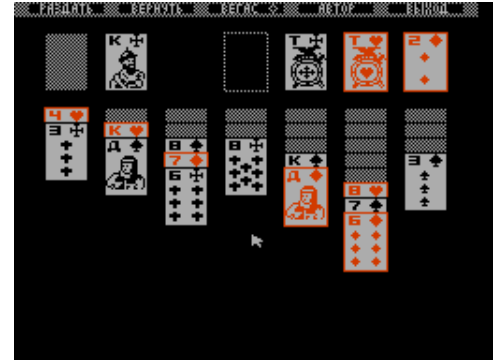

Patagoras issue 3 (Ediciones SM S.A.,1985)
Covertape



Patagoras issue 6 (Ediciones SM S.A.,1985)
Covertape



Patch, The (Gilsoft International,1985)
Text Adventure Development Tool

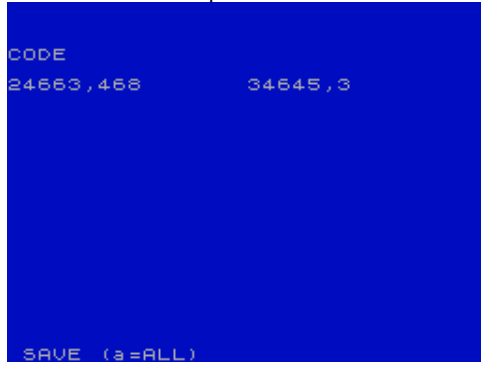

Patience (Evgeny Bystrov,)
Board/Card Game



Pattern Display (Spectrum Computing,1985)
Utility



Patufet (MicroHobby,1986)
Arcade

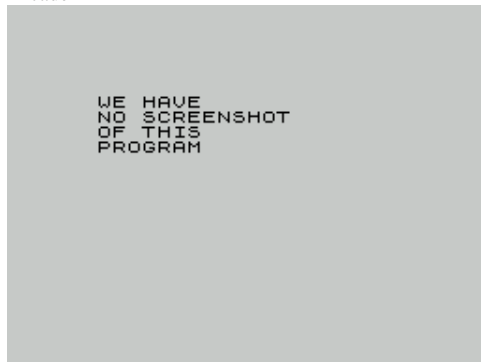

Paul Woakes' Mercenary Compendium (Novagen
Software Ltd,1988) Compilation

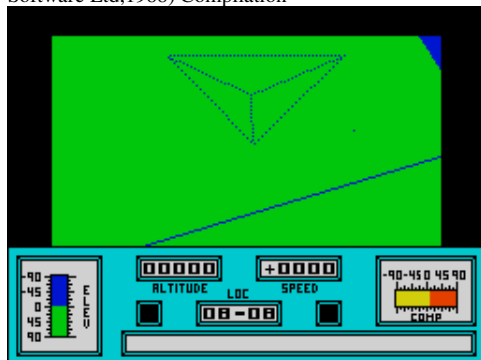

Pathetic Pablo Bros, The (Your Sinclair,1993)
Arcade

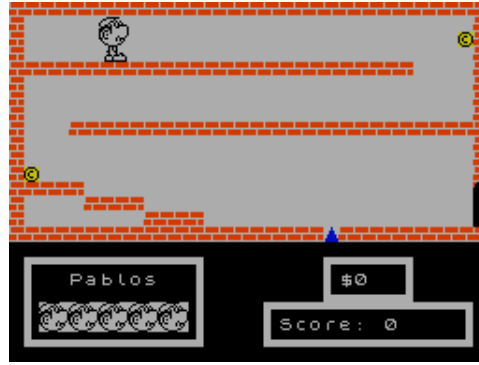

Patience (Haven Hardware,1983)
Board/Card Game



Patterns (.)
Demo

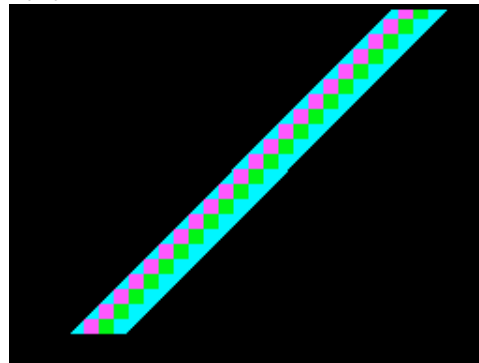

PAUL (Jaysoft,1983)
Utility



Pawnchess (Contrast Software,1983)
Board/Card Game



Path Finder (Widgit Software Ltd,1983)
Arcade

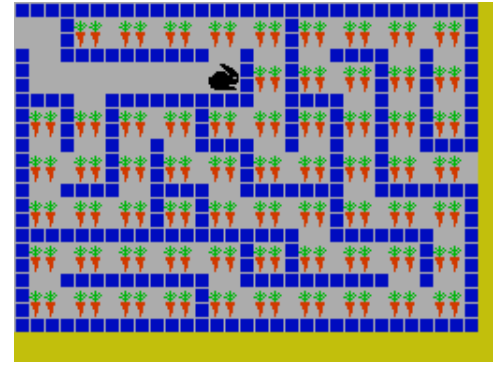

Pattern (.)
Utility: Drawing

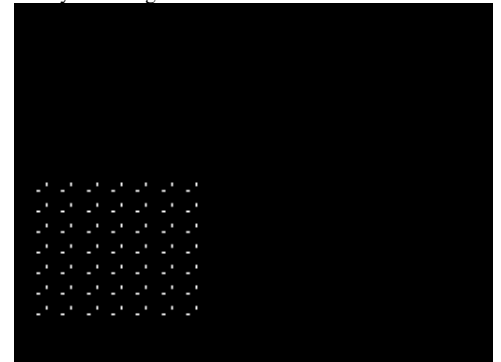

Pat the Postman (Mikro-Gen Ltd,1983)
Arcade

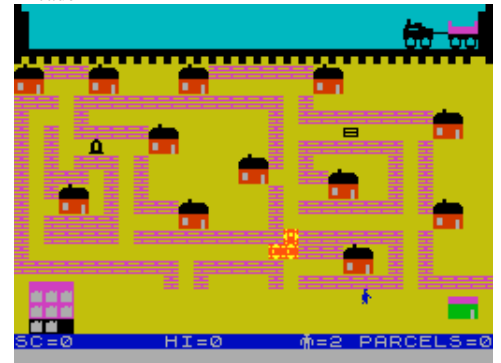

Paul and the Lost Chalice (CRC Software,1988)
Arcade

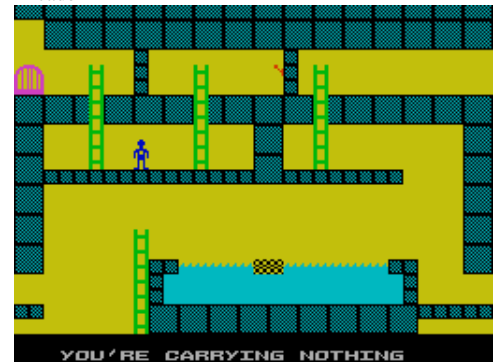

Pawns of War (Leslie Floyd,1989)
Text Adventure



Pawns of War 1 + 2 (Zenobi Software,1989)
Compilation



Pay-Off, The (Bignose Software,1985)
Text Adventure



PCB Designer (Kemsoft,1984)
Utility



PD Tape 01: Spectrum Comms (B.G. Services,1990)
Utility



Pedro (Imagine Software Ltd,1984)
Arcade



Pawn, The (Rainbird Software Ltd,1986)
Text Adventure



Payroll (Hilderbay Ltd,1983)
Utility

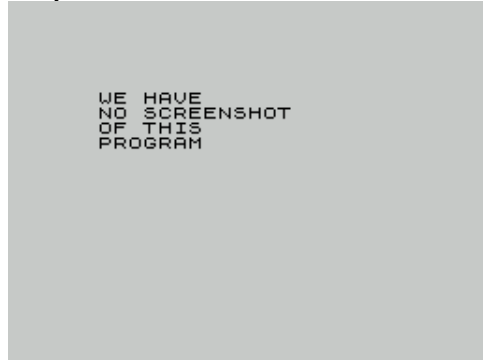

PCuk's Enter (Mythos,1998)
Arcade



PD Tape 02 (B.G. Services,)
Utility

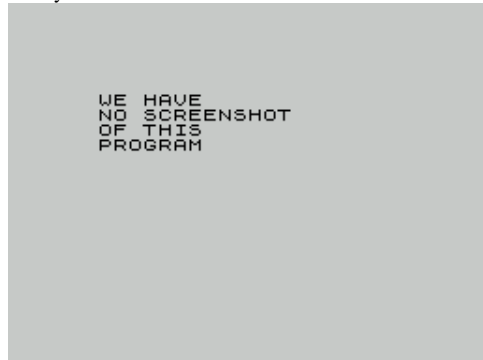

Pedro na Ostrove Piratov (Ultrasoft,1993)
Arcade

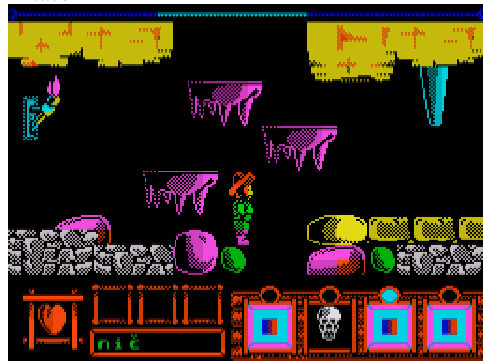

Paws (Artic Computing Ltd,1985)
Arcade



Pazazz (ASK Software,1987)
Educational

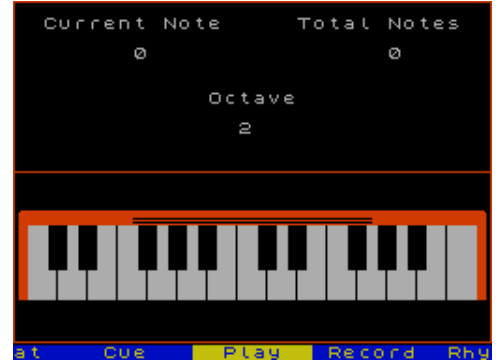

PCW Games Collection for the Spectrum (Personal Computer World,1984) Compilation



Pearl Harbour (Sabresoft,1983)
Strategy



Pedro v Krajine Pyramid (Ultrasoft,1993)
Arcade Adventure



Pedro v Strasilnem Zamku (Ultrasoft,1993)
Arcade Adventure

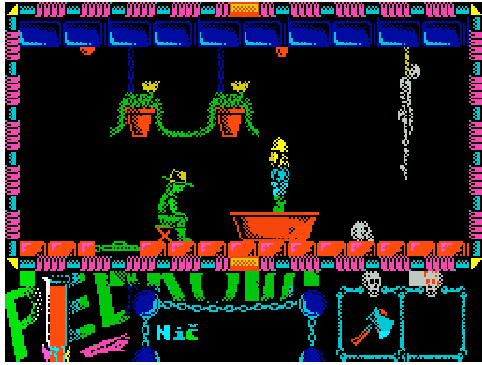

Peepshow 1 (Awk Software,1984)
Board/Card Game

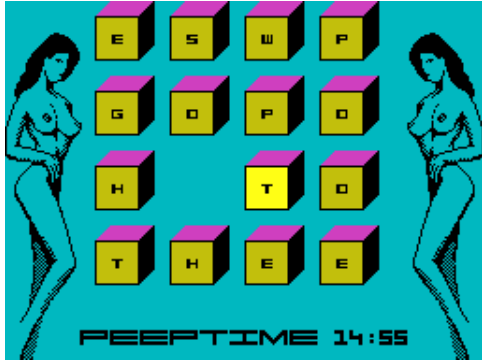

Pegasus (Herron Software,1985)
Text Adventure

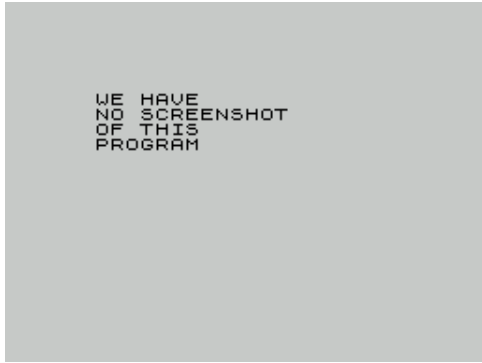

Pelon Questions (Dark Sentinel Soft,1992)
Board/Card Game

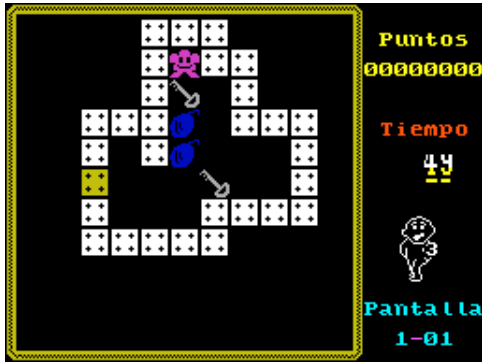

Penalty (Pacific Software,1990)
Simulation



Pedro y las Tortugas (Micromania [2],1985)
Arcade

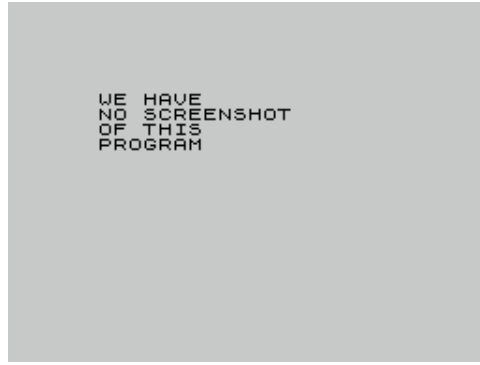

Peepshow 2 (Awk Software,1984)
Board/Card Game



Pegasus Bridge (PSS,1988)
Strategy

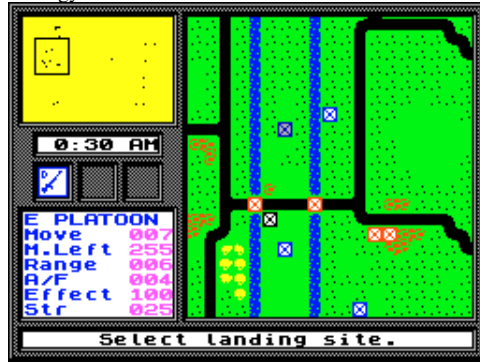

Peloponeska Valka (Proxima Software,1994)
Strategy

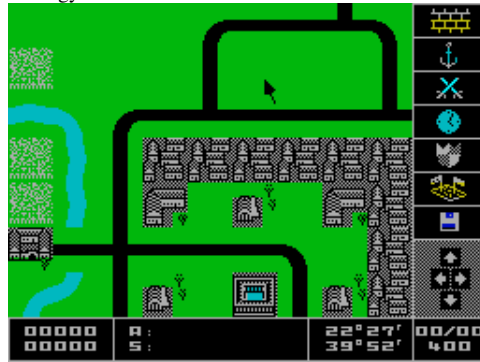

Penalty Soccer (Game Busters,1990)
Sport



Peep Show (R'n'H Microtec,1984)
Board/Card Game

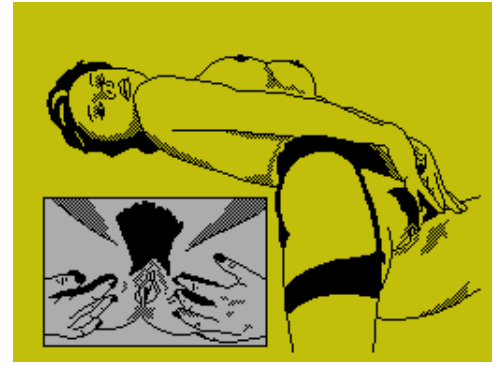

Peepshow Slideshow (TCS,1986)
Scene Demo

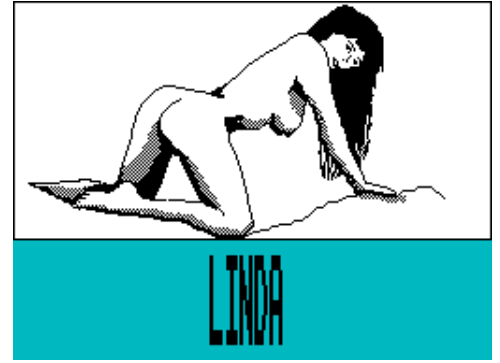

Peking (Your Sinclair,1991)
Board/Card Game

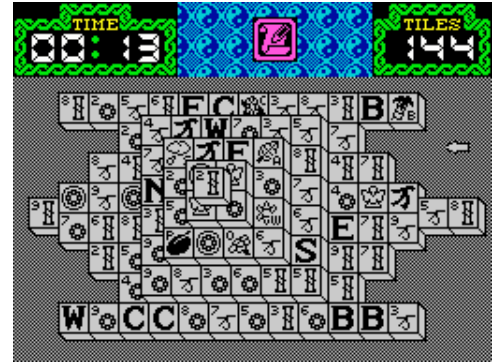

Peloponnesian War (MC Lothlorien Ltd,1983)
Strategy



Pen and the Dark, The (Mosaic Publishing Ltd,1984)
Text Adventure



Pendant of Logryn, The (Jamie Murphy,1989)
Text Adventure

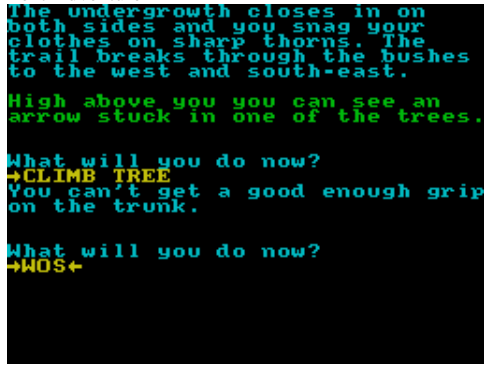

Peneless + Toot 'n' Come in (Ivyssoft,1992)
Compilation

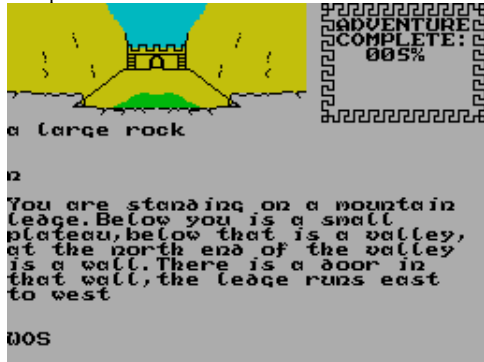

Peng II (The Mad Guys,1997)
Scene Demo



Penguin (Sinclair Programs,1984)
Arcade



Pentac (Compulogical S.A.,1985)
Strategy



Pendragon (Gadtek Games,1984)
Arcade

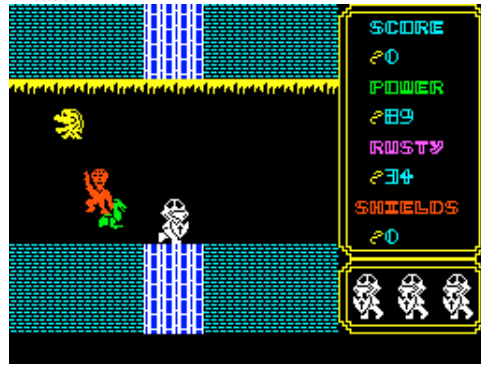

Penetrator (Melbourne House,1983)
Arcade

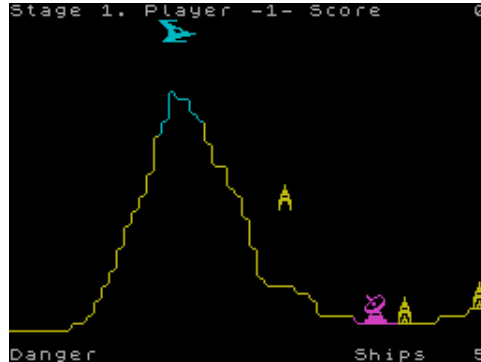

Pengo (MicroHobby,1985)
Arcade



Pengy (Micromania,1983)
Arcade



Pentacle, The (Anthony Byrne,)
Text Adventure

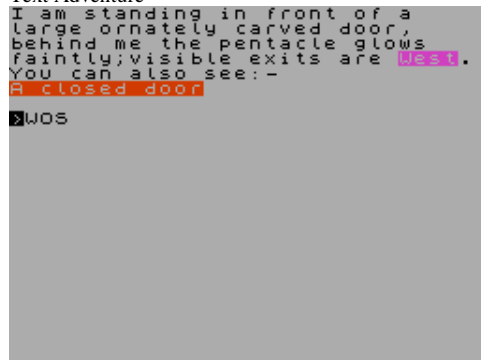

Peneless (Ivyssoft,1992)
Text Adventure

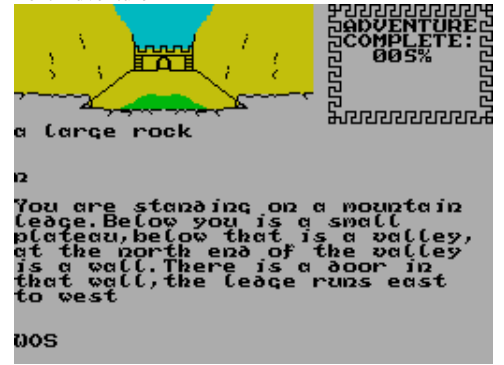

Penetrator, The (Mark Foley Productions,)
Arcade



Penguin (Add-On Electronics Ltd,1983)
Arcade



Pengy (Mogul Communications Ltd,1985)
Arcade

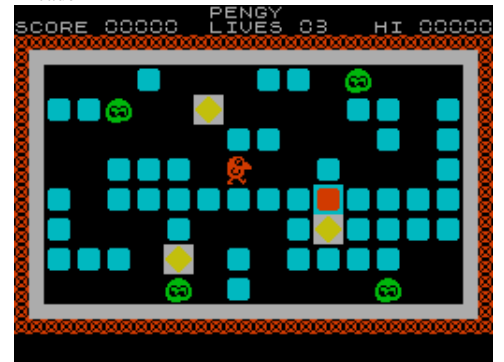

Pentagon (T. Korber,1984)
Arcade



Pentagram (Ultimate Play The Game,1986)
Arcade

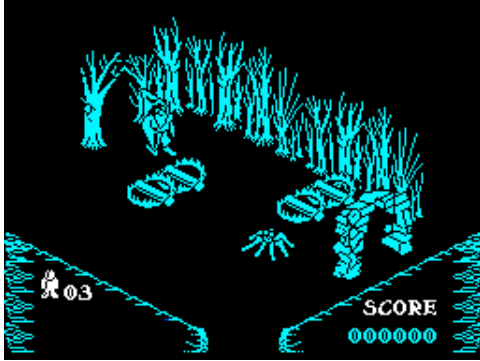

Pentomania (P. King,1987)
Board/Card Game

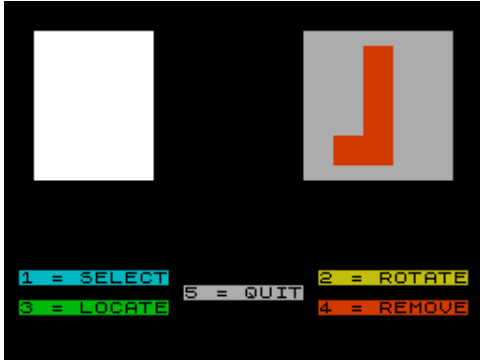

People from Sirius (US Gold Ltd/Your Sinclair,1987)
Arcade Adventure



Pequeweque (MicroHobby,1986)
Arcade



Perestrojka (Proxima Software,1991)
Arcade



Pentis (Tony Raugas,1988)
Arcade

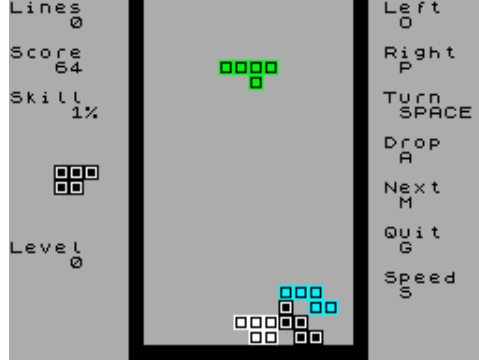

Pentominoes (Spectre,1983)
Board/Card Game



Peperami (Rasputin PD,1992)
Scene Demo



Percy: The Rhythm Interpreter (Misoft,1987)
Utility: Music Creation

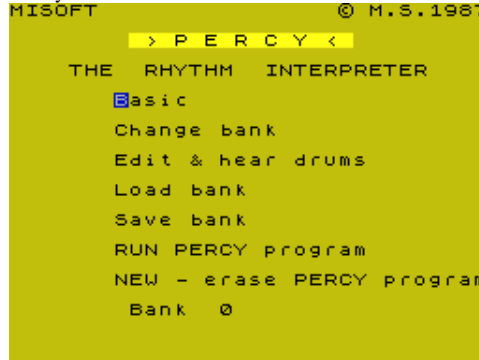

Perfume Hunter, The (Fernleaf Educational Software,1986)
Educational



Pentix (Academy Coders,1997)
Arcade



Pentzy (Spectrum Computing,1985)
Board/Card Game

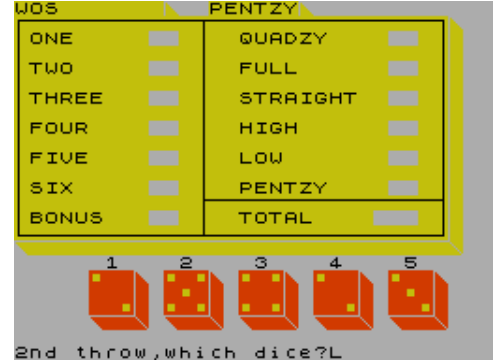

Pepsi Cola (Miami-Soft,1988)
Text Adventure



Peregrino, El (EP Software,)
Arcade



Perico Delgado Maillot Amarillo (Topo Soft,1989)
Sport

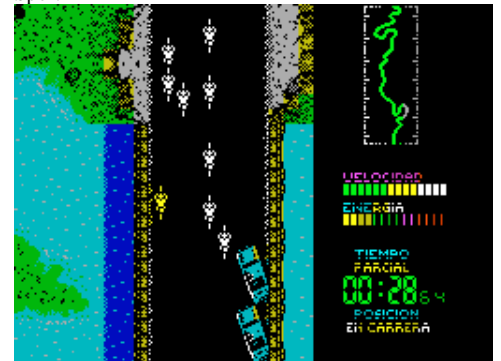

Perils of Bear George (Cheetahsoft Ltd,1984)
Arcade



Perrassorm (Pelagon Software,1986)
Text Adventure



Perseus and Andromeda (Digital Fantasia,1983)
Text Adventure

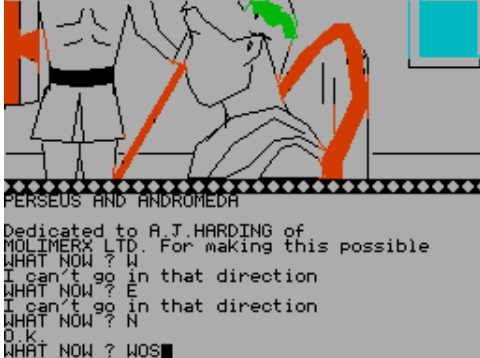

Personal Computer Games issue 03 (Personal Computer Games,1984) Covertape



Personal Computer Whirled! (Delbert the Hamster Software,1993) Text Adventure

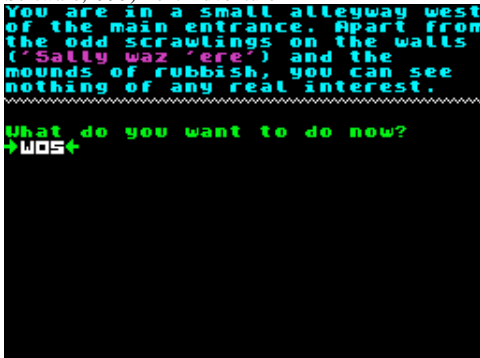

Periodic Table (Cloud 9 Software,1984)
Educational



Persecucion en Australia (Rafael Vico Costa,1989)
Text Adventure



Personal Banking System (Micromega,1982)
Utility: Spreadsheet

1982 A/C CLIVE SINCLAIR P.1

DATE	DETAILS	DR/CR	BALANCE
25SEP	BAL.BT/FWD	500.50	500.50
27SEP	BINATONE	-49.00	450.55
10OCT	BBC	-399.00	50.60
15OCT	DRAGON	-199.00	-140.35
27OCT	BINATONE	-49.00	-190.00
10NOV	BBC	-399.00	-590.00
15NOV	DRAGON	-199.00	-790.00
37NOV	BINATONE	-49.00	-840.15
30NOV	CASH	500.00	-340.15
10DEC	BBC	-399.00	-740.15
15DEC	DRAGON	-199.00	-940.05
20DEC	VIC 20	-179.00	-1120.00
27DEC	BINATONE	-49.00	-1170.05
28DEC	ZX SALES	5000.00	3830.15
10JAN	BBC	-399.00	3431.15
15JAN	DRAGON	-199.00	3232.15

Press - "N" for Next Page,
"R" to Reselect Page Number,
"M" for Menu, or "P" to Print

Personal Computer Games issue 13 (Personal Computer Games,1984) Covertape



Personal Filing System (SD Micro Systems,1984)
Utility

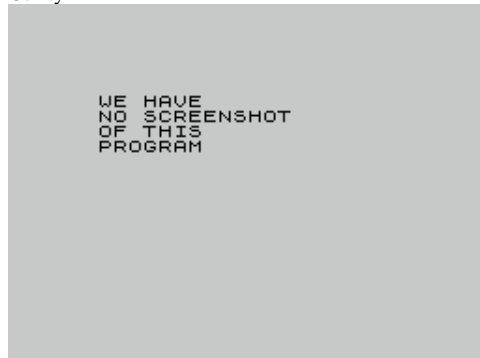

Periscope Up (Atlantis Software Ltd,1989)
Arcade



Perseus (Zenobi Software,1993)
Text Adventure

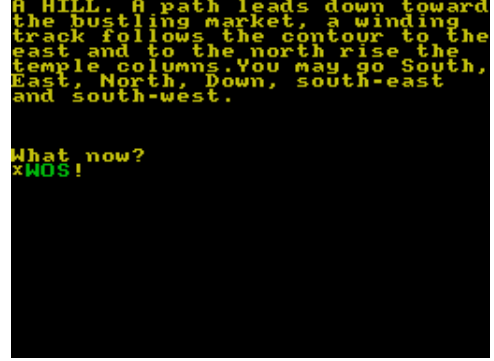

Personal Best (Earlgate Computers,1984)
Educational

PERSONAL BEST

NAME	TIME	NAME	TIME
1m	0h:10m:10s	10k	1h:3m:10s
3k	0h:18m:57s	8m	1h:21m:19s
2m	0h:20m:19s	10m	1h:41m:39s
3m	0h:30m:30s	12m	2h:1m:59s
5k	0h:31m:35s	h/M	2h:13m:17s
4m	0h:40m:39s	15m	2h:32m:29s
5m	0h:50m:49s	20m	3h:23m:19s
6m	1h:0m:59s	Mar	4h:26m:34s

Print Save Menu

Personal Computer Superlearning System (Morley Davies Associates,1984) Educational



Personal Finance (DK'Tronics Ltd,1983)
Utility: Spreadsheet

PERSONAL FINANCE SYSTEM

OPTION	FUNCTION
1	DEBIT CURRENT A/C
2	CREDIT CURRENT A/C
3	CURRENT BALANCE
4	BALANCE AS OF SPECIFIED DATE
5	CURRENT A/C HISTORY (LIST/UPDATE)
6	ADD STO/DDR
7	STO/DDR STATUS (LIST/UPDATE)
8	SYSTEM STATUS
9	TERMINATE SESSION

ENTER TODAY'S DATE (DDMMYY) "C"

Personality Analysis (Martin Malley,1983)

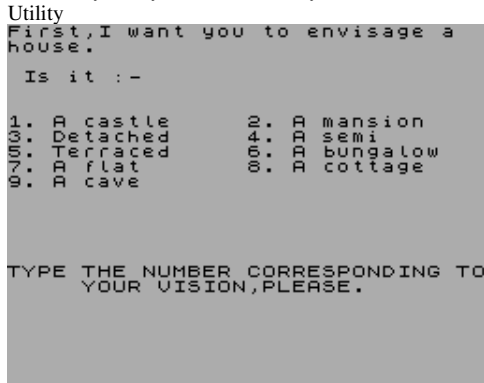

Perspectivas Conicas (MicroHobby,1985)



Pesadilla (.)

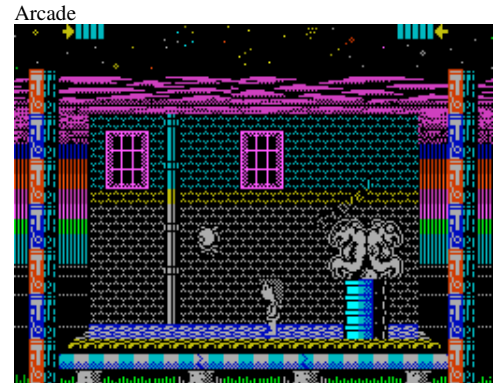

Pete Bog (Infected Software,1987)

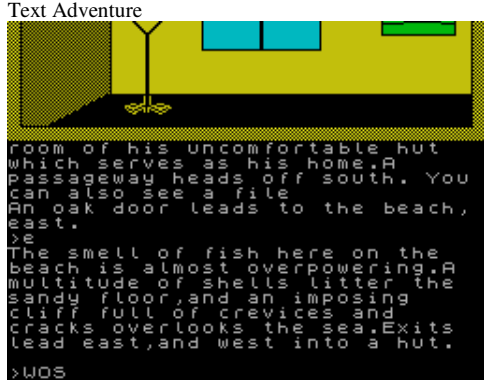

Pete n' Barry (Impact Software [3],1985)

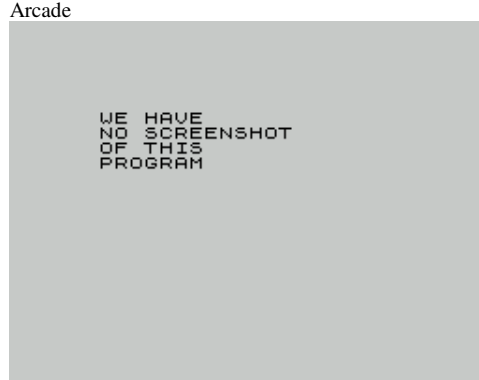

Peter-16 (Flash Inc,1994)

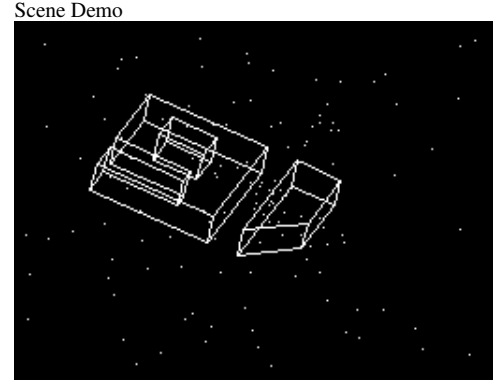

Peter Beardley's International Football (Grandslam Entertainments Ltd,1988) Sport



Peterborough Powerbox (Ashley Greenup,1992)



Peter Novak (Flash Inc,)



Peter Pack Rat (Silverbird Software Ltd,1989)

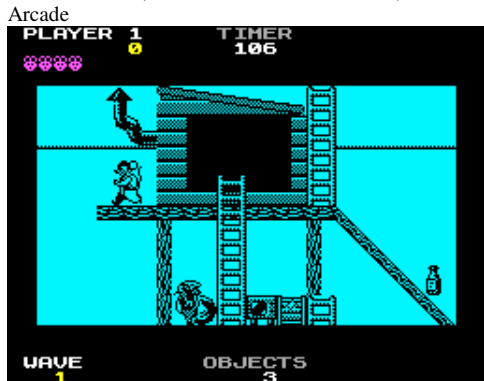

Peter Pan (Hodder & Stoughton Ltd,1984)



Peter Shilton's Handball Maradona (Grandslam Entertainments Ltd,1986) Sport



Pet-Porno (The M-1 Hacker,1999)

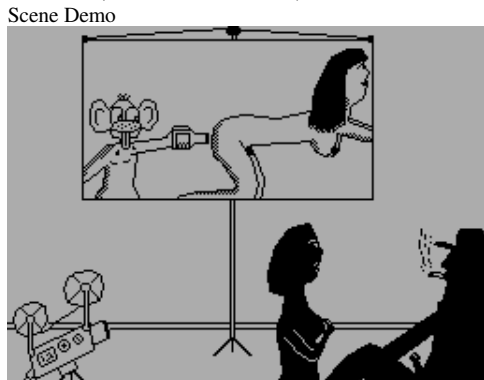

Petter the Pacifist (X Software,1987)



Pettigrew Chronicles, The (Shards Software,1985)



PFN Print (Garry Rowland,1991)
Utility: Font/UDGs

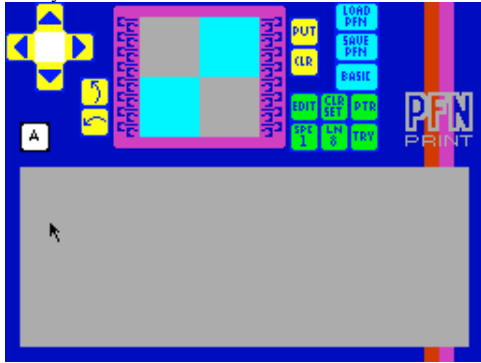

Phantasia (Rabbit Software Ltd,1983)
Arcade



Phantomas (Dinamic Software,1986)
Arcade

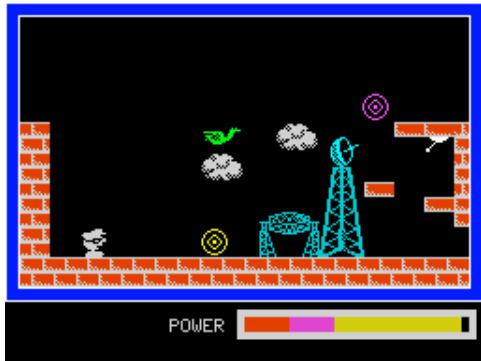

Phantomasa in the Land of the Grunge Wizards (na_th_an,2006) Arcade Adventure



Phantom Club (Ocean Software Ltd,1988)
Arcade



Pfui Spinne (.)
Arcade

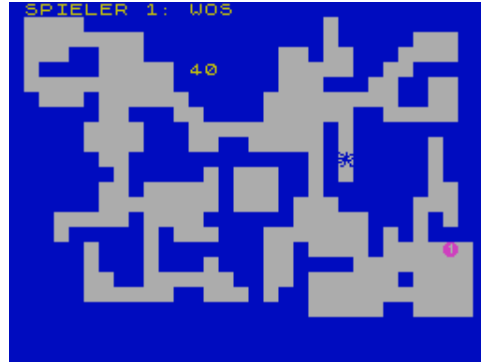

Phantasmagraphics (Saxon Computing,1982)
Utility

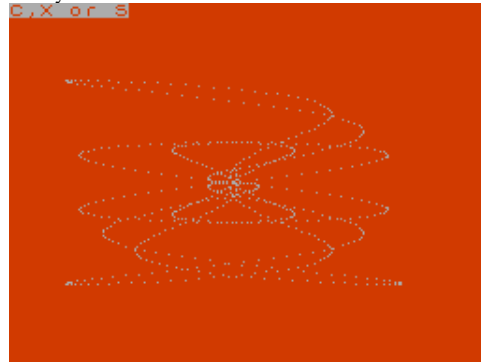

Phantomas 2 (Dinamic Software,1986)
Arcade



Phantomas en la Luna (Loko Soft,1992)
Arcade

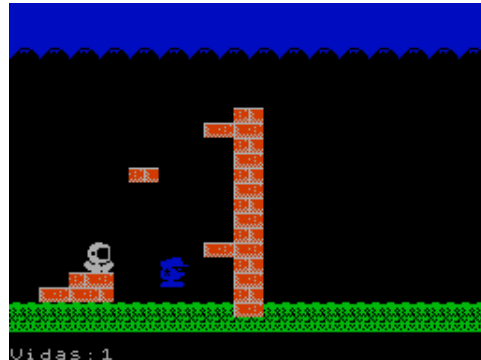

Phantom F4 (Ultrasoft,1992)
Arcade Adventure



Phantasia (Pw,1985)
Text Adventure

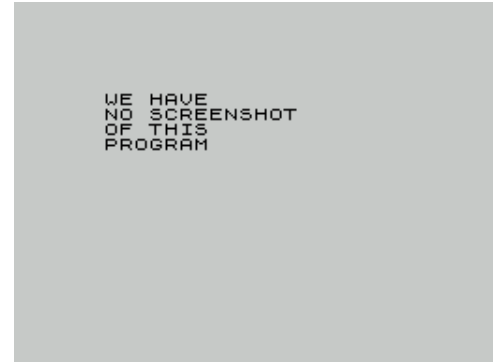

Phantis (Dinamic Software,1987)
Arcade



Phantomasa (Computer Emuzone,2007)
Arcade

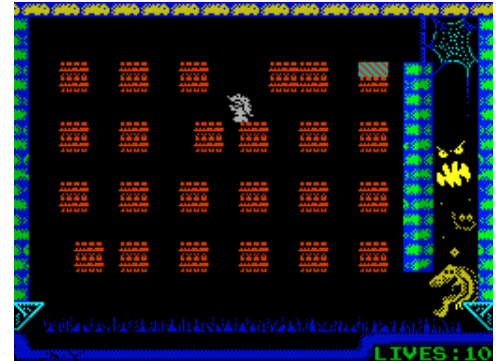

Phantomas Saga: Infinity (Computer Emuzone,2006)
Arcade

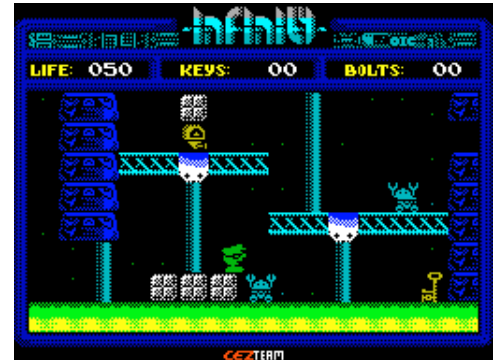

Phantom - The Demo (Scandinavian Software Crackers,)
Scene Demo

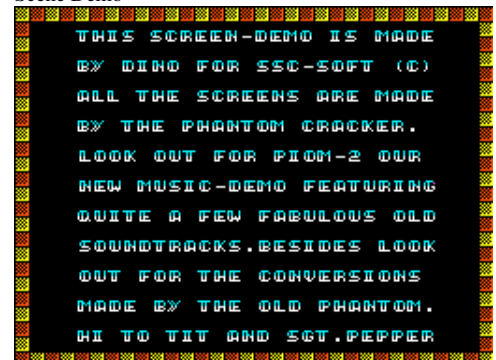

Pharaoh's Tomb (A'n'F Software,1983)
Text Adventure



Pharaoh's Tomb, The (Phipps Associates,1983)
Text Adventure



Pharaon (Loricels,1987)
Text Adventure

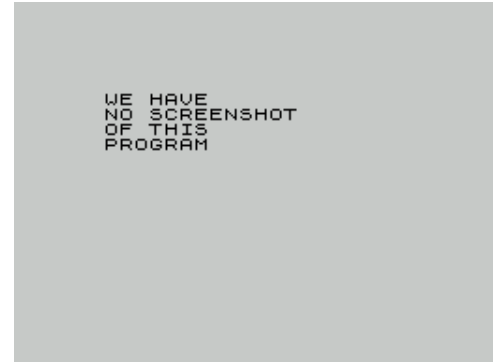

P.H.A.R.T. (Creative Juices,1988)
Text Adventure

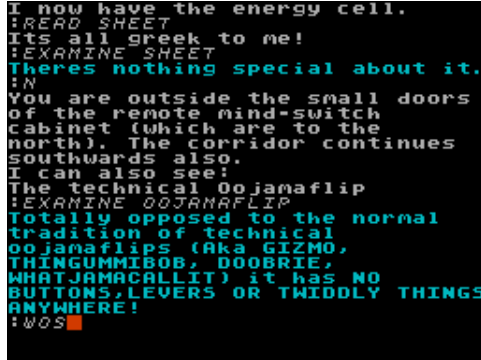

Phase (Sinclair Programs,1984)
Educational

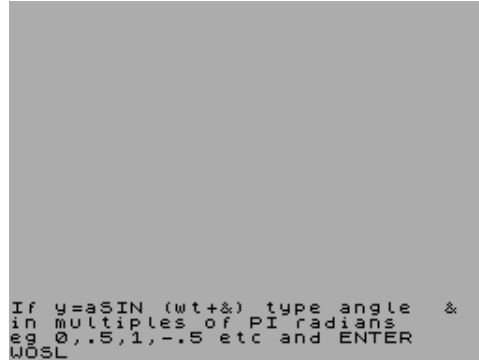

Phasorchase (Anik Microsystems,1984)
Arcade



Phasor Power (Anik Microsystems,1984)
Arcade

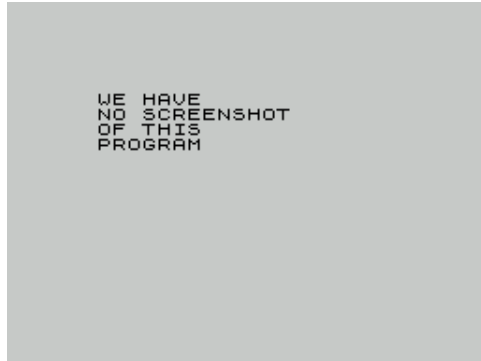

Phenix (Megadodo,1983)
Arcade



Phibian (Jonathan Cauldwell,2005)
Arcade

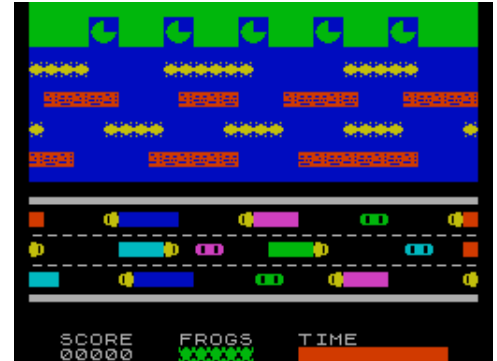

Phileas Fogg's Balloon Battles (Zeppelin Games Ltd,1991)
Arcade



Philly Flasher (Silver Fox Comm Ltd,1983)
Board/Card Game



Philosopher's Quest (Topologika,1988)
Text Adventure



Philosopher's Stone, The (Central Solutions,1986)
Text Adventure

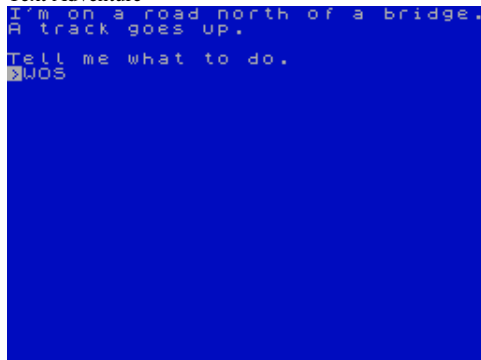

Philosopher's Stone, The + Greatest Show on Earth, The (Central Solutions,1986) Compilation

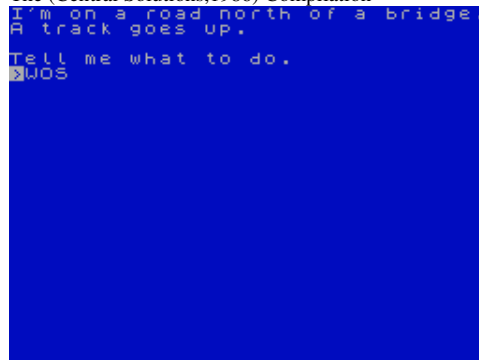

Phineas Frogg (Mirrorsoft Ltd,1985)
Text Adventure

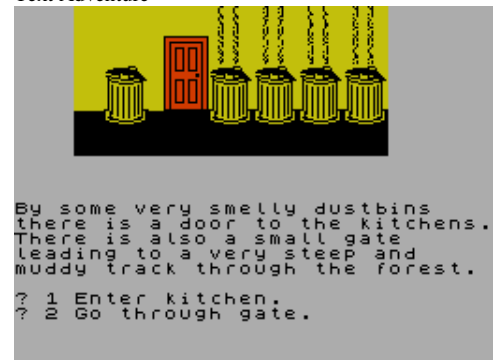

P.H.M. Pegasus (Electronic Arts,1988)
Arcade



Phoenix (ZX Spectrum Club.)
Arcade

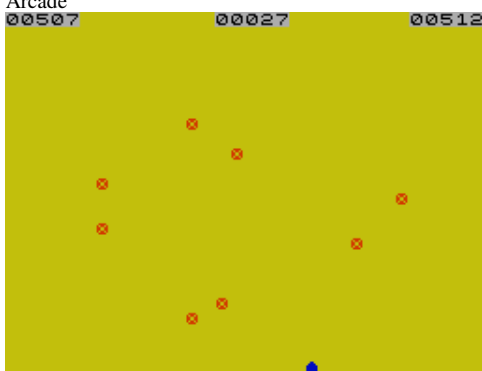

Photofit (Sinclair Programs,1984)
Utility



Phrenetic (FST/DST,1997)
Scene Demo



Physics (Collins Educational,1985)
Educational

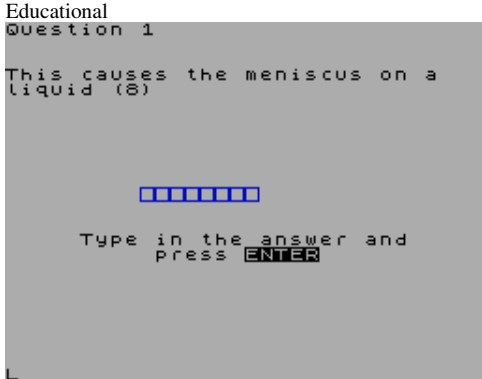

Phoenix (Robert Spahl,1983)
Arcade

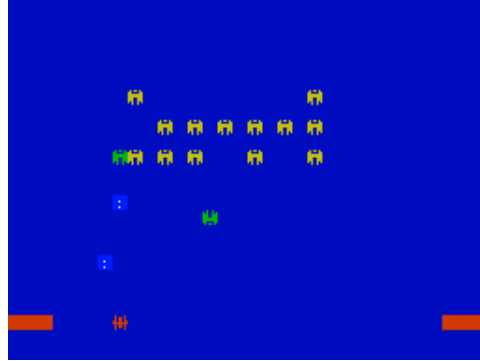

Phones (Wimsoft,1983)
Utility



Photon (Eigen Software,1984)
Utility: Assembler/Disassembler/Monitor



Physics (AVP Computing,1986)
Educational



Physics (Hill MacGibbon,1985)
Educational

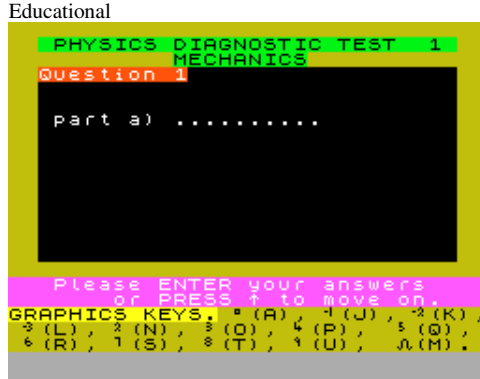

Phoenix (Zenobi Software,1991)
Text Adventure



Photo Finish (LJK Computing,1984)
Strategy



Photosynthesis (AVP Computing,1987)
Educational



Physics (Charles Letts & Co,1985)
Educational



Physics (Homestudy Ltd,1983)
Educational

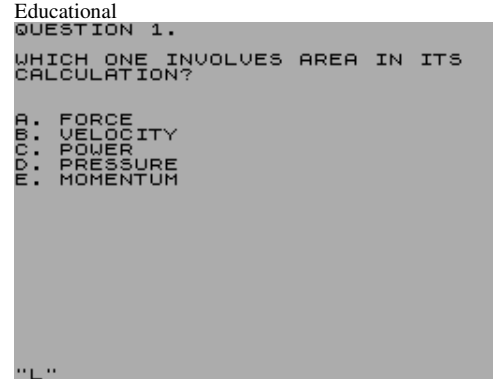

Physics (Visions Software Factory,1988)
Educational



Physics 1 (Think Tank Educational Software,1983)
Educational

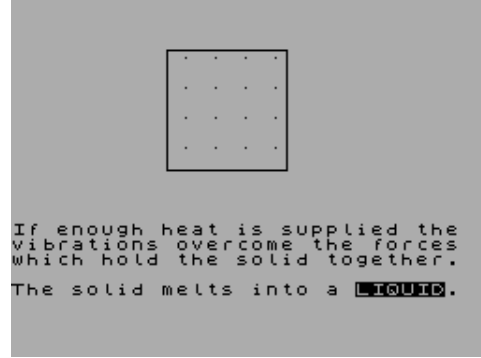

Physics 10 (Vision Software,1987)
Educational

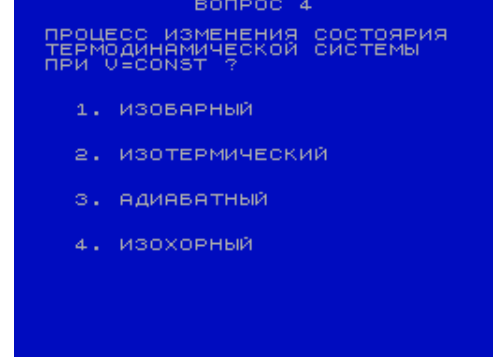

Physics 11 (Vision Software,1987)
Educational

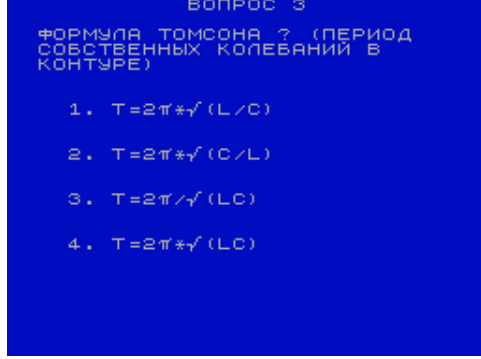

Physics - Examination Practise & Tests O Level (Sphere Software,) Educational

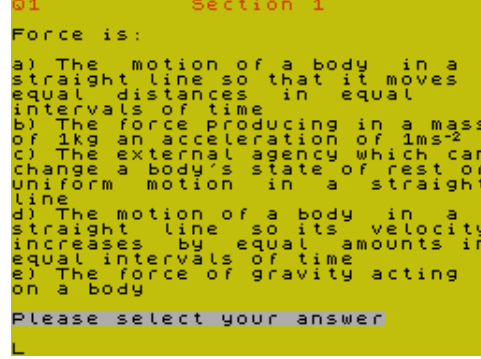

Physics O - A Level (Calisto,1983)
Educational

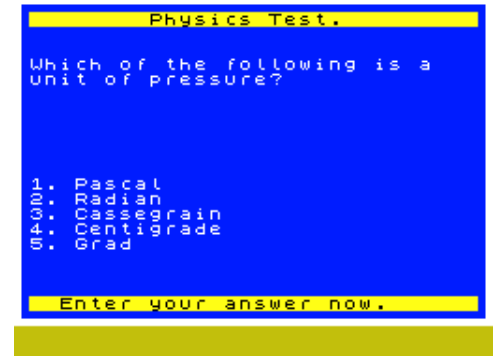

Physics - O'Level & CSE (Micro-De-Bug Consultancy,1984)
Educational



Physics - O-Level Revision and CSE (Longman Software,1985)
Educational

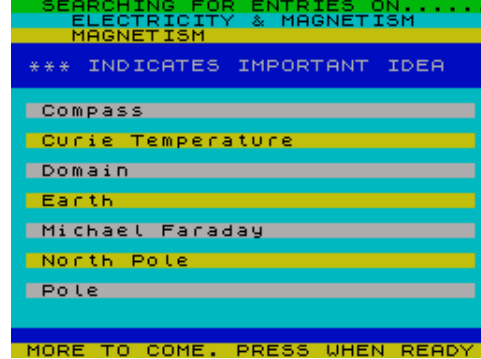

Physik Lernprogramm (Individual Software Service,1983)
Educational

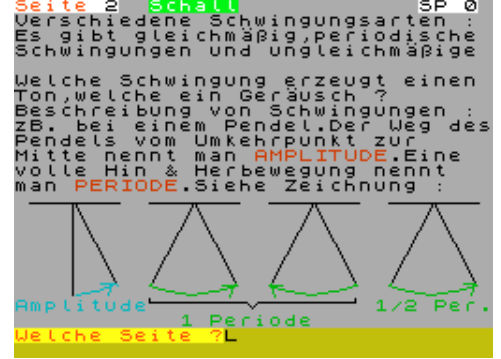

Pi (Blanchard Smith,1983)
Utility



Piano (.)
Utility: Music Creation



Pianola (De Wit Productions Ltd,1984)
Utility: Music Creation



Pi-Balled (Automata UK Ltd,1984)
Arcade



Picasso (Shiva Publishing Ltd,1983)
Utility: Drawing



Picassograph (Load 'n' Run [Spa.])
Utility: Drawing



Pick 'n' Pile (Ubi Soft Ltd,1990)



Pick-Poke-It (Miles Gordon Technology,1989)
Utility



Pictionary (Domark Ltd,1989)



Picture Book (Triple R Education,1992)
Educational



Picture of Innocence, A (Central Solutions,1986)



Pick Out 2 (Ultrasoft,1993)



Pic-nic (MicroHobby,1985)
Arcade



Picture (.)



Picture Logic (Addison-Wesley Productions,1985)
Educational



Picture Plotter (Calpac Educational Software,1983)

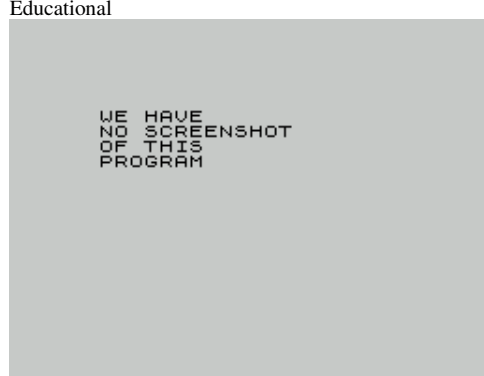

Pick-Pocket (Gemini Marketing Ltd,1983)



Picrema (Radical Alternative Software,1993)
Utility: BASIC Related

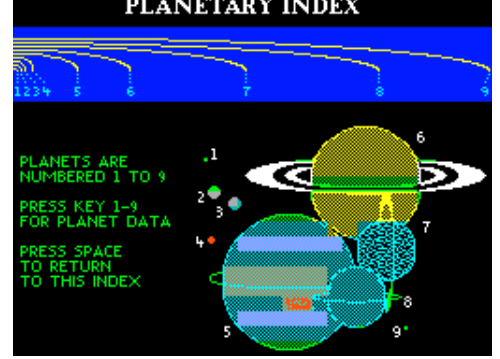

Picture Book (Softbacks,1984)

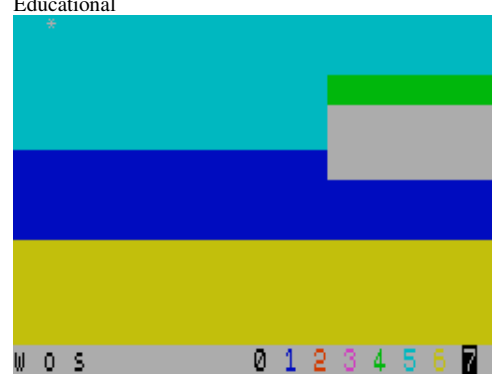

Picture Mixer (.)
Utility: Screen Manipulation

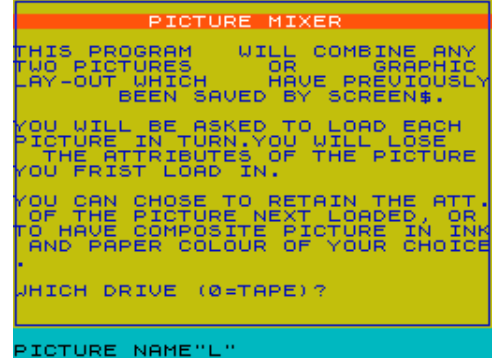

Picture Puzzle (Spectrum Computing,1985)



Picture Texter (Dominic Morris,1996)

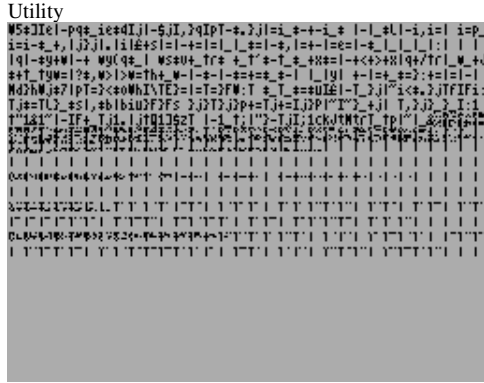

Pi-Eyed (Automata UK Ltd,1983)



Piggy (E.S.A. Productions,1997)



Pigs in Space (Comse,)

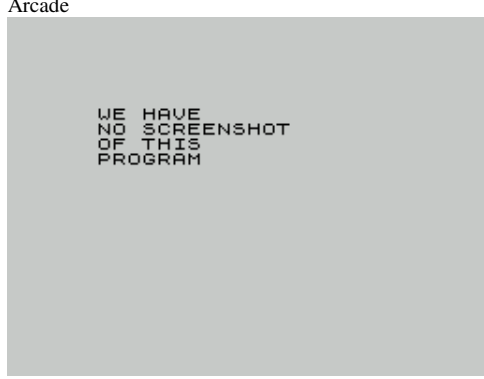

Pi in the Sky (Automata UK Ltd,1985)



Pieces of Eight (Sinclair User,1992)



Piggott's Pony (Anik Microsystems,1984)

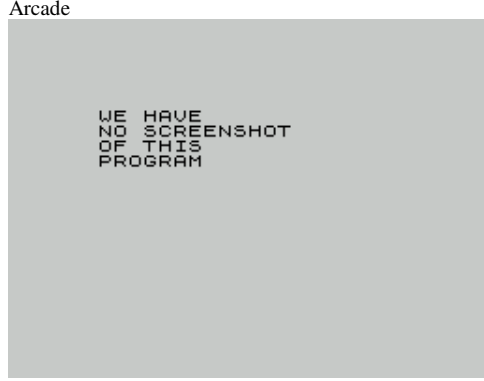

Piggy (Spectrum Computing,1985)

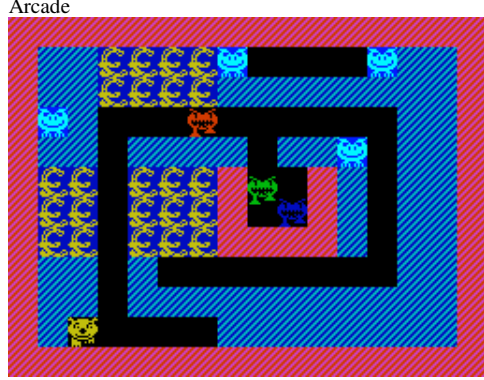

Pigs in Space (KDF Soft,1994)

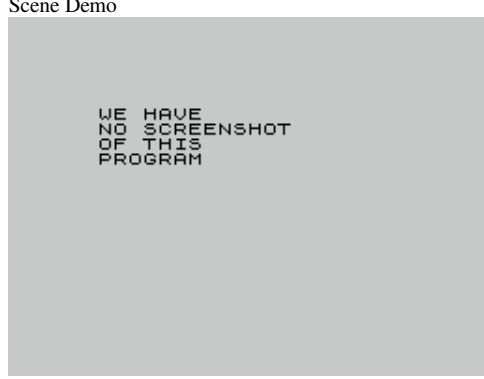

PIJ (Podraz na Indiana Jones) (PKCS/Fuxoft,1987)



Pie Chart (Shiva Publishing Ltd,1983)



Piggy (Bug-Byte Software Ltd,1988)

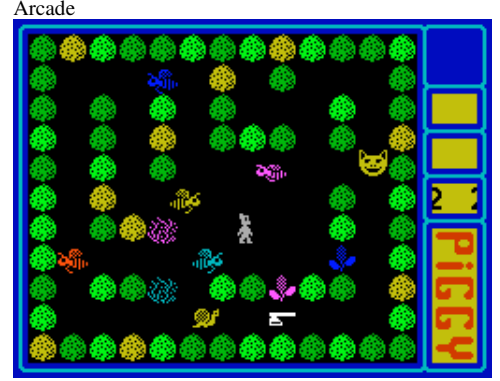

Piggy Punks (Sinclair User,1990)

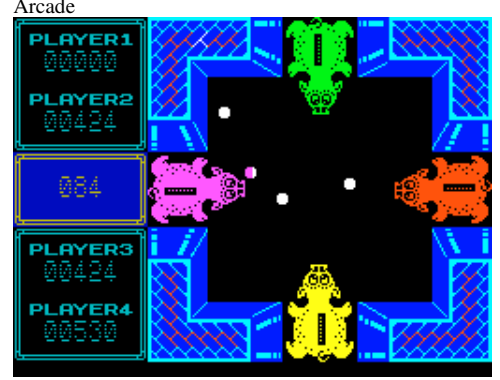

Pi-In-'Ere (Automata UK Ltd,1984)



Pikasm FSE (TRC Software,1988)

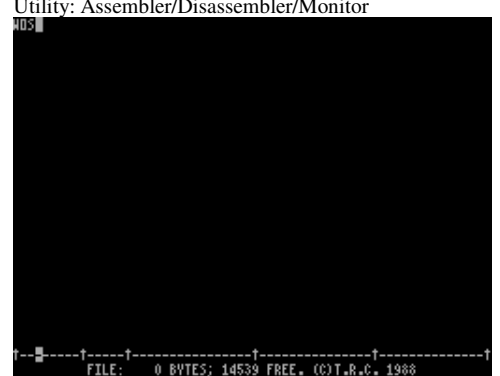

Piknik u Cesty (Regent Software,1990)

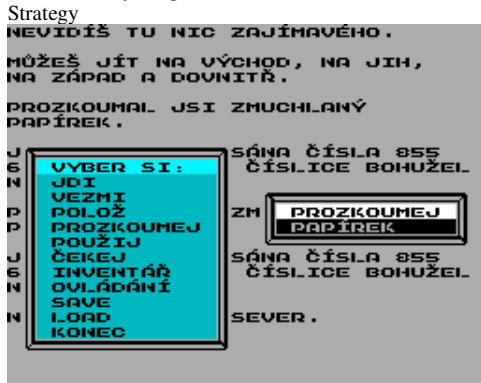

Pilot (Hewson Consultants Ltd.)
Arcade



Pimania (Automata UK Ltd,1982)
Text Adventure



Pinball (Wintersoft,1983)
Arcade



Pingo (Profisoft,1984)
Arcade



Pikomon (TRC Software,1988)
Utility: Assembler/Disassembler/Monitor

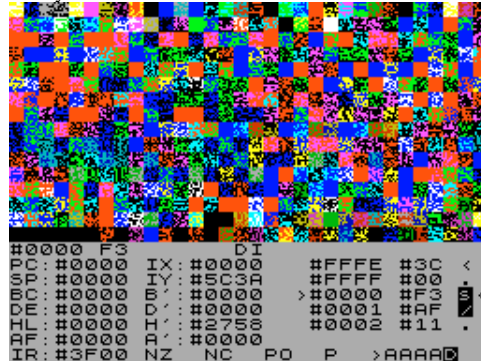

Pilot (Sinclair Programs,1983)

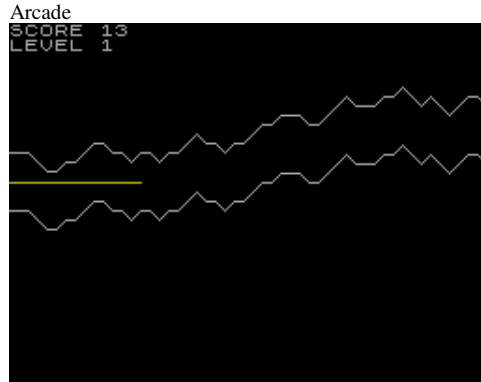

Pimans Cocktail Cabinet, The (Automata UK Ltd,1985)
Arcade

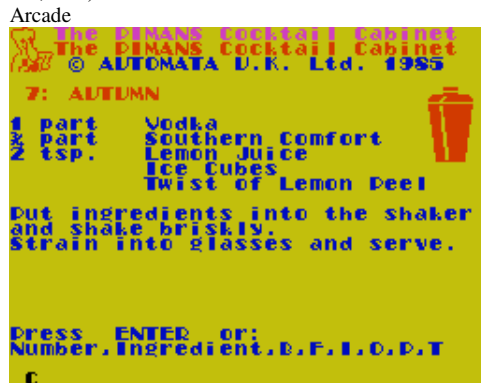

Pinball, 3D (Mastertronic Plus,1989)
Arcade



Ping Pong (Claus Jahn/Andy Schraepel,1996)
Arcade



Pilgrim's Progress (The Scripture Union,1984)
Text Adventure

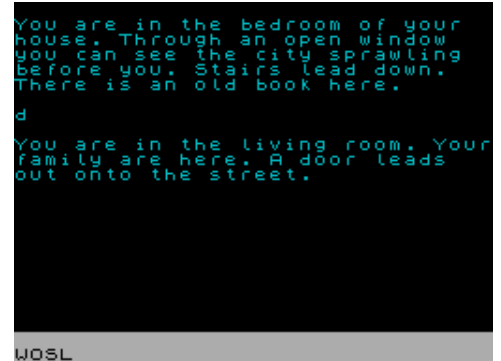

Piloto de Guerra (Microparadise Software,)
Simulation



Pimeval Man (Automata UK Ltd,1985)
Arcade

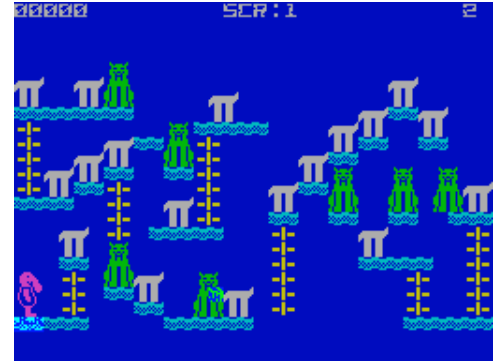

Pinball Wizard (CP Software,1983)
Arcade



Ping Pong (Imagine Software Ltd,1986)
Sport



Ping Pong (Ronny Nordqvist,1984)
Arcade

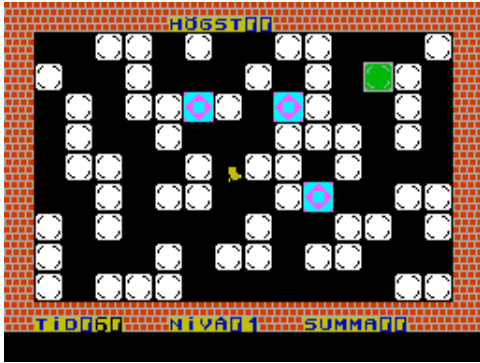

PinkBlue (Compuiter Soft,2005)
Board/Card Game

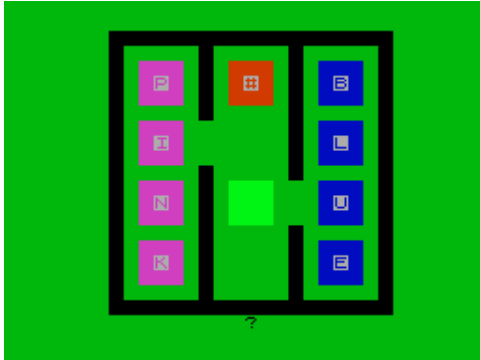

Pinky (MicroHobby,1985)
Arcade



Pipe Dream (Infosoft,1995)
Arcade

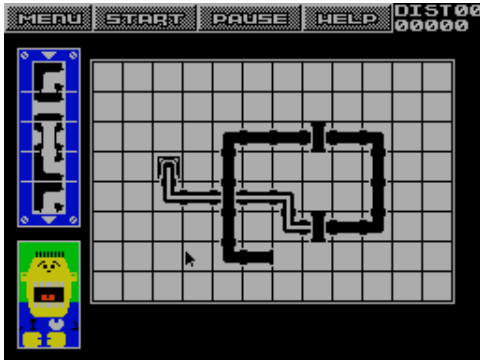

Pipeline (Viper Software,1985)
Arcade

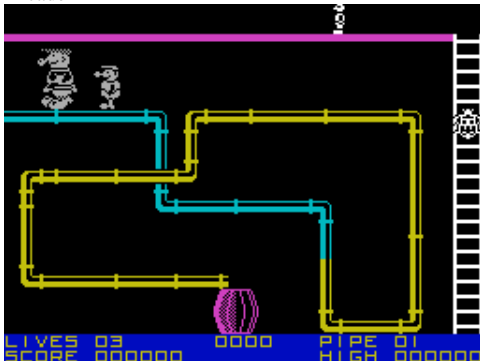

Ping Pong [1] (MicroHobby,1985)
Sport

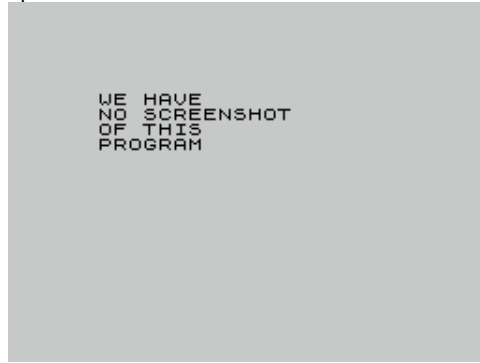

Pink Panther (Gremlin Graphics Software Ltd,1988)
Arcade Adventure



Pioneer (Atlantis Software Ltd,1984)
Arcade



Pipe Line (Dominic Morris,1992)
Board/Card Game

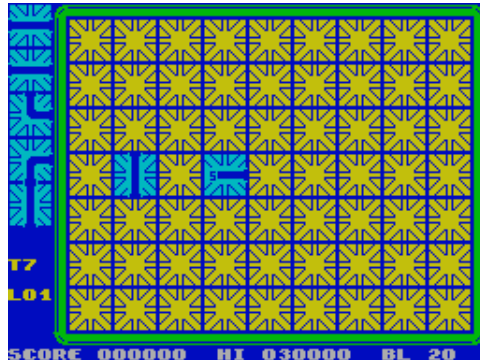

Pipeline + SOS (Consolidated Software Marketing Ltd,1985)
Compilation

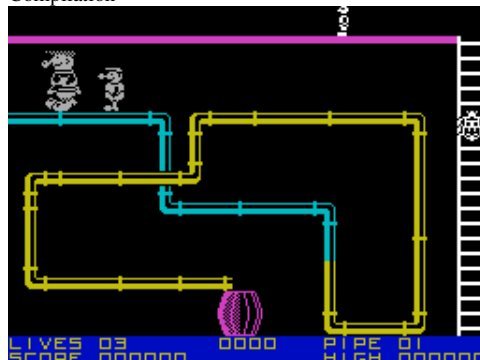

Ping-Pong [2] (MicroHobby,1986)
Arcade

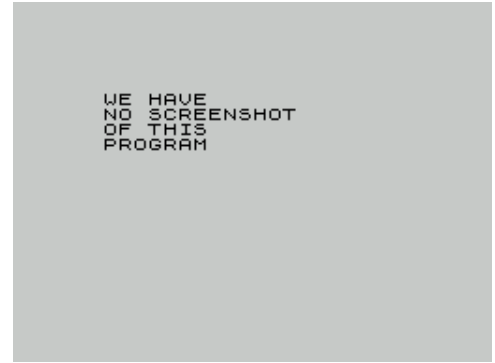

Pink Pearl, The (Astrosoft Games,1984)
Text Adventure



Piori (Markus Komputer,1985)
Utility

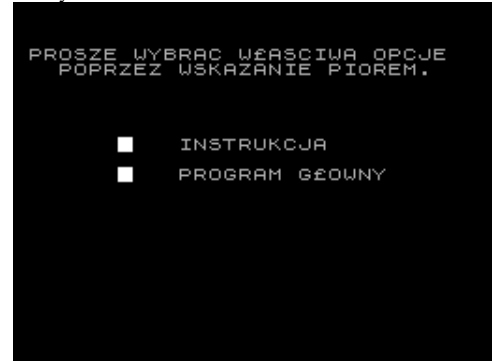

Pipeline (Sinclair Programs,1983)
Strategy

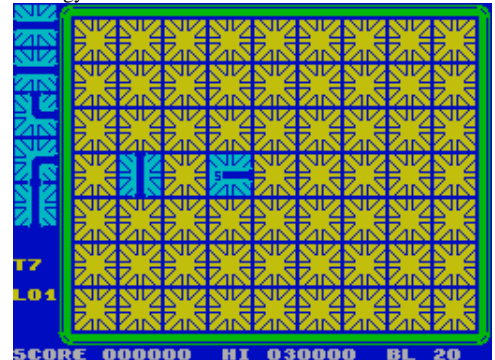

Pipe Mania (Empire Software,1990)
Arcade

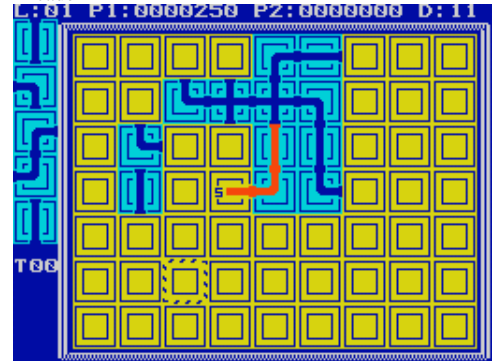

Pipework (Your Sinclair,1991)
Arcade



Piracy Copy (VJ Soft,1984)
Utility: Copier

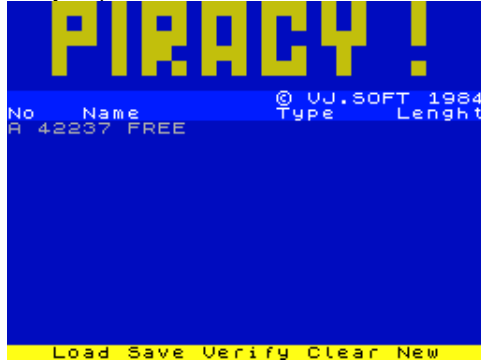

Piramide (Lolo Soft,)
Text Adventure

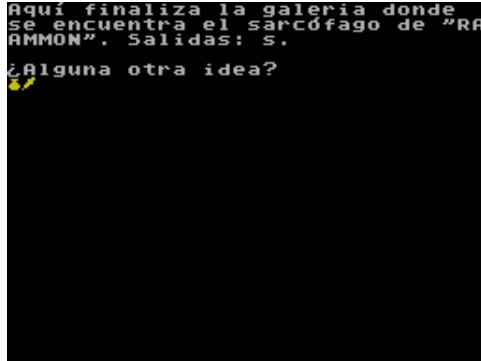

Pirat Copy (VMS Pirat & Co,1985)
Utility: Copier

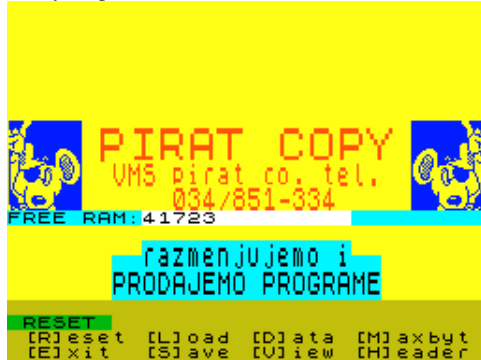

Pirate 7B - Special Agent (Kerr,1984)
Utility: Copier



Pippillea (The Yolpa Brothers,1995)
Scene Demo



Piraguas, Las (MicroHobby,1985)
Arcade

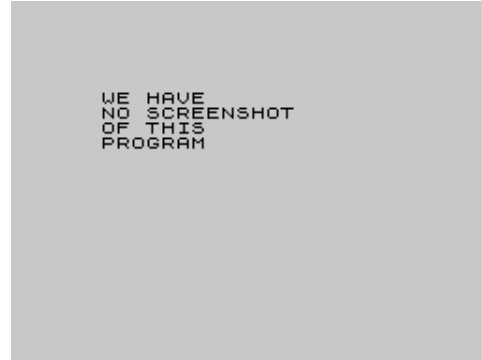

Piramide (Rafael Vico Costa,)
Text Adventure



Pirate (Chalksoft Ltd,1983)
Educational

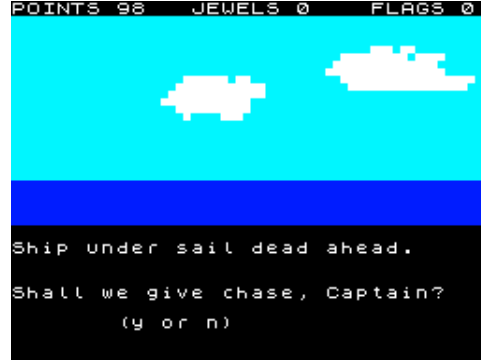

Pirate Adventure (Adventure International,1984)
Text Adventure

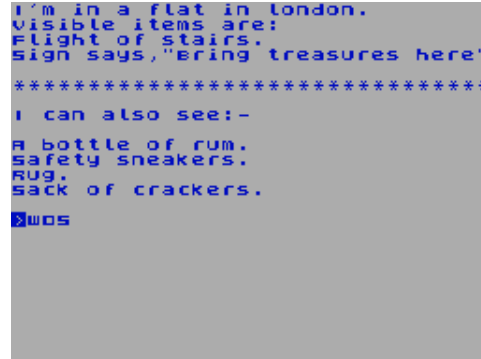

Pippo (Mastertronic Ltd,1986)
Arcade

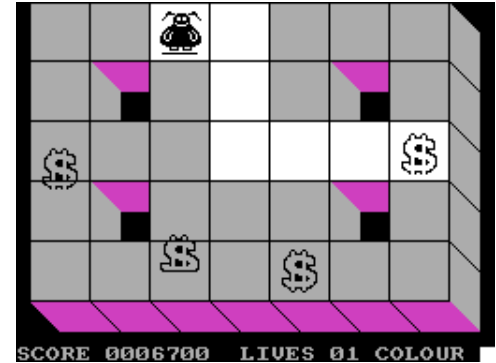

Piramida (Igor Kapultsevich,1992)
Board/Card Game

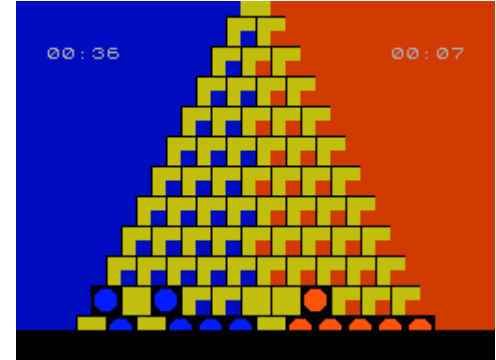

Piranha (16/48 Tape Magazine,1984)
Arcade



Pirate 3 +3 (Pirate Software Ltd,1987)
Compilation



Pirate Gold (Dave Watson,)
Text Adventure



Pirate Island (Work Force,1983)
Text Adventure



Pirate Tape Copy (,1985)
Utility: Copier
Pirate Tape Copy © 1985
Spare 42240



Pisak (Mikros,)
Utility



Pit (Camel Micros,1984)
Text Adventure



Pitfall ZX (Computer Emuzone,2003)
Arcade



Pirates (Nicodim,1995)
Strategy



Piromania (Automata UK Ltd,1984)
Arcade

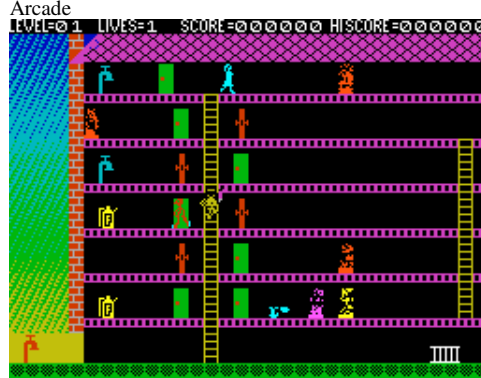

Piskworks (Raxoft,)
Board/Card Game

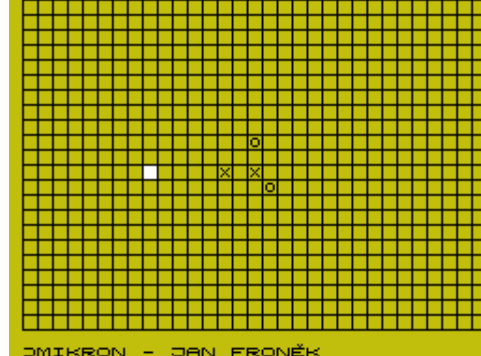

Pitcalc (Maldon Archaeological Group,1983)
Educational

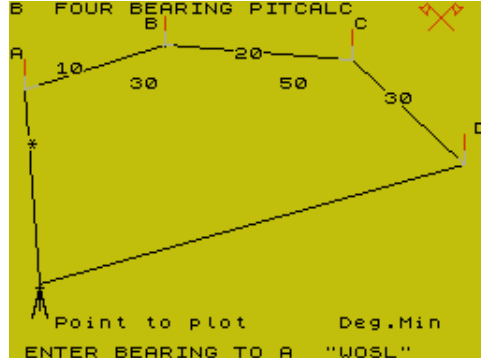

Pit-Fighter (Domark Ltd,1991)
Arcade



Pirates (Two Bears Software,1990)
Scene Demo



Pi-R Squared (Mind Games,1987)
Arcade



Piso Zero (Zigurat Software,1991)
Arcade



Pitfall II: Lost Caverns (Activision Inc,1984)
Arcade



Pit-Fighter + Super Space Invaders (Domark Ltd,1991)
Compilation



Pitfull (T. Storton,1983)
Arcade

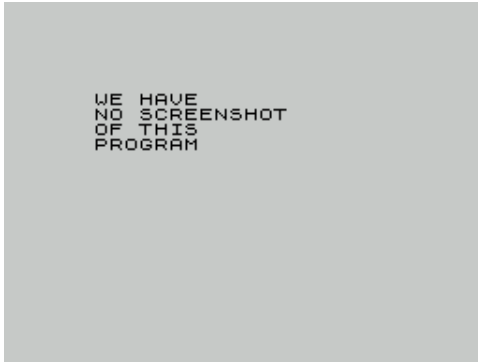

Pits, The (Cascade Games Ltd,1984)
Arcade

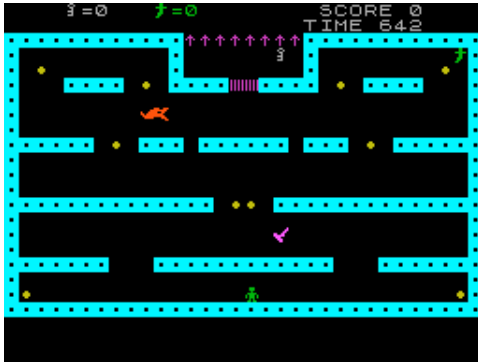

Pitufos, Los (Pepsi Soft,1991)
Text Adventure



Pixel Power (.)
Utility: Drawing



Pixy the Microdot (Your Sinclair,1987)
Arcade

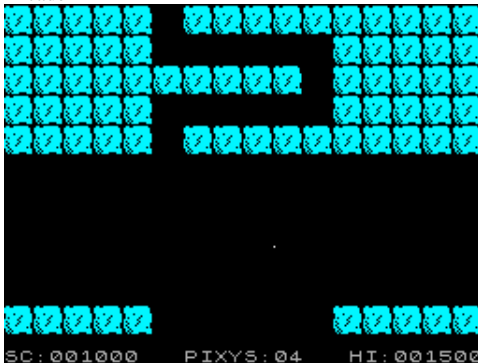

Pi There! (Automata UK Ltd,1985)
Arcade



Pit-Stop (Avalon Software,1984)
Arcade



Pixel (16/48 Tape Magazine,1984)
Utility



Pixel Puzzle (KPH Software,1985)
Board/Card Game



Pixy the Microdot 2 (Your Sinclair,1992)
Arcade



Pitman Seven (Visions Software Factory,1983)
Arcade

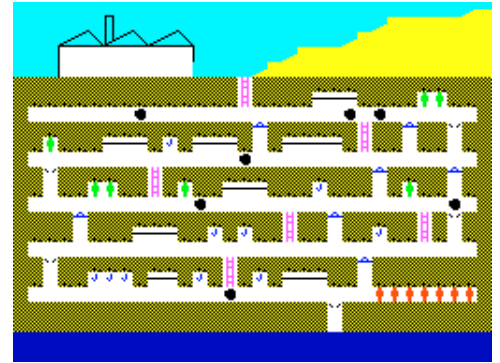

Pit, The (Rabbit Software Ltd.)
Arcade



Pixel Painter (Gary Perlmutter.)
Utility: Drawing



Pixerama (Load 'n' Run [Spa],1985)
Arcade

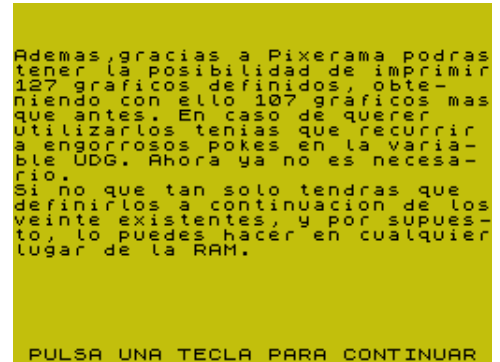

Pizza Bar (Redwood Designs,1993)
Arcade



Plagues of Egypt, The (Michael Young,1990)
Text Adventure

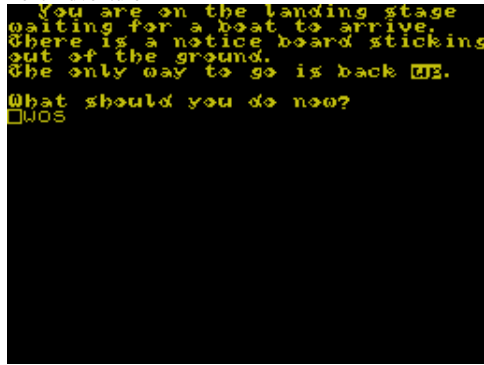

Planetarium (Eclipse Software,1985)
Educational



Planet Fighter (.)
Arcade



Planetoids (Sinclair Research Ltd,1982)
Arcade



Planet Patrol (Macmillan Software Ltd/Sinclair Research Ltd,1984) Strategy



Plan and Design Your Garden (Blandford Press,1985)
Utility

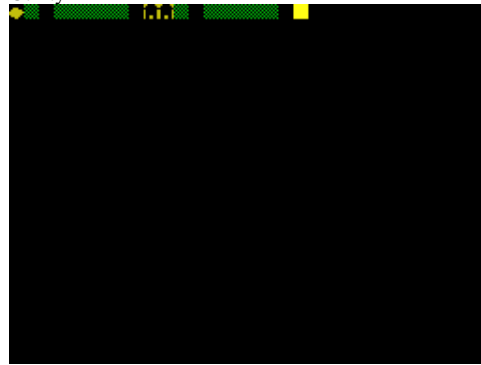

Planet Defender (Simon Micro-Soft,1982)
Arcade



Planet Mathematics (Teacher's Pet Software,1988)
Educational



Planetoids + Missile (Sinclair Research Ltd,1982)
Compilation



Planet Proton (Your Sinclair,1986)
Arcade

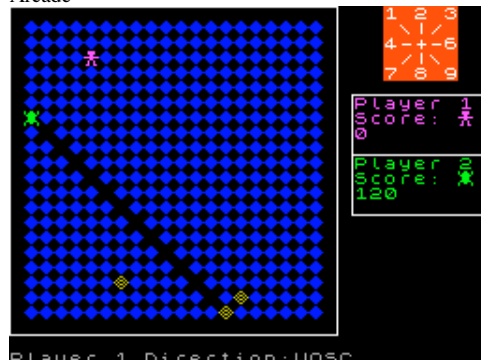

Planet 10 (Mastertronic Ltd,1989)
Arcade

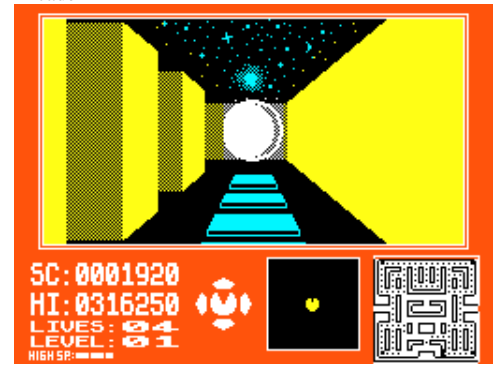

Planetfall (Argus Press Software Ltd,1984)
Simulation



Planet of Shades (Cybexlab Software,1986)
Arcade

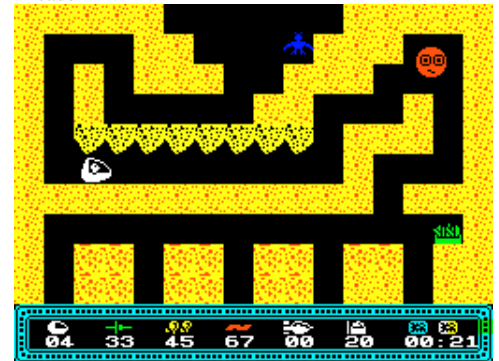

Planetopoly (Celerysoft,1986)
Strategy



PlanetQuest (The PResS Adventure.)
Text Adventure



Planets, The (Martech Games Ltd,1986)
Arcade Adventure

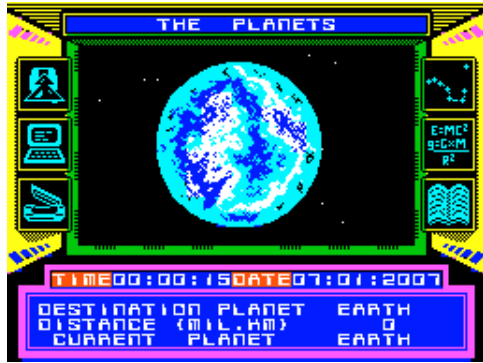

Planos Inclinados I (MicroHobby,1985)
Educational



Plasma Ball (Atlantis Software Ltd,1989)
Arcade



Platform Game Designer (Cronosoft,2005)
Arcade Game Development Tool



Play (Roman Mazl,1987)
Scene Demo



Planks (Sinclair Programs,1983)
Arcade

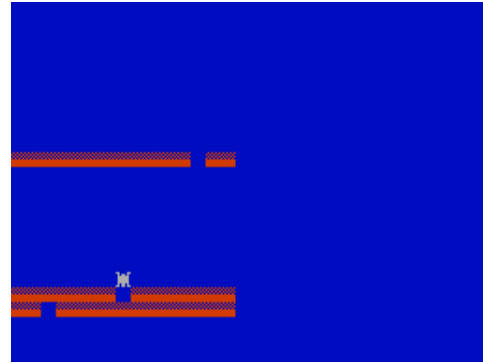

Planter's Guide, The (Phoenix Publishing Associates,1986)
Utility



Plasmatron (CRL Group PLC.)
Arcade



Platinum (US Gold Ltd,1991)
Compilation



Play As You Learn (Spartan Software,1984)
Educational



Plano Afin (MicroHobby,1986)
Arcade

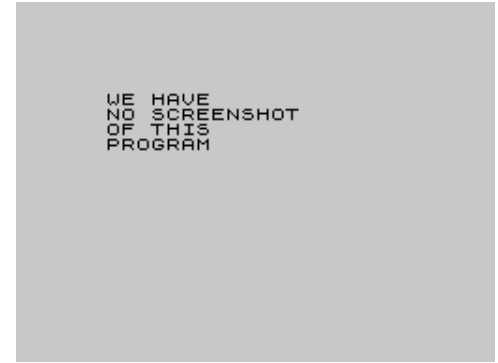

Plasma (MicroHobby,1985)
Arcade



Platero (Investronica S.A.,1984)
Board/Card Game



Platoon (Ocean Software Ltd,1988)
Arcade



Play As You Learn (Turtle Software,1984)
Educational



Play Ball! (Paul Grenfell,2003)
Arcade



Play for Your Life (Your Sinclair,1988)
Sport

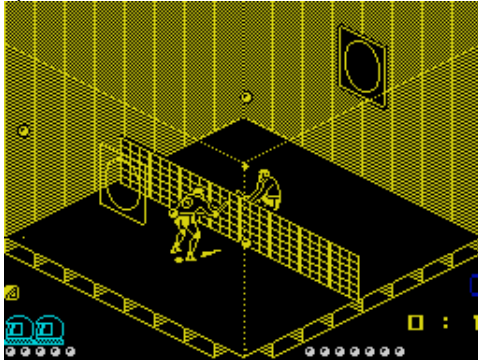

Play It Once More 1 (Scandinavian Software Crackers,1989)
Scene Demo



Play, Type and Transpose (Hilton Computer Services Ltd,1985) Utility



Play Your Cards Right (Ron Ridge,)
Board/Card Game



Playdays (Alternative Software Ltd,1993)
Arcade

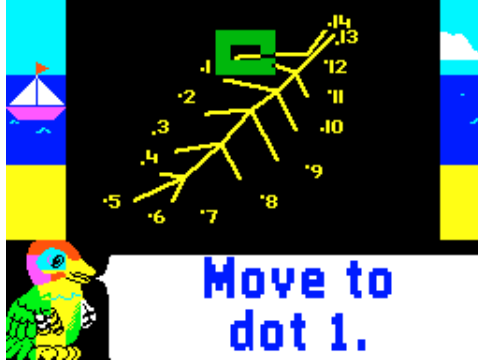

Play It Again (US Gold Ltd,1987)
Compilation



Play It Once More 2: Play It Again (Scandinavian Software Crackers,1989) Scene Demo



Play Your Cards Right (,)
Board/Card Game

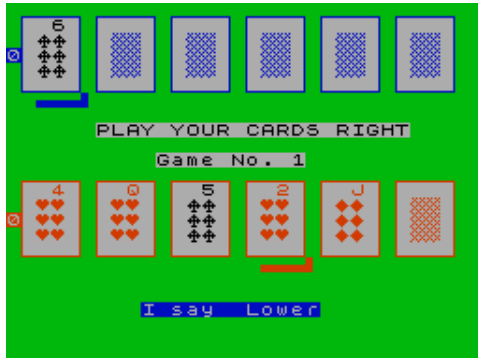

Plexar (Mastertronic Added Dimension,1987)
Arcade

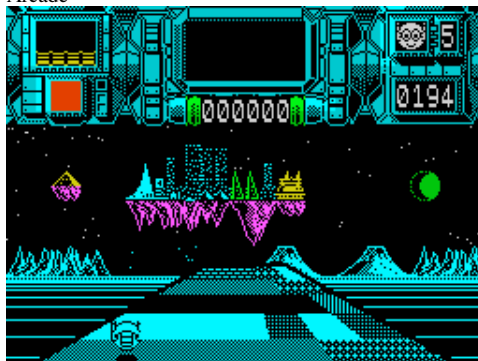

Player Manager (Anco Software Ltd,1990)
Simulation



Play It Again, Sam (Mastertronic Added Dimension,1986)
Text Adventure

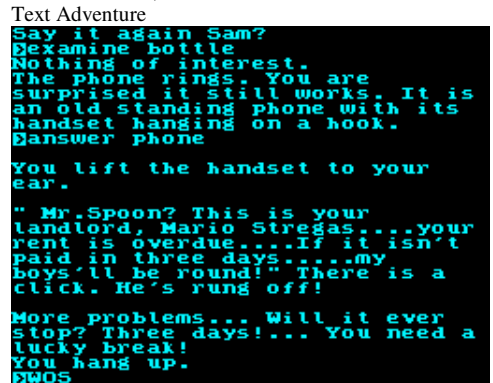

Play Super (Roman Mazl,1987)
Scene Demo

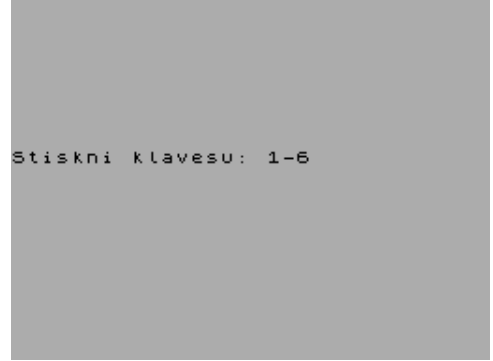

Play Your Cards Right (Britannia Software Ltd,1986)
Board/Card Game



Pling! (Sinclair Programs,1983)
Arcade

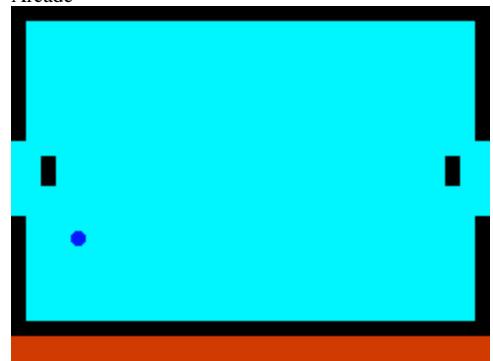

Plot, 3D (.)

Utility: Mathematics



Plot Hatcher (Smart Egg Software,1988)

Text Adventure

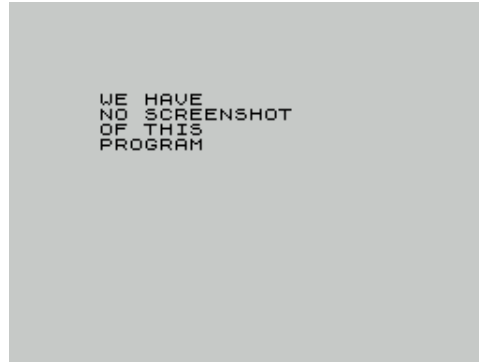

Plot of Bivariate Regression (University Software,1983)

Utility: Mathematics

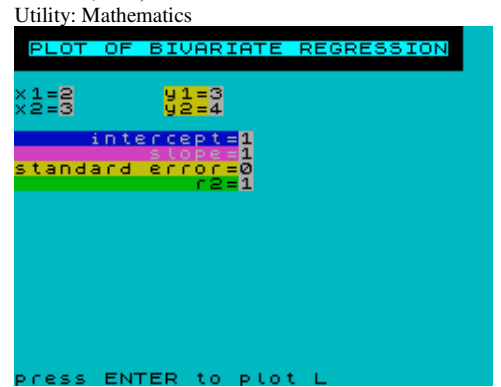

Plot-Print (.)

Utility: Font/UDGs



Plotter (MicroHobby,1984)

Utility: Drawing



Plotter, 3D (Ziga Turk,1984)

Utility: Mathematics

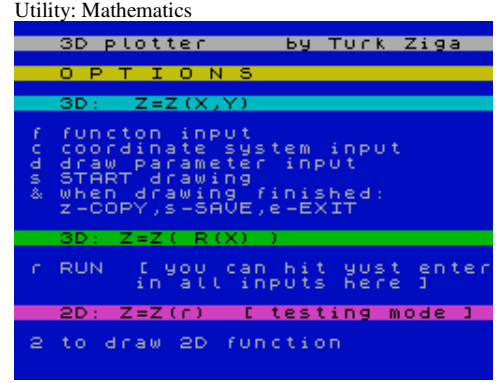

Plot, The (Firebird Software Ltd,1988)

Arcade

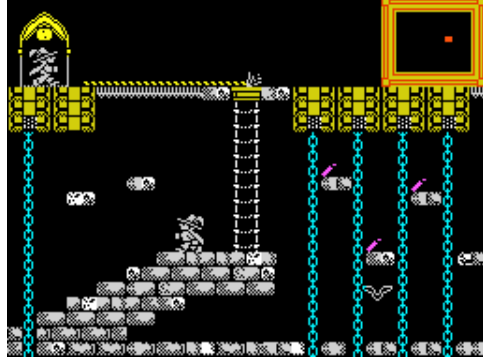

Plotting (Ocean Software Ltd,1990)

Arcade



Pluggit (Blaby Computer Games,1984)

Arcade



Plumber's Price (J. Redman,1985)

Utility



Plum Duff (Bug-Byte Software Ltd,1985)

Arcade



Plummet (Interceptor Micros Software,1984)

Arcade



Plunder (CCS,1983)

Strategy

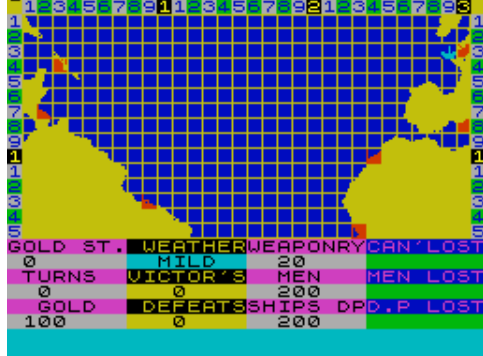

Plus 3 Adventures (Mastertronic Ltd,1988)

Compilation



Plus 3 Arcade (Mastertronic Ltd,1987)

Compilation

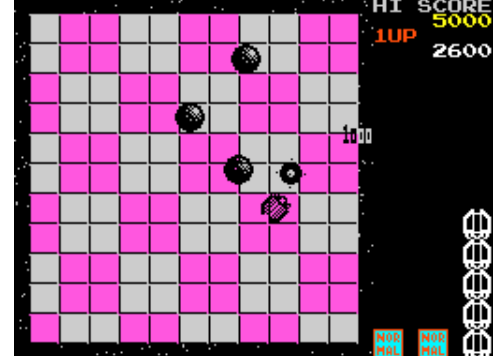

Plus 3 Biker (Mastertronic Ltd,1987)
Compilation

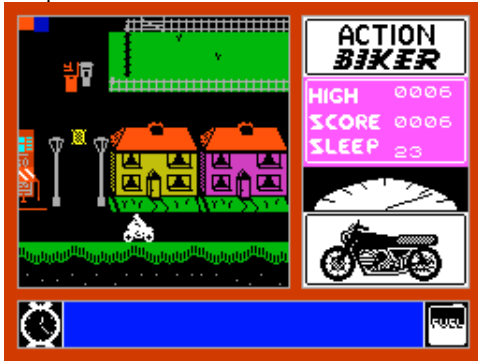

Plus 3 Hits (Mastertronic Ltd,1987)
Compilation

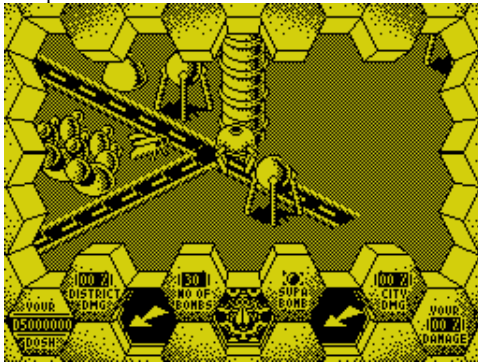

Plus 3 Pack (Gremlin Graphics Software Ltd,1987)
Compilation

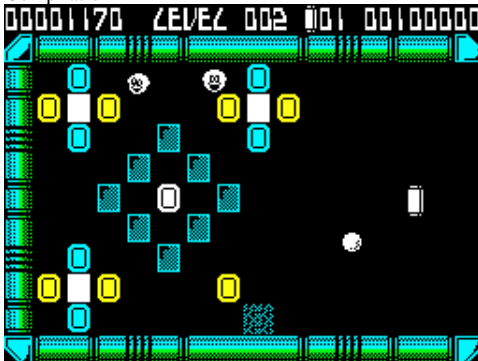

Plus 80 Address Manager (Oxford Computer Publishing,1984)
Utility

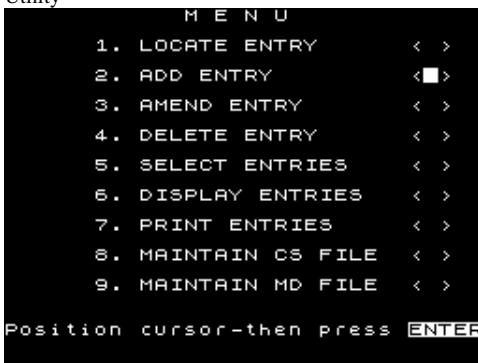

Plus 80 Stock Manager (Oxford Computer Publishing,1984)
Utility

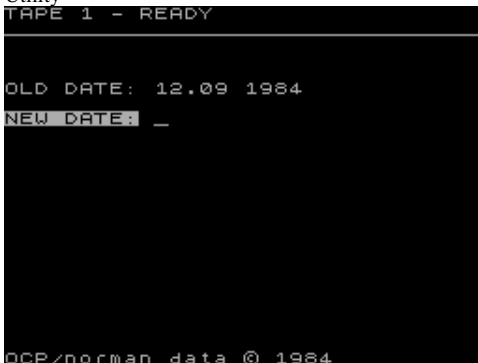

Plus 3 Diary & Filing System (Kobrahssoft,)
Utility: Database



Plus 3 Mate (Lerm Software,1991)
Utility



Plus 3 Sports (Mastertronic Ltd,1987)
Compilation

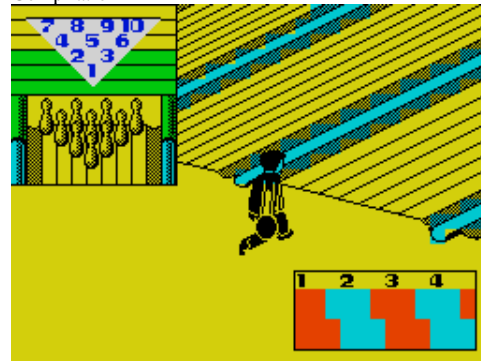

Plus 80 Finance Manager (Oxford Computer Publishing,1984)
Utility

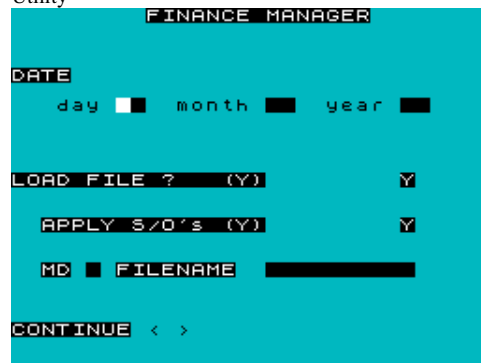

Plus 80 VAT Manager (Oxford Computer Publishing,1984)
Utility

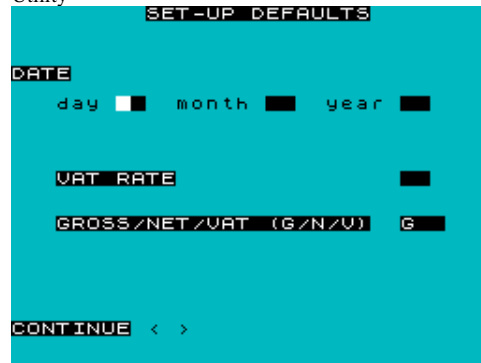

Plus 3 Games (.)
Compilation



Plus 3 Pack (Dinamic Software,)
Compilation



Plus 3 Utilities (.)
Compilation

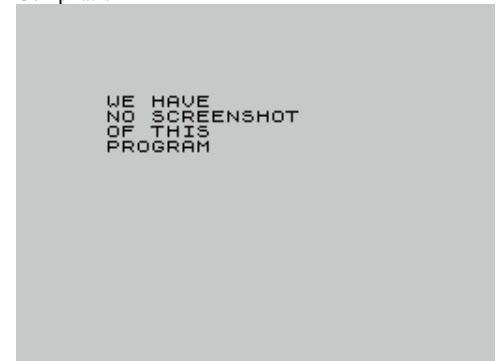

Plus 80 Full Screen Editor/Assembler (Oxford Computer Publishing,1984)
Utility: Assembler/Disassembler/Monitor

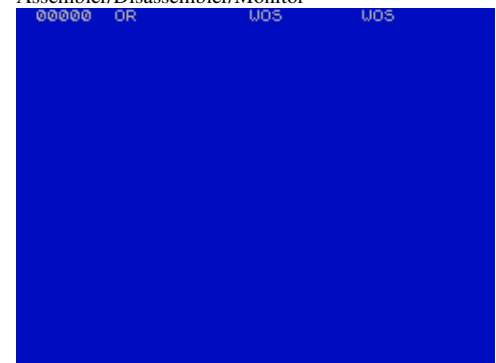

Plus 80 Word Manager (Oxford Computer Publishing,1985)
Utility: Word Processor



Plus D Disc Manager (Betterbytes Software,1989)
Utility



Plus D Hacker (INDUG,1988)
Utility

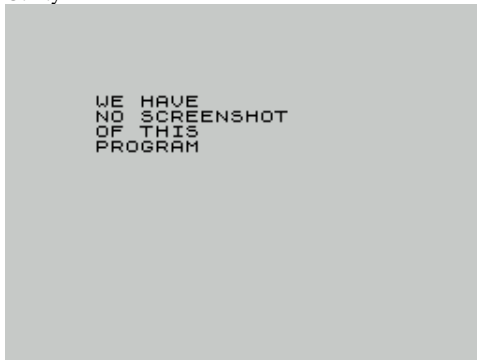

Plus D Hacker - Toolkit - Filer (S.J. Nuting,1989)
Utility

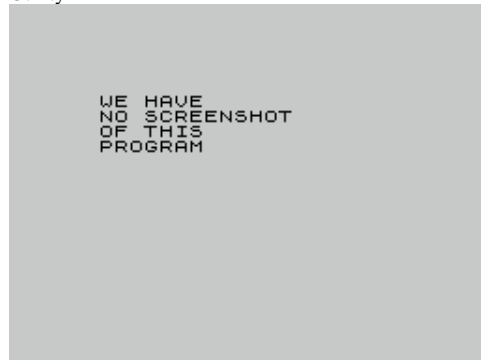

Plus D System Tape (Miles Gordon Technology,1988)
Utility



Plus D Util (Jose Manuel Claros,1990)
Utility



Plutonia (Sybilsoft,1987)
Text Adventure



Plutoniya (Twin Peaks,1996)
Text Adventure



Pneumatic Hammers (Firebird Software Ltd,1987)
Arcade



Pocker (.)
Board/Card Game



Pocket Book Games (Phipps Associates,1982)
Compilation

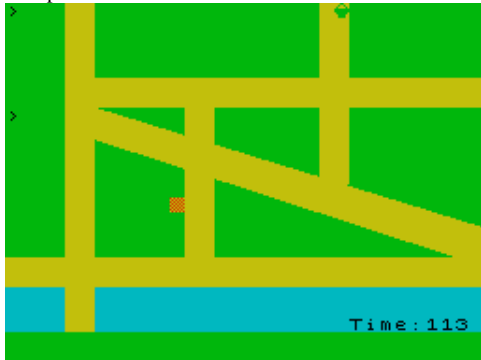

Pocky (MicroHobby,1985)
Arcade



Pod (Euro-Byte,1983)
Arcade



Podder (Central Solutions,1986)
Arcade

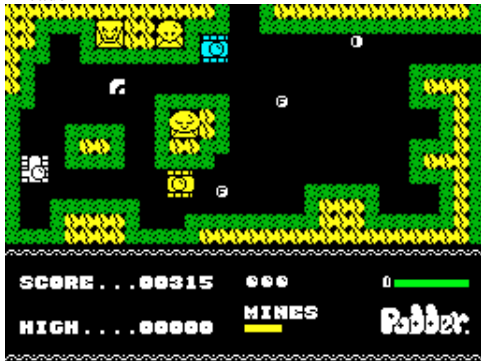

Poder Oscuro, El (Zigurat Software,1988)
Arcade



Podmornica (Radio Student,1984)
Strategy



Podpersons from Mars (The Lords,1990)
Scene Demo

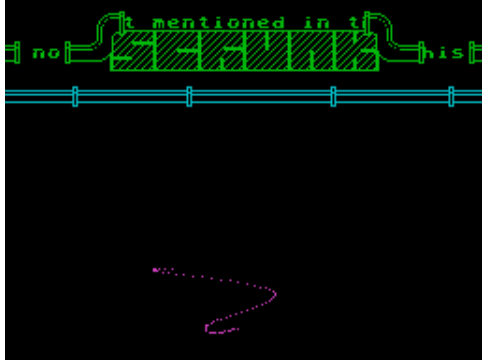

Podraz 4 (Raxoft,1988)
Text Adventure



Podraz 6 (Antok Software,1988)
Text Adventure



Pogostick Olympics (Silverbird Software Ltd,1988)
Sport

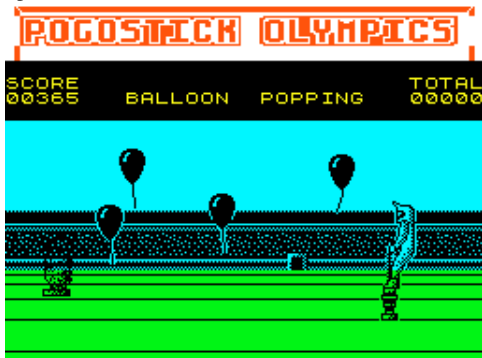

Point (Strangers Group/Entry Minds,1998)
Board/Card Game



Podraz 3 (Fuxoft,1986)
Text Adventure



Podraz 5 (Antok Software,)
Text Adventure

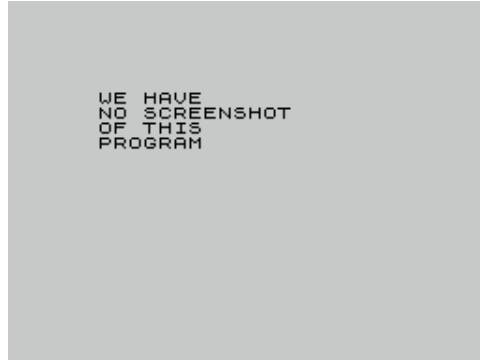

Podroz Po Polsce (Elkor Software,1987)
Strategy



Pogotron (Game Busters,1990)
Arcade



Point 5 (Icabod,2006)
Scene Demo



Podraz 4 (Antok Software,1987)
Text Adventure



Podraz 5 (Falcon Soft,)
Text Adventure

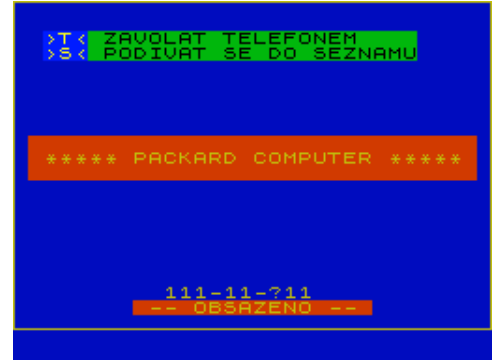

Pogo (Ocean Software Ltd,1983)
Arcade



Point (Icabod,2006)
Scene Demo



Point-A-Spot (Aasvoguelle Productions,1985)
Arcade



Point Set (A. Fylatov,1996)
Board/Card Game

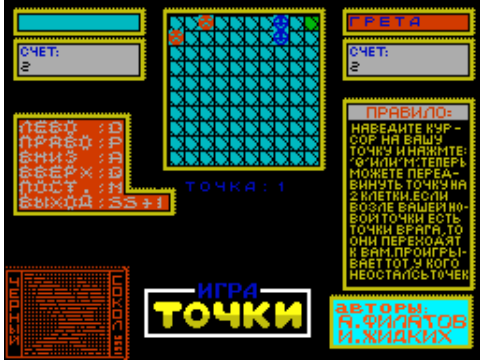

Poke Maker (Svet Kompjutera,1987)
Utility



Poker (Ducksoft,1985)
Board/Card Game



Poker (Spectrum Computing,1984)
Board/Card Game



Pokerama Tape 2 (Jon North,1990)
Utility



Poirot (MicroHobby,1986)
Arcade Adventure



Poker (.)
Board/Card Game



Poker (J.R. Hollingbery,1983)
Board/Card Game

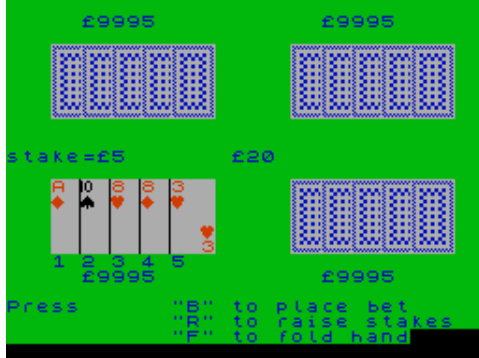

Pokerama Main Code (Jon North,1990)
Utility



Poker Club (Free Group,1994)
Board/Card Game

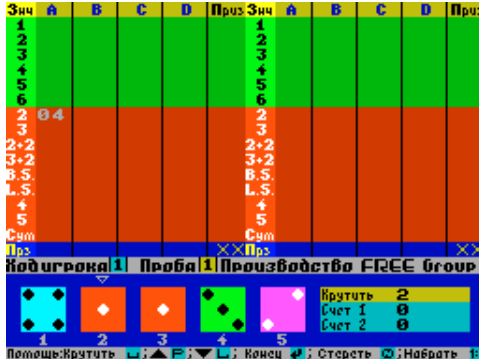

Pokeador Automatico (MicroHobby,1986)
Utility



Poker (De Barron Software Ltd,1984)
Board/Card Game

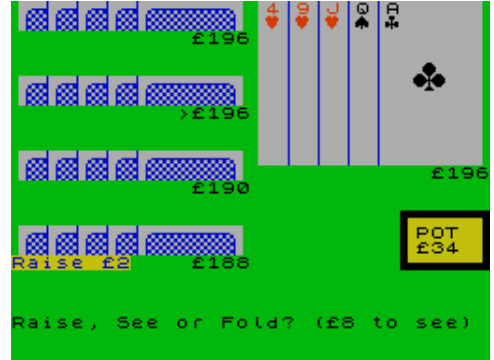

Poker (Master,1999)
Board/Card Game

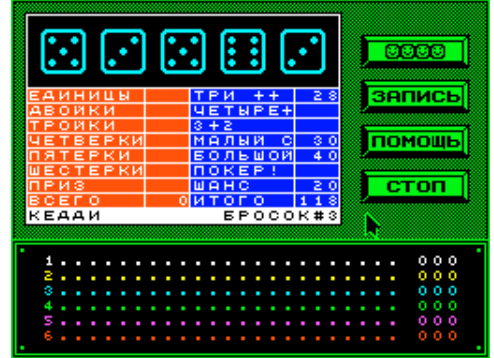

Pokerama Tape 1 (Jon North,1990)
Utility



Poker Club, The (George Calvere,1985)
Board/Card Game

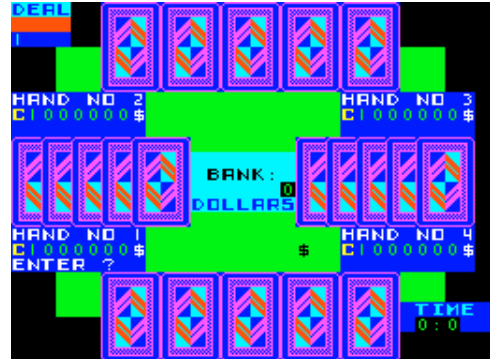

Poker de Dados (MicroHobby,1985)
Board/Card Game

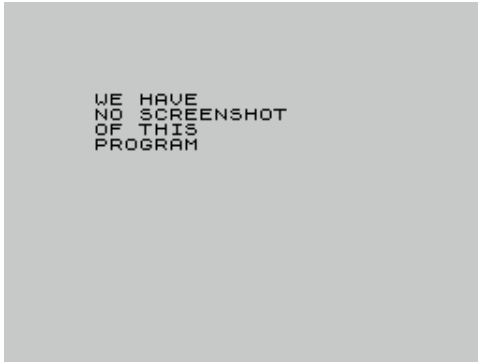

Poker Dice (Dymond Software,1983)
Board/Card Game

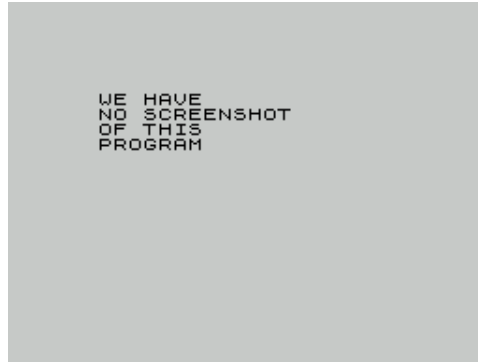

Poker Dice (Gilsoft International,1982)
Board/Card Game



Poker Dice Simulator (Frozen Ice,1989)
Simulation



Poker Entre Dos (MicroHobby,1985)
Board/Card Game



POKES (SuperSoft [2],2001)
Cheat

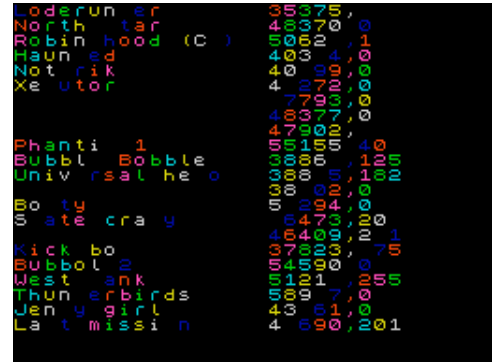

POKES 2 (SuperSoft [2],2001)
Cheat



Pokestripper (Individual Software Service,1986)
Board/Card Game

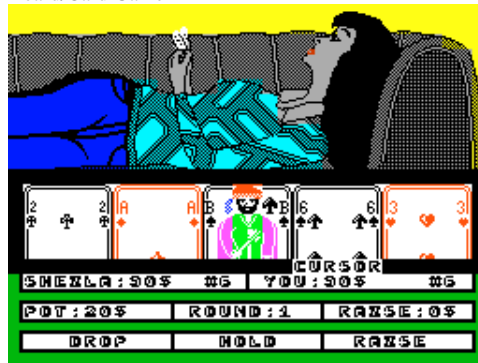

Pokes y Cargadores: Especial Patas Arriba n.1 (Micromania [2],1985) Covertape

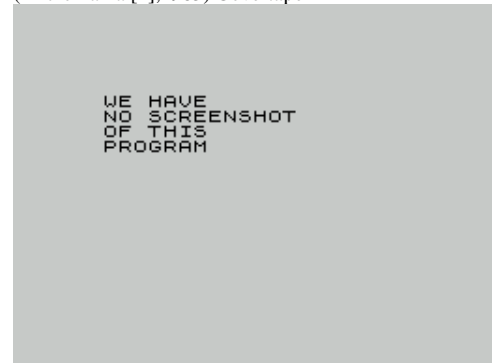

Poketape 2 (Dominic Morris,1992)
Cheat



Poklad (Proxima Software,1984)
Text Adventure

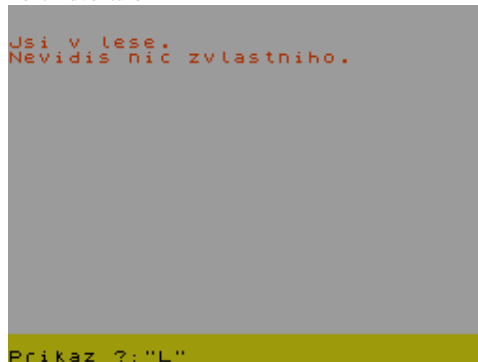

Poklad 2 (Proxima Software,1985)
Text Adventure

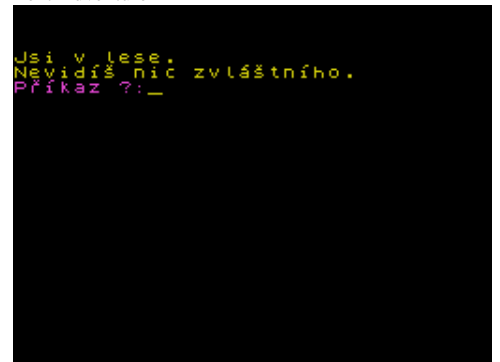

Polaris (CCS,1983)
Strategy

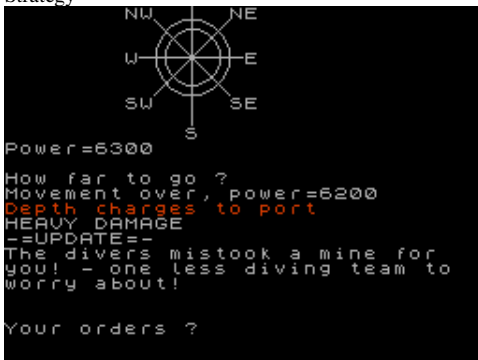

Polaris Patrol (Anik Microsystems,1984)
Arcade



Polbasic (Tadeusz Wilczek,1985)
Utility: BASIC Related

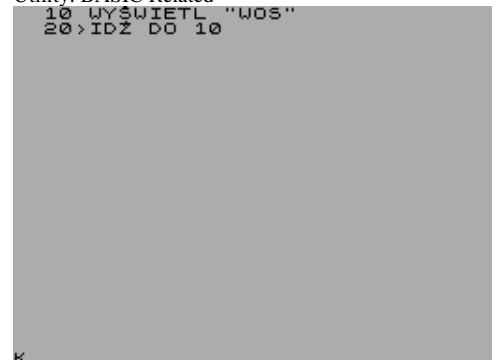

Polearn (Sheol Software,1988)
Text Adventure



Pole Chudes (SirotaSoft,1994)
Arcade

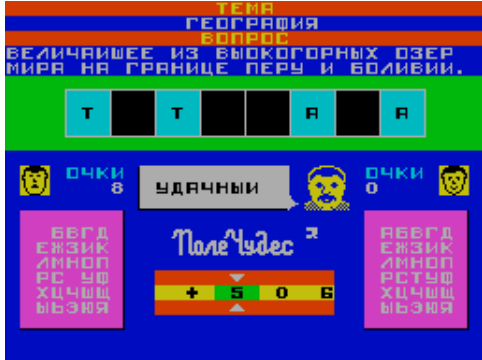

Pole Chudes 2 (SirotaSoft,1994)
Arcade



Pole Position (US Gold Ltd,1984)
Arcade



Poli Diaz (Opera Soft S.A.,1990)
Arcade

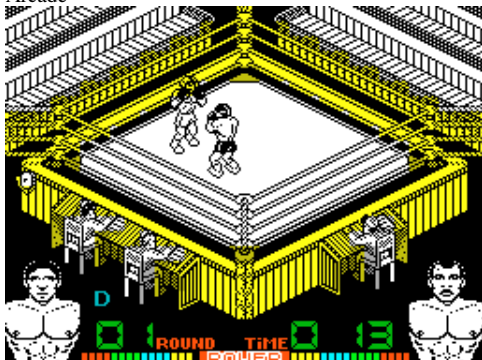

Polecat (C-Tech,1982)
Arcade

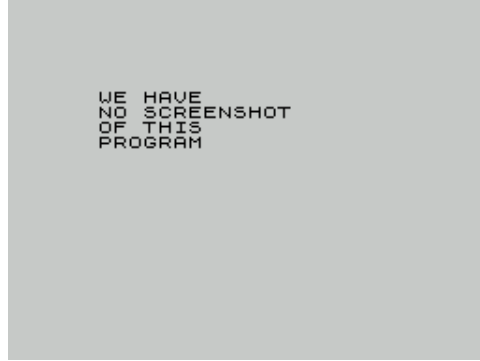

Pole Chudes (Softland,1995)
Board/Card Game



Pole Position (Atarisoft,1984)
Arcade



Police Demo (Sabe.)
Scene Demo



Polinomios (ABC Soft,1984)
Educational

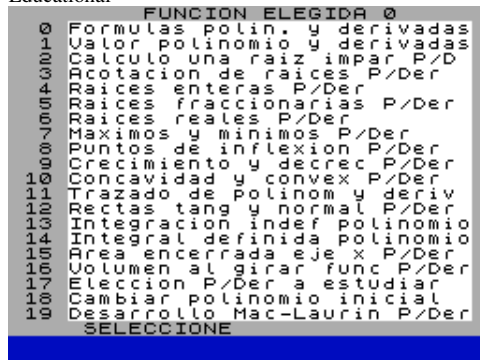

Pole Chudes (Outland Corp,1995)
Board/Card Game



Pole Chudes (Vladimir,1995)
Board/Card Game

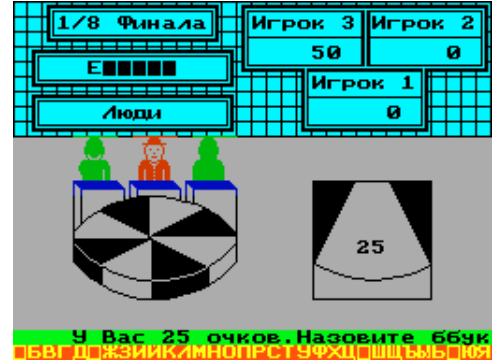

Pole Position (G. Whitehead.)
Arcade



Police Patrol Quiz (Flexibase Software,1988)
Educational



Polinomios I (MicroHobby,1985)
Educational



Polinomios II (MicroHobby,1985)
Educational

```
WE HAVE
NO SCREENSHOT
OF THIS
PROGRAM
```

Polinomios III (MicroHobby,1985)
Educational

```
WE HAVE
NO SCREENSHOT
OF THIS
PROGRAM
```

Polinomios IV (MicroHobby,1986)
Educational

```
WE HAVE
NO SCREENSHOT
OF THIS
PROGRAM
```

Politicar (Moj Mikro,1986)

Utility

```
UDRUZIVANJA RADA I SREDTAVA TE
REALIZACIJA ZADATAKA IZ
STABILIZACIONOG PROGRAMA
USPORAVA NEKE TRENDOVE NOVIH
PRIJEDLOGA. UOSTALOM, OBAVEZUJE
NA ANALIZU UKAZUJE NA NUZNOST
REDEFINIRANJA SISTEMA OPCE
PARTICIPACIJE. NASA BOGATA
REVOLUCIONARNA PROSLOST, KAO I
ZANEMARIVANJE DRUSTVENE ULOGE
OMLADINE POTENCIRA ZNACAJ
USMJERENOG OBRAZOVANJA KADROVA.
KAO STO JE POZNATO POLAGANI
PORAST PRODUKTIVNOSTI RADA
NAGLASAVA VAZNOST MODELA
DRUSTVENO EKONOMSKOG RAZVOJA.
UOSTALOM, ZANEMARIVANJE
DRUSTVENE ULOGE OMLADINE
UKAZUJE NA NUZNOST
REDEFINIRANJA VITALNIH PITANJA
RAZVOJA DRUSTVA. NEDOSTATAK
IDEOLOS.
```

Polskie Logo (Krajowe Wydawnictwo
Czasopism,1987)

Utility: Programming
©Zbigniew Kasprzycki

```
POLSKIE LOGO wersja 2.2
?WOS
```

Poltergeist (Firebird Software Ltd,1986)
Text Adventure



Poltergeist (PSS,1984)
Arcade

```
WE HAVE
NO SCREENSHOT
OF THIS
PROGRAM
```

Polygons (Shiva Publishing Ltd,1983)
Utility

```
WE HAVE
NO SCREENSHOT
OF THIS
PROGRAM
```

Polynomit (Otava,)
Educational

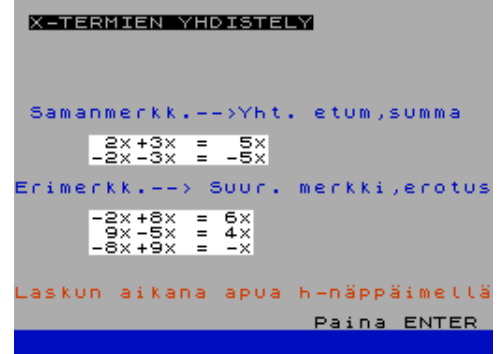

Pomocnik 2 (Polbrit International,1984)

Utility

```
INDEKS - STRONA 1
NR:      ADRES
1  PIXEL  SCROLL  ↑      640001
2  PIXEL  SCROLL  ↓      640008
3  *LINIA SCROLL  ↑      031900
4  PIXEL  SCROLL  ↑      640011
10  PIXEL  SCROLL  <      640043
11  LINIA  SCROLL  <      640070
12  LINIA  SCROLL  >      640111
13  SCROLL ZNAKU  W LEWO  640114
14  SCROLL ZNAKU  W PRAWO 640175
15  LINIA  LEWO-GORA SCROLL 640200
16  LINIA  PRAWO-GORA SCROLL 640200
17  WYPELNIANIE EKRANU    640200
18  ZAPIS  EKRANU ZA R-TOP 647444
19  ODCZYT  EKRANU        647566
20  WYMIANA EKRANOW       647844
21  ZAMIANA INK,PAPER     648009
22  *RESET                0
23  ZMIANA INK            648558
24  ZMIANA PAPER         648803
25  WLAZCZENIE FLASH     649114

NUMER/DEMO/PRINT/INDEKS C
```

Pondlife Preview (The Gasman,1997)
Scene Demo

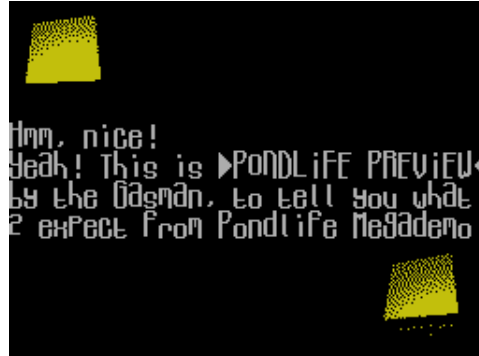

Pongo (Jonathan Ward/Andrew Neve,1983)
Arcade

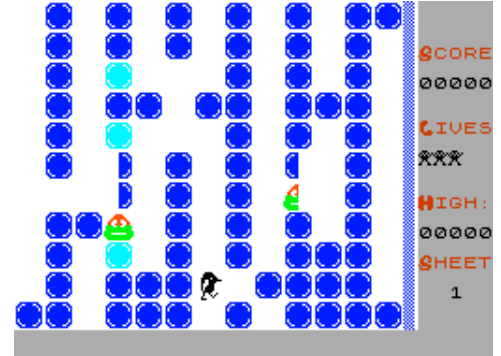

Ponlas en Raya (Load 'n' Run [Spa],1984)
Board/Card Game



Pontoon (16/48 Tape Magazine,1984)
Arcade

```
WE HAVE
NO SCREENSHOT
OF THIS
PROGRAM
```

Pontoon (Anco Software Ltd,1983)
Arcade

```
WE HAVE
NO SCREENSHOT
OF THIS
PROGRAM
```

Pontoon (Arcade Software,1983)
Board/Card Game

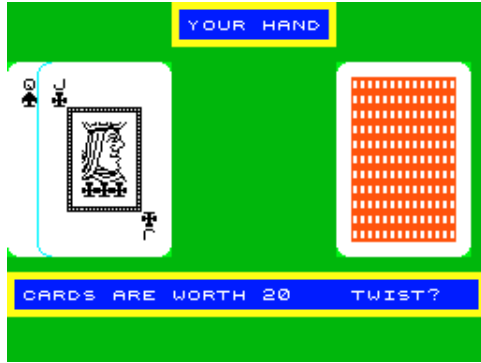

Pontoon (Keith Berry,1983)
Board/Card Game



Pontoon (Virgin Books,1983)
Arcade

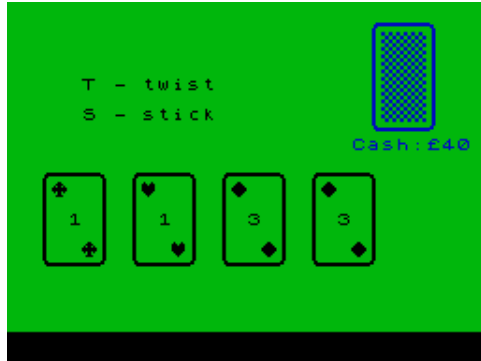

Poocake (The United Minds/Extacy-3,1995)
Scene Demo



Pool (Breadhill,1984)
Sport



Pontoon (Astro Software,1982)
Arcade

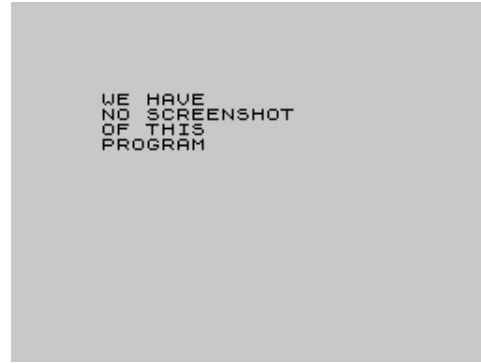

Pontoon (Oxford Computer Publishing,1985)
Board/Card Game



Pon Una Tarantula en Tu Vida (Nosequesoft,1989)
Text Adventure



Poogaboo (Opera Soft S.A.,1991)
Arcade



Pool (Bug-Byte Software Ltd,1983)
Sport

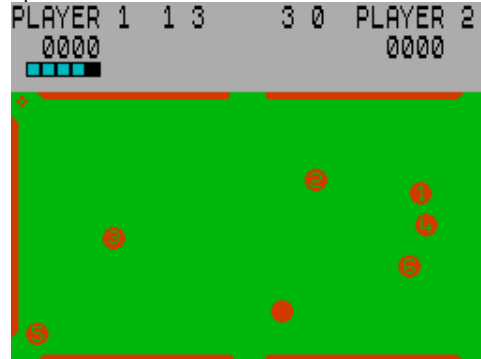

Pontoon (Contrast Software,1984)
Board/Card Game

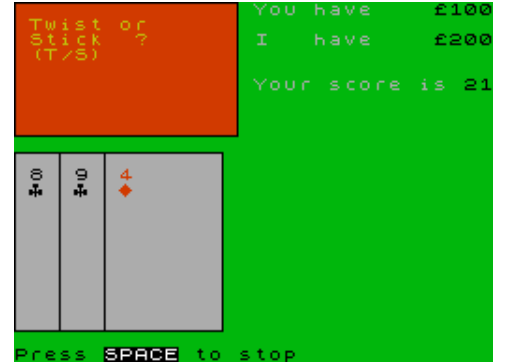

Pontoon (Sinclair User,1983)
Arcade

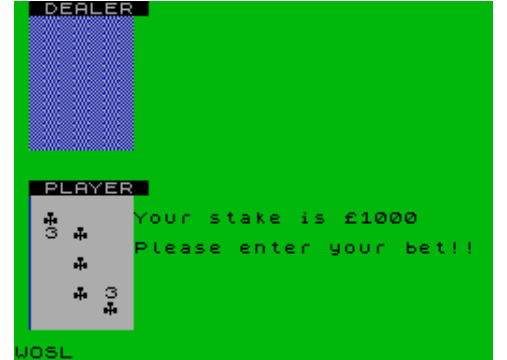

Pony Express (Vectis Software,1983)
Arcade



Pool (Abrasco,1983)
Sport

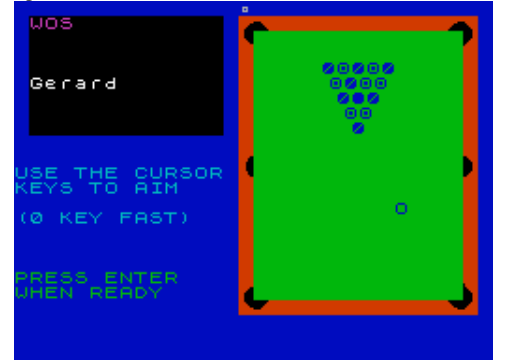

Pool (CDS Microsystems,1983)
Sport



Pool (Galileo,1986)
Sport

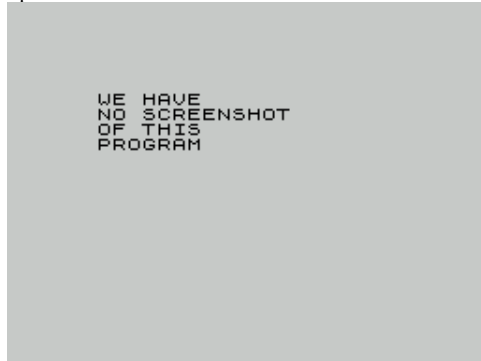

Pool (Omega Software Ltd,1983)
Sport

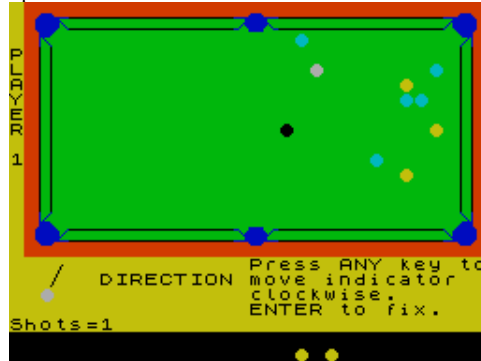

Pool, 3D (Firebird Software Ltd,1989)
Sport



Pooldemo I (Poolpet Software,1990)
Scene Demo



Pool Perm (J.A. Marris,1984)
Utility

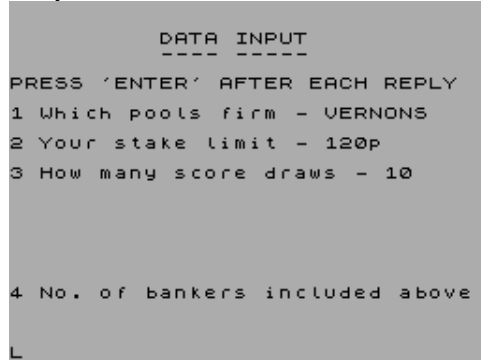

Pools (Basic Software Services,1988)
Simulation



Poolsdata (Selec Software,1983)
Sport



Pools Forecast (David Nowotnik,1983)
Utility

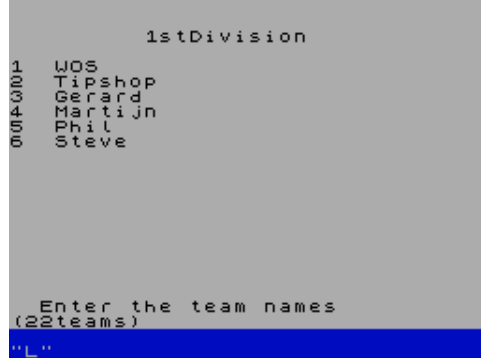

Poolsmaster (Asirus Software,1986)
Sport



Poolsmaster (Intraset Ltd,1989)
Simulation

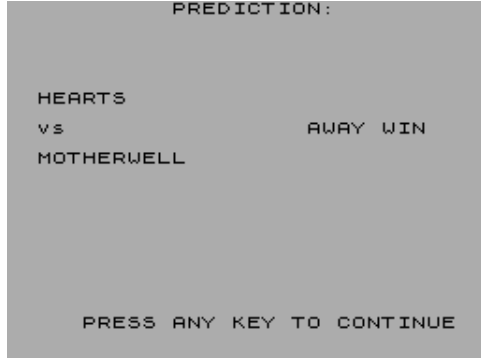

Pools Plan Checker (Cloud 10 Software,1984)
Simulation



Pools Prediction (Rombest,1984)
Simulation



Pools Prediction (Selec Software,1983)
Sport



Pools Predictions (Buffer Micro Ltd,1984)
Simulation



Pools Predictor (Corwen Computer Systems,1989)
Utility



Pool's Predictor (Mayday Software,1983)
Simulation

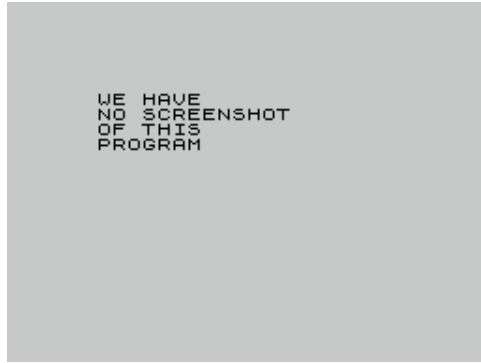

Popeye (DK'Tronics Ltd,1985)
Arcade



Popeye 3 (Alternative Software Ltd,1992)
Arcade



Pop Quiz '85 (Independent Software,1984)
Board/Card Game

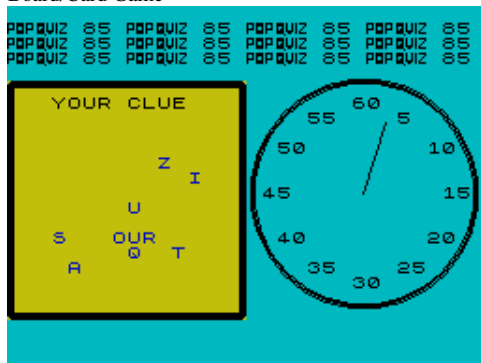

Pop Stars (Sinclair User,1991)
Arcade

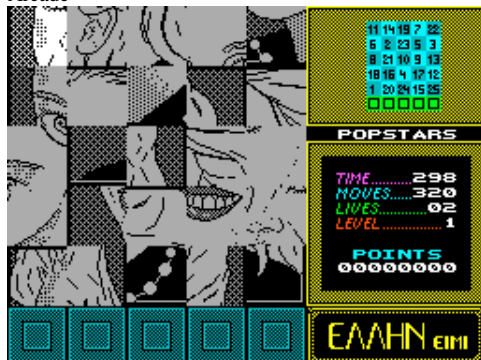

Poolswinner (Selec Software,1987)
Sport

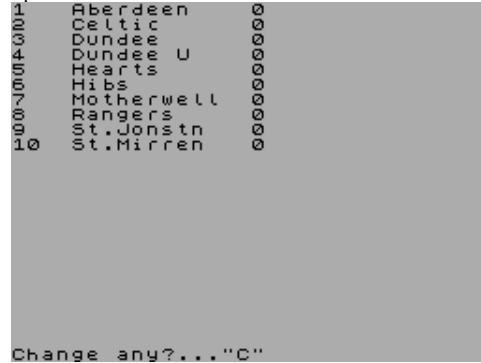

Popeye (Parker Software,1984)
Arcade



Popeye - The Collection (Alternative Software Ltd,1992)
Compilation



Pop Quizz (R.D. Foord Software,)
Board/Card Game



Popurri (Metalbrain,2006)
Compilation

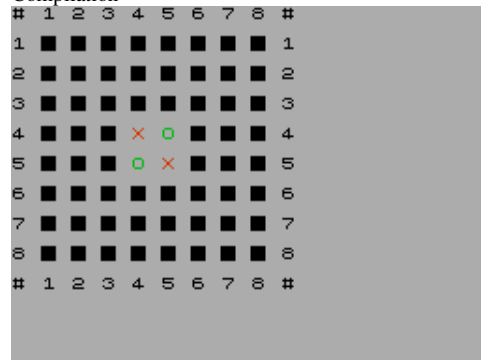

Pooyan (M. Marx,)
Arcade

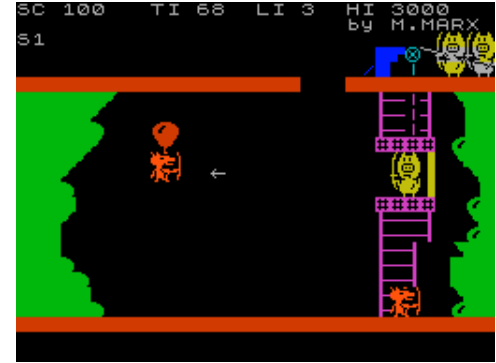

Popeye 2 (Alternative Software Ltd,1991)
Arcade

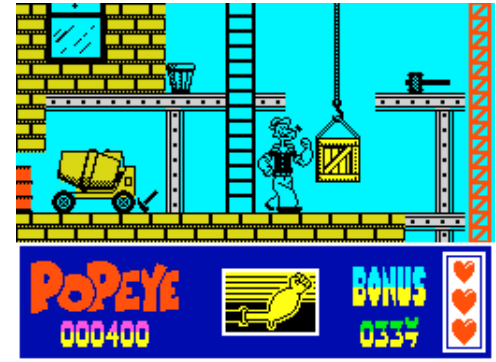

Popkey (B.G. Services,1991)
Utility

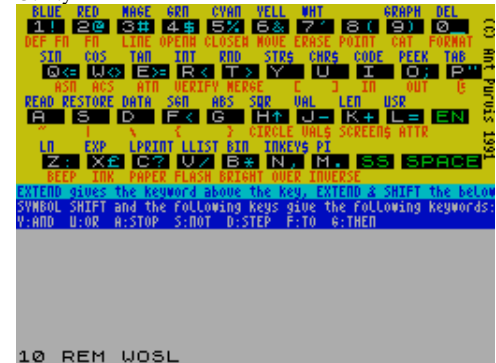

Popsnog (The Knuckle Girls,1994)
Scene Demo



Popurri-MC (MicroHobby,1985)
Utility: Programming



Poradce (Demon Software,1988)
Arcade

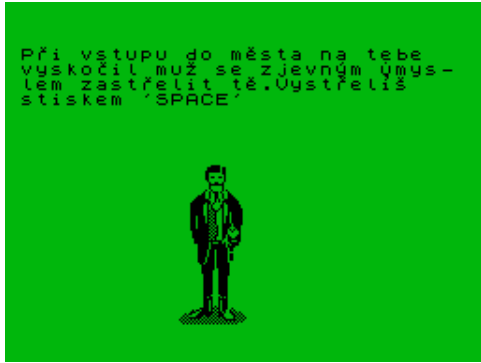

Porzellan (Laussoftware,1983)
Arcade



Poslednaya Avantura (A. Cherenov,1997)
Strategy

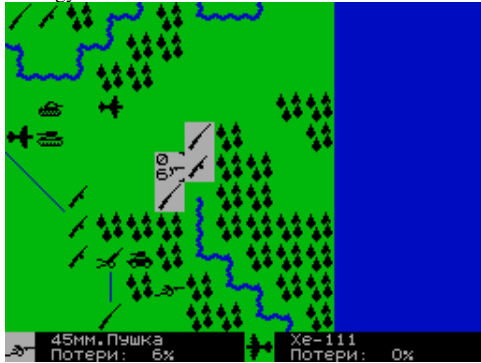

Post Mania (C&VG,1985)
Arcade

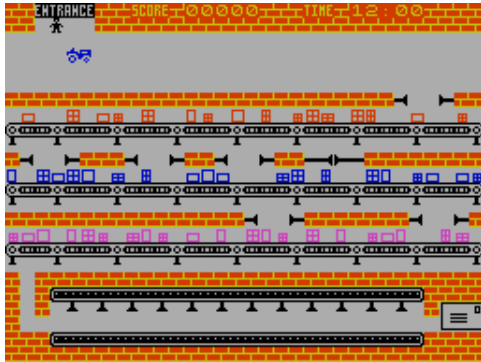

Postman Pat 3: To the Rescue (Alternative Software Ltd,1992) Arcade

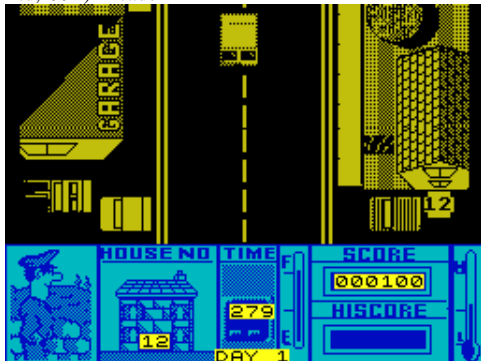

Portals of P'Thaal (Sinclair User,1987)
Arcade Adventure

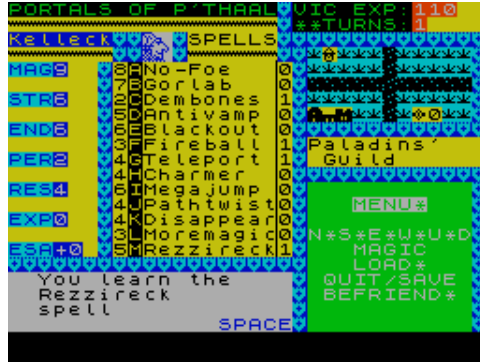

Poseidon: Planet Eleven (Hi-Tec Software Ltd,1990)
Arcade



Poster Machine (Softcat Micros,1986)
Utility: Drawing



Postman Pat (Alternative Software Ltd,1988)
Arcade



Postman Pat Hit Collection, The (Alternative Software Ltd,1992) Compilation



Port Demonstration (Vyacheslav V. Strunov,2006)
Utility

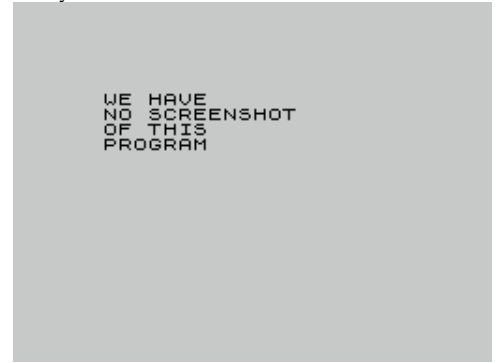

Posh List (Deltarho,1986)
Utility



Posthorn (Satyr Software,1986)
Board/Card Game

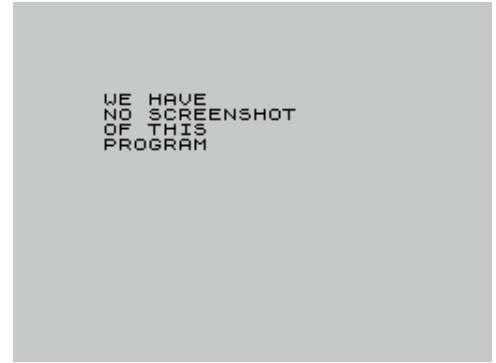

Postman Pat 2 (Alternative Software Ltd,1989)
Arcade



Postman Pat's Trail Game (Longman Software,1984)
Arcade



Post Mortem (Iber Software,1987)
Arcade Adventure



Pot-Pourri (JRS Software Ltd,1983)
Compilation



Potty Pigeon (Gremlin Graphics Software Ltd,1984)
Arcade



Powerama (The Power House,1988)
Arcade



Power Analytic 3 (Samir Ribic/Zeljko Juric,1988)
Utility: Mathematics

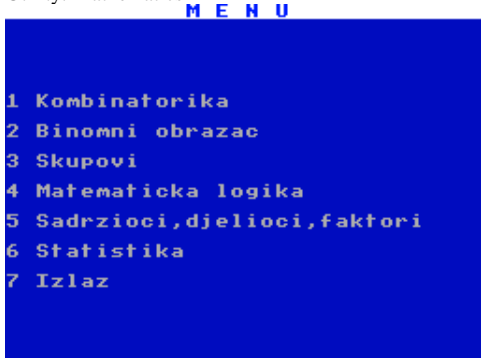

Potato Olympics (.)
Arcade

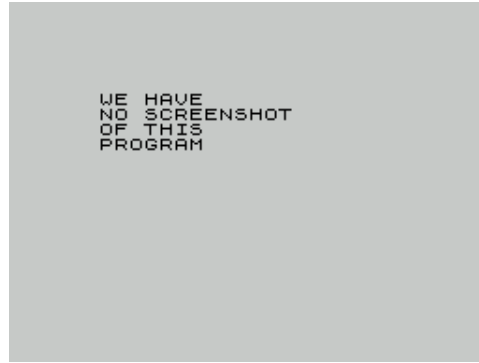

Potsworth and Co (Hi-Tec Software Ltd,1992)
Arcade

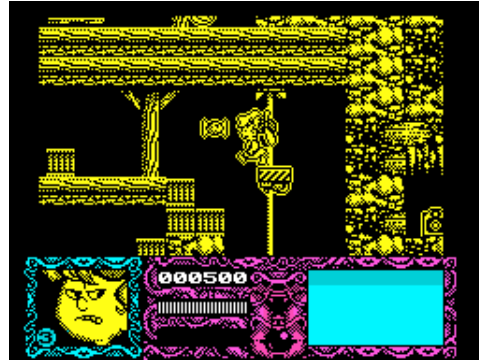

Potty Planter (Mogul Communications Ltd,1984)
Arcade

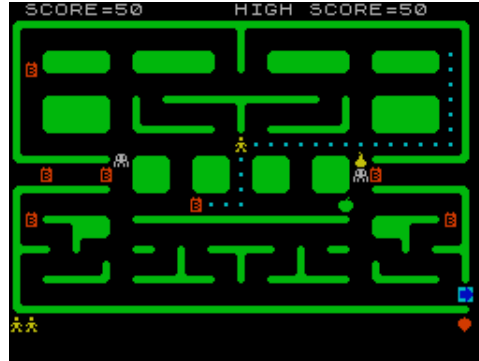

Power Analytic 1 (Samir Ribic/Zeljko Juric,1988)
Utility: Mathematics

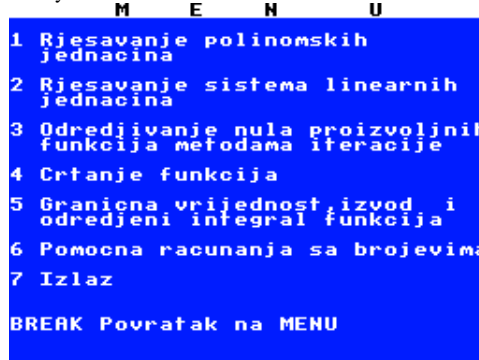

Power Analytic 4 (Samir Ribic/Zeljko Juric,1988)
Utility: Mathematics

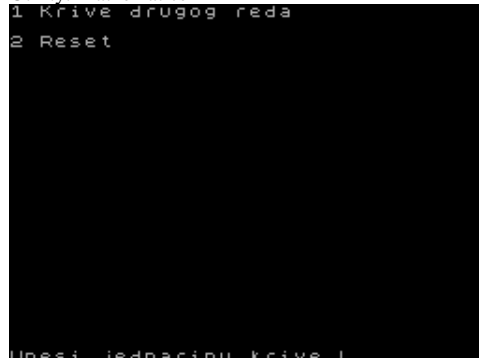

Potholer (Southway Software,1986)
Text Adventure



Potty Painter (Rabbit Software Ltd,1983)
Arcade

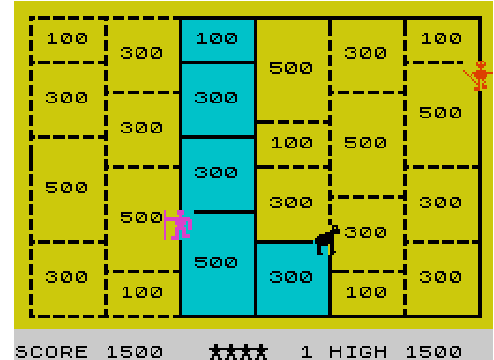

Potty Professor (Software Farm,1985)
Arcade



Power Analytic 2 (Samir Ribic/Zeljko Juric,1988)
Utility: Mathematics

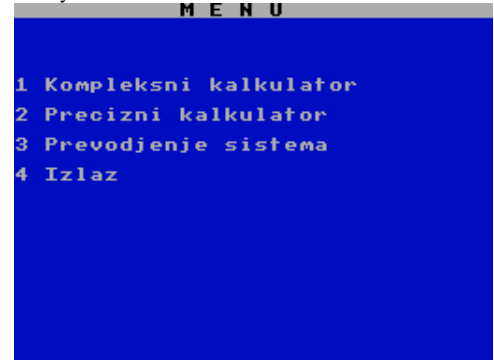

Power Ball (Flash Inc,1993)
Arcade

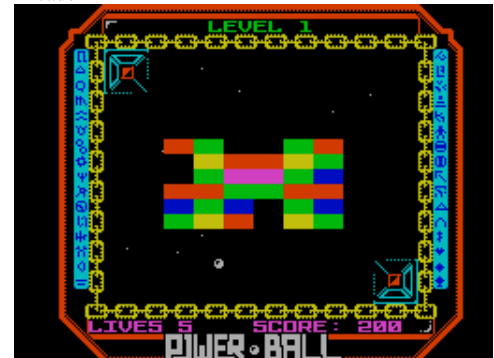

Powercross (VTS,2001)

Utility: Drawing



Powergrid (Fontana Publishing,1984)

Arcade

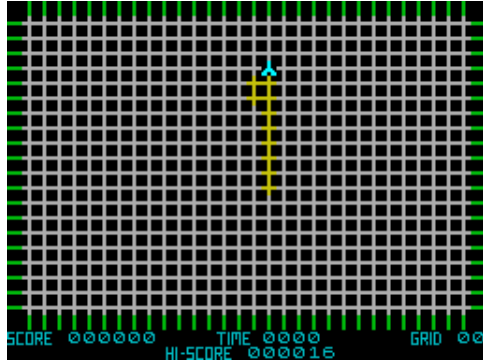

Power of Illusion (Illusion Group,1995)

Scene Demo

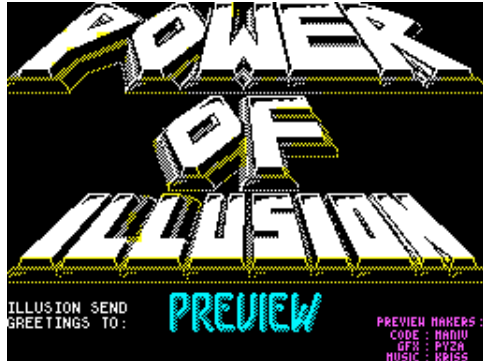

Power Plays (The Power House,1987)

Compilation



Powersports (Zigurat Software,1991)

Compilation



Power Drift (Activision Inc,1989)

Arcade

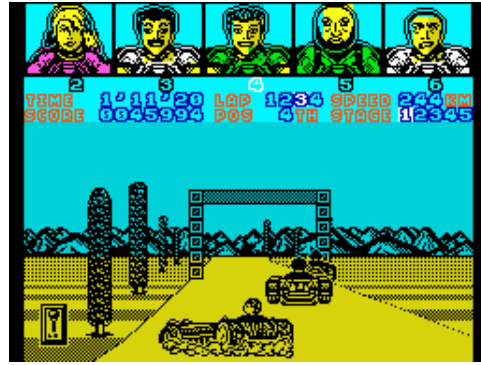

Power House (Sector Software,1983)

Arcade



Power Pack (Paxman Promotions,1990)

Compilation



Powerprint II (Buttercraft Software,1985)

Utility



Power Struggle (PSS,1987)

Strategy



Power Graphics (Buttercraft Software,1983)

Utility



Power & Magic (Zigurat Software,1990)

Arcade Adventure



Powerplay - Game of the Gods (Players Software,1988)

Arcade



Power Pyramids (Grandslam Entertainments Ltd,1986)

Arcade



Power Up (MegaCode/Extreme,1997)

Scene Demo

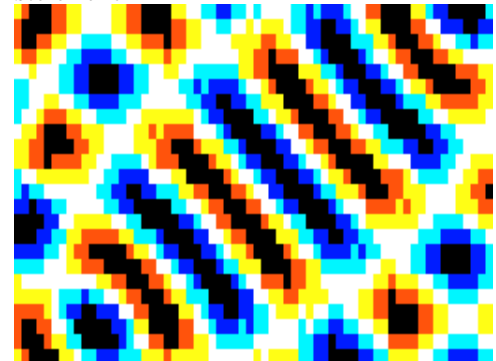

Power Up (Ocean Software Ltd,1991)
Compilation

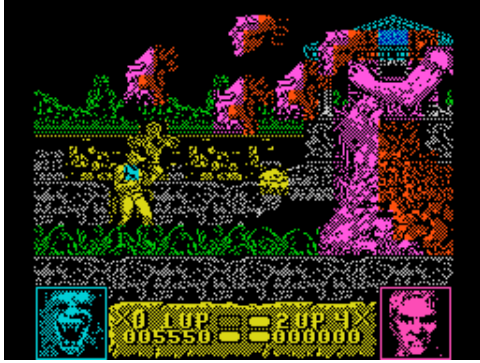

Pozycj Mikosne (ERL Computer Software,1987)
Arcade



Pravila Dorojnogo Dvijiya (ALS & RLS,1998)
Board/Card Game

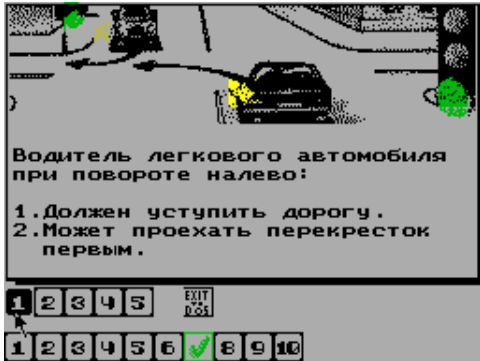

Predator 2 (Image Works,1991)
Arcade

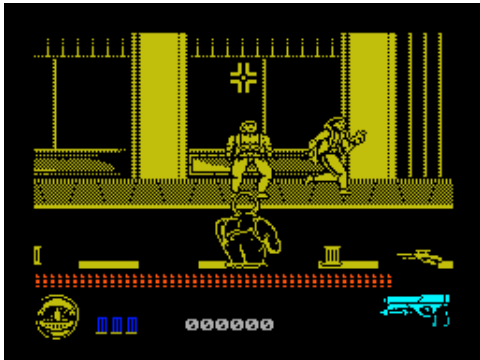

Prehistoria, La (Grupo Creators Union,1990)
Text Adventure



Pozar Wiewowca (.)
Arcade



Practically Impossible (ACME Software Ltd,1983)
Arcade

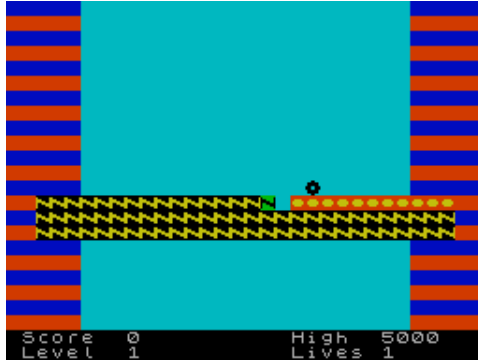

Prayer of the Warrior, The (Zigurat Software,1991)
Arcade Adventure



Prediction Birthday File, The (Blandford Press,1985)
Utility

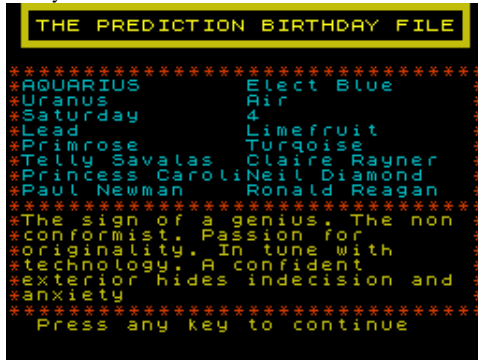

Prehistoric Adventure (Crusader Computing,1986)
Text Adventure

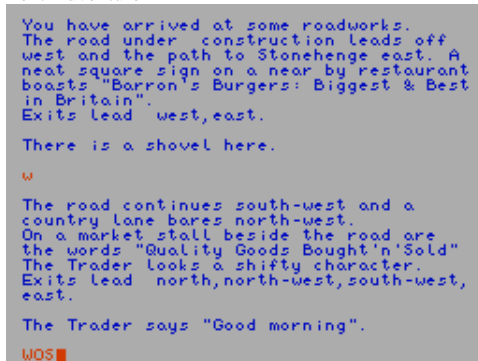

Pozitron (Neil Pawson,1986)
Arcade



Prang's Fancy Scroll (Spectrum Computing,1983)
Utility: BASIC Related



Predator (Activision Inc,1987)
Arcade



Pref Club (Sam/Sinclairland,1995)
Board/Card Game

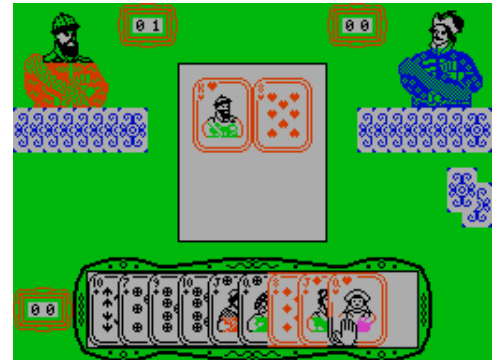

Pre-history (The Adventure Workshop,1992)
Text Adventure

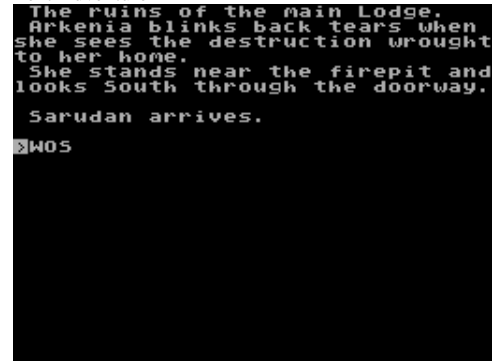

Prelude (Central Solutions,1985)

Text Adventure

```
You stand at the desk of the
G.O.'s secretary.
The main doors are open to the
east while another open door
lies to the north.
You can also see:-
The G.O.'s secretary.
WHAT NEXT ?
WOS
```

Premier League + European Trophy (E&J Software,1985)

Compilation

```
TRANSFER MARKET - BUY A PLAYER
Enter Team & Player number

Select option and press enter
TEAM C
```

President (Addictive Games Ltd,1987)

Simulation

```
IMPORT NEW TANK? YES NO
```

President 2 (Oleg Krasov,1992)

Strategy

```
Остров Флорес
ГОД 1
Ваш капитал 84000 дол.
Крестьян - 470
Солдат - 0
Земли - 1882 кв. миль
Пахотной земли - 941 кв. миль
Иностранных рабочих - 0
В этом году земля стоит 105 дол. кв. миль
Стоимость засева 13 дол. кв. миль
Уровень загрязнения 7 условных единиц
Сколько кв. миль вы продаете промышленникам ?
```

President's Guard (Cannonball,1991)

Arcade

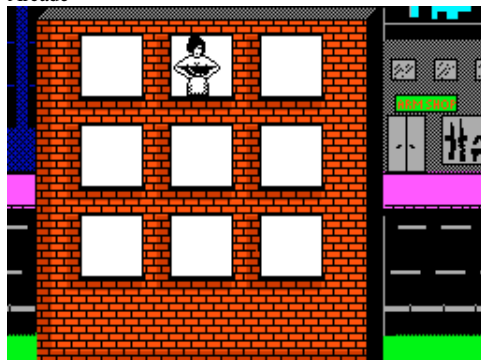

Premier II (E&J Software,1986)

Simulation



Pre-School and Early School Tutor (Essex Software,1983)

Educational

```
ADDITION.
+
1 1
* * * * *
* * * * *
WOSL
```

President (Izhevsk,1995)

Simulation

```
ФИРМА DARK NIGHT ПРЕДСТАВЛЯЕТ
ИГРУ ПРЕЗИДЕНТ ПЛЮС !!!
ENTER - НАЧАЛО ИГРЫ
L - ЧТЕНИЕ ИГРЫ
S - ВЫКЛ. ЗВУК
H - ИНСТРУКЦИИ
```

President 3: Great Britain (T.O.M.,1994)

Strategy

```
*****ПРЕЗ. *greg*****
СРОК: 1 *ВЕЛИКОБРИТАНИЯ* ГОД: 1
ИНФЛЯЦ: 14 КУРС ДОЛЛ. К ФУНТУ: 1.89
БЕЗРАБ: 1.3 РЕЙТИНГ ПРЕЗИДЕНТ: 17
ЭФ. РЕФФ ОБЩИИ БАЛАНС: £ -10457
СОСТАВ НАСЕЛЕНИЯ
55M ЛЮДЕЙ (общее число)
(10M Детей + 12M Пенсионеров)
955000 Компании
ПОСТУПЛЕНИЯ ОТ
Налога на Доб. Стоимость 13694M
Подоход. Налога £ 59713M
Налога на Прибыль £ 51509M
Акцизными сбор £ 8954M
ВСЕГО ПОСТУПИЛО £ 133870M
ПОТРАЧЕНО £ 144327M
БАЛАНС £ -10457M
НАЖМИТЕ ДЛЯ ПРОДОЛЖЕНИЯ (ЕНТЕР)
```

Pressor 6 (Proxima Software,1992)

Utility: Screen Manipulation

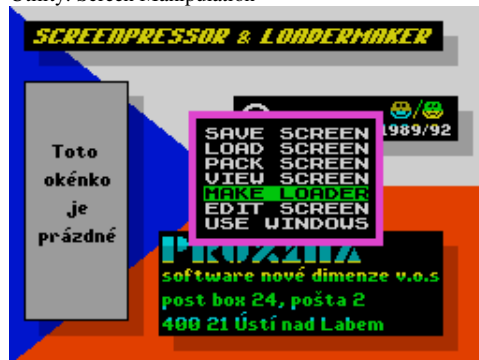

Premier League (E&J Software,1985)

Simulation

```
TRANSFER MARKET - BUY A PLAYER
Enter Team & Player number

Select option and press enter
TEAM C
```

Presents (Eugene Stepanoff,1991)

Scene Demo

```
WE HAVE
NO SCREENSHOT
OF THIS
PROGRAM
```

President + (Dark Night,1994)

Strategy

```
НАЛИЧНЫЕ СРЕДСТВА - 5422$
В НАСТОЯЩЕЕ ВРЕМЯ ВЫ -
БИЗНЕСМЕН
В ЭТОМ ГОДУ ВЫ МОЖЕТЕ ПРИНЯТЬ
УЧАСТИЕ В ВЫБОРАХ.ЕСТЬ МЕСТО:
ЛИДЕР МУСОРИКОВ
ЗАТРАТЫ НА ВЫБОРЫ - 1523$
ШАНС НА ПОБЕДУ - 0%
УЧАСТВУЕТЕ В ВЫБОРАХ? (Y/N)
```

Presidente (,)

Strategy

```
**BUENA SUERTA**
UD. TIENE 89915 PESETONES
396 NATIVOS, Y 2000 KM2 DE TERRE
NOS.
LA INDUSTRIA COMPRA A 96 PESETON
E5 KM2.
PLANTAR CUESTA 11 PESETONES KM2.
CUANTO LE VENDE A LA INDUSTRIA
```

Press, The (Gilsoft International,1986)

Utility

```
THE Press
[A] LOAD DICTIONARY
[B] SAVE DICTIONARY
[C] COMPILE & COMPRESS
[D] USE DICTIONARY
[I] SAVE database
[J] VERIFY database
[K] LOAD database
[T] LOAD TYPEFACE
[O] RETURN TO BASIC
Select Facility Required
```

Prestel 1: Micromouse (Prestel Tapezine,)

Simulation

Prestel has been slow to take off, in fact, some say it hasn't started yet. However, the advent of the Prism UTX5000 modem for the Spectrum may at last bring the mass user base for which the system was originally conceived. Micronet is just a part of the Prestel system, and has been in operation for only a little more than a year, but already Micronet claim up to a quarter of the 'accesses' totted up by the huge database, around 3 1/2 million in January. Not bad for a minority interest on what started out as a service providing city news and information for travel agencies (still a major threat!). There are supposed to be hundreds of thousands of pages on Prestel, even Telecom probably

Page 2

Prestel 4: Newsflash (Prestel Tapezine,)

Simulation

One of the great advantages of netting is the up-to-the-minute micro news. The net is ahead of all the mags, even the weeklies, and to symbolise this, I have chosen an item I fully expect to be still current by the time you read it! This is another feedback area, as users are invited to send in news stories of their own. I check the news pages daily, often reading about a new product launched days before Chris gets around to forwarding the press invitation in my post! Most of the 'Information Providers' have a 'what's new' page listing their recent additions. On Micronet this includes new software, letters and updates of regular features. Updating does

Page 2

Prestige Collection, The (Activision Inc,1987)

Compilation



Pretty Girl 2 (3T Software,1994)

Board/Card Game

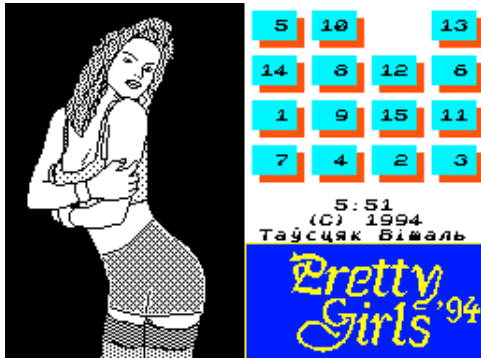

Pride Utilities (Pride Utilities,1984)

Utility

```
Play tape, press break to NEW
Program: @LOADER1
Length: 779 Start line: 1
Length vars: 11
Program: @LOADER
Length: 1185 Start line: 1
Length vars: 0
Program: @DISCAT1
Length: 841 Start line: 20
Length vars: 0
Program: @DISCAT
Length: 6560 Start line: 9100
Length vars: 2145
Bytes: @DISCODE
Length: 30 Start: 31000
```

Prestel 2: Heartsearch (Prestel Tapezine,)

Simulation

Wups! What's this got to do with computing? Well, it's great fun to poke around in what everyone else is up to (in this case, hanky-panky), and, while those of us with stable relationships may regard Heartsearch with amusement, there are other bulletin boards for penpals, hobbies, and clubs. Computer interest areas also have small ad sections where you can place notices to buy and sell, or just a cry for help in the dungeon. This is where Prestel becomes exciting for me, because, vast as it is, it will respond to you and you can contact the other users who, invisibly, inhabit the place with you. The numbers in the notices are not for phoning but for electronic mail, via

Page 2

Prestel 5: Aladdin's Cave (Prestel Tapezine,)

Simulation

and Viewfax have stopped allowing small ads even for software 'originals' due to fears that people are selling the originals after making a copy to keep. I reckon they've been got at. This obsession with sales lost to piracy is a sickness. Of course it goes on and it is certainly wrong, but a £200 schoolboy collection of pirated games doesn't represent £200 lost sales. Where would he have got £200 from if he hadn't been able to pirate? Anyhow, as a guest on the 'net I didn't download any pricey progs, only some free ones, and I was pleasantly surprised. More stuff is being added here daily, especially for the Spectrum. It might appeal more to people who don't get sent review software.

Page 3

Pretty Crazy (Alternative Software Ltd,)

Arcade



Price of Magik, The (Level 9 Computing Ltd,1986)

Text Adventure



Priest & Vampire (Your Computer,1984)

Arcade

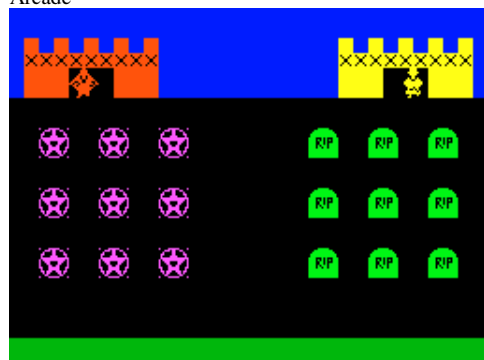

Prestel 3: Micrognome (Prestel Tapezine,)

Simulation

Micronet is not the only area of Prestel to be devoted to the micro. Viewfax is a similar sort of thing (eek! flying brickbats) but open to all, whereas Micronet costs £8 a quarter on top of Prestel's £5 subscription. The Gnome is Viewfax's columnist, specializing in Acorn news of the unofficial kind. We are reproducing one of his more innocent screens as Acorn are such a litigious bunch. The Gnome has also revealed page numbers which non-subscribers can use to get in to the free software on Micronet (the 'nets routing management' being somewhat flaky at best). Viewfax, and to a lesser extent Micronet, give more space to Acorn computers than the size of their user base can justify.

Page 2

Prestel 6: Hotlips (Prestel Tapezine,)

Simulation

Valentines are supposed to be anonymous, and this one goes one better, as we don't really know who it's to, either. Computing Today is the senior magazine around here and gets its name on everything, but that is our box number too. If you're on Prestel you could use it to send us one of BT's nice birthday cards. If you are not on, you might want to know some details. The Prism UTX5000 costs about £100. If you don't have one of BT's new style phone jacks, it will cost about £25 pounds to put in. That is all you need to pay, for hardware. The subscriptions are £20 per year for Prestel and £32 more for Micronet (optional) plus time charges if you call up during office hours. These are

Page 2

Pretty Girl (3T Software,1994)

Board/Card Game

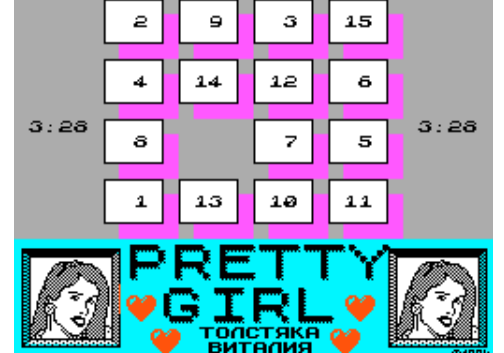

Pride of the Federation (Excalibur Software,1987)

Text Adventure

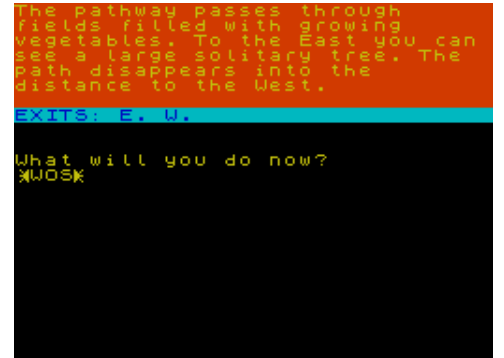

Prijsvraag, De (MCN Software,1985)

Arcade



Primary Arithmetic (Rose Software,1982)
Educational

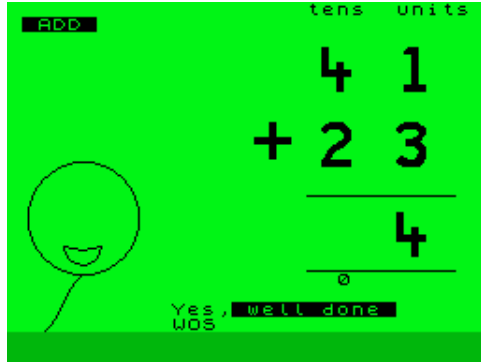

Primes by Div (Computer Programs That Work!.)
Utility: Mathematics

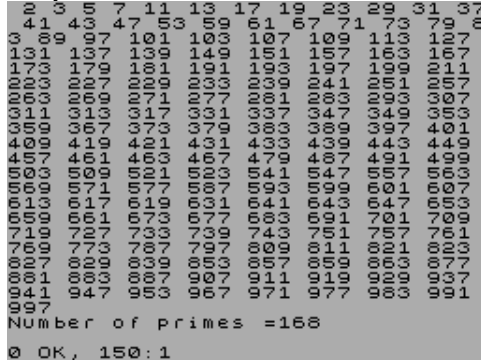

Prince of Persia Playable Demo (Magic Soft,1995)
Arcade

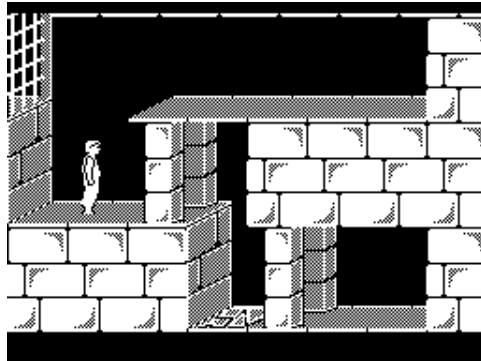

Prince, Princess and the Wicked Witch (Finsbury Software,1984) Text Adventure



Prince, The (CCS,1984)
Arcade Adventure



Prime Calculator (Sinclair Programs,1984)
Utility: Mathematics

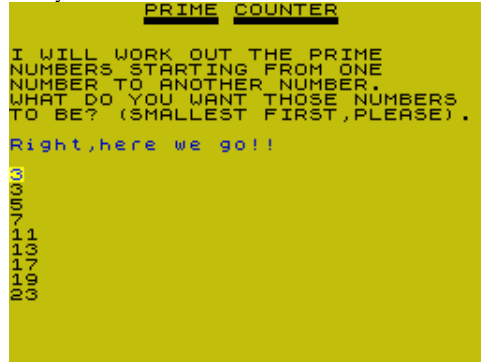

Prince Clumsy! (Cartoon Time,1990)
Arcade Adventure

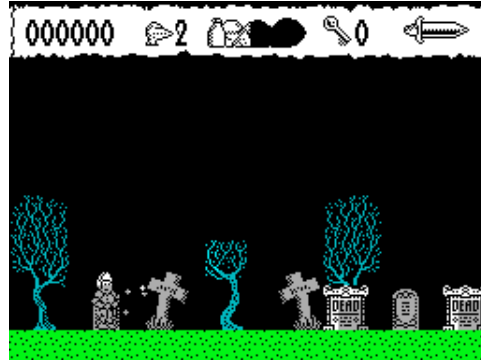

Prince of the YoikFolk (Code Masters Ltd,1991)
Arcade



Princesa, La (Software Center S.A.,1985)
Text Adventure

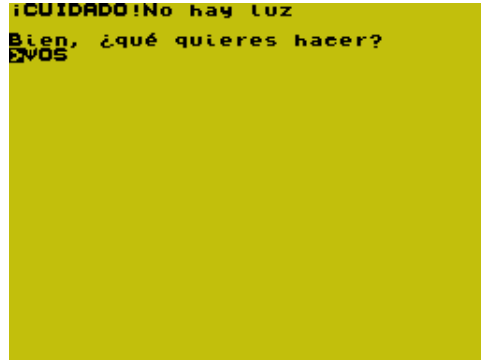

Prinsessen i Berget det Blaa (.)
Text Adventure

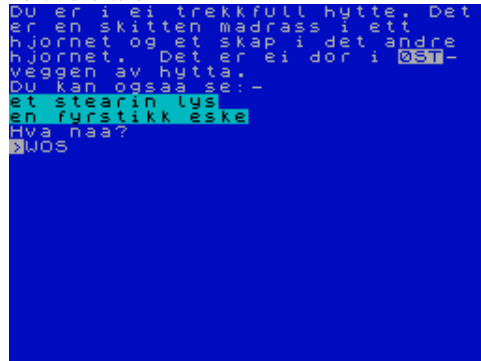

Prime Number Generator (Marcus Jay,2001)
Utility: Mathematics

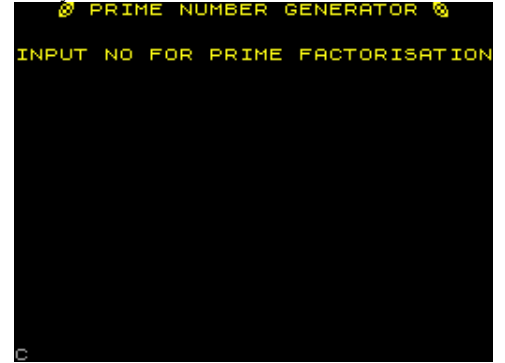

Prince of Persia (MC Software,1995)
Arcade

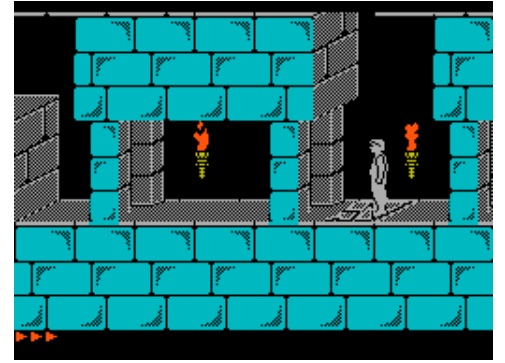

Prince of Tyndal, The (Tartan Software,1987)
Text Adventure



Prince, The (ACS Software,1985)
Utility



Print 40/50 (O. Przesmycki,)Utility: Font/UDGs



Print-42 (MicroHobby,1985)
Utility



Print'n'Plotter Jotter (Print'n'Plotter Productions,)
Utility: BASIC Related

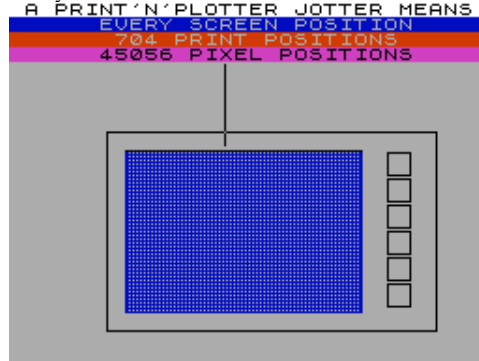

Print Shop (CCS,1982)
Simulation

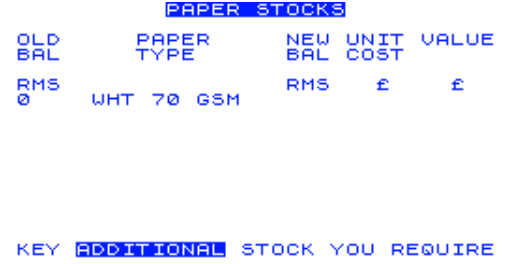

Print Utilities (Sinclair Research Ltd,1983)
Utility: Screen Manipulation

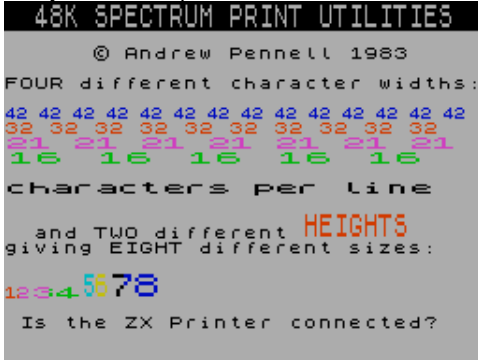

Print Utility (Spectrum Computing,1985)
Utility



Printy (Sinclair User,1991)
Utility

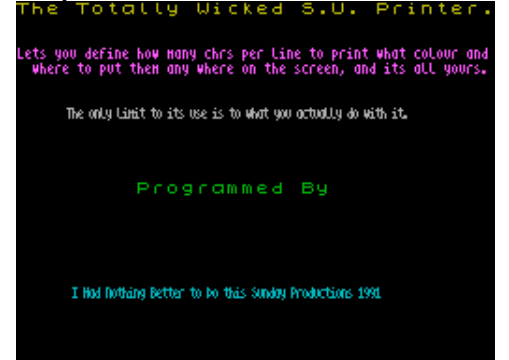

Printy 2 (Sinclair User,1992)
Utility

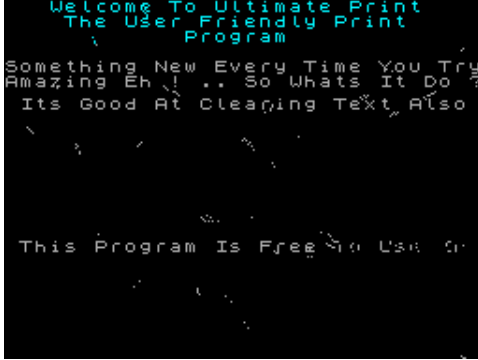

Pripad II (Shrap Software,1988)
Text Adventure

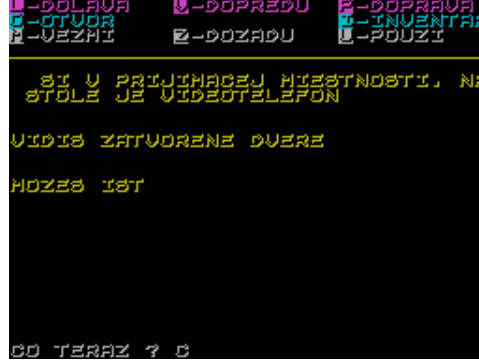

Prison Blues (The Guild,1990)
Text Adventure



Prison Blues + Magicians Apprentice (The Guild,1990)
Compilation



Prison Camp (,)
Arcade

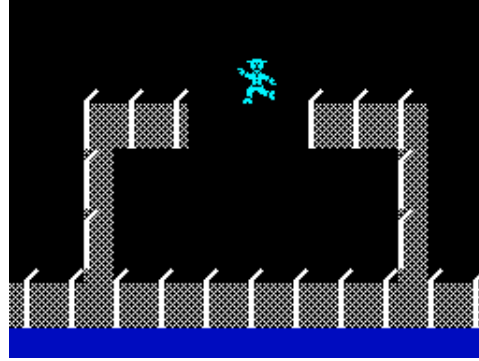

Prison Camp (Tir/Capsoft,1985)
Arcade

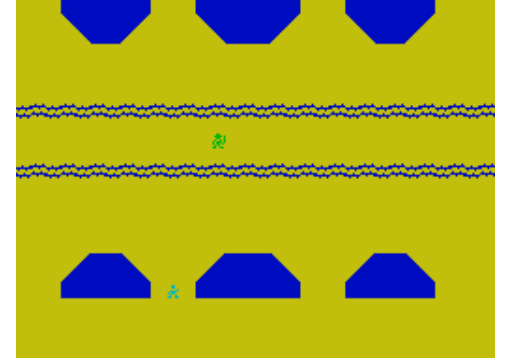

Prisoner No.6 (Adventure Software,)
Text Adventure

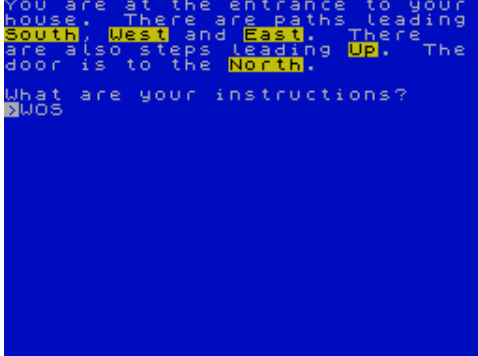

Prisoner of War (Pacific Software,1989)
Arcade



Prisoner, The (16/48 Tape Magazine,1985)
Text Adventure

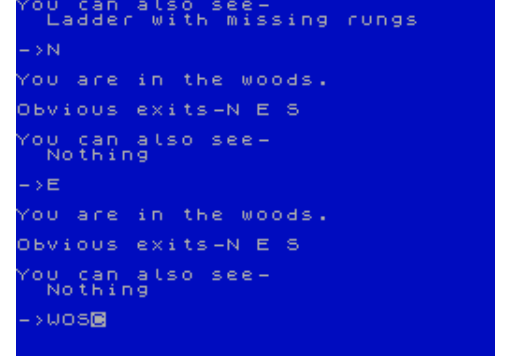

Prisoner, The (Spoof Software,1985)
Text Adventure

```
This room is a neatly equipped
modern kitchen. There is an exit
to the South.

I can also see:-

A knife.
A banana.

What now?
>WOS
```

Privat Budget (Norman Data,1983)
Utility: Spreadsheet

```
PRIVATBUDGET
MENU

1. SLET ALLE DATA
2. RET I DATA/ SLET DATA
3. INDSKRIV DATA
4. SE DATA
5. SE/UDSKRIV BUDGET
6. ÆNDRE GRUPPENAVN
7. SAVE (GEM) DATA PÅ BÅND

TRYK TAL
```

Probably the Last Big Disk (Zenobi Software,1995)
Compilation

```
You find yourself in a large
hall, the walls are decorated
with various paintings and
pictures. The most dominating
feature of the hall is the
enormous table in the centre,
around which numerous chairs are
placed. You also notice in the
corner of the hall the
teleportation machine through
which you came.

Exit(s) : ↑ ↓ ← →

What now?
>XX
```

Prodigy (Electric Dreams Software,1986)
Arcade

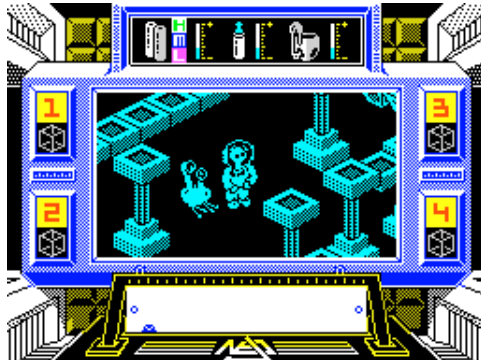

Professional Adventure Writer (Gilsoft International,1986)

```
Text Adventure Development Tool

Graficos

A PiCno. Arreglar dibujo
S PiCno. Tamano dibujo
P PiCno. Mostrar dibujo
C PiCno. Imprimir dibujo
D PiCno. Volcado pantalla
Z PiCno. Menu Ppal
```

Prisoner, The (Stephen Preston,1986)
Text Adventure



```
You are in your home in the
village.
Exits are N.

What now, Number Six?

WOS?
```

Privateer (MC Lothlorien Ltd,1983)
Strategy



Procesador de Textos (Iveson Software S.A.,)
Utility: Word Processor

```
WE HAVE
NO SCREENSHOT
OF THIS
PROGRAM
```

ProDOS Basic (Hans-Joachim Berndt,1985)
Utility: BASIC Related

```
Bytes: promc

(C) ProDos BASIC, 1985 by HJB
```

Professional Adventure Writer - User Overlays (Kelsoft,1987) Text Adventure Development Tool

```
Save PTM to drive.
1 - Microdrive/OPUS/DISCIPLE
2 - Plus 3
Insert Disc/Cartridge and
press key to start save.
```

Prison Riot (Players Premier Software,1990)
Arcade Adventure



Prize, The (Arcade Software,1984)
Arcade

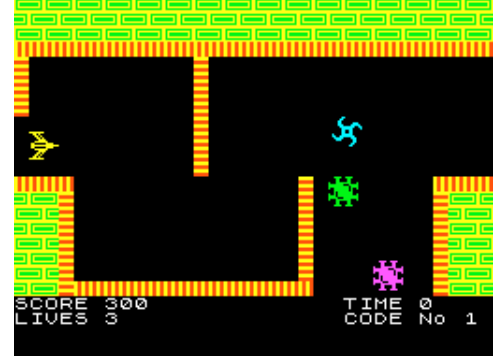

Prochazka Starou Prahou (Software Studio,1989)
Text Adventure

```
JSI NA HRAD.
MUZES JIT NA VYCHOD A NA ZAPAD

JSI U ULICI KE HRADU.
MUZES JIT NA SEVER, NA ZAPAD A NA
VYCHOD

JSI NA HRADCANSKEM NAMESTI.
MUZES JIT NA JIH
VIDIS DVE JIZDENKY NA TRAMVAJ.
```

Producent Boublí (Clasic,)
Simulation

```
Ilość BOUBLI w magazynie: 100
Koszt produkcji 1 BOUBLA: 100$
    robocizna: 63$
    surowce: 50$
    Amortyzacja: 11$
Cena detal. BOUBLA: 126$

Zysk na 1 BOUBLU: 0$
Wyprodukowano: 05 szt
Ilość zatrudnionych: 16 os
Sprzedano: 07 szt
za ogólna sumę: 3416$
Wpłaty dla prac.: 6170$
Amortyzacyjne: 1101$
Całkowity koszt produkcji: 12022$
Przyrost kasy: -8606$
Dochód: 0$

'R' wraca do początku programu
'H' wyświetla te strony raportu
wciśnij cokolwiek aby grac dalej
```

Professional BMX Simulator (Code Masters Plus,1988)
Arcade

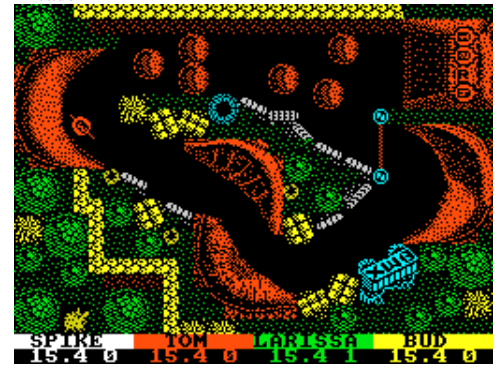

Professional Football (CRL Group PLC,1989)
Sport



Professional Footballer (Cult Games,1988)
Simulation



Professional Go-Kart Simulator (Zeppelin Games Ltd,1990)
Arcade



Professional Linear Programming (University Software,1983)
Utility: Mathematics

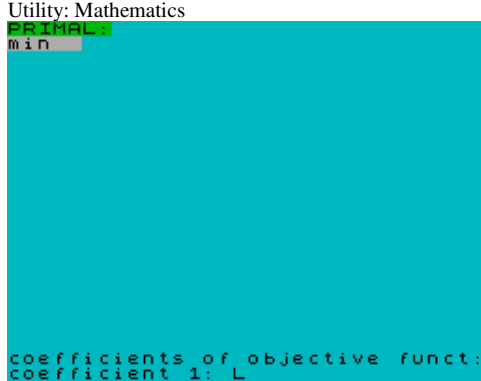

Professional Skateboard Simulator (Code Masters Ltd,1989)
Arcade



Professional Ski Simulator (Code Masters Ltd,1987)
Arcade



Professional Snooker Simulator (Code Masters Ltd,1987) Sport



Professional Soccer (CRL Group PLC,1989)
Sport



Profile 1 (McGraw-Hill Book Company UK Ltd,1984)
Utility: Spreadsheet



Profile 2 (McGraw-Hill Book Company UK Ltd,1984)
Utility: Spreadsheet

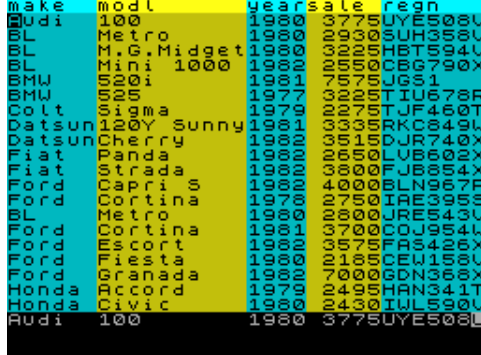

Progdat64 (Stephan Slabihoud,1986)
Utility: Database



Progen (Gensoft,1988)
Utility



Pro Golf (Atlantis Software Ltd,1986)
Sport



Pro Golf (Hornby Software,1983)
Sport



Pro Golf II (Atlantis Software Ltd,1986)
Sport



Pro Golf Simulator (Code Masters Ltd,1990)
Arcade

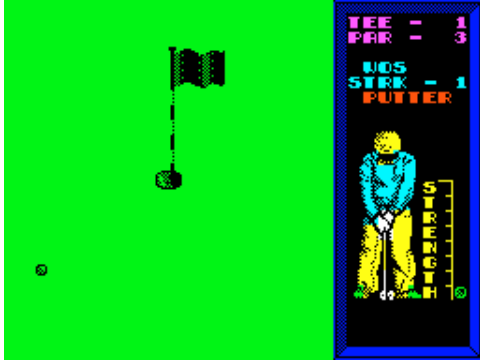

Program Base (.)
Utility: Database



Programmer's Dream, The (Work Force,1983)
Utility: Programming



Project Future (Micromania,1985)
Arcade



Project Planner (Collins Educational,1985)
Utility



Program 4 (5D Software,1983)
Arcade



Programmable Joystick Software (DK'Tronics Ltd,1984)
Utility



Progresiones y Sucesiones (MicroHobby,1986)
Educational



Project Nova (Bass-On,1987)
Text Adventure

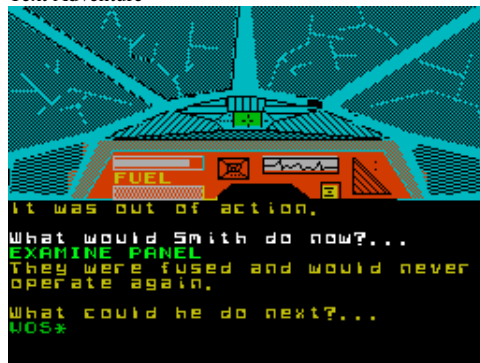

Project Stealth Fighter (Microprose Software Ltd,1990)
Arcade



Programa de Adiestramiento Con Ordenador (Investronica S.A.,1984) Educational



Programmable Sound Generator (Omikron Software [2].)
Utility

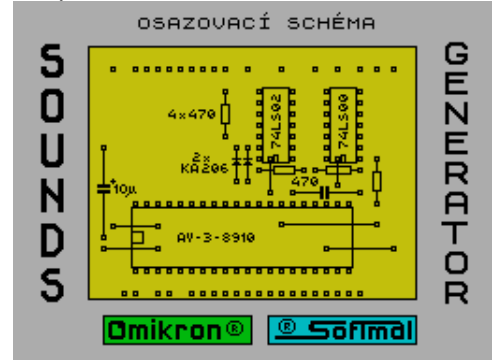

Prohibition (Infogrames,1987)
Arcade



Projector 1 (McGraw-Hill Book Company UK Ltd,1984)
Utility

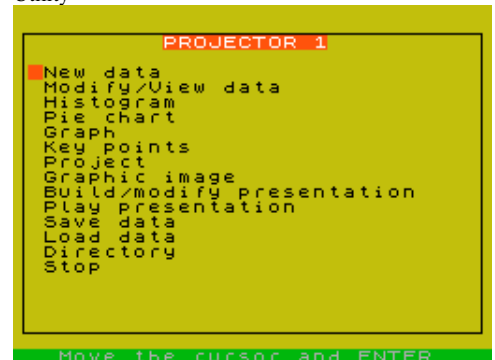

Project X + Cyberéal (Laser Dreams,1998)
Arcade



Project-X: The Micro Man (Compass Software,1985)
Text Adventure



Promotional Prospect, A (Sharon Harwood,1994)
Text Adventure



Proof of Destruction (Mastertronic Ltd,1988)
Arcade



Prophecy, The (G.H. Larsen,1984)
Text Adventure

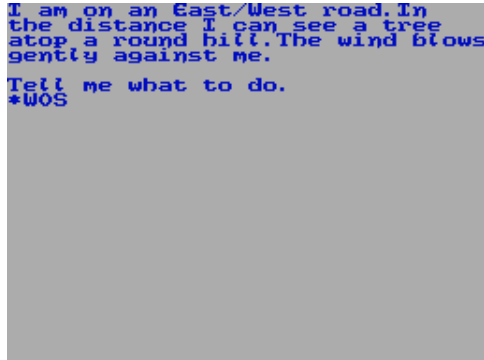

Pro Power Boat Simulator (Code Masters Ltd,1989)
Arcade



Projektowanie Plytek PCB (.)
Utility



Pro Mountain Bike Simulator (Alternative Software Ltd,1989) Arcade



ProPascal (Prospero Software,1988)
Utility: Programming

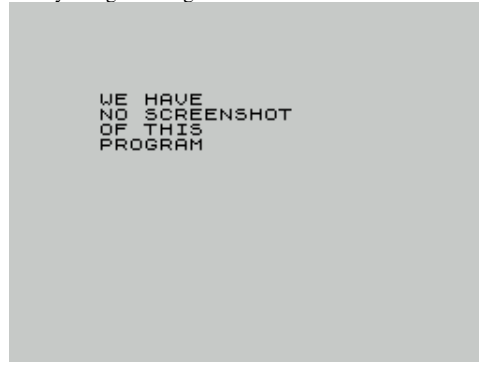

Prophecy, The (Pegasus Software,.)
Text Adventure



Prop-Print (Roelof Koning,1989)
Utility

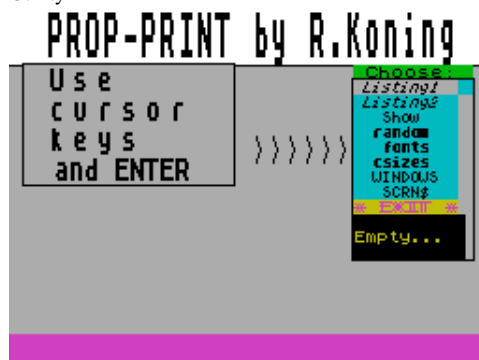

Pro Loader (.)
Utility

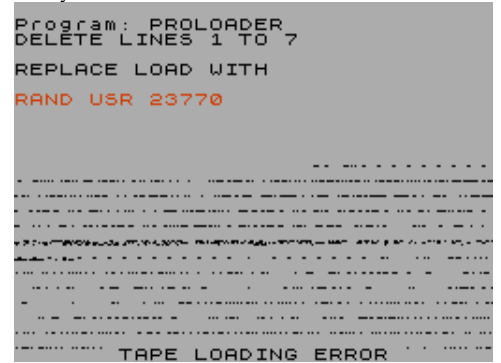

Pronostico de Quinielas (MicroHobby,1985)
Simulation



Prophecy + The Gladiator, The (The Guild,.)
Compilation



Pro Pinball (R.E.D. Sunshine,1983)
Arcade



Proracun Aktivnih Filtera (.)
Utility: Electronics

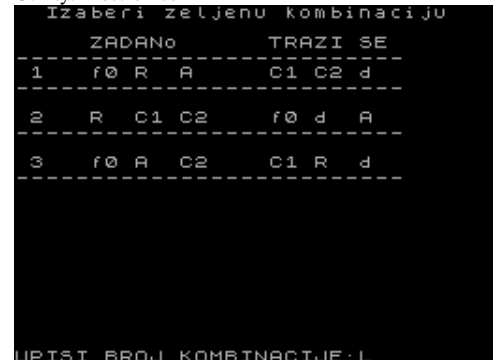

Proracun Antena (Radio Amaterski Klub
YU2RVL,1984)

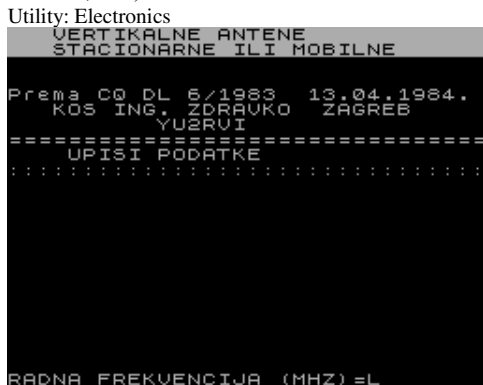

Proracun BASIC+ (Prosogn,1984)
Utility: Programming



Prospect 4 (Mayday Software,1986)
Utility

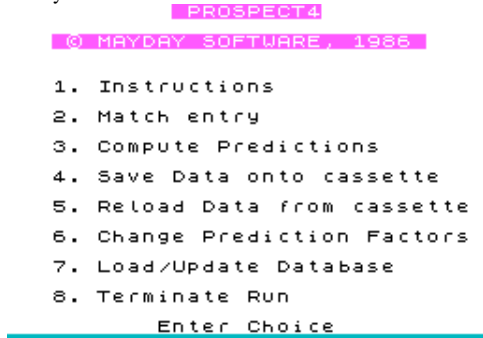

Protect and Survive (Northern Underground,1989)
Text Adventure



Protector (Sonic Software,1982)
Arcade



Proracun Transformatora (.)
Utility: Electronics



Pro Sounds (Your Sinclair,1991)
Utility: Sound Manipulation



Prospector, The (Tartan Software,1987)
Text Adventure

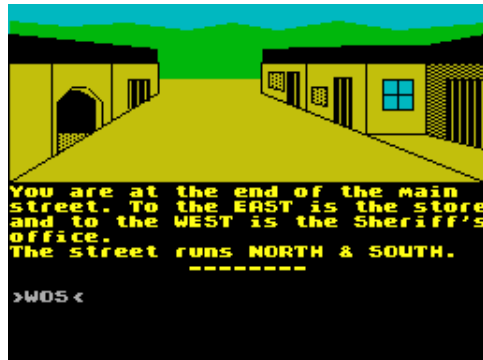

Protector (Black Knight Software,1986)
Arcade



Pro Tennis Simulator (Code Masters Ltd,1990)
Sport

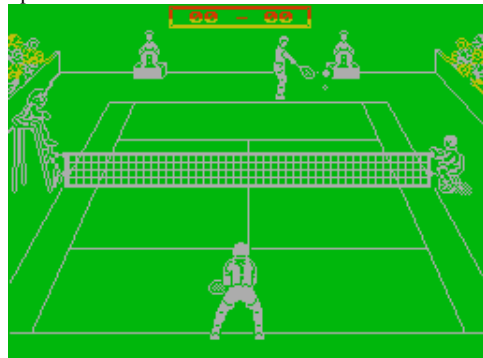

Proreg II (Holger Ahrens,1984)
Utility: Database



Prospect 2 (Mayday Software,1984)
Utility

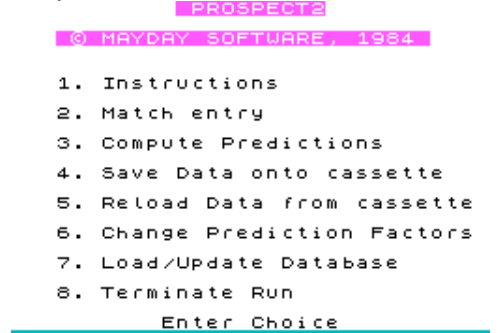

Pro Speedboat Simulator (Your Sinclair,1991)
Arcade



Protector (Mastertronic Plus,1989)
Arcade

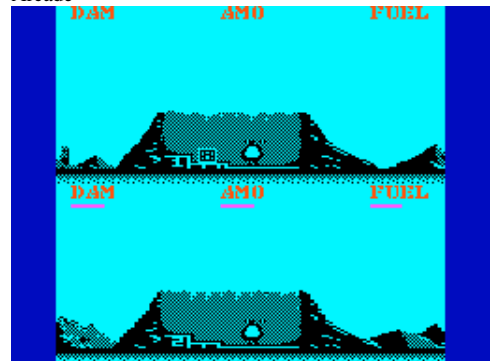

Pro Tennis Tour (Ubi Soft Ltd,1990)
Sport



Proteus (Abacus Programs,1984)
Arcade

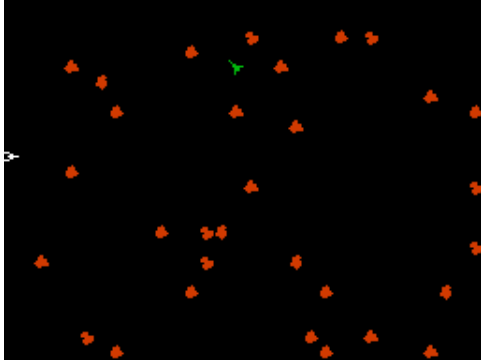

Proteus + Android Pit Rescue (Abacus Programs,1984)
Compilation

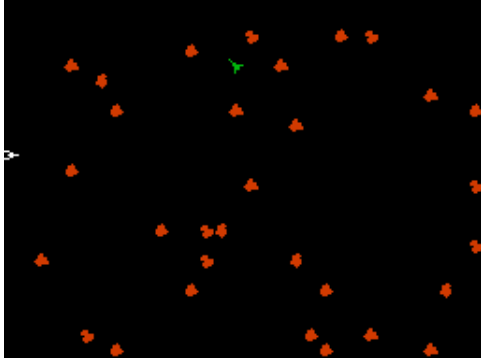

Prototype High Frequency Edge Connector Cleaning Program (Naffsoft,1990) Utility



Prowler (Pride Utilities,1984)
Utility: Programming

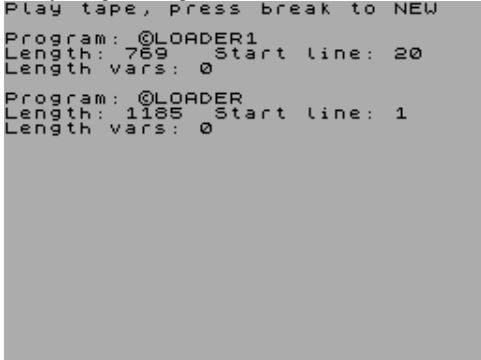

Prva Akcia (Ultrasoft,1992)
Arcade Adventure

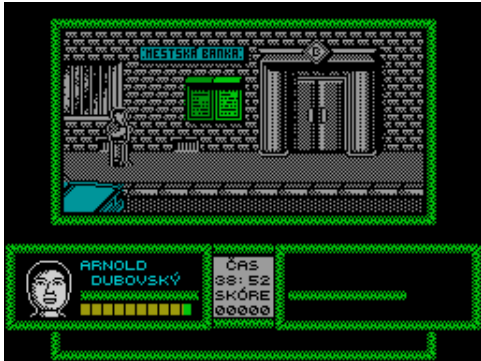

Proteus (Jorge Perez Barreiro,1986)
Arcade

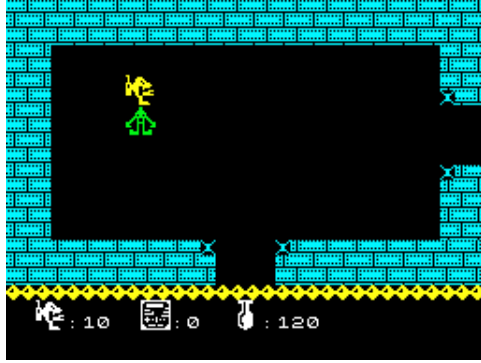

Protex (Jonathan Cauldwell,1996)
Utility



Protron (Software Editores,1986)
Arcade



PRT 64 (MHS Muller Hard & Software,1985)
Utility



Prva Informacija o Procesor Ju (Pipan Jure,1984)
Educational

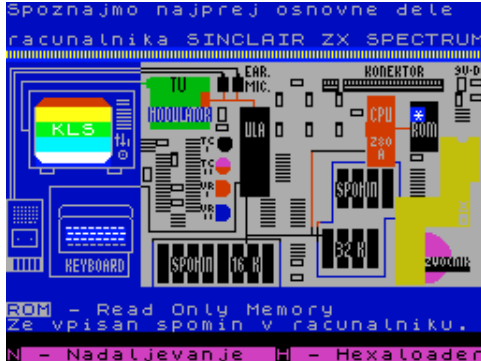

Proteus (Ultrasoft,1984)
Text Adventure



Protitler (Hall Video Products & Services,1991)
Utility



Prowler (Mastertronic Ltd,1988)
Arcade



Prueba, La (Alien Software,1993)
Text Adventure

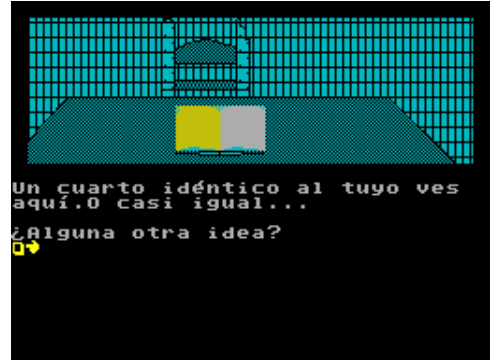

P-Schrift (,)
Utility: Font/UDGs



PSG-Wins (Prestige,1995)
Scene Demo



Psi-Games (Christopher James Software Ltd,1984)
Simulation



Psychedelia (Llamasoft,1984)
Utility

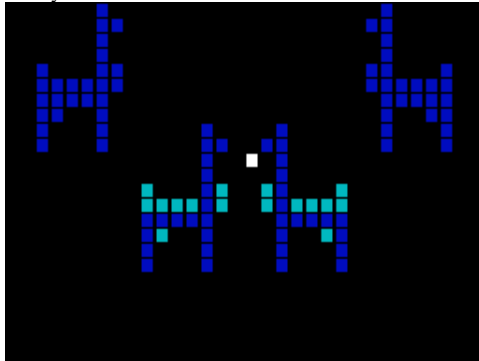

Psycho Helix (Spectec,1993)
Scene Demo



Psycho Pigs UXB + Titanic (Software Center S.A.)
Compilation



Psi-5 Trading Company (US Gold Ltd,1987)
Strategy



Psi-Spy (Postern,1983)
Arcade



Psycho City (Players Software,1989)
Arcade Adventure

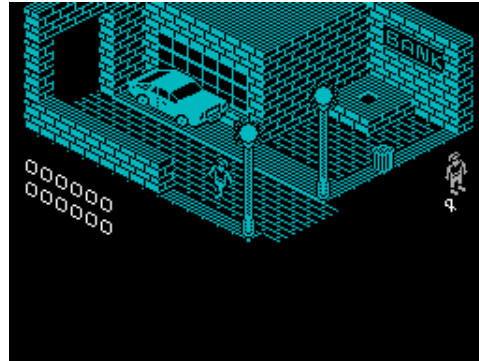

Psycho Hopper (Mastertronic Plus,1990)
Arcade



Psycho Pig U.X.B. (US Gold Ltd,1988)
Arcade



Psi Chess (The Edge Software,1986)
Board/Card Game

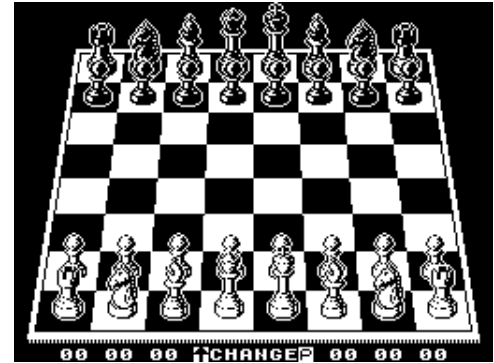

Psst (Ultimate Play The Game,1983)
Arcade



Psycho (Eliza) (M. de Vries,1983)
Simulation

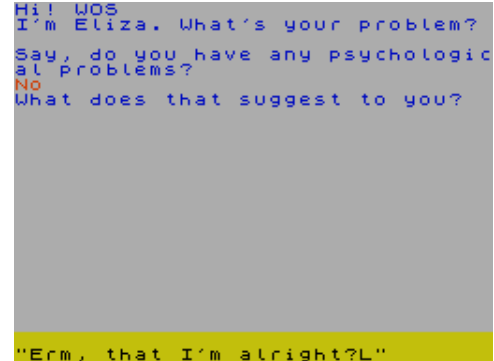

Psycho I (Convention,1995)
Scene Demo

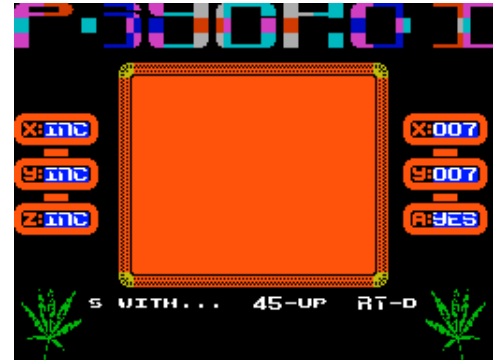

Psycho Soldier (Imagine Software Ltd,1987)
Arcade



Psychospectrology (Shiva Publishing Ltd,1983)
Educational



Parmigan (5D Software,1985)
Text Adventure

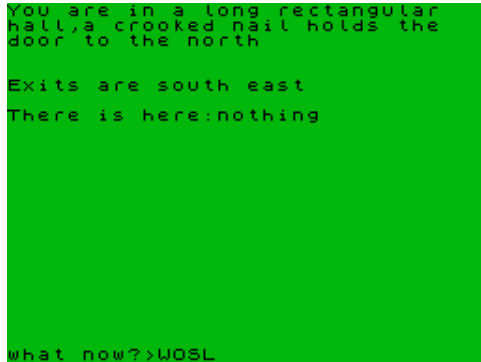

Pub Games (Alligata Software Ltd,1986)
Arcade



Puc Man (CIR,1990)
Arcade



Pueblo de la Noche (Grupo Creators Union,1989)
Text Adventure



Psytraxx (The Edge Software,1984)
Arcade



Pub Crawl (TV Soft,1985)
Text Adventure



Pub Trivia (Code Masters Ltd,1990)
Board/Card Game



Pucman (EJ Productions,1985)
Arcade

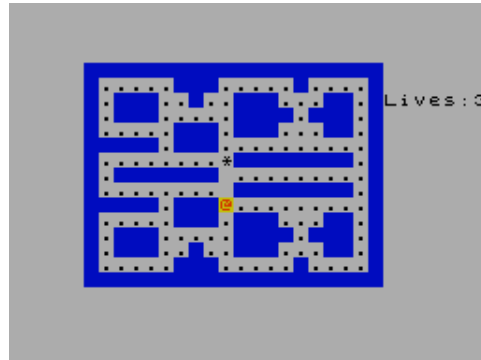

Puerta, La (Alberto M. Barragan/Mario M. Cortina,1989)
Text Adventure



Psytron (Beyond Software,1984)
Strategy



Pub Crawl 2 (TV Soft,1985)
Arcade



Puckman (Memotronic,1984)
Arcade



Pud Pud in Weird World (Ocean Software Ltd,1985)
Arcade



Puffy's Saga (Ubi Soft Ltd,1989)
Arcade



Pulga, La (Indescomp S.A.,1983)
Arcade



Pulsoids (Mastertronic Ltd,1988)
Arcade

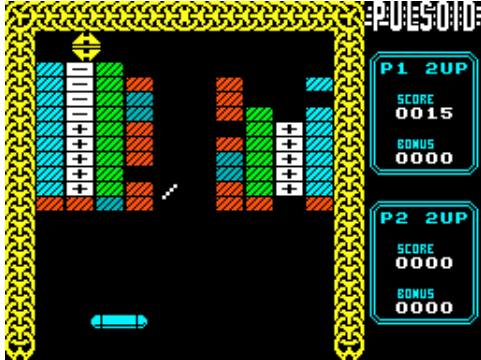

Punch & Judy (Alternative Software Ltd,1989)
Arcade Adventure



Puncman 3 + 4 (Chalksoft Ltd,1984)
Educational



Punisher, The (The Edge Software,)
Arcade

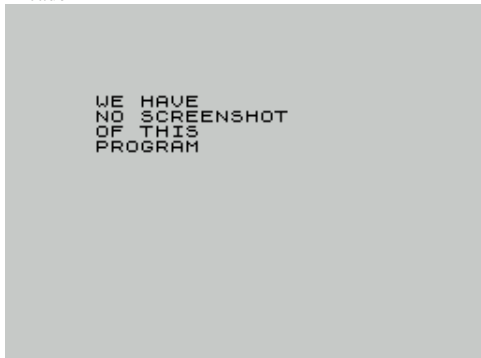

Pulsator (Martech Games Ltd,1987)
Arcade

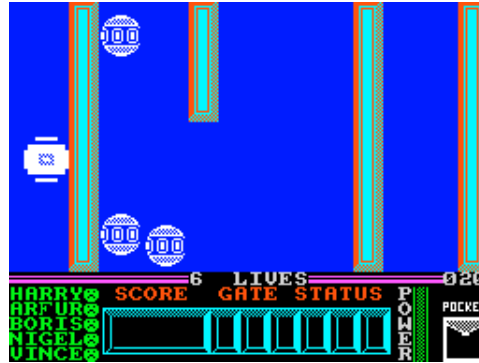

Puluc (.)
Board/Card Game



Punchy (Mr. Micro Ltd,1983)
Arcade



Punctuation Pete (Heinemann,1983)
Educational

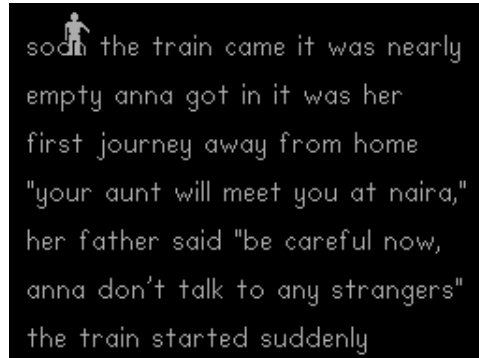

Punk Star (Iber Software,1988)
Arcade

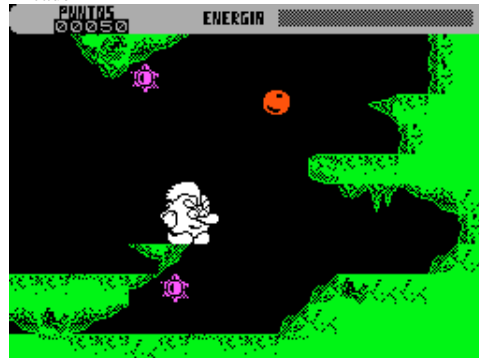

Pulse Warrior (Mastertronic Ltd,1988)
Arcade

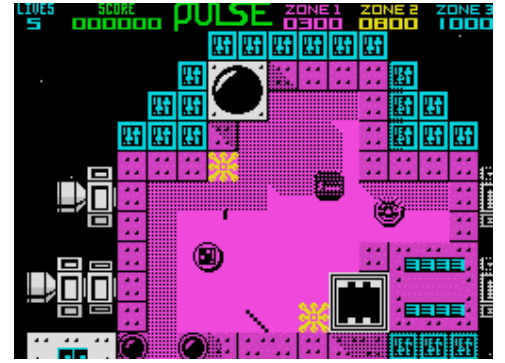

Pumped Full of Drugs (Coolguys Ltd,1989)
Scene Demo



Puncman 1 + 2 (Chalksoft Ltd,1984)
Educational



Punctuation Pete + Word Finder (Heinemann/Hill
MacGibbon,1984) Compilation

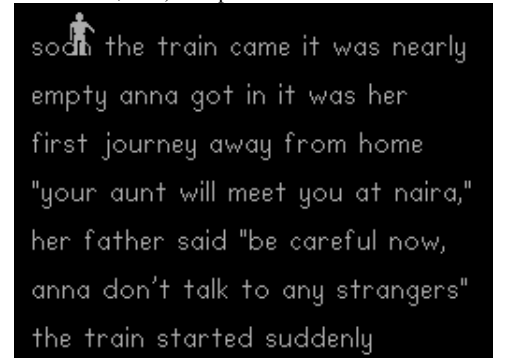

Punters Pal (Boxoft,1988)
Simulation

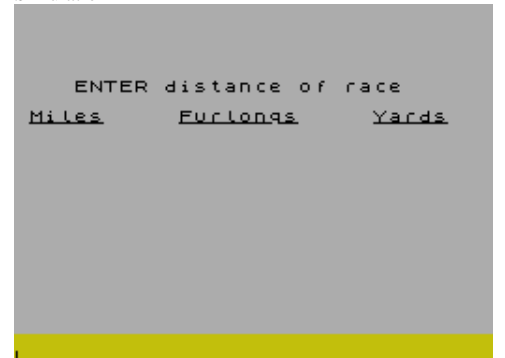

Puntos (MicroHobby,1985)
Arcade

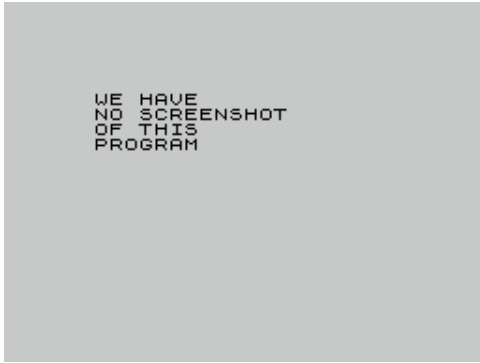

Purchase Ledger (Anik Microsystems,1984)
Utility



Purchase Ledger (Hestacrest Business Software,1984)
Utility

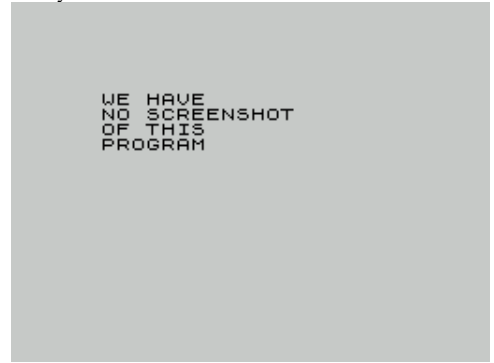

Purchase Ledger (Kemp Ltd,1983)
Utility



Purple Saturn Day (Exxos,1989)
Arcade

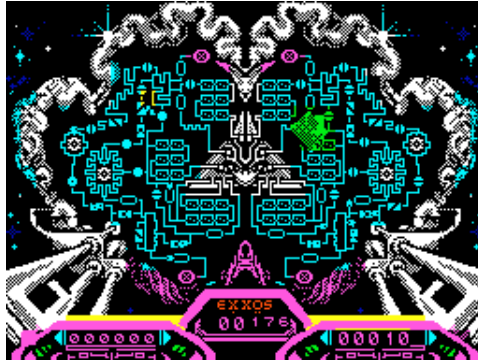

Pursuit (Finsbury Software,1984)
Board/Card Game



Purv Demo (Purv.)
Scene Demo



Pusher (Am-Tec,1983)
Arcade

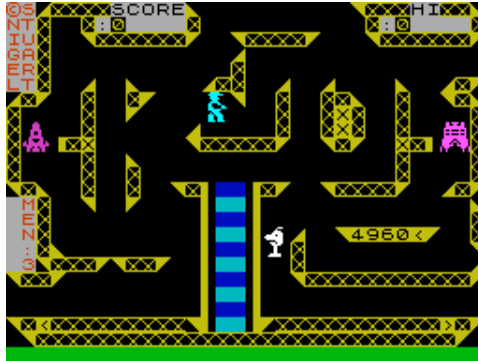

Push Off (Software Projects Ltd,1983)
Arcade



Pussy: Love Story from Titanic (Fatality,1999)
Arcade Adventure



Pustman (Birger Larsson,)
Arcade



Puszka Pandory (Marcin Borkowski,1986)
Text Adventure



Putup (Image Crew,1997)
Arcade



Puzzcar (MicroHobby,1985)
Arcade

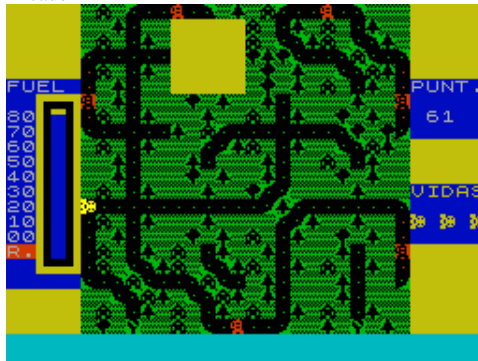

Puzzle (Spectrum Computing,1985)
Board/Card Game



Puzzle [1] (MicroHobby,1985)
Board/Card Game

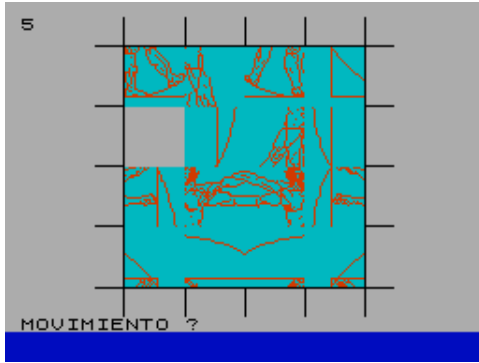

Puzzle de Coiores (MicroHobby,1985)
Board/Card Game



Puzzler (Micromega,1983)
Board/Card Game

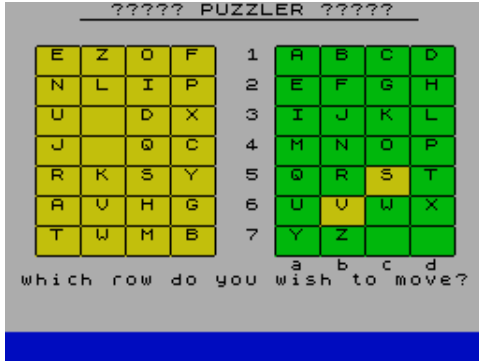

Puzznic (Ocean Software Ltd,1990)
Board/Card Game

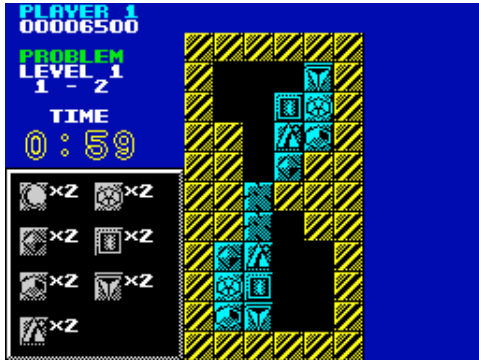

Pyldro (Tornado,1990)
Scene Demo

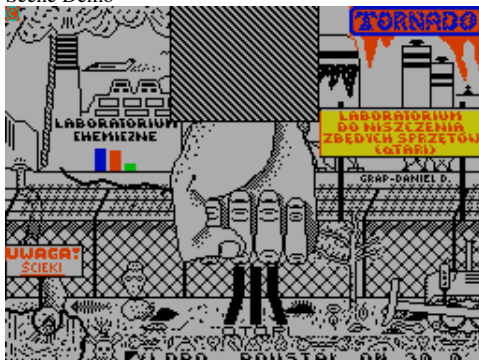

Puzzle [2] (MicroHobby,1991)
Board/Card Game

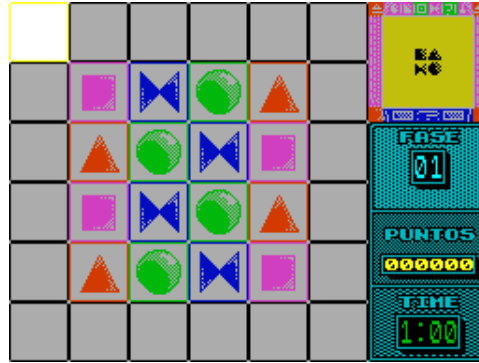

Puzzle Drama (MCN Software,1985)
Board/Card Game



Puzzle, The (Spectrum Club,1989)
Board/Card Game



Pyjamarama (Mikro-Gen Ltd,1984)
Arcade



Pyracuse (Hewson Consultants Ltd,1986)
Arcade



Puzzled (The Guild,1990)
Text Adventure

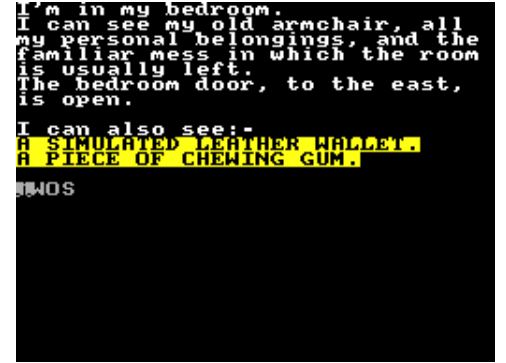

Puzzle Musical (David Fraile,1988)
Board/Card Game

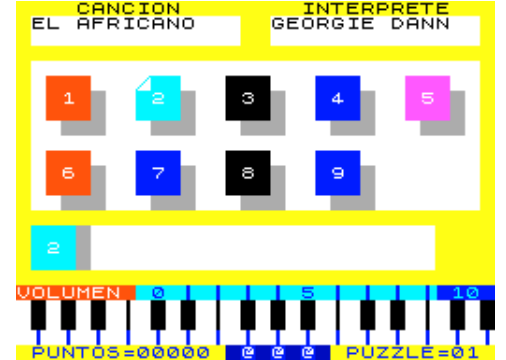

Puzzle, The (Taras,1998)
Board/Card Game

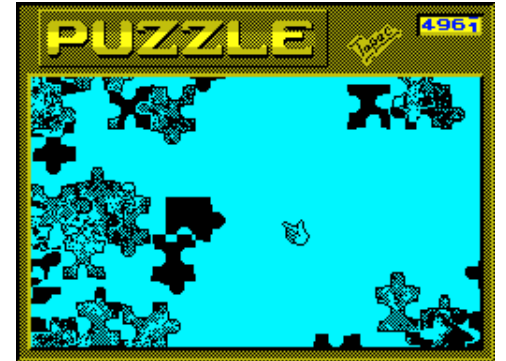

Pyjamarama + Automania (Mikro-Gen Ltd.)
Compilation

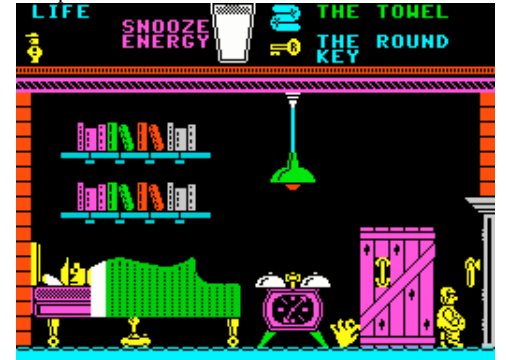

Pyramania (16/48 Tape Magazine,1984)
Arcade



Pyramid (Sinclair User,1984)

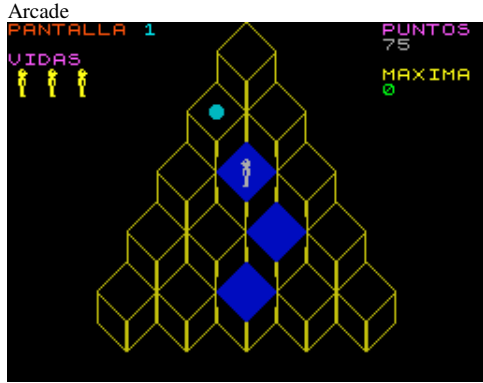

Pyramide (Pw/Mcs,1985)



Pyramid Patience (Tiger's Claw,1996)



Pyramid, The (G.I. Games,1992)

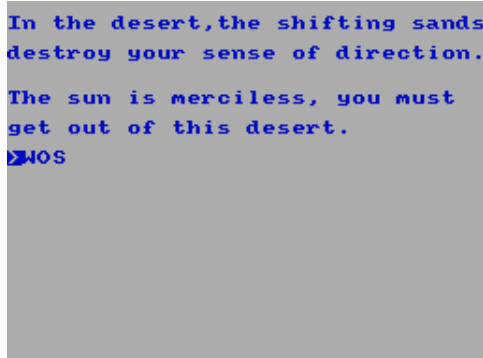

Qang (Scorpion,1991)



Pyramid (Visual Boys,1996)

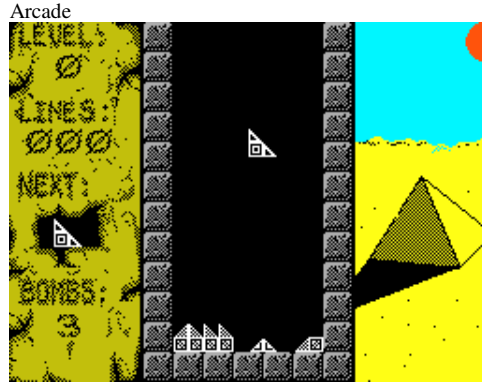

Pyramid of Doom (Adventure International,1985)



Pyramids (H.S. Software,1987)



Q10 Tankbuster (Zeppelin Games Ltd,1992)

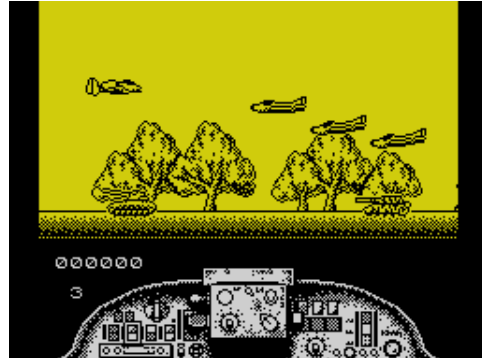

Qarx (Your Sinclair,1988)



Pyramid, 3D (Green Fish Software Enterprise,1983)

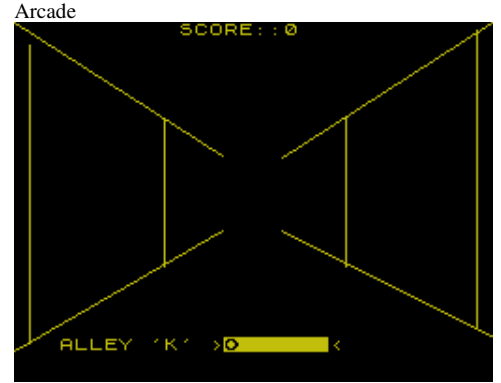

Pyramid of Rameses (Longman Software,1983)



Pyramid, The (Fantasy Software [1],1983)



Q8 Team Ford Rally Simulation (Thalamus Ltd,)



Q*Bert (Parker Software,1984)



Q-Bertus (.)

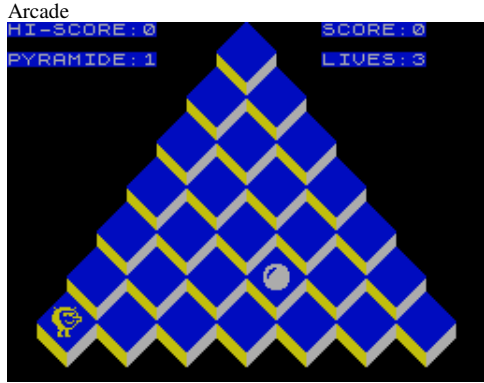

Q's Armoury (Domark Ltd,1990)

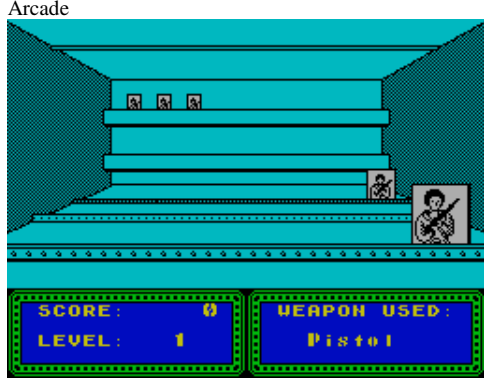

Quackers (Rabbit Software Ltd,1983)



Quadracube, 3D (Artic Computing Ltd,1983)

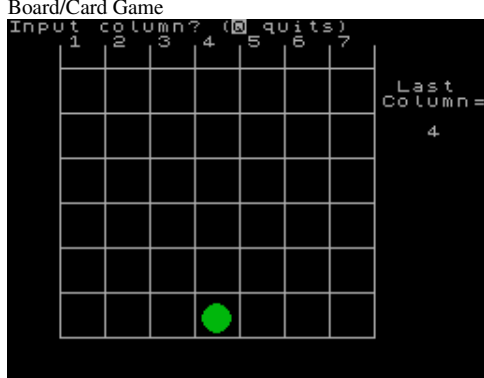

Quad Trap (Style Soft,1985)



Q.B.O. (MicroHobby,1985)

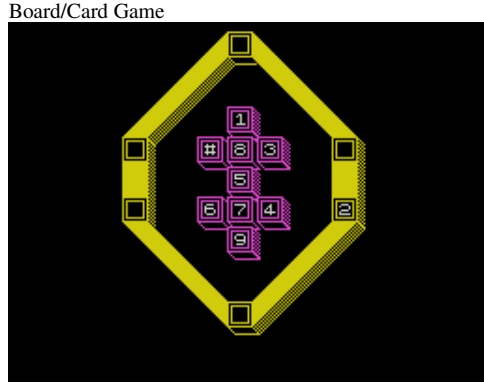

QS Defenda 81 (Russell Marks,.)



Quack-Shot (Sparklers,1985)

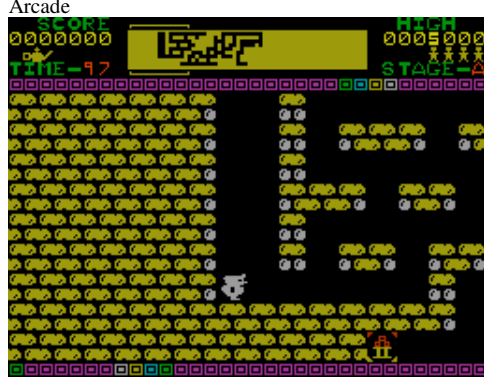

Quadrato (.)



Qualitas (Seven Stars Publishing,1986)

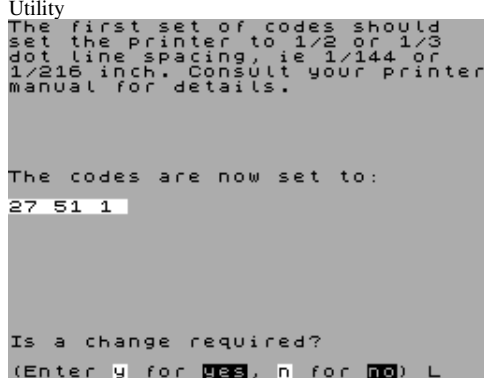

QRA (R.E. Stephens,1983)

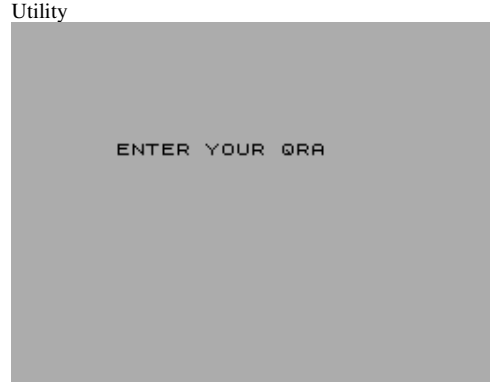

Quackers (.)

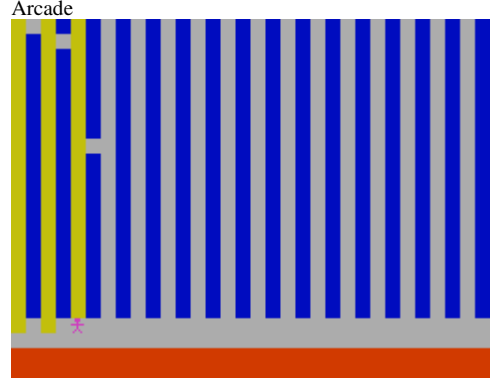

Quadracube, 3D (Artic Computing Ltd,1983)

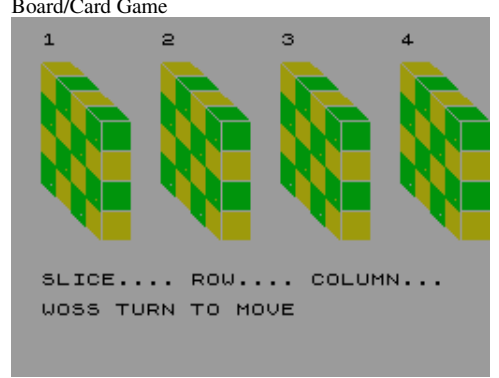

Quadrax (Ultrasoft/Sintech,1994)



Quann Tulla (8th Day Software,1985)



Quark (Dominic Morris,1992)
Scene Demo

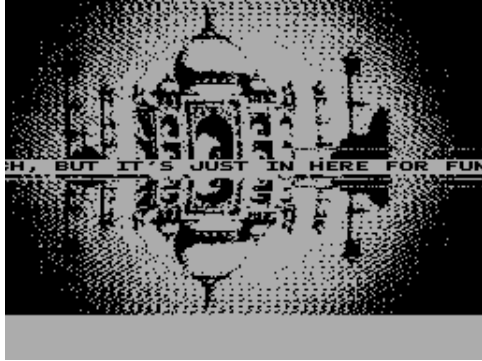

Quarterback (Virgin Games Ltd,1990)
Sport



Quasimodo (Sinclair Programs,1983)
Arcade



Quattro Cartoon (Code Masters Ltd,1991)
Compilation



Quattro Fantastic (Code Masters Ltd,1992)
Compilation



Quarks (,)
Board/Card Game

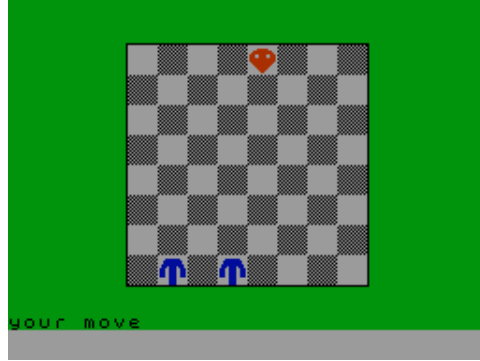

Quartet (Activision Inc,1987)
Arcade

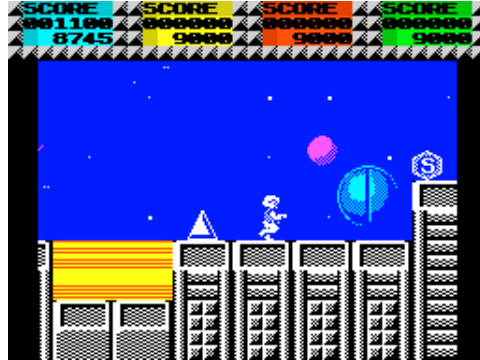

Quattro Adventure (Code Masters Ltd,1990)
Compilation



Quattro Coin-Ops (Code Masters Ltd,1991)
Compilation



Quattro Fighters (Code Masters Ltd,1992)
Compilation



Quarks (16/48 Tape Magazine,1984)
Arcade



Quasar (MicroHobby,1986)
Arcade



Quattro Arcade (Code Masters Ltd,1991)
Compilation

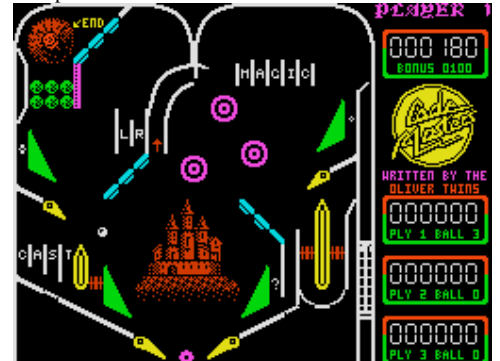

Quattro Combat (Code Masters Ltd,1991)
Compilation



Quattro Firepower (Code Masters Ltd,1991)
Compilation



Quattro Megastars (Code Masters Ltd,1992)
Compilation



Quattro Skills (Code Masters Ltd,1991)
Compilation



Quazatron (Hewson Consultants Ltd,1986)
Arcade



Queen of Hearts, The (Widgit Software Ltd,1984)
Text Adventure

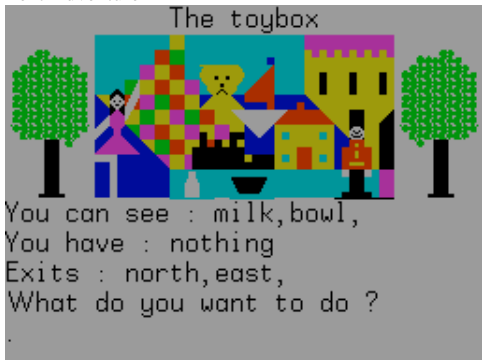

Quest Adventure (Hewson Consultants Ltd,1983)
Text Adventure

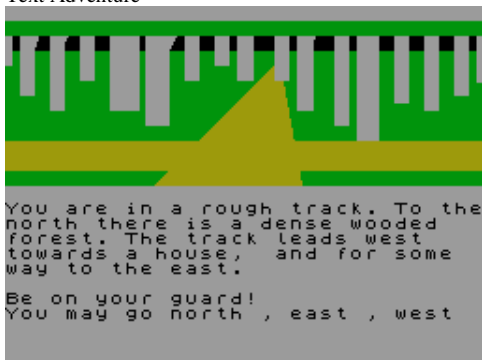

Quattro Power (Code Masters Ltd,1991)
Compilation

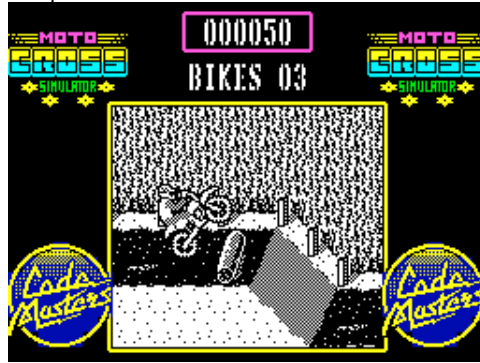

Quattro Sports (Code Masters Ltd,1990)
Compilation



Quazer (Rose Software,1983)
Board/Card Game



Queen of the Mirror (Elven Adventurers,1991)
Text Adventure



Quest for A (IEC Software,1986)
Educational



Quattro Racers (Code Masters Ltd,1991)
Compilation

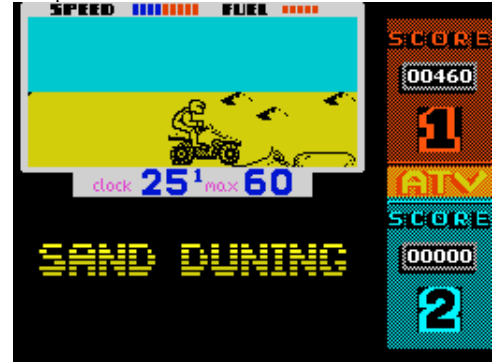

Quattro Super Hits (Code Masters Ltd,1991)
Compilation

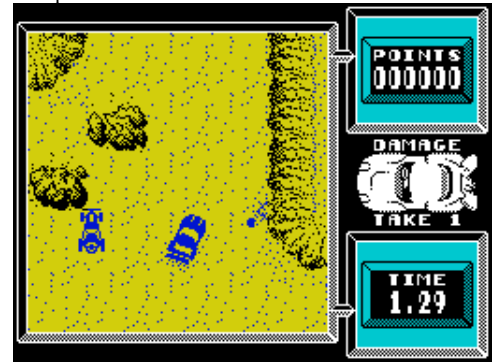

Qubert (Michael Rosenbohm,)
Arcade

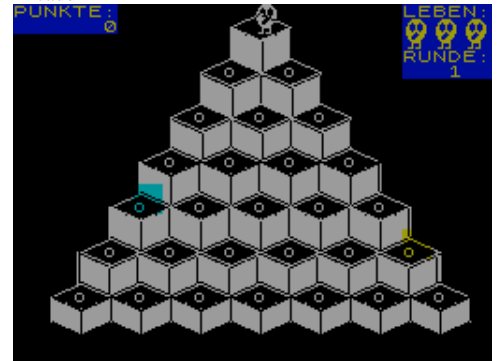

Que es el PERT? (Ingenieria Quimica,)
Educational

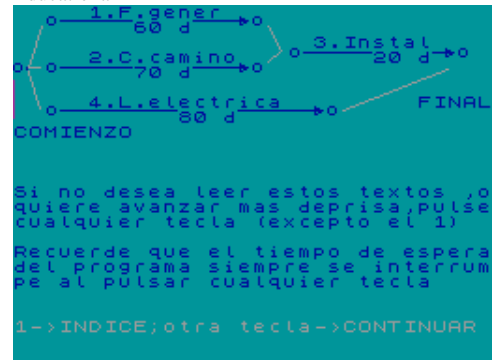

Quest for Eternity (Mind Games,1984)
Text Adventure

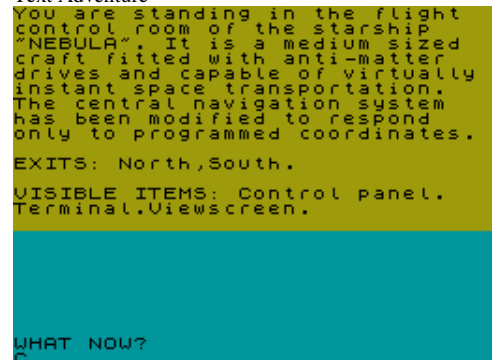

Quest for Sex (Carley Bros.)
Text Adventure

```

YOU ARE THE INTREPID VIRGIN
*****
***** NOVICE NIGEL! *****
*****
ONE FRIDAY NIGHT, YOU DECIDE TO GO
OUT TO LOSE YOUR VIRGINITY-BREAK
AK YOU DUCK. BUT BREAKING IT IS N
OT EASY AS YOU MAY FIND TO YOUR
PERIL. <SO BEWARE!>

AHEAD IS THE PLOUGHMAN.
TO THE LEFT IS A CARPARK.
TO THE RIGHT IS A SUBWAY.

WHICH WAY NOW?

A-AHEAD
L-LEFT
R-RIGHT

"L"
    
```

Quest for the Golden Scarab, The (Daniel Tietze.)
Text Adventure

```

WE HAVE
NO SCREENSHOT
OF THIS
PROGRAM
    
```

Quest for the Holy Joystick (Delta 4 Software, 1984)
Text Adventure

```

A dingy dive at number 5,
Safe from Eugene's moo,
Where you may sue for copyright,
Or play this game right through,

Through a window you see:-
Downing Street.
A visible exit leads out...
Your wish is my command,
>
    
```

Quest for the Orc (David Cowling, 1985)
Text Adventure

```

WE HAVE
NO SCREENSHOT
OF THIS
PROGRAM
    
```

Question of Scruples, A (Leisure Genius, 1987)
Board/Card Game

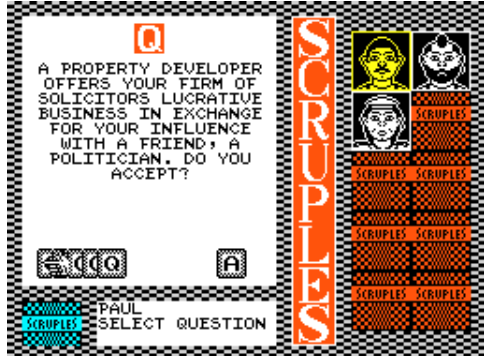

Quest for the Golden Eggcup (Network Adventure Games, 1986)
Text Adventure



Quest for the Holy Grail, The (Dream Software Ltd, 1984)
Text Adventure

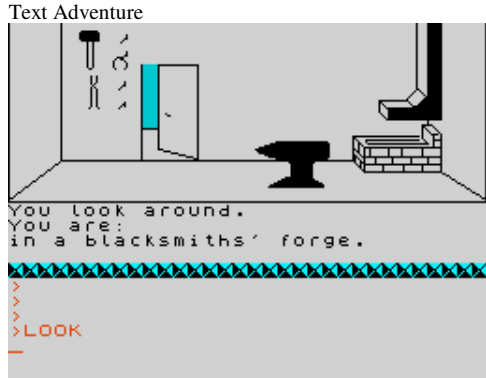

Quest for the Holy Snail (Delbert the Hamster Software, 1992)
Text Adventure

```

You are on a dusty track... you
know, a song on your LP that
hasn't been cleaned! Oh well,
it's an old joke but a new
location! To the north lies a
castle while to the east, west
and south there...erm, doesn't
lie a castle.

What should you do now?
>+
    
```

Quest for the Poorly Snail (Futuresoft, 1988)
Text Adventure

```

YOU are in your dark cell, in
which you have spend many a
year. To the west is a door. The
cell contains no windows and is
only lit by a candle. Your
calendar is on the north wall,
while on the south wall you can
see you favourite pass time,
graffiti:
OUR square hero can also see:
THE note
THE BOTTLE OF POISON!!!

Lead on, brave adventurer...
O
    
```

Question of Sport, A (Elite Systems Ltd, 1989)
Sport

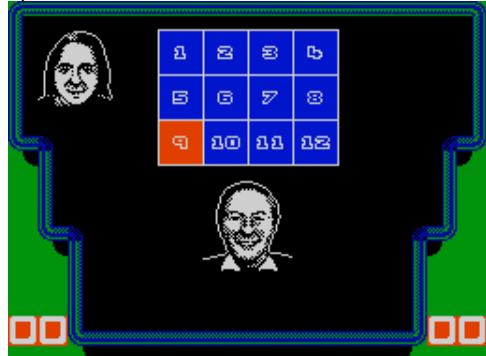

Quest for the Golden Orange Peel (Dual Dimension Software, 1986)
Text Adventure

```

You are outside a huge stone
temple, which towers above you.
Exits: north, south
>
    
```

Quest for the Holy Grant Cheque (Dead Donkey Designs, 1984)
Text Adventure

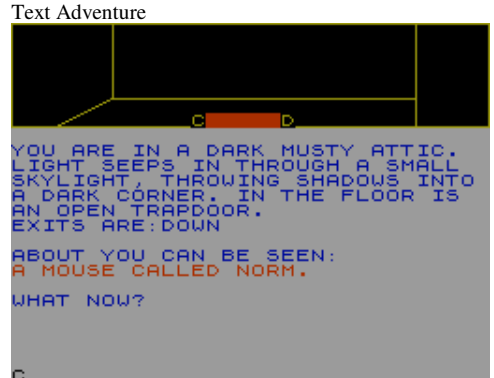

Quest for the Holy Something (Zenobi Software, 1992)
Text Adventure

```

Fred found himself to be in a
clearing, in a magical, mystical
forest. Trees loomed menacingly
around him, whilst tracks wound
away north & east.
Fred also noticed:
a curious note
>_
    
```

Quest for the Power Rod (Magic Soft, 1988)
Text Adventure



Quest, The (Impact Software [1], 1982)
Text Adventure

```

You have the following options.
E) Fire an arrow.
F) Light a flare.
J) Try bribing it.
R) Retreat
    
```

Quete du Chevalier, La (,1986)
Text Adventure



Quickrater 2 (J. Pooley,1986)
Simulation



Quick Thinking (Mirrorsoft Ltd,1983)
Educational



Quill Thrill Vol 1 (The Guild,)
Compilation



Quiniela Hipica (Micro-Spot,1985)
Utility

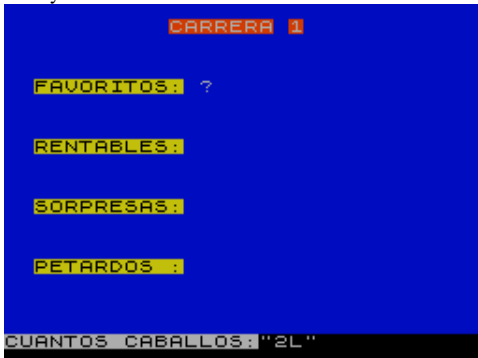

Quetzalcoatl (Virgin Games Ltd,1983)
Arcade Adventure

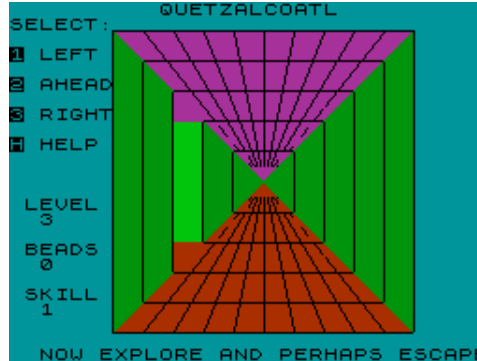

Quicksave (Individual Software,1984)
Utility: Copier



Quill Adventure System, The (Gilsoft International,1983)
Text Adventure Development Tool



Quill Thrill Vol 2 (The Guild,)
Compilation

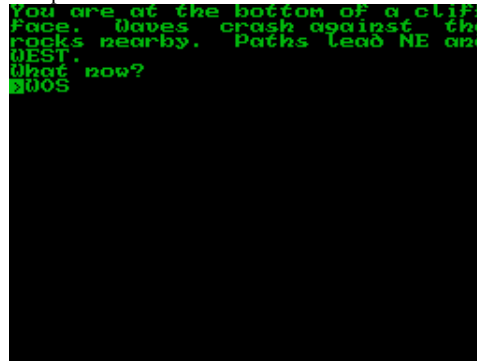

Quinielas (Ediciones y Textos S.A.,1985)
Utility



Quick Draw McGraw (Hi-Tec Software Ltd,1991)
Arcade

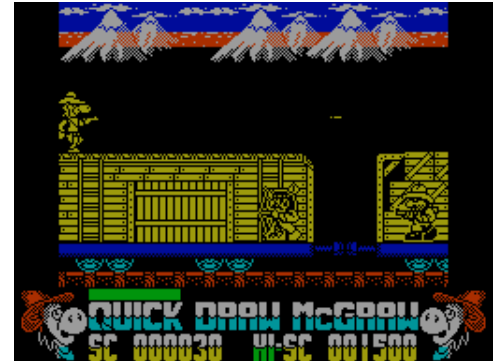

Quicksort B (O. Przesmycki,1985)
Utility



Quill Database Converter (Gilsoft International,1983)
Text Adventure Development Tool

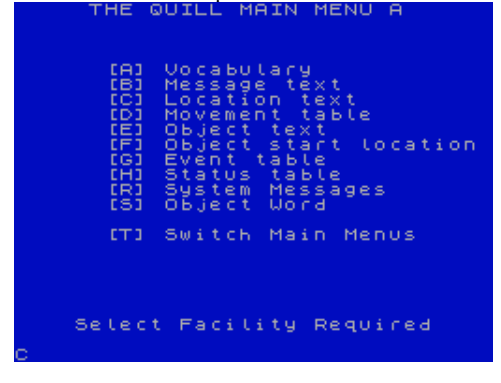

Quincy (Severn Software,1983)
Board/Card Game



Quinielas (Investronica S.A.)
Utility

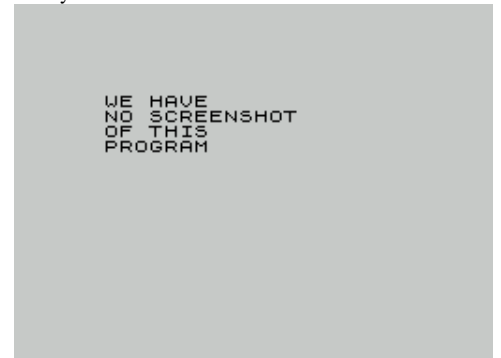

Quinielas (MicroHobby,1985)
Utility

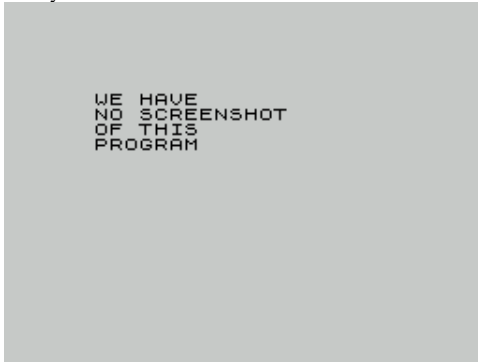

Quinielas (Monser S.A.,1985)
Utility: Mathematics



Quinielas 1X2 (Microparadise Software,1984)
Utility

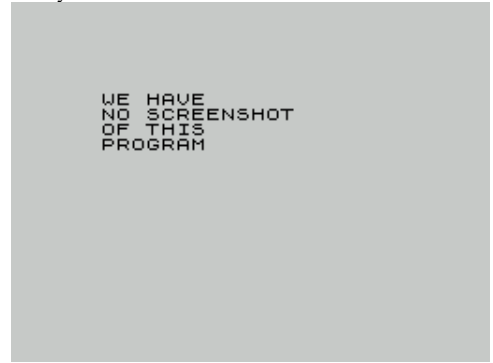

Quinquagesima (The Lords,1989)
Scene Demo

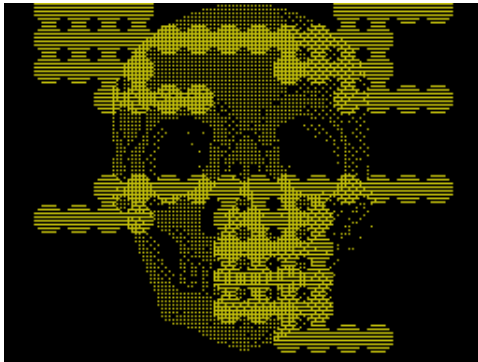

Quiz Chequers (Jemel Soft,1983)
Board/Card Game

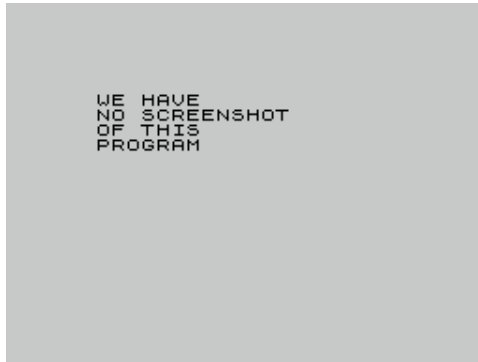

Quiz-Cross (M.H. Counsell,1985)
Board/Card Game



Quiz Game (.)
Educational

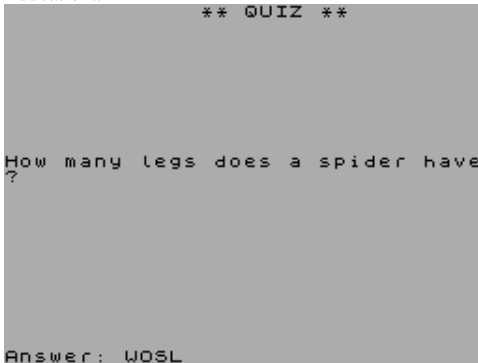

Quiz of Europe (Tawny Software.)
Educational



Quiz Quest (Alligata Software Ltd,1985)
Board/Card Game



Quiz Timer (Macmillan Software Ltd,1986)
Simulation



Quondam (Ian Collier,1989)
Arcade

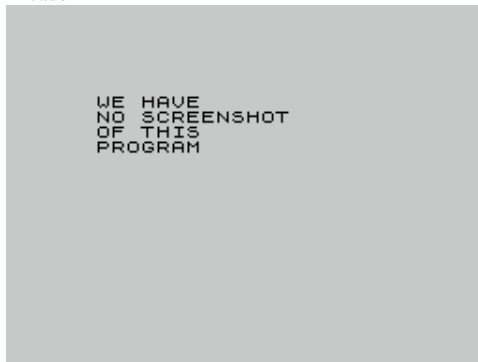

Quondam (Ocean Software Ltd,1989)
Arcade



Quo Vadis (Peter Miosga,1992)
Board/Card Game

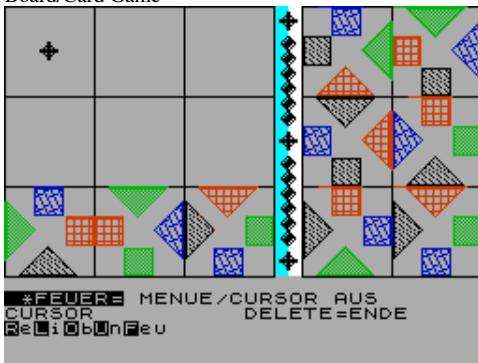

Rabbit Jazzy (Paradox,1998)
Arcade



Rabbit Shoot (Phipps Associates,1983)
Arcade

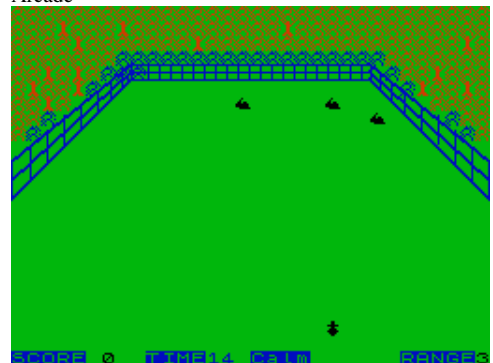

Race (16/48 Tape Magazine,1984)
Arcade

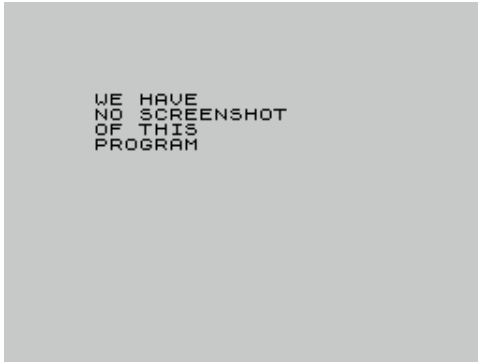

Race Fun (Rabbit Software Ltd,1983)
Arcade

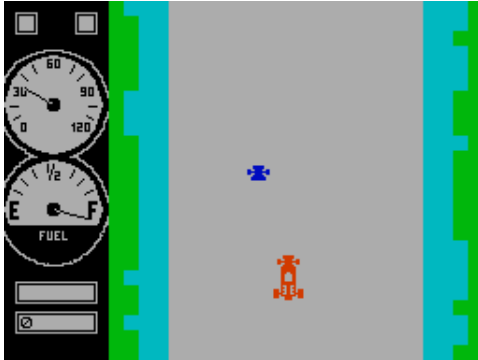

Racer Tracer (MicroHobby,1986)
Arcade



Race-Track (Video Showcase,1984)
Arcade



Racing Game, The (Tanglewood Software,1986)
Simulation

A MAXIMUM OF 5 HOURS CAN BE USED TO TRAIN HORSES OF YOUR CHOICE
NEXT RACE OVER 5f-MAX.6'DE 85

No	Horse	Form	G'de	Fit
1	Tax Demand	2301	05	00%
2	Star Soldier	3204	01	00%
3	Honour Bound	0202	00	00%
4	Skymaster	0030	00	00%
5	Workboy	0020	00	00%
6	Bold Bid	0020	00	00%
7	Downtown	0011	00	00%
8	Top Star	3010	00	07%
9	Deck Hand	0040	00	04%
10	Bonne Noel	0010	00	00%
11	Royal Smoke	0020	00	04%
12	Sharpen Up	0320	01	00%
13	First Season	0300	00	00%
14	Our Native	0043	00	05%
15	My Miracle	11	00	05%

1 hours Training=+1%
5 Hours Available

Enter number of horse "L"

Race Ace (Rainbird,1983)
Arcade

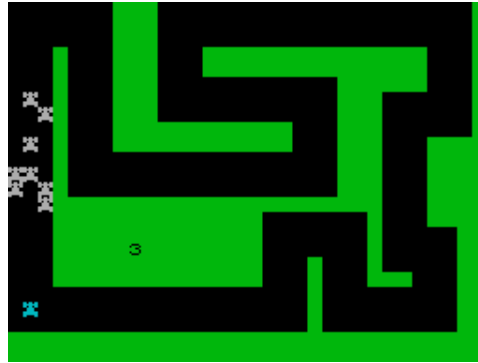

Racehorse Trainer (5D Software,1985)
Sport

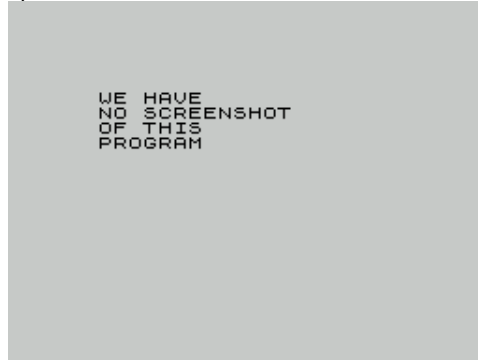

Race, The (Players Premier Software,1990)
Arcade

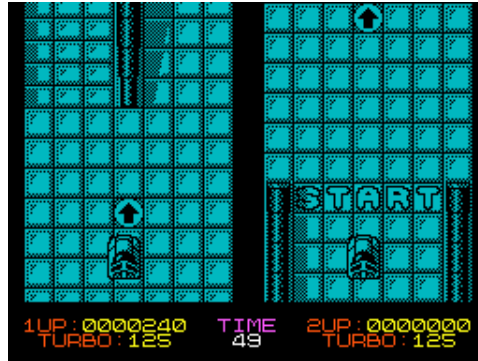

Raceway (Abacus Programs,1984)
Arcade



Racing League (R.L. Software,1985)
Simulation

1	ALI BABA	0000	WOS
2	BLUE MAX	0000	WOS
3	CAPTAIN	0000	WOS
4	DEADLOSS	0000	G. BOYCOTT
5	FRAGER B	0000	G. BOYCOTT
6	FLY ME	0000	G. BOYCOTT
7	GEMSTONE	0000	B. CLOUGH
8	HAMELIN	0000	B. CLOUGH
9	I CLAUDE	0000	H. COOPER
10	JERRYCAN	0000	H. COOPER
11	KUINANA	0000	H. COOPER
12	LASER	0000	H. COOPER
13	MY GIRL	0000	S. DAVIS
14	NIMBUS	0000	S. DAVIS
15	OLD HERO	0000	S. DAVIS
16	PICKLED	0000	N. EDMONDS
17	QUENTIN	0000	N. EDMONDS
18	ROMANY	0000	N. EDMONDS
19	STEAMING	0000	D. ESSSEX
20	TOM BELL	0000	D. ESSSEX

HIT ANY KEY TO CONTINUE

Race Against Time, The (Code Masters Plus,1988)
Arcade Adventure



Race - Pack 4 (Zeppelin Games Ltd,1992)
Compilation



Race Track (Sinclair Research Ltd,1982)
Arcade

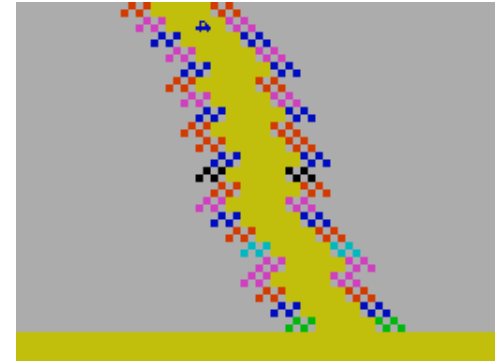

Racing (MicroHobby,1986)
Arcade



Racing Manager (Virgin Games Ltd,1983)
Simulation

MEETING NUMBER 1 RACE NUMBER 1
GOING :- GOOD TO SOFT

FOR HORSES WITH A SPEED FACTOR BETWEEN -1 AND 3: VALUE £1000

DISTANCE 6 FURLONGS

RUNNERS

1	CEDEARWAY	52%	FIT 14/F
2	OLD THUNDER	57%	FIT 4/GF

CHOICE ? ENTER 0 IF NO ENTRY

Racing Predictions (Buffer Micro Ltd,1984)
Simulation



Rack One's Brains (Eclipse [2],1988)
Board/Card Game



Radio 5 (IPC Magazines Ltd,1983)
Utility

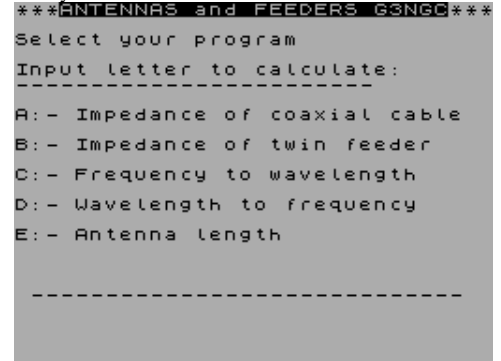

Radio-Hams (ON5KN.)
Utility

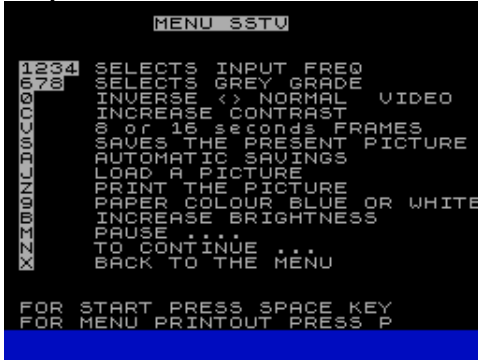

Radiomania (Zenobi Software,1991)
Text Adventure



Radio TFF (TFF Team,1990)
Scene Demo



Radix VII (Mme Sosostri Astro Computing,1984)
Strategy



Rad Ramp Racer (Mastertronic Plus,1990)
Sport

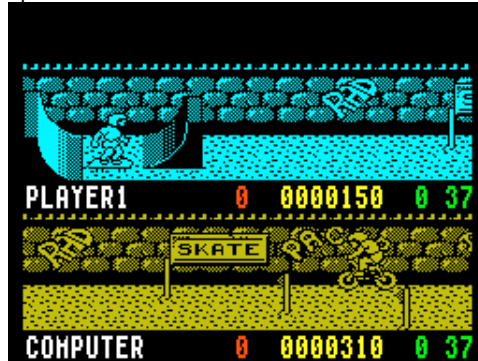

Rage (X-Trade Group,1997)
Scene Demo

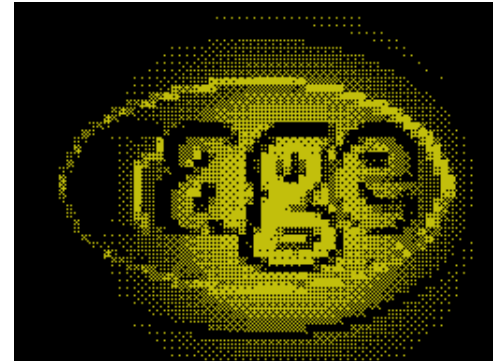

Raging Beast (Firebird Software Ltd,1986)
Arcade



Ragnablock (Computer Emuzone,2006)
Arcade

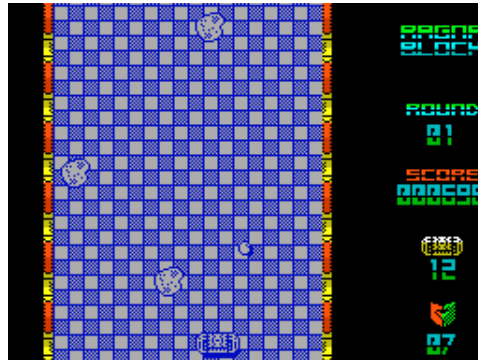

Raider'41 (MAP Software,1984)
Strategy

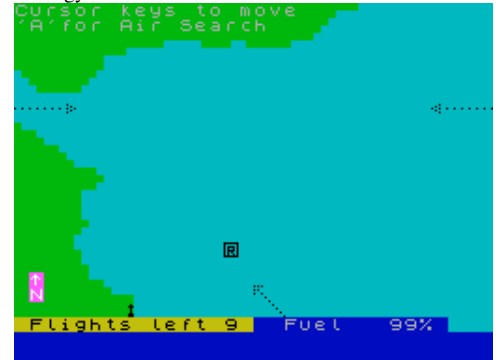

Raider of the Cursed Mine (Arcade Software,1983)
Arcade



Raiders of the Lost Ring (Arcade Software,1986)
Arcade

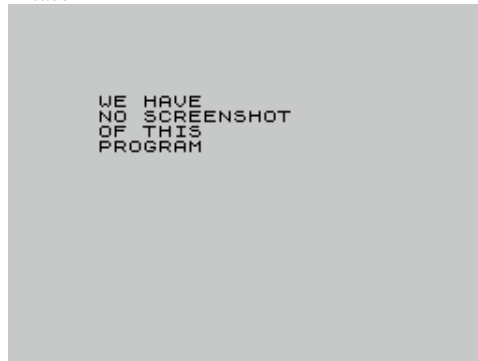

Raiders of the Lost Tomb (The Adventure Workshop,1995)
Text Adventure



Raid on Lethos (Dave Newton,1984)
Text Adventure

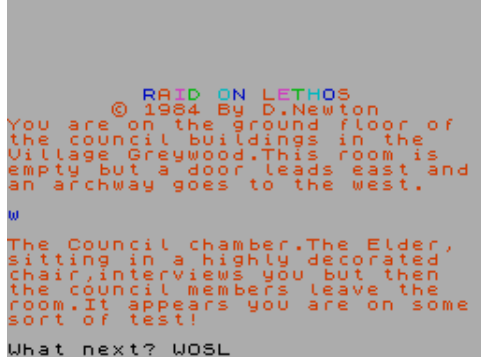

Railtour West (Dee-Kay Systems,1986)

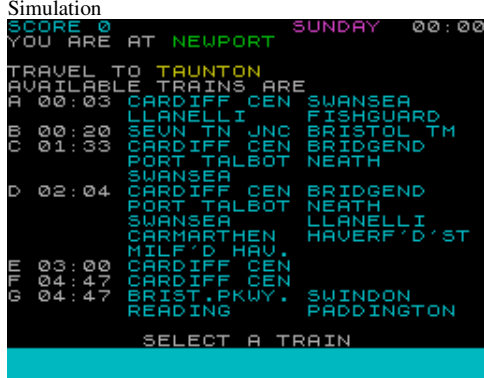

Rainbow Collection (Ocean Software Ltd,1991)

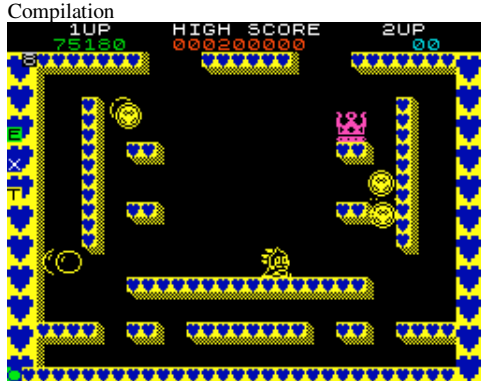

Rainbow Squash (Granada Publishing,1983)

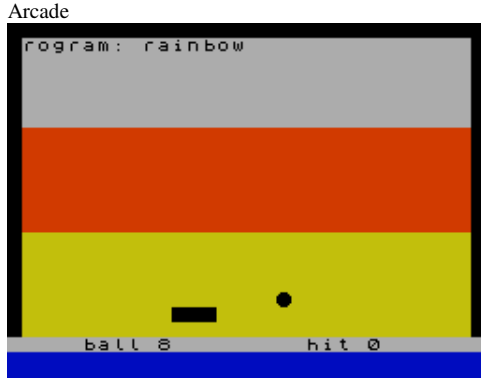

Rakattak (Gadtek Games,1987)

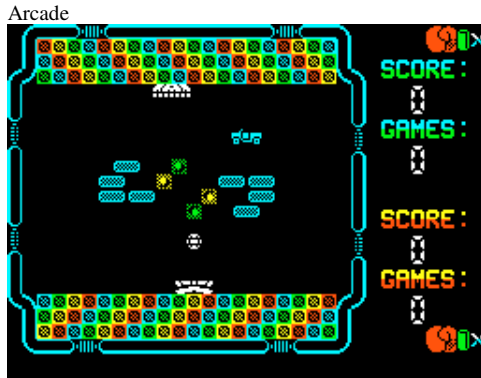

Raid over Moscow (US Gold Ltd,1985)
Arcade



Rain (J. Griffiths,1985)



Rainbow Islands (Ocean Software Ltd,1990)

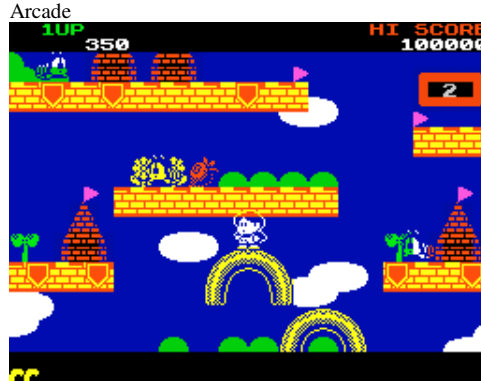

Rainbow Warriors (Red Wolf,1989)



Rally Cross (Anco Software Ltd,1989)



Railtour South (Dee-Kay Systems,)
Simulation



Rainbow 4K (Visual,1998)

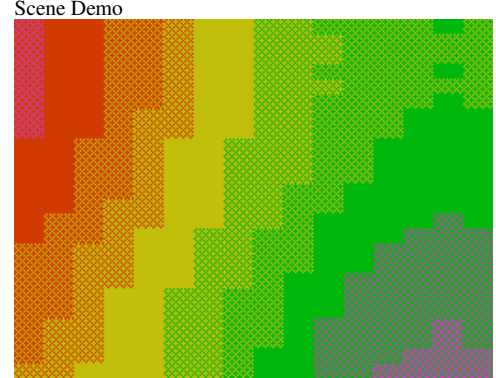

Rainbow Processor (Your Sinclair,1993)

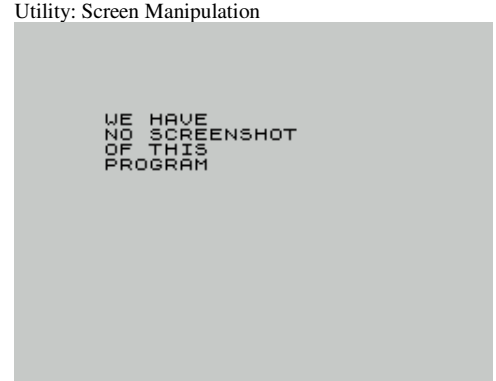

Rainy Day (CCS,1984)

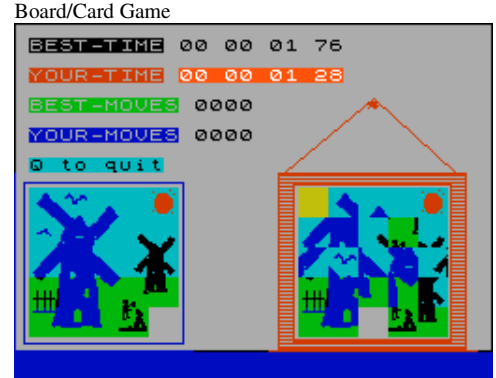

Rally Cross Simulator (Code Masters Ltd,1990)

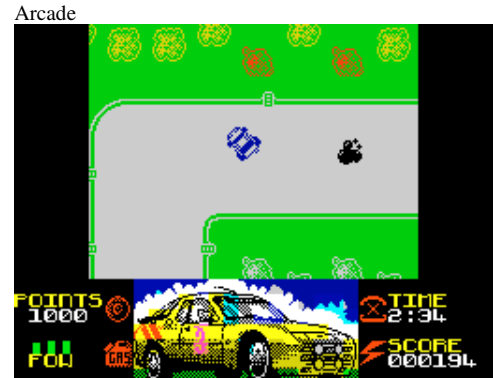

Rally Driver (Hill MacGibbon,1984)
Arcade

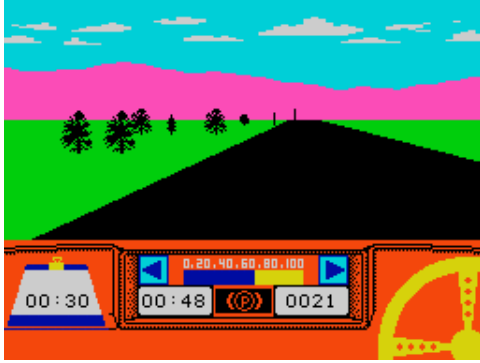

Ralph on Alpha 2 (16/48 Tape Magazine,1985)
Arcade



Rambo (Ocean Software Ltd,1985)
Arcade



Ram Disc 2 (RamDOS System,1986)
Utility: BASIC Related



RamDOS (High Byte Software,1985)
Utility: BASIC Related



Rally Simulator (Zeppelin Games Ltd,1989)
Arcade

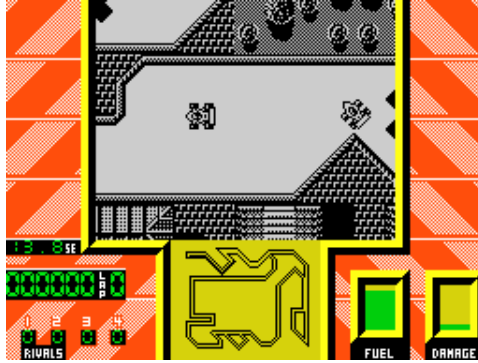

R.A.M. (Topo Soft,1990)
Arcade

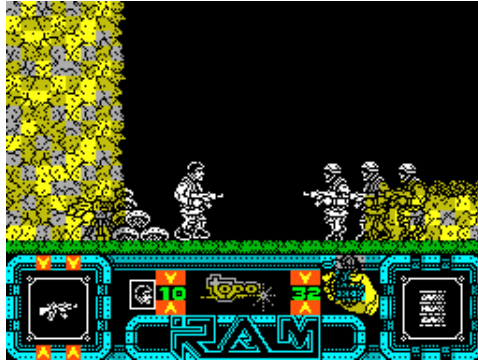

Rambo III (Ocean Software Ltd,1988)
Arcade

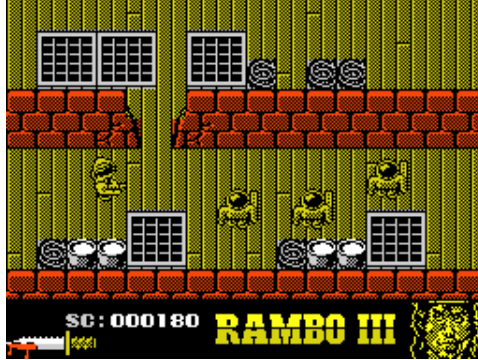

Ram Disc Copy (Zbynek Nejedly,1986)
Utility: Copier



RAMDOS (Roybot,1986)
Utility



Rally Z (Contrast Software,1983)
Arcade



R.A.M. 2: Space Mission (Topo Soft,)
Arcade



Ram-Disc (.)
Utility: BASIC Related



Ramdisk (Stephan Slabihoud,1986)
Utility: BASIC Related



Ram-Jet +3 (.)
Utility



Ramon Rodriguez (Erbe Software S.A.,1986)
Arcade



Rampart (Domark Ltd.)
Simulation



RAM Traks (JB Computing,1987)
Utility



Ranch (Spinnaker Software Corporation,1984)
Arcade

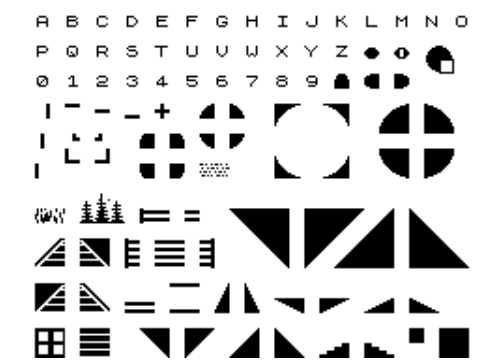

Random Attack (Theo's Micro-Engineering,1985)
Simulation

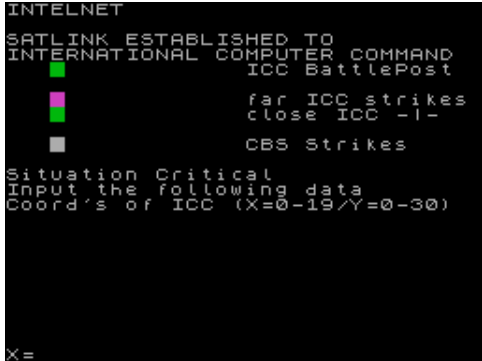

Rampage (Activision Inc,1988)
Arcade



Ramparts (Go!,1988)
Arcade



Rana, La (Microparadise Software,1984)
Arcade



Randax (MicroHobby,1985)
Arcade



Randy Warner and the Aztec Idol (Scorpio Gamesworld,1985)



Rampage (Newsoft Products,1982)
Arcade



RAM Test (.)
Utility

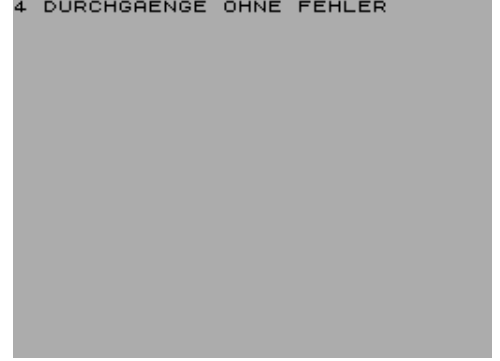

Ranarama (Hewson Consultants Ltd,1987)
Arcade Adventure

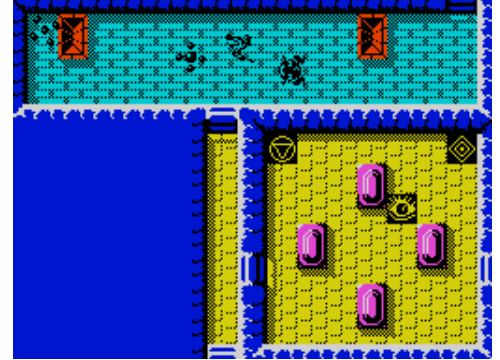

Randex (R.A. Soft,1996)
Arcade



Ranetech (Alien Software,1993)
Text Adventure



Ransom (MicroHobby,1985)
Arcade



Rapido, El (Microgesa,.)
Utility



RAS List 93 (Radical Alternative Software,1993)
Demo



Raster Runner (Mastertronic Plus,1990)
Arcade

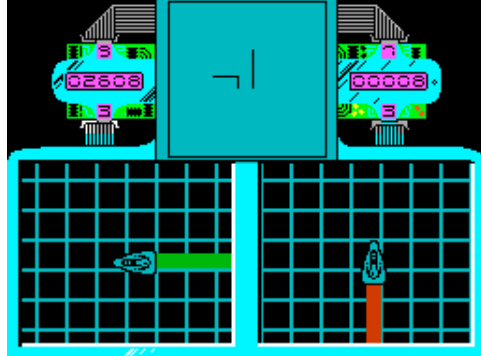

Rath-Tha (Positive,1989)
Arcade



Rapedes (Visions Software Factory,1983)
Arcade



Rapsallion (Bug-Byte Software Ltd,1984)
Arcade Adventure



Rasputin (Firebird Software Ltd,1986)
Arcade Adventure

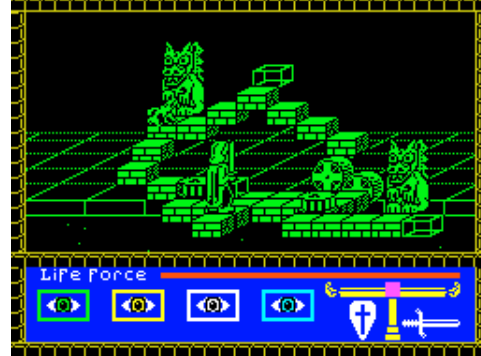

Rasterscan (Mastertronic Ltd,1987)
Arcade

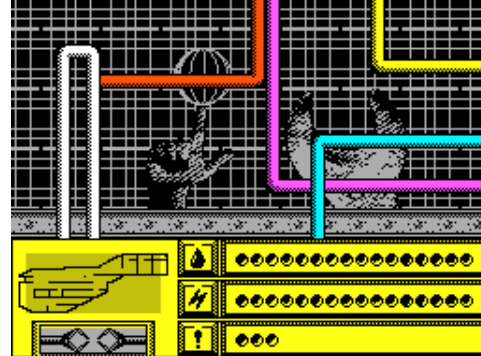

Rats & Cats (Stack Computer Services Ltd,1983)
Arcade



Rapid Fire (Mastertronic Ltd,1987)
Arcade

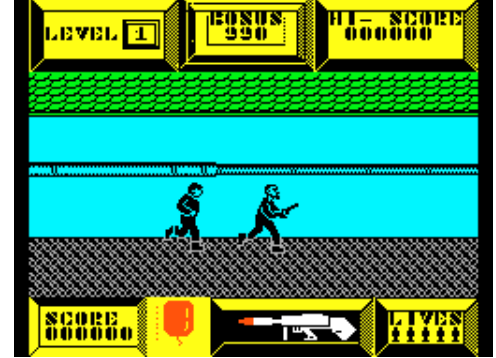

Rapto de Hector, El (Wazertown Works,.)
Text Adventure



Rastan (Imagine Software Ltd,1988)
Arcade

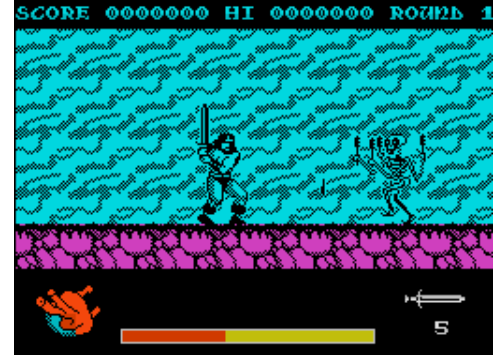

Ratas Asesinas, Las (MicroHobby,1985)
Arcade



Rats, The (Hodder & Stoughton Ltd,1985)
Text Adventure



Rattler (Atlantis Software Ltd,1985)
Arcade



Ravers Paradise, The (Illusion Group,1996)
Scene Demo

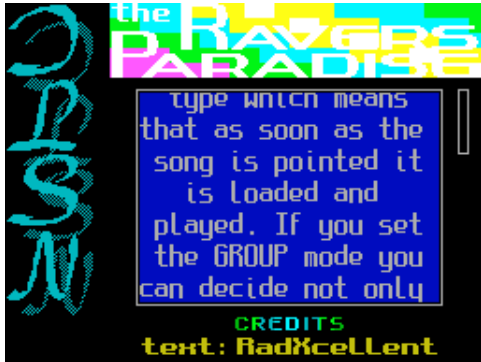

raww.orgy 2005 player (Icabod,2007)
Scene Demo



Raymond Pringle's Quest for the Fabled Jar of Pickled Cabbage (Delbert the Hamster Software,1993) Text Adventure



RD Digital Tracer (RD Labs,1983)
Utility

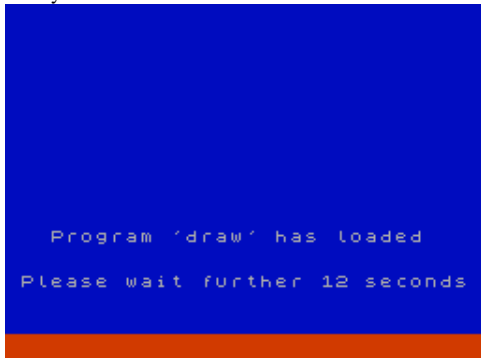

Rattus-Rex (A. Henrich,1985)
Text Adventure

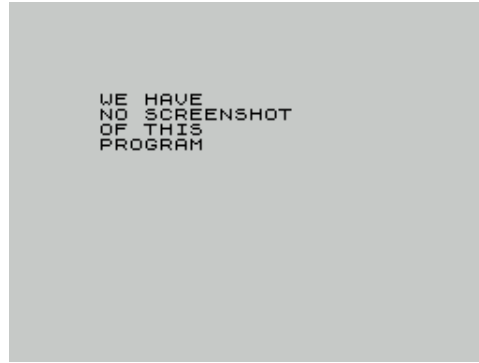

Ravine (.)
Arcade

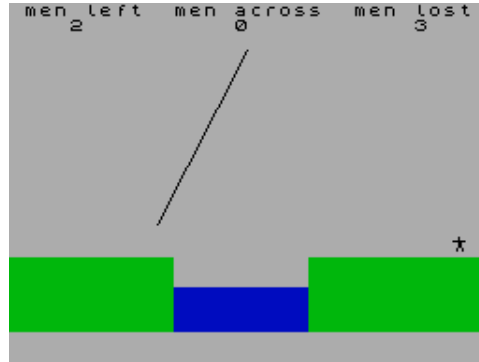

raww.orgy 2006 players (Icabod,2006)
Scene Demo



Rays (Tartan Software,1987)
Text Adventure

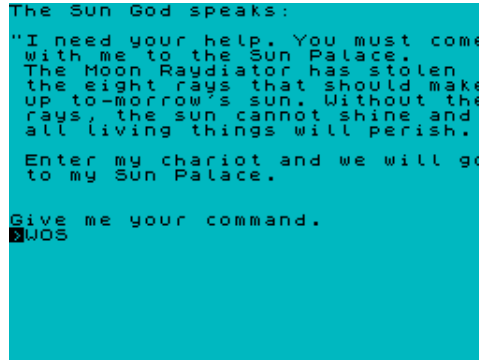

Reactions (Cloud 9 Software,1984)
Educational



Raven, The (8th Day Software,1988)
Text Adventure



Raw Recruit (Mastertronic Added Dimension,1988)
Arcade



raww.orgy 2007 player (Icabod,2007)
Scene Demo



R.B.I. 2 Baseball (Domark Ltd,1991)
Arcade



Reaction Tester (.)
Educational

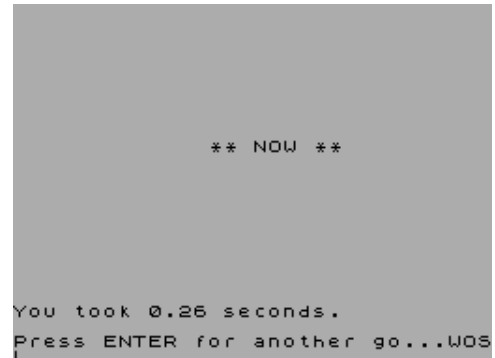

Reactor (Gemini Marketing Ltd,1984)
Arcade

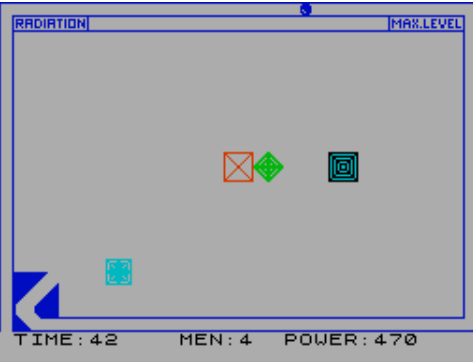

Reading Powerbox (Ashley Greenup,1991)
Simulation



Read-Right-Away - Reading Pack 2 (H.S. Software,1987)
Compilation



Real Debug (Cesar Hernandez Bano,1995)
Utility

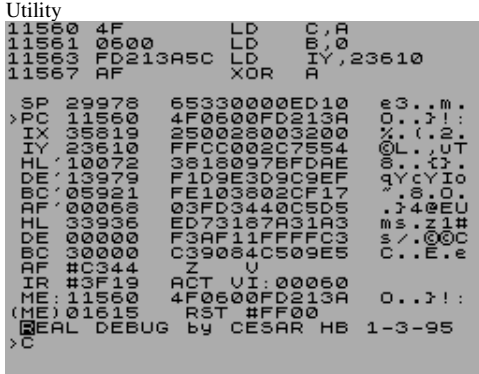

Real Lines (Saint Software,2000)
Board/Card Game

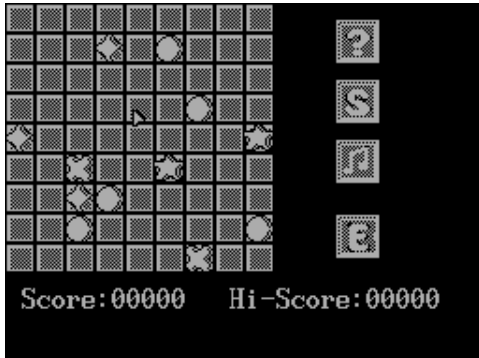

Reader (Norfolk Educational Psychologist,1987)
Educational

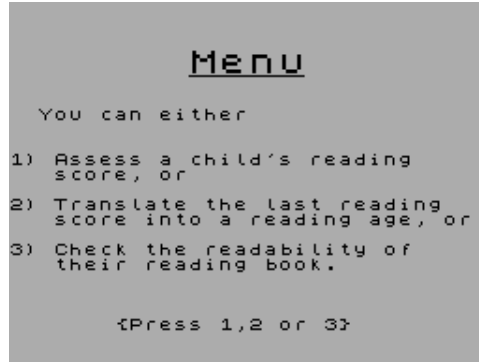

Read Me (Flash Inc.)
Scene Demo

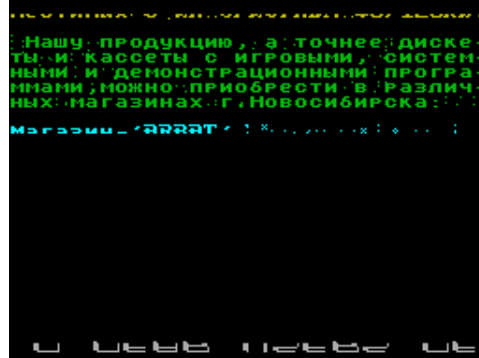

Ready Steady Go (Alternative Software Ltd,1988)
Sport



Real Ghostbusters, The (Activision Inc,1989)
Arcade



Really Sad Demo The (The United Minds,1996)
Scene Demo



Reader (Simon Software,1984)
Educational



Read-Right-Away - Reading Pack 1 (H.S. Software,1987)
Compilation

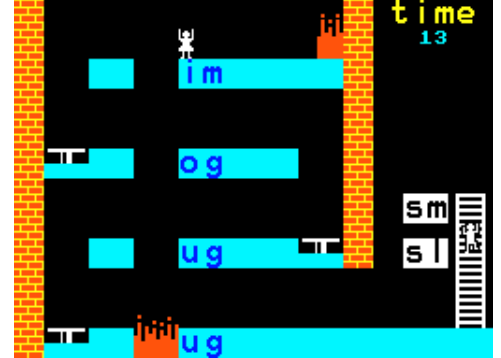

Real Action (Reaction,1997)
Scene Demo

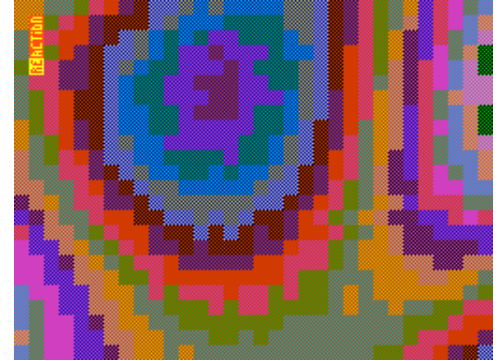

Reality Hacker (Visual Dimensions,1987)
Text Adventure



Realm + Boxing Manager, The (Willysoft UK,1986)
Compilation



Realm of Darkness (River Software,1987)
Text Adventure



Realm of Darkness + Matchmaker (River Software,1987)
Compilation



Realm of Impossibility (Ariolasoft UK Ltd,1985)
Arcade

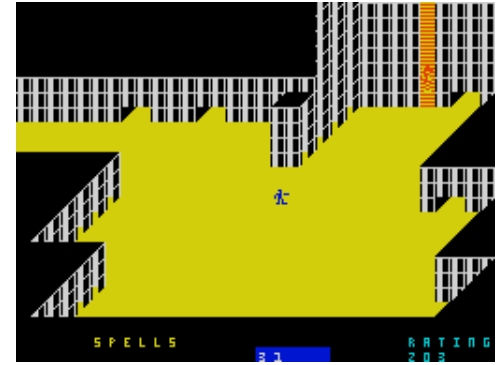

Realm of the Undead (Express Programmes Company,1984)
Arcade

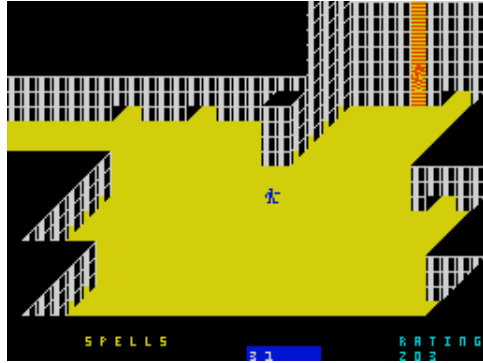

Realm of Troll (Rainbow Arts,)
Arcade



Realm, The (Cult Games,1986)
Text Adventure



Real Robocop, The (VVV Soft,)
Scene Demo



Real Stunt Experts, The (Alternative Software Ltd,1989) Arcade

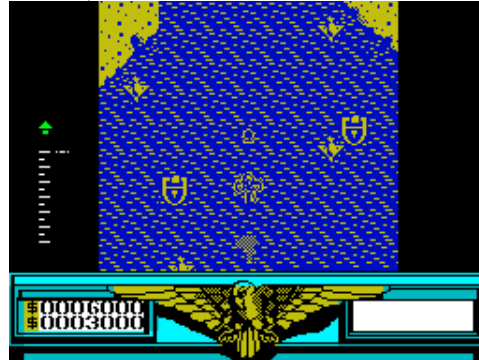

Real You?, The (Book Club Associates,1985)
Educational

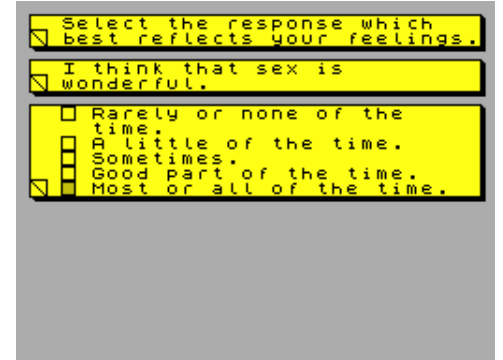

Reaper (Ubi Soft Ltd,1991)
Arcade

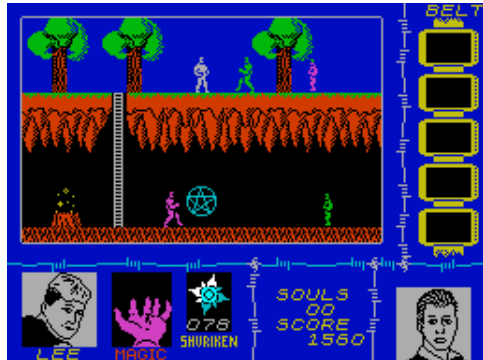

Reasoning - 11+ Yrs (Micro-De-Bug Consultancy,1984) Educational



Rebel (Virgin Games Ltd,1987)
Arcade

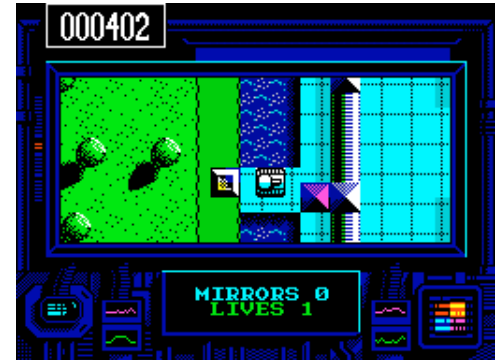

Rebel Force Harrier (,)
Arcade



Rebel Planet (US Gold Ltd,1986)
Text Adventure

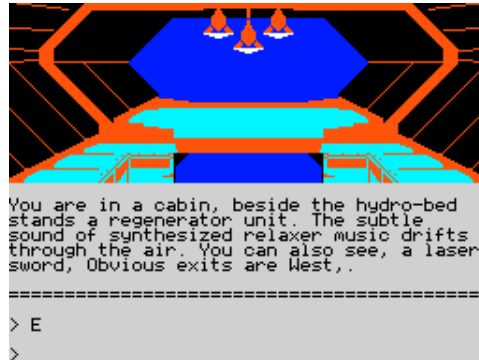

Rebelstar (Firebird Software Ltd,1986)
Strategy



Rebelstar 2 (Silverbird Software Ltd,1988)
Strategy



Re-Bouncer (Gremlin Graphics Software Ltd,)
Arcade



Recnik (Dragan Marjanovic,1986)
Utility: Word Processor

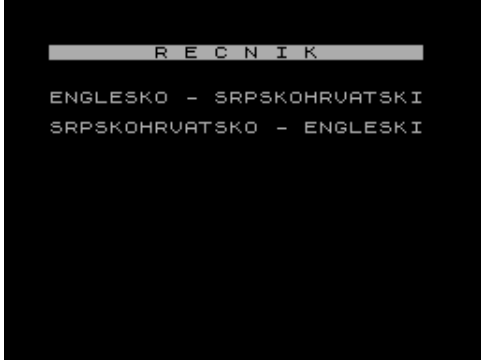

Red Alert (Zenobi Software,1991)
Text Adventure



Red Baron (MC Lothlorien Ltd,1983)
Simulation

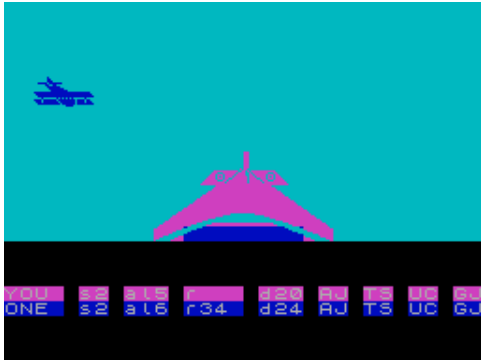

Rebelstar Collection, The (Mythos Games Ltd,1991)
Compilation

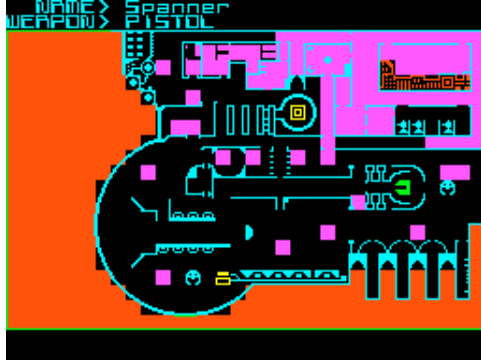

Reckless Rufus (Alternative Software Ltd,1992)
Arcade



Recovery (Jioi Chabek,1989)
Text Adventure

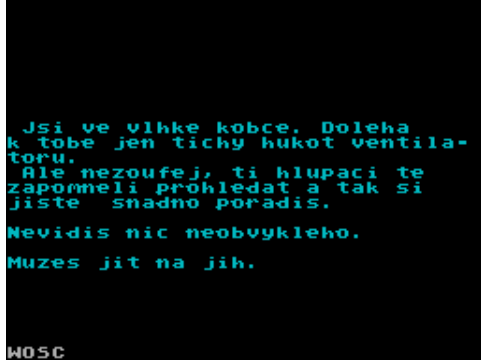

Red Arrows (Database Software,1985)
Simulation

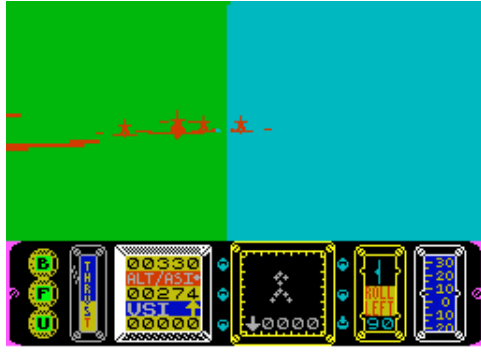

Redcoats (MC Lothlorien Ltd,1984)
Strategy



Rebelstar Raiders (Red Shift Ltd,1984)
Simulation

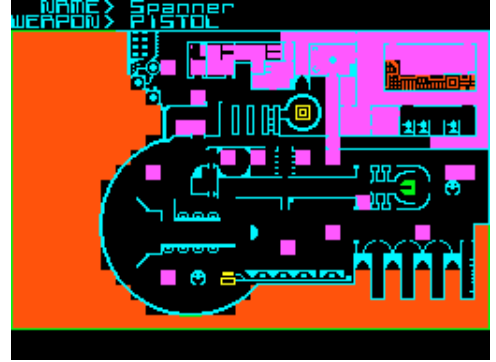

Reckoner, The (Replay Software,1986)
Simulation



Rec Time 6 (Sim & BonySoft,.)
Scene Demo



Red Attack (Unique,1984)
Arcade



Redcode Simulator (Egmont Koblinger,1995)
Utility: Word Processor

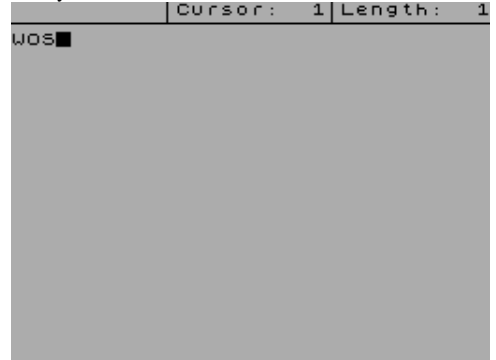

Red Door, The (Tartan Software,1988)
Text Adventure



Redhawk (Melbourne House,1986)
Text Adventure

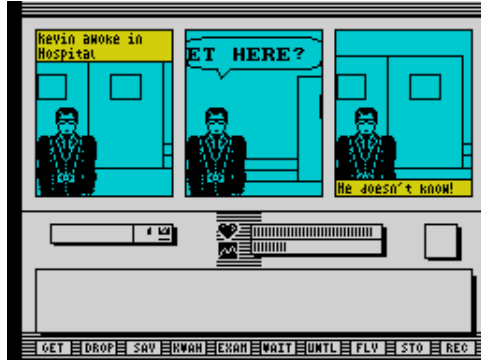

Red Lion, The (Mystic Software,1987)
Text Adventure

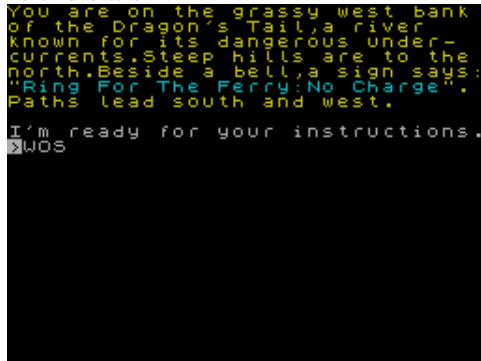

Reds (.)
Utility

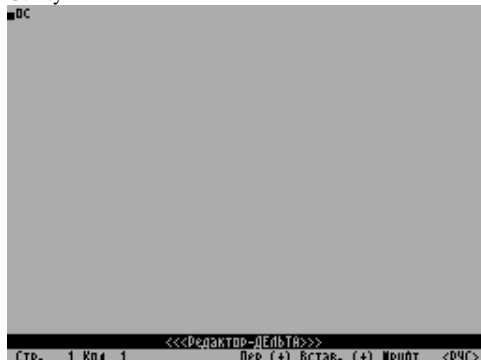

Red Sphere, The (Martin Tosas Bautista,1988)
Arcade

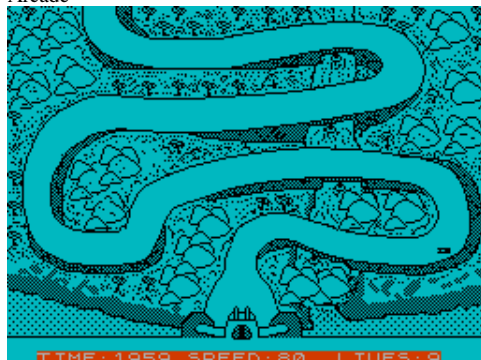

Red Dynamite Pack (Positive,1991)
Compilation

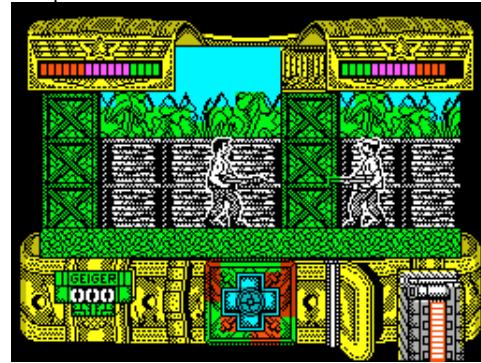

Red Heat (Ocean Software Ltd,1989)
Arcade

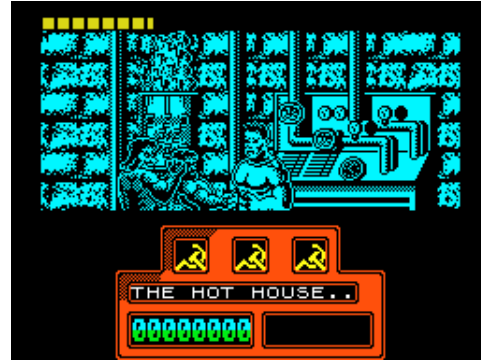

Red Moon (Level 9 Computing Ltd,1985)
Text Adventure



Red Scorpion (Quicksilver Ltd,1987)
Arcade

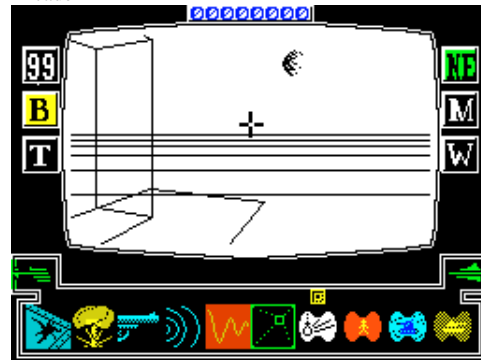

Red Stone II, The (Finest Group,1996)
Arcade

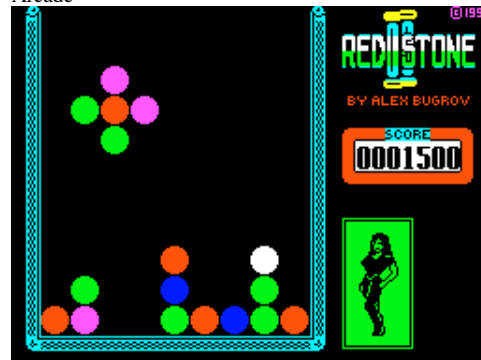

Red Fred (C&VG (Gamebook),1985)
Arcade

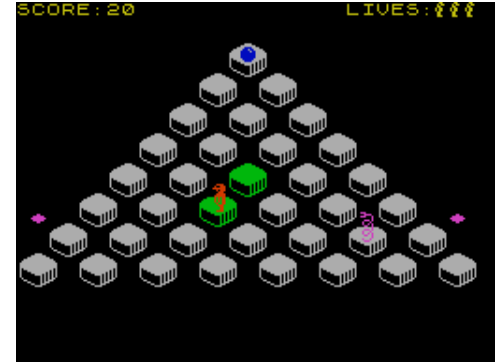

Red L.E.D. (Starlight Software,1987)
Arcade

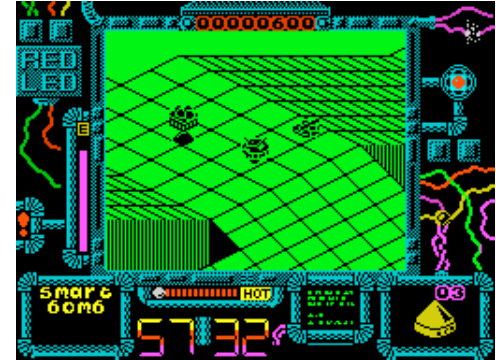

Red Riding Hood (Arrow,1984)
Educational

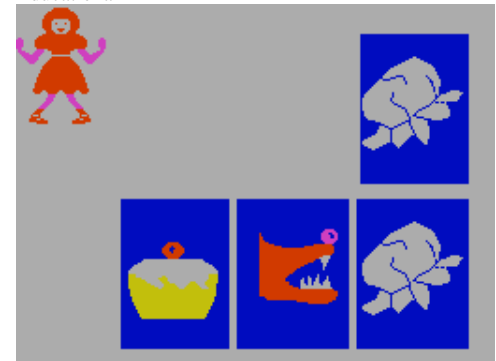

Red Sector (Herman Software,.)
Scene Demo

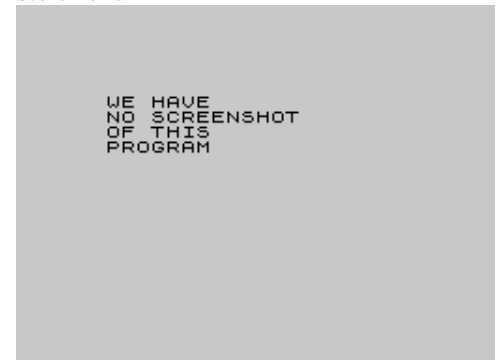

Red Stone, The (Finest Group,1995)
Arcade



Red Storm Rising (Microprose Software Ltd,1988)
Simulation



Reflections (Artic Computing Ltd,1983)
Arcade

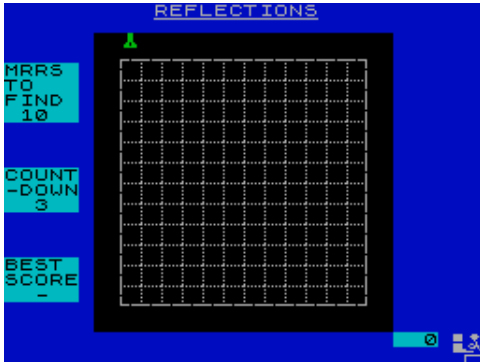

Regatul Magic (SuperSoft [2],1999)
Arcade Adventure



Regresion (MicroHobby,1985)
Educational



Reino de Atranta, El (Rock'n'Soft,)
Text Adventure



Red Weed (MC Lothlorien Ltd,1983)
Strategy

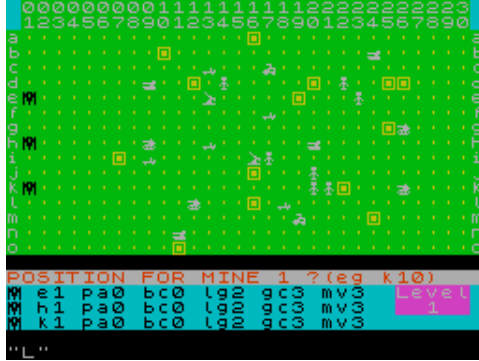

Reflex (.)
Arcade

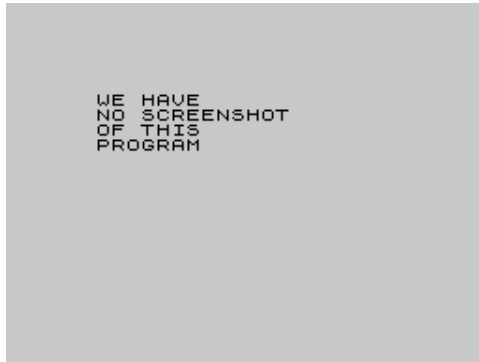

Regeners, The (Reserve Co,1995)
Arcade

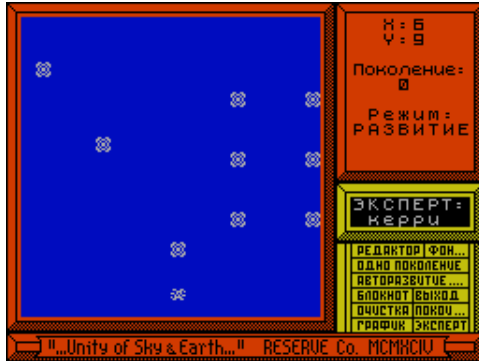

Regresiones (MicroHobby,1985)
Utility: Mathematics



Reino de Fantasia (Angel Fernandez Garcia,)
Text Adventure



Re-Evolucion (Software Atlantico,)
Text Adventure



Regatas (MicroHobby,1985)
Arcade

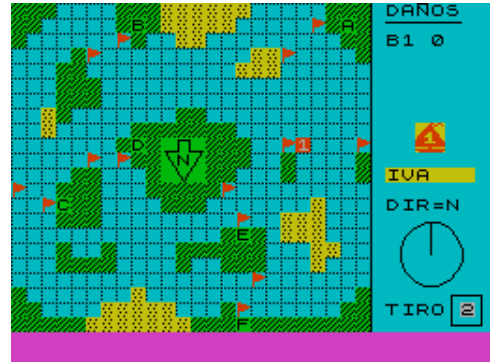

Regresioa Analyza (.)
Utility: Mathematics

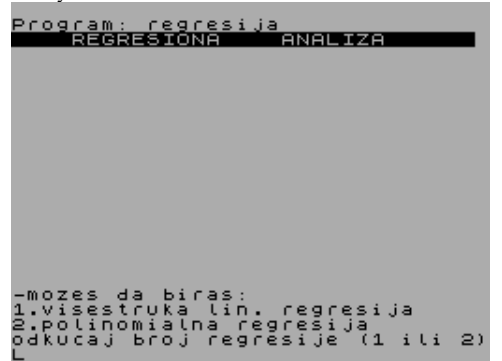

Reichswald (Scorpio Gamesworld,1984)
Strategy



Reka (Colic,1986)
Arcade



Relocate (.)

Utility: BASIC Related

Saving re-locator wos
Call with LET x=USR 60000
before main call.

REM WOSL

Rendez-Vous in Black & White (The Lords,1990)

Scene Demo

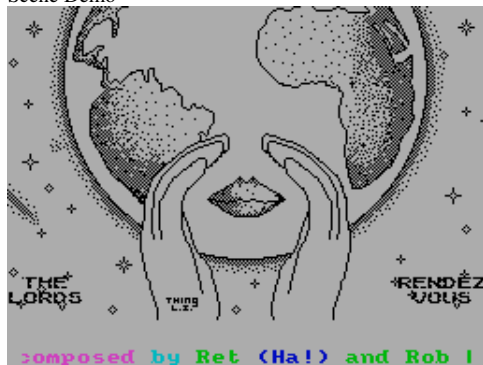

composed by Ret (Ha!) and Rob I

Rent (Coolguys Ltd.)

Scene Demo



Renumber (Your Sinclair,1993)

Utility: BASIC Related

```
10 REM WOS
9990 >REM this was line 11
9990 REM renumber
9991 LET x=PEEK 23635+256*PEEK 2
3636
9992 LET Fln=10: REM 1st LINE No
.
9993 LET lns=10: REM LINE No. st
ep
9994 IF PEEK (x+1)+256*PEEK x=99
90 THEN STOP
9995 POKE x,INT (Fln/256)
9996 POKE x+1,Fln-256*INT (Fln/2
56)
9997 LET Fln=Fln+lns
9998 LET x=x+4+PEEK (x+2)+256*PE
EK (x+3)
9999 GO TO 9994
```

Renumerador (MicroHobby,1985)

Utility



Remember This (Flash Inc,1994)

Scene Demo

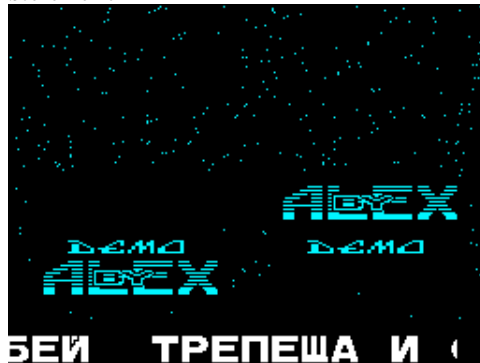

Renegade (Imagine Software Ltd,1987)

Arcade



Rentakill Rita (Mastertronic Ltd,1987)

Arcade

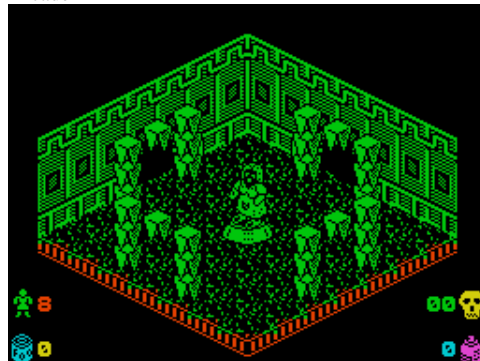

Renumber & Delete (AWA Software,1983)

Utility

```
THIS PROGRAM HAS 4 FUNCTIONS: -
R...RENUMBER
D...DELETE BETWEEN SPECIFIED
LINE NUMBERS
K...KILL ALL REM STATEMENTS
BETWEEN SPECIFIED LINES
M...CALCULATES FREE MEMORY

PRESS "ENTER" TO CONTINUE
"C"
```

Replay (Jacek Michalak,1992)

Scene Demo



Ren and Stimp Slideshow, The (Extacy-3,1994)

Scene Demo



Renegade III: The Final Chapter (Imagine Software Ltd,1989)

Arcade



Renumber (16/48 Tape Magazine,1984)

Utility: BASIC Related



Renumber/Delete (Work Force,1983)

Utility: Programming

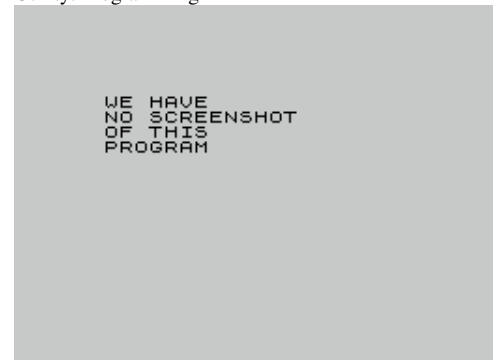

Replicate (J.R. Ball,1983)

Utility: Copier

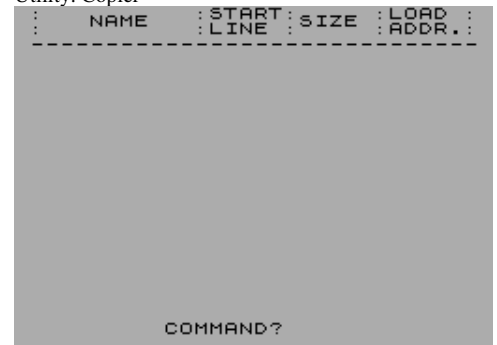

Representacion Grafica (MicroHobby,1986)
Educational

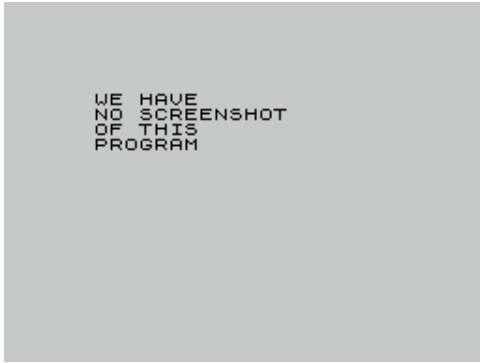

Representacion Tridimensional (MicroHobby,1985)
Educational



Repton (Alligata Software Ltd,1989)
Arcade Adventure

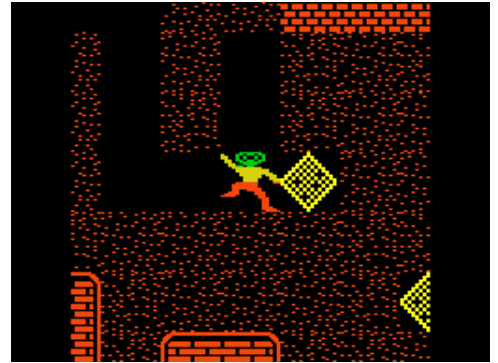

Repton 2 (Alligata Software Ltd,1989)
Arcade Adventure



Repton Mania (Superior Software Ltd,1989)
Compilation

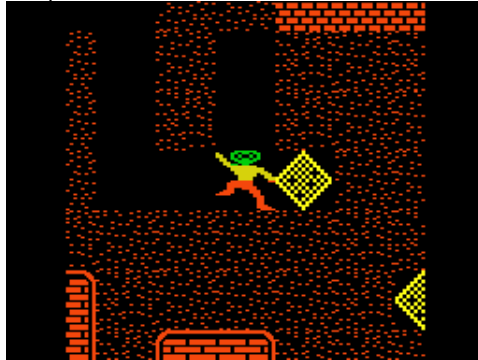

Repulsar (Softtek Software International Ltd,1983)
Arcade

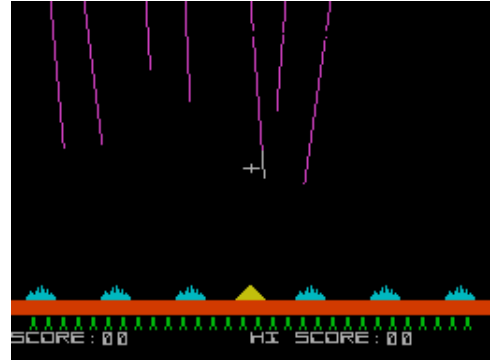

Repulser (Haven Hardware,1983)
Arcade



Rescate (MicroHobby,1985)
Arcade

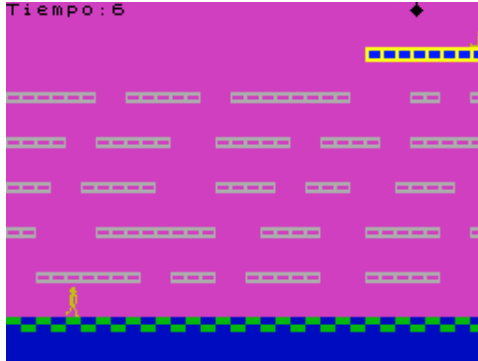

Rescate (Ricardo Oyon Rodriguez,1989)
Text Adventure



Rescate Atlantida (Dinamic Software,1992)
Arcade



Rescate del Tesoro (Investronica S.A.,1984)
Arcade



Rescate en el Golfo (Opera Soft S.A.,1990)
Arcade

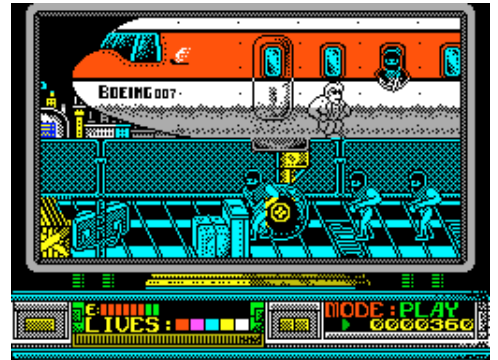

Rescate en la Montana (Cibercomp S.A.,1984)
Arcade



Rescode (16/48 Tape Magazine,1984)
Utility

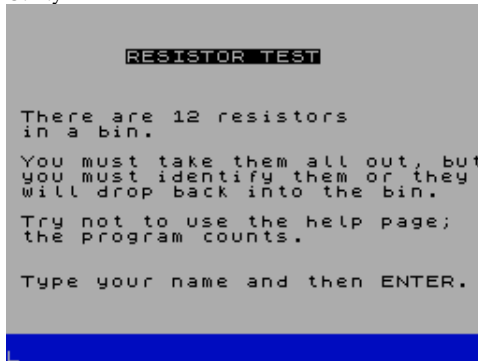

Rescue (CRL Group PLC,1982)
Arcade

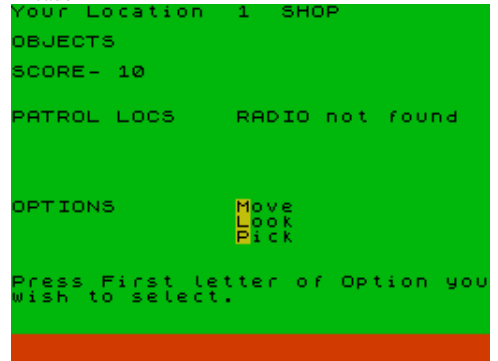

Rescue (Mastertronic Ltd,1987)
Arcade

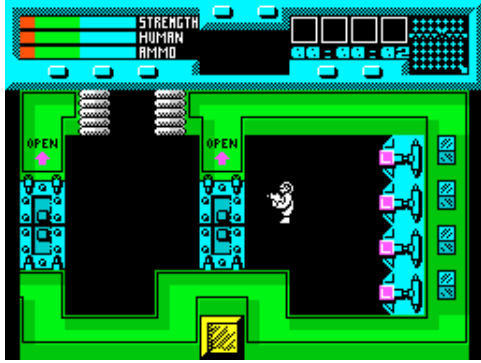

Rescue from Doom (The Guild,1986)
Text Adventure

```
You are in a small cave. There
is a set of stairs here leading
up.
I can also see:-
A bouncy ball.
Now what ?
>WOS
```

Resistor Colour Coder (Spectrum Computing,1985)
Utility



Resound 1 (R-Soft,1993)
Scene Demo



Retrophemia (Jose Maria Gonzalez Ondina,2006)
Text Adventure

```
© 1982 Microsoft Research Ltd.
¡Aaaaaaaargh! Gritas con
una voz tres tonos por encima
de lo que te habría gustado.
Algo ha ido realmente mal.
Algo se ha trastocado en el
universo.
¡Estás viviendo en el peor de
los mundos posibles!
1 - Vas a Internet en busca de
más información.
2 - No le das importancia y
vuelves a intentar cargar el
Alien B.
```

Rescue (Ocean Software Ltd,1983)
Arcade



Rescue on Fractalus! (Activision Inc,1986)
Arcade

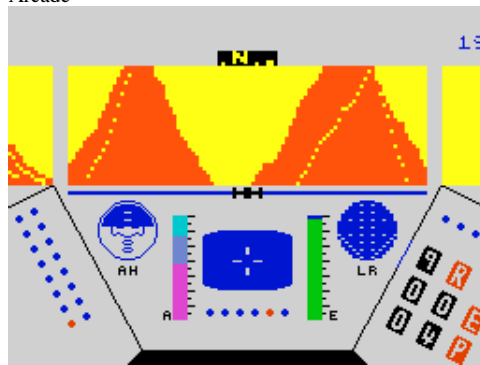

Resolucion de Triangulos (MicroHobby,1985)
Educational



Retarded Creatures and Caverns (Zenobi Software,1989)
Text Adventure

```
the door, someone had erected a
small, cast-iron foot-scraper.
→EXAM SCRAP
Set firmly into the ground, it
was the sort of thing that you
used to scrape the mud off your
boots BEFORE going indoors. At
one end was the head of a donkey
whilst at the other was its tail
and joining them both was a long
length of metal bar that served
as the scraper.
→SCRAPE FOOT
Raising each foot in turn, he
drew it across the metal-bar.
Something stirred in the depths
of the moat.
→
```

Return of Sock, The (Spectrum Adventure Exch Club,1987)
Text Adventure

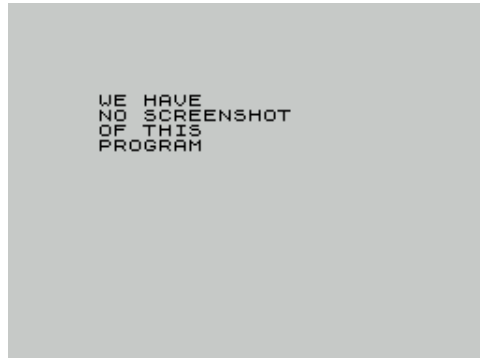

Rescue (Professional Software,1983)
Arcade



Reset (MicroHobby,1985)
Utility



Resolution (Nexus Productions Ltd.)
Arcade Adventure



Retro '84 Compilation (Jatekgyaros,1984)
Compilation



Return of the Holy Joystick, The (Delta 4 Software,1984)
Text Adventure

```
You stand at a bus shelter in
the Alexandra Park. To the south
is the foot of Muswell Hill and
the road goes north amidst the
trees unto the Ally Pally. An
old poster hangs off the bus
shelter dismally.
A path leads west.
What will you do now ?
>WOS
```

Return of the Jedi (Domark Ltd,1987)
Arcade



Return of the Living Death (.)
Text Adventure



Return of the Warrior (G.H. Larsen,1984)
Text Adventure

I am on a deserted beach at the South side of the Great Ocean. Waves pound the pebbles beneath my feet. Large dunes rise high above me to my South whilst the beach stretches East/West.

Tell me what to do.
*W05

Return to Earth (Saturnsoft,1982)
Text Adventure

Examine cabinet
PARDON?

You are in the control room, only a steel cabinet remains undamaged, 4 corridors lead off

What will you do now? "W0SL"

Return to Ithaca (Atlantis Software Ltd,1985)
Text Adventure

You are on board a Greek War Galley. A kaleidoscopic sail, suspended from the single mast, billows in the wind. An image of the Goddess Athene, your protector, serves as figurehead. I can also see: -
An empty wine **skin**

I'm ready for your instructions.
*W05

Return of the Jedi: Death Star Battle (Parker Software/Sinclair Research Ltd,1984) Arcade

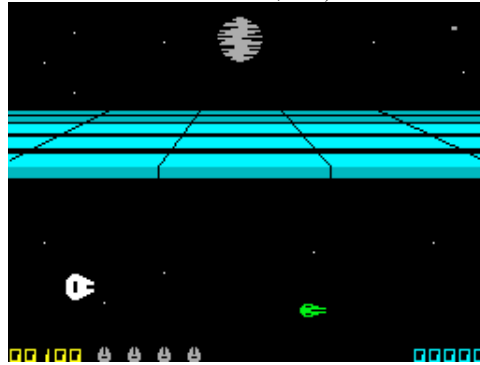

Return of the Ring (Wintersoft,1984)
Text Adventure



Return to Castle Dracula (.)
Text Adventure



Return to Eden (Level 9 Computing Ltd,1984)
Text Adventure

sabotage on the evidence of fire-damaged videos, you have fled to Eden. You're in the control room of a crashed stratoglider. A vision screen shows the strange plants on Eden. There's an opening behind you. What now? S
You're in a padded room. What now? NO CHANGE THERE, THEN?

Return to Oz (US Gold Ltd,1986)
Arcade Adventure



Return of the Jedy (M.K. Circuits,1983)
Arcade

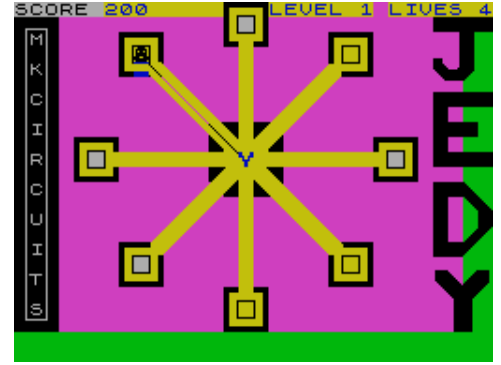

Return of the Things (Design Design Software,1984)
Arcade



Return to Doom (Topologika,1988)
Text Adventure



Return to Home 4 (K.Kav Software,1996)
Strategy

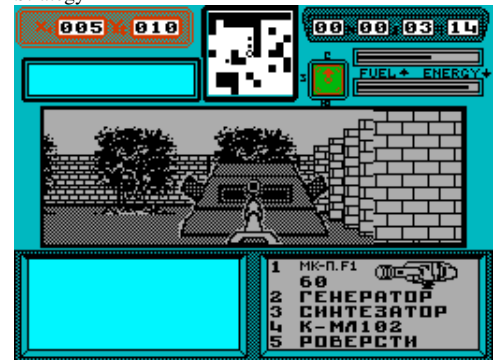

Reveal (Mastertronic Ltd,1989)
Arcade



Revelados (Compiler Software,2006)
Simulation



Revenge of the Killer Tomatoes (Visions Software Factory,1984) Arcade

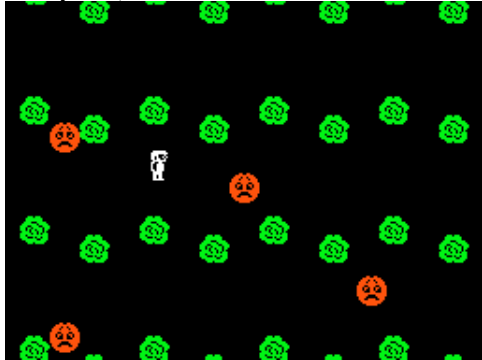

Reversi (.)
Board/Card Game



Reversi (C&VG,1982)
Board/Card Game

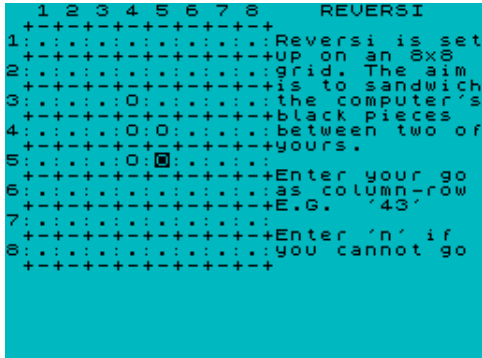

Reversi (Sinclair Programs,1983)
Board/Card Game

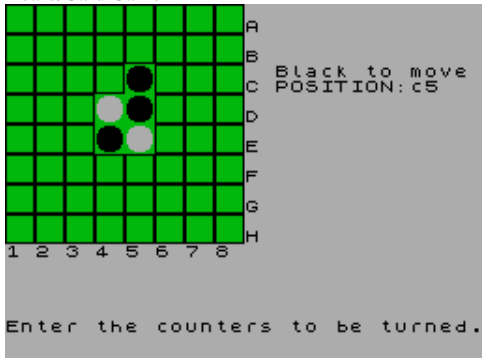

Revenge of Chaos (The Guild.)
Text Adventure

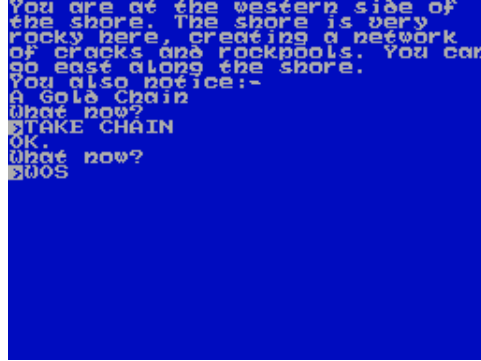

Revenge of the Space Pirates (FSF Adventures,1994)
Text Adventure

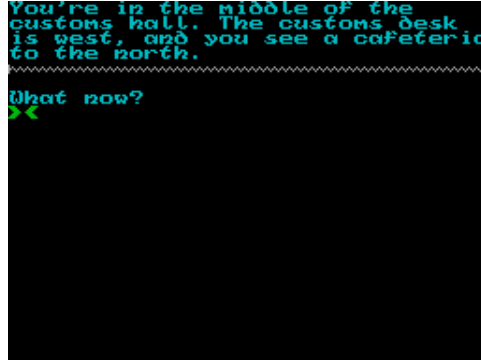

Reversi (Artic Computing Ltd,1983)
Board/Card Game



Reversi (Gilsoft International,1982)
Board/Card Game



Reversi (Sinclair Research Ltd,1982)
Board/Card Game

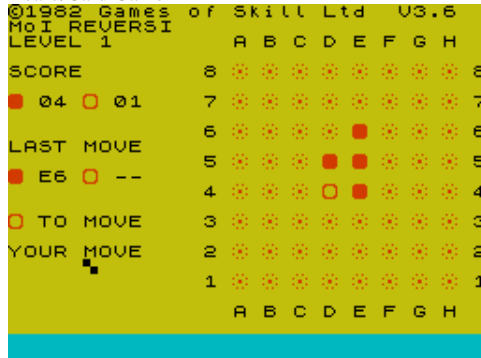

Revenge of the C5 (Atlantis Software Ltd,1985)
Arcade



Reversals (Chalksoft Ltd,1983)
Educational

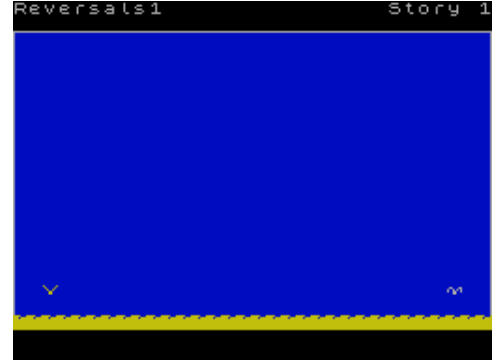

Reversi (CDS Microsystems,1983)
Board/Card Game

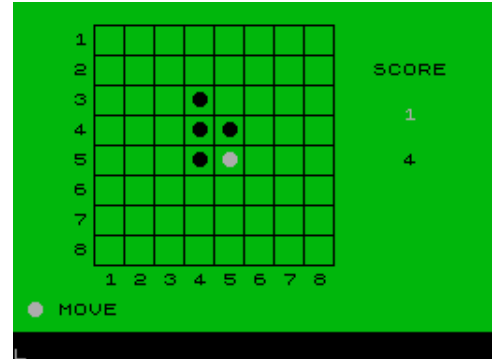

Reversi (Phipps Associates,1982)
Board/Card Game

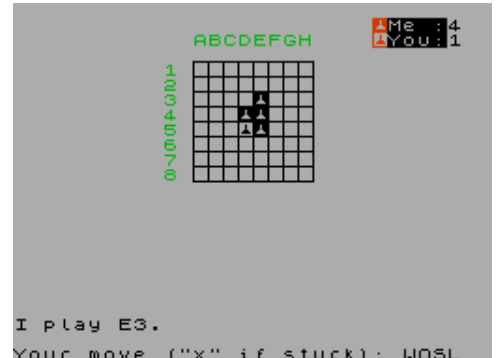

Reversi (Spartan Software,1984)
Board/Card Game



Reversi (Your Computer,1983)
Board/Card Game

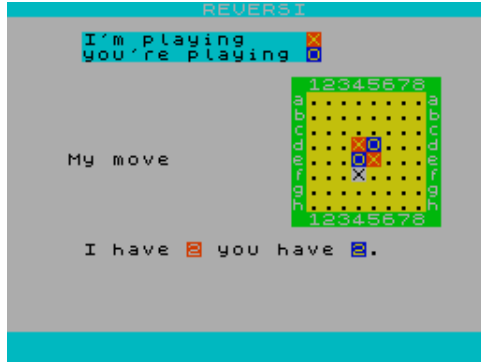

Reversor (Peter Witzgall,1983)
Board/Card Game

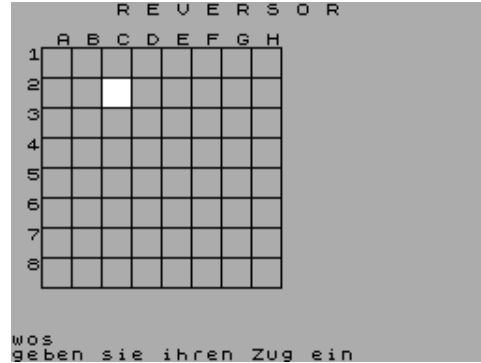

Revised Champions of Cricket 1993 (Lambourne Games,1994)
Simulation

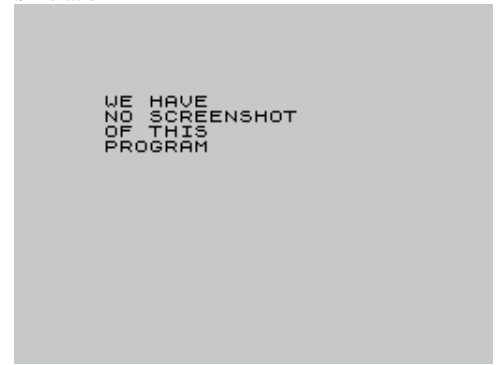

Revised Champions of Cricket 1994 (Lambourne Games,1994)
Simulation

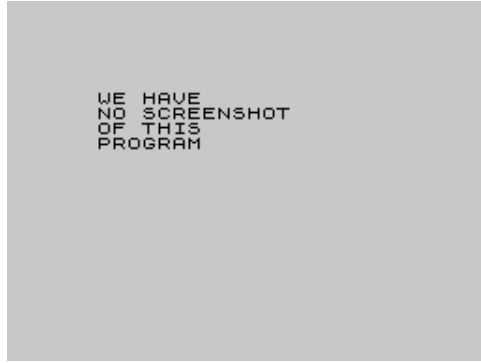

Revised Champions Of Cricket - 2 To 6 Version Mark 5 (Lambourne Games,1994) Simulation

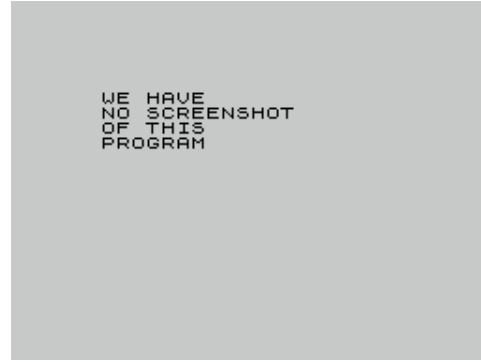

Revised World Cup Cricket 1993 (Lambourne Games,1993)
Simulation



Revised World Cup Cricket - Great Players of the Sixties (Lambourne Games,1994) Simulation



Revise Physics (SciCAL Software Ltd,1985)
Educational



Revolution (US Gold Ltd,1986)
Arcade

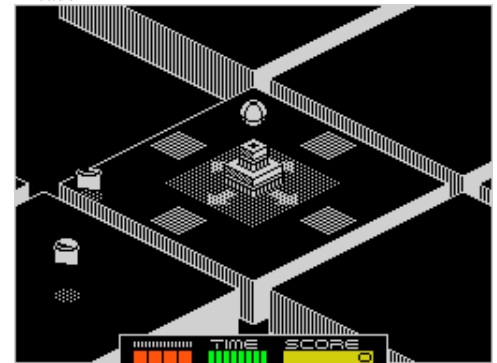

Revolver (Alternative Software Ltd,1988)
Arcade



Rex (Martech Games Ltd,1988)
Arcade



Rex Hard (Mister Chip,1987)
Arcade Adventure



Rey del After Sun, El (MicroHobby,1986)
Arcade



Reyes Y Castillos (Special Soft,1984)
Arcade



R.F. Tuned Circuits (Roelof Koning,1984)
Utility: Electronics

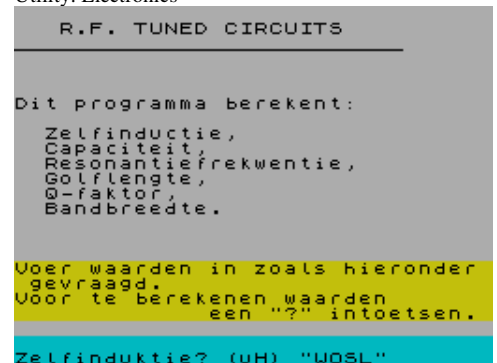

Rhaa Lovely I + II (The Lords,1990)
Scene Demo



Rhythm Generator (Your Computer,1983)
Utility: Music Creation

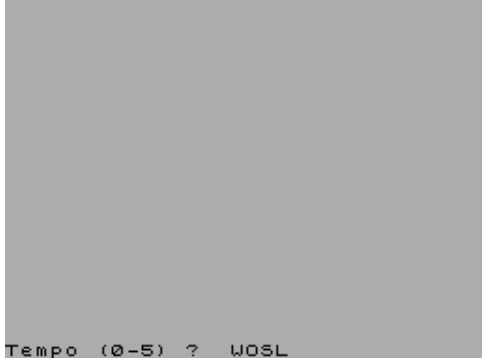

Ricochet (Firebird Software Ltd,1987)
Arcade



Riddler's Den (Electric Dreams Software,1985)
Arcade Adventure

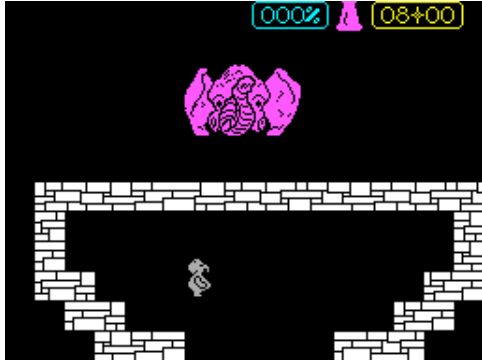

Riding the Rapids (Players Software,1987)
Arcade

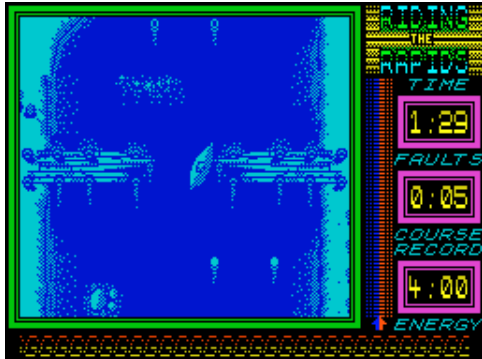

Rhun (EP Software,)
Arcade

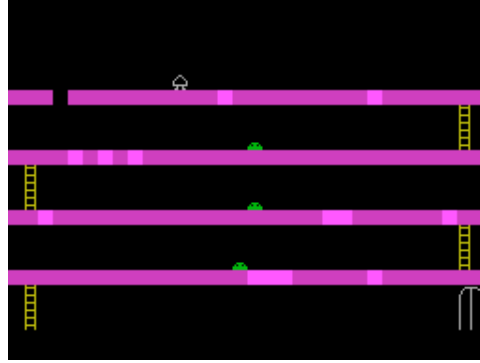

Rick Dangerous (Firebird Software Ltd,1989)
Arcade

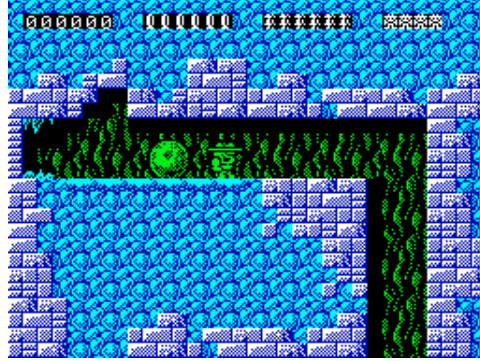

Ricochet (unpublished,1989)
Utility: Copier

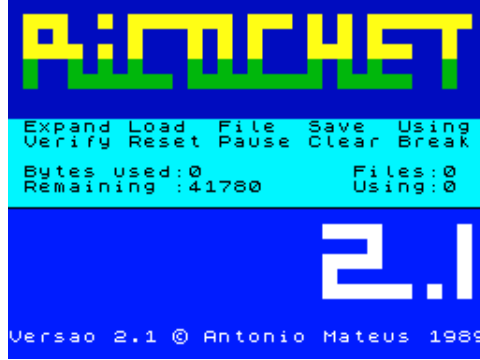

Rider (Virgin Games Ltd,1983)
Arcade



Rifle Range (Mastertronic Ltd,1984)
Arcade



Rhyme Cryme (Zenobi Software,1996)
Text Adventure



Rick Dangerous 2 (Micro Style,1990)
Arcade

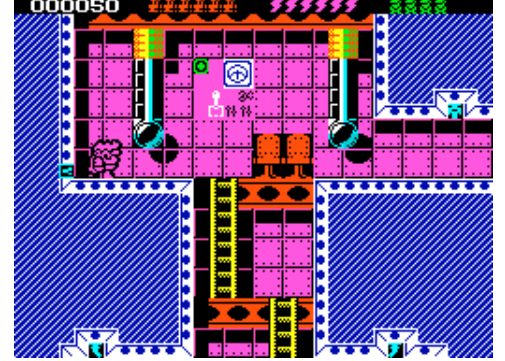

Riddle of the Sphinx (Longman Software,1984)
Educational



Rider Demo (Oleg Moskalenko,1993)
Scene Demo

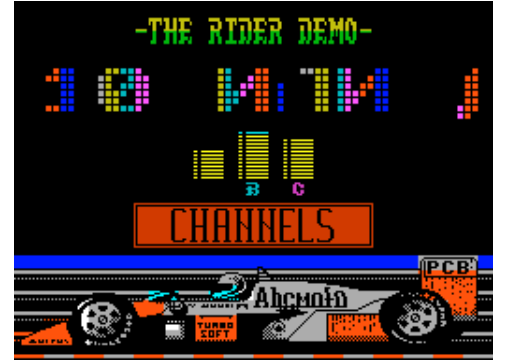

Rifts of Time, The (Pocket Money Software,1984)
Text Adventure

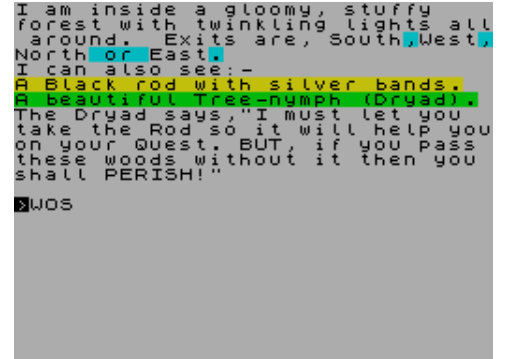

Rigel's Revenge (Bulldog,1987)

Text Adventure

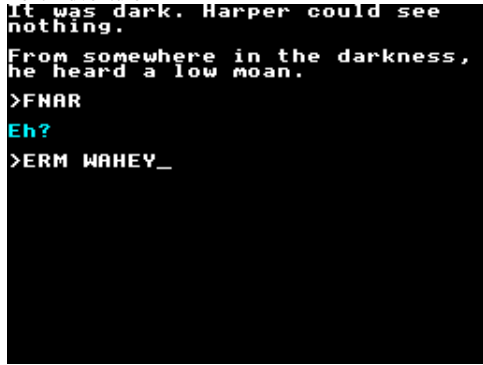

Rik the Roadie (Alternative Software Ltd,1988)

Arcade



Ring-O (Elephant Software,1983)

Arcade



Ring of Inger, The (unpublished,)

Text Adventure

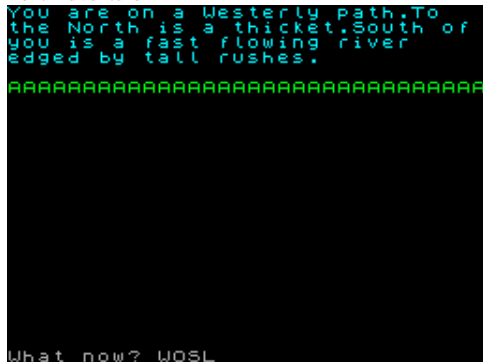

Rings of Saturn, The (,)

Text Adventure



Right Pile of Crap, A (Zenobi Software,1993)

Compilation



Rimrunner (Palace Software,)

Arcade

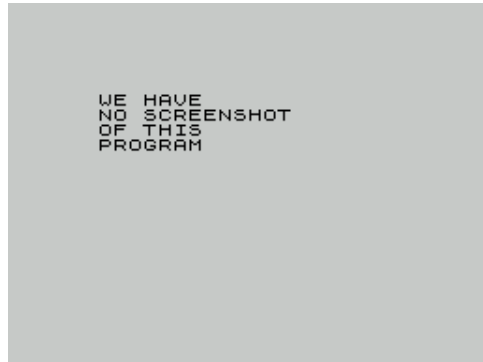

Ring of Darkness, The (Wintersoft,1983)

Text Adventure



Ring Quest (Uburg Software,)

Text Adventure

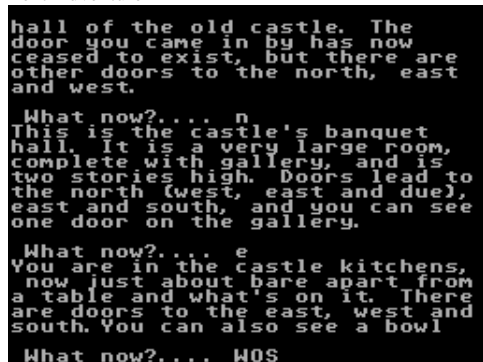

Rings of The Magic (Global Corporation,1996)

Board/Card Game

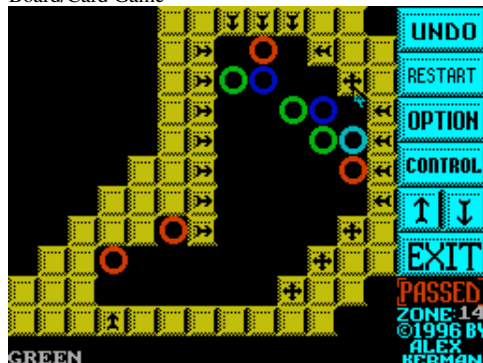

Rikosphere (Your Sinclair,1992)

Arcade

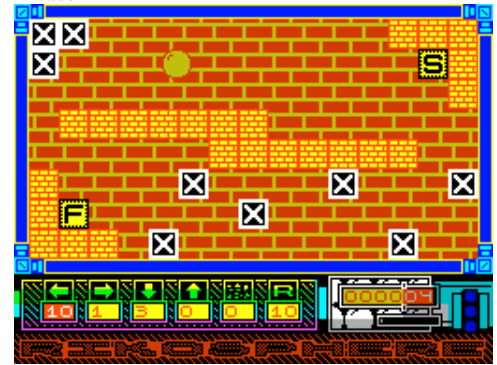

Ring Master (,)

Text Adventure



Ring of Dreams, The (Central Solutions,1985)

Text Adventure

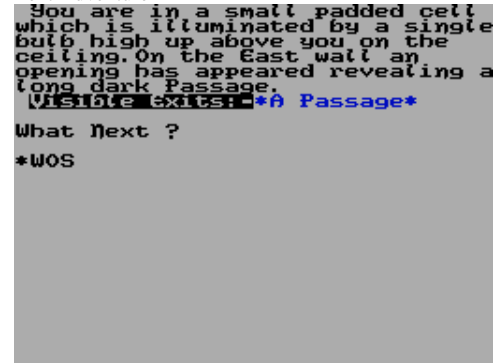

Rings of Merlin, The (Gordon Fong,1986)

Text Adventure

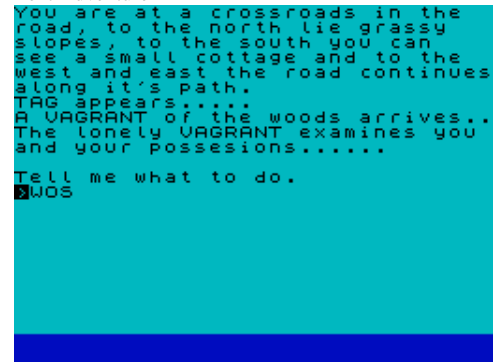

Ring Wars (Cascade Games Ltd,1989)

Arcade

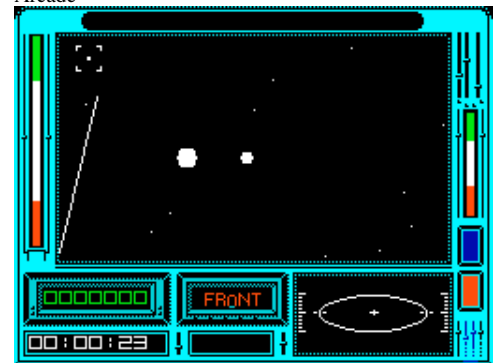

Ringworld (Games Workshop,1984)
Board/Card Game

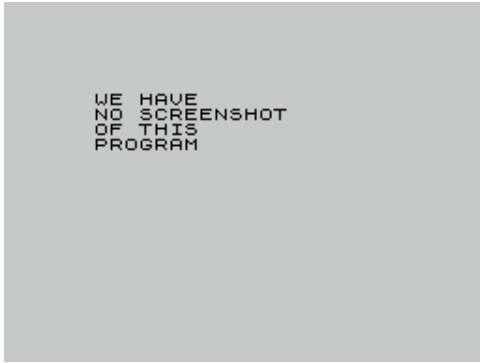

Riptoff (Your Sinclair,1991)
Arcade



Risk (Leisure Genius,1989)
Strategy



Ristar Rjecnik (Megasoft [3],1985)
Utility: Database

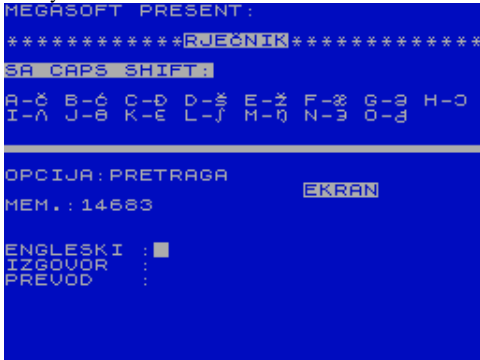

RITM 3 (Fire Angel Software,1993)
Scene Demo



Rio Blanco (MicroHobby,1989)
Arcade Adventure

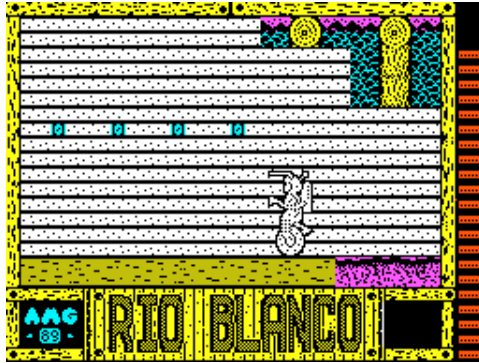

Risar (Radio Student,1984)
Utility: Screen Manipulation

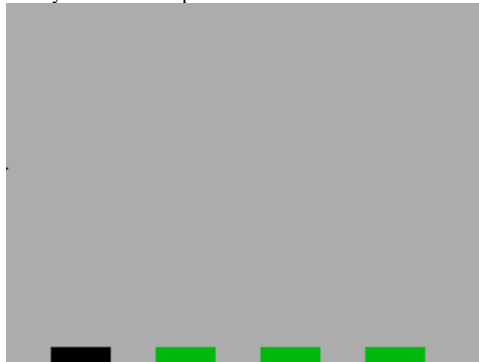

RISK Compendium (Bartle Electronics,1986)
Strategy



RITM 1 (Fire Angel Software,1993)
Scene Demo



Ritm 4 (Fire Angel Software,1993)
Scene Demo

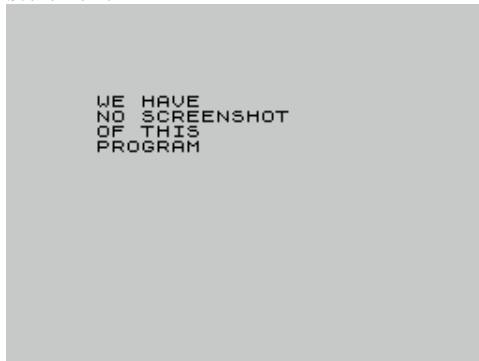

Rio Karate (MicroHobby,1986)
Arcade

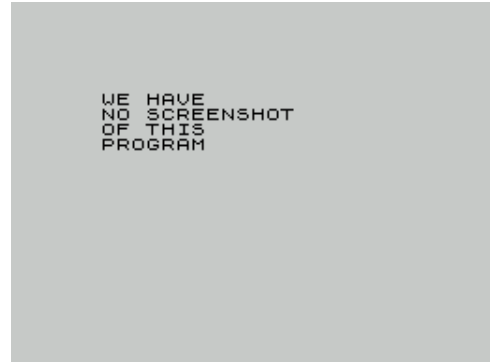

Rise out from Dungeons (Vadim Vetyutnev,1994)
Arcade



Risky Risk (MicroHobby,1985)
Arcade

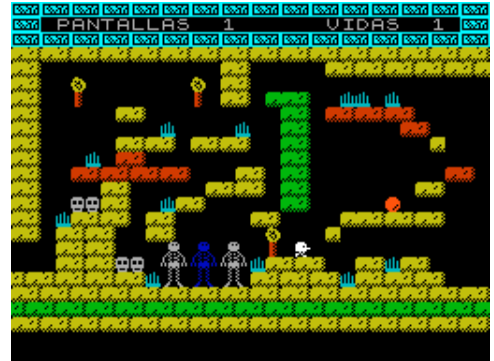

RITM 2 (Fire Angel Software,1993)
Scene Demo



RITTY-9 (.)
Utility



River Raid (Activision Inc,1984)
Arcade



River Rescue (Thorn Emi Video Ltd,1984)
Arcade



RMS Titanic (Electric Dreams Software,)
Arcade



Road Frog (Spectrum Games Ltd,1983)
Arcade

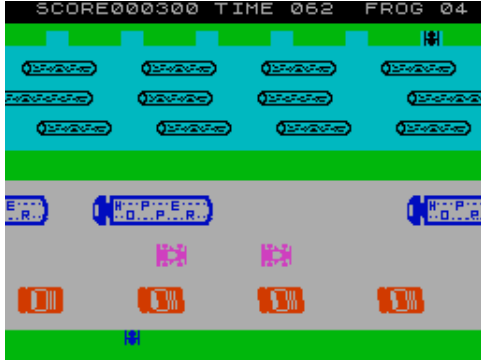

Road Race + Soccer (Meow Micros,1983)
Compilation



River Raider (Starzone Software,1984)
Arcade



Rjecnik (Xor Soft [2,])
Utility: Database

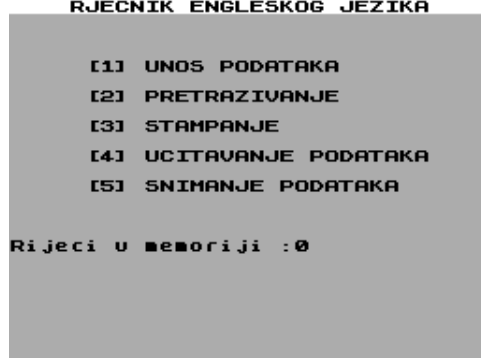

Road Blasters (US Gold Ltd,1988)
Arcade



Road Race (Meow Micros,1983)
Arcade



Road Racer (Fontana Publishing,1984)
Arcade



River Regatta (Fontana Publishing,1984)
Arcade

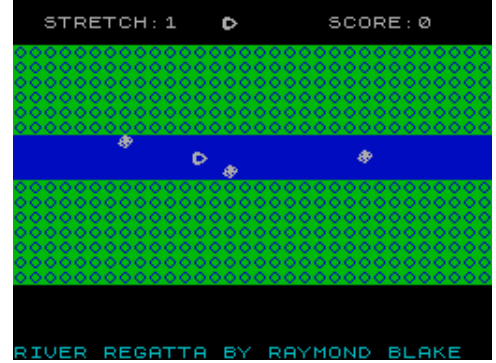

RJ's Ultimatum (The Adventure Workshop,1996)
Text Adventure

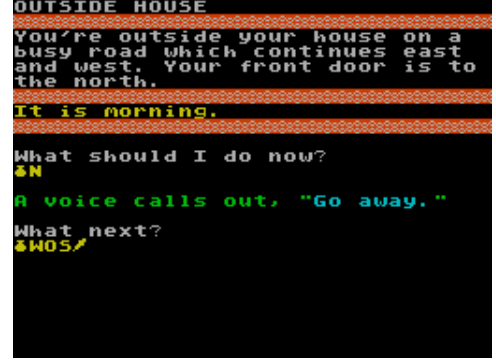

Road Fighter (Surdakar Group,1997)
Arcade

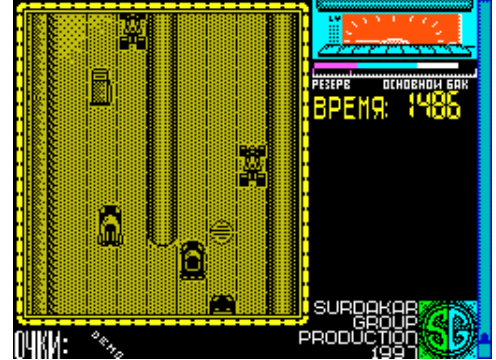

Road Race (Your Sinclair,1987)
Arcade



Road Racer (Hyperion Software,1983)
Arcade

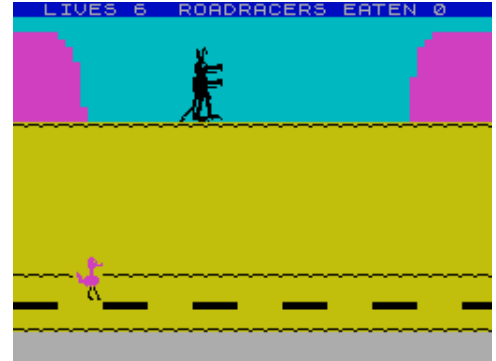

Road Racer (Micro Press [1],1983)
Arcade



Road Racers (Artic Computing Ltd,1983)
Arcade



Road Runner and Wile E. Coyote (Hi-Tec Software Ltd,1991)
Arcade

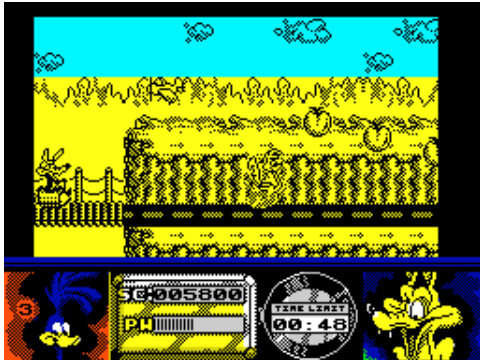

Roadstar XRi (Hewson Consultants Ltd.)
Arcade



Road Warrior (CRL Group PLC,1988)
Arcade



Road Racer (Thorn Emi Video Ltd,1983)
Arcade



Road Runner (Protek Computing Ltd,1983)
Arcade

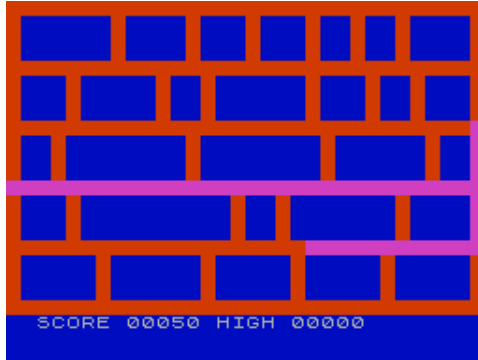

Road Safety Made Fun (Djh Software,1984)
Educational

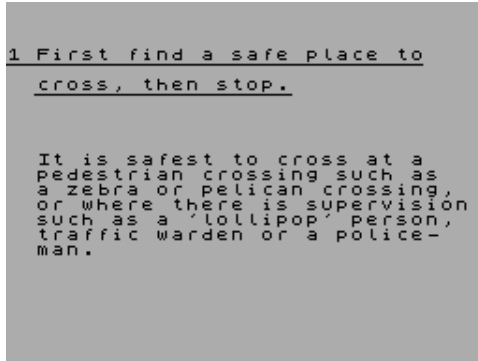

Road, The (.)
Arcade

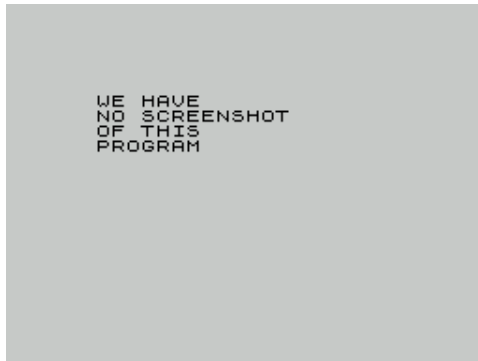

Roadwars (Melbourne House,1987)
Arcade

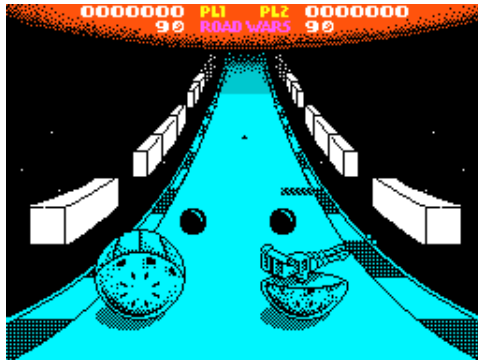

Road Racer (Your Spectrum,1984)
Arcade



Road Runner (US Gold Ltd,1985)
Arcade



Road Safety Made Fun (Turtle Software,1985)
Educational



Road Toad (Elfin Software Ltd,1983)
Arcade



Roaring Twenties, The (R'n'H Microtec,1985)
Simulation



Robber (Virgin Games Ltd,1983)
Arcade

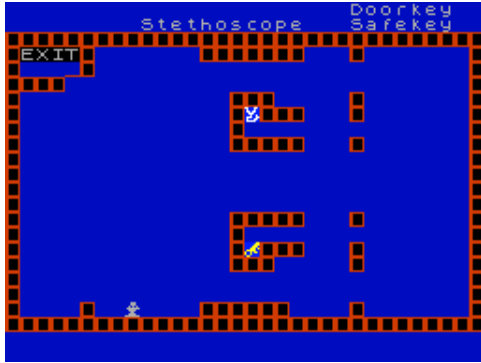

Robin Hood (T.S. Software,1984)
Text Adventure

You are in the Sherwood Forest. Around you there are a lot of huge trees. It is quiet dimly. You see a pile of trunks. Visible exits are: north.

What do you do ? WOSC

Robin of Sherwood (Adventure International,1985)
Text Adventure

You are standing on somebody's shoulders. You see:

Winded guard. Locked Grating.

Exits: DOWN

---WHAT NOW ? WAIT
You hear footsteps above you.
---WHAT NOW ? GET ANKLE
The guard falls over and is winded.
---WHAT NOW ? WOS

Robin the Outlaw (Gadtek Games,1986)
Arcade Adventure



RoboCop (Ocean Software Ltd,1989)
Arcade

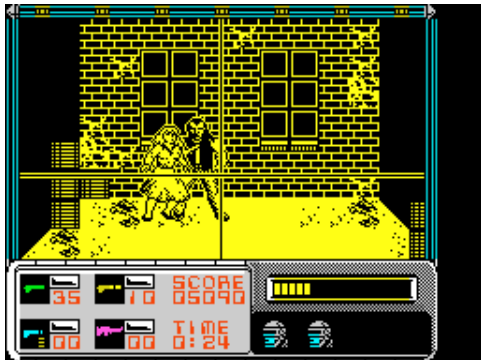

Robbo (Amilton,1997)
Arcade

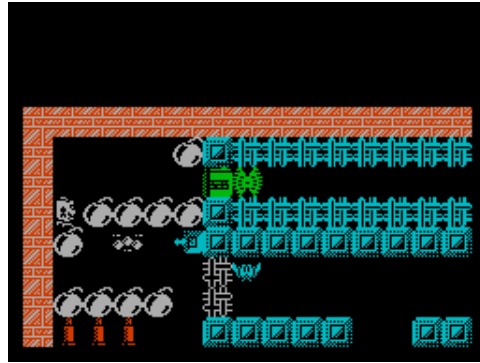

Robin Hood - Legend Quest (Code Masters Ltd,1993)
Arcade Adventure

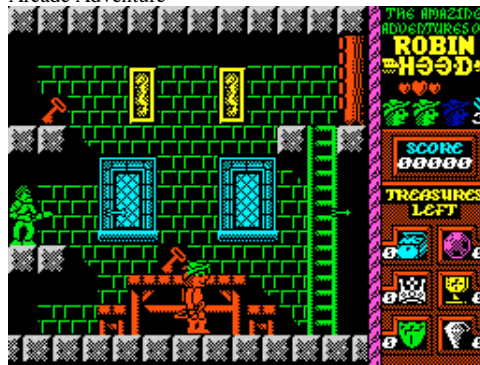

Robin of the Wood (Odin Computer Graphics Ltd,1985)
Arcade Adventure



Robo: The Komix Game (ETC Group,1997)
Arcade

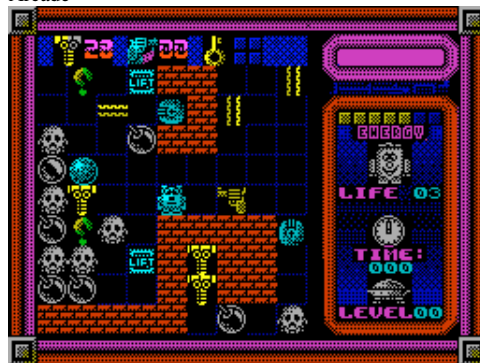

RoboCop 2 (Ocean Software Ltd,1990)
Arcade

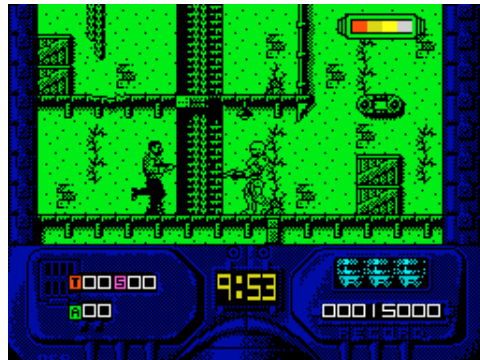

Robbo (Pro Soft,1996)
Arcade

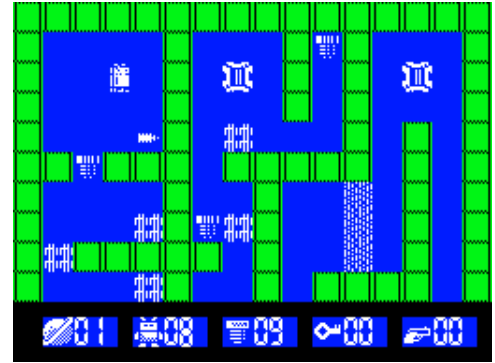

Robin of Sherlock (Silversoft Ltd,1985)
Text Adventure

Robin was in Sherwood Forest. This was, on the whole, to be expected and so came as no real surprise. Paths led south, east & west.

Robin Smith's International Cricket (Challenge Software,1990) Sport

ENGLAND			
NAME	BAT		BOUL
A GOOCH	OPENER	1	
B ATHERTON	OPENER	3	
C LARKINS	OPENER	2	
D GOVER	STROKE	3	HED 1
E LABB	STROKE	3	
F SMITH	STROKE	3	
G STEUART	STROKE	1	
H MORRIS	STROKE	1	U/K 3
J RUSSELL	STROKE	1	HED 3
K LEUIS	MIDDLE	1	U/K 3
L BICKNELL	MIDDLE	1	HED 3
L TUFNELL	TAIL	1	3
H SWALL	TAIL	1	FAST 3
H HENHINGS	TAIL	1	FAST 1
O FRASER	TAIL	1	FAST 1
P HALCOLM	TAIL	1	SPIN 2

0 NAME 1 DROP 2 DATA
PRESS A TO P TO SELECT - No 0

Robo-City (Spectrum Computing,1984)
Text Adventure

I am in a bed onboard ship. There are row upon row of bright lights on the ceiling above me.

I can also see:-

PILLOW
HAND MIRROR

RoboCop 3 (Ocean Software Ltd,1992)
Arcade

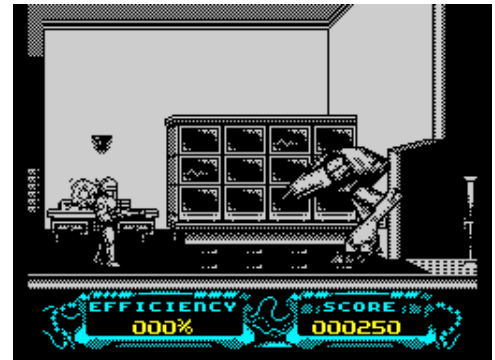

RoboCop 3 Demo (Softstar,1993)
Scene Demo



Robopon (Play Games Software,1984)
Arcade



Robot Attack (Mastertronic Ltd,1989)
Arcade

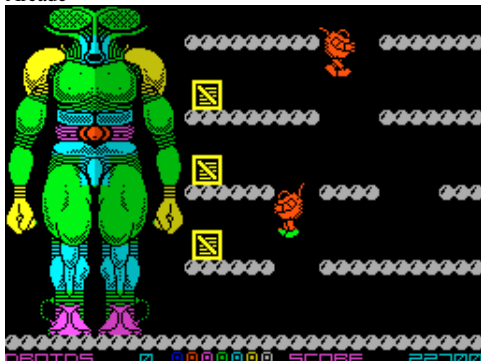

Robotic Capers (WB Software,1984)
Arcade

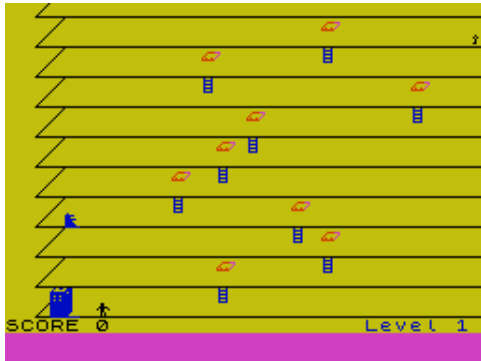

Robot Panic (Soft Mill Software,1983)
Arcade



Robomania (,1987)
Arcade

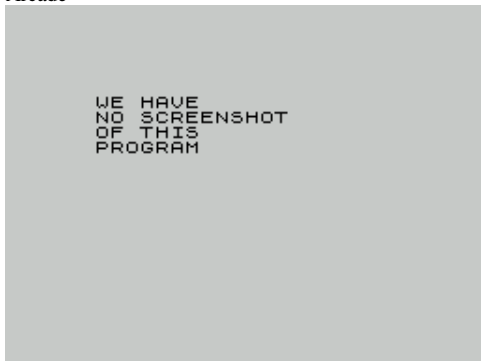

Roborun (C&VG,1982)
Arcade

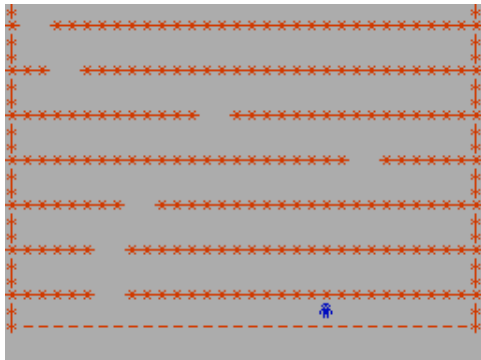

Robot Chase (Phipps Associates,1982)
Arcade

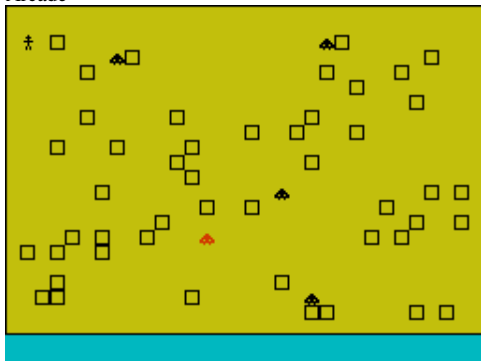

Robot Messiah (Alphatim,1985)
Arcade



Robot Riot (Siversoft Ltd,1983)
Arcade



Robon (Softek Software International Ltd,1983)
Arcade



Robot (Inferno Software,1996)
Arcade

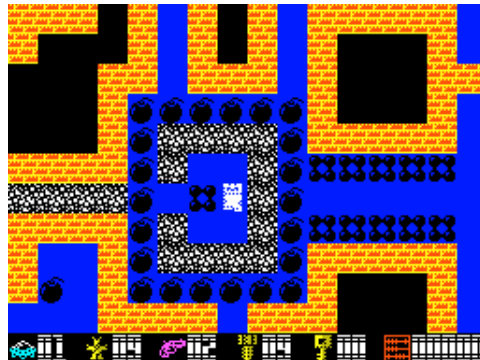

Robot Factory (Ventamatic,1984)
Arcade

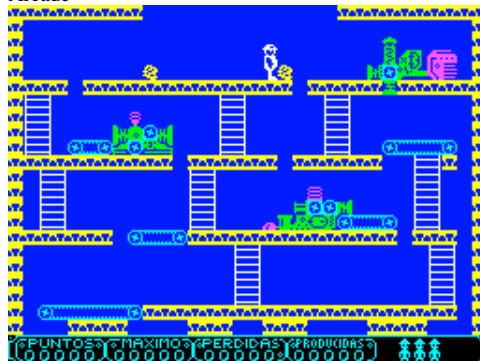

Roboto (Bug-Byte Software Ltd,1986)
Arcade



Robotron (Krypton Force,1985)
Arcade



Robotron: 2084 (Atarisoft,1984)

Arcade



Robot Scape (Sygran S.A.,1988)

Arcade

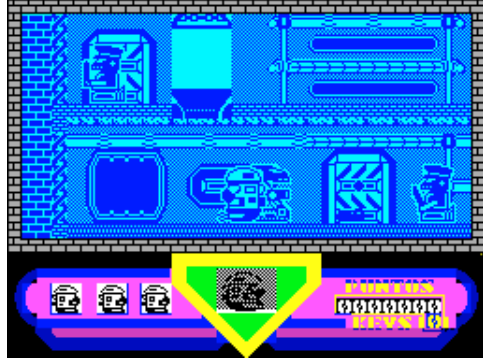

Robyn Hode (Runesoft,1986)

Text Adventure

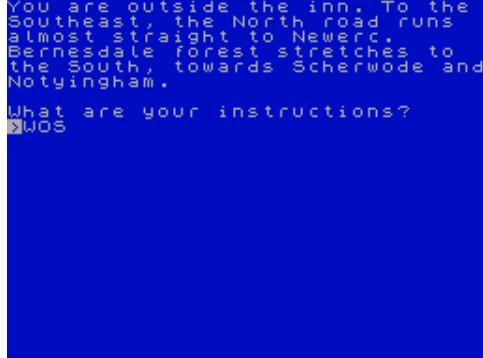

Rocket Command (Spectrum Games Ltd,1983)

Arcade



Rocket Raider (C-Tech,1983)

Arcade



Robot Rumpus (Atlantis Software Ltd,1985)

Arcade

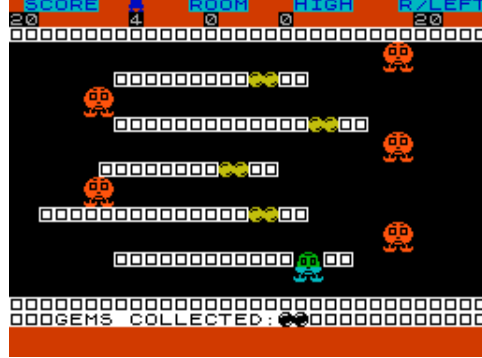

Robo Xonix (Chemist Soft,1994)

Arcade



Rochn, la Era de las Espadas (SKUAT Soft,1988)

Text Adventure



Rocketman (.)

Arcade



Rockfall (Crash,1990)

Arcade



Robot Runner (Longman Software,1984)

Educational

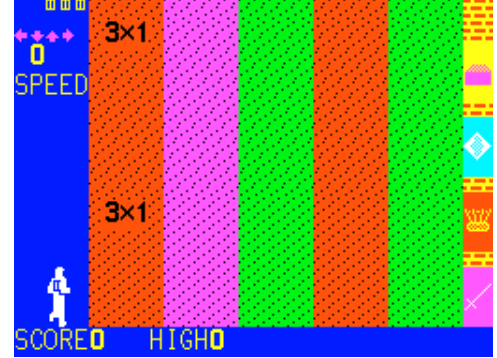

Robozone (Image Works,1991)

Arcade



Rock (Alien Software,1993)

Text Adventure



Rocket Man Mike (Your Computer,1985)

Arcade



Rockfall (Top Ten Software,1988)

Arcade

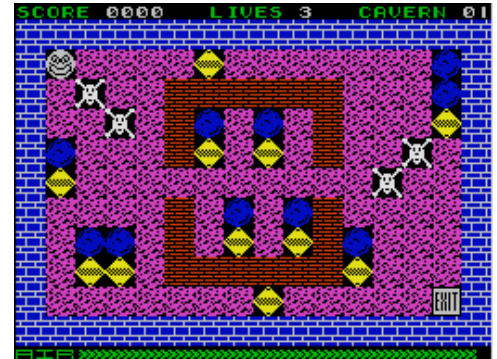

Rockfall Designer (Ian Collier,1985)
Arcade Game Development Tool



Rockford's Riot + Boulderdash (Monolith,1985)
Compilation

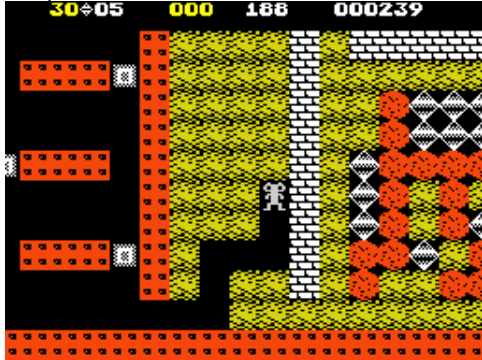

Rock'n Roll (Software Editores,1986)
Arcade



Rock'n Roll Tuner (Your Sinclair,1986)
Arcade Game Development Tool



Rock, The (Karl Crawford,1987)
Text Adventure



Rockfall II (Crash,1991)
Arcade

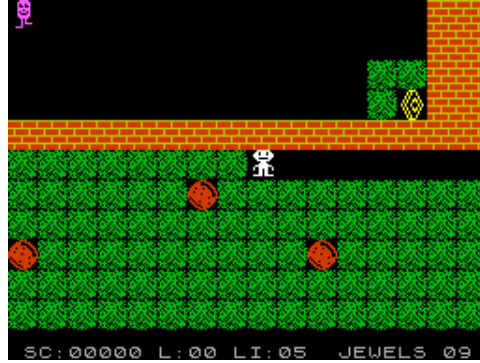

Rockman (Mastertronic Ltd,1985)
Arcade



Rock 'n' Roll (Your Sinclair,1986)
Arcade

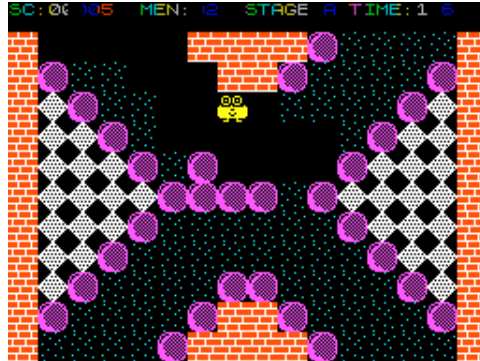

Rock 'n' Wrestle (Melbourne House,1985)
Sport

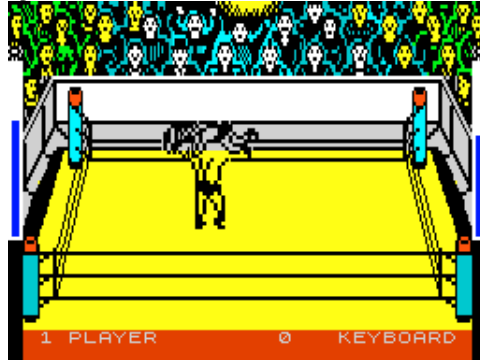

Rocky (Dinamic Software,1985)
Arcade

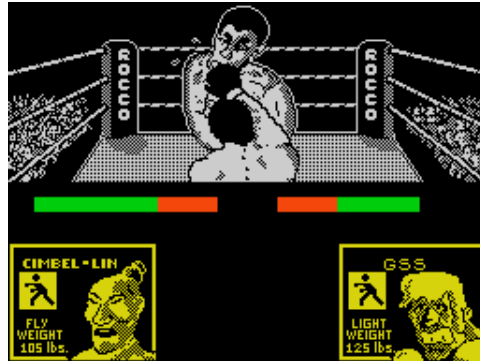

Rockford (Mastertronic Added Dimension,1987)
Arcade



Rock 'n Roll (Rainbow Arts,1989)
Arcade



Rock 'n Roller (Topo Soft,1989)
Arcade

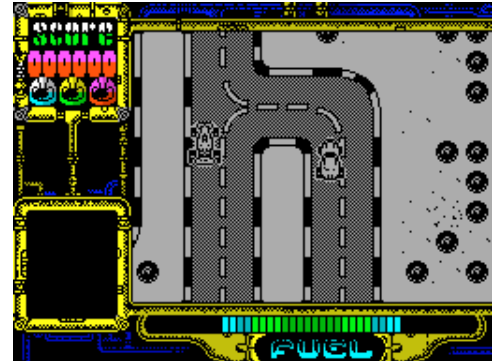

Rock Star Ate My Hamster (Code Masters Gold,1989)
Simulation



Rocky Horror Show, The (CRL Group PLC,1985)
Arcade Adventure



Rocman (Magic Team,1986)
Arcade Adventure



Rod Pike's Horror Compilation (CRL Group PLC,1988)
Compilation

```
i am sitting in the coach, on my way to castle dracula! the end of this day will see me to my destination! soon we are high in the mountains. the views are stunning! occasionally i see the castle, high up, watching through the clouds, watching? why should i feel that? castles don't watch! ...looking again i gain the impression that it is built in the style of a grand french chateau. tall towers and turrets... the coach rattles on with an urgency i find disarming... i'm ready for your instructions.
```

Rogue Trooper (Piranha,1986)
Arcade

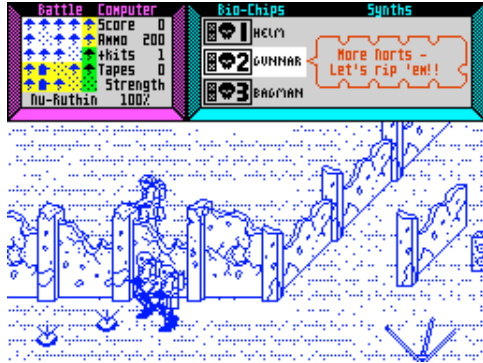

Rollaround (Mastertronic Ltd,1988)
Arcade

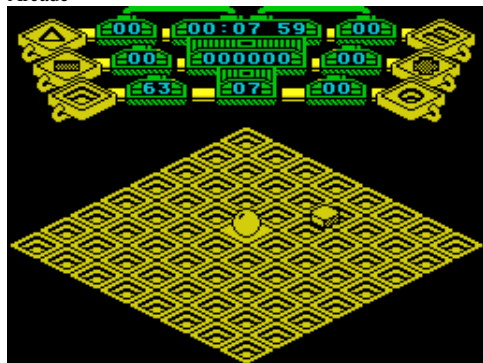

Rolmer en Manhattan (J. Baltasar,1989)
Text Adventure

```
WE HAVE NO SCREENSHOT OF THIS PROGRAM
```

Roco (Francisco Bretones Castillo,)
Text Adventure

```
WE HAVE NO SCREENSHOT OF THIS PROGRAM
```

Rogue (Mastertronic Ltd,1988)
Arcade Adventure



Roland Garros (MicroHobby,1985)
Arcade

```
WE HAVE NO SCREENSHOT OF THIS PROGRAM
```

Roller Coaster (Elite Systems Ltd,1985)
Arcade



Roly Poly Goes to Hospital (David Todd Software,1985)
Arcade

```
WE HAVE NO SCREENSHOT OF THIS PROGRAM
```

Rod-Land (Storm Software [2],1991)
Arcade

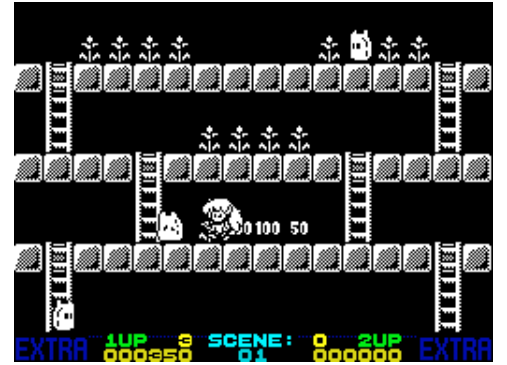

Rogue Comet (Walrus Computing,1986)
Text Adventure

```
YOU ARE AT THE COMMAND DESK, YOU SEE THREE BUTTONS. RED BLUE GREY  
What now ?  
WOS
```

Roland's Rat Race (Ocean Software Ltd,1985)
Arcade



Rolling Thunder (US Gold Ltd,1988)
Arcade Adventure



Roman Empire (MC Lothlorien Ltd,1982)
Strategy

No.	COUNTRY	%	F	E	H	E	S
1	Aegyptus	0643	4	0	0	0	0
2	Carthago	1100	0	0	0	0	0
3	Græcia	1000	0	0	0	0	0
4	Hispania	1000	0	0	0	0	0
5	Italia	1000	0	0	0	0	0
6	Numidia	1000	0	0	0	0	0

Romans, The (Calpac Educational Software,1983)
Educational



ROM Copy (.)
Utility

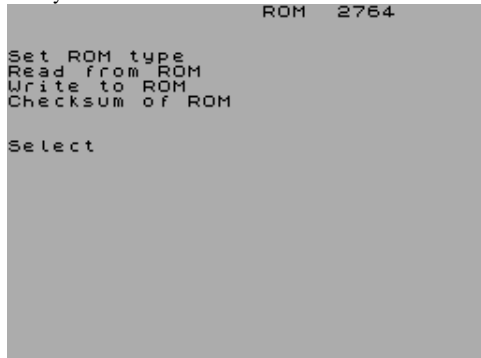

ROM i RAM (Radio Ventilator 202,1984)
Educational

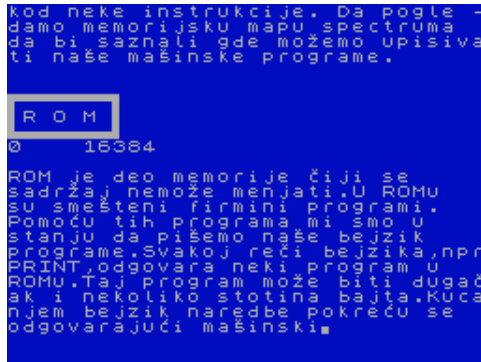

ROM Routinen (Klaus Jahn,1987)
Educational



Room Ten (CRL Group PLC,1986)
Sport

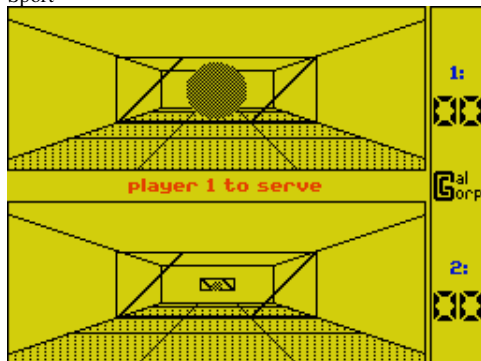

Romantic Robot Videoface (Romantic Robot UK Ltd,1987)
Utility

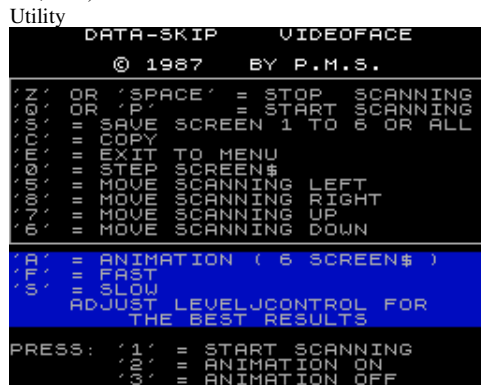

Rome 90 (Qualsoft,1990)
Sport



Rommel's Revenge (Crystal Computing,1983)
Arcade

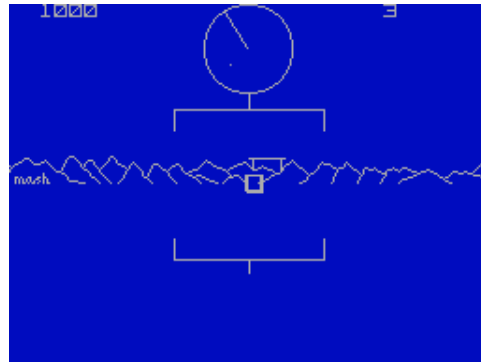

Ronnie Goes to Hollywood (8th Day Software,1987)
Text Adventure



Rosas (MicroHobby,1985)
Utility



Rombo Vidi-ZX (Rombo Productions,1988)
Utility

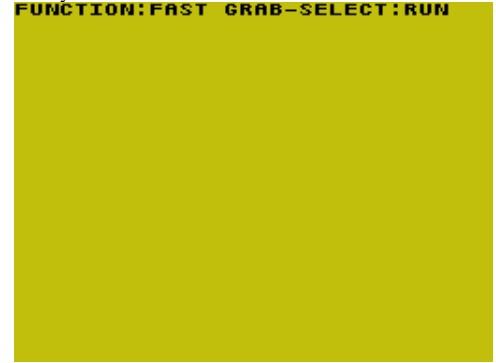

Romeo and Juliet (Avonsoft,1988)
Text Adventure



Romper Room's I Love My Alphabet (Beyond Software,1986)
Educational



Rookie (Mastertronic Ltd,1989)
Arcade



Rotation (.)
Utility: Screen Manipulation

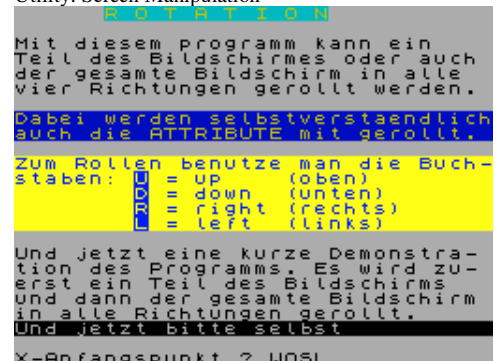

Rotation (Jacek Michalak,1991)
Scene Demo



Rotulos (MicroHobby,1985)
Utility: Font/UDGs

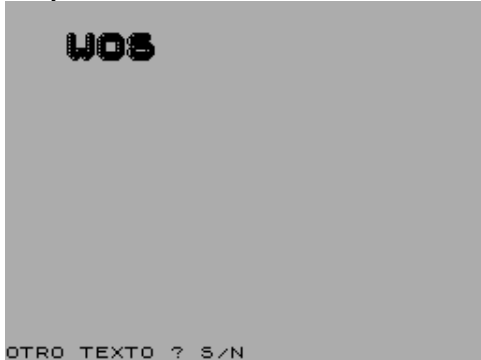

Rough Justice (Cronosoft,2003)
Arcade



Roulette (JRS Software Ltd,1983)
Board/Card Game



Roulette (Newsoft Products,1982)
Board/Card Game



Rothmans Football Quick Quiz (Cassell Ltd,1985)
Board/Card Game

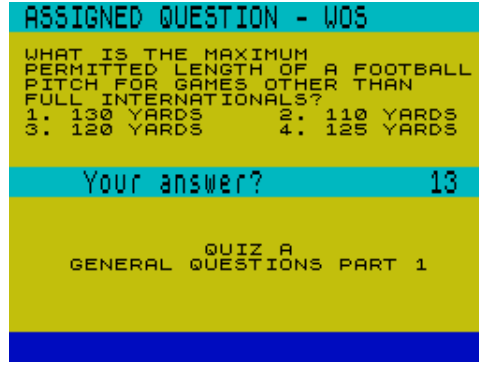

Rotulos Printer (Microparadise Software,1984)
Utility



Roulette (Baumsoft,1984)
Board/Card Game



Roulette (Megasoft [3],1985)
Board/Card Game

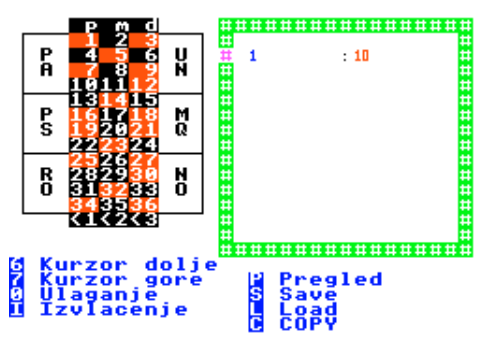

Roulette (Shiva Publishing Ltd,1983)
Board/Card Game



Rotozlow (Icabod,2006)
Scene Demo



Rouge Midget (The Guild,1991)
Text Adventure

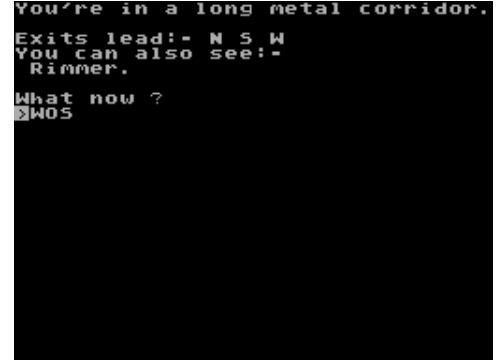

Roulette (Dymond Software,1982)
Board/Card Game



Roulette (Micromega,1984)
Board/Card Game



Roulette (Stefan Freise,1982)
Board/Card Game



Roundheads & Cavaliers (Argus Press Software Ltd,1987)

Strategy

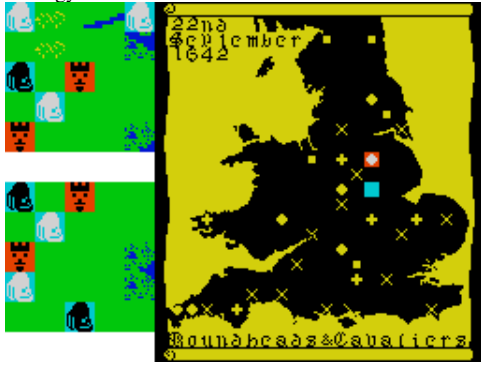

Round the Houses (Spectrum Computing,1983)

Utility



Royal Adventures of a Common Frog (Automata UK Ltd,1985)Text Adventure

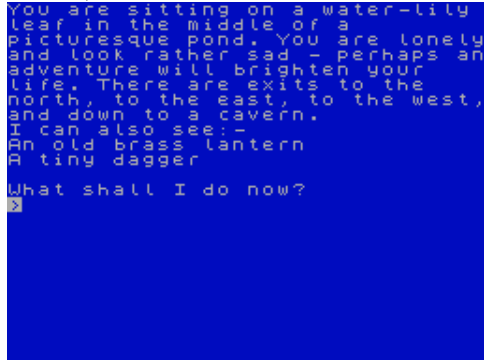

Royal Life (Fuxoft,1987)

Simulation



Roy of the Rovers (Gremlin Graphics Software Ltd,1988)

Arcade Adventure



Roundsby Incident, The (Kayde Software Ltd,1983)

Text Adventure



Rox III (Llamasoft,1982)

Arcade

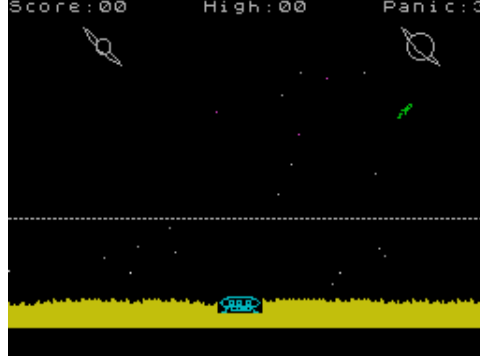

Royal Birkdale (Hornby Software,1983)

Sport

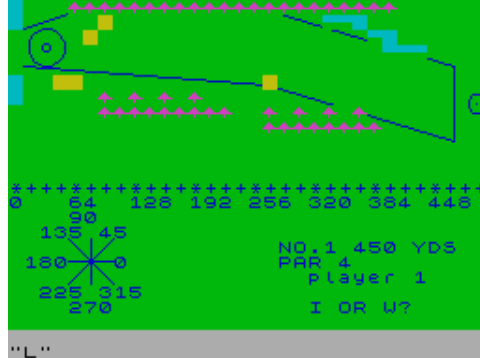

Royal Scot (Dee-Kay Systems,1984)

Simulation

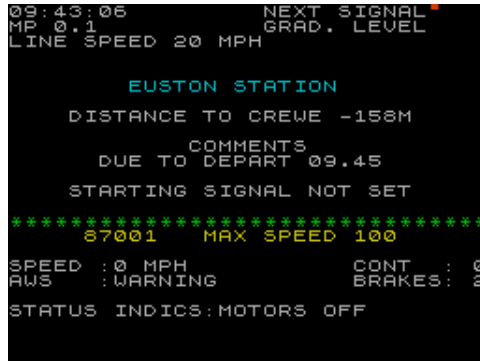

Roy Stead's Hacker's Guide (16/48 Tape Magazine,1986)

Utility

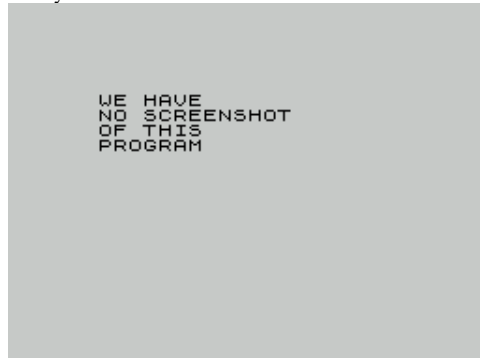

Round the Bend! (Zeppelin Games Ltd,1991)

Arcade Adventure

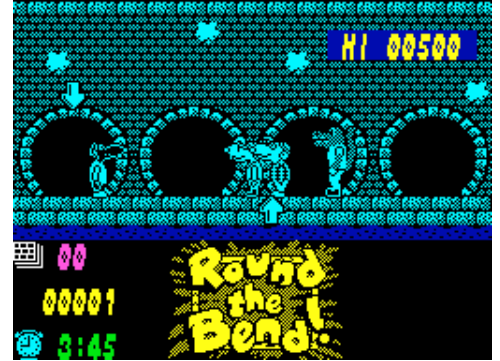

Rox III + Bomber (Investronica S.A.)

Compilation



Royal Birkdale: Championship Golf (Ocean Software Ltd,1983) Sport



Roy Benson Show, The (Technium 220,1996)

Scene Demo



RS 232C Interface (Jury Nikolskiy,1987)

Utility

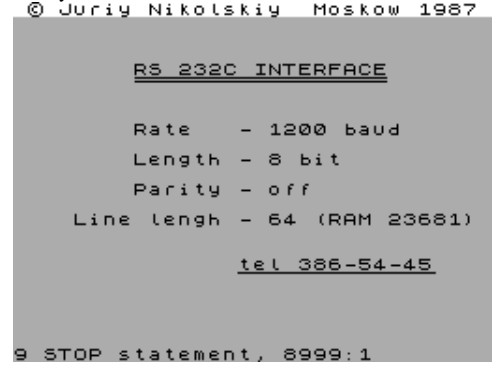

RTC Birmingham (Dee-Kay Systems,)

```
Simulation
W BIRMINGHAM NS CONTROL 1009 E
EAST END ARRIVALS
AS 2657 Wal-Brm Held apprch sigs
CU 2645 Cov-Brm Held apprch sigs
DY 1013 Bdf-Wey Held apprch sigs
WEST END ARRIVALS
WU 1U71 Liv-Pgn Held apprch sigs
GL 2636 CCS-Bst Checked on aprch
2691 Stb d1015
1E72 Brm-Yar Due depart 1020
1U68 Brm-Cdf Ready to depart
2G11 CCS-Lgb Ready to depart
accept
```

RTC Doncaster (Ashley Greenup,1989)

```
Simulation
S DONCASTER CONTROL 0933 N
NORTH END ARRIVALS
UM
LD
HU
SOUTH END ARRIVALS
DF*1L02 Kgx-Lds App.Bridge Junc.
DS
SH 2C14 Shf-HUL Due 0943 on time
2C15 Shf d0938
1A10 Yrk-Kgx DT Due depart 0934
2K11 Ste d1026
accept
```

RTC Kings Cross (Dee-Kay Systems,1986)

```
Simulation
KINGSX CONTROL 0647 SIGNALLING
ARRIVALS DEPARTURES
UP FAST 05014 0648 P10
Aberdeen Slpr 0718
Due Kings X 0657 0740
(ECS Ferme park) 0745
RUNNING ON TIME
UP SLOW 054007
stock 0740
EXPECTED 0700
HOLD
UF
DF
US
DS
WB,LY
```

RTC Paddington (Dee-Kay Systems,1986)

```
Simulation
UP ARRIVALS 0737 DEPARTURES
UP MAIN 253036 0725 P4
0553 dep exCard 0745
(stock 0900 dep) 0800
EXPECTED 0800 0835
UP CARR 253010 SN
(stock 0745 dep) P9
D2 P8
UR HE P8
DR P7
UM P6
DM P5
UC P4
HW PARCELS P3
SUBURBAN DMU P0
PASSING OLD OAK P1
```

RTC Rugby (Dee-Kay Systems,1988)

```
Simulation
RUGBY POWERBOX 1207
1330 Stf
Station Area
ARRIVALS
US=
UF=1A33* 1203 Man-Eus HELD
UB=
DN=
DH=1H09 1205 Eus-Man HELD
```

RTC Buxton (Dee-Kay Systems,1987)

```
Simulation
BUXTON RAILFREIGHT CONTROL 0320
PHINLEY JUNCTIONS
Next arr 47337
6M66 Margam-TS DOUB HOLES
Expected 0330 Due dep. 0510
7H55 arr.
PEAK FOREST
Banker 40022
Awaiting Despatch
TUNSTEAD SDGS
7J18 Dean Lane
Due dep. 0400
BUXTON HS
Avail Exam/Rep 6F90 Widnes
45062 40079 Due dep. 0410
05084 40196
04143
05323
05199
BRIDGE SIDINGS
Loco no. "L"
```

RTC Exeter (Ashley Greenup,1990)

```
Simulation
W EXETER ST DAVIDS 0900 E
EAST END ARRIVALS
Waterloo stock being serviced
WEST END ARRIVALS
UM 1M37 Pgn-Man Due 0915 on time
DU
1E23 Plm-New Due depart 0902
41C11 Swd-Pnz Due depart 0901
2F07 Ext-Exm Due depart 0926
2B58 Bsp d0906
```

RTC Leeds (Ashley Greenup,1989)

```
Simulation
WEST LEEDS 1001 EAST
YK 1M58 New-Liv Due 1012 2 late
HG
SK
BD 2T14 Bdf-Lds Due 1010 5 late
HD 1E52 Mcr-Hul Due 1015 on time
DN 1D33 Kgx-Lds Due 1007 3 late
NM
2U10 Ilk d1011
2H13 Skp d1003
1A15 Lds-Kgx Due depart 1010
1M43 Lds-Car Due depart 1045
2J05 Msd d1022
2F07 Knt d1007
2M12 Scb-Lvp Ready to depart
ACCEPT
```

RTC Penzance (Dee-Kay Systems,1986)

```
Simulation
PENZANCE CONTROL SUMMER SATURDAY
DEPARTURES NEXT ARRIVAL Due 0527
0650 Plum 47451 +1915 dep exyork
0800 Padd-H Becomes stock 0648 dep
0840 New-e HELD AT LONGROCK SIG
PONSANDANE YARD LONGROCK DEPOT
shunter required 253036 (a)
MARSHALLED SETS 253006 (a)
stock 0740 dep 253032 (e)
stock 0853 dep
PL: clear SW:
EL:
STATION AREA
B2 50022
B1 45149
06644 BE 47557
50013+0505 dep tr.
```

RTL Demo Volume 1 (Anthraxx Developments,1990)



RTC Crewe (Ashley Greenup,1990)

```
Simulation
S CREWE STATION CONTROL 0930 N
NORTH END ARRIVALS
UF
US
CH
MN
SOUTH END ARRIVALS
DF 1547 Eus-Inv Due 0938 on time
DS*3540 PCL-Str Due 0940 on time
SW
ST 1D33 Stk-Hol Due 0944 on time
PARCEL VANS 1D27 Hol d1115
1U49 Liv-Ptn Due depart 0931
2P82 Dby d0937 223 PARCEL VANS
2H23 Crw-Alt Due depart 0944
accept
```

RTC Kings Cross (Ashley Greenup,1990)

```
Simulation
KINGS CROSS STATION CONTROL 1005
ARRIVALS
UF 1A09 New-Kgx Checked on aprch
US 2R55 Roy-Kgx Due 1010 2 late
1528 Kgx-Edb Due depart 1300
1536 Kgx-Abd Due depart 1030
1521 Kgx-Edb Due depart 1100
1500 Kgx-Edb Ready to depart
1D49 Kgx-Lds Due depart 1010
2P16 Pet d1040
1L02 Cam d1011 1P44 Hun d1015
ACCEPT
```

RTC Lime Street (Dee-Kay Systems,)

```
Simulation
ARRIVALS 0634 DEPARTURES
DOWN F 86246 0633 P6
ECS-Edge Hill 0650 P3
(stock 0710 dep) 0703
HELD ON APPROCH 0705 P8
DOWN S 45134 P9
ECS-Edge Hill
(stock 0703 dep) P8
EXPECTED 0641 P7
DF P6
UF P5
NK P4
DS P3
US HD P2
SA SB SD SE P1
```

RTC Reading (Dee-Kay Systems,)

```
Simulation
W READING STATION CONTROL 0932 E
EAST END ARRIVALS
DM 1C23 Pad-Ust App.New Junction
DR 1M09 Pad-Liv Due 0947 on time
EL
WEST END ARRIVALS
UM
UR
WL 2B11 Nby-Rdg Due 0940 on time
2A29 Pad d0954
TL
2B10 Bdw Ready 1064 Gat d0940
accept
```

RTL Demo Volume 2 (Anthraxx Developments,1990)

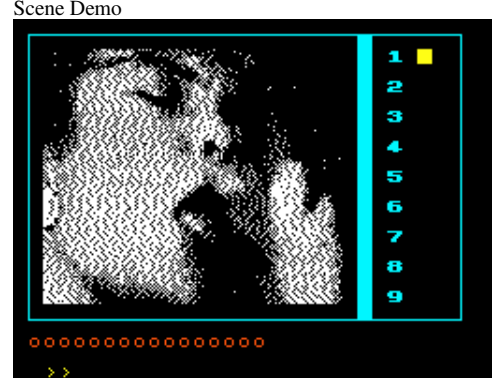

RTL Demo Volume 3 (Anthraxx Developments,1990)
Scene Demo

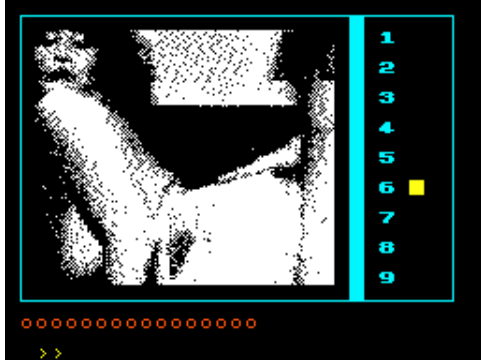

R-Type (Electric Dreams Software,1988)
Arcade

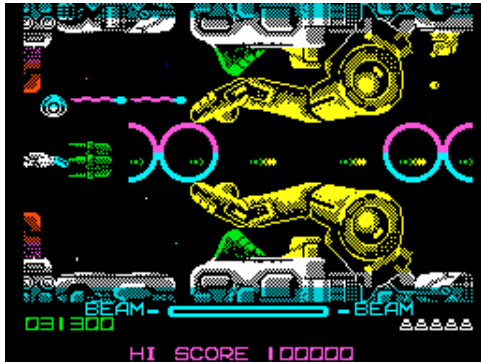

Rubik Solver (Gemini Marketing Ltd,1982)
Board/Card Game



Rude Pictures Demo 1 (Tinbin Garbage Production Ltd,1990)
Scene Demo

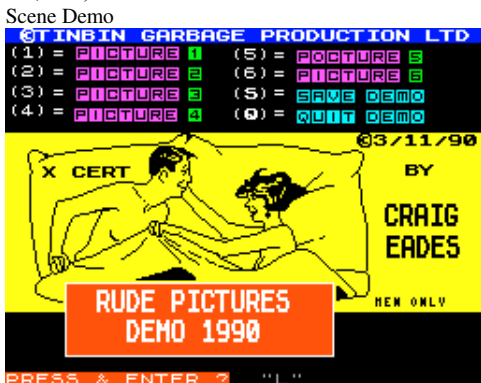

Ruedas (Valente Computacion,)
Arcade



RTL Demo Volume 4 (Anthraxx Developments,1990)
Scene Demo



Rubicon (Bug-Byte Software Ltd,1987)
Arcade

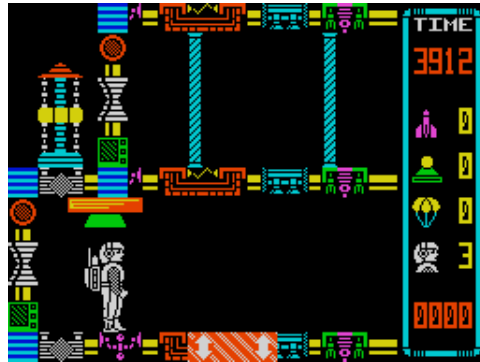

Rubix Revenge (.)
Arcade

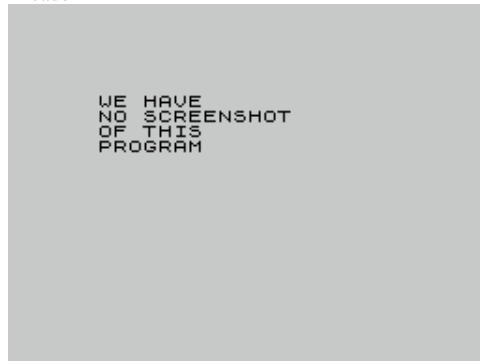

Rude Pictures Demo 2 (Tinbin Garbage Production Ltd,1991)
Scene Demo

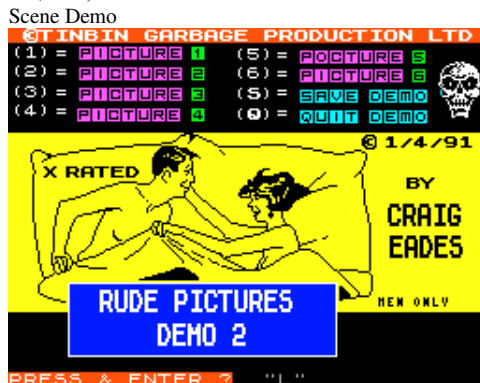

Ruff and Reddy in the Space Adventure (Hi-Tec Software Ltd,1990) Arcade



RTTY (Pearsons Computing,1984)
Utility



Rubik (MicroHobby,1985)
Board/Card Game

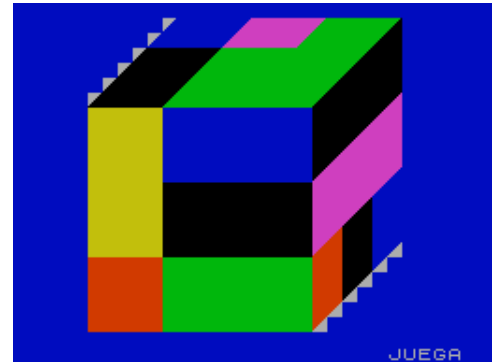

Ruby Runabout (Scorpio Software,1984)
Text Adventure

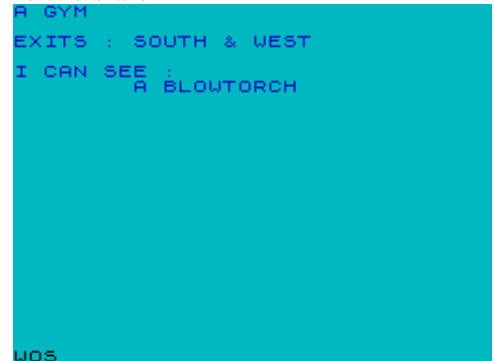

Rude Pictures Demo 3 (Tinbin Garbage Production Ltd,1991)
Scene Demo

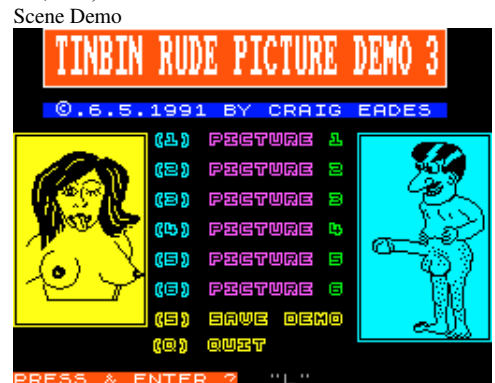

Ruffo's Dream (MicroHobby,1987)
Arcade

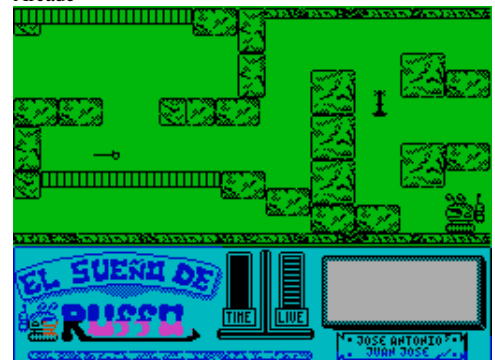

Rugby Boss (Alternative Software Ltd,1989)
Simulation



Rugby Manager (Artic Computing Ltd,1986)
Sport



Rugrats (Technium 220,1996)
Scene Demo



Ruleta (QLS,1986)
Board/Card Game



Runaway Robot (Games Computing,1984)
Arcade

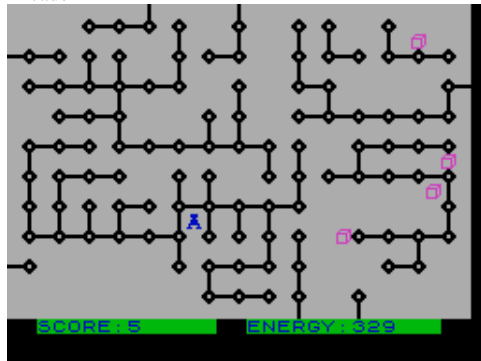

Rugby Coach (Cult Games,1991)
Simulation



Rugby Manager (Mastertronic Plus,1989)
Sport



Ruleta (Ediciones y Textos S.A.,1985)
Board/Card Game



Rulett (NyitraiSOFT,2005)
Board/Card Game

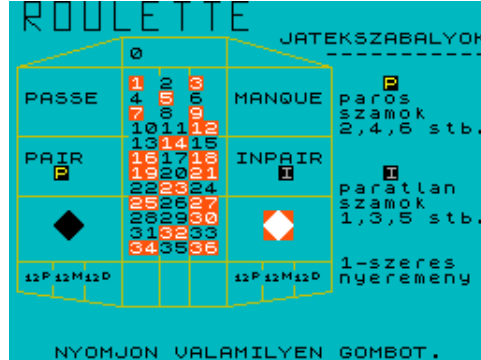

Run Baby Run (Firebird Software Ltd,1983)
Arcade



Rugby Fifteen (Tanglewood Software,1988)
Simulation

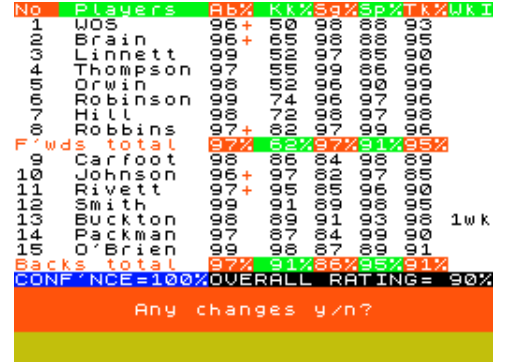

Rugby Manager + Automania (Tynesoft,1985)
Compilation



Ruleta (MicroHobby,1985)
Board/Card Game



Rumble (.)
Arcade



Run Bill Run (Computer Emuzone,2005)
Arcade

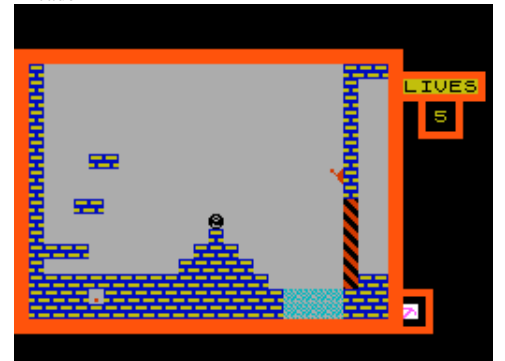

Run, Bronwynn, Run! (FSF Adventures,1992)

Text Adventure

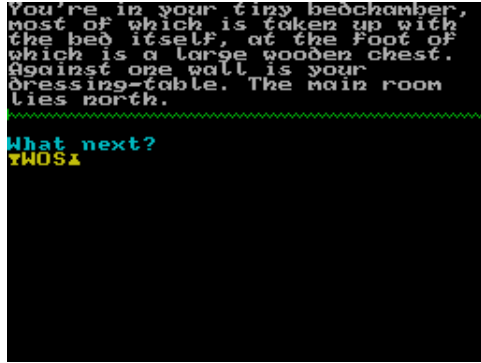

Runestone of Zaobab + Escape from Magic, The (,) Compilation

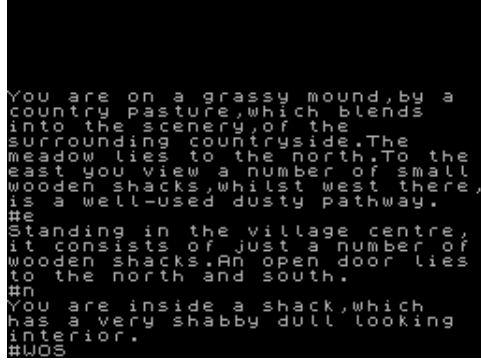

Runge Kutta (MicroHobby,1985) Utility



Run issue 03 (Ediciones Ingelek S.A.) Covertape



Run issue 06 (Ediciones Ingelek S.A.) Covertape



Runes of Zendo, The (Dorcas Software,1984)

Text Adventure



Runestone of Zaobab, The (Eric Stewart,1988) Text Adventure

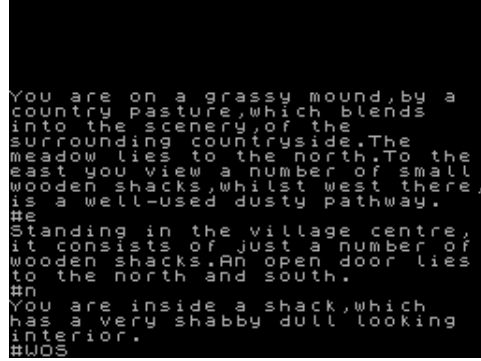

Run issue 01 (Ediciones Ingelek S.A.) Covertape



Run issue 04 (Ediciones Ingelek S.A.) Covertape



Run issue 07 (Ediciones Ingelek S.A.) Covertape



Runestone (Games Workshop,1986)

Text Adventure



Run for Gold (Hill MacGibbon,1985) Sport

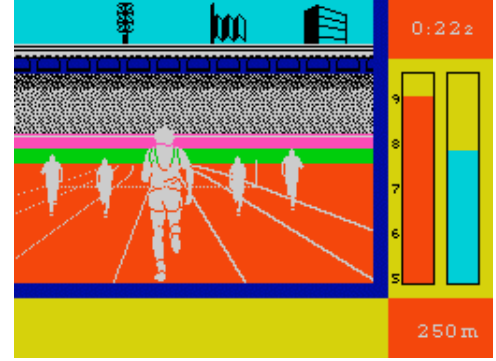

Run issue 02 (Ediciones Ingelek S.A.) Covertape



Run issue 05 (Ediciones Ingelek S.A.) Covertape



Run issue 08 (Ediciones Ingelek S.A.) Covertape



Run issue 09 (Ediciones Ingelek S.A.)
Covertape



Run issue 10 (Ediciones Ingelek S.A.)
Covertape



Run issue 11 (Ediciones Ingelek S.A.)
Covertape



Run issue 12 (Ediciones Ingelek S.A.)
Covertape



Run issue 13 (Ediciones Ingelek S.A.)
Covertape



Runner (Sinclair User,1983)
Arcade

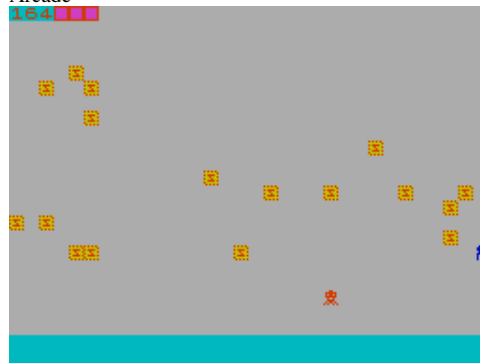

Running Man, The (Grandslam Entertainments Ltd,1989)
Arcade

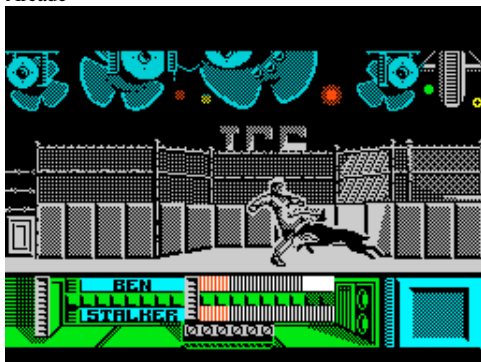

Running Stick Man, The (XFAWORLD Software,2003)
Arcade



Run OPUS (.)
Utility



Run, Rabbit, Run (Hill MacGibbon,1983)
Educational



Run Rabbit Run (Video Productions,1983)
Arcade



RUN SCREEN\$ Creator (Benkosoft.)
Utility: Screen Manipulation

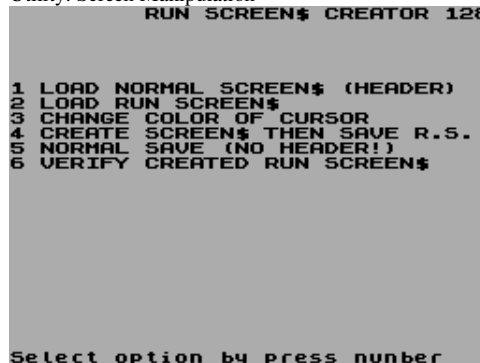

Run the Gauntlet (Ocean Software Ltd,1989)
Arcade



Run Your Own League (Silicon Joy,1984)
Utility

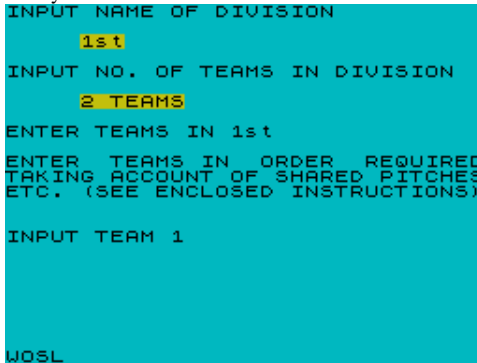

Rupert and the Ice Castle (Bug-Byte Software Ltd,1986)
Arcade



Rupert and the Toymaker's Party (Quicksilver Ltd,1985)
Arcade



Russian Time Teaser (World Eyes Group,1995)
Board/Card Game

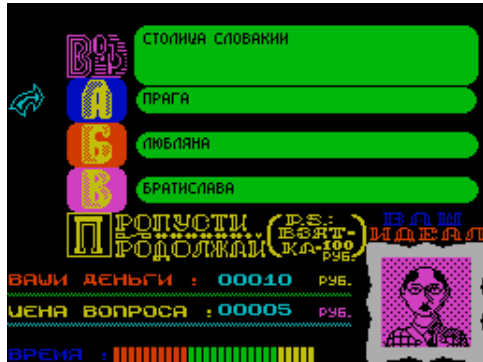

Rutinas Graficas (MicroHobby,1986)
Educational



Rygar (US Gold Ltd,1987)
Arcade

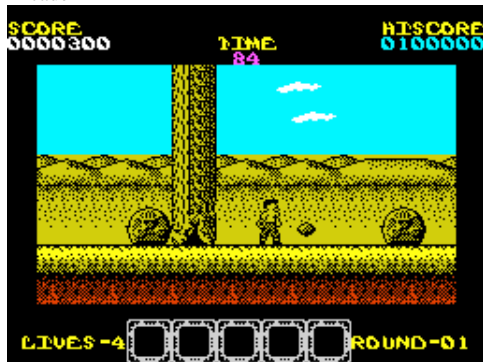

Sabbie di Marte (.)
Arcade



Russian's Attack (MicroHobby,1988)
Strategy



Russian Prestige (Black Shark,1996)
Scene Demo



RX-4 (Technical Software,1985)
Utility

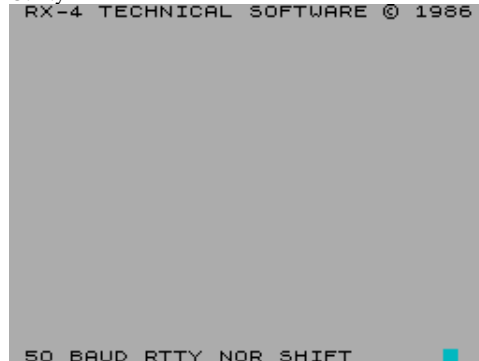

Rygar - Legendary Warrior (YOX,1987)
Arcade



Sabo (???) (.)
Arcade



Russian Tetris (THD,1993)
Arcade

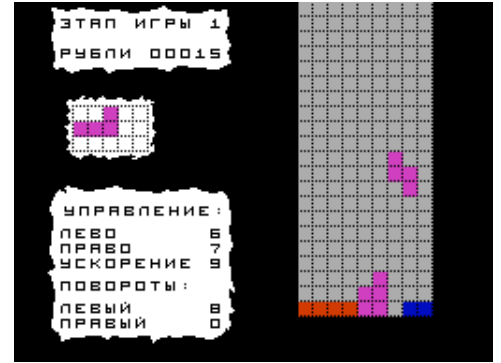

Russisch Übungen (W.E. Hintze,1984)
Educational



Rychle Sipy (MAJA Software/CID Software,1990)
Arcade



Sabat of Milton Gordon, The (The Adventure Club,1990)
Text Adventure



Sabotage (Eric Lawo,1983)
Arcade

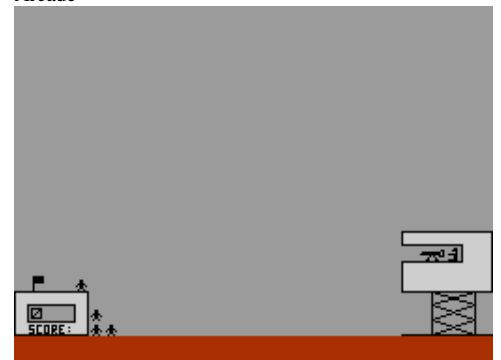

Sabotage (Quicksilva Ltd,1985)
Arcade



Sabotaje (P.J. Software,1988)
Arcade



Sabre (Dream Software Ltd,1984)
Arcade



Sabrina Demo (The Lords,.)
Scene Demo



Sach-Mat (Ultrasoft,1992)
Board/Card Game

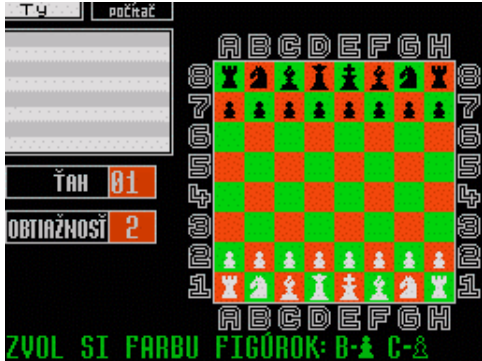

Sabotage (Robert Spahl,1983)
Arcade

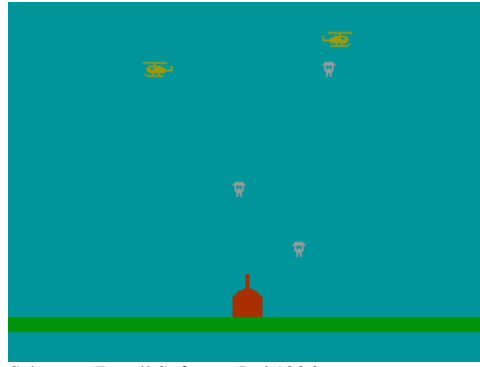

Saboteur (Durell Software Ltd,1986)
Arcade

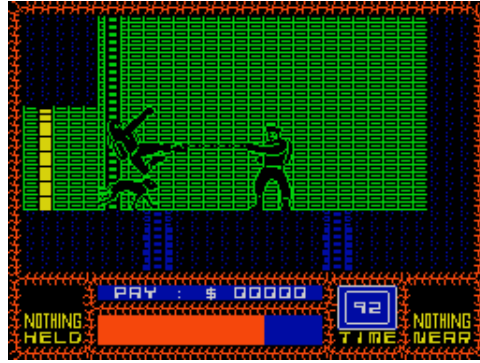

Sabre Wulf (Ultimate Play The Game,1984)
Arcade



Sabrina Demo 1 (Bromba,1989)
Scene Demo



Sacred Armour of Antiraid, The (Palace Software,1986)
Arcade



Sabotage (Zeppelin Games Ltd,1988)
Arcade

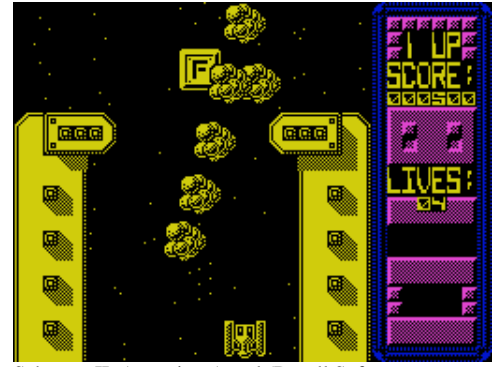

Saboteur II: Avenging Angel (Durell Software Ltd,1987)
Arcade

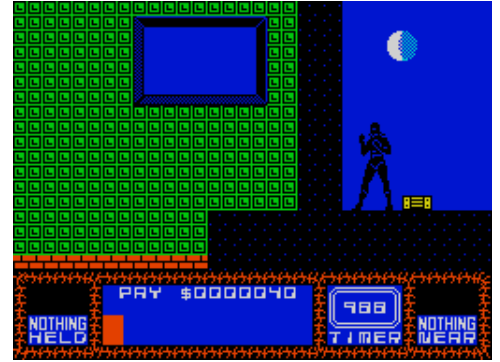

Sabrina (Iber Software,1989)
Arcade Adventure



Sabrina Demo 2 (Bromba,1989)
Scene Demo



Saga Commando Lexikon (D&K Softwaredevelopments,1984)
Utility: Screen Manipulation

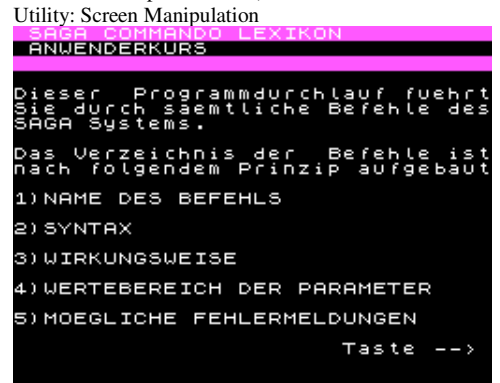

Saga of a Mad Barbarian (Psychaedelic Hedgehog Software,1991) Text Adventure



Saga Sprites Table (D&K Softwaredevelopments,1984) Utility: Screen Manipulation



Saigon Combat Unit (Players Premier Software,1989) Arcade



Saimazoom (Dinamic Software,1984) Arcade



Salamander (Konami Ltd,1987) Arcade



Saga of Erik the Viking, The (Mosaic Publishing Ltd,1984) Text Adventure



Sagenhafte Schatz des Minotaurus (RGH Software,) Simulation

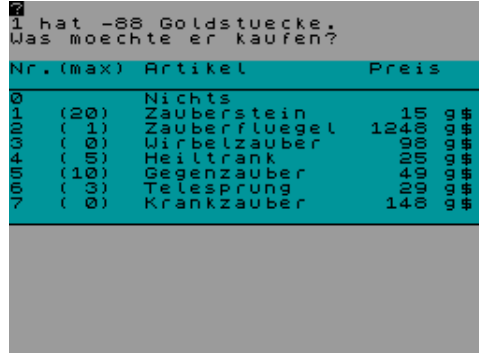

Sailing (Activision Inc,1987) Sport

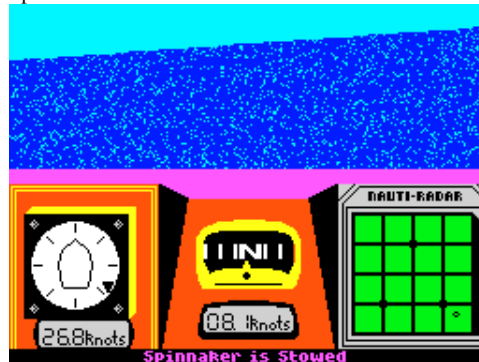

Saint and Greavsie (Grandslam Entertainments Ltd,1989) Board/Card Game



Sales Day Book (Transform Ltd,1985) Utility: Database

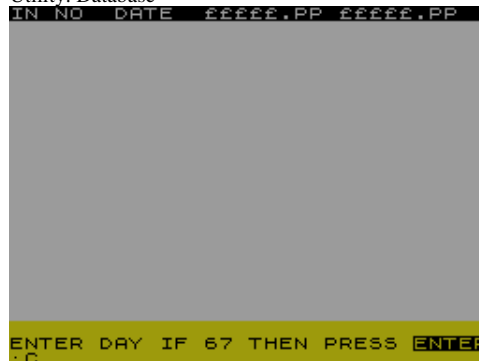

Saga Sprite Editor (D&K Softwaredevelopments,1984) Utility: Screen Manipulation



Sai Combat (Mirrorsoft Ltd,1986) Sport



Sail Racing (J. Cain,1985) Sport



Saint Reeta Connection (Alien Software,1994) Text Adventure



Sales Journal (Ramtop Software,1983) Utility

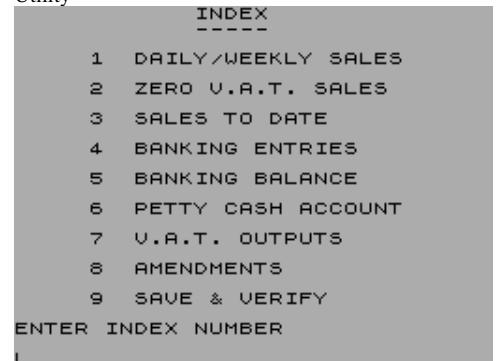

Sales Ledger (Anik Microsystems,1984)
Utility

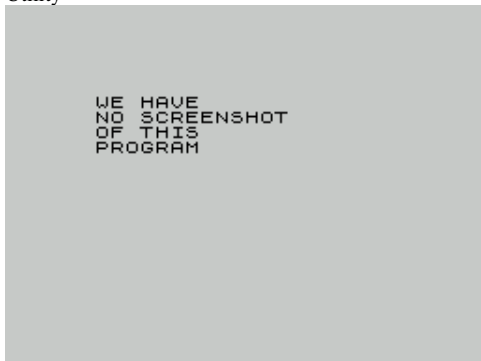

Sales Ledger (Hestacrest Business Software,1984)
Utility



Sales Ledger (Kemp Ltd,1983)
Utility



Sales/Purchase Ledger/Invoicing (Transform Ltd,1985)
Utility



Sales/Purchases Spectrum (Hestacrest Business Software,1983) Utility



Saltamovil (Micromania [2],)
Arcade

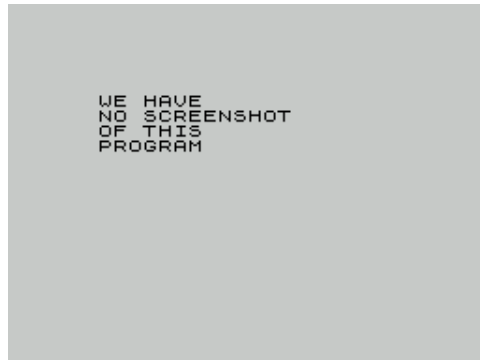

Saltarin (MicroHobby,1985)
Arcade

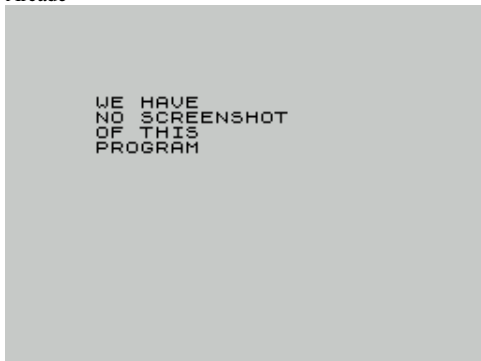

Salte La Blanca (Millansoft,1992)
Board/Card Game

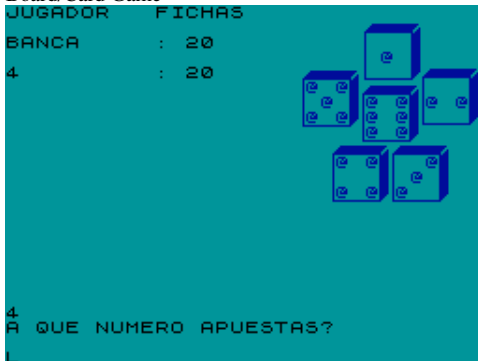

Salto de Caballo (MicroHobby,1985)
Board/Card Game



Salto de Dama (MicroHobby,1984)
Board/Card Game



Saltux (MicroHobby,1985)
Arcade



Salvage (Custom Software,1983)
Arcade



Salvage (Live-Wire Software,)
Text Adventure



Salvame! (MicroHobby,1986)
Arcade

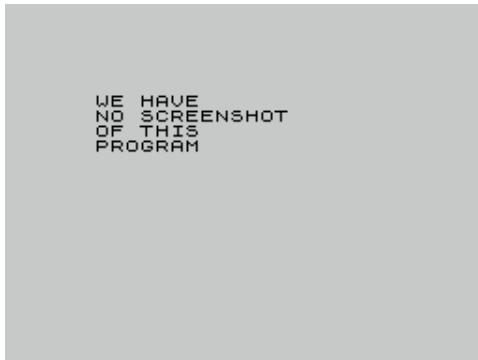

Samantha Fox 2 (.)
Scene Demo



Samantha Fox Ecrans (JF Soft,) Scene Demo



Samouczek Spectrum (Beyond Horizons,1985) Educational

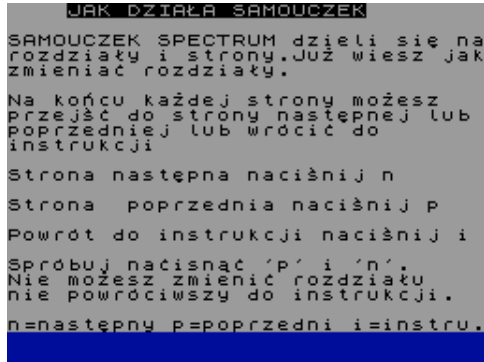

Sample Editor (Quasar Software,1987) Utility



Sample Tracker (CBM,1992) Utility: Sound Manipulation

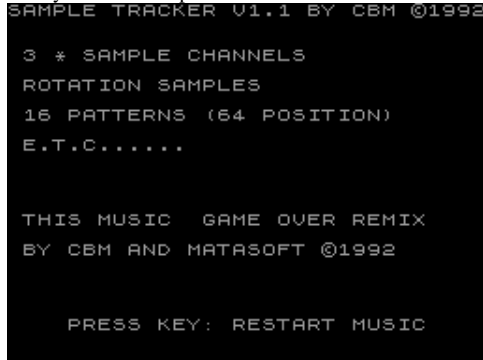

Sam Stoat Safebreaker (Gremlin Graphics Software Ltd,1985) Arcade



Samantha Fox Strip Poker (Martech Games Ltd,1986) Board/Card Game



Samomur (???) (Aurora Software,) Text Adventure

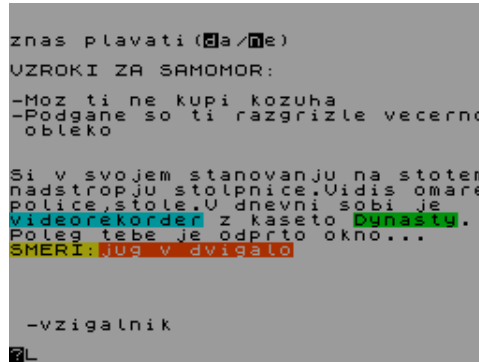

Sampler (Heikki Julkunen,1987) Utility: Sound Manipulation

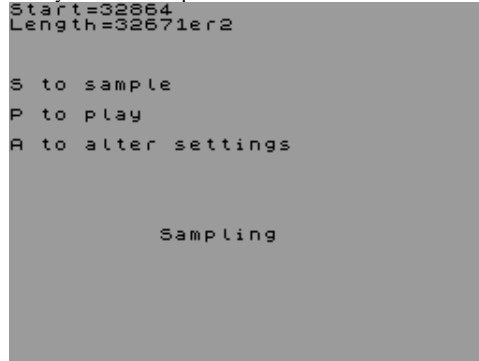

S.A.M. Simulator Boda Revenge (Miguel A. Garcia Prada,2004) Arcade

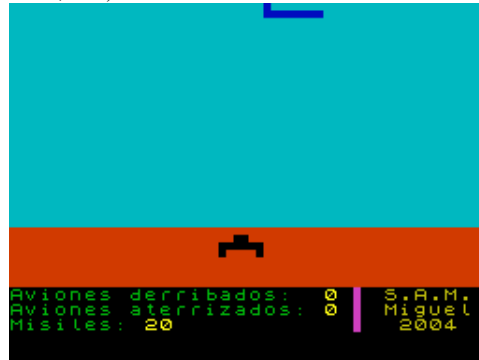

Sam's Un-Excellent Adventure (Zenobi Software,1994) Text Adventure

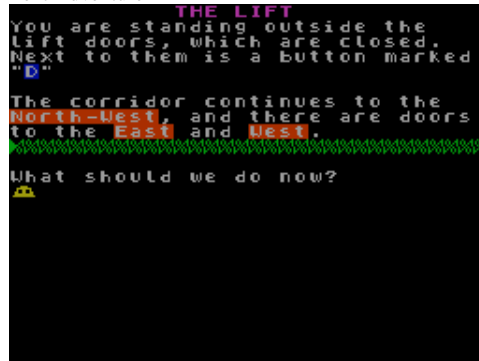

Sam Coupe - A Total Piss Take (The United Minds/Extacy-3,1995) Scene Demo



Sample Converter (Softhouse Ltd,1994) Utility: Music Creation

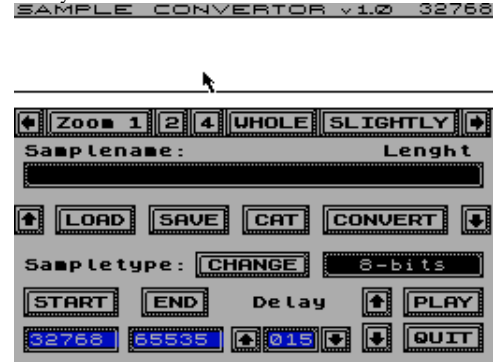

Sample Sequencer (Greg Fox,1995) Utility

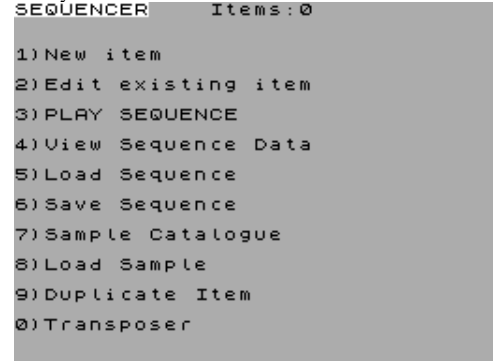

Sam Spade (Silversoft Ltd,1983) Arcade

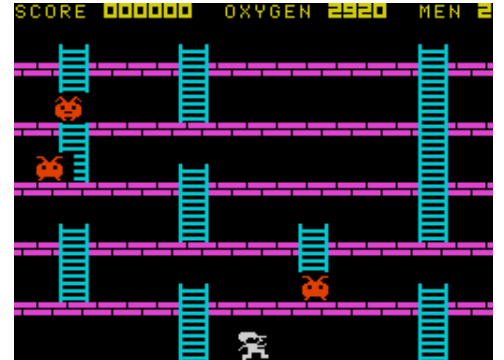

Sam's Un-Excellent Adventure + The Hospital (Zenobi Software,1995) Compilation



Samurai (CRL Group PLC,1986)
Strategy

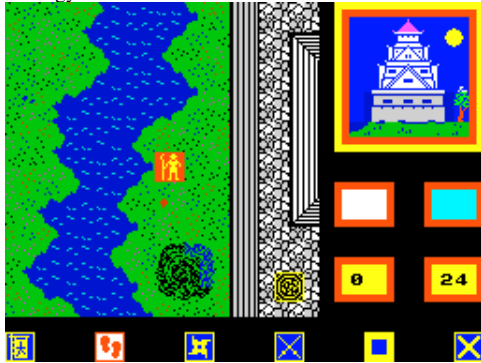

Samurai Trilogy (Gremlin Graphics Software Ltd,1987)
Text Adventure



Sand Conversion (.)
Utility

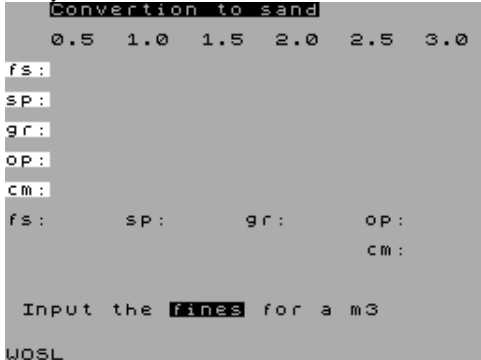

Sanity Man (The Power House,1986)
Text Adventure



Santa's Christmas Caper (Zeppelin Games Ltd,1991)
Arcade



Samurai Dancing (Anestis Koutsoudis,1998)
Scene Demo

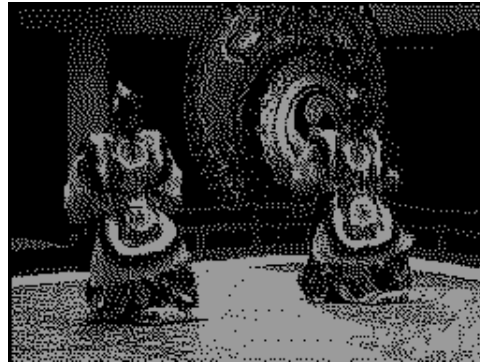

Samurai Warrior (Firebird Software Ltd,1988)
Arcade

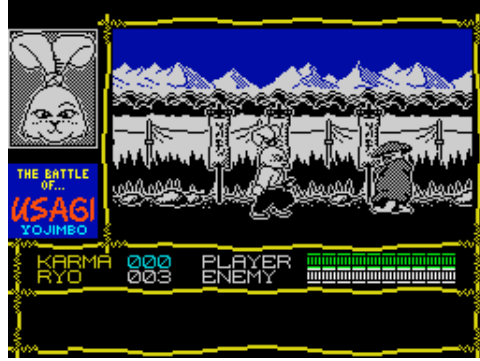

Sandman Cometh, The (Star Dreams,1984)
Text Adventure



Santa (Artic Computing Ltd,1983)
Arcade



Santa's Search (.)
Arcade



Samurai Dawn (Faster Than Light,)
Arcade

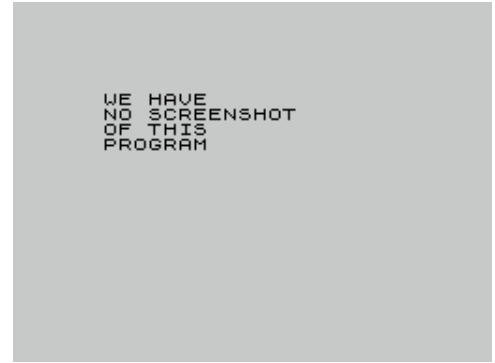

Samurai Warrior (MC Lothlorien Ltd,1982)
Simulation

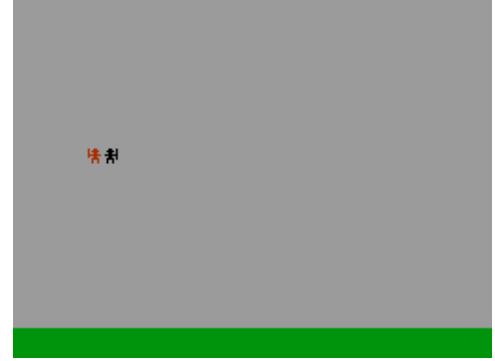

Sand Scorchers (Unique,1984)
Arcade

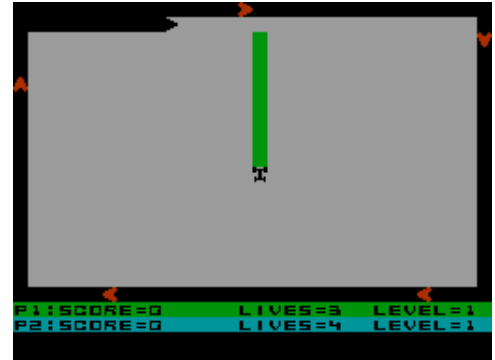

Santa Paravia en Fiumaccio (D.J. de Korte,)
Simulation



Sanxion: The Spectrum Remix (Thalamus Ltd,1989)
Arcade

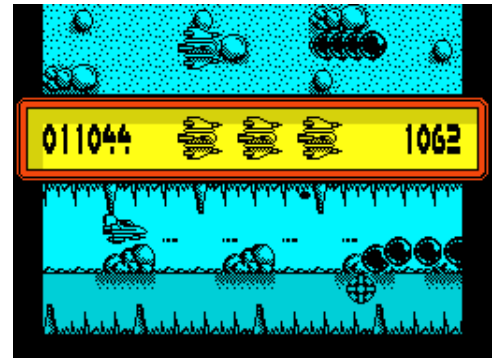

Sapper (Computer Work Company,1996)
Board/Card Game

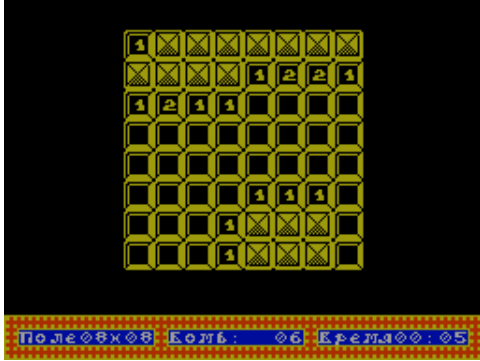

SAS: Operation Thunderflash!! (Sparklers,1986)
Arcade Adventure



S.A.S. Combat Simulator (Code Masters Ltd,1989)
Arcade



Satan's Pendulum (Minatron Computing,1983)
Arcade

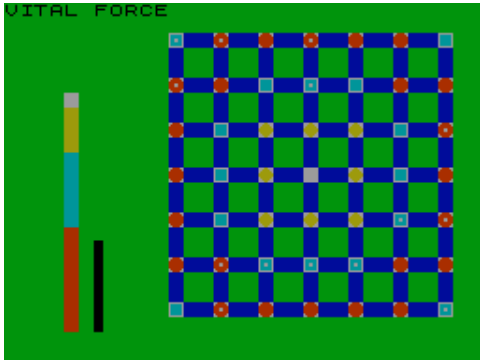

Satisfaction Megademo (Code Busters,1994)
Scene Demo



Saracen (US Gold Ltd,1987)
Arcade

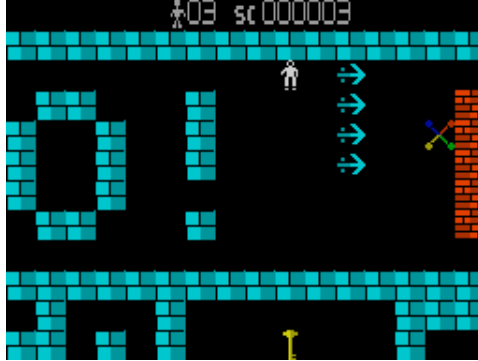

S.A.S. Assault (Mikro-Gen Ltd,1983)
Text Adventure

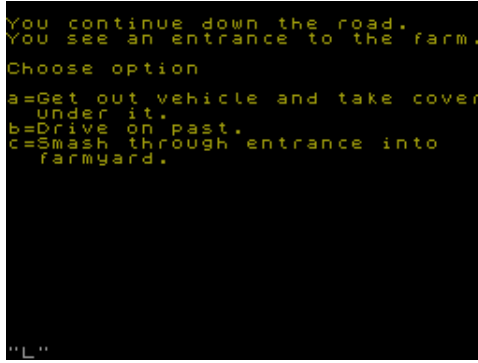

Satan (Dynamic Software,1990)
Arcade



Satan's Servants (K. Marshall/Taylorsoft,1986)
Text Adventure



Satochin (Sybilsoft,1988)
Text Adventure



Sarlmoor (Atlantis Software Ltd,1986)
Arcade



S.A.S. Combat Assault (Sinclair User,1993)
Arcade Adventure



Satan Copy 3 (Satansoft,1985)
Utility: Copier

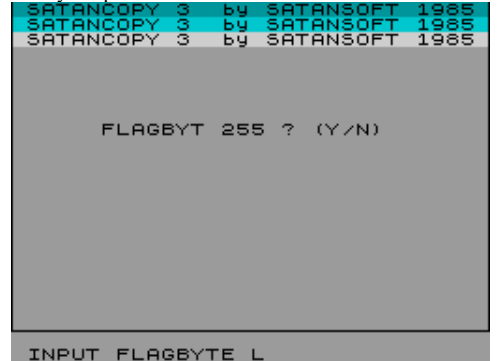

Satcom (Atlantis Software Ltd,1987)
Simulation



Saturn Lander (G. Owen,1983)
Arcade

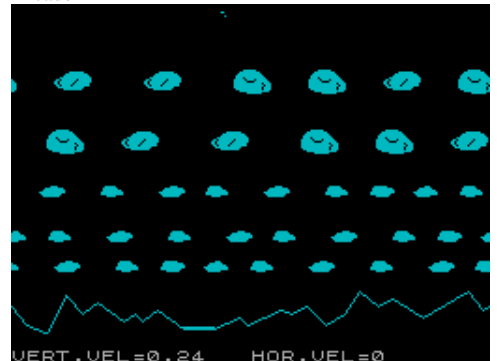

Saturno 2 (MicroHobby,1986)
Arcade

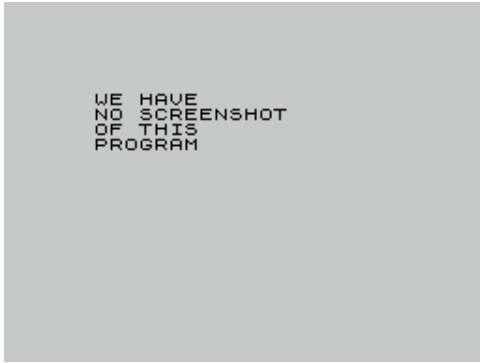

Saturno 3 (MicroHobby,1986)
Arcade



Saucers (Sinclair User,1983)
Arcade

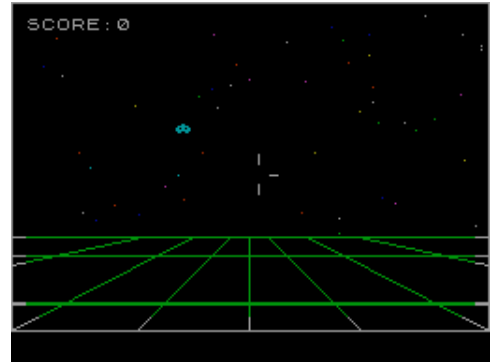

Savage (Firebird Software Ltd,1988)
Arcade Adventure



Savage (Sabe,1990)
Scene Demo



Savage Island 1 (Adventure International,1987)
Text Adventure



Savage Island 2 (Adventure International,1987)
Text Adventure



Savage Pond (Starcade,1984)
Arcade



Save Our Sheep (16/48 Tape Magazine,1984)
Simulation



Save the Whale (Granada Publishing,1983)
Arcade

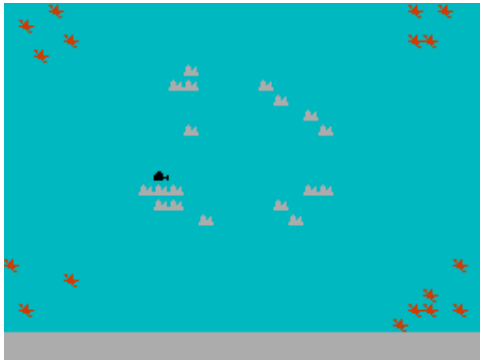

Save the Whale (Luca Bordonni,1997)
Arcade



Sbugetti Junction (Bug-Byte Software Ltd,1986)
Strategy

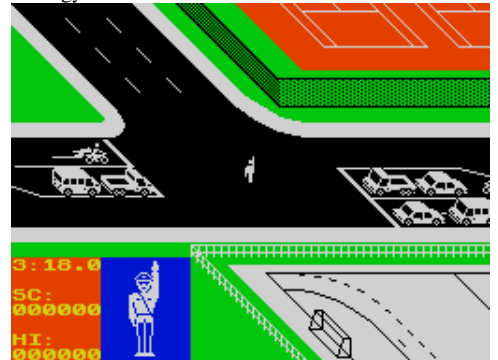

SC1 Tape to Microdrive Utility (Kobrahssoft,)
Utility: Copier



SC6 Advanced Tape Utility (Kobrahssoft,)
Utility: Copier



Scalexiada (NOP,1993)
Scene Demo



Scalextric (Leisure Genius,1986)
Arcade



Scangraph (Software Center S.A.,1984)
Utility



Scaramouche (Magic Team,1987)
Arcade



Sceptical (Delta 4 Software,1986)
Simulation



Sceptre of Bagdad (Atlantis Software Ltd,1987)
Arcade Adventure



Scalybur (MicroHobby,1986)
Arcade



Scanner (Greppo Franko,1985)
Utility

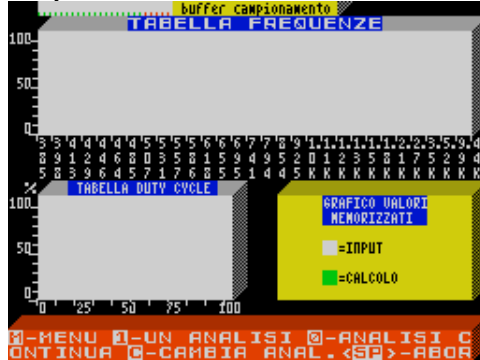

Scary Mansion (Zodiac Software,1987)
Text Adventure



Sceptical 2 (Delta 4 Software,1986)
Simulation

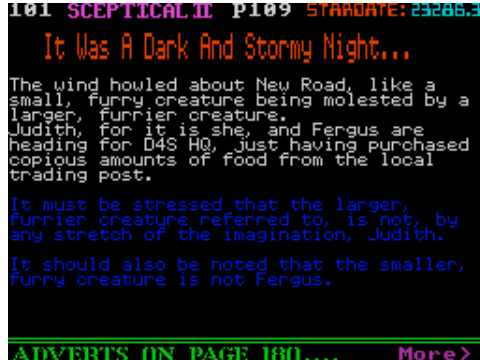

Schalk 2 (Hartmut Seba,1984)
Utility

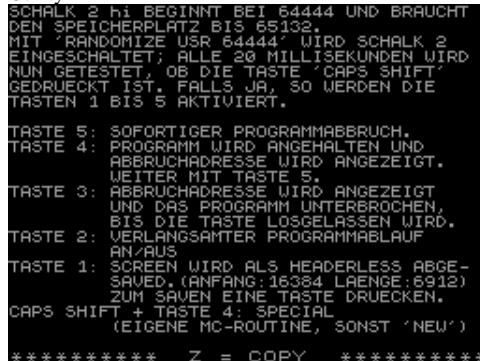

Scanner (Xor Soft [2],1988)
Utility

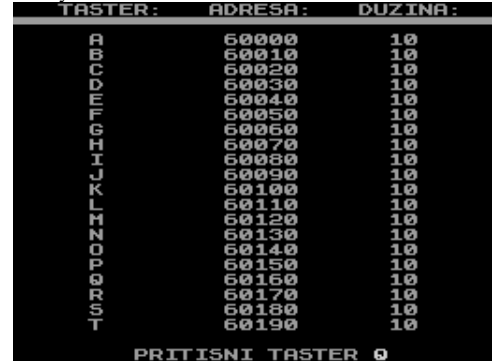

Scapghost (Level 9 Computing Ltd,1989)
Text Adventure

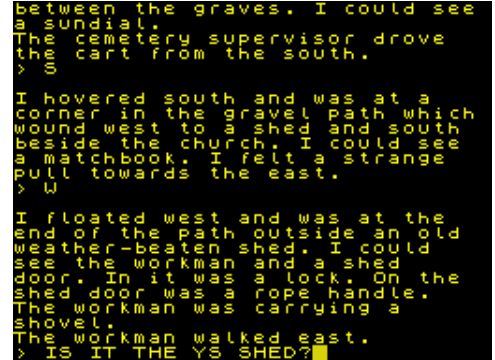

Scatterbrain (Manor Software,1984)
Simulation



Sceptical 3 (Delta 4 Software,1987)
Simulation

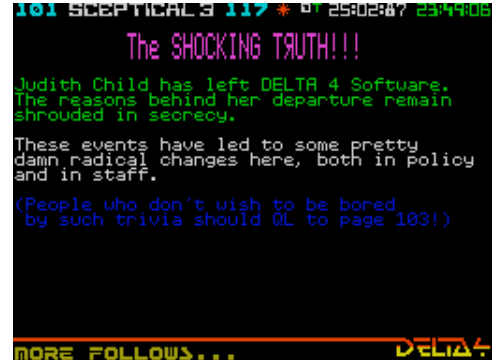

Schaltplan (.)
Utility: Electronics

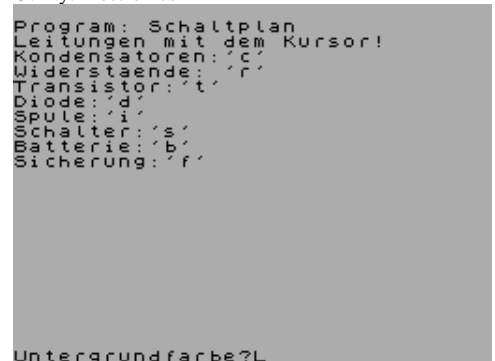

Schaltplanzeichner (.)
Utility: Electronics

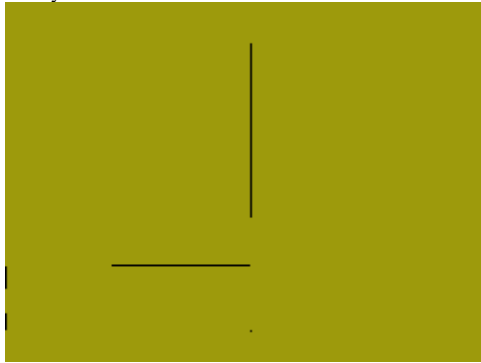

Schiffe Versenken (Omega-Soft,1983)
Board/Card Game



Schloss, Das (Chalksoft Ltd,1984)
Educational



Schlumpf (Hartmut Fiebig,1983)
Arcade Adventure



School (Baumsoft,1984)
Text Adventure

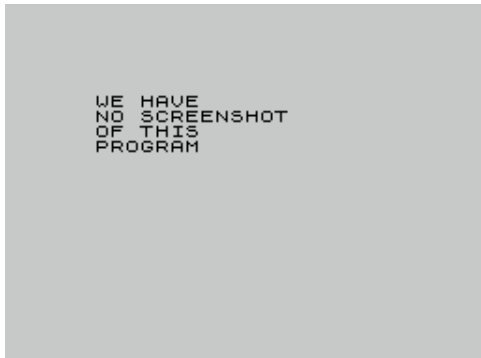

Schatz Des Minotaurus, Der (T. Korber,1984)
Text Adventure

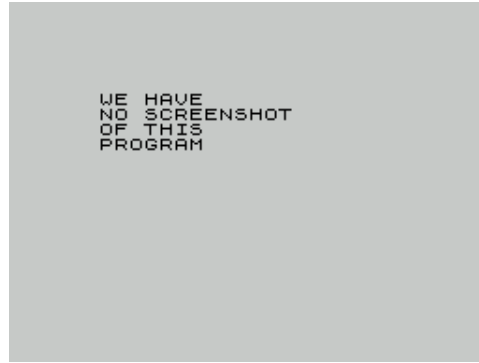

Schizophrenia (Quicksilva Ltd,1985)
Arcade



Schloss Greiffenklau (Pw/Mcs,1985)
Text Adventure



Schnapsen (Chris Gandler,1984)
Board/Card Game

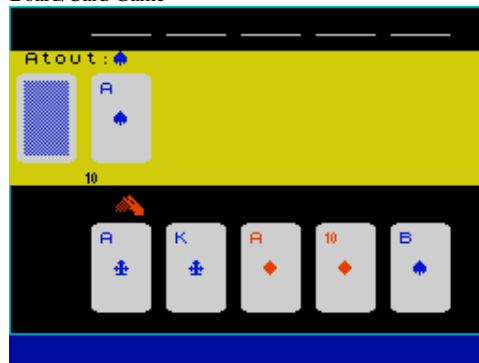

School (Lee Tonks,1984)
Text Adventure

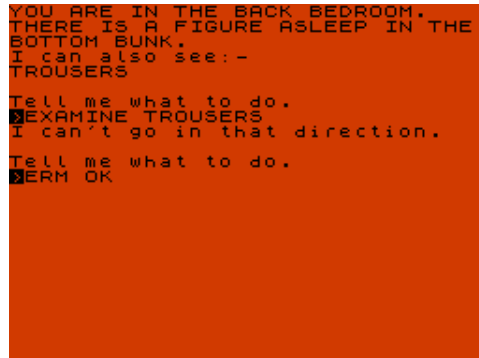

Schatzsuche Im Irrgarten (Wicosoft,1984)
Text Adventure



Schizoids (Imagine Software Ltd,1983)
Arcade



Schloss in den Karpaten, Das (Michael Silberberg,1985)
Text Adventure



Schnitte im Dreidimensionalen Raum (Ronald Roehl,1984)
Utility: Mathematics

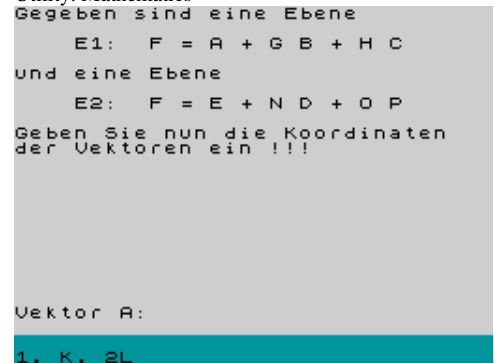

School 2 (Lee Tonks,1984)
Text Adventure

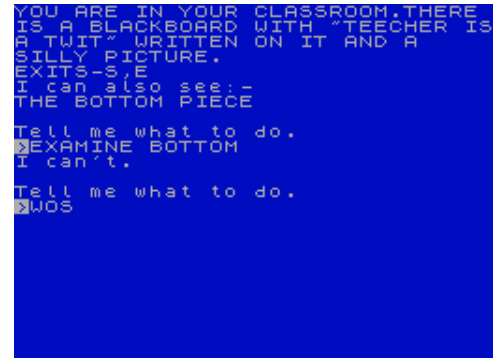

School Adventure (Daniel Tietze,)
Text Adventure

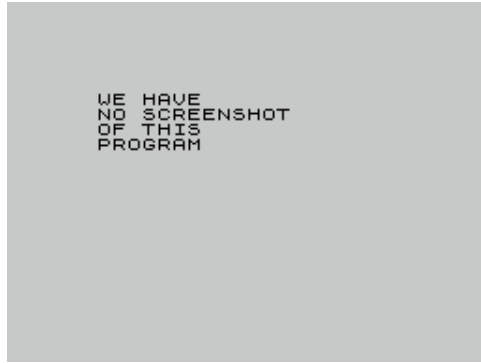

Schwimmen (A. Horstmann,1985)
Board/Card Game



Sci-File (Visions Software Factory,1984)
Utility

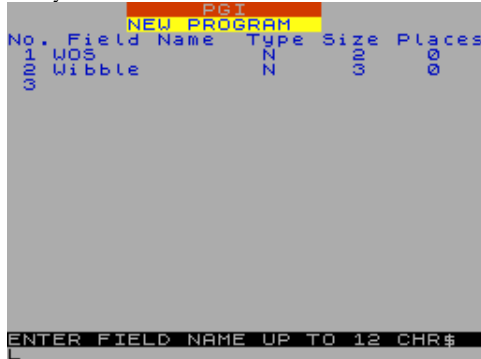

Scoop (Sentient Software Ltd,1985)
Text Adventure

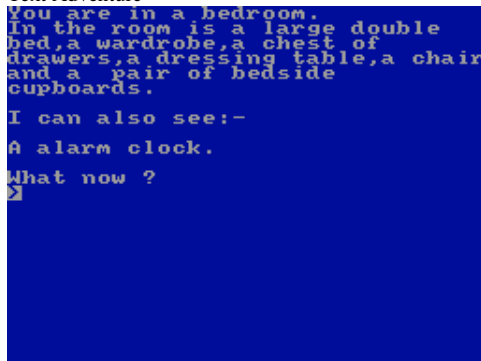

Scopy (Outlet Microdrive Magazine,)
Utility: Drawing

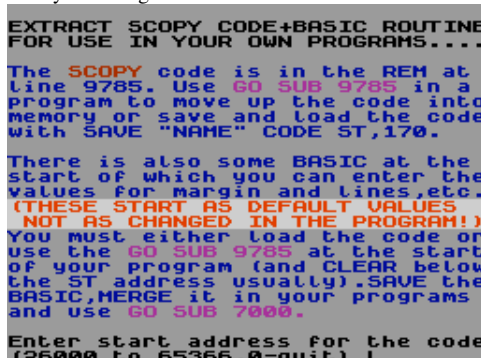

School Bus (MicroHobby,1985)
Arcade

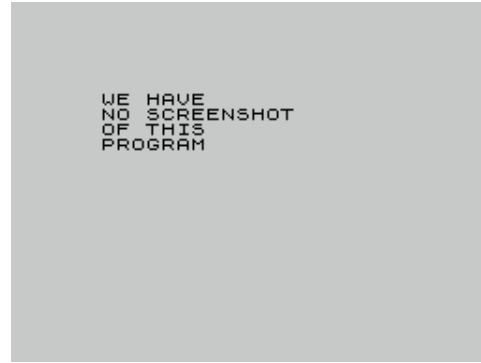

Science - 12-14 Yrs (Micro-De-Bug Consultancy,1984)
Educational

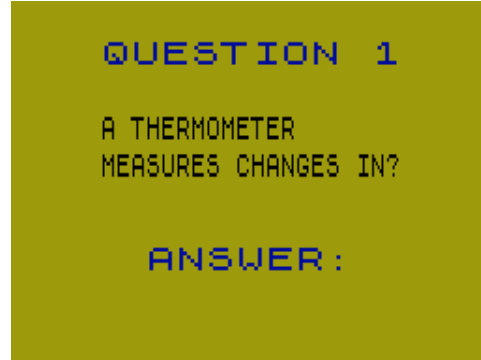

Scooby Doo (Elite Systems Ltd,1986)
Arcade

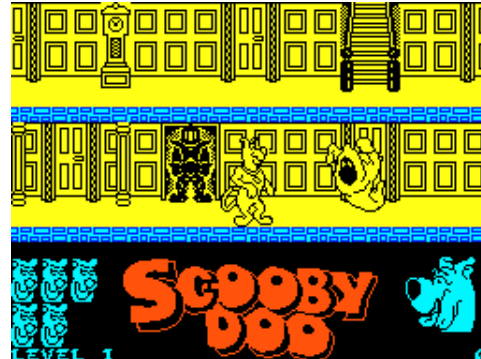

Scope (Interactive Software People,1983)
Utility: Screen Manipulation



Scorched Earth, The (Star Group,1997)
Arcade

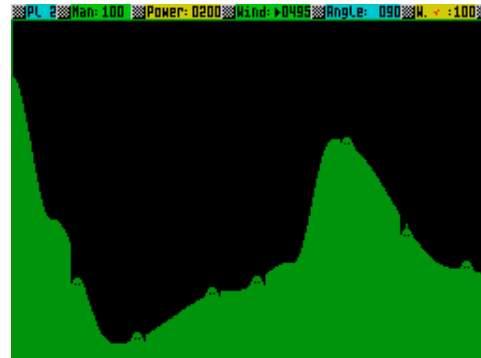

School Report (Soft 2000,1985)
Text Adventure

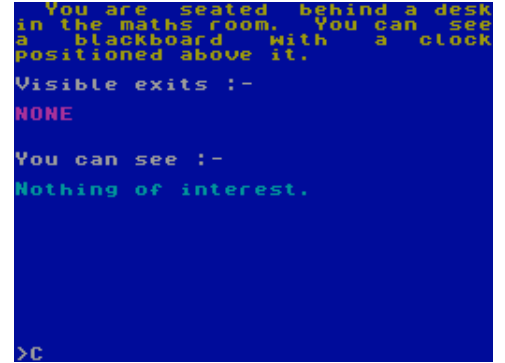

Scientist Rescue (Sinclair Programs,1984)
Arcade

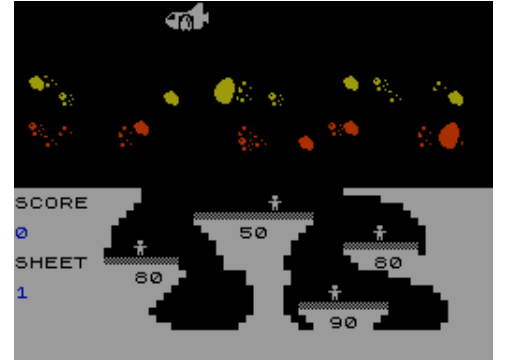

Scooby Doo and Scrappy Doo (Hi-Tec Software Ltd,1991)
Arcade

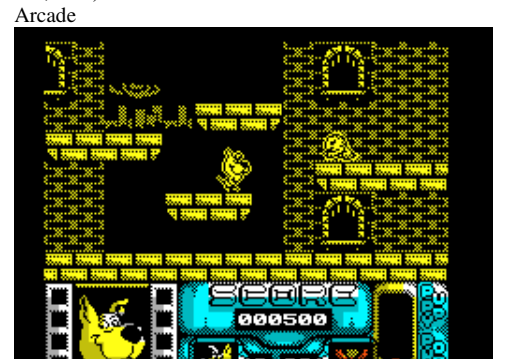

Scope II (Interactive Software People,1985)
Utility: Screen Manipulation

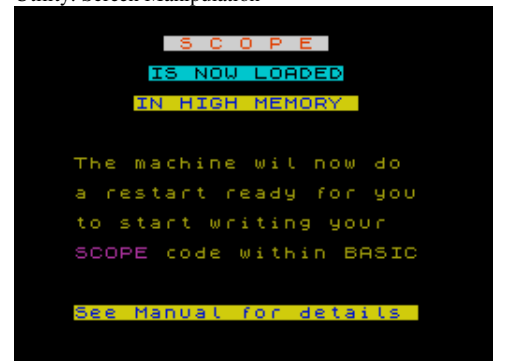

Score (CV Software,1989)
Arcade



Score 3020 (Topo Soft,1988)
Arcade

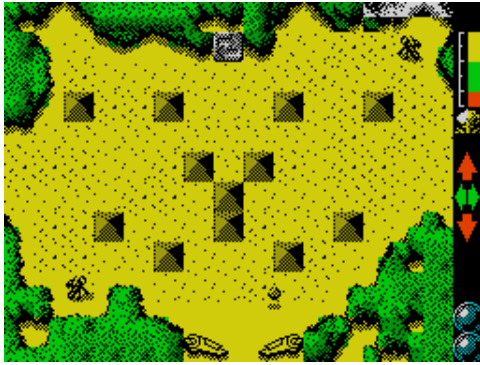

Scorpion (Live-Wire Software,1983)
Arcade



Scotrail Express (Dee-Kay Systems,)
Simulation

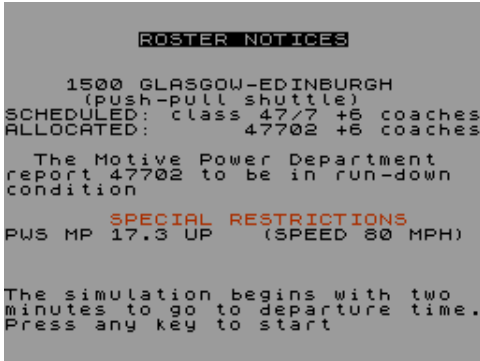

Scottish League (Cult Games,)
Simulation



Scrabble DeLuxe (Virgin Games Ltd,1987)
Board/Card Game



Scoreboard (Byron Software,1986)
Sport



Scorpions: Die Machine (Magic Soft,1996)
Arcade Adventure



Scotsmaths (Technol Computing,1986)
Educational



Scottish Towns (Teacher's Pet Software,1988)
Educational



Scramble (16/48 Tape Magazine,1984)
Board/Card Game



Scoria Sonic 2 Preview (Jackson Hollis,1993)
Scene Demo

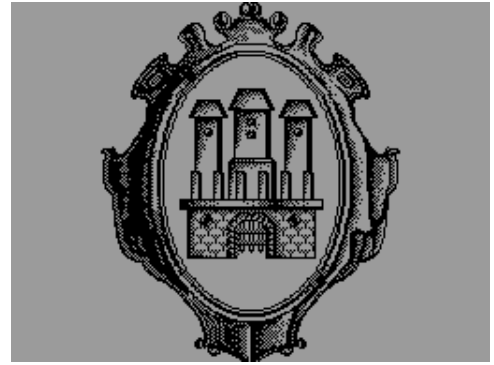

Scotrail Class 47 Manager (Ashley Greenup,1990)
Simulation

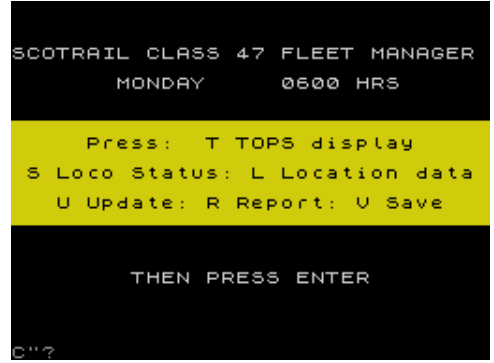

Scott Adams Scoops (US Gold Ltd,1987)
Compilation

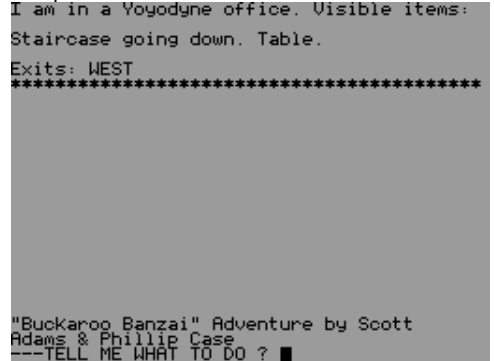

Scout Troop (Nevis Records Ltd,1985)
Utility

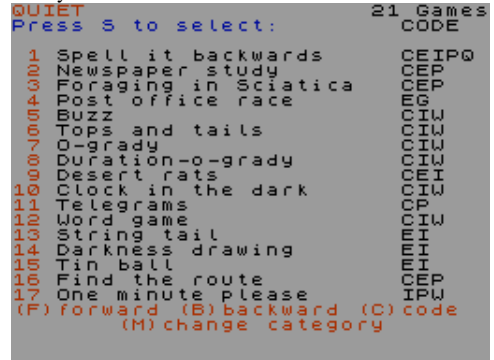

Scramble (Krypton Force,1984)
Arcade



Scramble (Mikro-Gen Ltd,1983)
Arcade



Scrapyard, The (5D Software,1984)
Arcade



Screen Compressor (Mikropol,1993)
Utility: Screen Manipulation



Screen Heroes (Ocean Software Ltd,1987)
Compilation

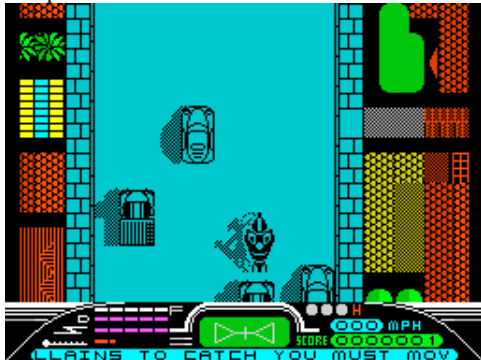

Screen Machine, The (Interactive Software People,1984)
Utility

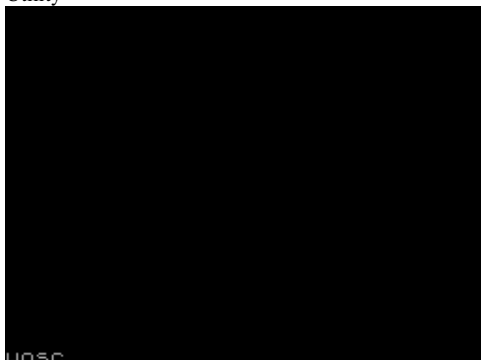

Scrambler 2 (Mentor Software,1983)
Educational

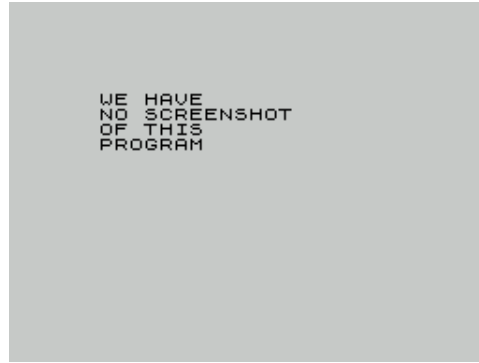

Screaming Demons (Axis Software,1983)
Arcade

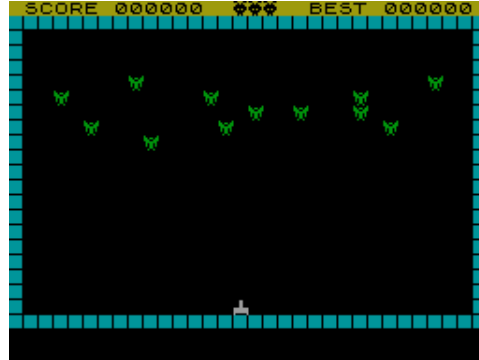

Screen Compressor (Sinclair User,1992)
Utility

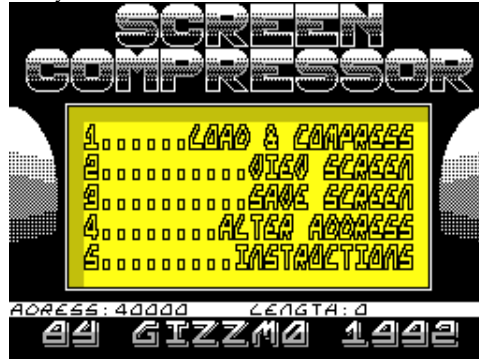

Screen LOAD & Save (Kanebo Software,1987)
Utility



Screen Master (Simtron,1986)
Utility: Screen Manipulation

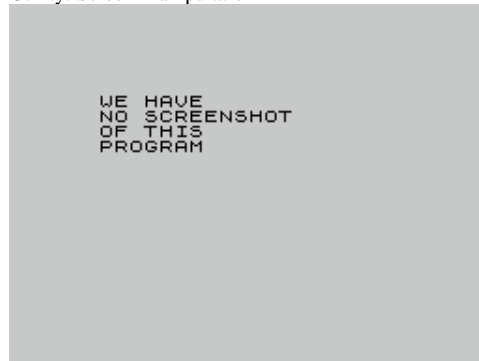

Scramble Spirits (Grandslam Entertainments Ltd,1990)
Arcade



Screen *2 (16/48 Tape Magazine,1984)
Utility



SCREEN\$ Converter (Benkosoft,)
Utility: Screen Manipulation

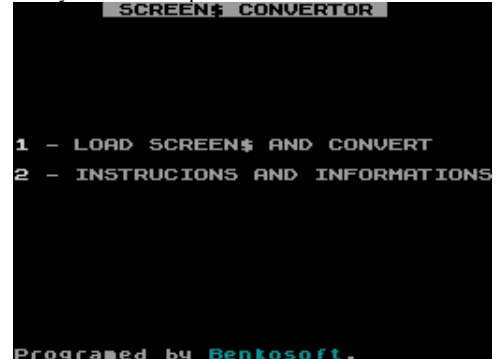

Screen Machine (Print'n'Plotter Productions,1984)
Utility: Screen Manipulation



Screen Merger, Der (Spectra Computing,1984)
Utility: Screen Manipulation

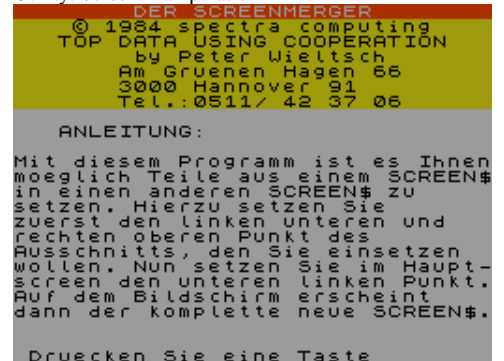

Screen Play (Macmillan Software Ltd,1987)
Utility: Drawing

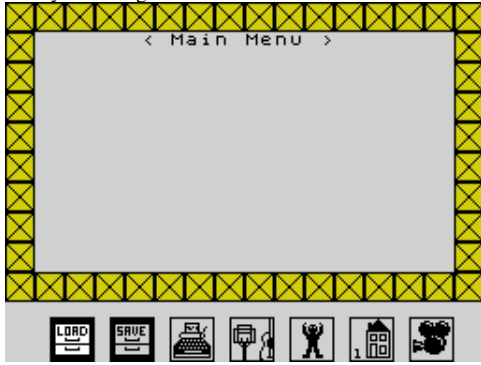

Script Designer (16/48 Tape Magazine,1986)
Utility: Font/UDGs



Scrolling Example (Longman Software,1984)
Utility: Programming



Scrollisis (EP Software,.)
Arcade



Scuba Attack (Century Software [1],1984)
Arcade



Screens (MicroHobby,1986)
Utility: Drawing

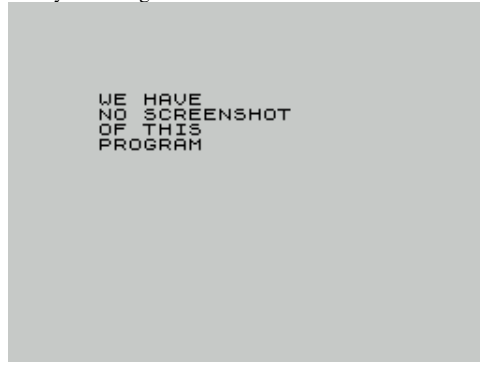

Scroll (,)
Utility: Screen Manipulation



Scroll Show (Pentagram,.)
Scene Demo



Scrumper (Sinclair Programs,1983)
Arcade



Scuba Dive (Durell Software Ltd,1983)
Arcade

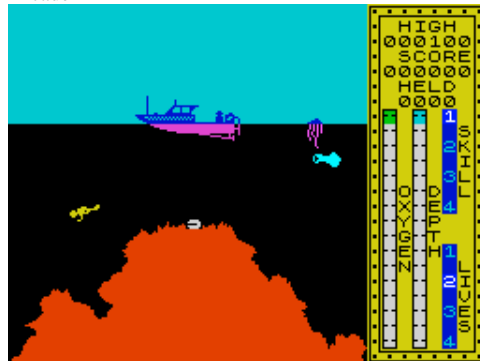

Screwie (Nuevo Mundo,1987)
Arcade

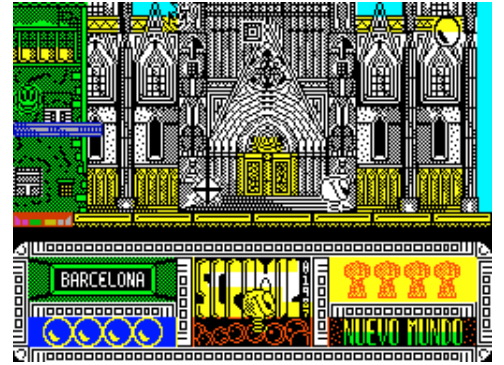

Scroll de Pantalla Pixel a Pixel (MicroHobby,1986)
Utility: Programming



Scrolls of Thram, The (Leslie Marwick,1985)
Text Adventure

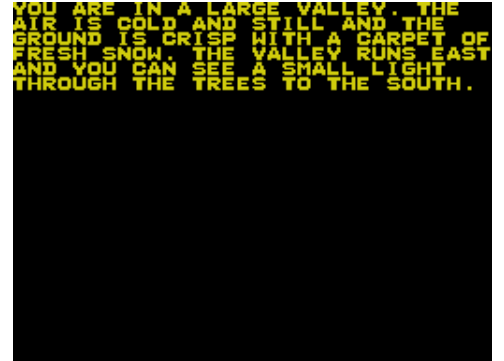

Scrumpy (R.D. Foord Software,1987)
Arcade

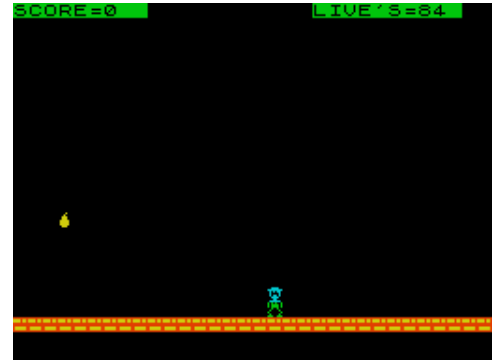

Scuba Kidz (Silverbird Software Ltd,1989)
Arcade



Scumball (Bulldog,1988)
Arcade



SD5 Plus Utility (Kobrahsft,)
Utility: Copier



SDM 4K (Syndrome,1998)
Scene Demo

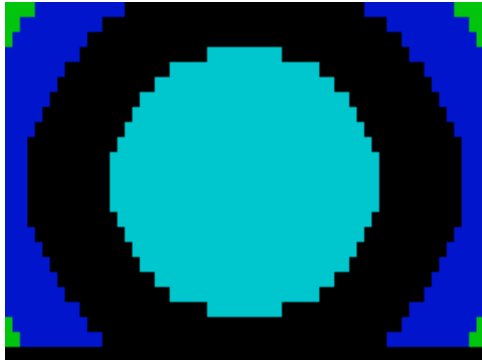

Sea-Battle (Add-On Electronics Ltd,1983)
Board/Card Game



Sea Cruise (The PResS Adventure,)
Text Adventure



SD3 Advanced Tape to Microdrive Utility
(Kobrahsft,1987)
Utility: Copier



SD5 Tape to Microdrive Utility (Kobrahsft,1989)
Utility: Copier



Sea (VTS,2001)
Strategy

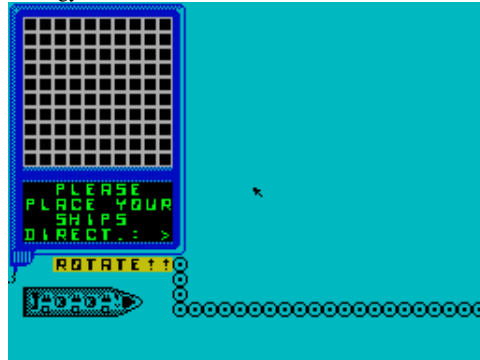

Sea Battle (M. Spiridonenko,1994)
Arcade

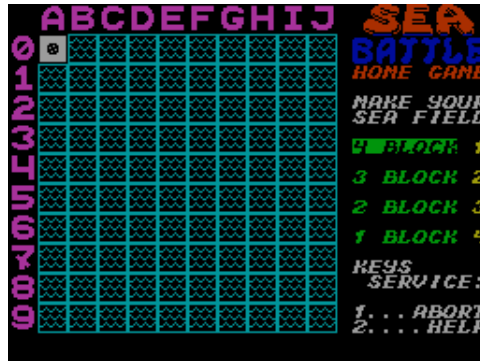

Seahawk (Atlantis Software Ltd,1990)
Arcade



SD4 Advanced Tape to Microdrive Utility
(Kobrahsft,)
Utility: Copier



S.D.I. (Activision Inc,1988)
Arcade



Seabase Delta (Firebird Software Ltd,1985)
Text Adventure

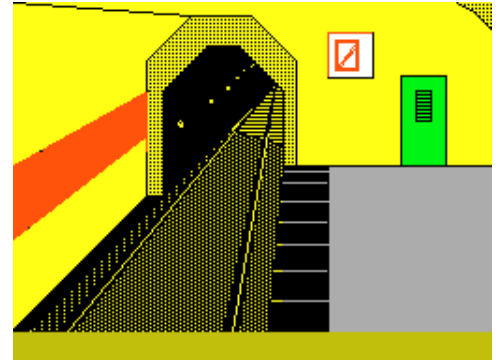

Sea Battles (Atlantis Software Ltd,1984)
Board/Card Game

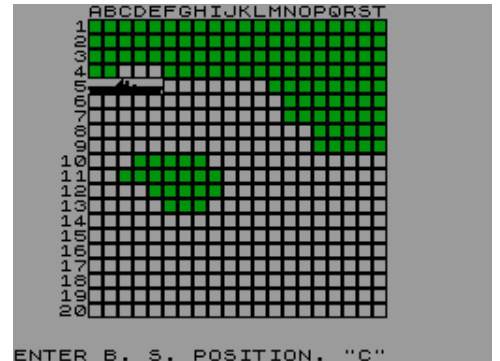

Sea Landing (.)
Arcade



Sealed City, The (Central Solutions,1986)

Text Adventure



Search for Smok, The (,)

Text Adventure



Seaside Sorcery (Zenobi Software,1997)

Text Adventure



Sea War (Alexey Vetytnev,1993)

Board/Card Game



Seawolf (Chameleon,1983)

Strategy



Seamaster (A. Walter,1985)

Board/Card Game



Search for the Nether Regions (Zenobi Software,1987)

Text Adventure

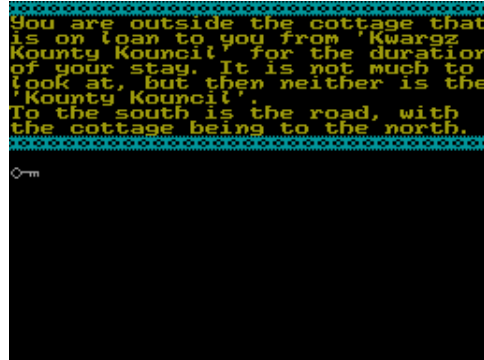

Seas of Blood (Adventure International,1985)

Text Adventure



Sea War (Panda Software,1982)

Arcade



Second Attempt on Speccy (TRENSoft,1994)

Scene Demo



Sea of Zirun (Gilsoft International,)

Text Adventure

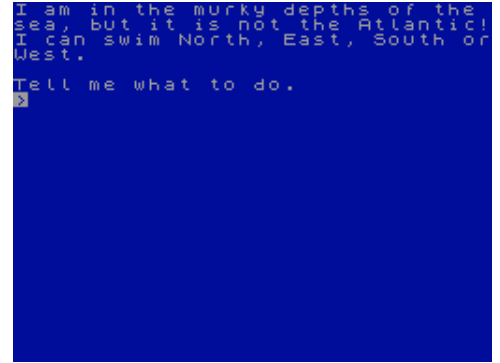

Search for the Wonderful Whatsit (Derek Shaw,1996)

Text Adventure

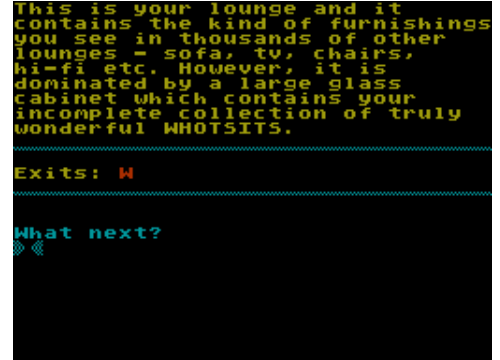

Sea Spray Incident, The (Scorpio Gamesworld,1985)

Text Adventure

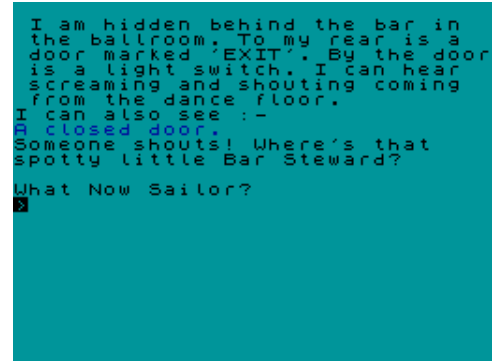

Sea War (R. Stobbe,1985)

Board/Card Game



Second Reality (Matthew Westcott,1995)

Scene Demo



Secret Code (Sinclair Research Ltd,1982)
Arcade



Secret Mission 007 James Bond (Petr Spad,1987)
Text Adventure



Secret of Levitation, The (Americana Software Ltd,1986)
Arcade



Secret River, The (Triffid Software Research,1985)
Strategy



Security Shelter (Custom Cables International Ltd,1983)
Text Adventure

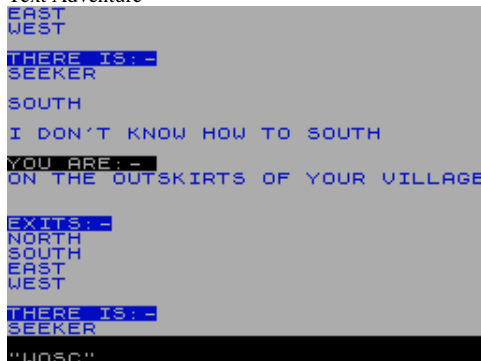

Secret Diary of Adrian Mole, The (Mosaic Publishing Ltd,1985) Text Adventure

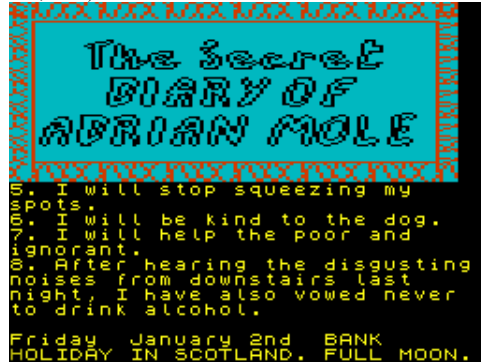

Secreto de Pentengan, El (MicroHobby,1986)
Arcade



Secret of Little Hodcome, The (Zenobi Software,1987)
Text Adventure



Secret Valley (Newsoft Products,1982)
Text Adventure



Seek and Find (Humphrey Software,1986)
Arcade



Secret Mission (Adventure International,1985)
Text Adventure



Secret of Arendarvon Castle, The (Addison-Wesley Productions,1985) Text Adventure

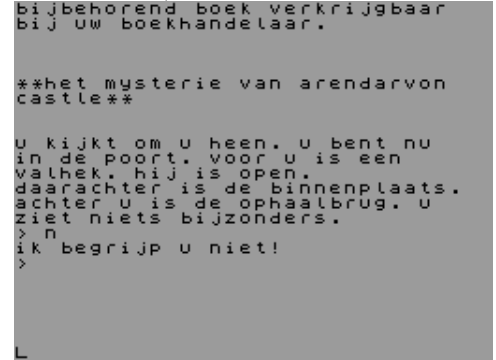

Secret of St. Brides, The (St. Bride's School,1985)
Text Adventure

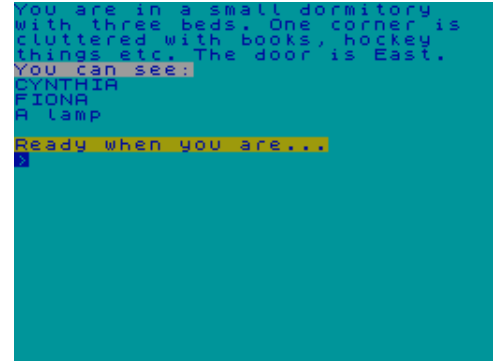

Sector 90 (Argus Press Software Ltd,1987)
Arcade

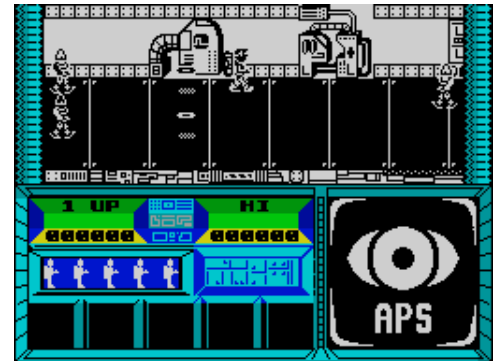

Seekey (Breadhill,1982)
Arcade



See-Saw (unpublished,1982)
Educational

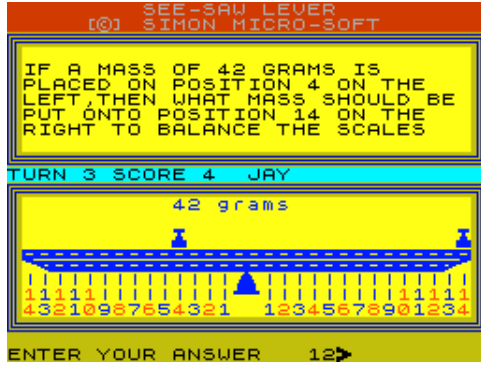

Sega Master-Mix (US Gold Ltd,1991)
Compilation



Se-Kaa of Assiah (Mastervision,1984)
Text Adventure

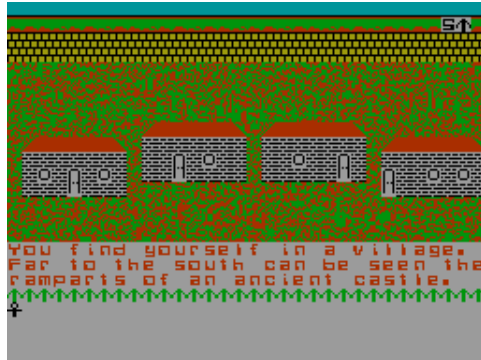

Selectron 36 (P.S. Lodge,1985)
Simulation

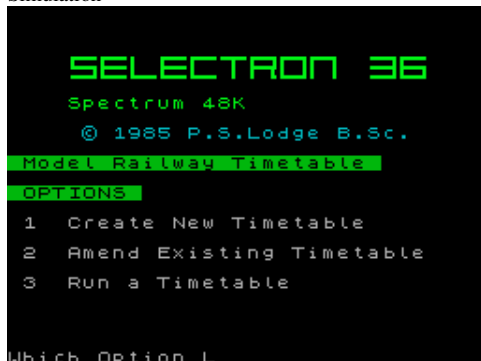

Semi-detached at the End of the Street, The (S. Phipps,2000) Text Adventure



Sefton Manor Assignment, The (The Adventure Club,1990)

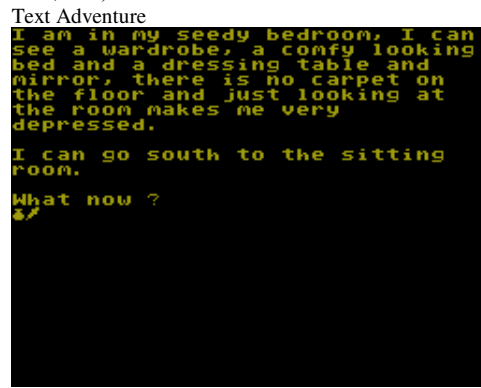

Segunda Muerte de Dracula, La (Iron Chip,2001)
Text Adventure

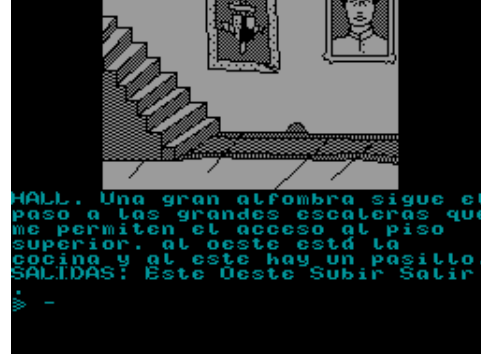

Select 1 (Computer Records,1985)
Compilation



Self Destruct (Atlantis Software Ltd,1985)
Arcade



S.E.M.I.S.I.S. (MicroHobby,1987)
Arcade



Sega Collection, The (US Gold Ltd.)
Compilation



Seiddab Attack, 3D (Hewson Consultants Ltd,1984)
Arcade



Selective Listing (.)
Utility: BASIC Related



Selvaticus (MicroHobby,1986)
Arcade



Senda Salvaje (Zigurat Software,1990)
Arcade



Senet (MicroHobby,1985)
Arcade

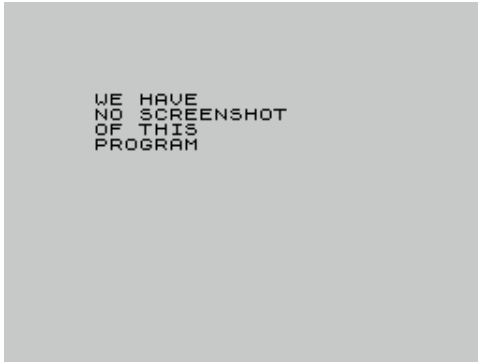

Senso (CP Software,1984)
Simulation



Sentinel, The (Firebird Software Ltd,1987)
Arcade

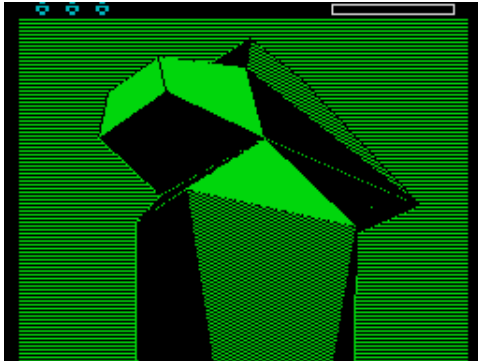

Septiembre (Procin Soft Line,)
Board/Card Game



Serf's Tale, The (Players Software,1986)
Text Adventure

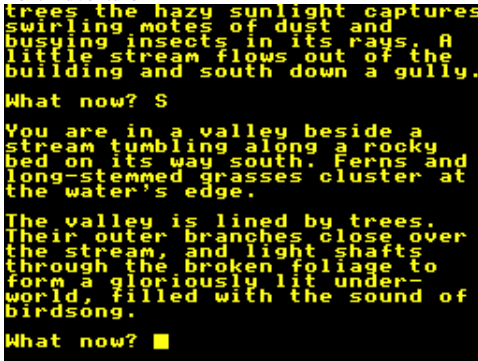

Senku (MicroHobby,1991)
Board/Card Game



Sentinel (Abacus Programs,1984)
Arcade

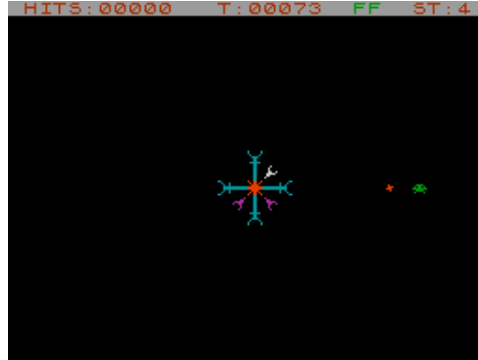

Sentonal 2000 (Mole Software,1985)
Arcade



Sequencing (Chalksoft Ltd,1984)
Educational

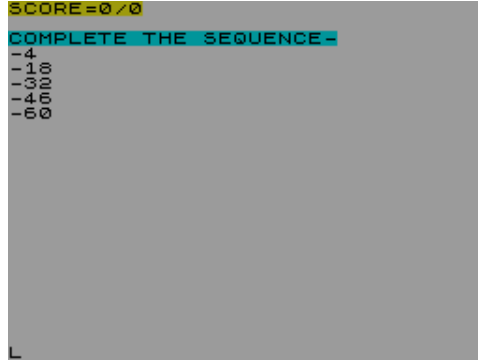

Sergeant Seymour Robot Cop (Code Masters Ltd,1992)
Arcade

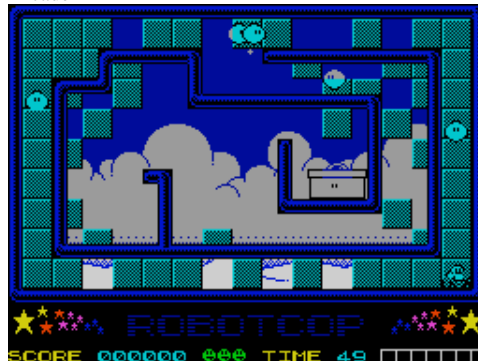

Senor del Dragon, El (Grupo Creators Union,1990)
Text Adventure



Sentinels (Century City Software Ltd,1984)
Arcade

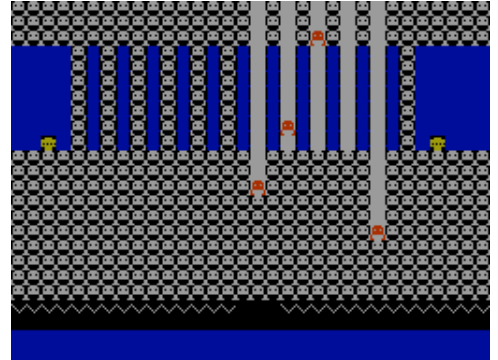

September (Activision Inc.)
Arcade



Serendipity (Dream World Adventures,1994)
Text Adventure

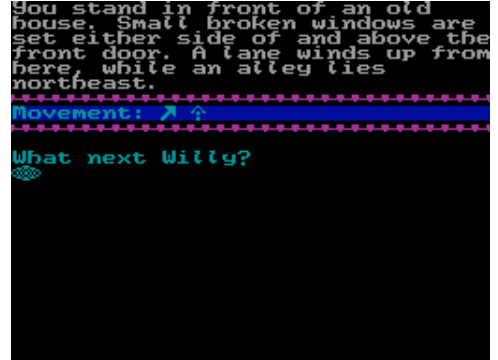

Serial 8056 Screen Copy Routine (Paul Bullough,1988)
Utility



Serpent from Hell (Scorpio Gamesworld,1985)
Text Adventure

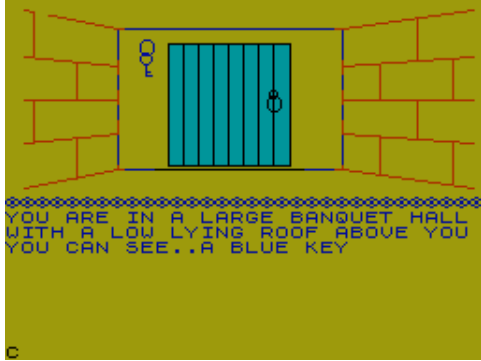

Serpes (David "Amigaman",2003)
Arcade

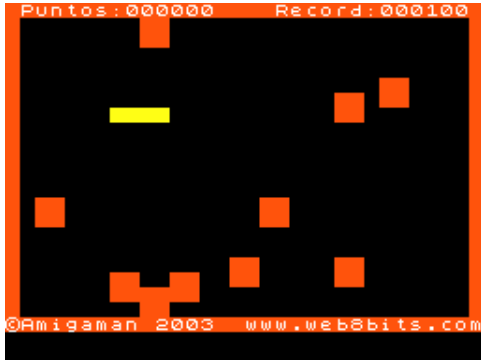

Settlement XIII (Dream World Adventures,1993)
Text Adventure



Seven Minutes to Midnight (Destiny Software,1988)
Arcade



Sewer, The (Domark Ltd.)
Arcade



Serpenti (.1986)
Arcade

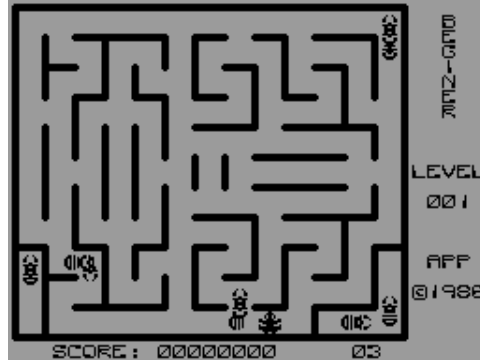

Sest Ran do Klobouku (SPL,1986)
Board/Card Game

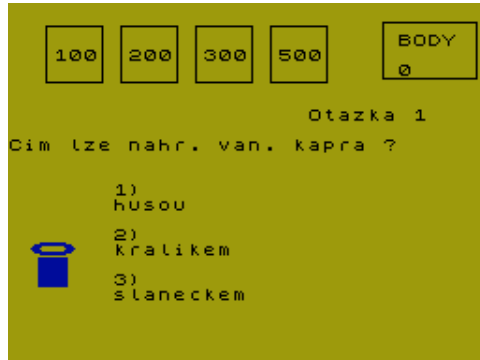

Set Up! (Global Games [1],1989)
Text Adventure



Seven Parchments of Kandos, The (Sinclair User,1989)
Text Adventure



Sex (.)
Scene Demo



Serpent's Tail (Spectre Soft,1984)
Arcade



Sets (Alpha Plus,1986)
Educational



Seven Hills, The (Anik Microsystems,1984)
Arcade



Seventh Cavalry (Black Knight Software,1985)
Strategy



Sex Crime (Omycron Software,1985)
Arcade



Sexdemo (The Lids,) Scene Demo



Sex Invaders (Silver Fox Comm Ltd,1983) Arcade



Sex Poker (Andreas Niemann,1984) Board/Card Game



Sex Simulator 1 (Scandinavian Software Crackers,1988) Scene Demo

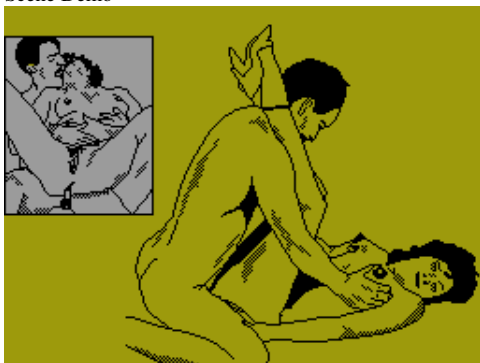

Sex Tetris 2 (Seamans Beer Users Hackers Group,) Arcade



Sexeso (OKF,1988) Board/Card Game

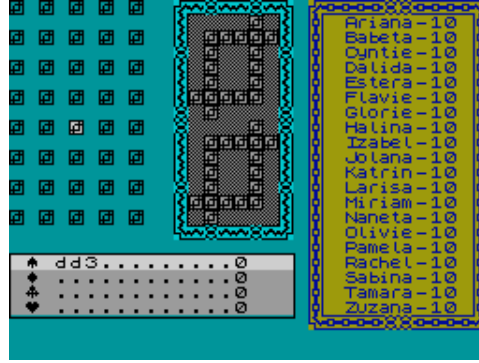

Sex Machine (Shattered Dreams,1987) Text Adventure

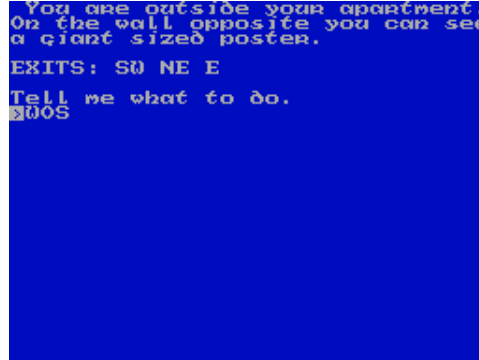

Sex Poker (Janusz Gajewicz,1986) Board/Card Game

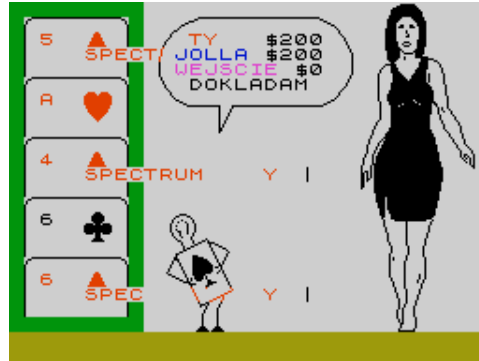

Sex Tetris (.) Arcade



Sextris (Silicon Brains Software Ltd,1995) Arcade



Sex Game (Softlake/Meastrosoft,) Board/Card Game



Sex Minesweeper (UFO Group,1997) Board/Card Game

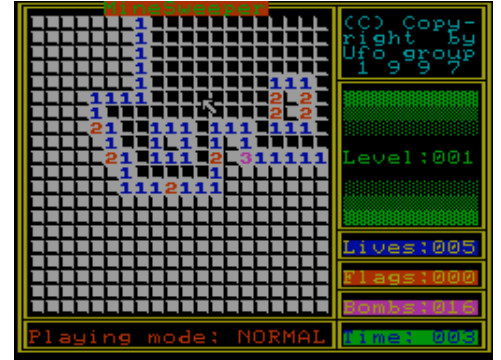

Sex Poker Dla Niecierpliwych (Janusz Gajewicz,1986) Board/Card Game

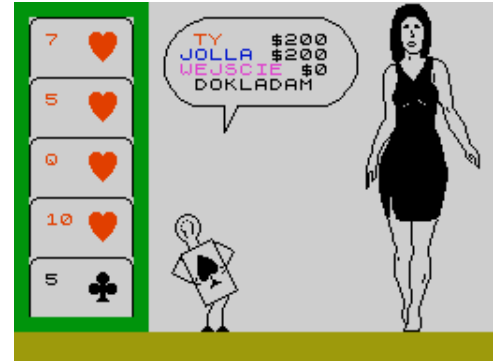

Sex Tetris (Russian Soft,1993) Arcade



Sextris Plus, The (B. Michael,) Arcade



Sex Vixens from Space (Asoft [2],1989)
Arcade



Seymour Goes to Hollywood (Code Masters Ltd,1991)
Arcade

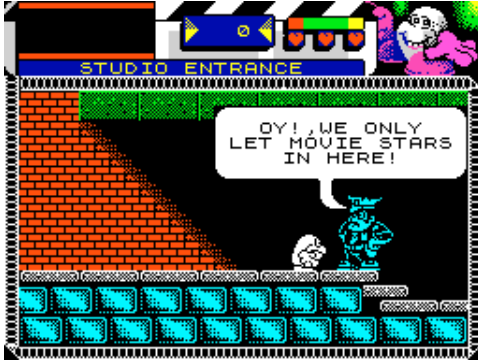

Sgt. Pepper 1 (Sgt. Pepper,1988)
Scene Demo

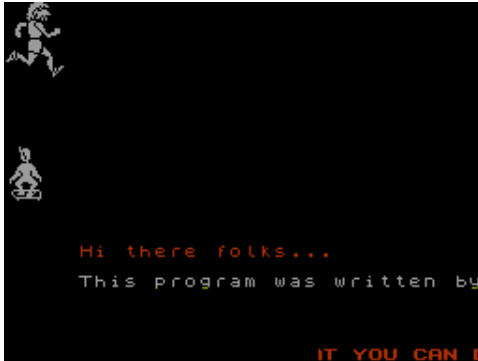

Sgt. Pepper 2 (Sgt. Pepper,1988)
Scene Demo

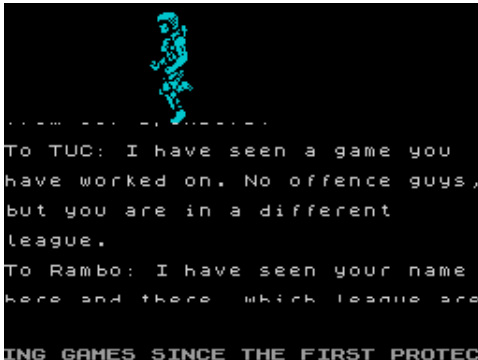

Sgt. Pepper 6 (Sgt. Pepper,1988)
Scene Demo



Sex Xonix (Tankard,1996)
Board/Card Game



Seymour - Take One! (Your Sinclair,1991)
Arcade



Sgt. Pepper 10 (Sgt. Pepper,1989)
Scene Demo



Sgt. Pepper 3 (Sgt. Pepper,1988)
Scene Demo



Sgt. Pepper 7 (Sgt. Pepper,1989)
Scene Demo



Sexy Black Jack (Load 'n' Run [Ita],1986)
Board/Card Game

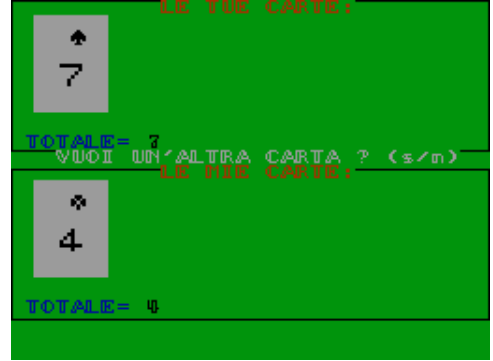

Sgrizam (Dinamic Software,1985)
Arcade

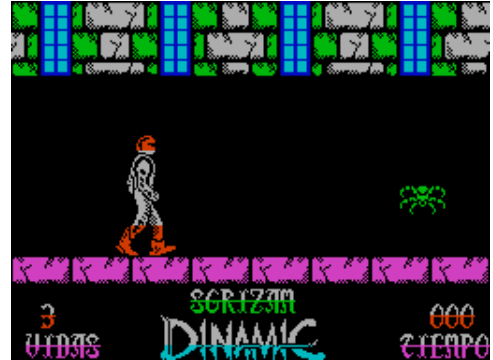

Sgt. Pepper 11 (Sgt. Pepper,1989)
Scene Demo



Sgt. Pepper 4 (Sgt. Pepper,1988)
Scene Demo



Sgt. Pepper 8 (Sgt. Pepper,1989)
Scene Demo



Sgt. Pepper 9 (Sgt. Pepper,1989)
Scene Demo

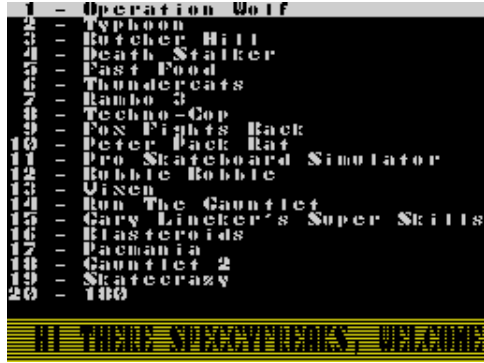

Shades (Micronet,1986)
Text Adventure



Shadowfax (Postern,1983)
Arcade



Shadow of the Beast (Gremlin Graphics Software Ltd,1990)
Arcade

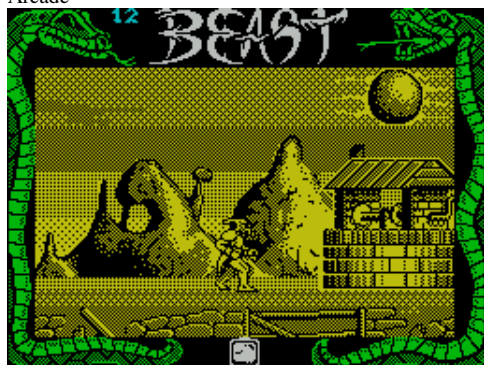

Shadows from the Dark Side (Digital Design,1987)
Arcade

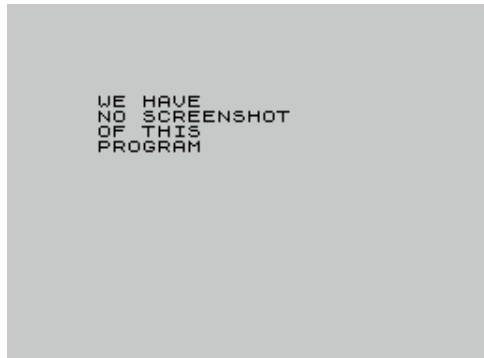

Shackled (US Gold Ltd,1988)
Arcade Adventure



Shadow Dancer (US Gold Ltd,1991)
Arcade



Shadowfire (Beyond Software,1985)
Strategy



Shadow of the Unicorn (Mikro-Gen Ltd,1985)
Arcade



Shadow Skimmer (The Edge Software,1987)
Arcade



Shade Copy (Your Computer,1984)
Utility: Copier



Shadow Dancer + Alien Storm (US Gold Ltd,1991)
Compilation



Shadowfire Tuner (Beyond Software,1985)
Strategy



Shadow on Glass, A (Psychaedelic Hedgehog Software,1989)
Text Adventure

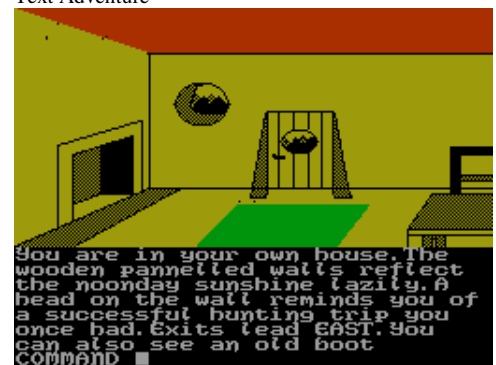

Shadows of Mordor (Melbourne House,1987)
Text Adventure

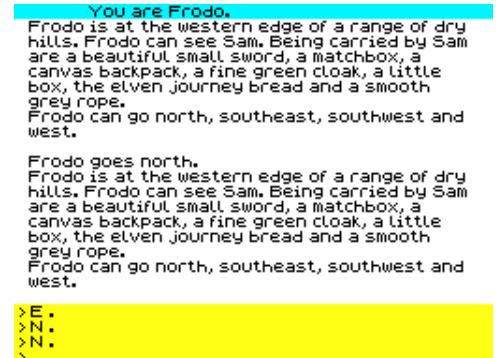

Shadows of the Past (Compass Software,1988)

Text Adventure



Shaken But Not Stirred (Richard Shepherd Software Ltd,1983) Arcade

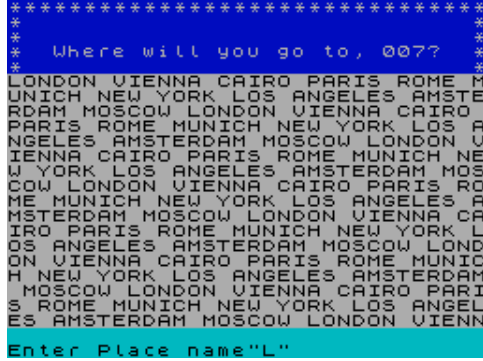

Shakespeare - Macbeth (Penguin Study Software,1984) Educational



Shakespeare - Twelfth Night (Penguin Study Software,1984)

Educational



Shanghai Warriors (Players Software,1989)

Arcade



Shadow Warriors (Ocean Software Ltd,1990)

Arcade



Shakespeare - Henry IV Part 1 (Penguin Study Software,1984) Educational

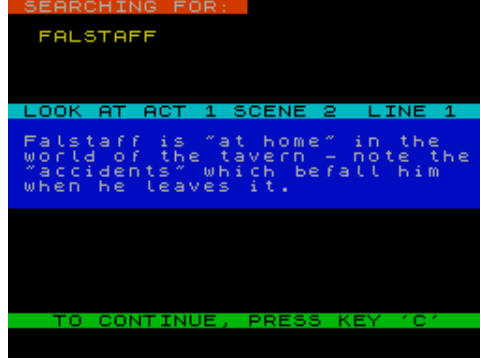

Shakespeare - Merchant of Venice (Penguin Study Software,1984) Educational



Shaky Game, The (Olympic Software,1983)

Arcade

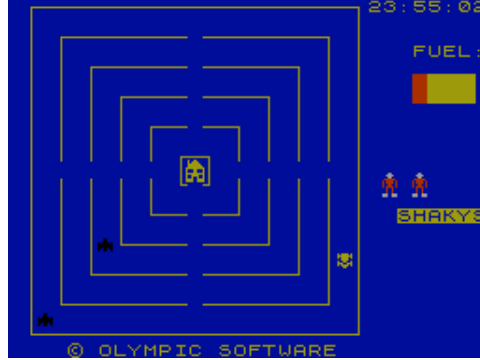

Shao-Lin's Road (The Edge Software,1986)

Arcade



Shake (Keep Publishing,1987)

Arcade

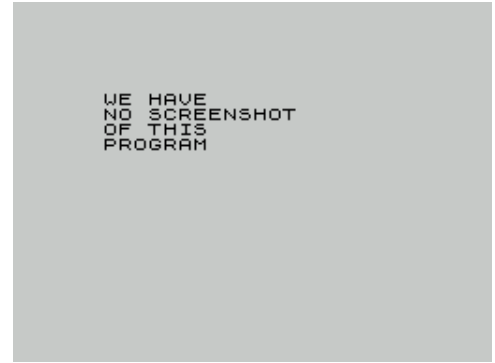

Shakespeare - Julius Caesar (Penguin Study Software,1984)

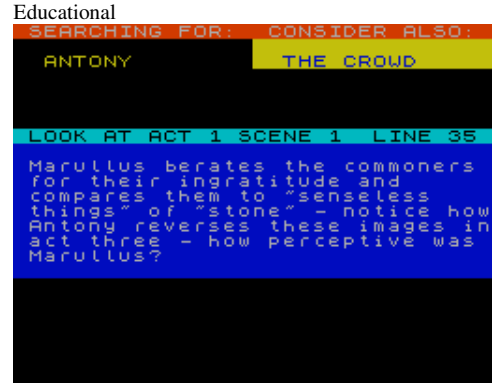

Shakespeare - Romeo and Juliet (Penguin Study Software,1984) Educational



Shanghai Karate (Players Software,1988)

Arcade



Shape Sort (Widgit Software Ltd,1983)

Educational

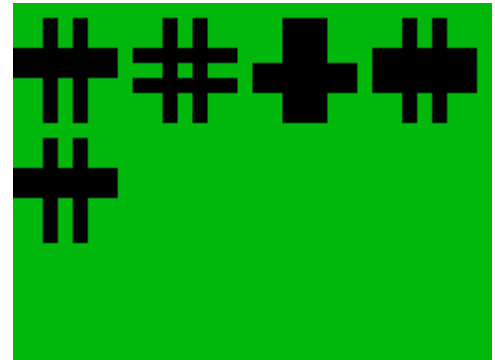

Shape Sorter (Widgit Software Ltd,1983)
Compilation

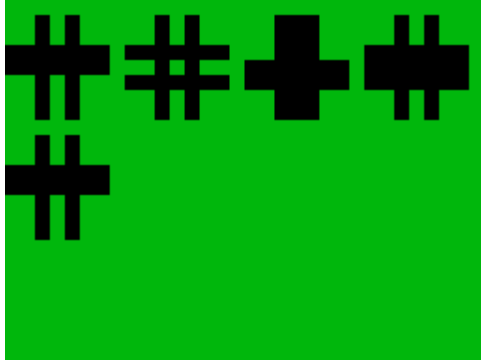

Shares (Cottage,1987)
Utility



Sharkey's Moll (Zeppelin Games Ltd,1991)
Arcade



Shaws III (Gadtek Games,1995)
Arcade



Shedmaster Finsbury Park (Dee-Kay Systems,1989)
Simulation

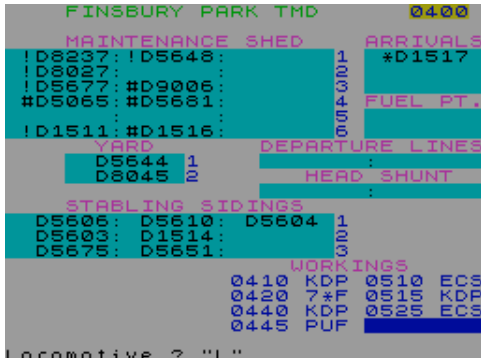

Shard of Inovar (Bulldog,1987)
Arcade Adventure



Shark (Players Premier Software,1989)
Arcade

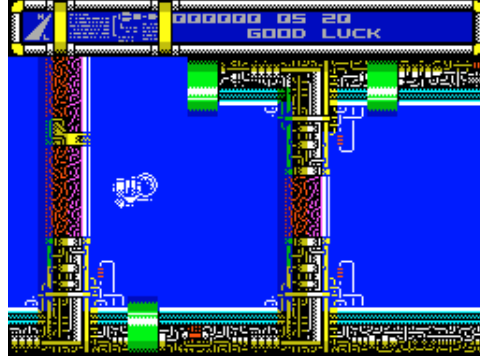

Sharpshooter (Games Machine Ltd.)
Arcade



Shazma Plasma (Sinclair User,1984)
Arcade

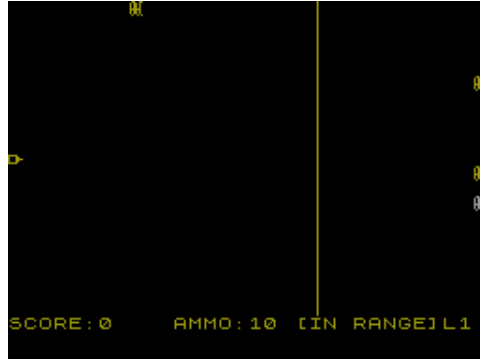

Sheepdog (Fontana Publishing,1982)
Arcade



Share Bizz (.)
Strategy



Shark Attack (Romik Software,1983)
Arcade



Sharpshooter (KobraSoft,1987)
Arcade



Shedmaster Bounds Green (Dee-Kay Systems,1987)
Simulation

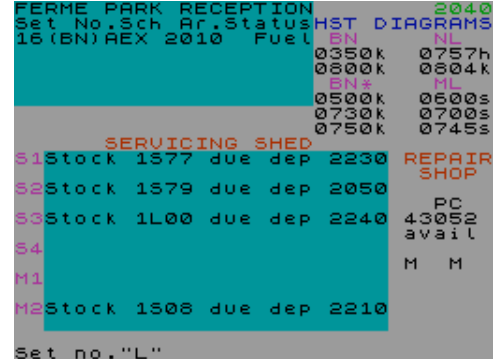

Sheep Dog (Sinclair Programs,1984)
Arcade



Sheepdog Champion (Fontana Publishing,1982)
Arcade

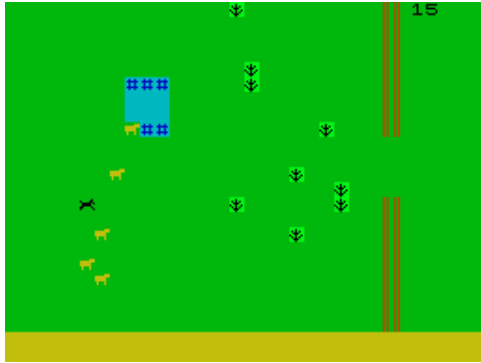

Sheerluck Holmes and Dr. Witsend (Speccysoft,1987)
Text Adventure



Sherezade (MicroHobby,1985)
Arcade



Sherlock (Melbourne House,1984)
Text Adventure

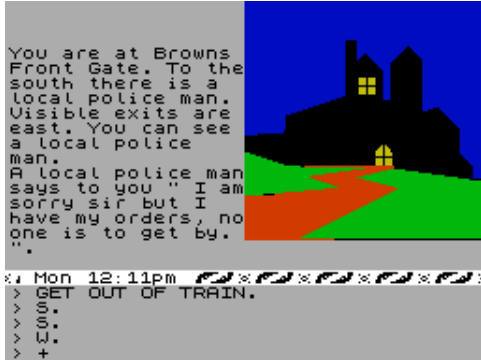

Sherlock Holmes: The Lamberley Mystery (Zenobi Software,1990) Text Adventure

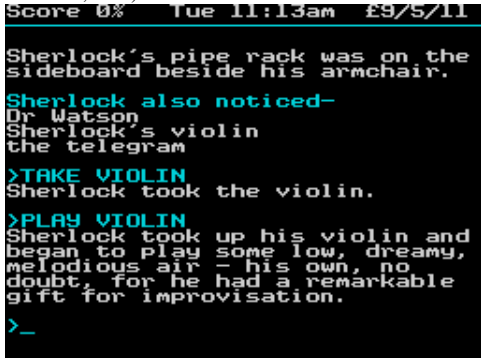

Sheepdog Trials (Granada Publishing,1983)
Arcade

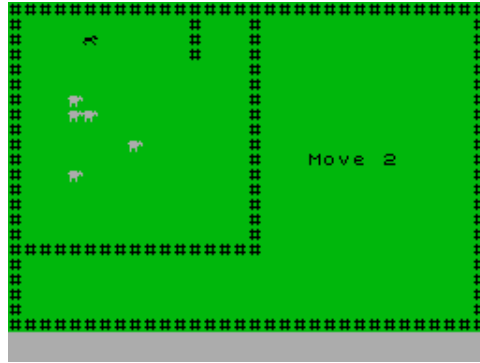

Sheer Panic (Visions Software Factory,1983)
Arcade

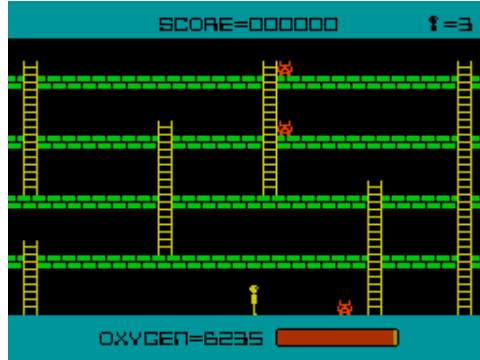

Sheriff (Antonio de Haro Leon,1989)
Text Adventure



Sherlock Holmes: A Matter of Evil (Creative Juices,1988)
Text Adventure



Sherlock Holmes: Traja Garridebovia (Sybilasoft,1987)
Text Adventure



Sheepwalk (Virgin Games Ltd,1983)
Arcade

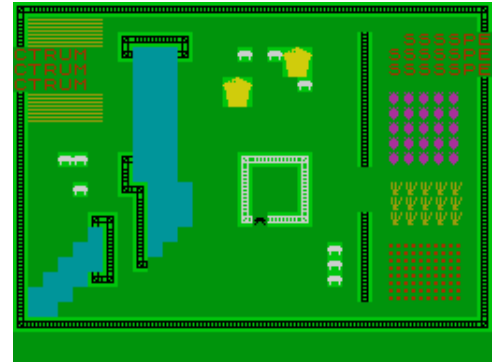

Shellshock (Corrupt Code,1989)
Text Adventure

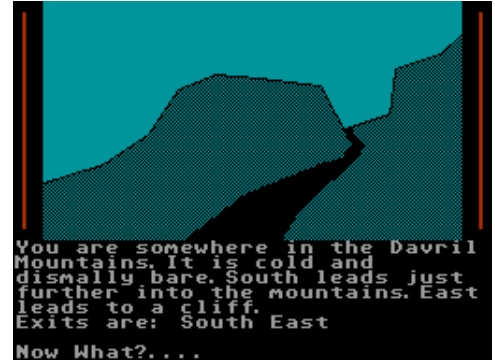

Sherlock (Kamasoft,1988)
Utility

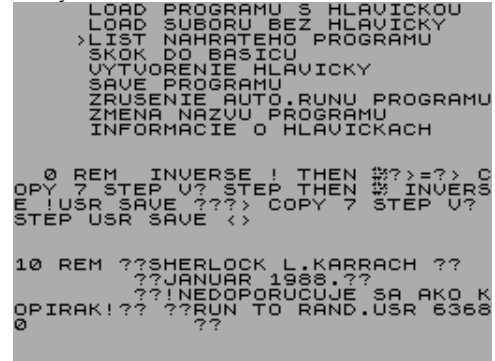

Sherlock Holmes: The Case of the Beheaded Smuggler (Mental Images,1988) Text Adventure



Sherwood (Ultrasoft,1992)
Arcade Adventure



Sherwood Forest (Delta 4 Software,1984)

Text Adventure

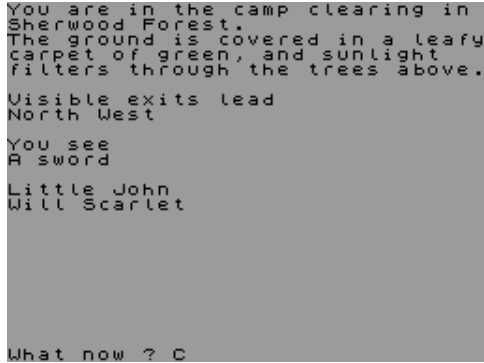

Shibenitsa (Taras,2000)

Board/Card Game



Shift Screen\$ (Your Sinclair,1988)

Utility: Screen Manipulation

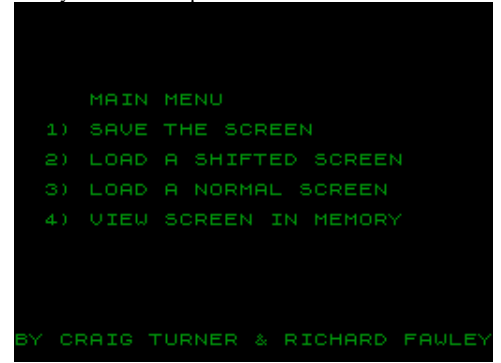

Shift Shaft (CCS,1985)

Arcade

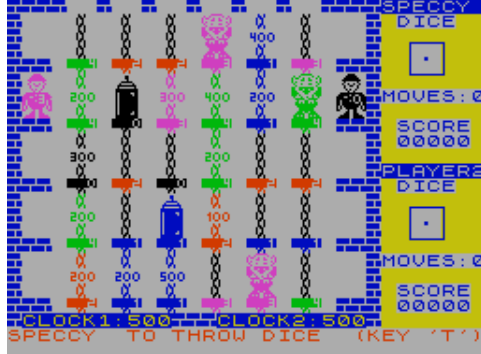

Shifty (Work Force,1983)

Utility: Word Processor

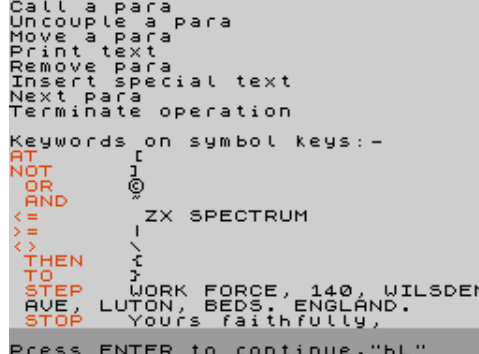

Shimmerkin (Adventure Probe Software,)

Text Adventure

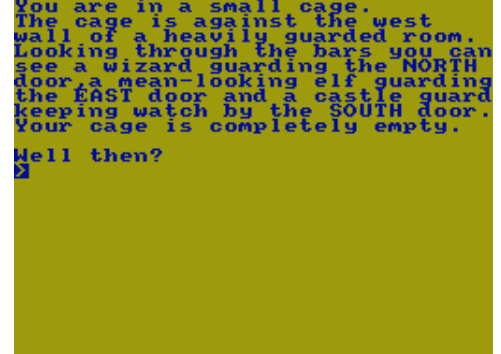

Shinning in the Darkness (Alien Software,1993)

Text Adventure

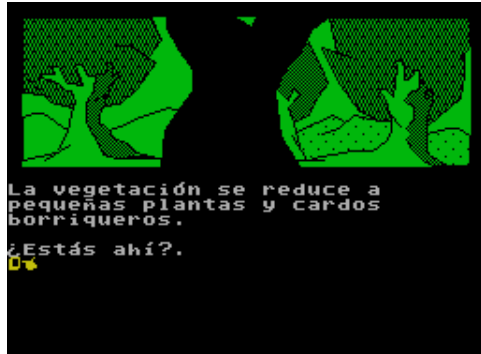

Shinobi (Virgin Games Ltd,1989)

Arcade



Ship (SPE,1986)

Arcade



Ship of the Line (Richard Shepherd Software Ltd,1982)

Text Adventure

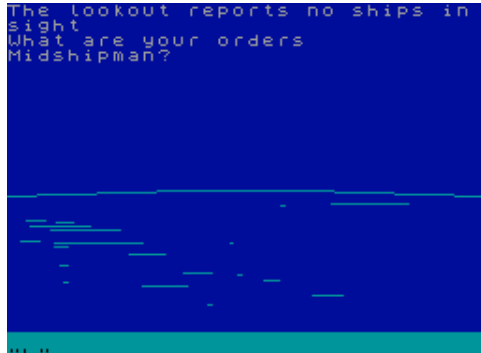

Ships (J. Cichorski,1984)

Arcade

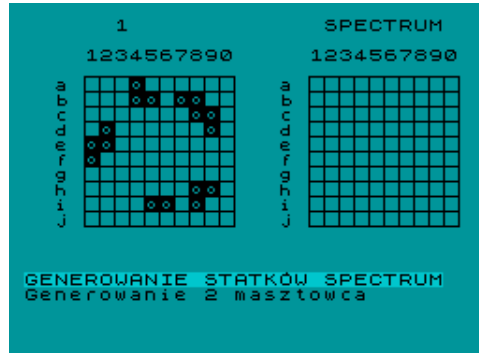

Shipwreck (Tartan Software,1987)

Text Adventure



Shipwreck + Castle Eerie (Tartan Software,1987)

Compilation



Shock (ESI,1992)

Scene Demo



Shock Megademo (ESI,1992)

Scene Demo

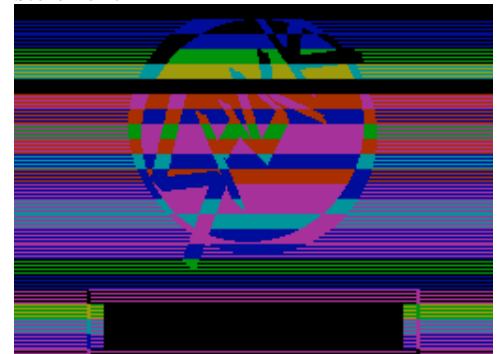

Shock Wave (Impulse Software,1983)
Arcade



Shockway Rider (Faster Than Light,1987)
Arcade

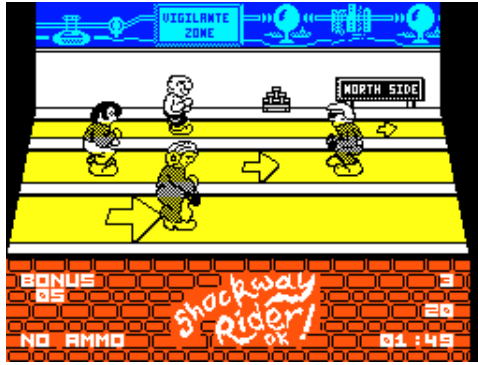

Shoe People, The (Gremlin Graphics Software Ltd,1992)
Arcade

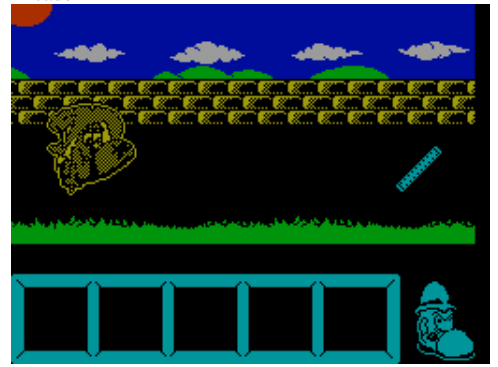

Shoot! (Spectrum Computing,1984)
Arcade



Shootacular (Alternative Software Ltd,1988)
Compilation

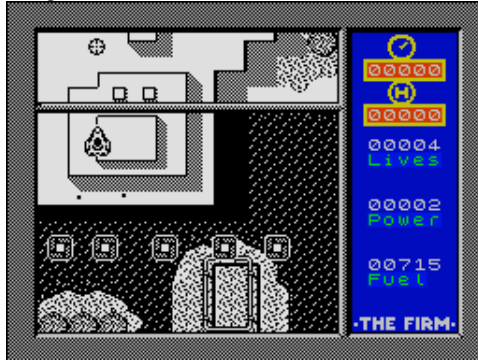

Shoot 'em Down (Bo Jangeborg.)
Arcade



Shooting Gallery (Stack Computer Services Ltd,1983)
Arcade

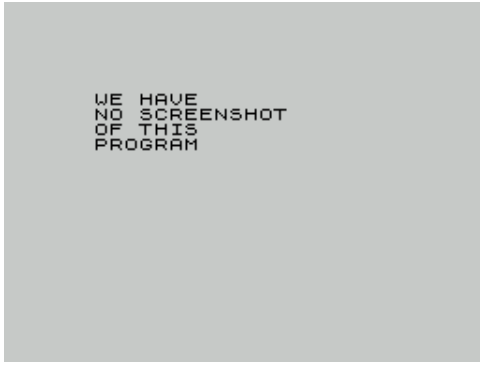

Shooting Gallery (Your Spectrum,1985)
Arcade

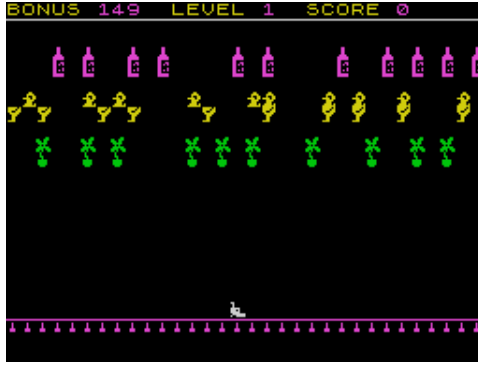

Shooting Range: Mix I (New Frontier.)
Arcade



Shoot-Out (Martech Games Ltd,1989)
Arcade



Shoot Out (Your Spectrum,1985)
Arcade



Short Circuit (Ocean Software Ltd,1987)
Arcade Adventure



Short Circuit (Your Sinclair,1986)
Arcade

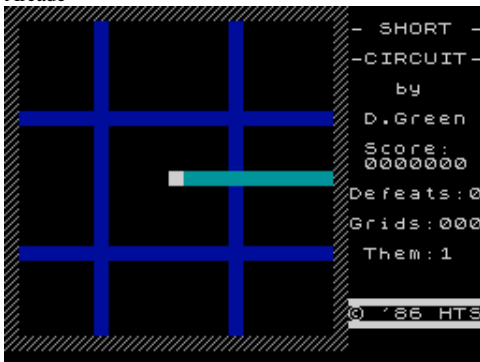

Short Demo 1 (Mad Max,)
Scene Demo

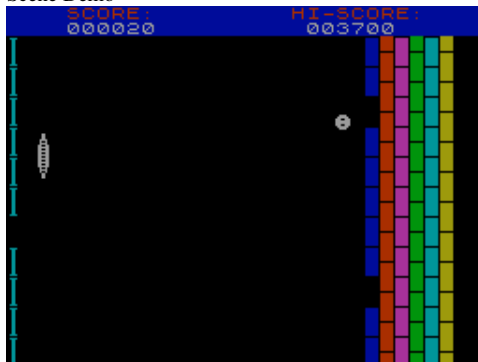

Short Demo 2 (Mad Max,)
Scene Demo



Short Memory Test (.)
Utility

Short's Fuse (Firebird Software Ltd,1986)
Arcade

Short Vowel Sounds (Sherston Software,1983)
Educational

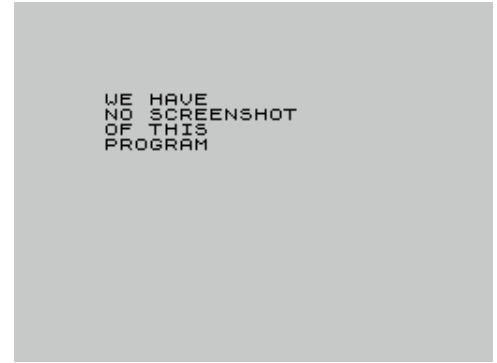

Shot (Jacek Michalak Software,1989)
Arcade

Shouter (,1986)
Arcade

Shove a Sledge (Gremlin Graphics Software Ltd,1987)
Arcade

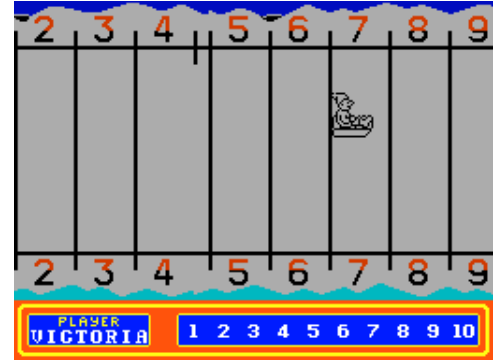

Shove Off (Jonathan Cauldwell,1990)
Arcade

Show, 3D (Jacek Michalak,)
Scene Demo

Showdown (Artic Computing Ltd,1983)
Arcade

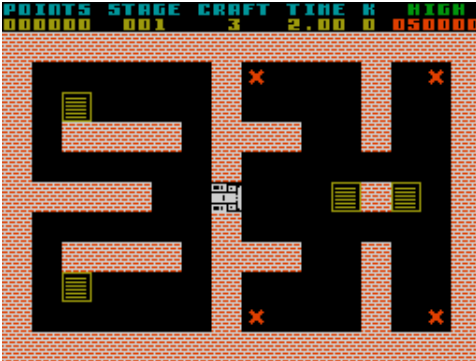

Showjump (IMS Software,1984)
Sport

Show Jumping (Alligata Software Ltd,1986)
Sport

Shrewsbury Key (Players Software,1986)
Text Adventure

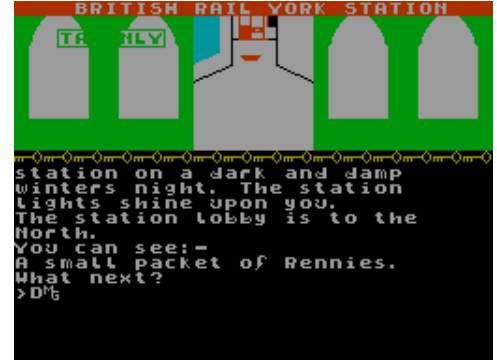
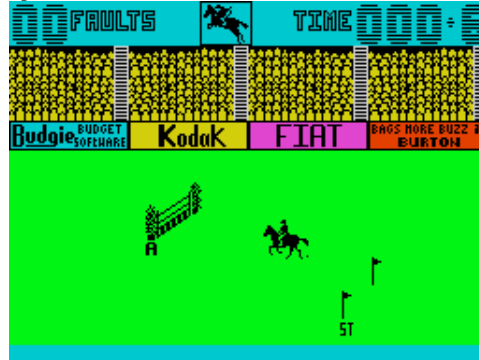

Shuriken (Crash,1989)
Arcade

Shurk (Jaime Tejedor Gomez,1991)
Arcade

Shut the Box (Spectrum Computing,1983)
Board/Card Game

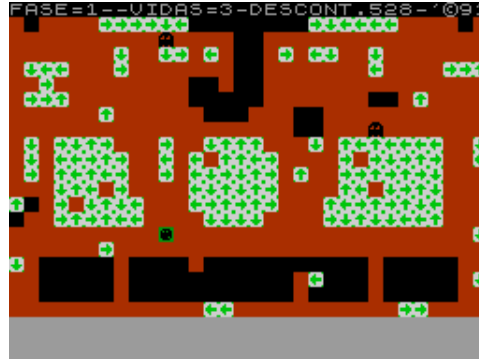

Shut the Boxes (16/48 Tape Magazine,1984)
Board/Card Game

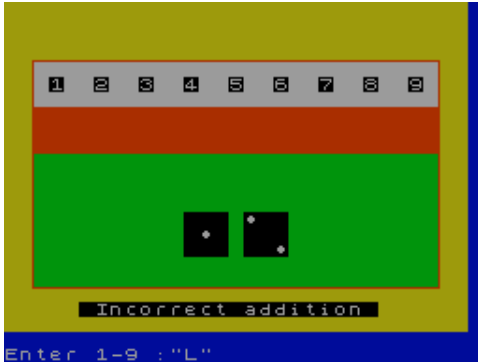

Shuttle Shock (Software Super Savers Ltd,1984)
Arcade

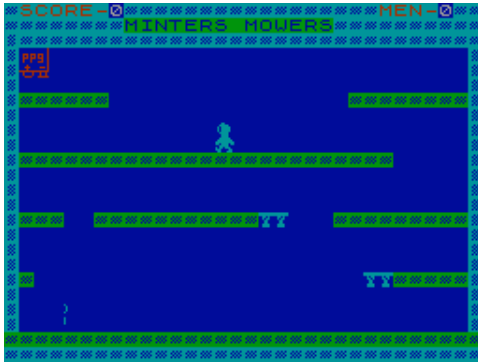

Side Arms (Go!,1988)
Arcade

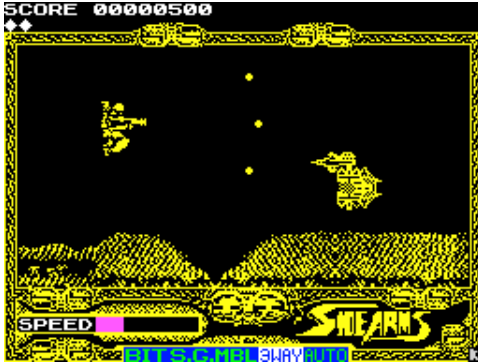

Sidewalk (Infogrames,1987)
Arcade Adventure



Sidewize (Firebird Software Ltd,1987)
Arcade

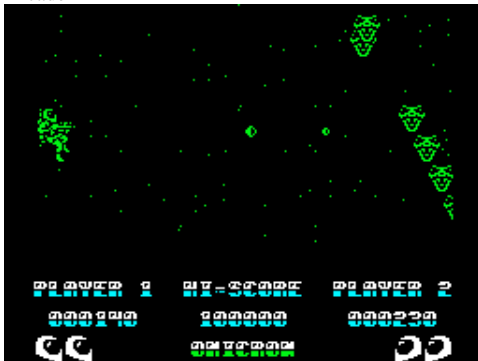

Shuttle (Blaby Computer Games,1983)
Arcade

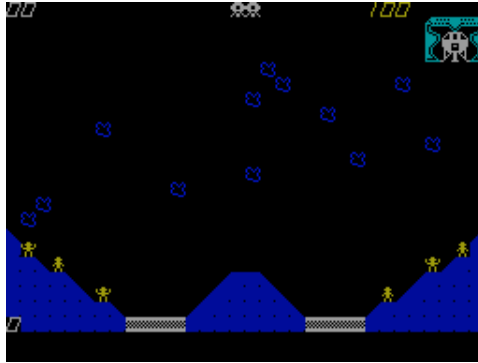

SIDA (Alfonso Fernandez Borro,)
Arcade

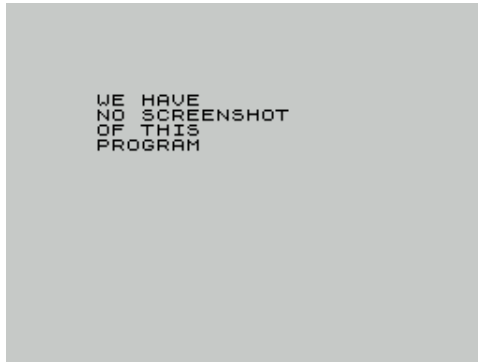

Side Print (.)
Utility: Screen Manipulation

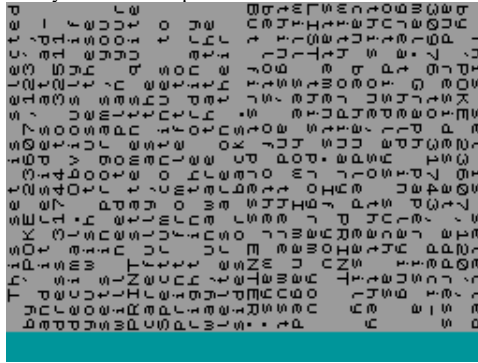

Sideways Look (Spectrum Computing,1983)
Utility



Sidney Affair, The (Infogrames,1987)
Text Adventure

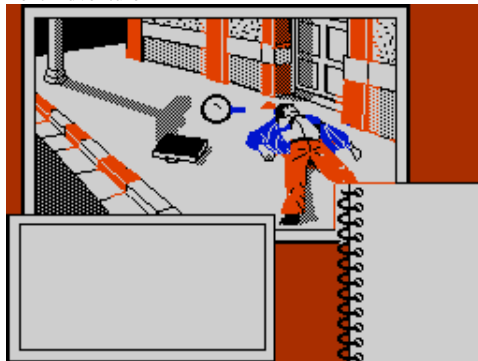

Shuttle Master (Sinclair Programs,1983)
Arcade



SIDA + Cronos (Alfonso Fernandez Borro,)
Compilation



Sideral War (Delta Software,1990)
Arcade



Sidewinder II (Mastertronic Plus,1989)
Arcade

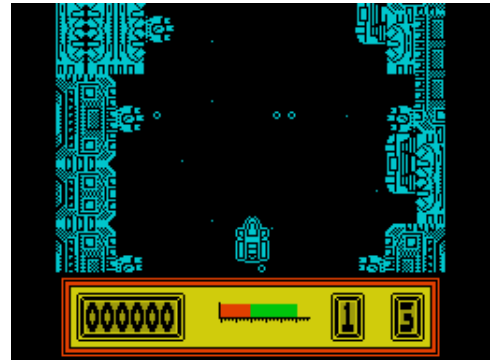

SID - Semi-Intelligent Drone (Piranha,)
Arcade



Siege (Postern,1983)
Arcade

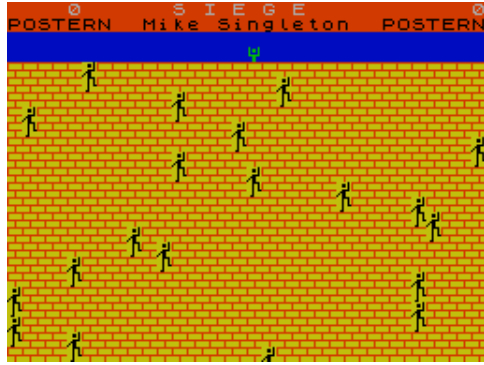

Siete y Media (MicroHobby,1985)
Board/Card Game



Sigfrido (MicroHobby,1986)
Arcade



Signal Part 1 (Mikropol,1989)
Scene Demo



Silent Shadow (Topo Soft,1988)
Arcade

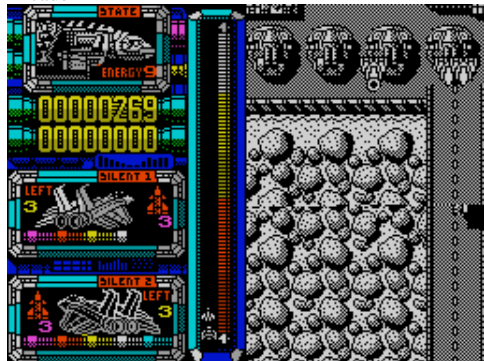

Siege (Sinclair Programs,1983)
Arcade

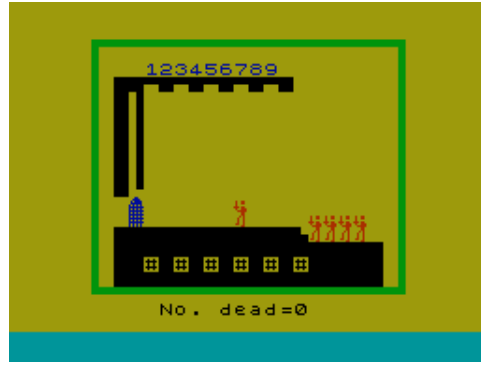

Siete y Medio (Ediciones y Textos S.A.,1985)
Board/Card Game



Sigfrido (New Frontier,1987)
Arcade

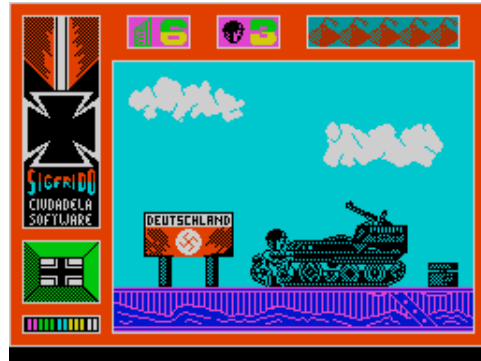

Signal Part 3 (Mikropol,1992)
Scene Demo



Silhouette (Sinclair Research Ltd,1982)
Arcade



Siege on the Volga (Omega Games,)
Strategy



Siete y Medio (Load 'n' Run [Spa],1985)
Board/Card Game



Sigma 7 (Durell Software Ltd,1987)
Arcade



Silent Service (Microprose Software Ltd,1986)
Arcade

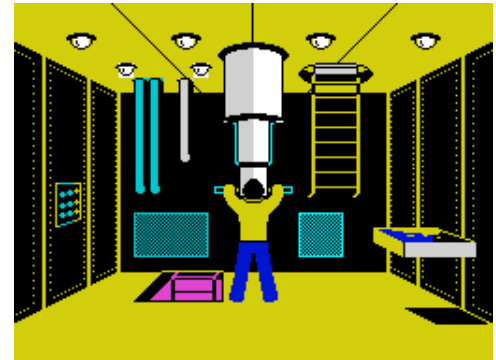

Silicon Dreams (Rainbird Software Ltd,1986)
Compilation

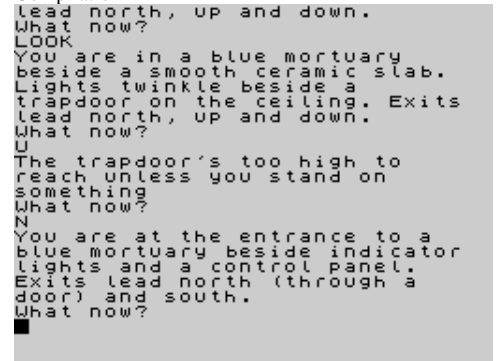

Silkworm (Virgin Games Ltd,1989)
Arcade



Silly Demo 1 (The Lords,1989)
Scene Demo



Silverwolf (Zenobi Software,1992)
Text Adventure



Simeon (Data Design Systems,1986)
Board/Card Game

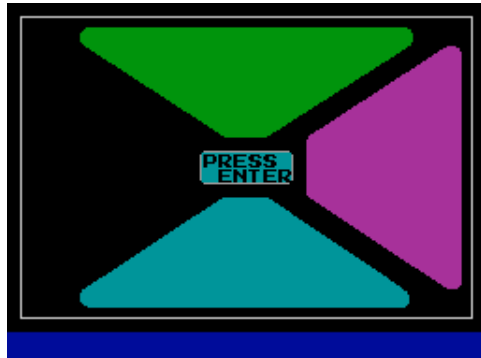

Simon (BH'Soft,)
Board/Card Game

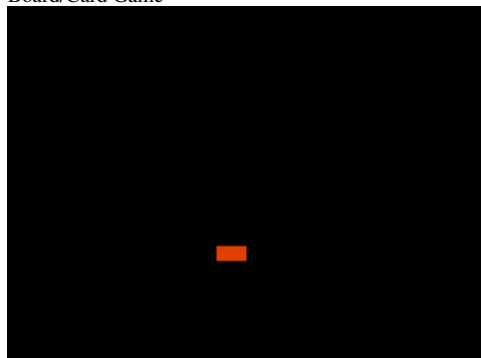

Silly Adventure Number One (D.R. Stone,)
Text Adventure

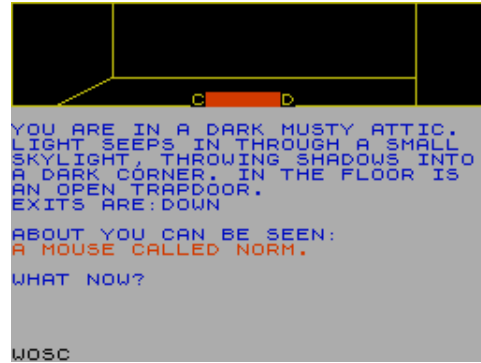

Silver Gun (MicroHobby,1988)
Arcade



Silvestrovska Pecka (Proxima Software,1992)
Text Adventure

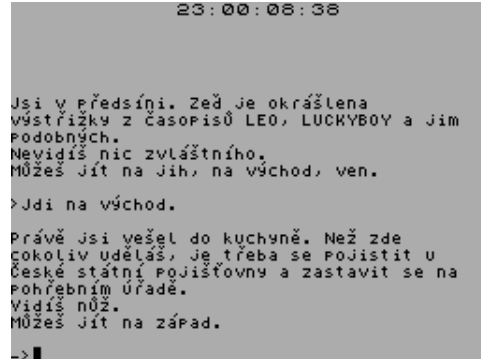

Simeon (Spectrum Computing,1985)
Board/Card Game



Simon (Ediciones y Textos S.A.,1985)
Educational



Sillycon War, The (Maz H. Spork,1985)
Arcade Adventure

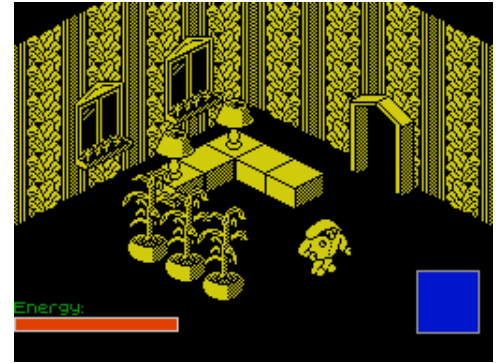

Silversword: La Espada de Plata (.)
Text Adventure



Sim City (Infogrames,1990)
Strategy

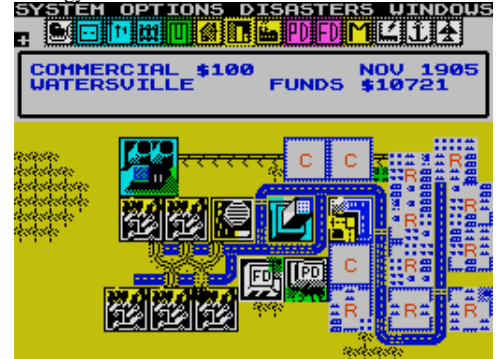

Simon (.)
Board/Card Game



Simon [1] (MicroHobby,1984)
Board/Card Game



Simon [2] (MicroHobby,1986)
Board/Card Game



Simon Games 2 (Simon Software,1984)
Educational



Simon Micro-Soft - Collection One (Simon Micro-Soft,1982)
Compilation

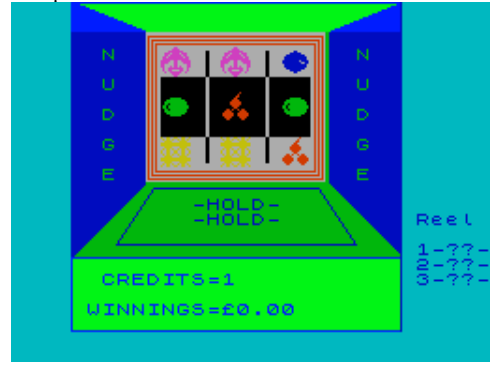

Simon Micro-Soft - Collection Two (Simon Micro-Soft,1982)
Compilation



Simon Said (Virgin Books,1983)
Arcade



Simon Saw (Touchmaster Ltd,1984)
Educational



Simon Says (Touchmaster Ltd,1984)
Educational



Simon's Shapes (Touchmaster Ltd,1984)
Educational



Simple Arithmetic (Camel Micros,1983)
Educational



Simple Business Accounts (Flowchart Ltd,1984)

Utility: Database

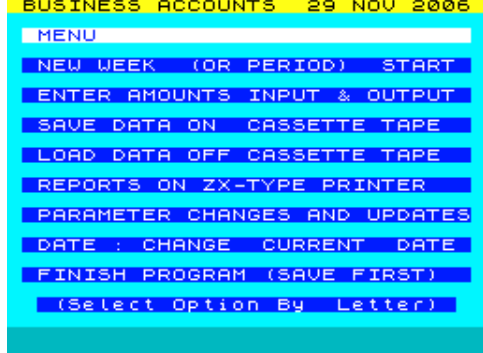

Simple Case of Espionage, A (Skyslip Software,1988)

Text Adventure



Simple Word Processor (Hilderbay Ltd,1983)

Utility: Word Processor

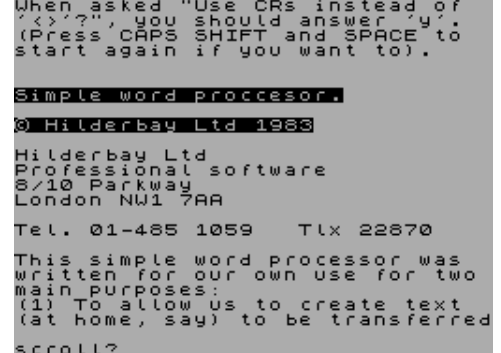

Simplex (SuperSoft [2],1998)

Arcade

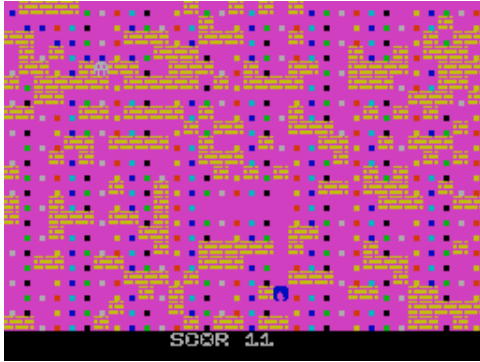

Simpsons: Bart vs. the Space Mutants, The (Ocean Software Ltd,1991)

Arcade Adventure



Simulacion de Orbitas Planetarias (MicroHobby,1986)

Utility



Simulador de Control de Procesos (Ingenieria Quimica,)

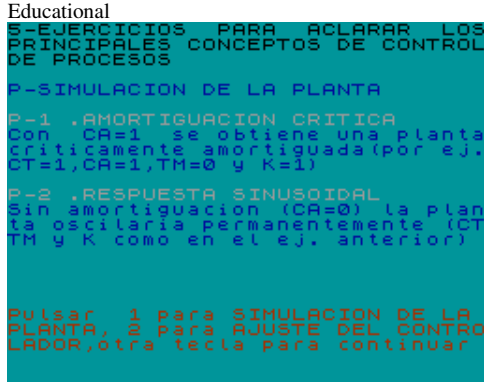

Sinbad (Atlantis Software Ltd,1983) Arcade

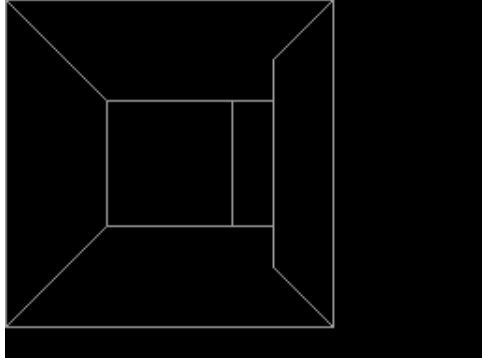

Sinclair Action Pack - Lightgun Games (Sinclair Research Ltd,1989) Compilation



Sinclair Casino (Data-Skip Software,1985) Arcade



Sinclair User Club issue 01 (Sinclair User,) Covertape



Simulador Profesional de Tenis (Dinamic Software,1990) Sport

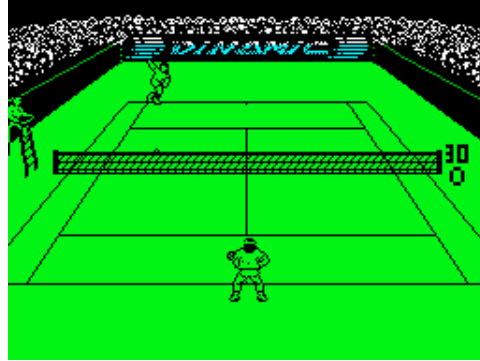

Sinbad and the Golden Ship (Mastervision,1986) Text Adventure



Sinclair-Basic (Stephan Slabihoud,1986) Utility: BASIC Related



Sinclair Game Compilation (Sinclair Research Ltd,1988) Compilation



Sinclair User Club issue 02 (Sinclair User,) Covertape



Simulation Hits (Loriciels,1989) Compilation



Sinclair 128K to 8056 Serial Printer (.) Utility



Sinclair Basic Teacher (Mladen Erjavec,) Simulation



Sinclair Logo (Sinclair Research Ltd,1984) Utility: Programming

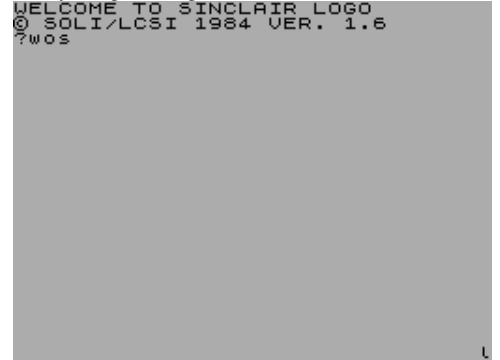

Sinclair User Club issue 03 (Sinclair User,) Covertape



Sir Fred (Made in Spain,1986)
Arcade Adventure



Sir Lancelot (Melbourne House,1984)
Arcade



Sirwood (Opera Soft S.A.,1990)
Arcade Adventure



Sistemas Elementales (MicroHobby,1986)
Educational



S.I.T.I. (Ventamatic,1984)
Utility

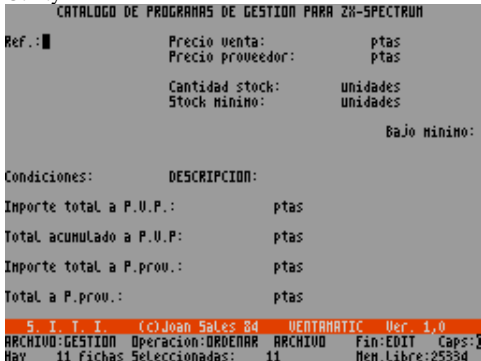

Sirius (MicroHobby,1986)
Arcade

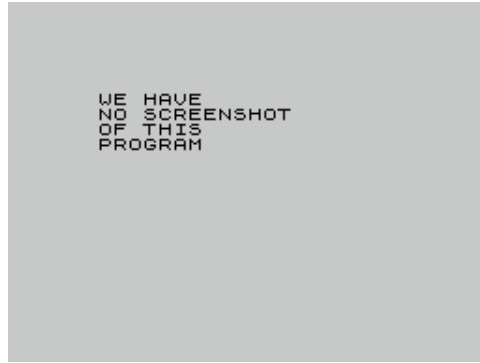

Sir Loin (Silverbird Software Ltd,1987)
Arcade Adventure

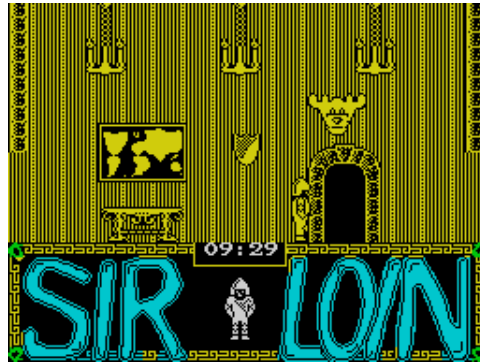

Sistemas de Ecuaciones (MicroHobby,1984)
Utility: Mathematics



Sistemas No Lineales (MicroHobby,1986)
Educational



S.I.T.I. Calc (Ventamatic,1985)
Utility

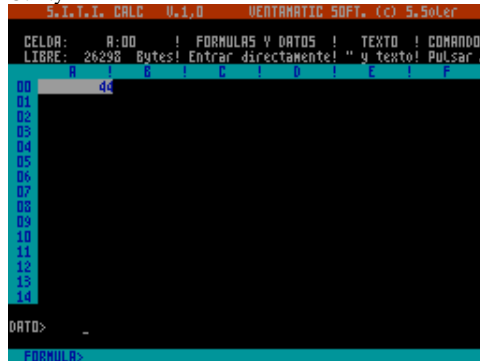

Sir Knight (Dmitriy Zhivilov,1991)
Arcade

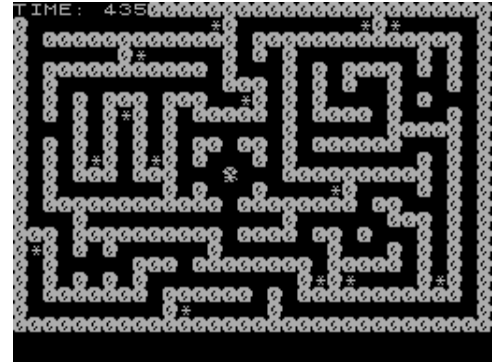

Sir Sigfrid (Luis I. Garcia Ventura,1986)
Text Adventure



Sistemas de Inecuaciones (MicroHobby,1986)
Educational



Sistema Solar (MicroHobby,1985)
Educational



Sito Pons 500cc Grand Prix (Zigurat Software,1990)
Arcade

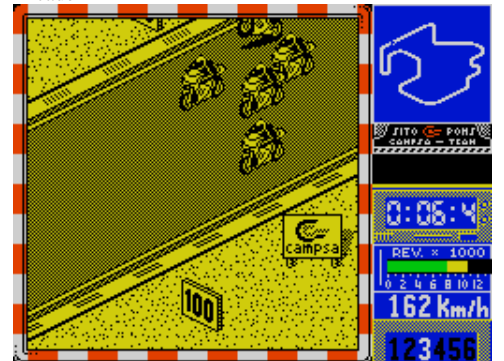

Six Appeal (Ubi Soft Ltd,1991)
Compilation



Skabet (JC Jumbo Data,1985)
Text Adventure

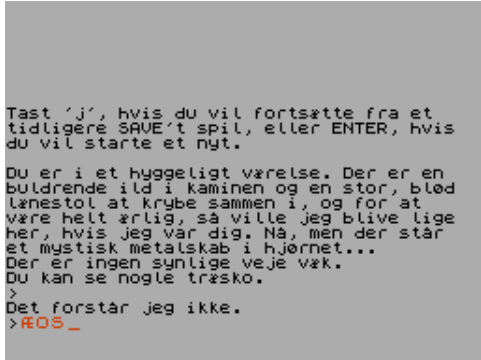

Skateboard Joust (Silverbird Software Ltd,1989)
Arcade

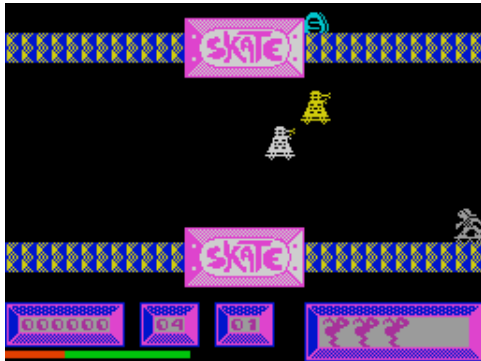

Skate Crazy (Gremlin Graphics Software Ltd,1988)
Arcade



Skatin' USA (Atlantis Software Ltd,1989)
Arcade

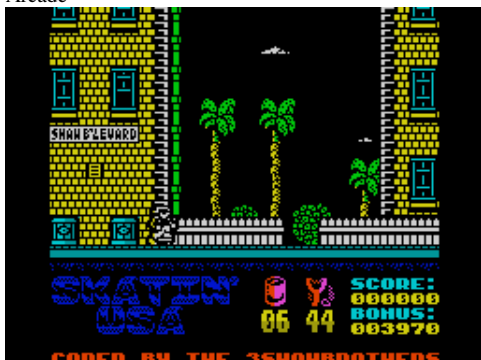

Six Card Cribbage (Esem Software,1987)
Board/Card Game



Skateball (Ubi Soft Ltd,1988)
Arcade

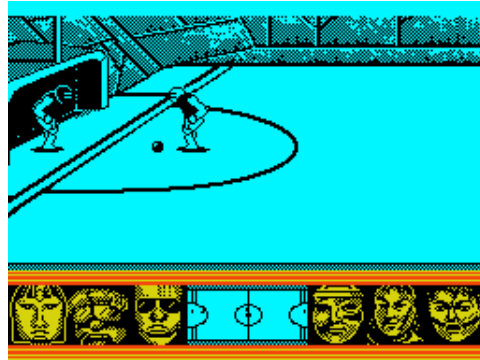

Skateboard Kidz (Silverbird Software Ltd,1988)
Arcade



Skate or Die (Electronic Arts,1989)
Arcade

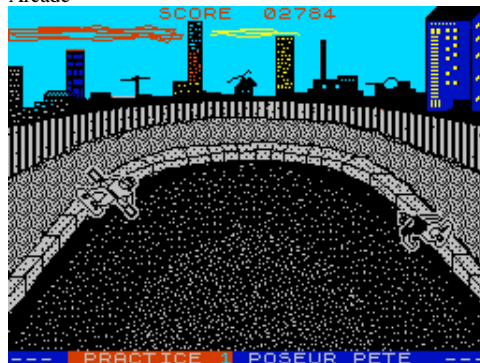

Skatteberegning (ZX Data,1984)
Utility

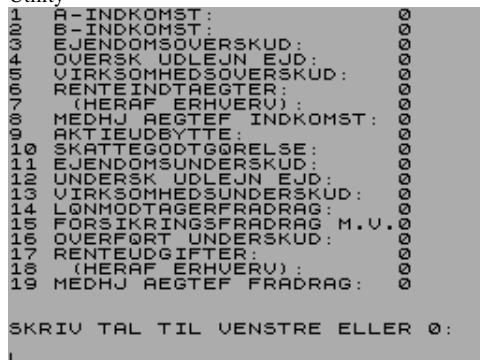

Size Sorter (Widgit Software Ltd,1983)
Educational

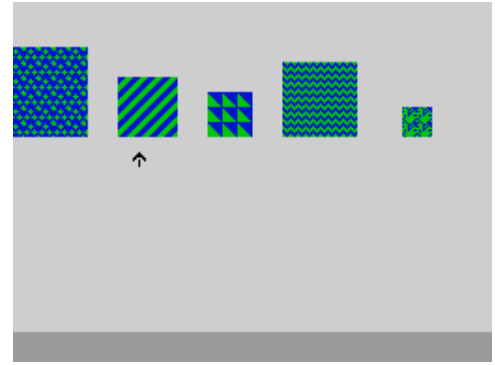

Skateboard Construction System (Players Software,1988)
Arcade

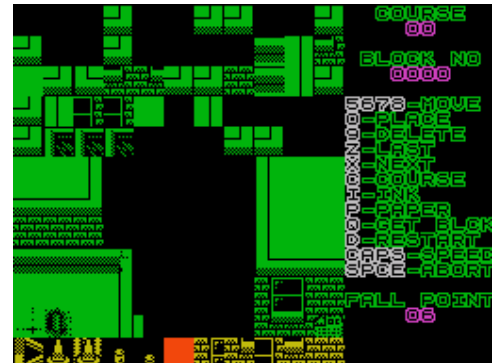

Skateboard Stuntman (Sinclair Programs,1984)
Arcade



Skate Wars (Ubi Soft Ltd,1990)
Arcade

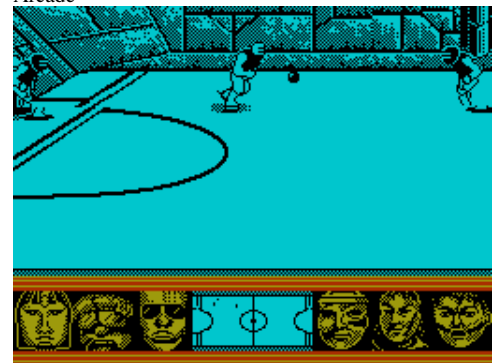

Skelby - The Schizophrenic Droid (Q Bit,1984)
Arcade



Skeleton (Jon North,1990)
Utility



Sketch4 (16/48 Tape Magazine,1984)
Utility: Drawing



Skirmish (MAS,1994)
Arcade



Ski Star 2000 (Richard Shepherd Software Ltd,1985)
Arcade

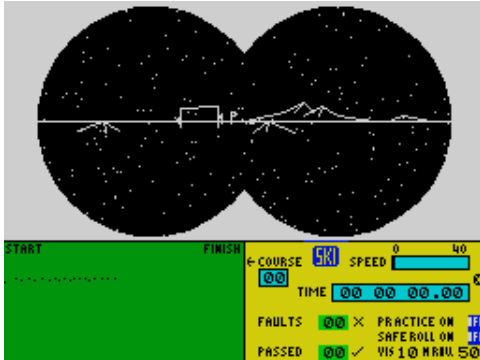

Skool Daze (Microsphere,1985)
Arcade

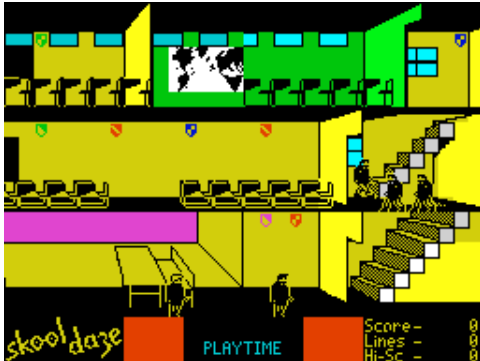

Skeleton Dance (WoMo-Team,1996)
Scene Demo



Ski Acuatico (MicroHobby,1985)
Arcade



Ski-Run (Spectrum Computing,1985)
Arcade



Skittles (Sinclair Research Ltd,1982)
Arcade



Skuldugery (K'Soft Ltd,1987)
Arcade



Skelvullyn Twine (8th Day Software,1986)
Text Adventure



Ski Master (C&VG,1985)
Arcade

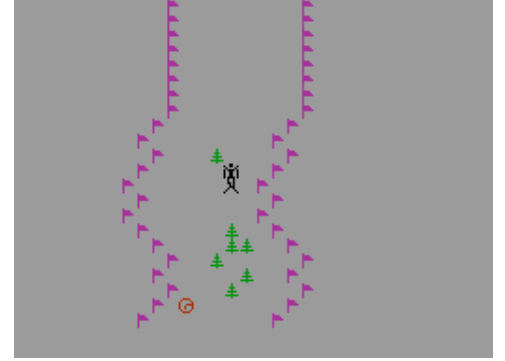

Ski Run (ZX Computing,1983)
Arcade



Skladacka (Deltasoft,1989)
Arcade



Skull (Games Machine Ltd,1984)
Arcade

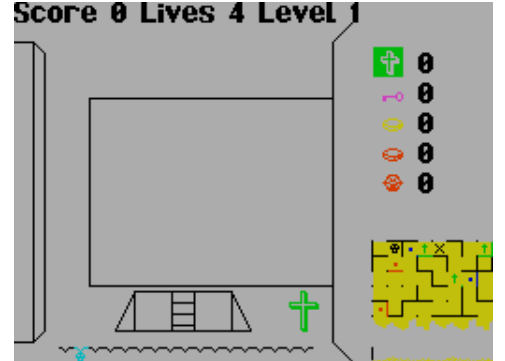

Skull & Crossbones (Domark Ltd,1991)
Arcade

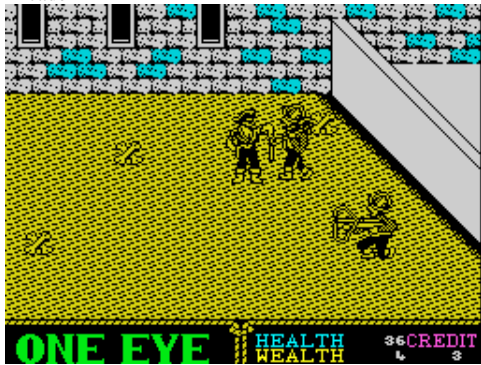

Sky 128K III (Hacker Chris,1988)
Scene Demo



Sky Diver (Scele & Ufo Software,1983)
Arcade



Sky High Stuntman (Code Masters Ltd,1991)
Arcade

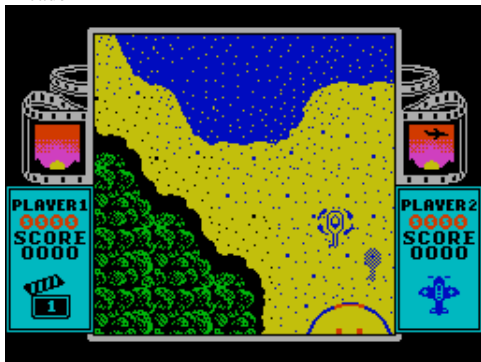

Sky Runner (Cascade Games Ltd,1987)
Arcade



Sky 128K (Hacker Chris,1988)
Scene Demo



Sky 128K IV (Hacker Chris,1988)
Scene Demo



Sky Fight (16/48 Tape Magazine,1984)
Arcade

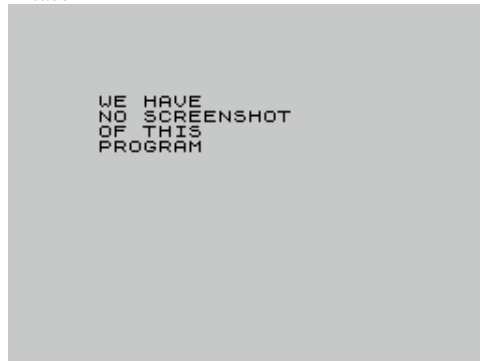

Skyline Extended Basic (Ionis Software International,1984)
Utility



Sky Search (Spidersoft,1986)
Arcade



Sky 128K II (Hacker Chris,1988)
Scene Demo



Sky Diver (Micro Press [1],1983)
Arcade



Skyfox (Ariolasoft UK Ltd,1985)
Arcade



Sky Ranger (Microsphere,1986)
Arcade

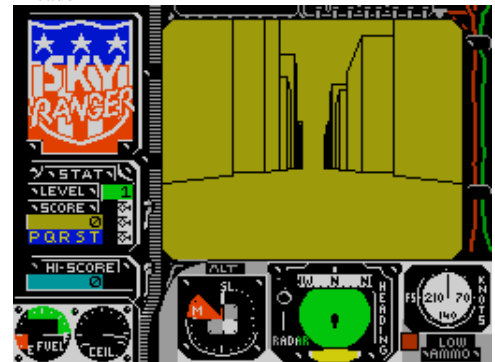

Sky Spiders (XFAWORLD Software,2004)
Arcade



Skyview (Mira Software,1986)
Utility

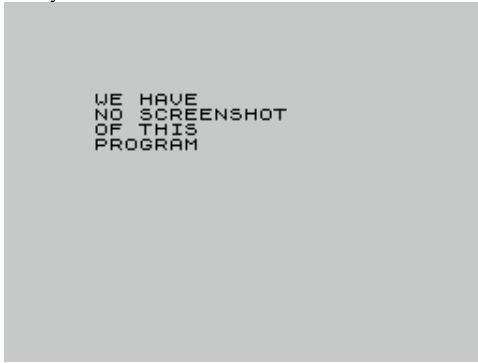

Sky Warrior (Reelax Games,1985)
Arcade



SL3 Advanced Speedloader (Kobrahssoft,1987)
Utility: Copier



SL4 Advanced Speedloader (Kobrahssoft,)
Utility: Copier



SL4 Super Speedloader (Kobrahssoft,)
Utility: Copier



Slab Age (THD,1993)
Arcade

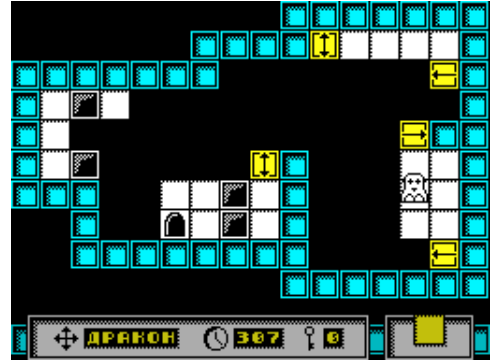

Slack Bladder (Moonchild Software,)
Text Adventure



Slaine, the Celtic Barbarian (Martech Games Ltd,1987)
Arcade Adventure



Slap Dab (Anirog Software,1983)
Arcade



Slap Fight (Imagine Software Ltd,1987)
Arcade

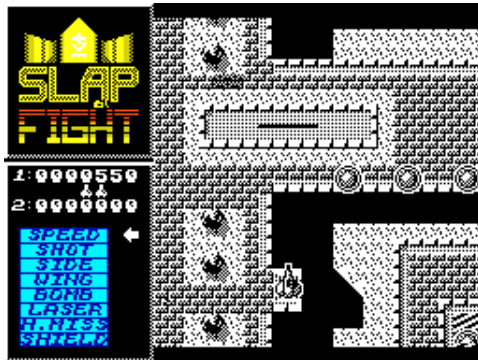

Slap-Slop (Woody,)
Arcade



Slaughter Caves (Zenobi Software,1989)
Text Adventure

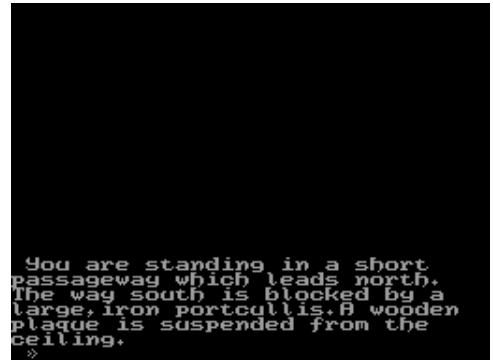

Sleepin' Again (The Adventure Workshop,1996)
Text Adventure



Sleep Walker (Zeppelin Games Ltd,1992)
Arcade Adventure



Slicer 2 (Hartmut Seba,1984)
Utility

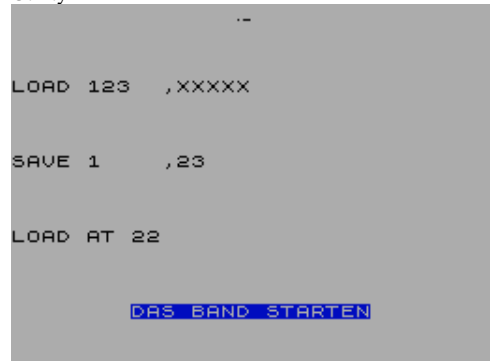

Slicker Puzzle (DK'Tronics Ltd,1983)
Board/Card Game



Sliders (MSD Group,2000)
Arcade Adventure



Slime, 3D (Datalink,1986)
Arcade



Slippery Sid (Silversoft Ltd,1983)
Arcade

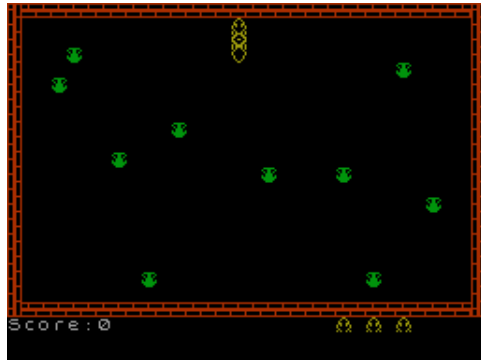

Slowglass Leader (Slowglass,1986)
Utility

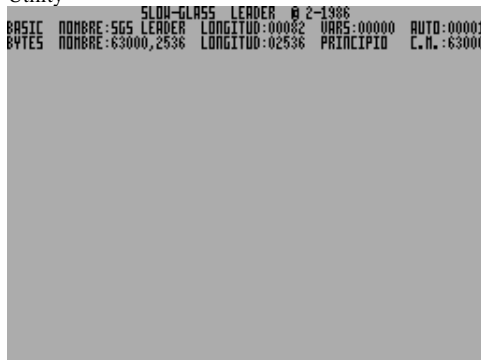

Slicks (Code Masters Ltd,1992)
Arcade

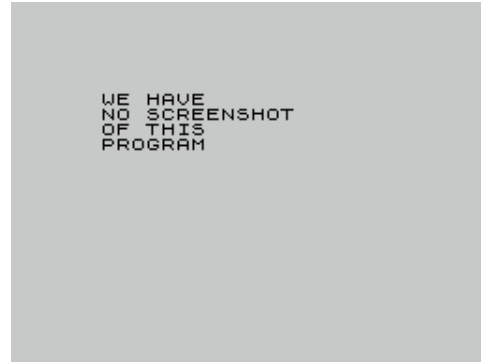

Slightly Magic (Code Masters Ltd,1991)
Arcade Adventure



Slingshot (The Power House,1987)
Arcade



SlowDOS (Dominic Morris,1997)
Utility

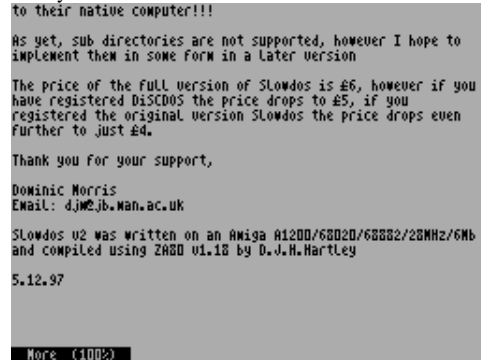

Slow Scan Television (G4OIK/G4OIL,1986)
Utility

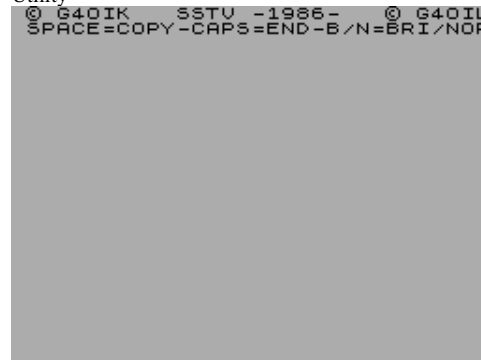

Slide Puzzle (G. Nunney,)
Board/Card Game



Slightly Manic (The Manic Hacker,1992)
Arcade

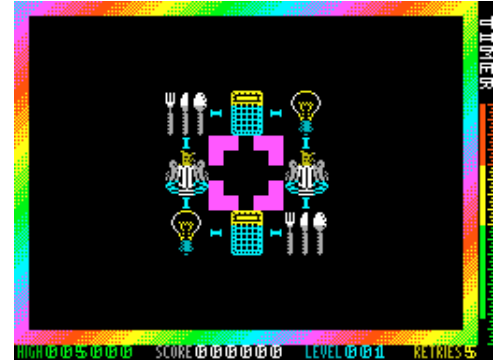

Slippery Sam (Dymond Software,1983)
Board/Card Game



Slowglass (Slowglass,1990)
Arcade

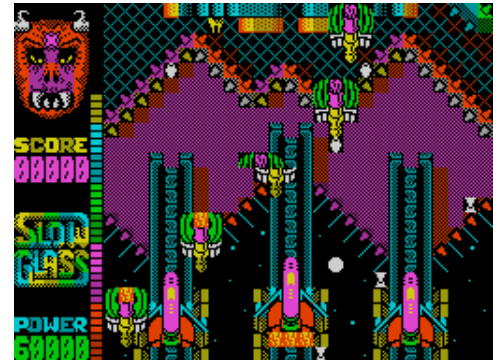

Slug (Alternative Software Ltd,1988)
Arcade



Sly Spy: Secret Agent (Ocean Software Ltd,1990)
Arcade Adventure

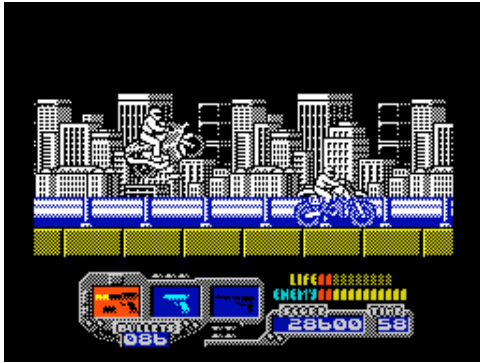

Smagly 2 (Crystal Dream,1996)
Arcade Adventure



Small 1 (The United Minds/Extacy-3,1995)
Scene Demo



Smash 16 (Code Masters Ltd,1993)
Compilation



Smash Out! (Pirate Software Ltd,1987)
Arcade

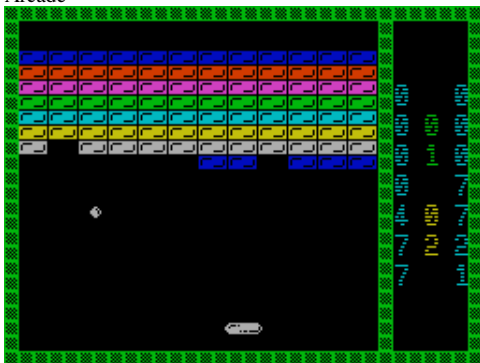

SM1 Multiface Suite (Kobrahsot.)
Utility



Smagly 3: Or Kill'em All! (CryptoGraphics,2000)
Arcade



Small Business Accounts (Sinclair Research Ltd,1983)
Utility: Spreadsheet

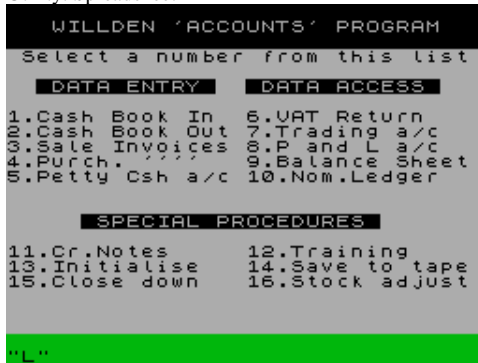

S.M.A.S.H.E.D. (Alternative Software Ltd,1987)
Text Adventure

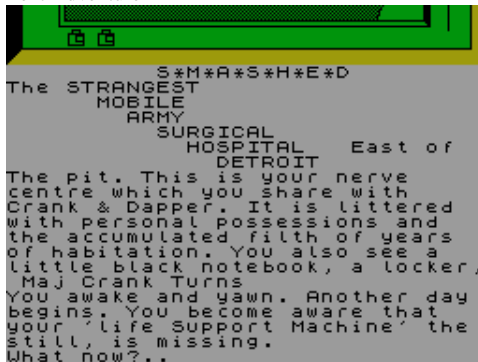

Smash TV (Ocean Software Ltd,1991)
Arcade Adventure

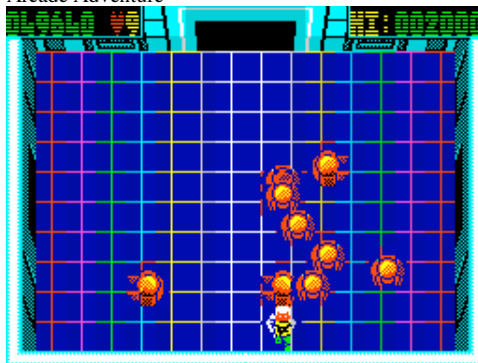

Smagly 1 (Spectre Guys,1995)
Arcade Adventure



Smaily (Zigurat Software,1990)
Arcade

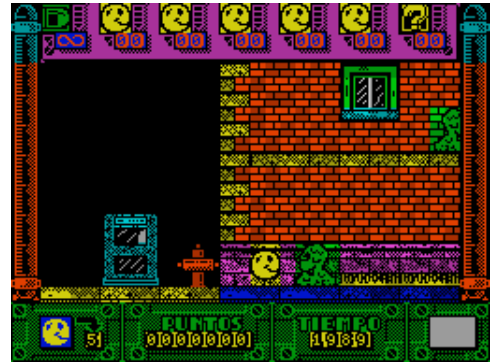

Smash (E.S.A. Productions,1996)
Scene Demo

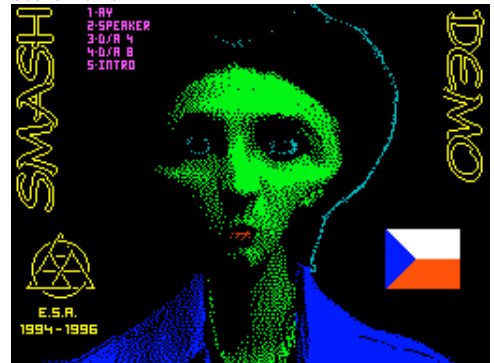

Smashout!! (Digital Image,1985)
Arcade

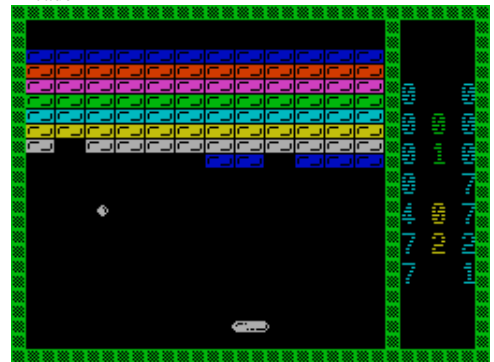

Smok Wawelski (KWCz,1987)
Text Adventure



Smooth, 3D (Claus Jahn,1996)
Utility: Screen Manipulation

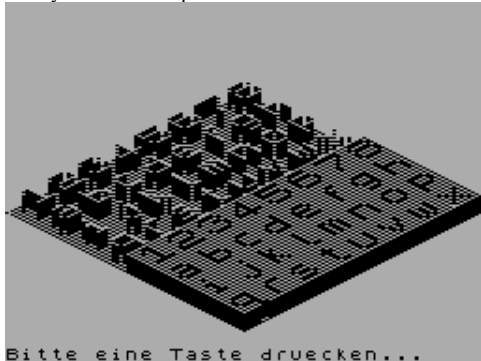

Smuggler (CCS,1983)
Simulation

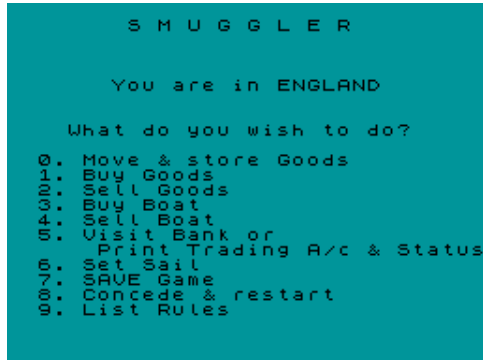

Smurf's Shit 2 (Hacker Chris,1988)
Scene Demo



Snail Logo (CP Software,1983)
Utility: Programming

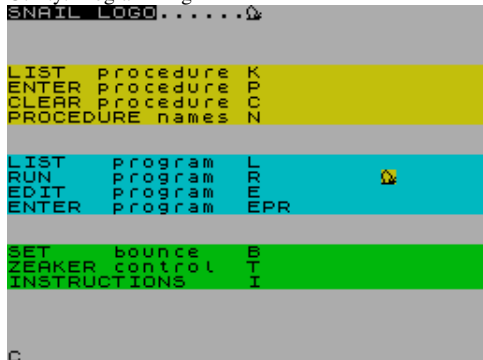

Snake (16/48 Tape Magazine,1984)
Arcade



Smrkci (Xenon,1985)
Text Adventure



Smuggler's Cove (Quicksilva Ltd,1983)
Text Adventure

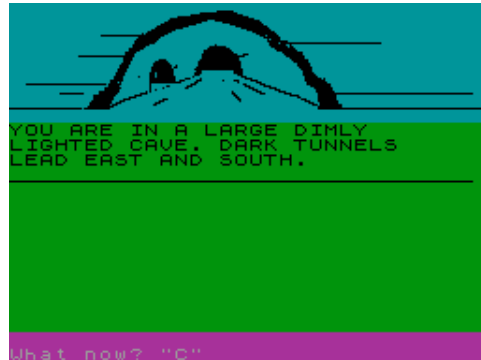

Snackman (Amba Software,1983)
Arcade



Snail Race (Mouse,.)
Simulation



Snake (Apocalypse Software,1983)
Arcade



Smudge and the Moonees (Sparklers,1987)
Arcade



Smurf's Shit 1 (Hacker Chris,1987)
Scene Demo



Snaffle (Longman Software,1985)
Educational

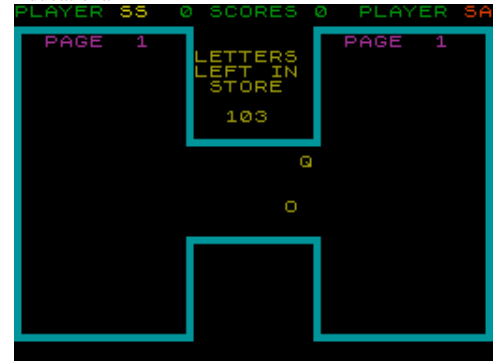

Snail-Racing (New Hairs Software Ltd,1995)
Simulation



Snake (Artic Computing Ltd,1983)
Arcade

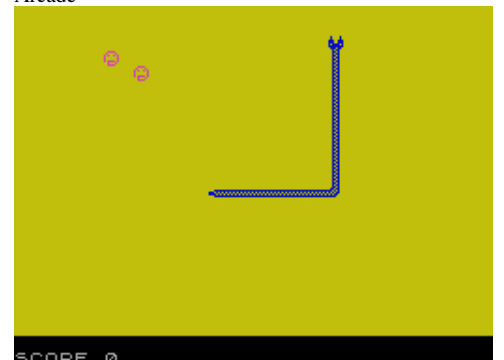

Snake!! (David Hembrow,1983)
Arcade



Snake (RGH Software,)
Arcade



Snake Battle (M.T.V.,1994)
Arcade

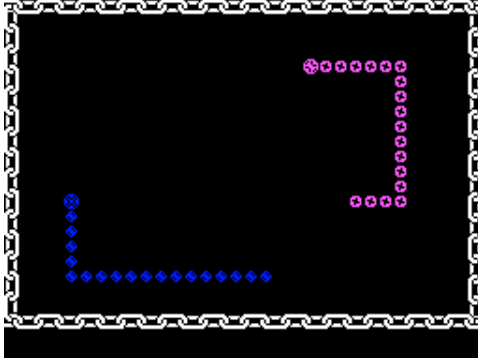

Snake Pit (Postern,1983)
Arcade

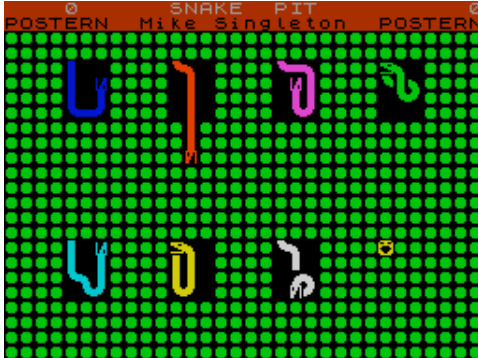

Snakes and Hazards (Gremlin Graphics Software Ltd,1987)
Board/Card Game

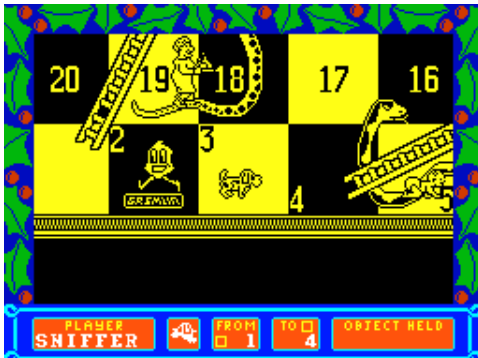

Snake (Dominic Morris,1992)
Arcade

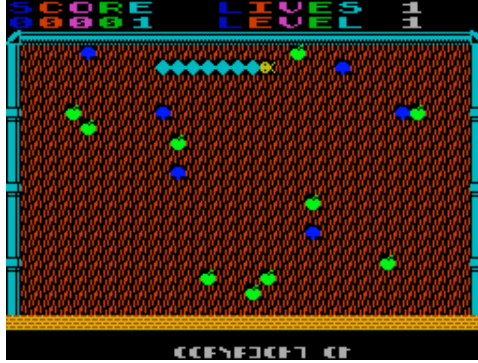

Snake (Sinclair Programs,1983)
Arcade

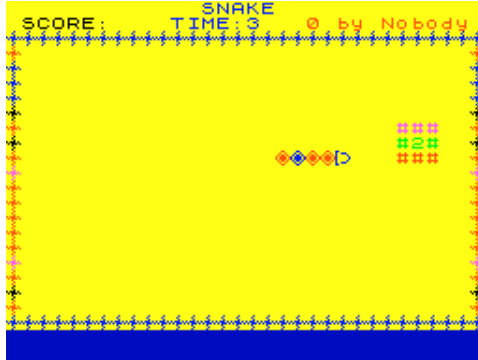

Snake Byte (,)
Arcade



Snaker (Spectrum Computing,1985)
Arcade

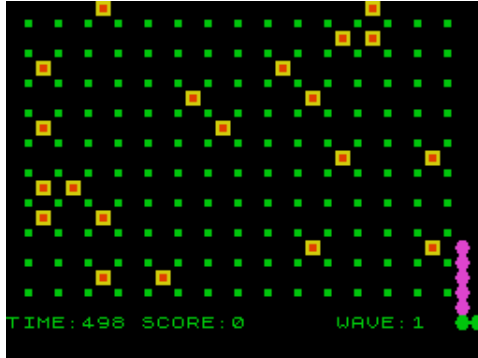

Snakes and Ladders (Rai Software,1986)
Board/Card Game

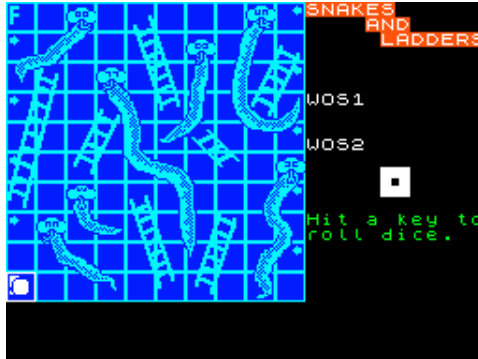

Snake (MicroHobby,1986)
Arcade



Snake (Virgin Books,1983)
Arcade

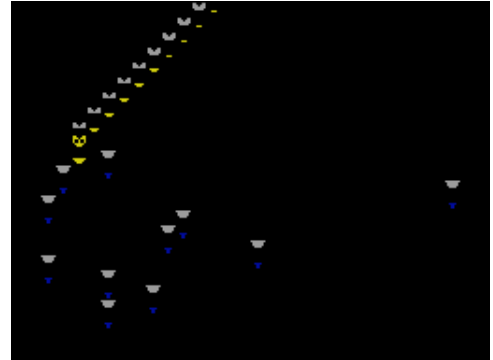

Snake Crash (Thomas Busse,1985)
Arcade



Snakes Alive (Your Computer,1985)
Arcade



Snake & Supaplex (X-Project Assotiation/ZX Power,1999)
Board/Card Game



Snakey (.)
Arcade

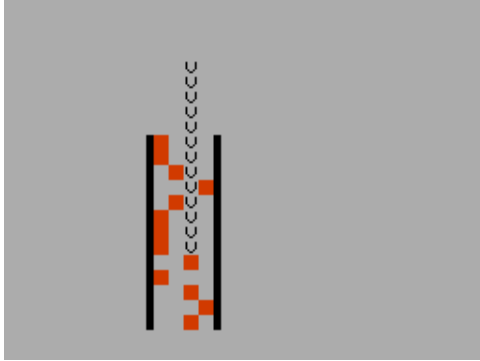

Snapple Hopper (Macmillan Software Ltd,1985)
Educational



Snare (Beyond Belief,1992)
Arcade



Sniper (Scorpio Gamesworld,1984)
Arcade



Snooker (Artic Computing Ltd,1983)
Sport



Snakman (Your Computer,1983)
Arcade

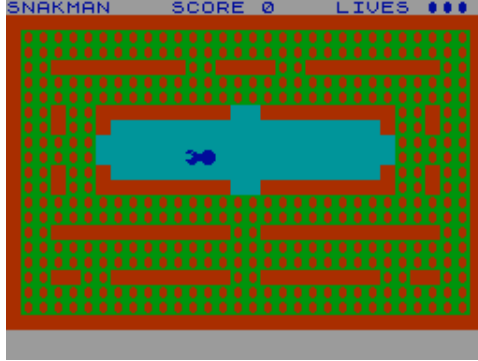

Snap Reader (Richard Swann/Miles
Kinloch/ewgf,1996)
Utility

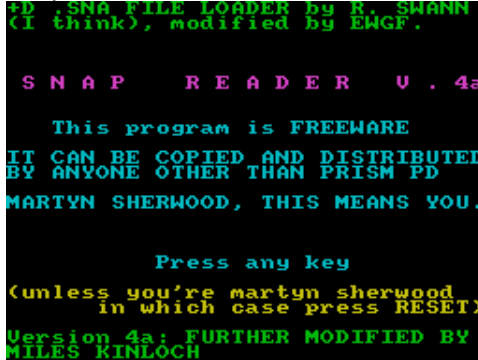

Snip (R'n'H Microtec,1990)
Arcade



Snoball in Hell (Atlantis Software Ltd,1989)
Arcade

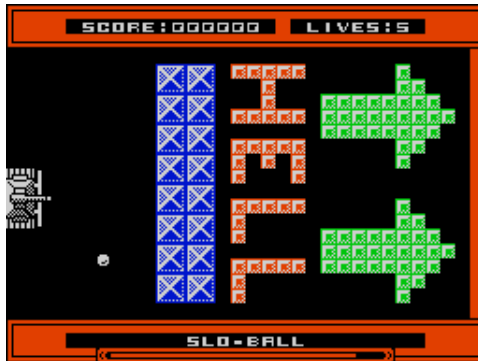

Snooker (G.R. Bonfield,1983)
Sport



Snap! (Garry Cappuccini,1989)
Text Adventure



Snapshot (Scetlander,1988)
Educational



Sniper (Brian Fitton,1985)
Arcade



Snodgits! (Creative Sparks,1985)
Arcade Adventure

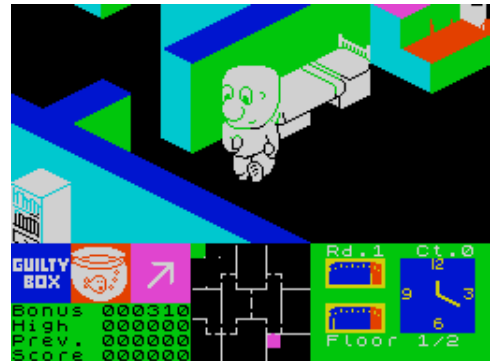

Snooker (Visions Software Factory,1983)
Sport



Snooker, 3D (Players Premier Software,1990)
Arcade



Snooker Manager (Image Software Ltd,1989)
Simulation



Snoopy (The Edge Software,1990)
Arcade

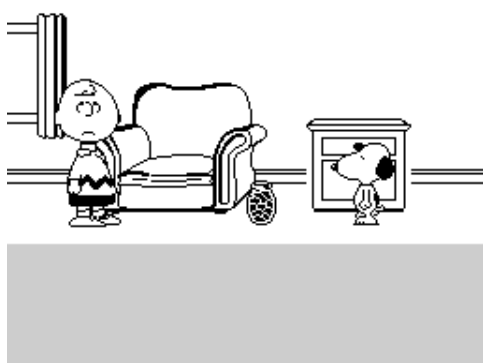

Snowman Sam (16/48 Tape Magazine,1984)
Arcade



Snowstrike (US Gold Ltd,1991)
Arcade



Snookered (Top Ten Software,1988)
Board/Card Game



Snooker Manager 2 (Image Software Ltd,1990)
Sport

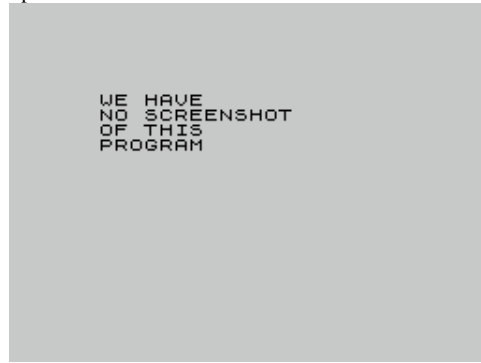

Snowball (Level 9 Computing Ltd,1983)
Text Adventure

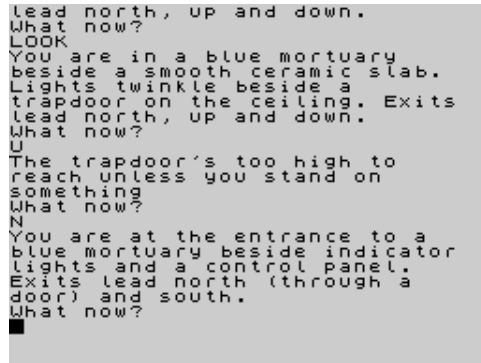

Snowman, The (Quicksilva Ltd,1984)
Arcade

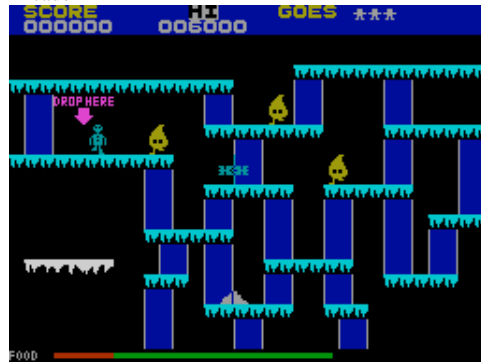

Snurf (H. Fiebig,1984)
Arcade



Snooker Management (D&H Games,1989)
Simulation

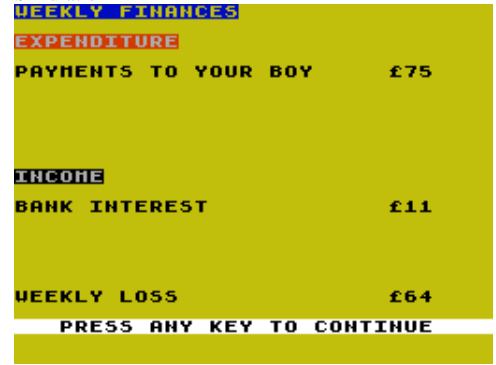

Snooker Masters (Lambourne Games,1990)
Strategy

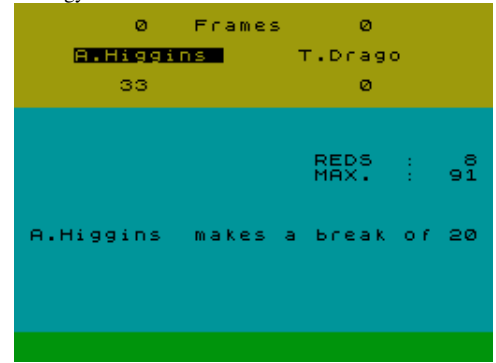

Snow Joke! (Delbert the Hamster Software,1991)
Text Adventure

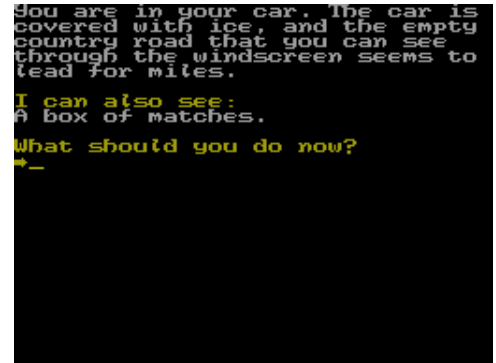

Snow Queen, The (Mosaic Publishing Ltd,1985)
Text Adventure

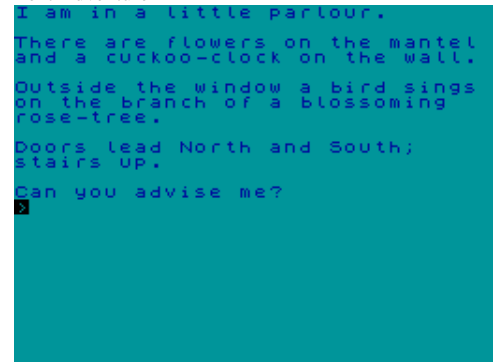

SO3 Tape to Opus Drive Utility (Kobrahssoft,1987)
Utility: Copier



SO4 Tape to Opus Drive Utility (Kobraisoft,1987)
Utility: Copier



SO5 Tape to Opus Utility (Kobraisoft,)
Utility: Copier



Soap Land (Zodiac Software,1987)
Text Adventure

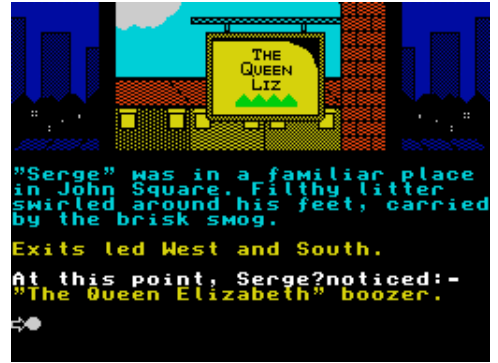

Soap Land + For Your Thighs Only (Delbert the Hamster Software,.) Compilation



Soccer (Meow Micros,1983)
Arcade



Soccer 6 (Challenge Software,1990)
Compilation

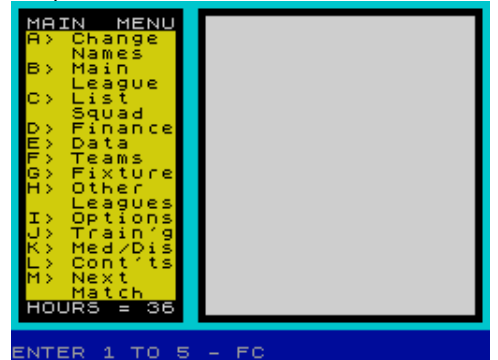

Soccer 7 (Cult Games,1989)
Simulation



Soccer Challenge (Alternative Software Ltd,1990)
Arcade

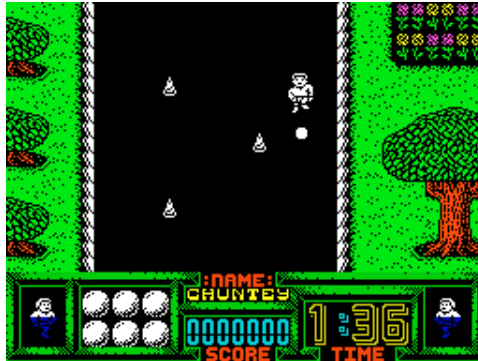

Soccer Coach (D&H Games,1988)
Sport



Soccer Cup Quizmaster (Crash,1991)
Board/Card Game



Soccer Director (GTI Software,1990)
Simulation



Soccer Double (E&J Software,1991)
Compilation



Soccer Double 2 (Challenge Software,1991)
Compilation



Soccer Double 3 (Challenge Software,1991)
Compilation



Soccer Genius (Stephen Bye,)
Simulation



Soccer Mania (Addictive Games Ltd,1992)
Compilation

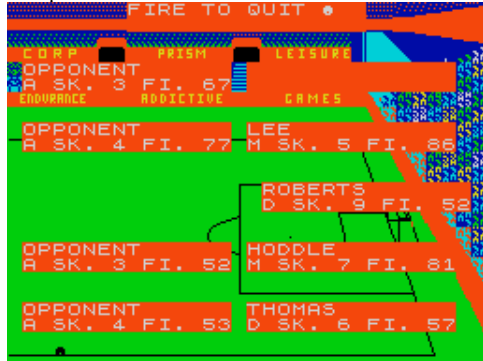

Soccer Rematch (Lambourne Games,1989)
Strategy



Soccer Rematch - Misc Datafiles (Lambourne Games,)
Simulation



Soccer Spectacular (Beau-Jolly Ltd,1989)
Compilation



Soccer Stars (Empire Software,1992)
Compilation



Soccer Pinball (Code Masters Ltd,1992)
Arcade



Soccer Rematch Data Cassette 1 (Lambourne Games,1994)
Strategy



Soccer Rivals (Cult Games,1991)
Simulation



Soccer Squad, The (Gremlin Graphics Software Ltd,1989)
Compilation



Soccer Supremo (Redwood Designs,1988)
Arcade



Soccer Q (Cult Games,1989)
Simulation

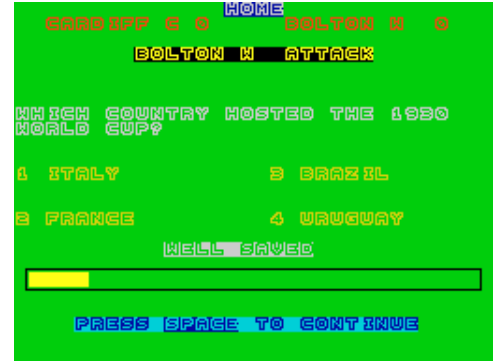

Soccer Rematch - Italia 90 (Lambourne Games,1991)
Strategy

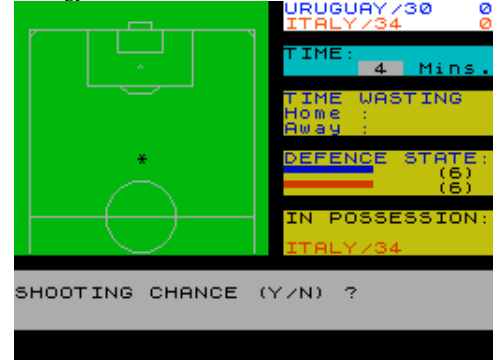

Soccer Skills (Code Masters Gold,1988)
Sport



Soccer Star (Cult Games,1989)
Simulation



Soccer Supremo (White Panter Software,1988)
Arcade



Sodov the Sorcerer (Bug-Byte Software Ltd,1986)
Arcade Adventure



Sofmon (Softek Software International Ltd,1983)

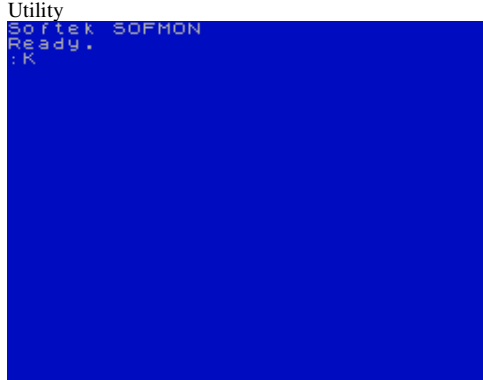

Softalk (CP Software,1982)
Utility: Sound Manipulation



Softcopy (Joan Soft,)
Utility: Copier

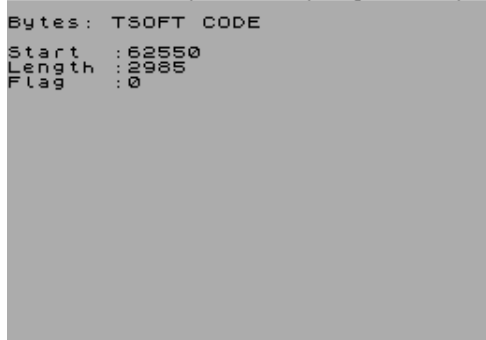

Softek 'IS' BASIC Compiler (Softek Software International Ltd,1982) Utility: BASIC Related



Sofkit 1 (Softek Software International Ltd,1983)
Utility

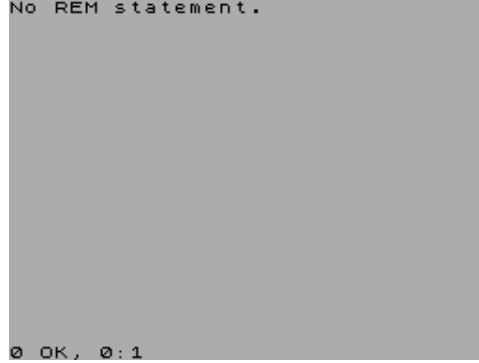

Soft 888 (Sinclair Research Ltd,1986)
Compilation



Softalk II (CP Software,1982)
Utility: Sound Manipulation



Soft & Cuddly (The Power House,1987)
Arcade



Softek Super C Compiler (Softek Software International Ltd,1982) Utility: Programming

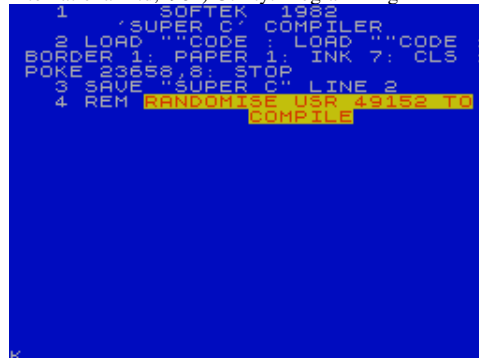

Sofkit 2 (Softek Software International Ltd,1983)
Utility



Soft Aid (Quicksilva Ltd,1985)
Compilation



Softape 3 (Soft Sell,1983)
Compilation



Softek 'FP' Full Compiler (Softek Software International Ltd,1983) Utility: BASIC Related

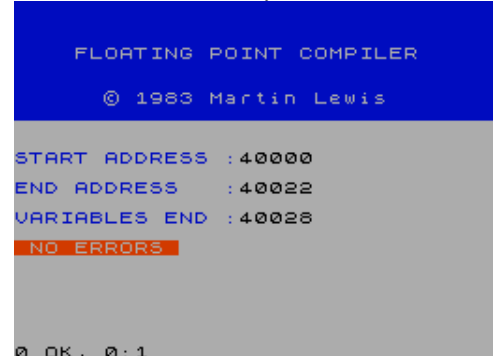

Soft issue 2 (Sift,1984)
Covertape



Softland 1 (Felix.)
Scene Demo



Softland 2 (Felix.)
Scene Demo

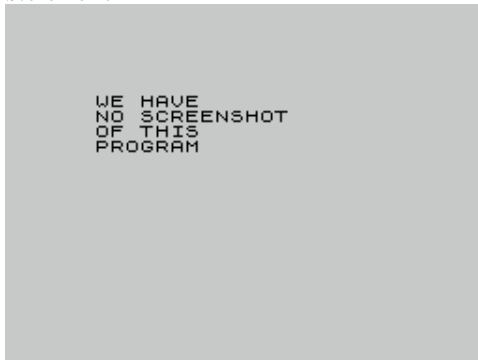

Softlink 1 (Gilsoft International,1983)
Utility

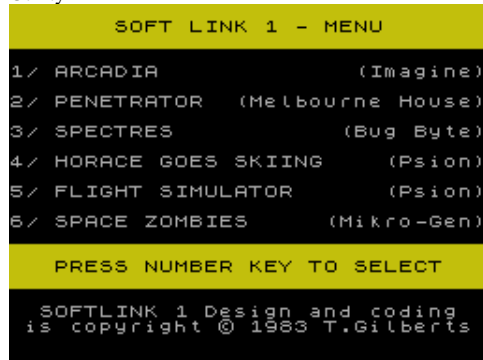

Soft Spectrum issue 01 (Grupo de Trabajo Software S.A.,1984) Covertape

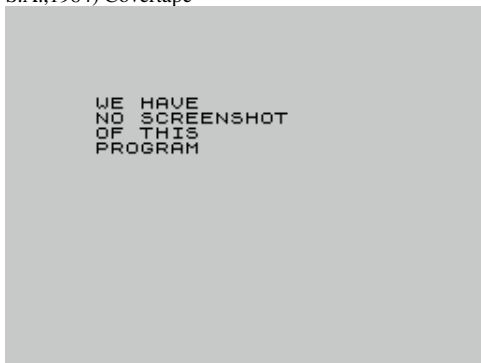

Soft Spectrum issue 02 (Grupo de Trabajo Software S.A.,1985) Covertape

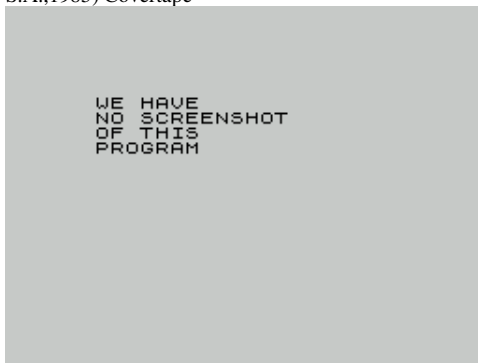

Soft Spectrum issue 03 (Grupo de Trabajo Software S.A.,1985) Covertape



Soft Spectrum issue 04 (Grupo de Trabajo Software S.A.,1985) Covertape



Soft Spectrum issue 05 (Grupo de Trabajo Software S.A.,1985) Covertape



Soft Spectrum issue 06 (Grupo de Trabajo Software S.A.,1985) Covertape



Soft Spectrum issue 07 (Grupo de Trabajo Software S.A.,1985) Covertape



Soft Spectrum issue 08 (Grupo de Trabajo Software S.A.,1985) Covertape



Soft Spectrum issue 09 (Grupo de Trabajo Software S.A.,1985) Covertape



Soft Spectrum issue 10 (Grupo de Trabajo Software S.A.,) Covertape



Soft Spectrum issue 11 (Grupo de Trabajo Software S.A.,) Covertape



Soft Spectrum issue 12 (Grupo de Trabajo Software S.A.,) Covertape



Soft Spectrum issue 13 (Grupo de Trabajo Software S.A.) Covertape

WE HAVE
NO SCREENSHOT
OF THIS
PROGRAM

Soft Spectrum issue 14 (Grupo de Trabajo Software S.A.) Covertape

WE HAVE
NO SCREENSHOT
OF THIS
PROGRAM

Soft Spectrum issue 15 (Grupo de Trabajo Software S.A.) Covertape

WE HAVE
NO SCREENSHOT
OF THIS
PROGRAM

Soft Spectrum issue 16 (Grupo de Trabajo Software S.A.) Covertape

WE HAVE
NO SCREENSHOT
OF THIS
PROGRAM

Soft Spectrum issue 17 (Grupo de Trabajo Software S.A.) Covertape

WE HAVE
NO SCREENSHOT
OF THIS
PROGRAM

Soft Spectrum issue 18 (Grupo de Trabajo Software S.A.) Covertape

WE HAVE
NO SCREENSHOT
OF THIS
PROGRAM

Soft Spectrum issue 19 (Grupo de Trabajo Software S.A.) Covertape

WE HAVE
NO SCREENSHOT
OF THIS
PROGRAM

Soft Spectrum issue 20 (Grupo de Trabajo Software S.A.) Covertape

WE HAVE
NO SCREENSHOT
OF THIS
PROGRAM

Soft Spectrum issue 21 (Grupo de Trabajo Software S.A.) Covertape

WE HAVE
NO SCREENSHOT
OF THIS
PROGRAM

Soft Spectrum issue 22 (Grupo de Trabajo Software S.A.) Covertape

WE HAVE
NO SCREENSHOT
OF THIS
PROGRAM

Soft Spectrum issue 23 [1] (Grupo de Trabajo Software S.A.,1987) Covertape



Soft Spectrum issue 23 [2] (Grupo de Trabajo Software S.A.,1987) Covertape



Soft Spectrum issue 24 (Grupo de Trabajo Software S.A.,1987) Covertape

WE HAVE
NO SCREENSHOT
OF THIS
PROGRAM

Soft Spectrum issue 25 (Grupo de Trabajo Software S.A.,1987) Covertape

WE HAVE
NO SCREENSHOT
OF THIS
PROGRAM

Software Crimes of Bill Gilbert, The (Double 27,1991) Scene Demo

```
BROKEN BY BILL GILBERT
  don't believe in magic!!!
Hacker Chris breaks 100 % games
and sells him these creations!!!
Then bill loads cracked games,
  plays a bit and presses button
of his MASTERFACE,so each game
is double or triple broken (if
the 2nd wasn't good) by bill!!!
It's true! But bill cracks alre-
ady broken releases.

  FOR WHAT? That's a question!
The correct answer:for install
his famous sentence:BROKEN BY...

PRESS SPACE

B.L.L. WATCH OUT!
```

Software Filer, The (Gilad Japhet.)
Utility: Database



Software Magazine issue 00 (Monser S.A.,1984)
Covertape



Software Magazine issue 02b (Monser S.A.,1984)
Covertape



Software Magazine issue 04a (Monser S.A.,1984)
Covertape



Software Magazine issue 05b (Monser S.A.,1985)
Covertape



Software House (Cult Games,1988)
Simulation



Software Magazine issue 01 (Monser S.A.,1984)
Covertape



Software Magazine issue 03a (Monser S.A.,1984)
Covertape

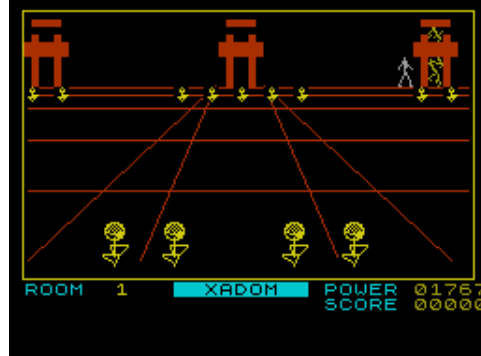

Software Magazine issue 04b (Monser S.A.,1984)
Covertape



Software Magazine issue 06a (Monser S.A.,1985)
Covertape



Softwareliste (.)
Utility: Database



Software Magazine issue 02a (Monser S.A.,1984)
Covertape



Software Magazine issue 03b (Monser S.A.,1984)
Covertape



Software Magazine issue 05a (Monser S.A.,1985)
Covertape



Software Magazine issue 06b (Monser S.A.,1985)
Covertape



Software Magazine issue 07a (Monser S.A.,1985)
Covertape

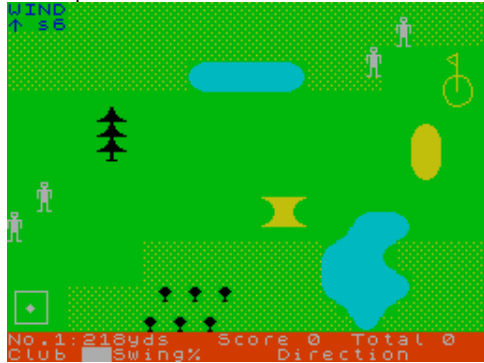

Software Magazine issue 08b (Monser S.A.,1985)
Covertape

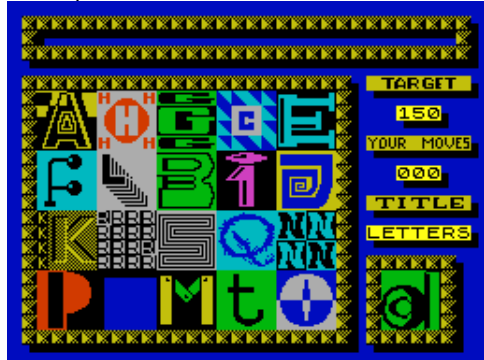

Software Magazine issue 10a (Monser S.A.,1985)
Covertape



Software Magazine issue 11b (Monser S.A.,1985)
Covertape

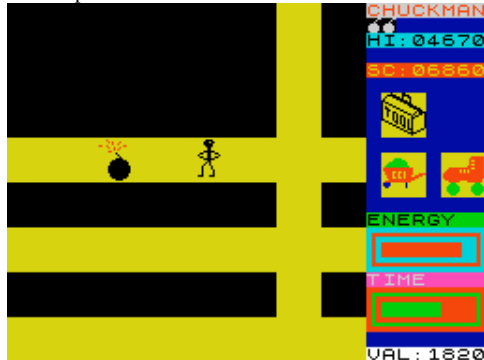

Software Magazine issue 12b (Monser S.A.,1985)
Covertape



Software Magazine issue 07b (Monser S.A.,1985)
Covertape

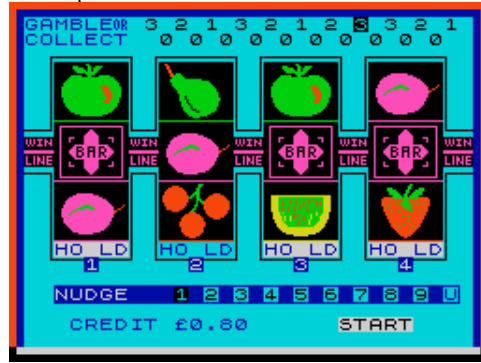

Software Magazine issue 09a (Monser S.A.,1985)
Covertape

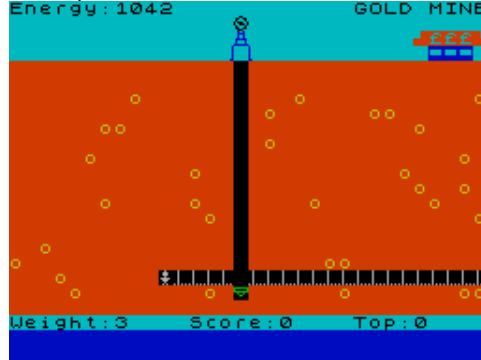

Software Magazine issue 10b (Monser S.A.,1985)
Covertape



Software Magazine issue 11c (Monser S.A.,1985)
Covertape



Software Magazine issue 13a (Monser S.A.,1985)
Covertape

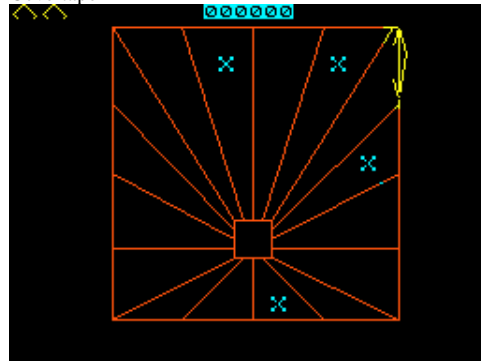

Software Magazine issue 08a (Monser S.A.,1985)
Covertape



Software Magazine issue 09b (Monser S.A.,1985)
Covertape



Software Magazine issue 11a (Monser S.A.,1985)
Covertape



Software Magazine issue 12a (Monser S.A.,1985)
Covertape

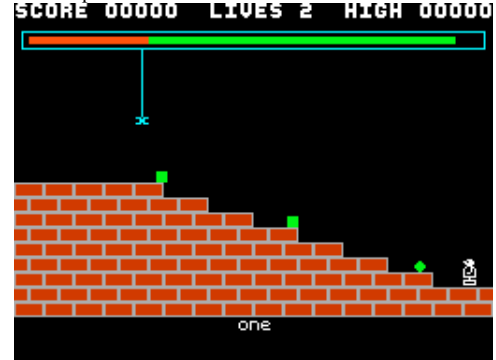

Software Magazine issue 13b (Monser S.A.,1985)
Covertape



Software Magazine issue 14a (Monser S.A.,1985)
Covertape

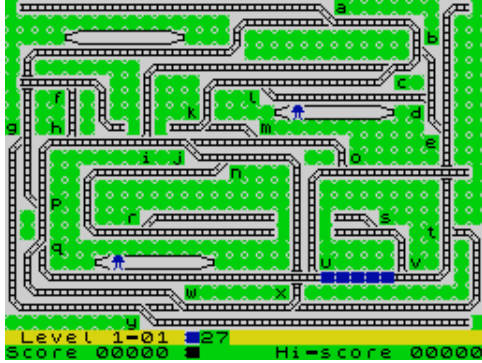

Software Magazine issue 15b (Monser S.A.,1985)



Software Magazine issue 17a (Monser S.A.,1986)
Covertape



Software Magazine issue 18b (Monser S.A.,1986)
Covertape



Soho Sex Quest (Malan Associates,1984)
Text Adventure

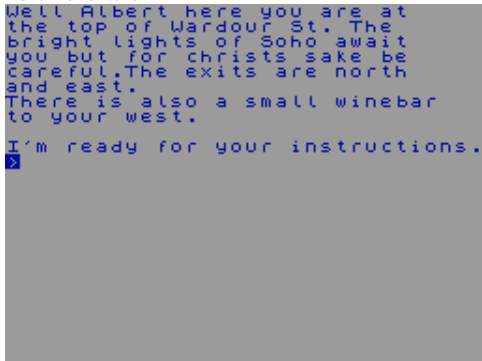

Software Magazine issue 14b (Monser S.A.,1985)
Covertape



Software Magazine issue 16a (Monser S.A.,1985)
Covertape



Software Magazine issue 17b (Monser S.A.,1986)
Covertape



Software Star (Addictive Games Ltd,1985)
Simulation

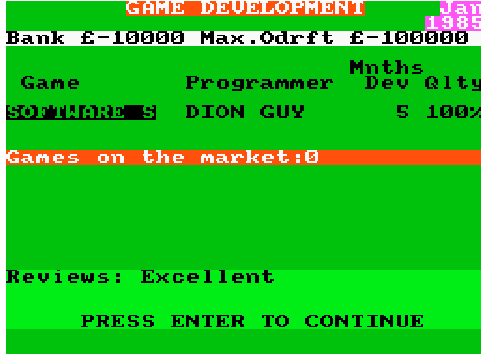

Soho Sex Quest 2: Herpes or Bust (Malan Associates,1984)
Text Adventure

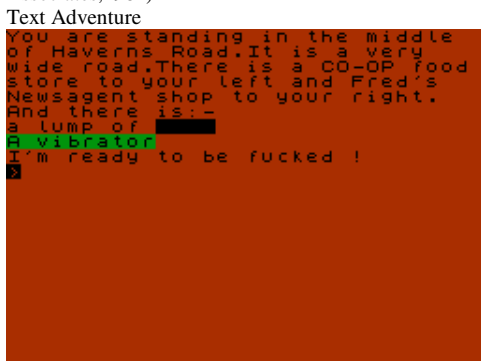

Software Magazine issue 15a (Monser S.A.,1985)
Covertape



Software Magazine issue 16b (Monser S.A.,1985)
Covertape

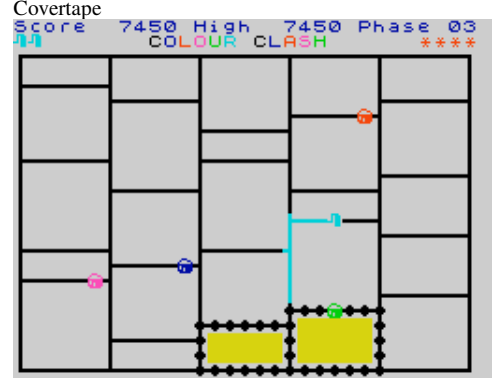

Software Magazine issue 18a (Monser S.A.,1986)
Covertape

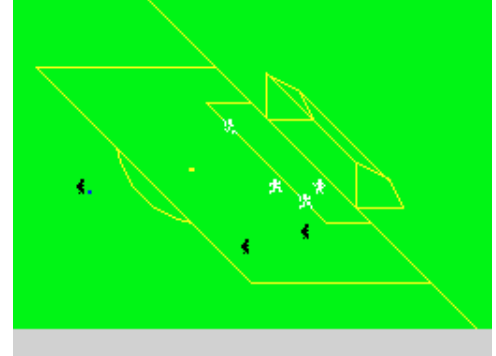

Soho Mission (Daren Percy,1990)
Text Adventure

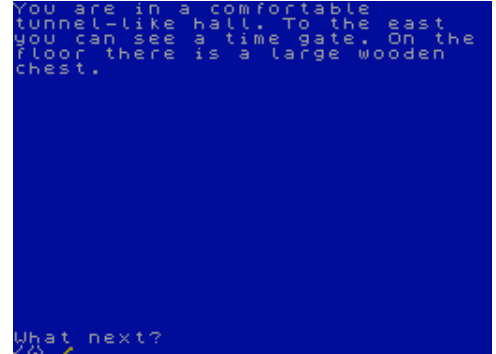

Sokoban (Compiler Software,2006)
Arcade



Sokoban (VTS,2001)
Arcade

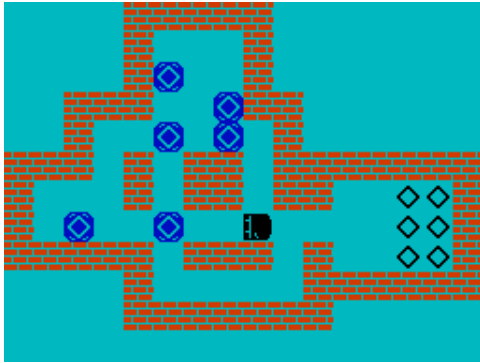

Soko-Ban Editor (Omikron Software [2],1990)
Arcade Game Development Tool



Solar Fire (Astros Productions,1989)
Arcade Adventure

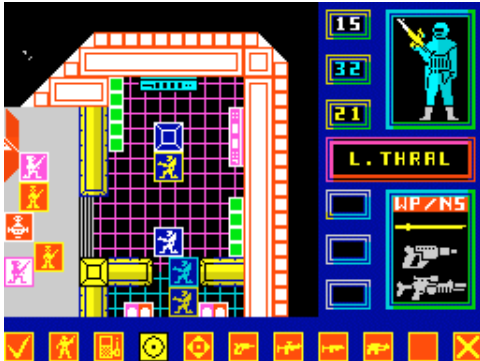

Solaris (Softel Software,1983)
Text Adventure



Soldier of Fortune (Firebird Software Ltd,1988)
Arcade

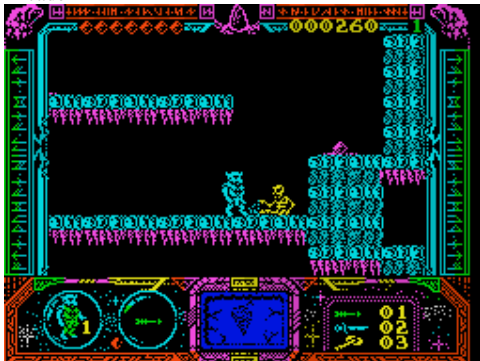

Sokoban (WE [Poland],1991)
Arcade

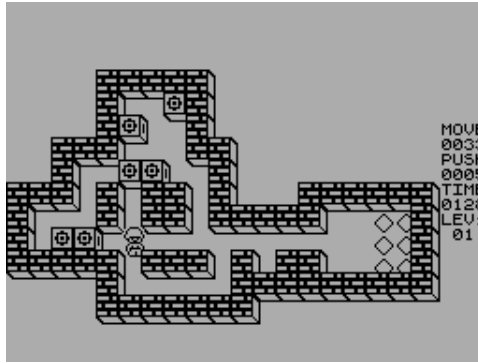

Solador (MicroHobby,1985)
Arcade



Solar Invasion (Mastertronic Ltd,1989)
Arcade

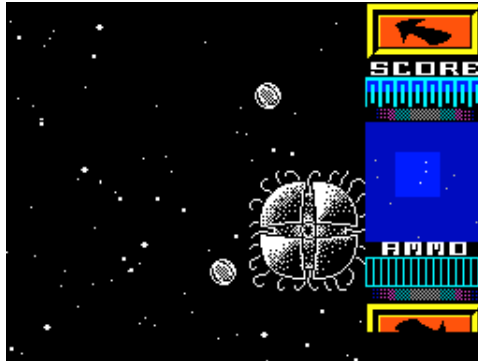

Solar Jetman (Ultimate Play The Game,)
Arcade Adventure



Soldier of Light (ACE Software [1],1988)
Arcade

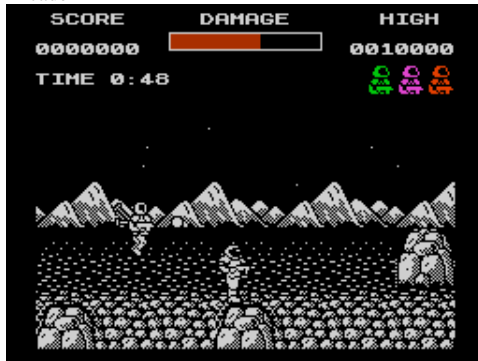

Sokoban (Zack,1997)
Arcade

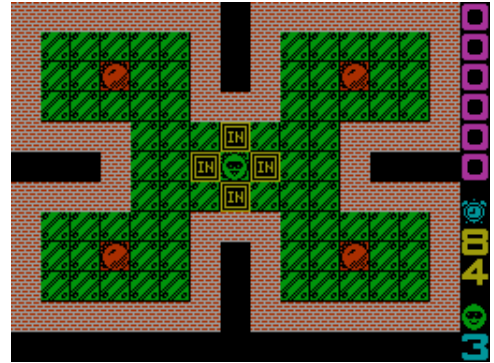

Solar Empire (Players Premier Software,1990)
Arcade

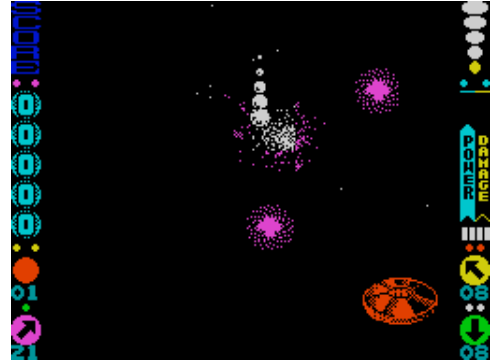

Solaris (Hellenic Software,1989)
Arcade



Solar System, The (Eaglesoft,1985)
Educational



Soldier of the Future (Ivan Gudkov,1994)
Strategy



Soldier One (Your Sinclair,1993)
Arcade



Solid Gold (US Gold Ltd,1988)
Compilation

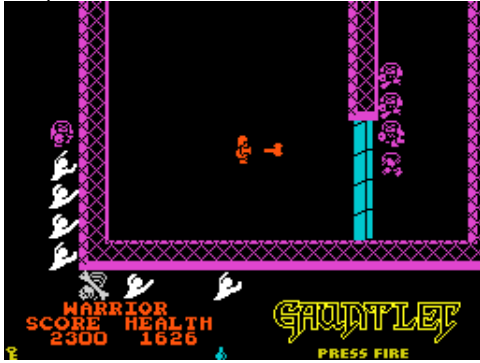

Solitaire (Frozen Ice,1990)
Board/Card Game



Solitaire (Shiva Publishing Ltd,1983)
Board/Card Game



Solitaire (Spectrum Computing,1985)
Board/Card Game

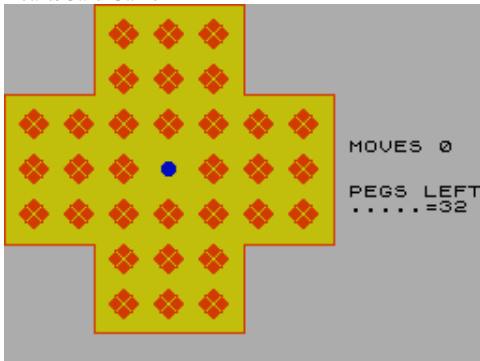

Soldiers (Alexander Sizenko,1998)
Strategy



Solitaire (16/48 Tape Magazine,1985)
Board/Card Game



Solitaire (Haven Hardware,1983)
Board/Card Game



Solitaire (Sinclair Research Ltd,1982)
Board/Card Game



Solitario (MicroHobby,1985)
Board/Card Game

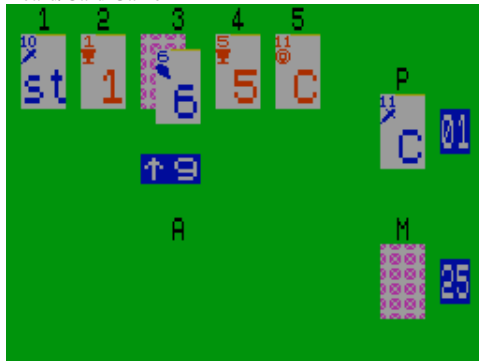

Solfeo (Video Spectrum,1984)
Educational

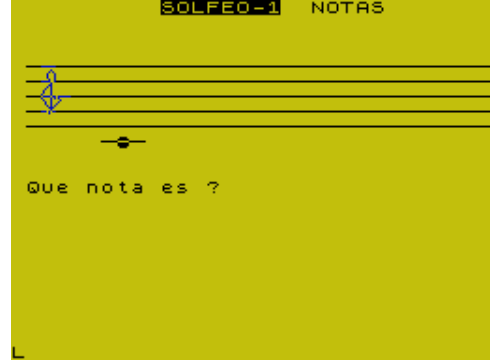

Solitaire (CCS.)
Board/Card Game



Solitaire (No Man's Land,1984)
Board/Card Game

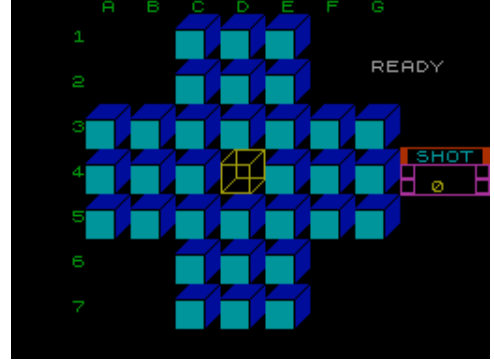

Solitaire (Softhouse Ltd,1997)
Board/Card Game

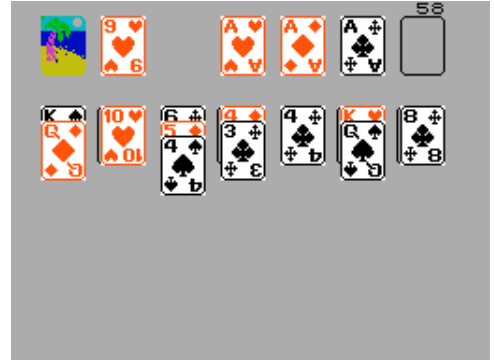

Solitario del 7 (MicroHobby,1986)
Board/Card Game



Solitario de la Cruz, La (MicroHobby,1985)
Board/Card Game



Sol Negro (Opera Soft S.A.,1989)
Arcade



Solo Whist (Video Software Ltd,1983)
Board/Card Game

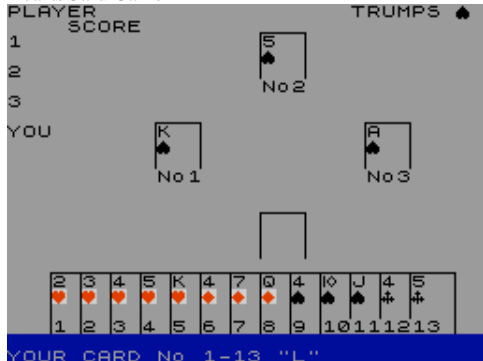

Something Happened (Peter Machala Software,1989)
Text Adventure



Sonata (Popular Computing Weekly,1983)
Music



Soliter (Oldsoft,1994)
Board/Card Game

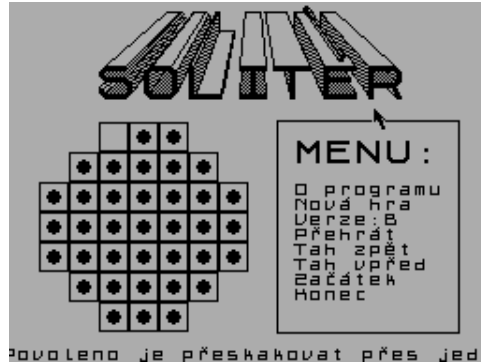

Solo (Opera Soft S.A.,1989)
Arcade

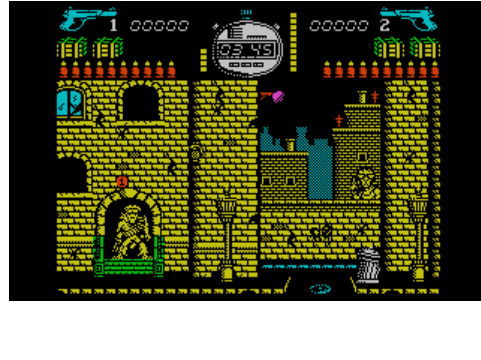

Solvaldol-X (The Guild,1992)
Text Adventure



Something Happened 2 (Peter Machala Software,1991)
Text Adventure

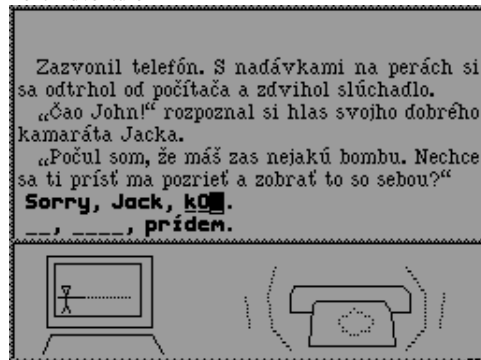

Son... De Pelicula... (Proein Soft Line,)
Compilation



So Little Time (Martin Freemantle,1993)
Text Adventure

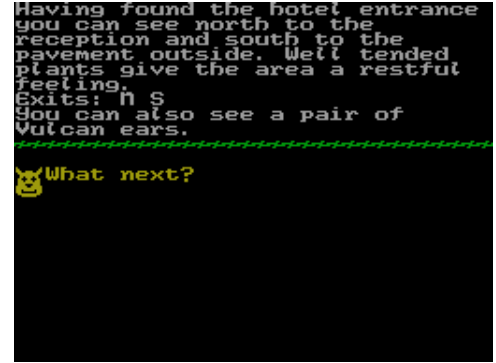

Solomon's Key (US Gold Ltd,1987)
Arcade

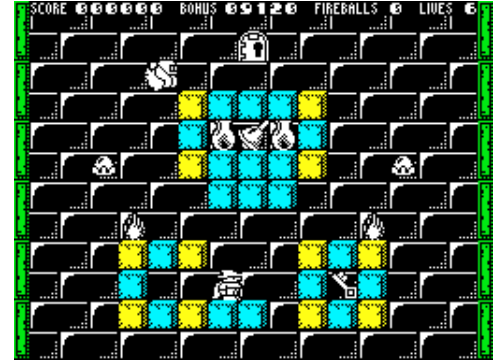

Solvaldol-X + Million Dollar Great Jewel Heist (The Guild,1992) Compilation



Sonar Salvage (Hitech Games Plus,1984)
Text Adventure



Song in Lines 4 (Busy Software,1990)
Scene Demo

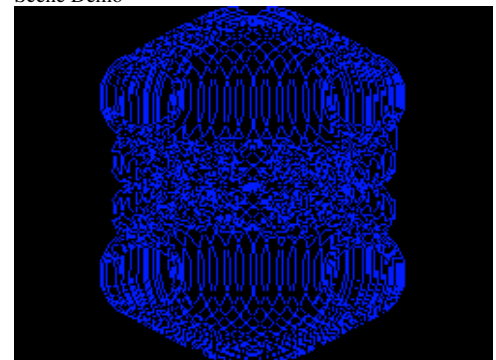

Song in Lines 5 (Busy Software,1991)
Scene Demo

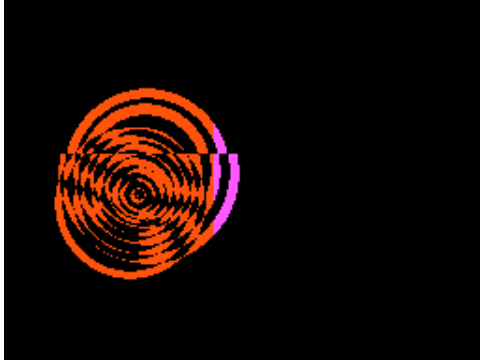

Sonic Intro (Anestis Koutsoudis,1998)
Scene Demo



Son of Bagger (Alligata Software Ltd,1984)
Arcade



Sooty and Sweep (Alternative Software Ltd,1990)
Arcade



Sophistry (CRL Group PLC,1988)
Arcade



Song of Taliesin, The (Zenobi Software,1994)
Text Adventure

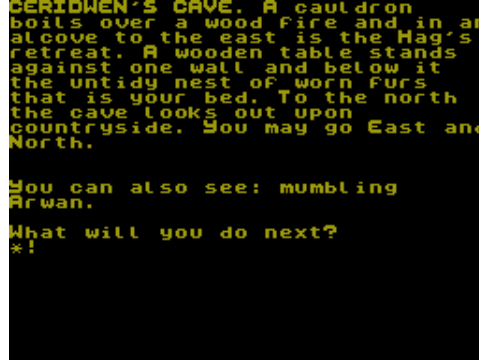

Sonic Intro, 3D (Anestis Koutsoudis,1998)
Scene Demo



Son of Mandelbrot (Your Sinclair,1990)
Utility: Screen Manipulation

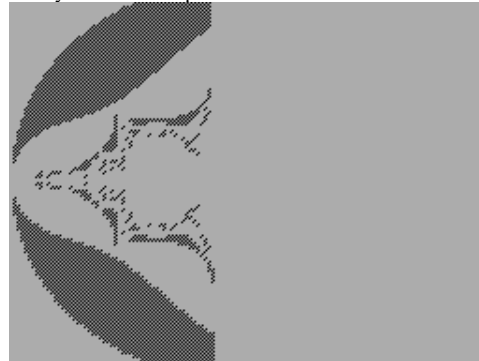

Sopa de Letras [1] (MicroHobby,1985)
Board/Card Game



Soporific (The Mad Guys,1992)
Scene Demo



Sonic Boom (Activision Inc,1990)
Arcade

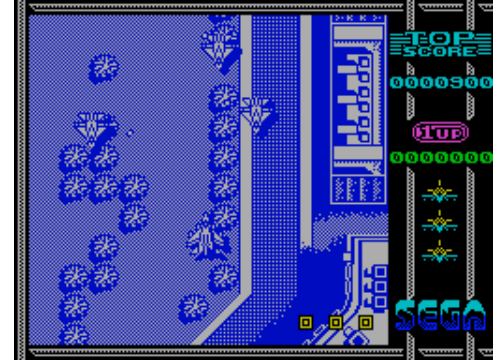

Sonic the Hedgehog (Convention,1994)
Scene Demo



Sootland (Zafiro Software Division,1988)
Arcade

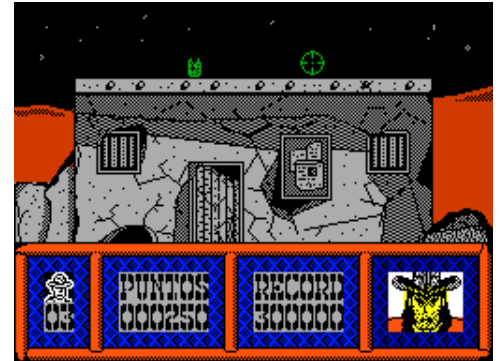

Sopa de Letras [2] (MicroHobby,1986)
Board/Card Game



Sorcerer (16/48 Tape Magazine,1984)
Text Adventure

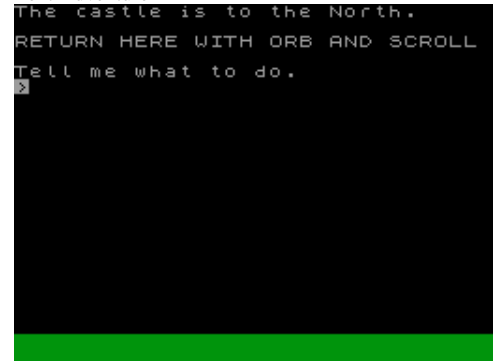

Sorcerer Lord (PSS,1987)



Sorcerer's Mountain, The (Martin Sykes,1984)

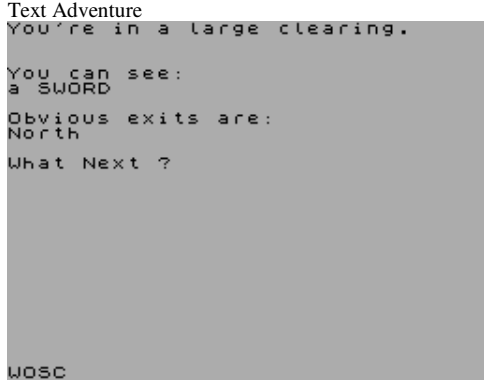

Sorderon's Shadow (Beyond Software,1985)



SOS (Visions Software Factory,1984)



S.O.S. [2] (MicroHobby,1985)



Sorcerer of Claymorgue Castle (Adventure International,1985) Text Adventure



Sorceror, The (Tim Gilberts,)

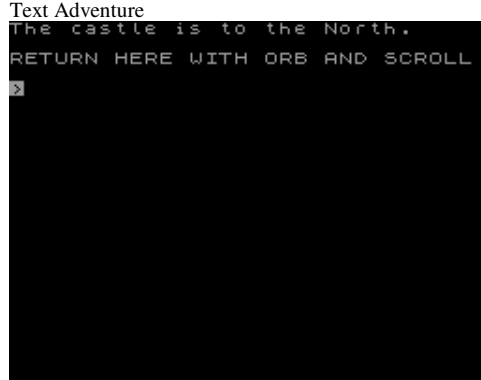

Sorti (,1984)

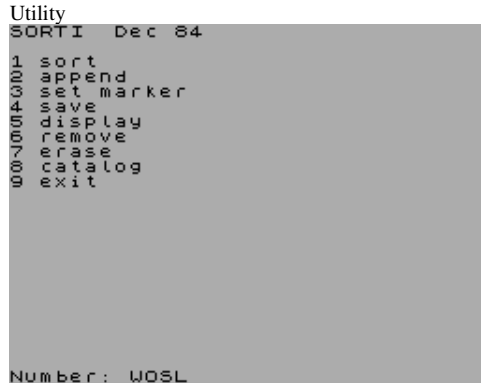

SOS: Save Our Specky (Icabod,1994)

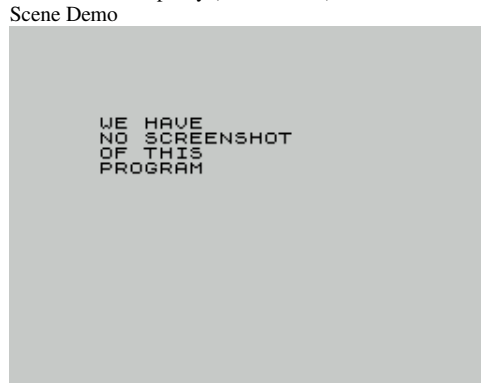

Soul Hunter, The (Trevor Whitsey,1987)



Sorcerer's Castle (Mikro-Gen Ltd,1983) Text Adventure

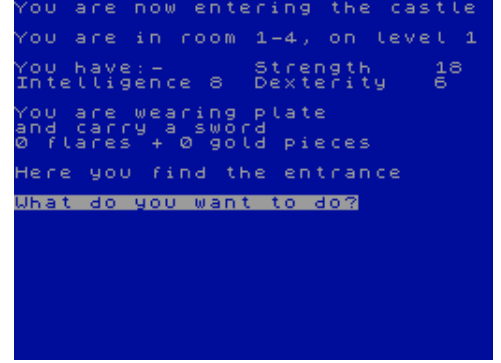

Sorcery (Virgin Games Ltd,1984)



S.O.S. (Mastertronic Ltd,1986)



S.O.S. [1] (MicroHobby,1985)

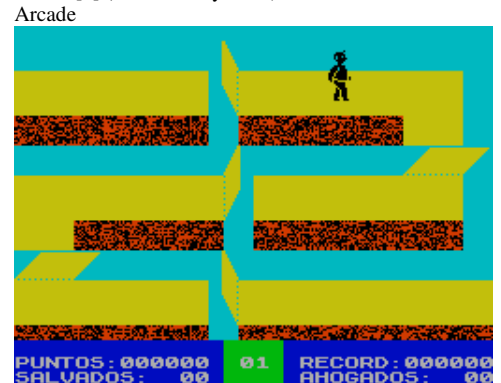

Soul of a Robot (Mastertronic Ltd,1985)



Souls of Darkon (Taskset Ltd,1985)

Text Adventure

YOU COME ACROSS THE REMAINS OF A DEAD WARRIOR LYING NEXT TO HIM IN THE MUD IS A DAMAGED KOMPUTA DROID.



YOU CAN'T GO NORTH
OK EXAMINE DROID
THE ALMOST LIFELESS DROID SAYS AS YOU ARE, I ONCE WAS, AS I AM YOU WILL BE.

Soundbeat 3 Antidemo (Pentagram,1991)

Scene Demo



Sound Demo 01 (Theo Devil,1992)

Scene Demo



Sound Demo 04 (Theo Devil,1992)

Scene Demo



Sound Demo 07 (Theo Devil,1992)

Scene Demo



Soundabout (Macmillan Software Ltd/Sinclair

Research Ltd,1985) Educational

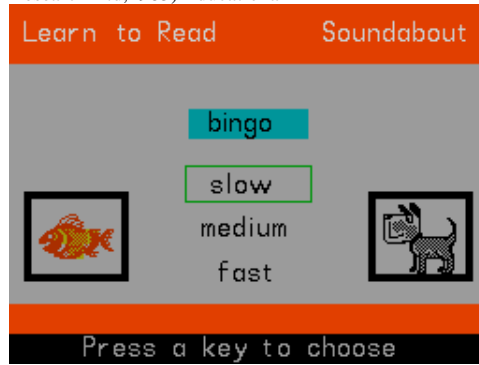

Sound Compilation (.)

Utility: Sound Manipulation

THE COMPUTER HAS RANDOMLY CHOSEN A NUMBER FROM ONE TO A HUNDRED. TRY TO GUESS THE NUMBER.

Sound Demo 02 (Theo Devil,1992)

Scene Demo



Sound Demo 05 (Theo Devil,1992)

Scene Demo

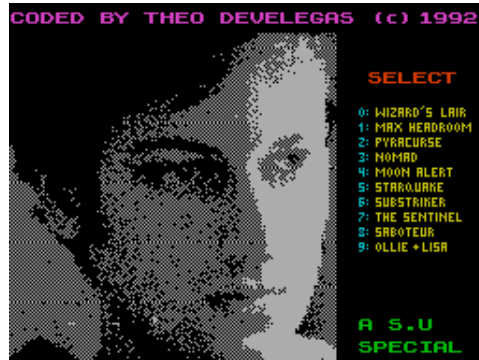

Sound Demo 08 (Theo Devil,1992)

Scene Demo

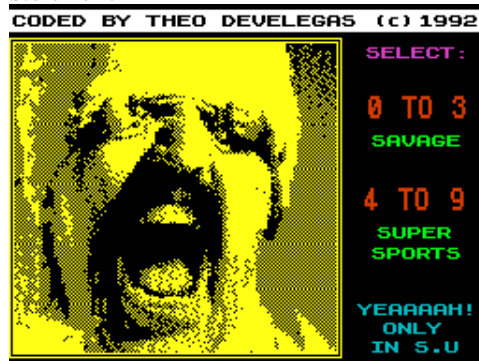

Sound Basic (Mapasoft,1985)

Utility: BASIC Related



Sound Database (XRI Systems,1987)

Utility



Sound Demo 03 (Theo Devil,1992)

Scene Demo



Sound Demo 06 (Theo Devil,1992)

Scene Demo



Sound Demo 09 (Theo Devil,1992)

Scene Demo



Sound Demo 10 (Theo Devil,1992)
Scene Demo



SoundFX (16/48 Tape Magazine,1983)
Utility: Sound Manipulation



Sound Master (Whiz Bang Software,1986)
Utility



Sound Sampler (Hamish Rust,1989)
Utility: Sound Manipulation

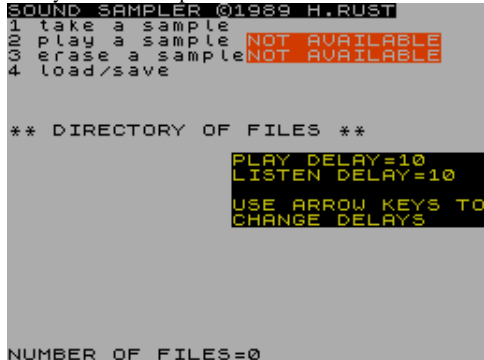

Sounds I (The Champ and Jason,)
Music



Sound Demo 3 (Rafii Soft,1989)
Scene Demo



Sound FX (DK'Tronics Ltd,1982)
Utility: Sound Manipulation

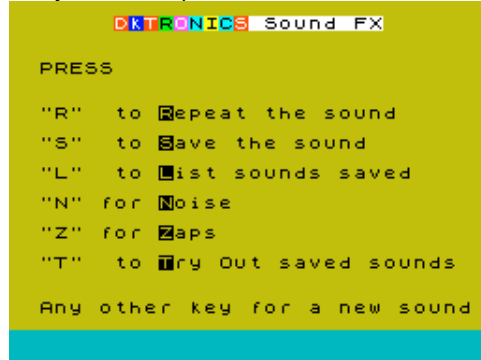

Soundrive (Flash Inc,1996)
Scene Demo



Sound Sampler (Your Sinclair,1987)
Utility: Sound Manipulation



Sound to Graphiks (,)
Utility

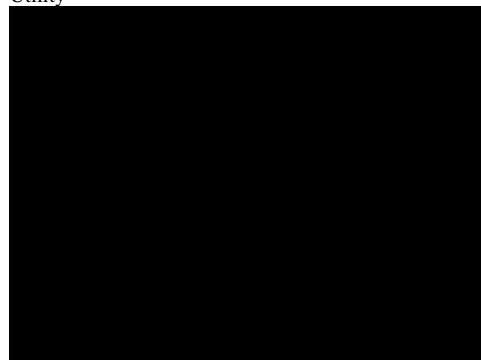

Sound Designer (DK'Tronics Ltd,)
Utility

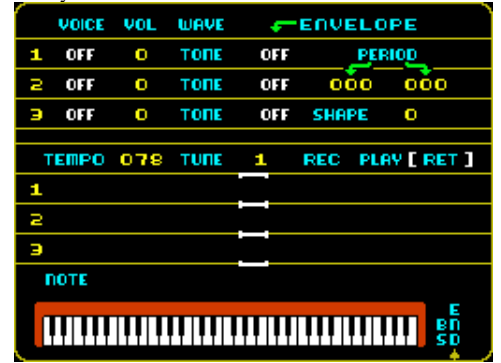

Sound FX Generator (Your Sinclair,1988)
Utility: Sound Manipulation



Sounds 2 (The Champ and Jason,)
Music

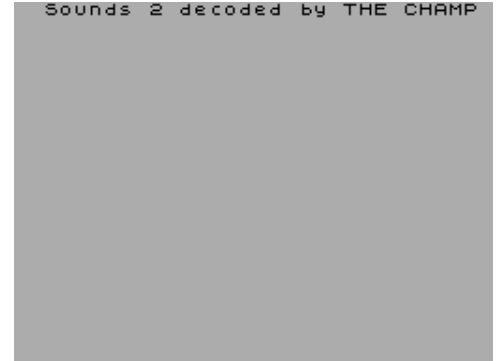

Sound Scanner (Your Computer,1983)
Utility: Sound Manipulation



Sound to Light (Sinclair User,1991)
Scene Demo

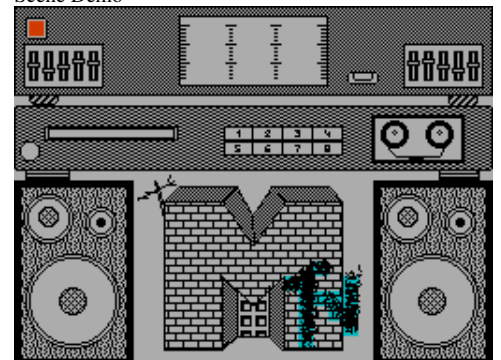

Soundtracker (Pentagram,1992)

Utility: Music Creation

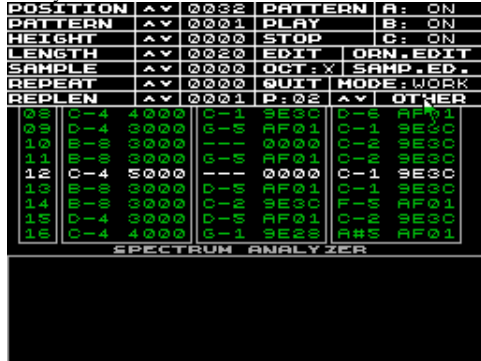

Soundtracker Song Compiler (Your Sinclair,1992)

Utility: Music Creation



Southern Belle (Hewson Consultants Ltd,1985)

Simulation



Soviet Fighter MiG 29 (Code Masters Ltd,1989)

Arcade



SP5 (,1992)

Compilation



Sound Tracker Demo (,1991)

Scene Demo



Soupcion of Trouble, A (Adventure Probe Software,)

Text Adventure



South Rail (Dee-Kay Systems,1984)

Simulation

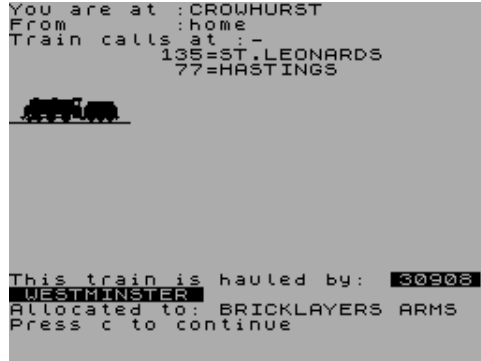

SP3 Tape to +3 Disc Utility (Kobraisoft,1987)

Utility: Copier

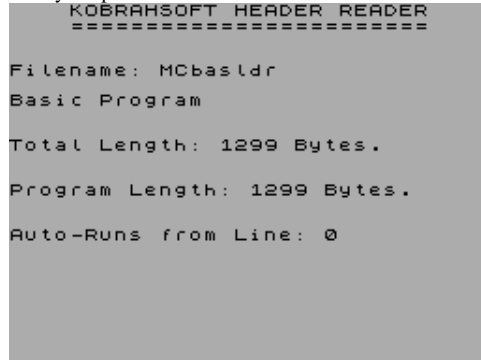

SP5 Tape to +3 Disc Utility (Kobraisoft,1989)

Utility: Copier



Soundtracker Music Demo (BZYK,1990)

Scene Demo



South Devon Hydraulics (Dee-Kay Systems,1986)

Simulation



Soviet (Opera Soft S.A.,1990)

Arcade

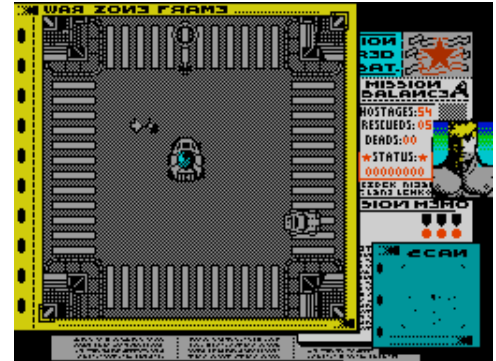

SP4 Tape to +3 Disc Utility (Kobraisoft,1989)

Utility: Copier



SP6 Tape to +3 Disc Utility (Kobraisoft,1990)

Utility: Copier



SP7 Encrypter Demo Tape (Kobraisoft,1991)
Utility: Copier



Space Ace (Empire Software,)
Arcade



Space Chaos: Battle in Future (Blindmouse Ltd,)
Arcade



Space Command (Virgin Games Ltd,1984)
Arcade



Space Defender (R. Bhattacharya,1982)
Arcade



SP7 Tape to +3 Disc Utility (Kobraisoft,1991)
Utility: Copier



Space Ace (Gremlin Graphics Software Ltd,1989)
Compilation



Space Chase (Load 'n' Run [Ita],1989)
Arcade



Space Crusade (Gremlin Graphics Software Ltd,1992)
Arcade Adventure

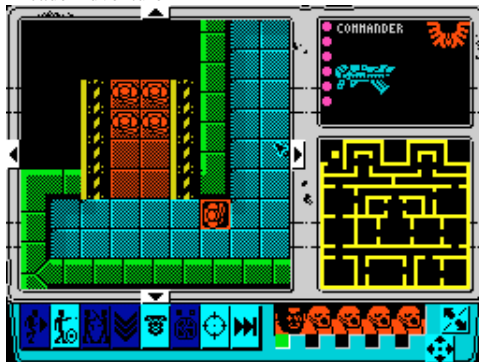

Space Defender (Spectrum Computing,1983)
Arcade



Space 7 (Your Sinclair,1992)
Arcade Adventure

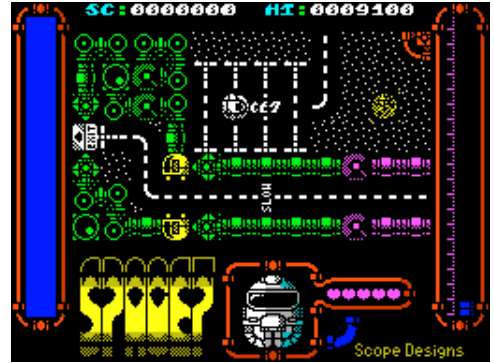

Space Art (Eclipse Software,1984)
Utility: Drawing



Space Chase (Your Computer,1983)
Arcade



Space Crystal (Quark Data,1983)
Simulation



Space Detective (Celerysoft,1986)
Text Adventure



Space Detective II: Home Run (Celerysoft,1989)
Text Adventure

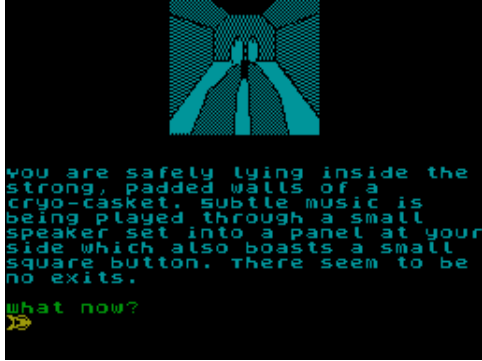

Space Escape (R. Bhattacharya,1983)
Arcade

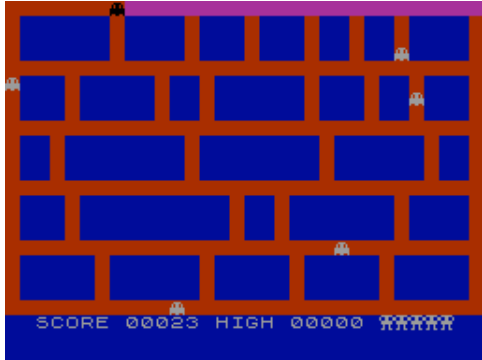

Space Gun (Ocean Software Ltd,1992)
Arcade

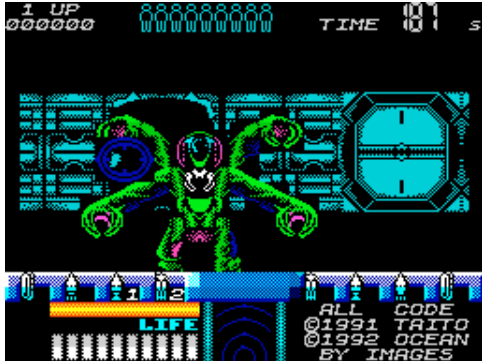

Space Hunter (Mastertronic Ltd,1986)
Arcade



Space Invaders (Robert Spahl,1983)
Arcade

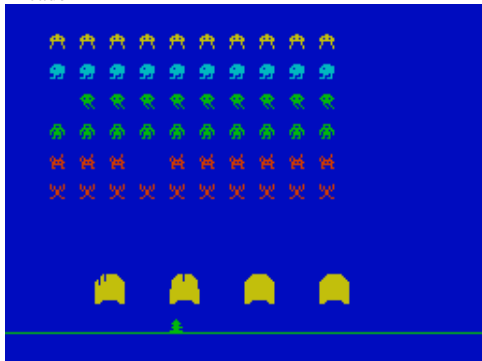

Space Doubt (CRL Group PLC.)
Text Adventure

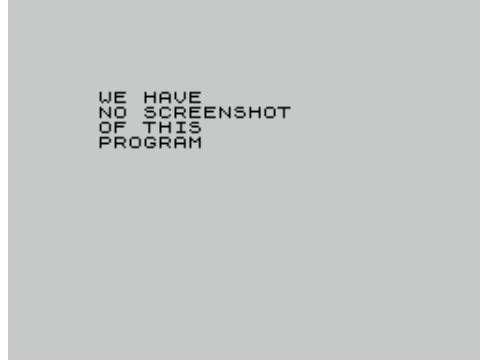

Space Fighter (Wintersoft,1983)
Arcade



Space Harrier (Elite Systems Ltd,1986)
Simulation



Space Hunter (MicroHobby,1989)
Arcade



Space Invaders (Wintersoft,1983)
Arcade

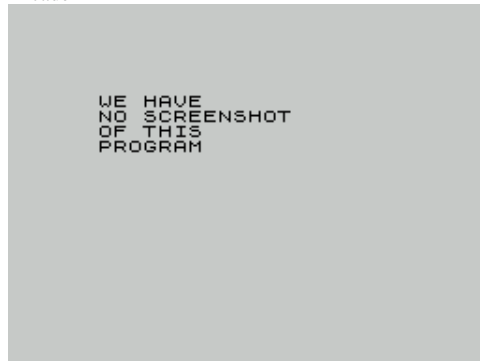

Spaced Out (Firebird Software Ltd,1987)
Board/Card Game



Space Fright (Data Design Systems,1985)
Arcade



Space Harrier II (Grandslam Entertainments Ltd,1990)
Arcade



Space Intruders (Quicksilva Ltd,1982)
Arcade



Space Invaders 2 (.)
Arcade



Space Invasion (.)
Arcade

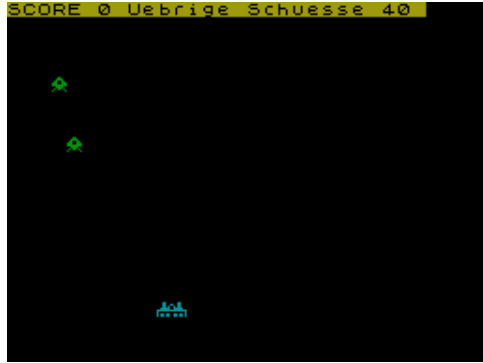

Space Lab (MicroHobby,1985)
Arcade



Space Lanes + Laser Lander (Cathedral Software,1983)
Compilation



Space Missile Command (Profisoft,1984)
Arcade

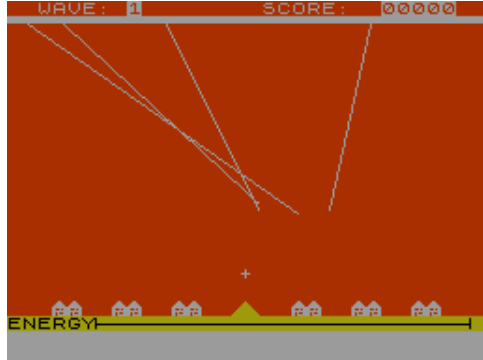

Space Odyssey (Abacus Programs,1984)
Compilation



Space Island (Terminal Software,1983)
Text Adventure

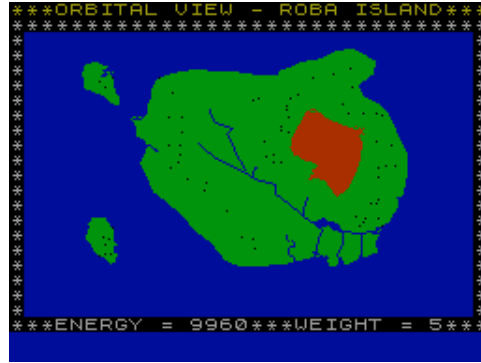

Space Landing (Gambrinus Software,1989)
Arcade

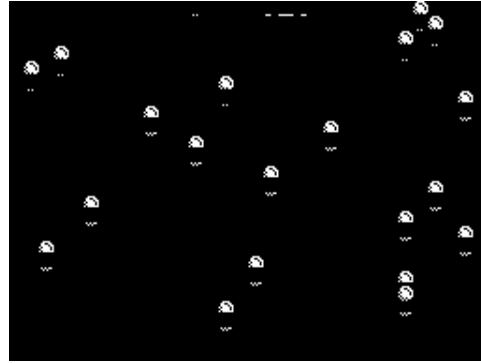

Spaceman Bob (Alchemist Research,)
Text Adventure



Space Mission (Gem Software,1984)
Arcade



Space Professor (Front Runner,1984)
Educational



Space Jack (The Power House,1988)
Arcade



Space Lanes (Cathedral Software,1983)
Arcade

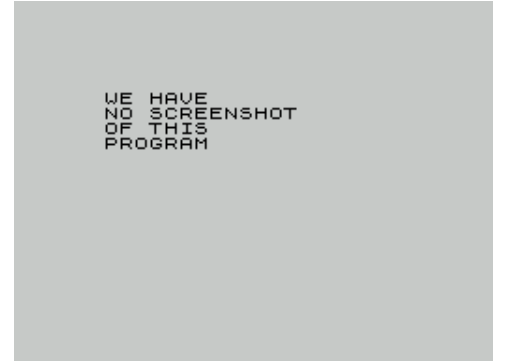

Space Mines (Fontana Publishing,1984)
Arcade



Space Observer (.)
Arcade

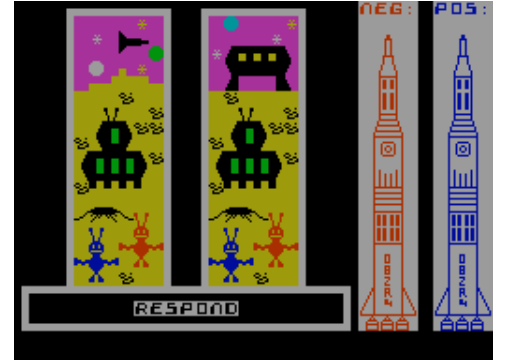

Space Quest (Your Computer,1984)
Arcade



Space Race (XFAWORLD Software,2005)
Simulation



Space Racer (Loricels,1988)
Arcade

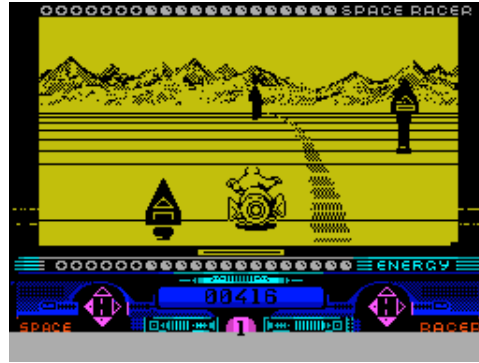

Space Raiders (Sinclair Research Ltd,1982)
Arcade



Space Rescue (Darryl LeCount,1994)
Arcade

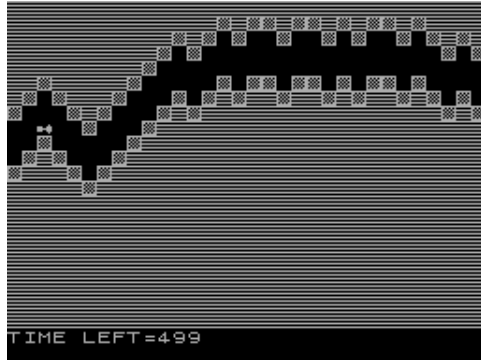

Space Rescue (Wizard Software,1986)
Arcade



Space Resque (Breadhill,1982)
Arcade



Space Rider Jet Pack Co. (Hi-Tec Software Ltd,1990)
Arcade



Space Rocus (Hipoprates Soft.)
Arcade



Space Rogue (Microprose Software Ltd.)
Arcade



Space Saving Mission (Ultravideo Software,1985)
Text Adventure

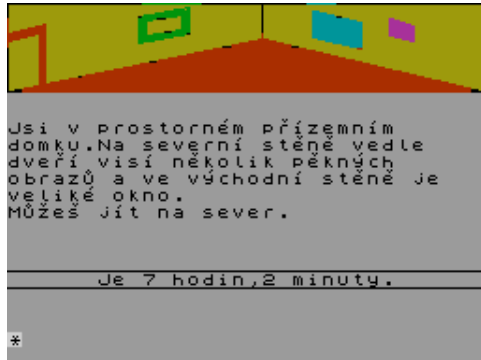

Space Scan (Macmillan Software Ltd,1985)
Educational



Spaceship (MicroHobby,1985)
Arcade



Space Ship Adventure (CP Software,1982)
Text Adventure



Space Shuttle (Accord Data Ltd,1983)
Arcade

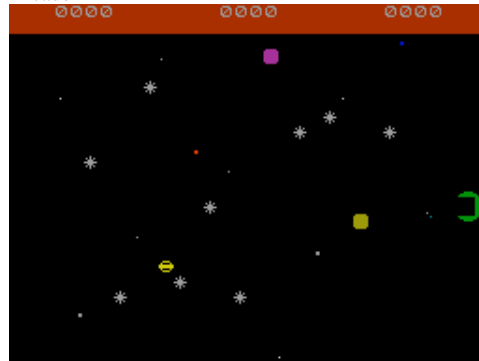

Space Shuttle (Microdeal,1984)
Simulation



Space Shuttle: A Journey into Space (Activision Inc,1984)
Arcade

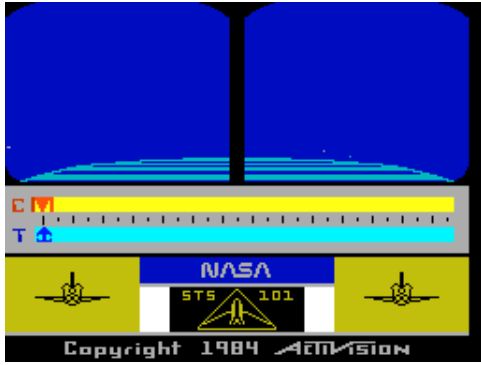

Spacestation Beta 1 (Dan B. Nielsen,1986)
Text Adventure



Space Walk (Mastertronic Ltd,1984)
Arcade



Space Warp (A.C.E. Software [3],1984)
Arcade



Space Wars, 3D (Hewson Consultants Ltd,1983)
Arcade



Space Shuttle Simulator (DK'Tronics Ltd.)
Arcade

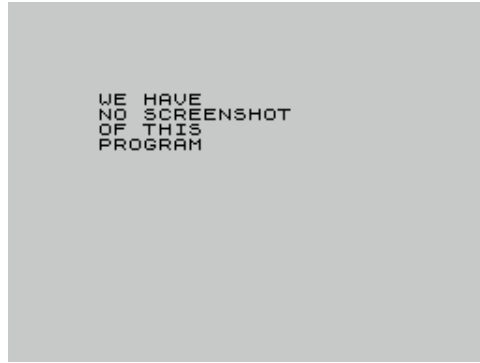

Space Station Zebra (Beyond Software,1983)
Arcade

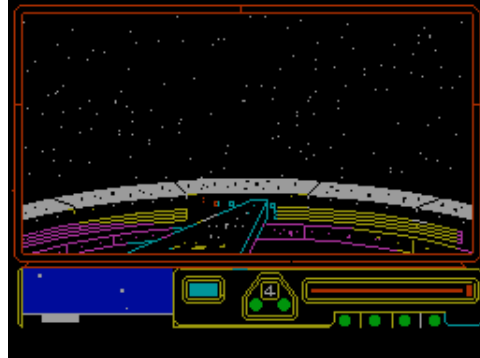

Space War (Hipocrates Soft.)
Arcade

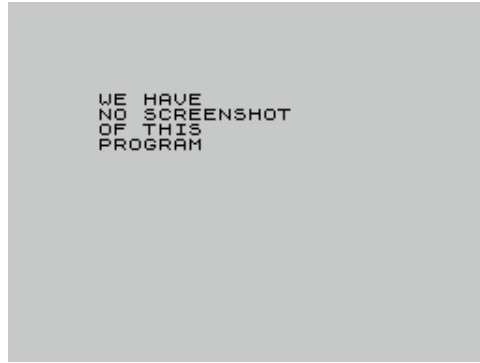

Space Warrior (Automata UK Ltd,1985)
Arcade



Spaceway (Decibel,)
Arcade



Space Smugglers (MHT Ingenieros S.L.,1989)
Arcade

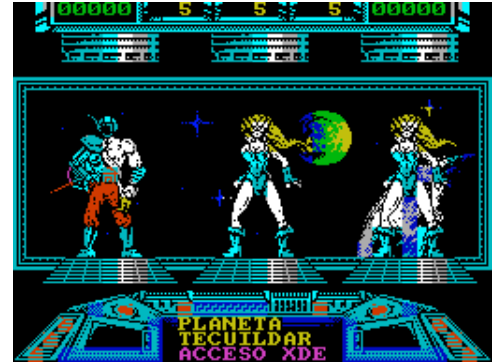

Space Traid (Pavel Nikitin,1993)
Strategy

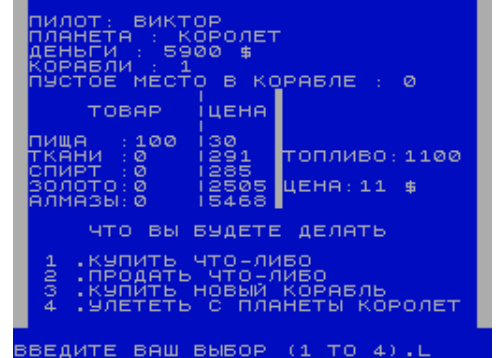

Space War (MicroHobby,1985)
Arcade



Space Wars (CPL Computing,1982)
Arcade



Space Worm (Crash,1991)
Arcade



Space Worm (Psychaedelic Hedgehog Software,1992)
Arcade



Space Wreck (Big Ben Software,1983)
Strategy



Spacewreck (Premier Software,1984)
Educational



SPACE X (4Mation Educational Resources Ltd,1984)
Educational

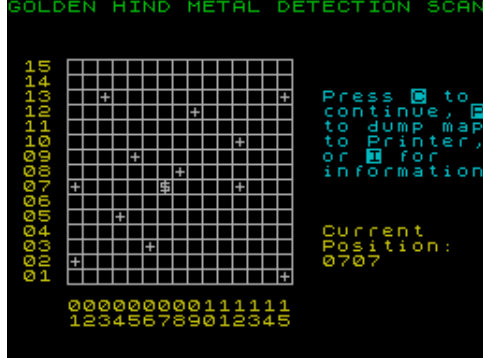

Space Zombies (Mikro-Gen Ltd,1983)
Arcade



Spaghetti Western Simulator (Zeppelin Games Ltd,1990)
Arcade

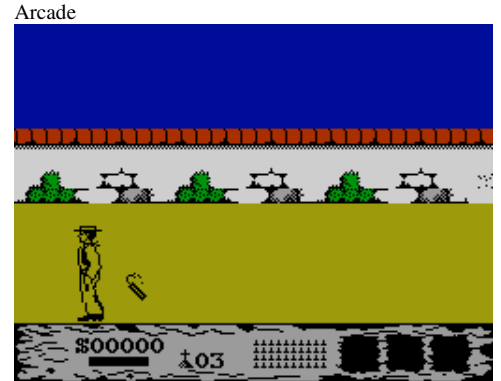

Spahl Copy (Aqua Soft,1983)
Utility: Copier



Spanish Gold (Chalksoft Ltd,1983)
Text Adventure

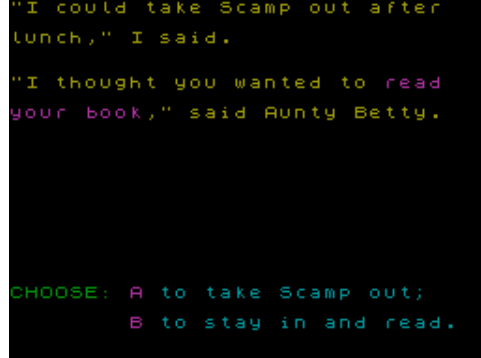

Spanish is Fun (CDS Microsystems,1985)
Educational



Spanish Tutor, The: Level A (Kosmos Software Ltd,1984)
Educational

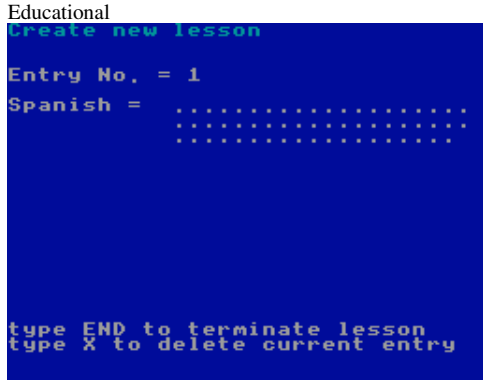

Spanish Tutor, The: Level B (Kosmos Software Ltd,1984)
Educational



Spark (Load 'n' Run [Ita],1989)
Arcade

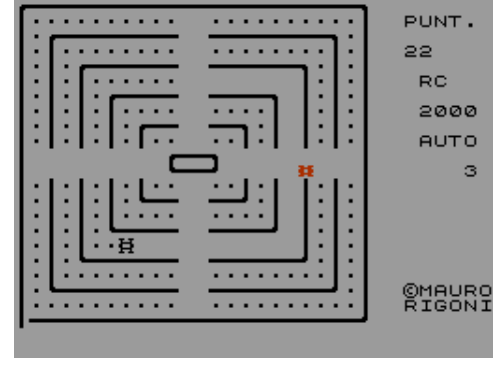

Spar-Key (.)
Utility: Copier



Sparklers Special (Creative Sparks,1985)
Compilation

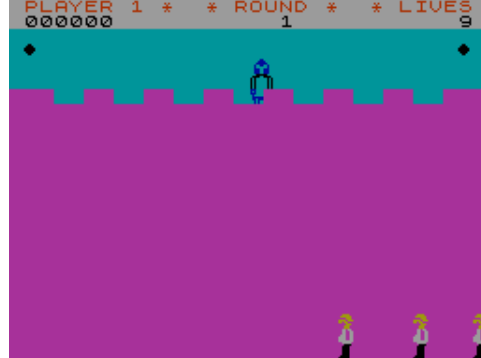

Spawn of Evil (DK'Tronics Ltd,1983)
Arcade

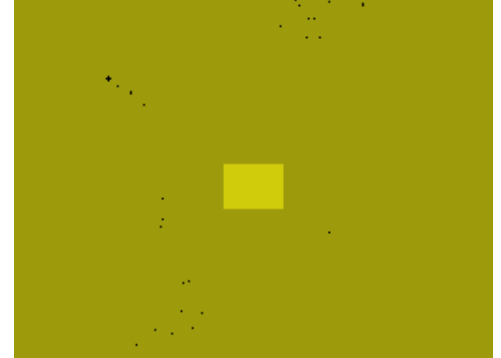

SPDE (Campbell Systems,1982)

Utility: Programming

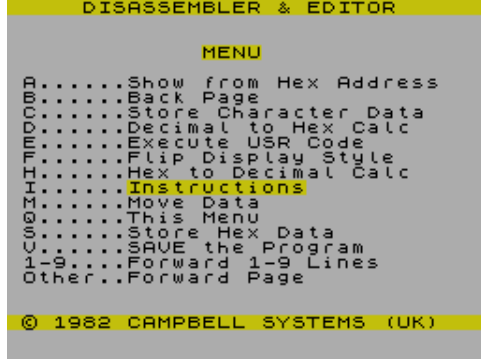

Speakeasy (Quicksilva Ltd,1982)

Utility: Sound Manipulation

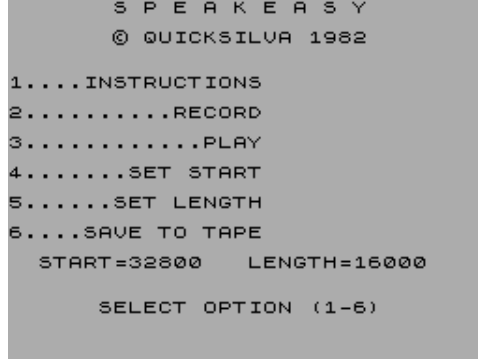

Speaker (Psian Software Ltd,1988)

Utility: Sound Manipulation

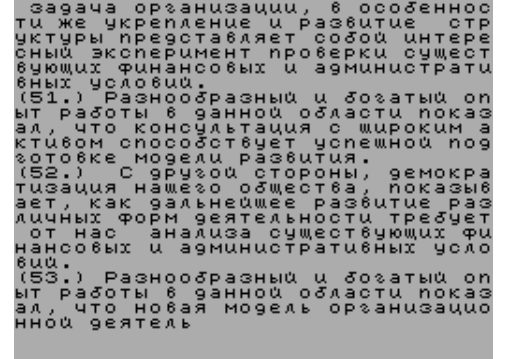

Spearhead (CRL Group PLC,1987)

Simulation



SP-Easel (Todospectrum,)

Utility: Mathematics



Specbug (Artic Computing Ltd,1982)

Utility



Specifax Picturebase (Roybot,1987)

Utility



Speccopy (.)

Utility: Copier

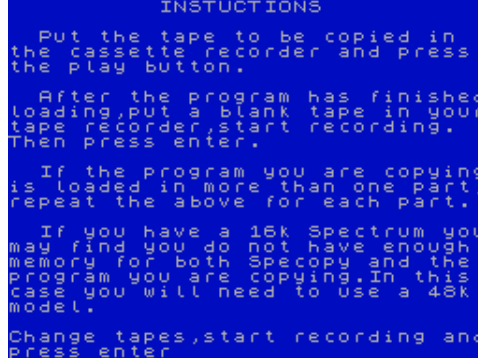

Specycalista Kronika (Jatekgyaros,2005)

Simulation



Specy Demo (Betasoft,)

Scene Demo



Specy Minigame Collection (Russell Marks,2003)

Compilation



Specy Pairs (Pedro Romero,2003)

Arcade

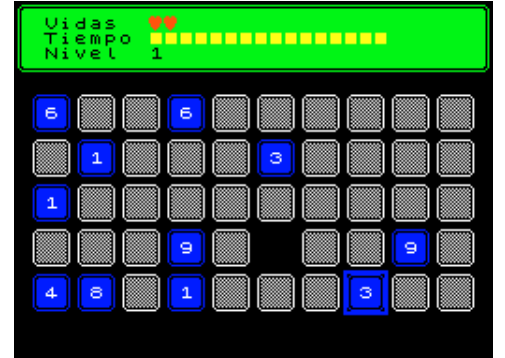

Specy Simon (Cheese Freak Software,1996)

Board/Card Game

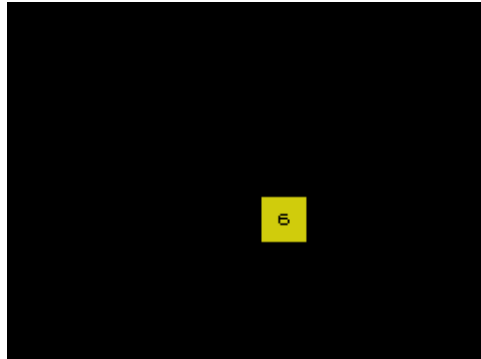

Specdicul! (Matand Software,1986)

Demo



SpecDrum (Cheetahsoft Ltd,1985)

Utility: Music Creation



SpecDrum - Afro Kit (Cheetahsoft Ltd,1985)

Utility: Music Creation



SpecDrum>Music Machine Convertor (Simon N. Goodwin,1988)

Utility



Specgraf (Anirog Software,1984)

Utility: Font/UDGs



Special Corps (Ivan Gudkov,1996)

Strategy



Special POKE 2 (Fuxoft,1986)

Cheat

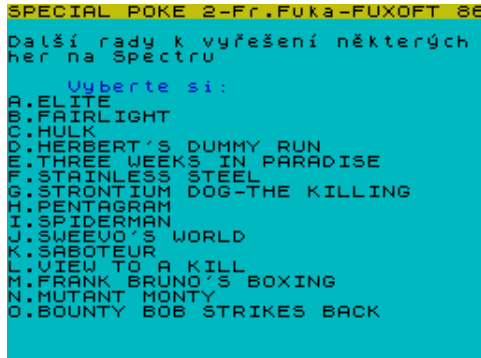

SpecDrum - Electro Kit (Cheetahsoft Ltd,1985)

Utility: Music Creation



Specfile+ (S.D. Software,1998)

Utility



Special Action (Ocean Software Ltd,1989)

Compilation



Special Delivery (Creative Sparks,1984)

Arcade



Special POKE III (Fuxoft,)

Cheat



SpecDrum - Latin Kit (Cheetahsoft Ltd,1985)

Utility: Music Creation



Spec-GAC-ular Vol 1 (The Guild,)

Compilation

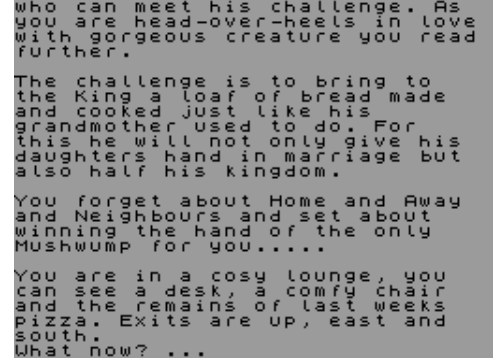

Special Agent (Heinemann/Hill MacGibbon,1983)

Simulation



Special Operations (MC Lothlorien Ltd,1984)

Strategy



Special POKE III Editor (Softhouse Ltd,1990)

Utility



Specific (A'n'F Software,1983)
Utility



Specky Lecky (New Dimension,1984)
Simulation



Spec Man (Jega Software,1982)
Arcade

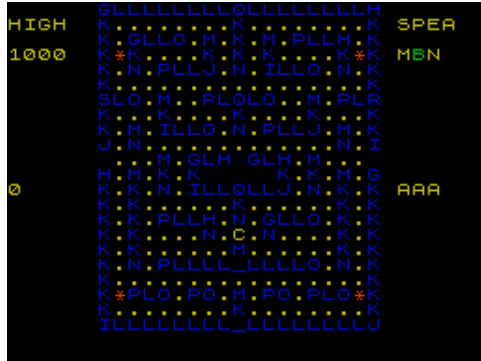

Specpanel (K.S. Beddoe,1983)
Utility: Assembler/Disassembler/Monitor

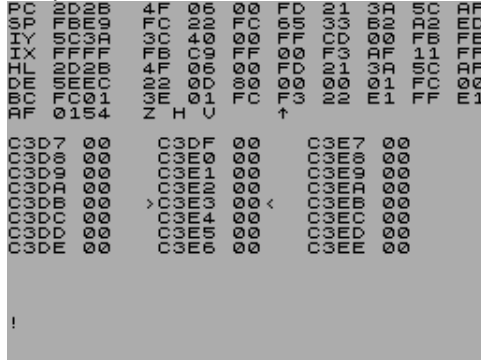

Spec-Sound (Spectrum Computing,1985)
Utility: Sound Manipulation



Specimen (Crash,1990)
Arcade



Specman (C-Tech,1982)
Arcade

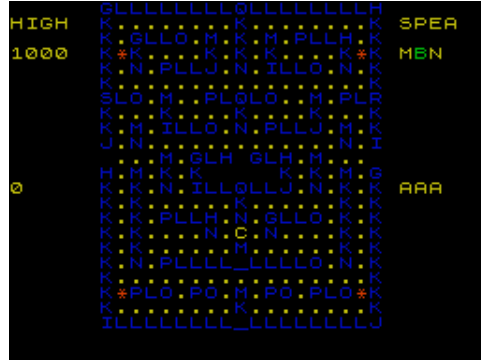

Specmap1 (Outlet Microdrive Magazine,1989)
Utility: Screen Manipulation



Specrealm (ACD Computer Services,1986)
Strategy



Specsound (Your Computer,1983)
Utility: Music Creation

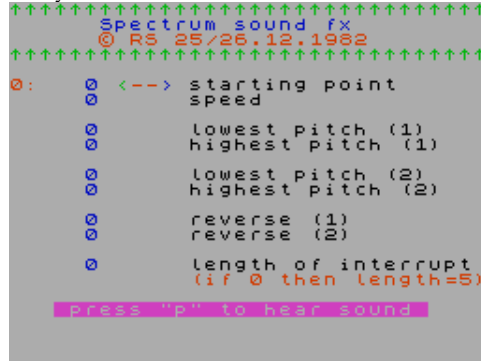

Specimen II: The Apple Quest (Crash,1991)
Arcade



Specman (Impact Software [1],1983)
Arcade



Specmunch (Spartan Software,1984)
Arcade



Spec Soccer (Top Spec,1986)
Compilation



Spectacle (Design Design Software,1984)
Simulation



Spectacle 2 (Design Design Software,1986)



Specta Draw (Bryan S. McAlley,1983)



Specta Draw 2 (Bryan S. McAlley,1983)

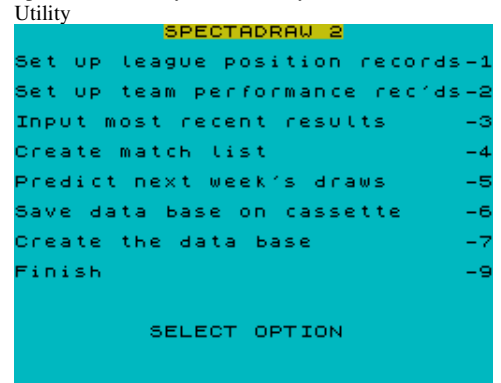

Specta Draw 3 (Bryan S. McAlley,1983)



Spectasort (Bryan S. McAlley,1984)



Spectel (Vidicode,1982)



Specterm (Raats/Versluis/Weijgers,1991)

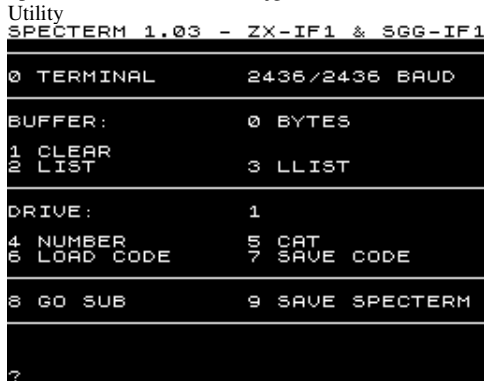

Spectext (McGraw-Hill Book Company UK Ltd,1985)

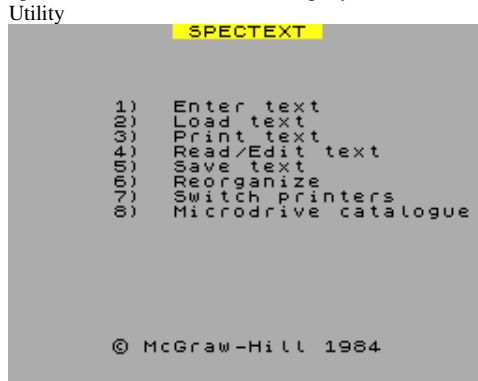

Spectipede (R&R Software Ltd,1983)

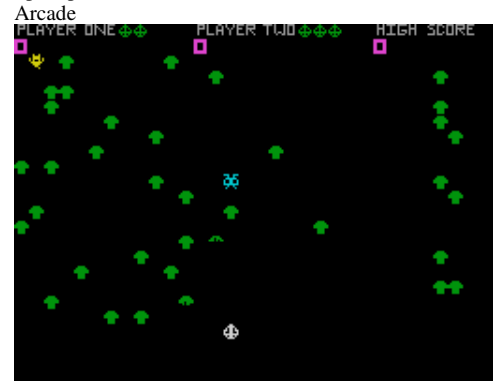

Spectool (Mikro-Gen Ltd,1983)



Spectral Invaders (Bug-Byte Software Ltd,1982)



Spectral Maze, 3D (Newsoft Products,1982)



Spectral Panic (Hewson Consultants Ltd,1983)

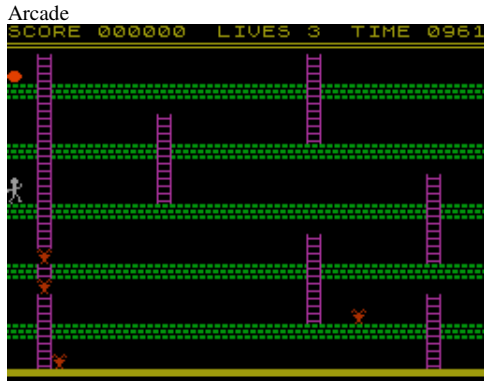

Spectral Writer (Softek Software International Ltd,1984)

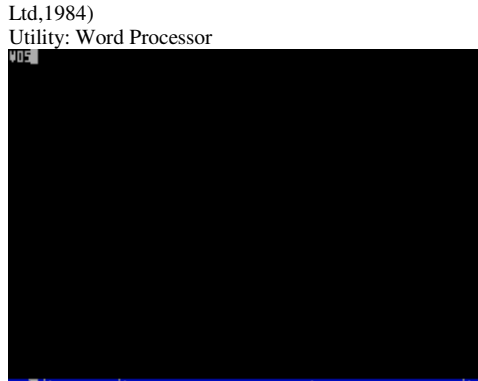

Spectramon (ASP Software Ltd,1983)

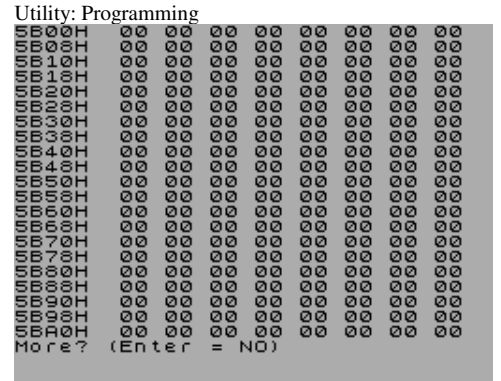

Spectrapede (Protek Computing Ltd,1983)
Arcade

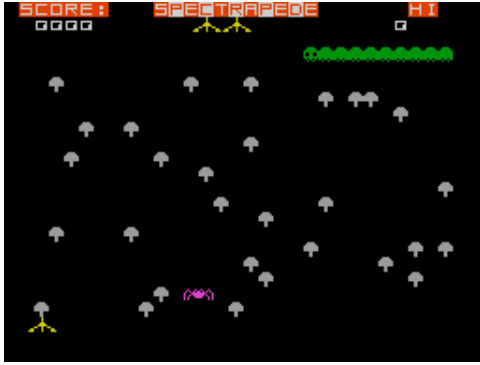

Spectra Smash + Break Out (Romik Software,1983)
Compilation



Spectraxe issue 03 (Spectraxe Tape Magazine,1987)
Covertape



Spectraxe issue 06 (Spectraxe Tape Magazine,1988)
Covertape



Spectraxe issue 09 (Spectraxe Tape Magazine,1988)
Covertape



Spectraprobe (Artic Computing Ltd,1983)
Arcade



Spectraxe issue 01 (Spectraxe Tape Magazine,1987)
Covertape



Spectraxe issue 04 (Spectraxe Tape Magazine,1987)
Covertape

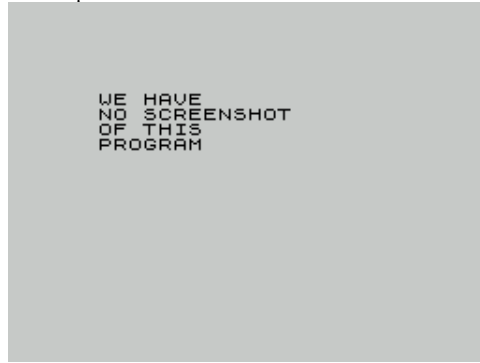

Spectraxe issue 07 (Spectraxe Tape Magazine,1988)
Covertape



Spectraxe issue 10 (Spectraxe Tape Magazine,1988)
Covertape



Spectra Smash (Romik Software,1983)
Arcade



Spectraxe issue 02 (Spectraxe Tape Magazine,1987)
Covertape



Spectraxe issue 05 (Spectraxe Tape Magazine,1988)
Covertape



Spectraxe issue 08 (Spectraxe Tape Magazine,1988)
Covertape



Spectraxe issue 11 (Spectraxe Tape Magazine,1988)
Covertape



Spectrxxx issue 12 (Spectrxxx Tape Magazine,1988)
Covertape



Spectrechess (Oasis Software,1984)
Board/Card Game

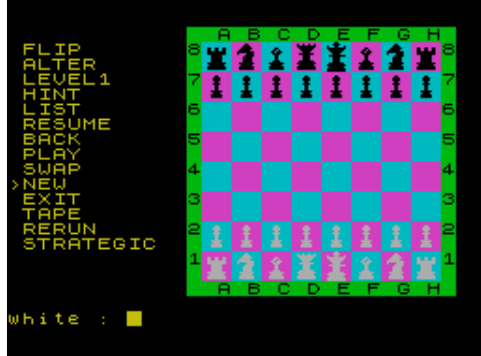

Spectre-Mac-Mon (Oasis Software,1983)
Utility: Assembler/Disassembler/Monitor



Spectre of Larry Horsfield, The (The Fly On The Wall)
Text Adventure

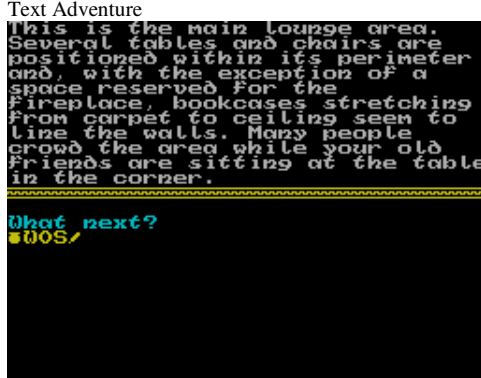

SpecTRIS (Gustavo Brown Rodriguez,2003)
Arcade



Spectream (Runesoft,1984)
Simulation

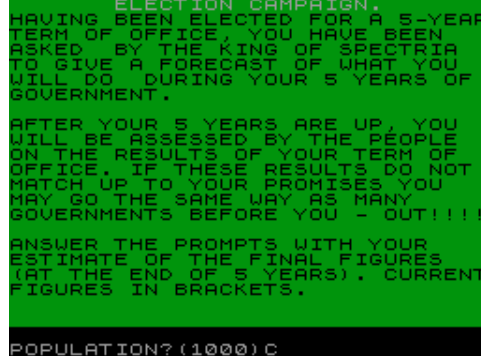

Spectrek (Micropress [2],1985)
Simulation



Spectre of Booballyhoo, The (Infected Software,1987)
Text Adventure

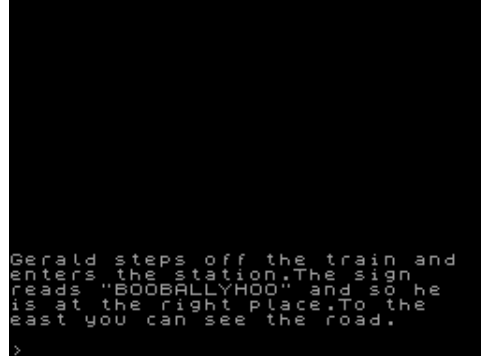

Spectres (Bug-Byte Software Ltd,1982)
Arcade

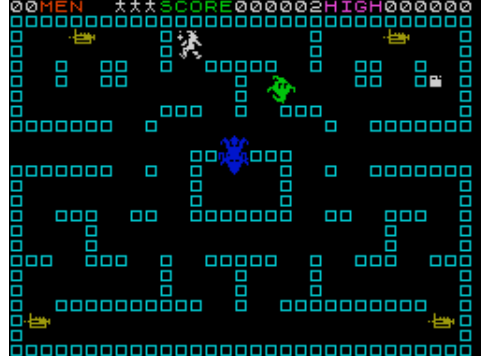

Spectrographics (Bridge Software,1983)
Utility



Spectrec (Palantir,1983)
Arcade



Spec Trek (Specy Basher,1984)
Arcade



Spectre of Castle Coris (FSF Adventures,1990)
Text Adventure



Spectris (Church of the Latter Day Specy,1996)
Arcade



Spectroid Storm (Abersoft,1983)
Arcade



Spectron (Virgin Games Ltd,1983)
Arcade

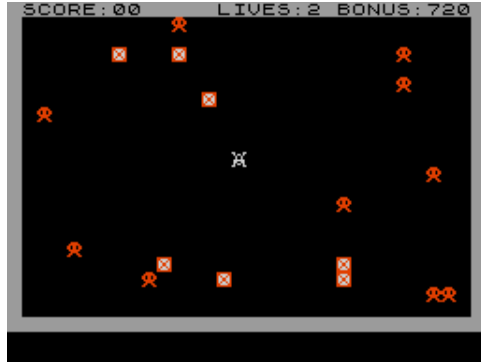

Spectrosim (Shiva Publishing Ltd,1983)

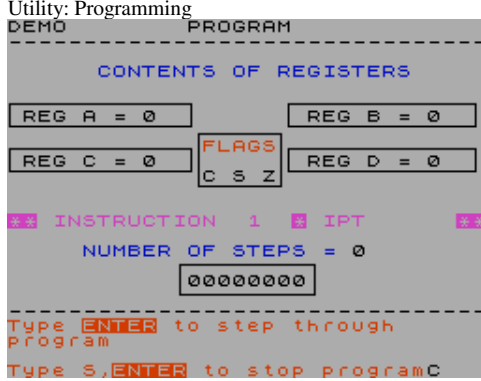

Spectrum 4 (Durell Software Ltd,1987)
Compilation



Spectrum 50 Games (U.T.S.,1983)
Compilation



Spectrumania 1/01 (Ventamatic,1984)
Covertape



Spectropedes (EMM Software,1984)
Arcade

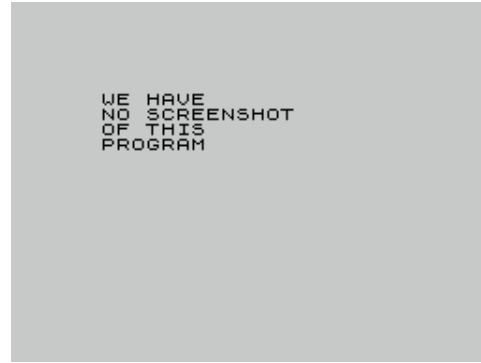

Spectroskop (Astro-Service Maitenbeth,1983)

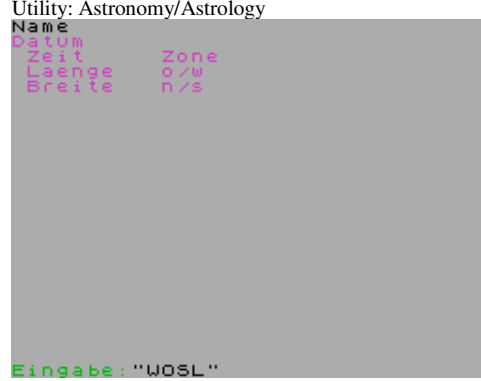

Spectrum 48K Sample Cassette (Sulis Software Ltd,1983)

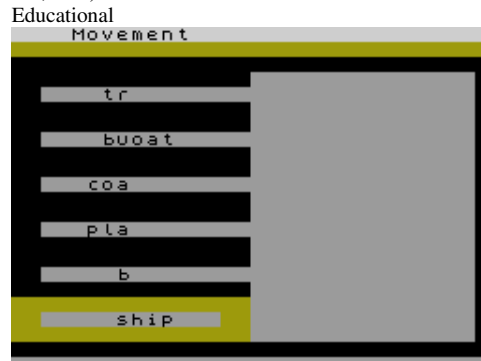

Spectrum Action Pack (Paxman Promotions,1985)
Compilation



Spectrumania 1/02 (Ventamatic,1984)
Covertape



Spectroscoop IV (E.O. Eshuis,1984)
Utility: Astronomy/Astrology

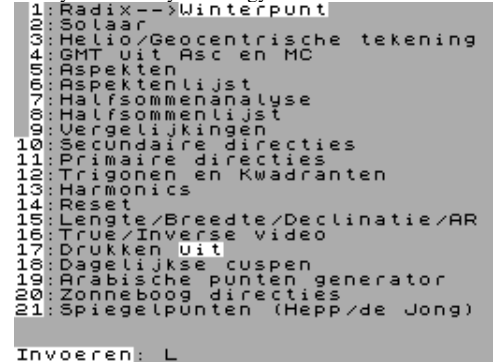

Spectrum 128K Music Demo (Andy Brown,1988)

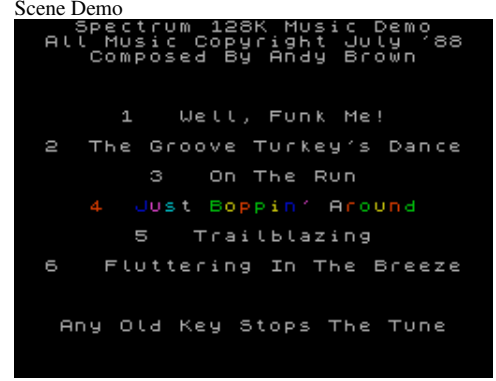

Spectrum 4 Pack (Paxman Promotions,)
Compilation



Spectrum Adventures (McGraw-Hill Book Company UK Ltd,1983)
Compilation



Spectrumania 1/03 (Ventamatic,1984)
Covertape



Spectrumania 1/04 (Ventamatic,1984)
Covertape



Spectrumania 2/01 (Ventamatic,1985)
Covertape



Spectrumania 2/02 (Ventamatic,1985)
Covertape



Spectrumania 2/03 (Ventamatic,1985)
Covertape



Spectrumania 2/04 (Ventamatic,1985)
Covertape



Spectrum Animation (16/48 Tape Magazine,1984)
Demo



Spectrum Arcade Pack (C-Tech,1982)
Compilation



Spectrum Assembler (Artic Computing Ltd,1982)
Utility: Assembler/Disassembler/Monitor

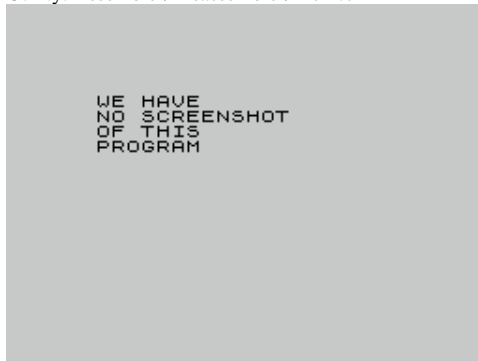

Spectrum Assembler (Hamish Rust,1988)
Utility: Assembler/Disassembler/Monitor



Spectrum Assembler 2 (Artic Computing Ltd,1984)
Utility: Assembler/Disassembler/Monitor



Spectrum Basic Programming Course (Honeyfold Software,1984) Educational

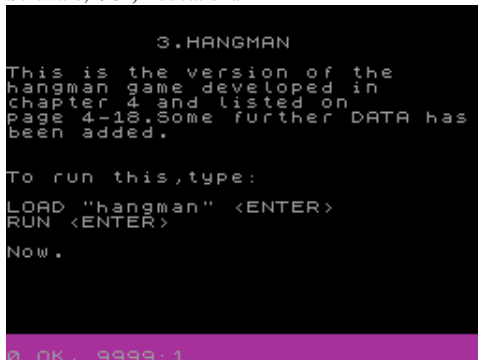

Spectrum Bowls (,1984)
Arcade



Spectrum Bug 2 (Artic Computing Ltd,1982)
Utility: Assembler/Disassembler/Monitor



Spectrum C.A.D. (Profisoft,1984)
Utility: Screen Manipulation

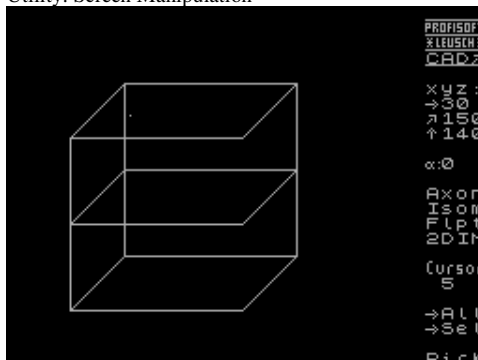

Spectrum Cassette 4802 (Courbois Software,1984)
Compilation



Spectrum Chess (Artic Computing Ltd,1982)
Board/Card Game

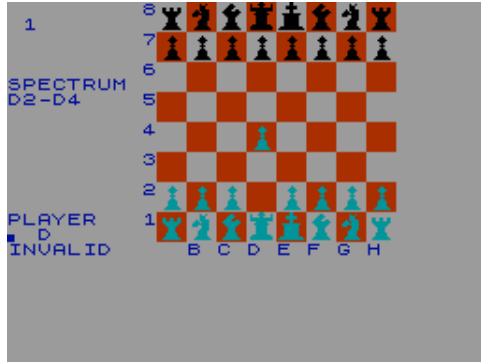

Spectrum Computing 01 (Spectrum Computing,1983)
Covertape



Spectrum Computing 04 (Spectrum Computing,1983)
Covertape



Spectrum Computing 07 (Spectrum Computing,1984)
Covertape



Spectrum Computing 10 (Spectrum Computing,1984)
Covertape



Spectrum Chess II (Artic Computing Ltd,1982)
Board/Card Game

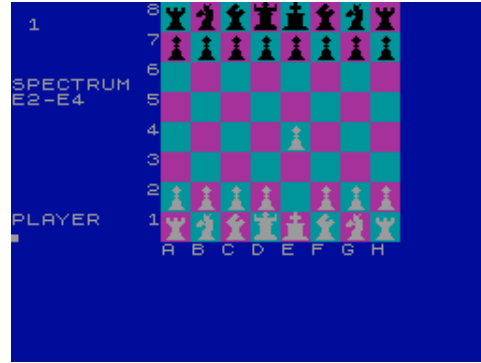

Spectrum Computing 02 (Spectrum Computing,1983)
Covertape



Spectrum Computing 05 (Spectrum Computing,1984)
Covertape



Spectrum Computing 08 (Spectrum Computing,1984)
Covertape



Spectrum Computing 11 (Spectrum Computing,1984)
Covertape



Spectrum Collection 1 (MicroHobby,1989)
Compilation

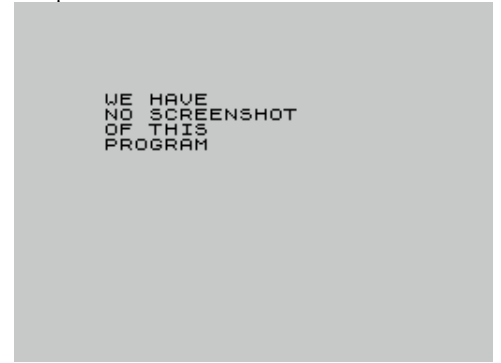

Spectrum Computing 03 (Spectrum Computing,1983)
Covertape



Spectrum Computing 06 (Spectrum Computing,1984)
Covertape



Spectrum Computing 09 (Spectrum Computing,1984)
Covertape



Spectrum Computing 12 (Spectrum Computing,1985)
Covertape



Spectrum Computing 13 (Spectrum Computing,1985)
Covertape



Spectrum Computing 14 (Spectrum Computing,1985)
Covertape

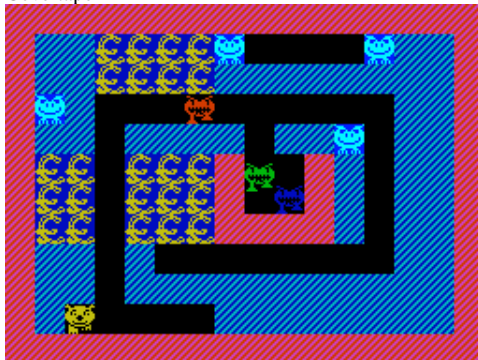

Spectrum Computing 15 (Spectrum Computing,1985)
Covertape



Spectrum Computing 16 (Spectrum Computing,1985)
Covertape



Spectrum Computing 17 (Spectrum Computing,1985)
Covertape



Spectrum Computing 18 (Spectrum Computing,1985)
Covertape



Spectrum Computing 19 (Spectrum Computing,1985)
Covertape



Spectrum Computing 20 (Spectrum Computing,1985)
Covertape



Spectrum Computing 21 (Spectrum Computing,1986)
Covertape



Spectrum Computing issue 1 (Compulogical
S.A.,1984)
Covertape



Spectrum Computing issue 2 (Compulogical
S.A.,1984)
Covertape



Spectrum Computing issue 3 (Compulogical
S.A.,1984)
Covertape



Spectrum Computing issue 4 (Compulogical
S.A.,1985)
Covertape



Spectrum CP/M (Locomotive Software,1988)
Utility

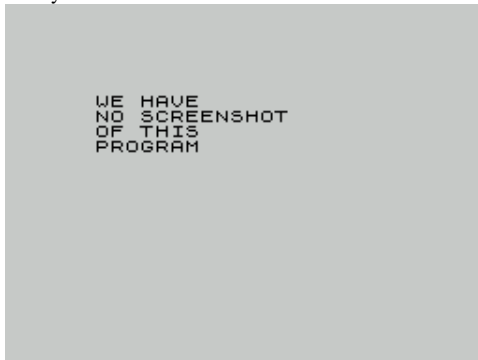

Spectrum CP/M Plus + Mallard BASIC (Locomotive
Software,1988) Compilation



Spectrum Cricket (Wizard Software,1984)
Sport



Spectrum Demonstration (Oxford Computer Publishing,1982)
Educational

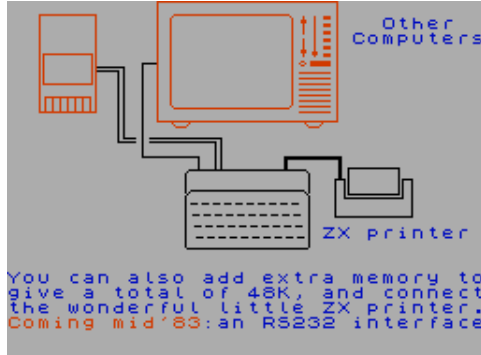

Spectrum EDV (.)
Utility: Database

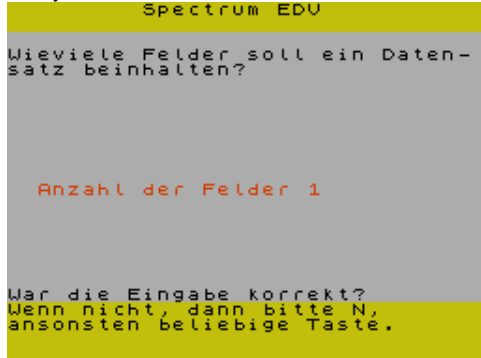

Spectrum Forth (Artic Computing Ltd,1982)
Utility: Programming

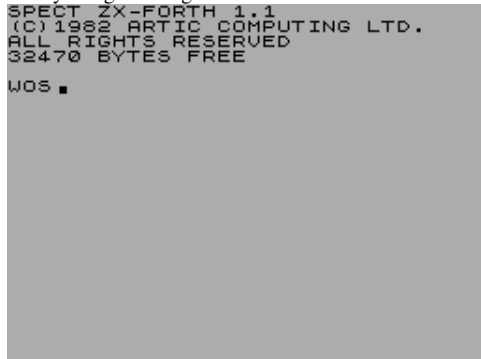

Spectrum Forth Game (CP Software,1983)
Arcade

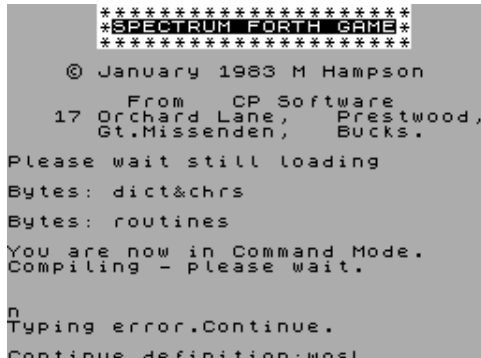

Spectrum Database (Gemini Marketing Ltd,1984)
Utility: Database



Spectrum Dice (Granada Publishing,1983)
Board/Card Game

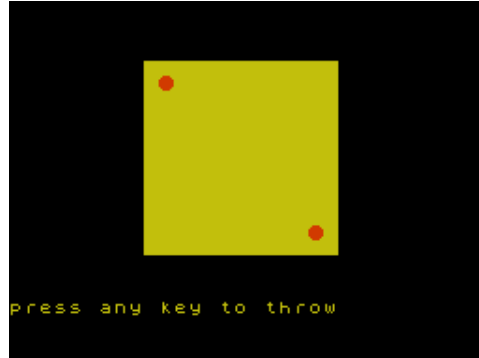

Spectrum Electronics - CCT (Spectre,1982)
Utility: Electronics

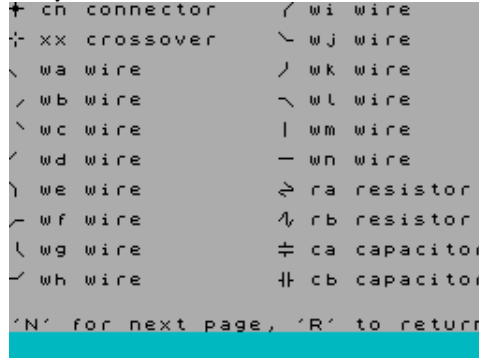

Spectrum Forth (CP Software,1983)
Utility: Programming

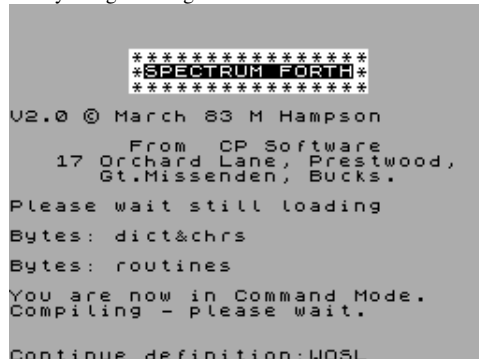

Spectrum Games (Serious Software,1982)
Compilation



Spectrum DBMS (.)
Utility: Database



Spectrum Doodler Lightpen (F.E. Electronics,1985)
Utility



Spectrum File (Sinclair Programs,1983)
Utility: Database

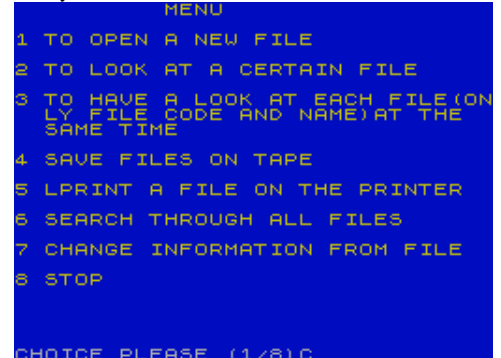

Spectrum Forth Converter (Zero-Plus,1986)
Utility: Programming



Spectrum Game Writers' Pack (Collins Educational,1983)
Arcade

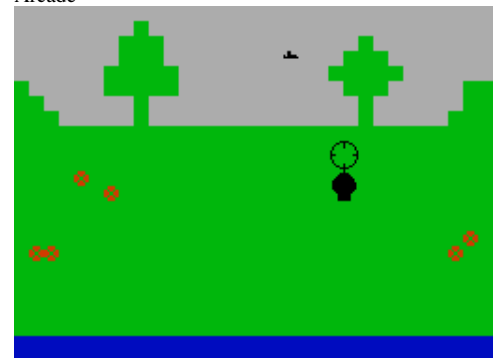

Spectrum Golf (Bryan S. McAlley,1983)
Sport



Spectrum Graphics LOGO (Sigma Press.)
Utility: Programming



Spectrum Graph Plot (Gemini Marketing Ltd,1984)
Utility: Screen Manipulation

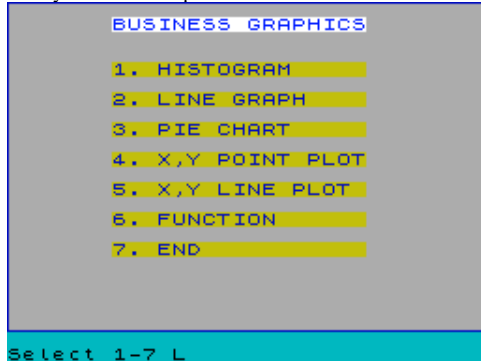

Spectrum Interrupts (.)
Utility

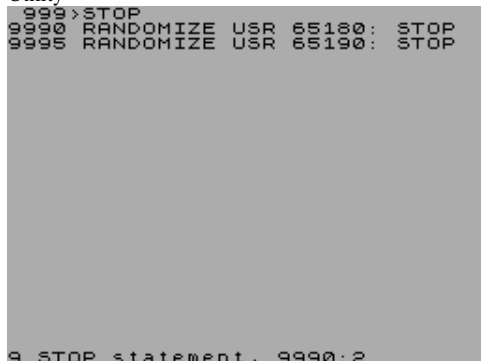

Spectrum Juggler (UK Lead,1987)
Scene Demo

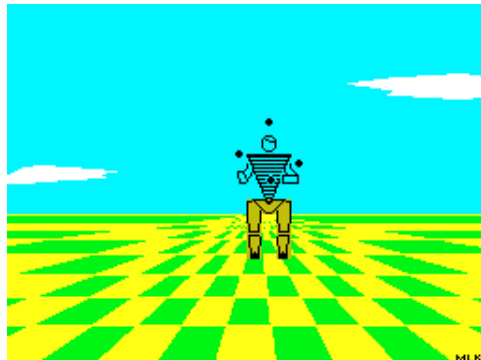

Spectrum Golf (R&R Software Ltd,1982)
Sport



Spectrum Graphics Machine, The (McGraw-Hill Book Company UK Ltd,1984) Utility: Programming



Spectrum Home Accounts (Gemini Marketing Ltd,1984)
Utility: Spreadsheet

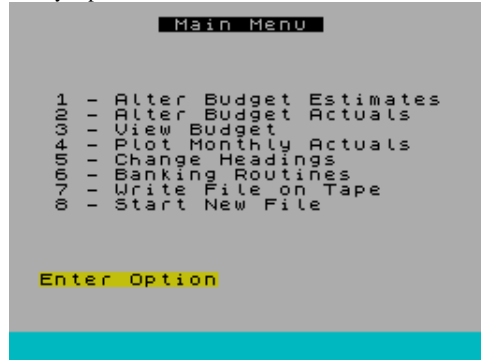

Spectrum Intruders (CPL Computing,1982)
Arcade



Spectrum Ledger (Granada Publishing,1983)
Arcade



Spectrum Graphics Kit (Kempston Micro Electronics Ltd,1987) Utility



Spectrum Graphics Toolkit (JRS Software Ltd,1983)
Utility: Drawing



Spectrum Integer Compiler (Threlfall & Hodgson,1982)
Utility: BASIC Related

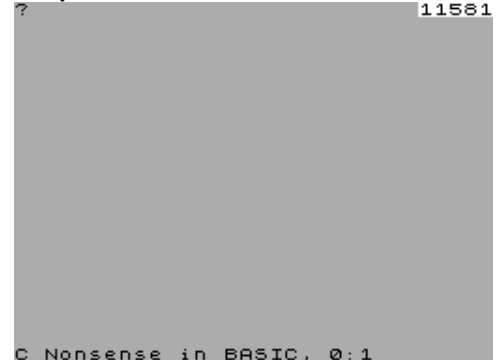

C Nonsense in BASIC, 0:1
Spectrum Invaders (Granada Publishing,1983)
Arcade

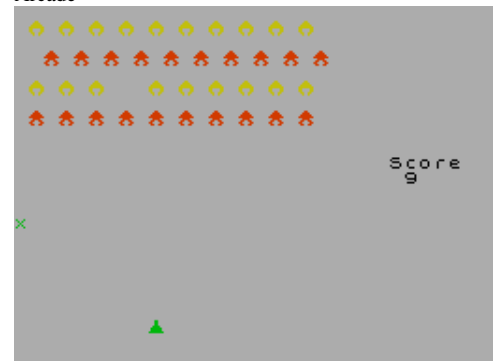

Spectrum Mailist (Gemini Marketing Ltd,1984)
Utility: Database



Spectrum Markbook (Mentor Software,1984)

Utility

CLASS 1CL MAX=340

	1	2	3	4	5	TOT.
BIRD.S	400	400	000	000	000	0000
BOYDELL.J	000	000	000	000	000	0000
CLARKE.L.G.	000	000	000	000	000	0000
CLINNING.G.A	000	000	000	000	000	0000
COURBET.C.A	000	000	000	000	000	0000
DOBSON.A	100	000	000	000	000	0000
DORAN.R	000	000	000	000	000	0000
EVERSON.S	000	000	000	000	000	0000
GALLAGHER.S	000	000	000	000	000	0000
GREENE.L	000	000	000	000	000	0000
HARTIN.D	000	000	000	000	000	0000
HOBART.C	000	000	000	000	000	0000
HOYLE.F.A	000	000	000	000	000	0000
HUGGINS.S.J	000	000	000	000	000	0000
MANTLE.C.J	000	000	000	000	000	0000
GITTOES.A	000	000	100	000	000	0000

Spectrum Morse (Sinclair Programs,1983)

Utility

ENTER YOUR ANSWER FOR EACH BLOCK

"WOSC"

Spectrum NIM (Your Computer,1982)

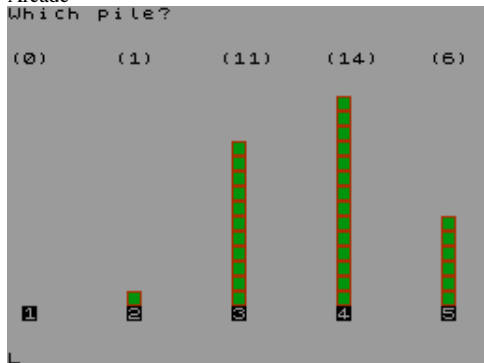

Spectrum Scrabble (Granada Publishing,1983)

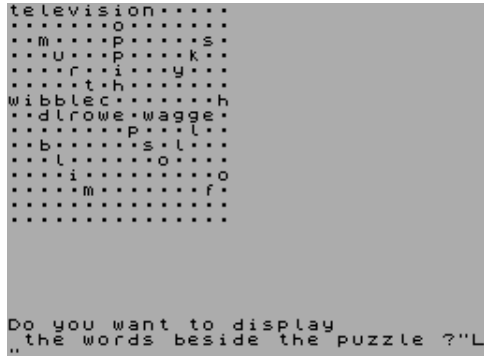

Spectrum-Skat (,1983)



Spectrum Micro Chess (Artic Computing Ltd,1983)

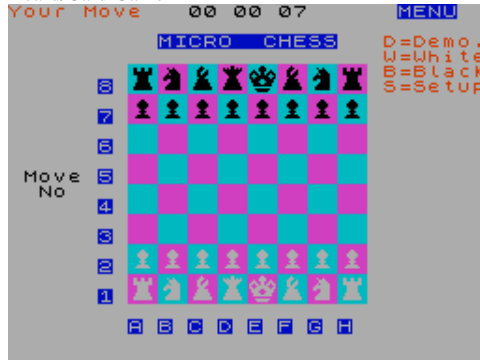

Spectrum Musical (MicroHobby,1985)



Spectrum Online Tape A (Elite Systems Ltd,1985)



Spectrum Scramble (Work Force,1982)

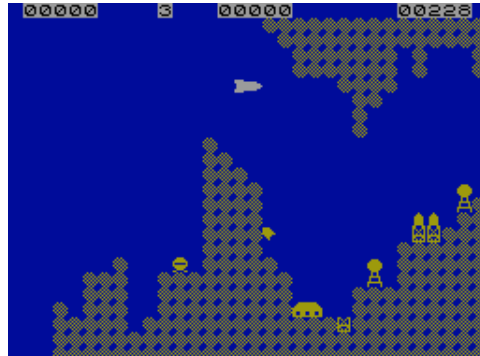

Spectrum-Sketch (Klaus Jahn,)

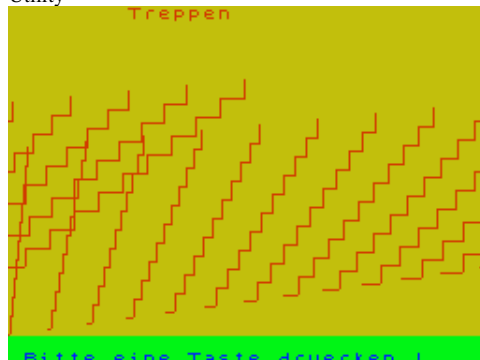

Spectrum Monitor (Picturesque,1982)

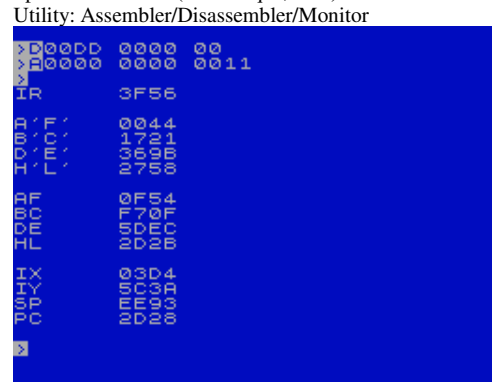

Spectrum Musicmaker (Your Computer,1984)

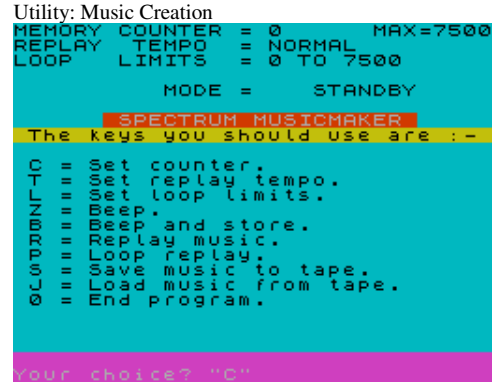

Spectrum Safari (CDS Microsystems,1983)



Spectrum Shoot (Granada Publishing,1983)



Spectrum Smalltalk (Granada Publishing,1983)

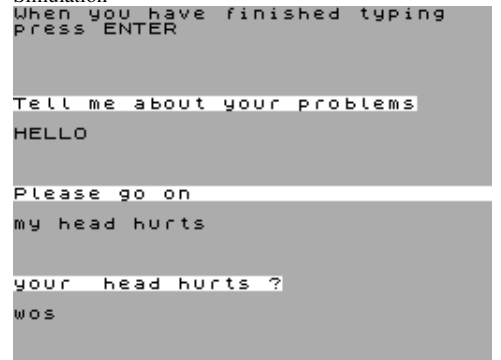

Spectrum Software (Spectrum Software,1983)
Compilation

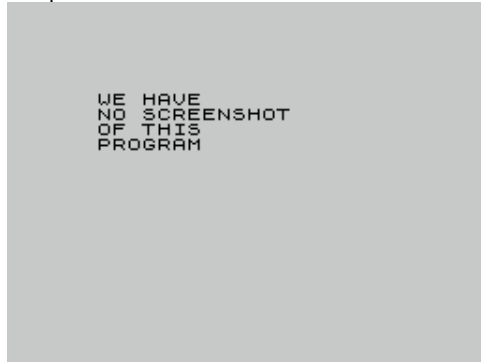

Spectrum Sound Compiler (F+K Ware,)
Utility: Music Creation

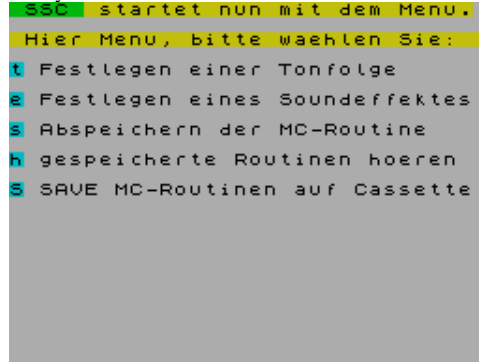

Spectrum Sound Effects (MFM Data Services Ltd,1984)
Utility



Spectrum Sound FX (Marolli-Soft,1982)
Utility: Sound Manipulation

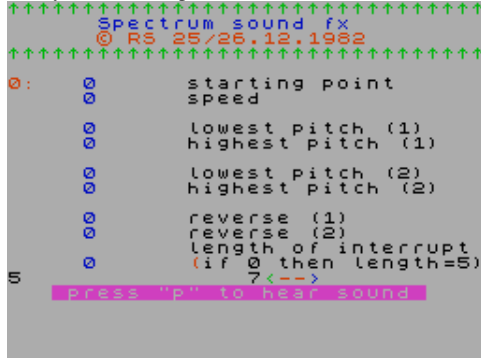

Spectrum Special 1 (Shiva Publishing Ltd,1983)
Compilation



Spectrum Special 2 (Shiva Publishing Ltd,1983)
Compilation



Spectrum Special 3 (Shiva Publishing Ltd,1983)
Compilation



Spectrum & Spectrum+ Assembly Language Course (Glentop Publishers Ltd,1985) Utility:
Assembler/Disassembler/Monitor



Spectrum Sprites (Interactive Software People,1984)
Utility: Drawing



Spectrum Sprites Generator (Ionis Software International,1983) Utility: Drawing



Spectrum Star Atlas, The (16/48 Tape Magazine,1984)
Educational



Spectrum Starter Pack 1 (Collins Educational,1983)
Compilation



Spectrum Starter Pack 2 (Collins Educational,1983)
Compilation



Spectrum Starwar Pack (Paxman Promotions,1985)
Compilation



Spectrum Stingers (US Gold Ltd,1987)
Compilation



Spectrum Substrike (,1984)
Simulation

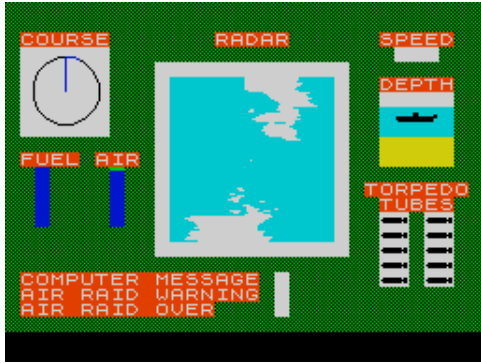

Spectrum Top Hits 1 (Ventamatic,1985)
Compilation



Spectrum Voice Chess (Artic Computing Ltd,1982)
Board/Card Game

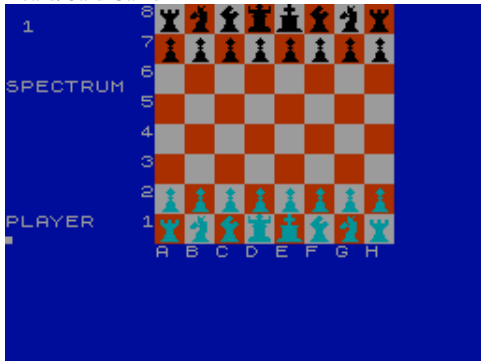

Spectsound (PDQ Software,1983)
Utility

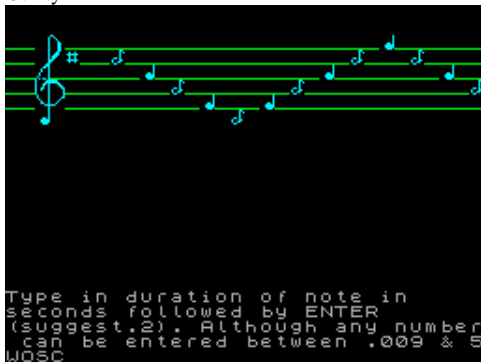

Specvaders (Hewson Consultants Ltd,1983)
Arcade



Spectrum Toolkit (David Spagnol,1985)
Utility

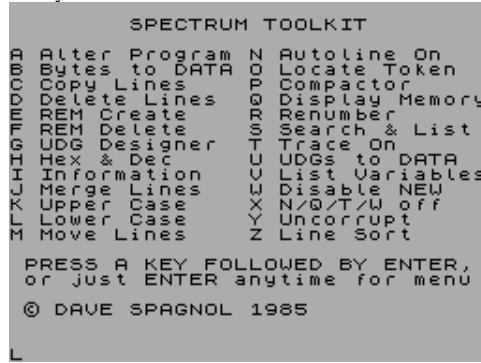

Spectrum Top Hits 2 (Ventamatic,1985)
Compilation

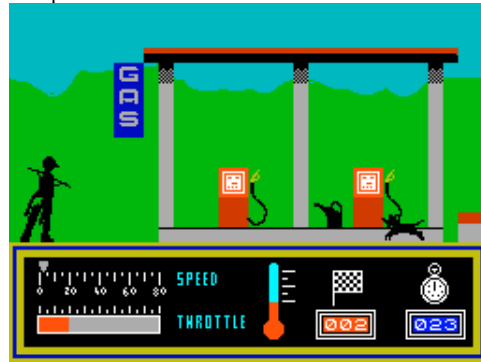

Spectrum Zap (ASP Software Ltd,1983)
Arcade

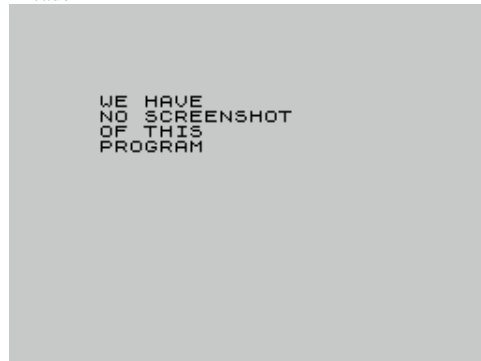

Spectune (XORsoft [1],1984)
Utility



Specventure (Mastertronic Ltd,1986)
Arcade

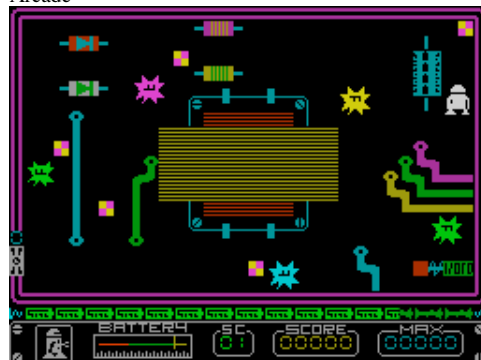

Spectrum Toolkit (Elfin Software Ltd,1983)
Utility

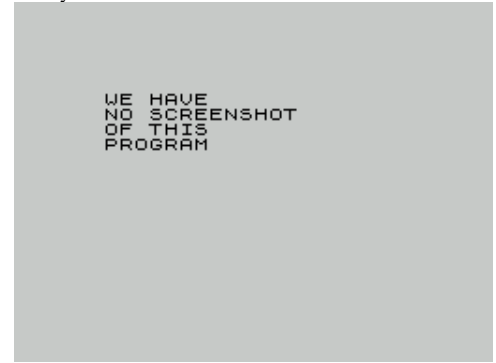

Spectrum Top Hits 3 (Ventamatic,1986)
Compilation



Spectrum Zorf (Odyssey Computing,1983)
Arcade



Speculator (Protek Computing Ltd,1983)
Board/Card Game

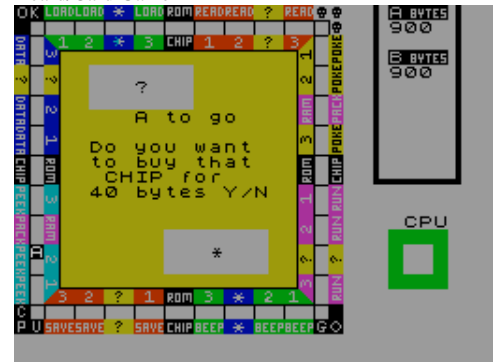

SPED 52 (Cesar Hernandez Bano,1997)
Utility: Assembler/Disassembler/Monitor

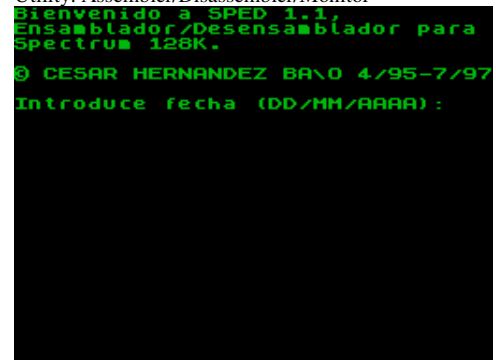

Speech (.)
Utility: Sound Manipulation

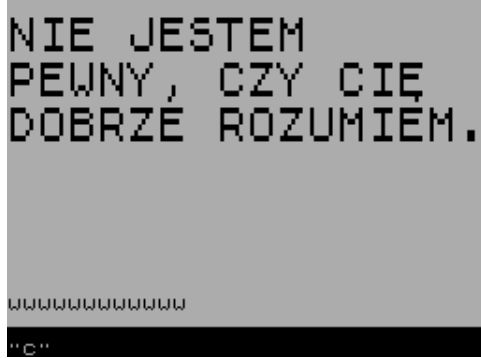

Speech Software (DK'Tronics Ltd,1985)
Utility

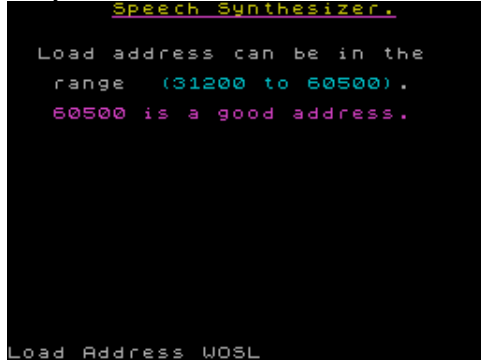

Speed 2 - No Turning Back (Technium 220,1995)
Scene Demo

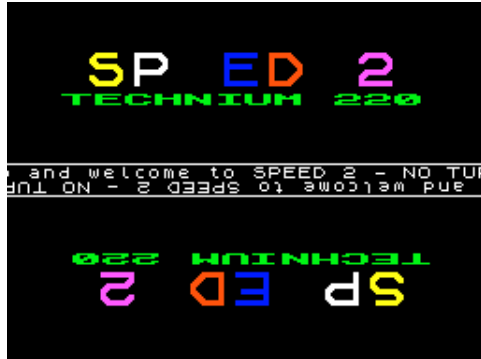

Speed Duel (DK'Tronics Ltd,1983)
Arcade



Speedload! (Your Sinclair,1992)
Utility



Speech (Stephan Slabihoud,1986)
Utility: Sound Manipulation



Speech Synthesizer (.)
Utility: Sound Manipulation



Speed Ace (Zeppelin Games Ltd,)
Arcade



Speedfile (DGF Software,1986)
Utility



Speed Office (Original Soft,1985)
Utility: Word Processor



Speech Marks (Sinclair Research Ltd,1983)
Educational



Speech System 3 (Your Sinclair,1986)
Utility

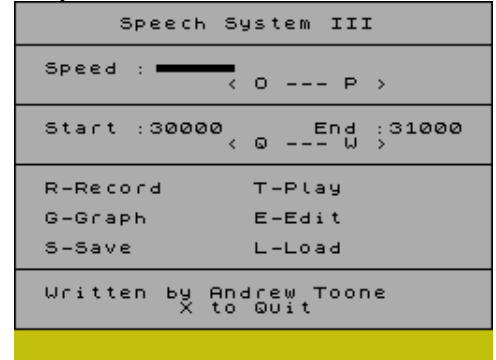

Speedboat Assassin (Mastertronic Plus,1989)
Arcade



Speed King 2 (Mastertronic Ltd,1987)
Arcade



Speed Read (Hi-Yin Music,1984)
Educational

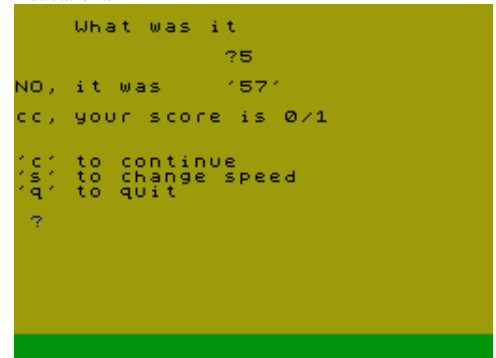

Spellbound: Golden Apple (Sulis Software Ltd,1983)
Educational

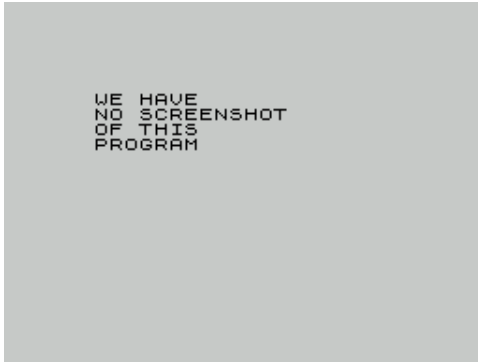

Spellbound: Towering Inferno (Sulis Software Ltd,1983)
Educational

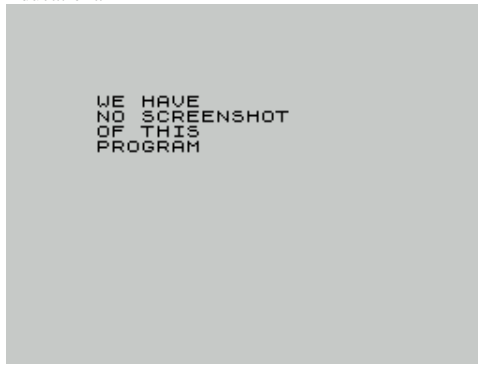

Spellbound Dizzy (Code Masters Ltd,1991)
Arcade

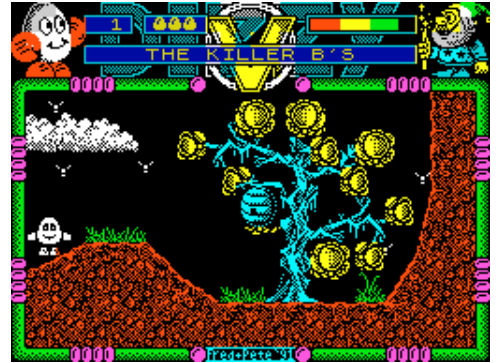

Spellbox (Macmillan Software Ltd/Sinclair Research Ltd,1985) Educational

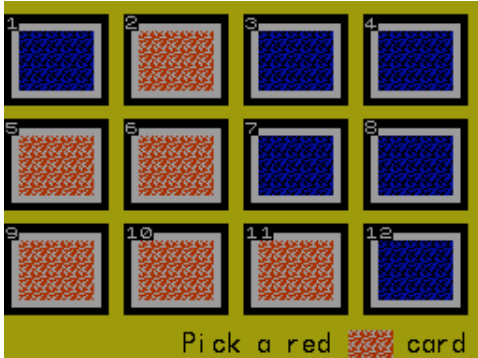

Spellcaster (,) Text Adventure

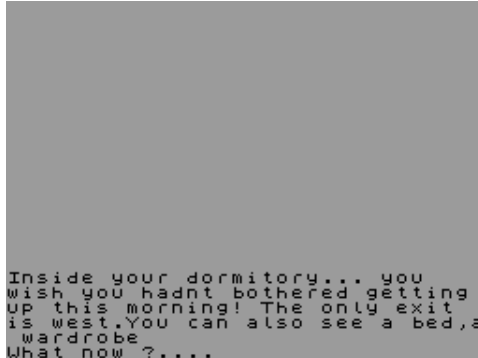

Spelli-Copter (Kerian UK Ltd,1984)
Educational



Spelling Bee (Image Systems,1984)
Educational



Spelling Tester (Calpac Educational Software,1983)
Educational



Spell of Christmas Ice, A (Star Dreams,1989)
Text Adventure

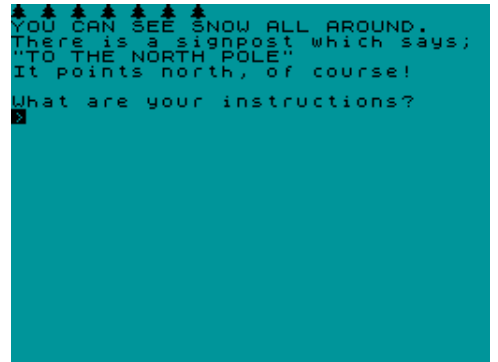

Spend (Garry Rowland,1991)
Utility: Spreadsheet

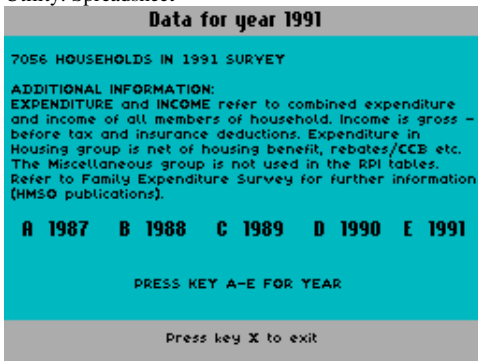

Sphere (Mikro+kleincomputer Informa Verlag AG,1984)
Utility: BASIC Related

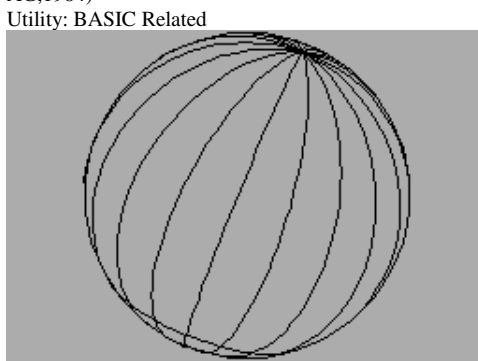

Sphere of Q'li (The Adventure Workshop,1996)
Text Adventure

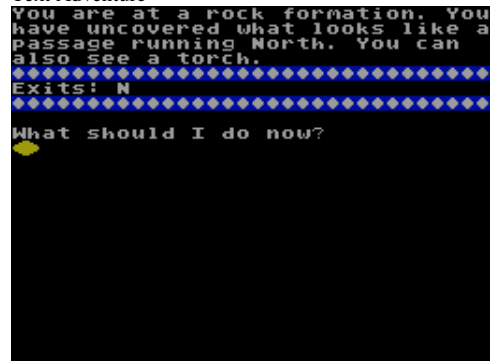

Spherical (Rainbow Arts,1989)
Arcade



Sphinx (Ignacio Prini Garcia,1989)
Music



Spider (16/48 Tape Magazine,1984)
Arcade



Spirit of the Demon (Wolfsoft, 1991)
Text Adventure



Spirograph (Your Sinclair, 1993)
Utility: Drawing

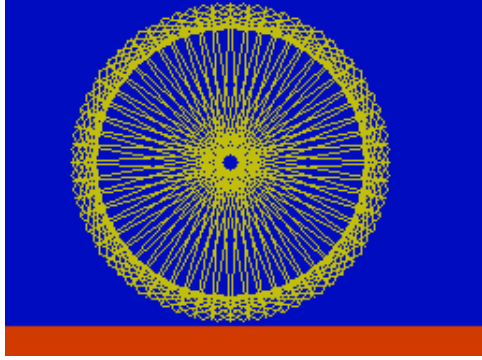

Spitfire '40 (Mirrorsoft Ltd, 1985)
Simulation

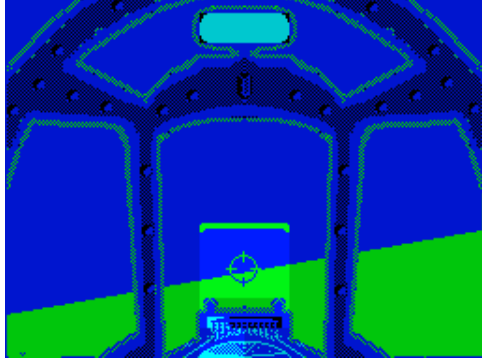

SPiX (G4HLX, 1986)
Utility

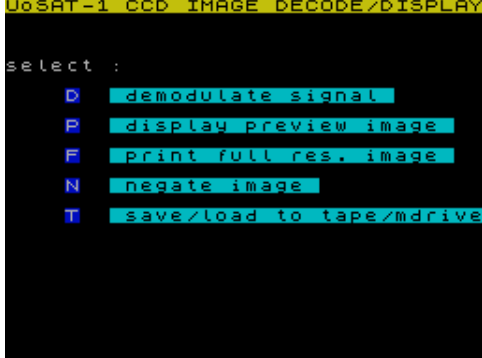

Splat (Sinclair User, 1984)
Arcade



Spirits (Topo Soft, 1987)
Arcade Adventure

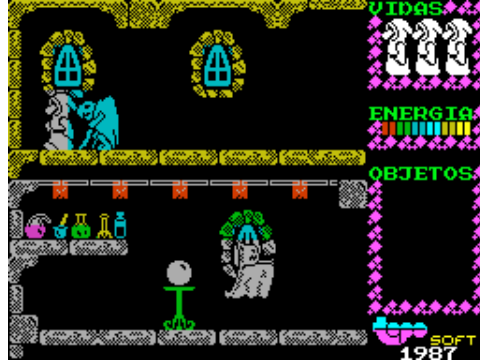

Spiro Legacy, The (The Adventure Workshop, 1991)
Text Adventure

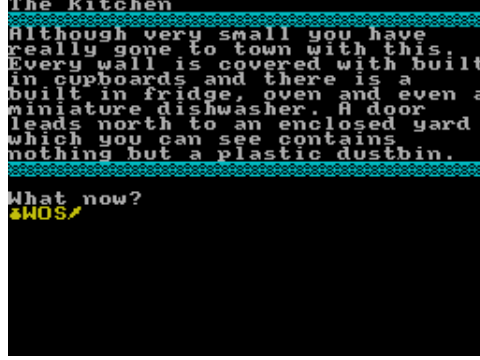

Spitfire '40 + Strike Force Harrier (Alternative Software Ltd, 1992) Compilation

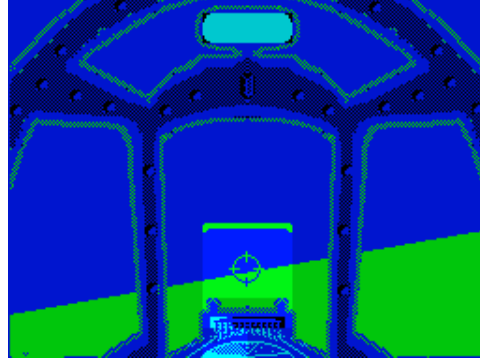

Splashdown (H.S. Software, 1987)
Educational

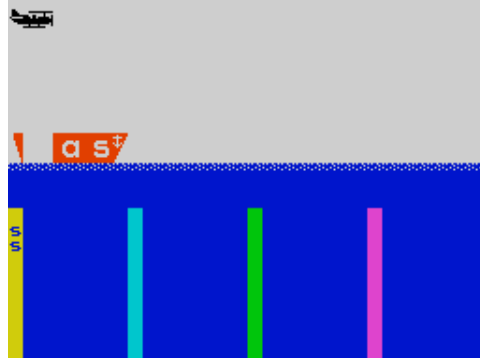

Split Personalities (Domark Ltd, 1986)
Board/Card Game



Spirograph (Sinclair Programs, 1983)
Utility: Drawing

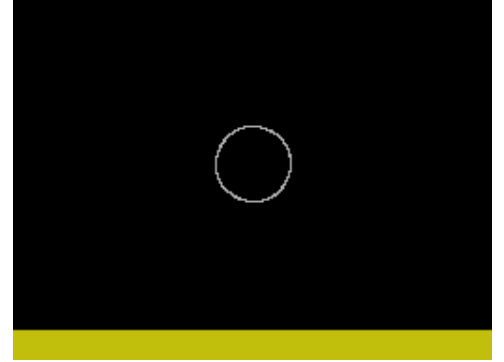

Spitfire (Durell Software Ltd, 1989)
Arcade



Spitting Image (Domark Ltd, 1988)
Arcade



Splat! (Incentive Software Ltd, 1983)
Arcade



Splitting Images (Domark Ltd, 1986)
Board/Card Game



Splooosh (H.S. Software,1987)
Educational

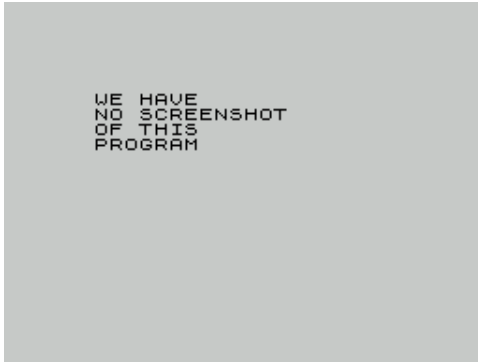

Spludgies (Freaky Fruitbat Software,1989)
Arcade



SP-MT11 (Nowatech,1986)
Utility

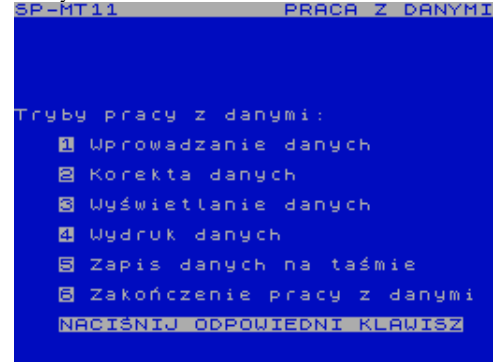

Spoof: The Magic Dragon (Runesoft,1984)
Text Adventure



Spooked (Players Premier Software,1989)
Arcade Adventure



Spooky Castle (Atlantis Software Ltd,1991)
Arcade



Spookyman (Abbex Electronics,1982)
Arcade

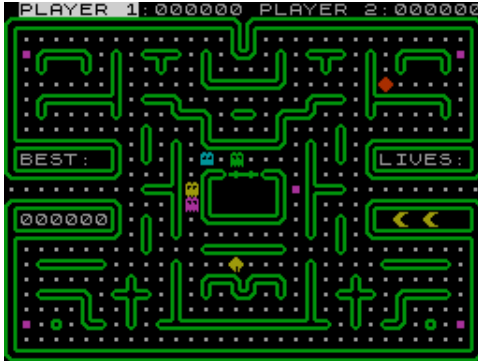

Spore (Bulldog,1988)
Arcade

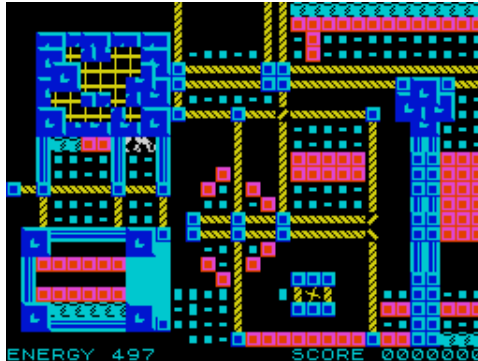

Spore, The (K-Soft,1986)
Text Adventure

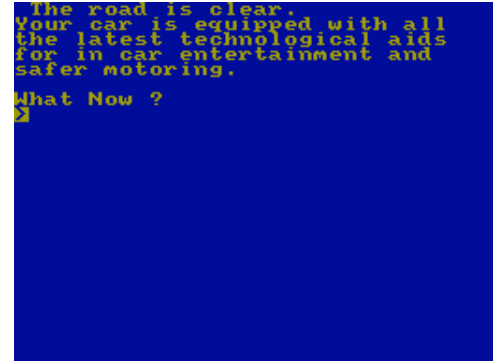

Sportacular (Alternative Software Ltd,1988)
Compilation



Sporting Triangles (CDS Microsystems,1989)
Arcade



Sportloto (Tera Software,1990)
Board/Card Game



Sport of Kings (Mastertronic Added Dimension,1986)
Simulation



Sports Hero (Melbourne House,1984)
Sport



Sport & Skill - Pack 5 (Zeppelin Games Ltd,1992)
Compilation



Sports Pack, The (Gamestar,1987)
Compilation

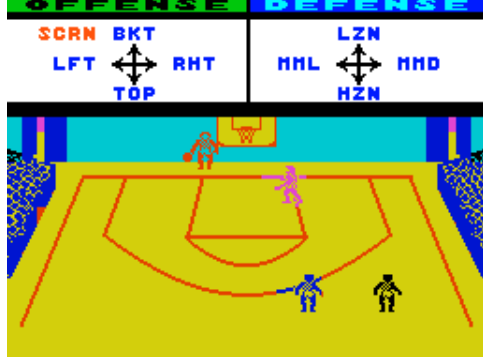

Sprache (Karl Veith,1983)
Utility: Sound Manipulation

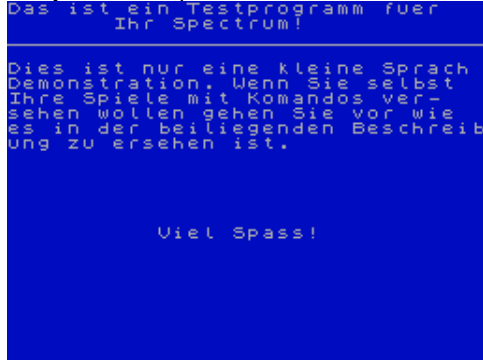

Spreadsheet, The (MiCROL,1982)
Utility: Spreadsheet

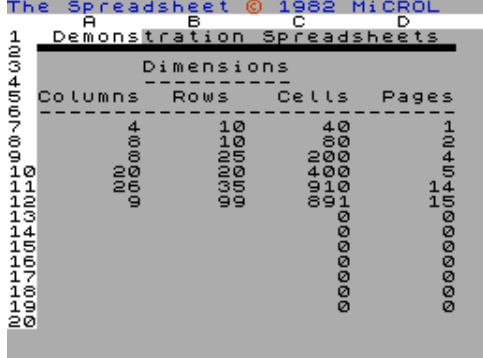

Sprite Demos (Robert Newman,1983)
Utility: Screen Manipulation



Sprite Designer (R.D. Foord Software,1985)
Utility

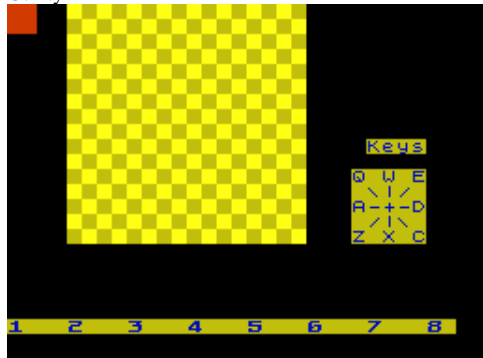

Sports Pack, The (Paxman Promotions,1986)
Compilation

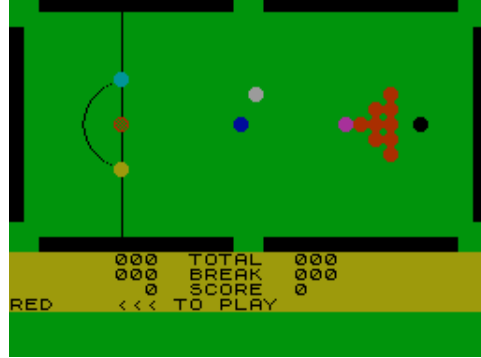

Sprache (R. Zeissler,1983)
Utility: Sound Manipulation

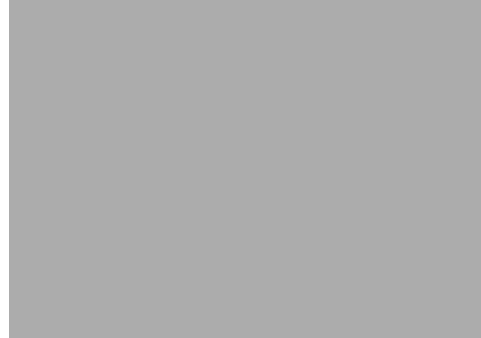

Springer (.)
Arcade

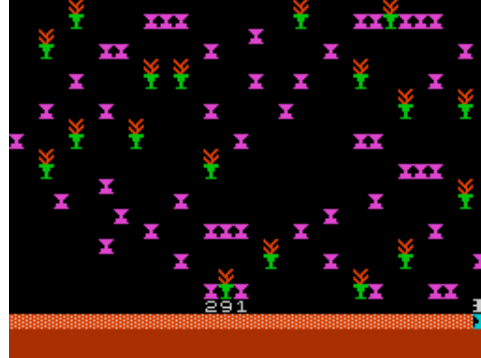

Sprite Design (Robert Spahl,)
Utility: Drawing

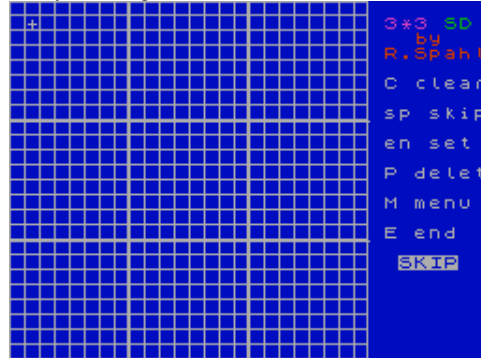

Sprite Editor (Your Computer,1985)
Utility: Drawing

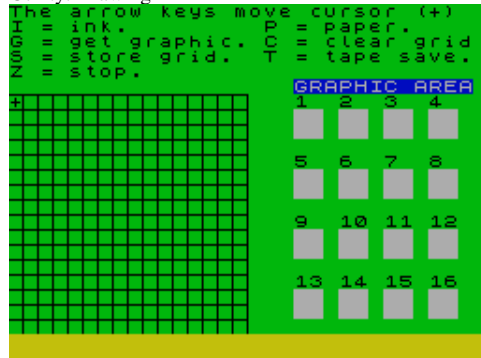

Spr (16/48 Tape Magazine,1984)
Educational



Spray Mania (Your Computer,1985)
Arcade



Sprinter (Aackosoft,)
Simulation

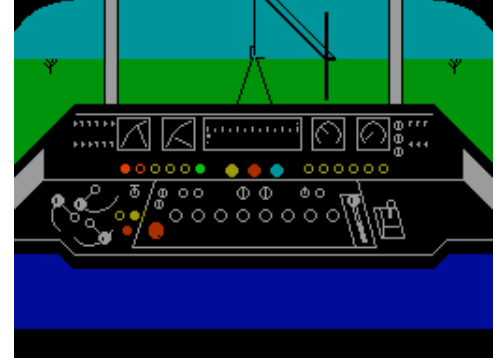

Sprite Designer (Kamasoft,1989)
Utility: Drawing

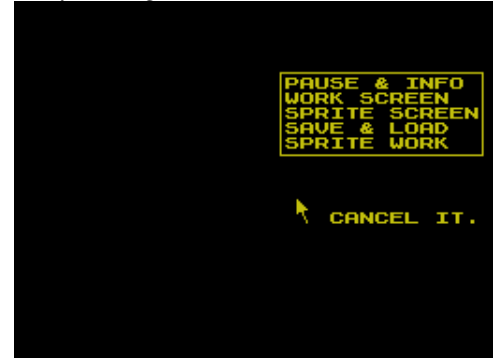

Sprite Editor (Your Sinclair,1988)
Utility: Drawing

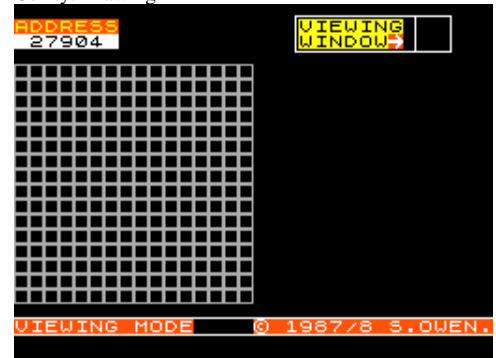

Sprite Editor Introduction (.)

Utility: Drawing

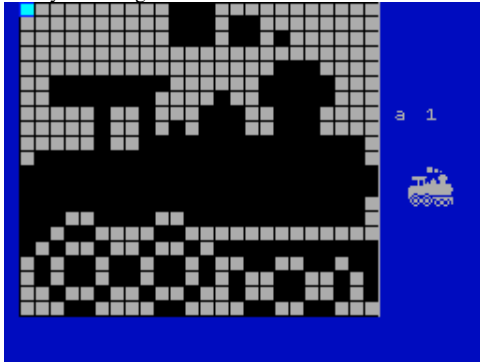

Sprite Machine (Print'n'Plotter Productions,1985)

Utility

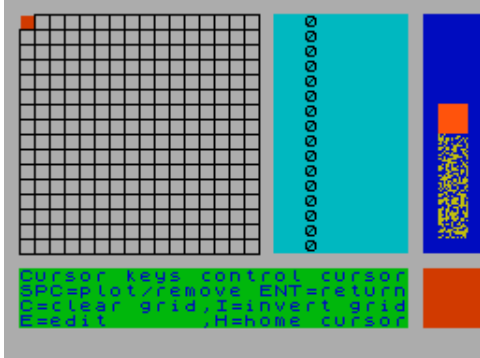

Sprites (.)

Utility



SP-ST01 (Nowatech,1986)

Utility

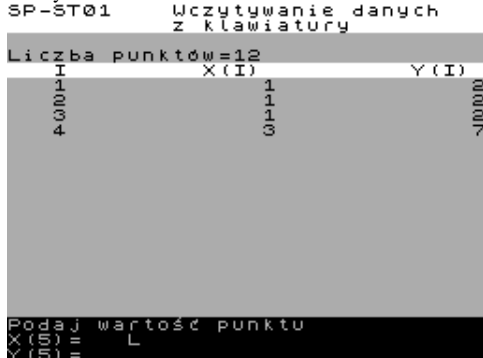

Sputnik (Sygran S.A.,)

Arcade

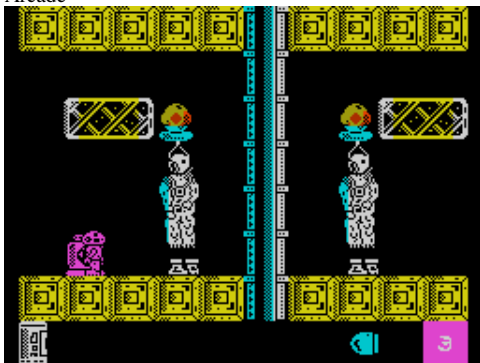

Sprite I (MicroHobby,1986)

Educational

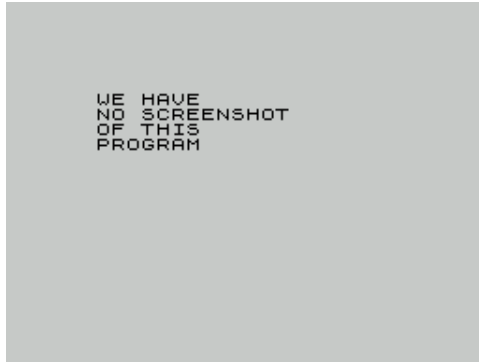

Sprite Maker (Rock'n'Soft,.)

Utility



Sprites Package (Alvin Albrecht,2002)

Utility: Drawing



SP-ST03 (Nowatech,1986)

Utility

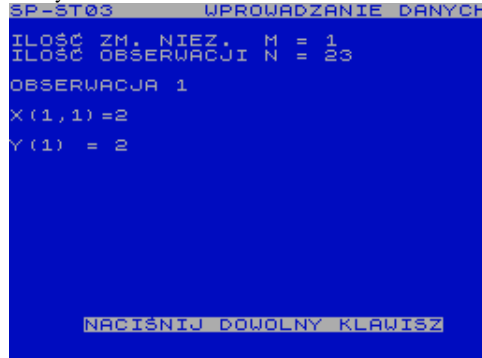

Spy 008 (Markus Rinio,1985)

Arcade



Sprite II (MicroHobby,1986)

Educational

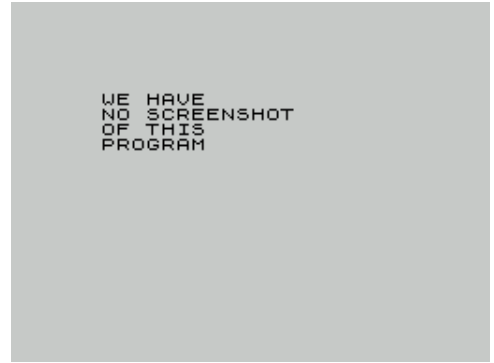

Spriter (Sinclair User,1989)

Utility



Sprl (???) Tower (.)

Arcade

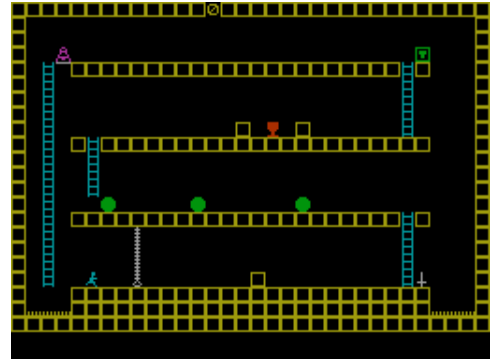

SP-ST17 (Nowatech,1986)

Utility

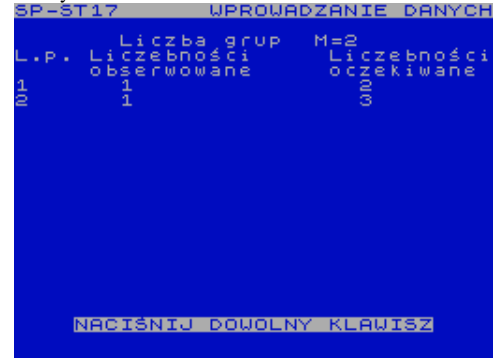

Spy Hunter (US Gold Ltd,1985)

Arcade



Spy-Plane (Gilsoft International,1983)

Text Adventure

You are flying over open sea. There is mountainous land to the south west, elsewhere open sea. There are variable amounts of cloud.
Tell me what to do.
X

Spy Story (Aackosoft,1985)

Text Adventure

DE WACHTKAMER
Achter de deur zit je chef.
jh
Wat wil je dat ik nu ga doen ?
C

Spy vs. Spy (Beyond Software,1985)

Arcade Adventure



Spy vs. Spy Trilogy (Databyte,1988)

Compilation



Squamble (Jonathan Cauldwell,1993)

Arcade



Spy's Demise II (Tweety Soft Ltd,1985)

Arcade

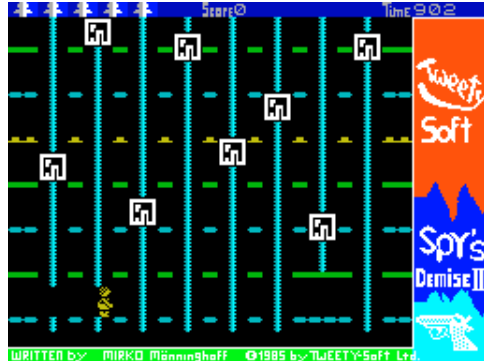

Spy-Trek Adventure (Americana Software Ltd,1986)

Text Adventure

You are lying in a LARGE OAK COFFIN in near total blackness. The pungent smell of wood varnish irritates your nose which is inches from the COFFIN LID.
What now Mike?..

Spy vs. Spy II: The Island Caper (Databyte,1987)

Arcade Adventure

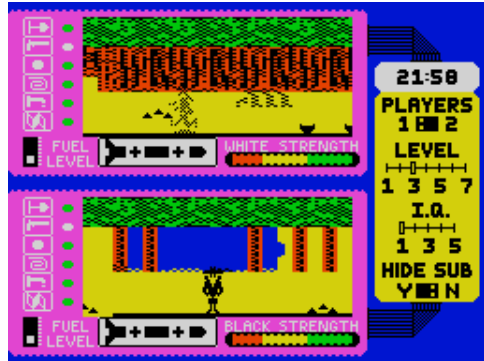

Spy Who Loved Me, The (Domark Ltd,1990)

Arcade Adventure

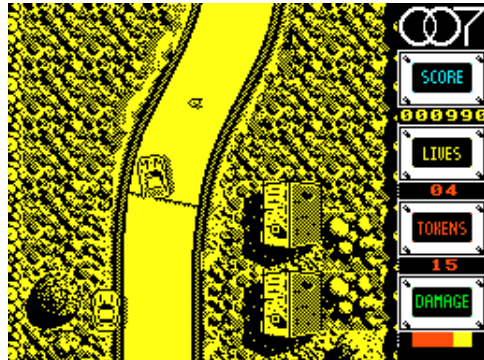

Squads (Spark,1996)

Board/Card Game



Spyship SOS (Dynamic Software,1984)

Arcade

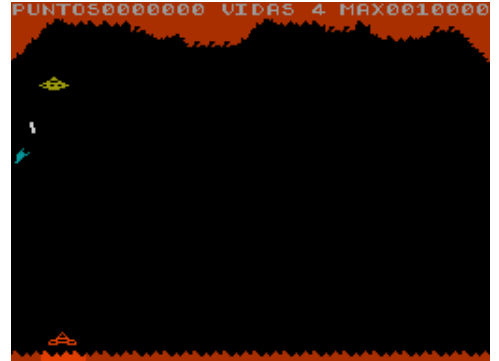

Spy Trilogy, The (Tartan Software,1986)

Text Adventure

You are in a tidy office. To the EAST is a DOOR on which there is a NOTICE. A door MAT is beside the DOOR.
Here there is:-
A small MAT
There is also a Large RAT in here
What now? BOND
*

Spy vs. Spy III: Arctic Antics (Databyte,1988)

Arcade Adventure

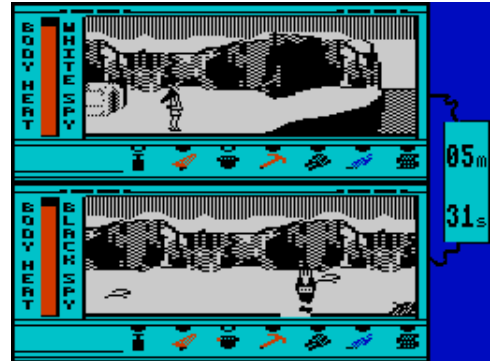

Sqj (The Power House,1987)

Arcade



Square Eyes (C.W. May,1985)

Board/Card Game

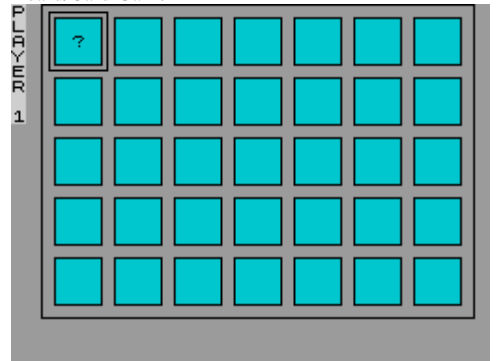

Square Head (Outland Corp,1996)
Board/Card Game

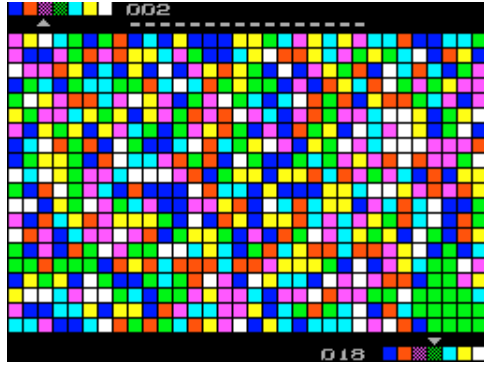

Squares (Zuheir Urwani,1985)
Arcade

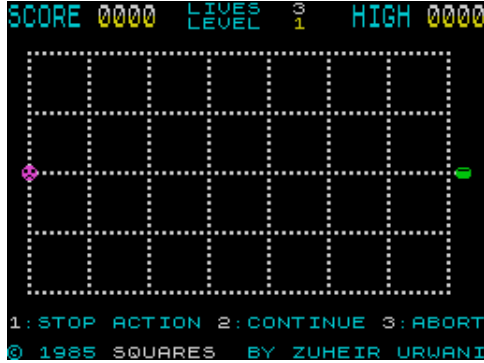

Squirmy Wormy (John Prince,1983)
Arcade



Srednevekovaya Istoriya (Human Soft,1996)
Text Adventure

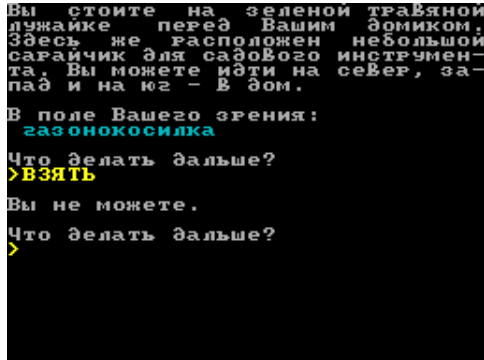

S&S Parapsychologists (Arkham Software,1994)
Text Adventure

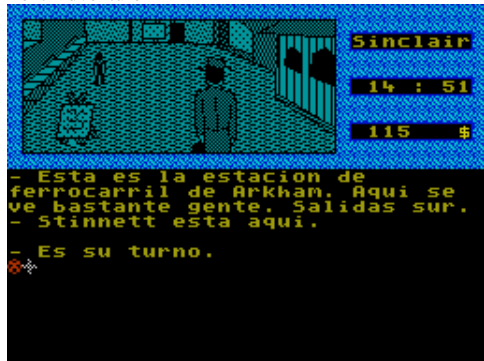

SquareMania (Perspective Group,2006)
Arcade



Squares Colours (THD,1993)
Arcade



Squirt (David Todd Software,1986)
Arcade



SRS Games Disc (Steam Railway Simulations,1988)
Compilation



SSTV (Minicom Soft,)
Utility

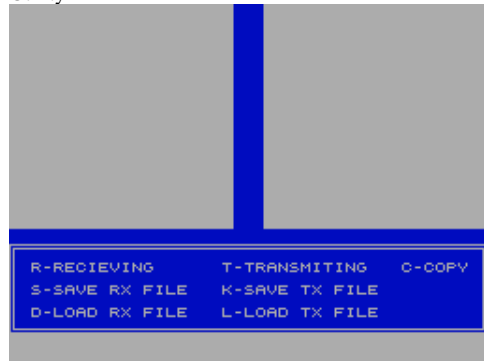

Squareology (ZX Computing,1982)
Arcade

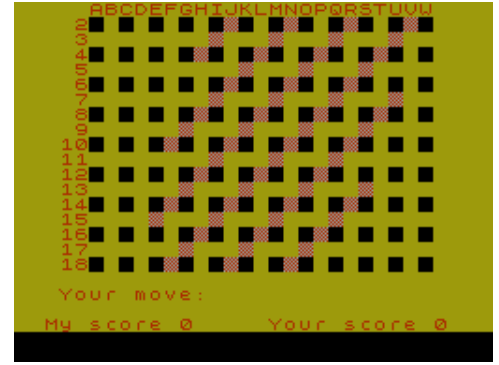

Squash (MicroHobby,1985)
Arcade

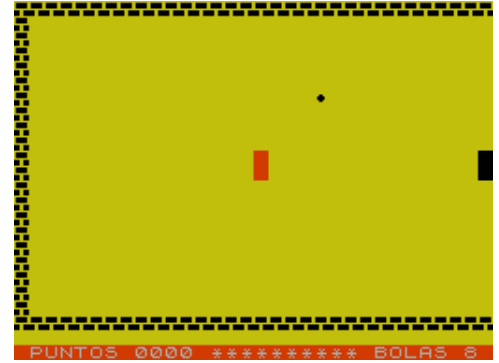

Srajenje (Willis Software,1997)
Board/Card Game

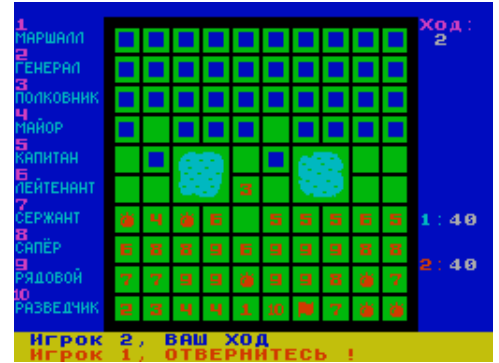

SRSO2 (Treasure Software,1997)
Text Adventure

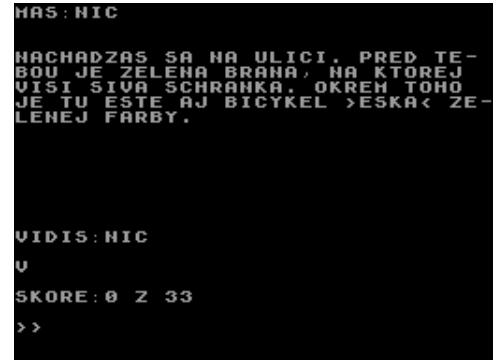

SSTV (Pearsons Computing,1987)
Utility



Stab des Druiden, Der (Thomas Brammen,1985)
Text Adventure

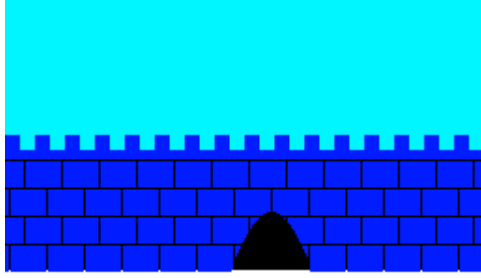

Die Stadtmauer!

Stadhouders van Flipflopland (Kluwer Technische Boeken,1985) Simulation



Staff of Zaranol, The (CCS,1984)
Text Adventure

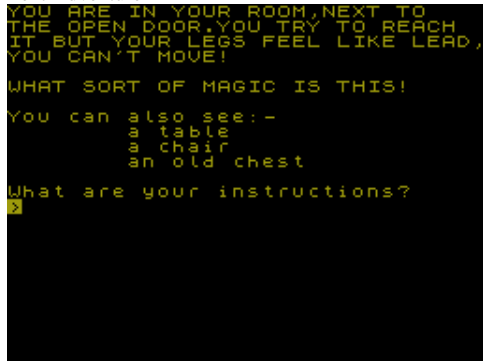

Stainless Steel Rat, The (Mosaic Publishing Ltd,1984)
Text Adventure



Stalker (Evgeny Nesterenko,1997)
Strategy

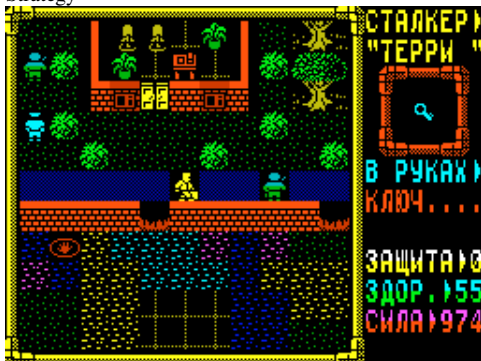

Stack Light Rifle (Stack Computer Services Ltd,1983)
Compilation



Stadt Alzan, Die (,)
Text Adventure

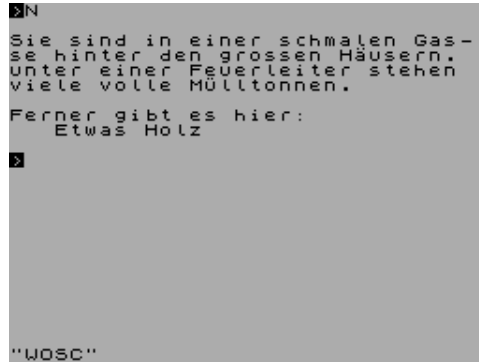

Stagecoach (Creative Sparks,1984)
Board/Card Game

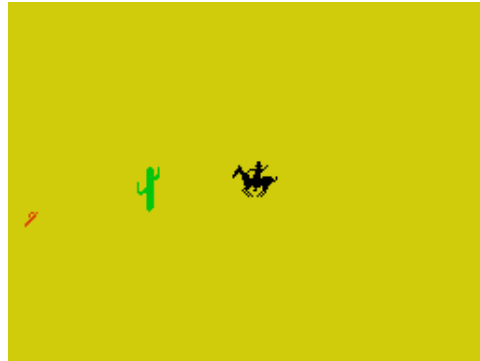

Staketris (3CCorp,1996)
Arcade



Stalker (Zenobi Software,1990)
Text Adventure



Stack Up (Zeppelin Games Ltd,1991)
Arcade

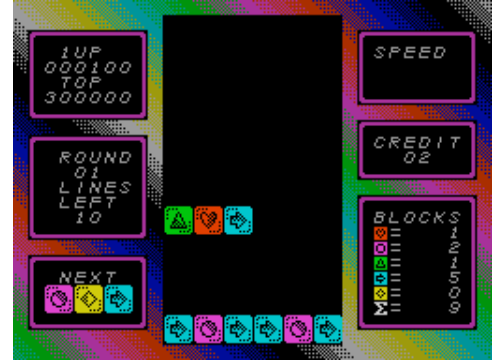

Staff of Power, The (Zenobi Software,1991)
Text Adventure

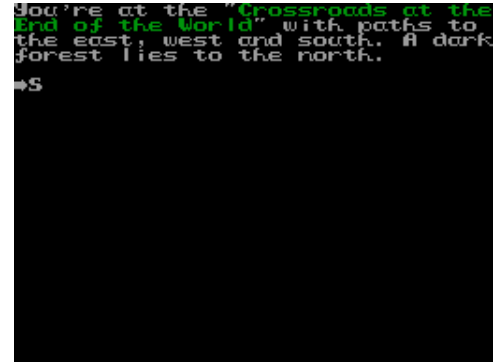

Stainless Steel (Mikro-Gen Ltd,1986)
Arcade

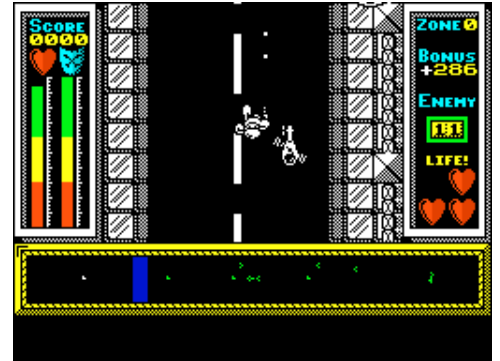

Stalingrad (CCS,1988)
Strategy

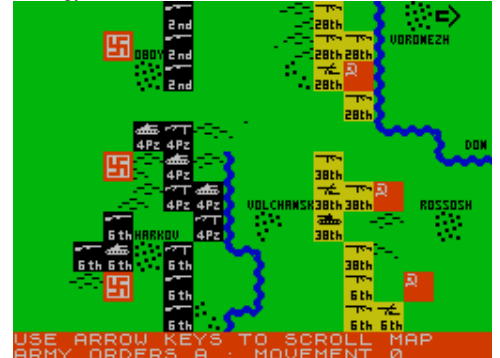

Stampabout (Your Spectrum,1984)
Arcade

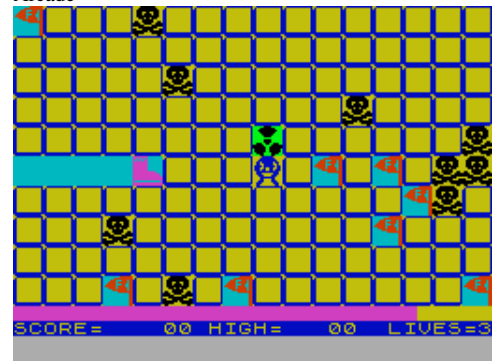

St. Andrews Golf (Artic Computing Ltd,1983)
Sport

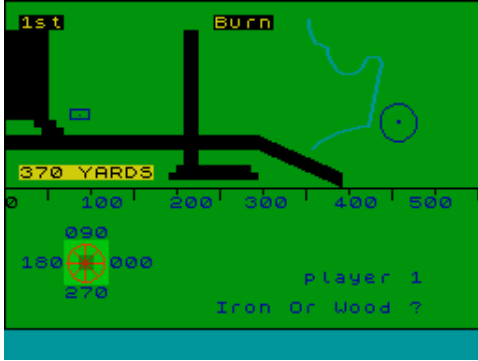

Star (Anestis Koutsoudis,1998)
Scene Demo



Star Atlas (MiCROL,1982)
Utility: Astronomy/Astrology

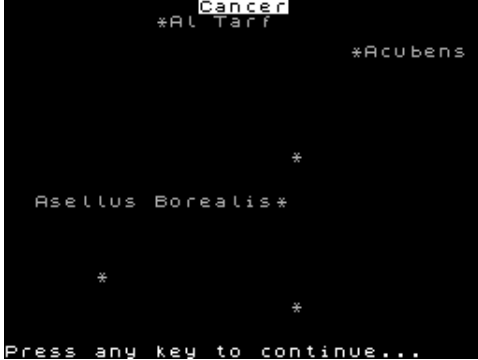

Starbike (The Edge Software,1984)
Arcade



Starblitz (Softek Software International Ltd,1984)
Arcade



Stanley and the Wallbangers (Software Liason,1985)
Arcade



Star [1] (Sinclair Programs,1983)
Arcade

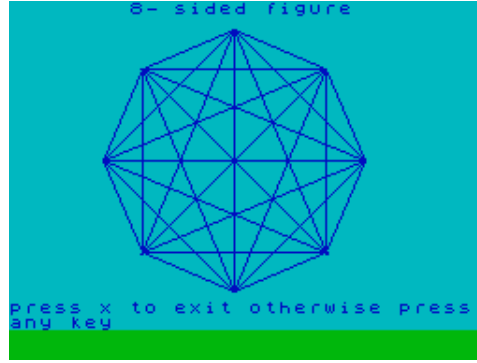

Star Base (Simon N. Goodwin,1984)
Arcade

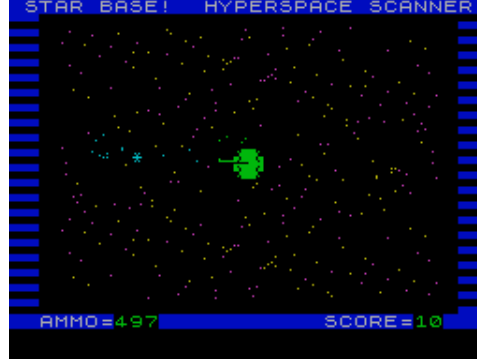

Star Blade (Barry & Bruce Adams,1988)
Arcade

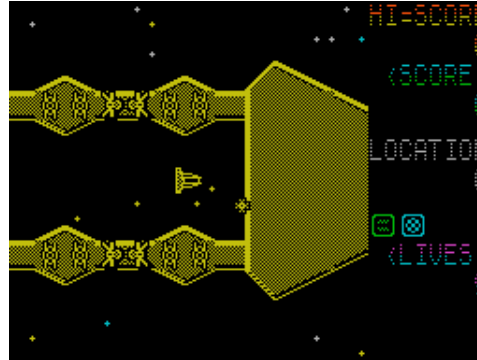

Star Bowls (Diabolic Software,1991)
Arcade

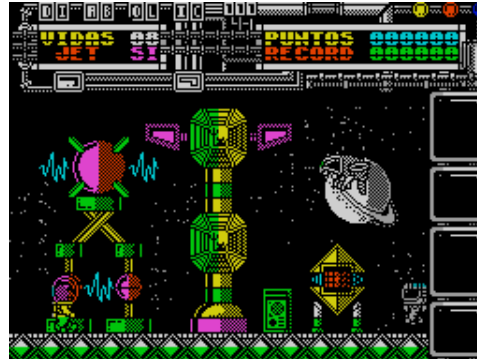

Stan Stalnoy Krisoy (Rome'r Software/Bloody Skull
Ent.,1997) Text Adventure

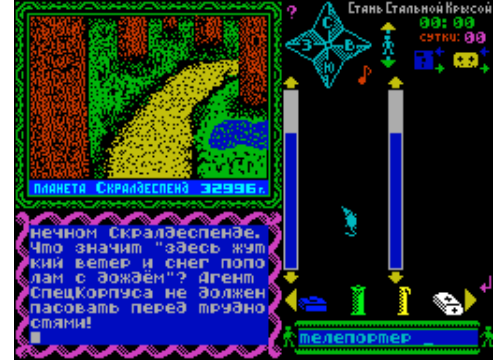

Star [2] (Sinclair Programs,1984)
Arcade

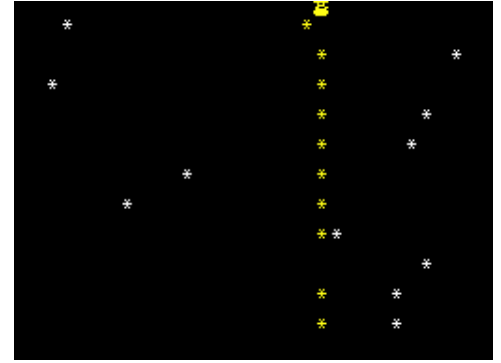

Starbase 13 (.)
Text Adventure



Starblazer (Sidewinder,1983)
Arcade



Starburst (Crash,1991)
Arcade

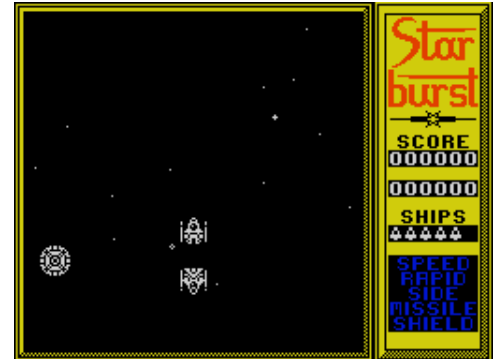

Starburst (Shaw Brothers,1989)
Arcade



Starbuster (Meow Micros,1983)
Arcade



Star Chess (Space Age Software,1984)
Board/Card Game



Starcrash (MicroHobby,1985)
Arcade



Star Dragon (Proxima Software,1990)
Arcade

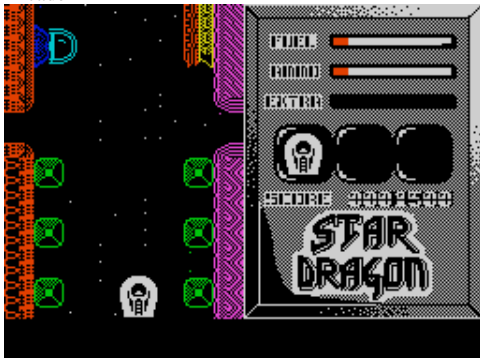

Starburst + Ice Attack (Alternative Software Ltd,1987)
Compilation



Starbyte (Mister Chip,1987)
Arcade



Starclash (Micromega,1983)
Arcade



Starcrash (Starcrash Software Systems,1986)
Text Adventure

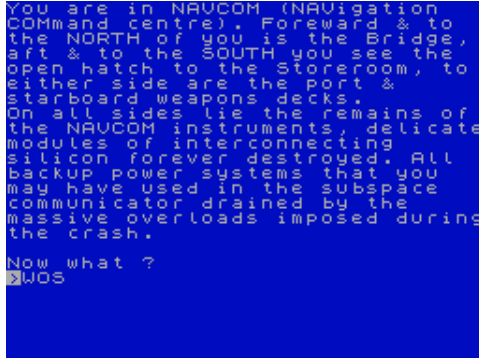

Star Dragon Collection (Proxima Software,1990)
Compilation



Starbuster (K'Soft Ltd,1986)
Arcade



Star Chart (Shiva Publishing Ltd,1983)
Educational



Star Control (Accolade Inc,1991)
Arcade

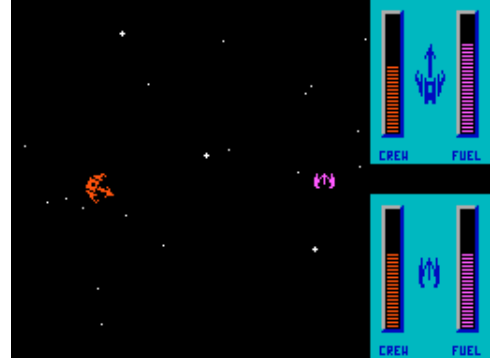

Star Crystal (Edward Beck,1986)
Text Adventure



Stardrive (MicroHobby,1986)
Arcade



Stardust (Topo Soft,1987)
Arcade



Star Fighter (Impact Software [1],1982)
Arcade

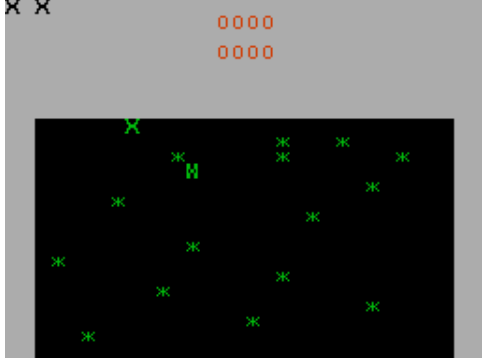

Starfinder (NMS,1983)

Utility: Astronomy/Astrology

Celstial obj. availability table

```

Date 11/11 Days from 22/IX=50
Local zone time 23:51 (GMT=22:51)
Local star time 0:0
Latitude 52 degrees north
Longitude 21.666667 degrees east
Objects brighter than mag=0
zenith at 3:34 Hours R.a.

Object      Mg      BrngAlt
-----
0 Sirius (a-Canis Maj)      -1.6    110  21
1 Vega (a-Lyra)             0.0    160  10
300 Capella (a-Auriga)       0.1    160  10
300 Rigel (b-Orion)          0.0    160  10
4 Procyon (a-Canic min)    0.2    160  10
5 Betelgeuse (a-Orion)     0.4    110  21
    
```

scroll?

Star Flaws (Delbert the Hamster Software,1992)
Text Adventure

```

NUKE SKYPORTER STOOD... WELL,
CROUCHED, IN THE RATHER
CLAUSTROPHOBIC SECRET HIDING
PLACE. IT WAS SCARCELY
FURNISHED, APART FROM A FEW
CRATES LYING AROUND. NUKE WAS
UPSET THAT YAN POLO HAD NOT
TAKEN THE TIME TO MAKE IT A BIT
MORE WELCOMING.
THE ONLY EXIT WAS A SMALL HATCH
THAT LED UP.
*****
WHAT SHOULD NUKE DO NOW?
**
    
```

Starforce One (Carnell Software,1984)
Arcade

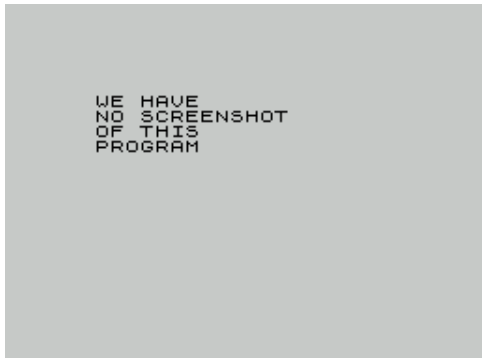

Star Farce (Mastertronic Ltd,1988)
Arcade



Starfighter, 3D (Code Masters Ltd,1988)
Arcade



Starfire (Virgin Games Ltd,1982)
Arcade



Star Flaws + Raymond Pringle's Quest for the Fabled Jar of Pick (Delbert the Hamster Software,1992)
Compilation



Star Force Seven (.)
Arcade

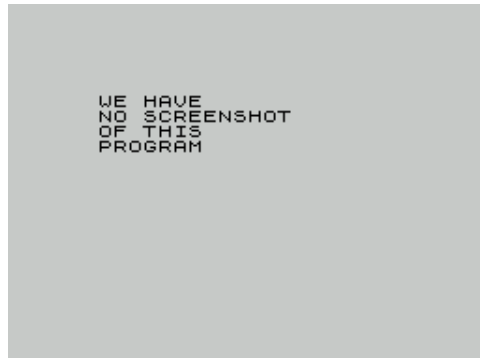

Star Fighter (Grupo de Trabajo Software S.A.,1987)
Arcade



Starfighters (Load 'n' Run [Ita],1986)
Arcade



Star Firebirds (Insight Software,1985)
Arcade



Star Fly, The (TRC Software,1987)
Arcade

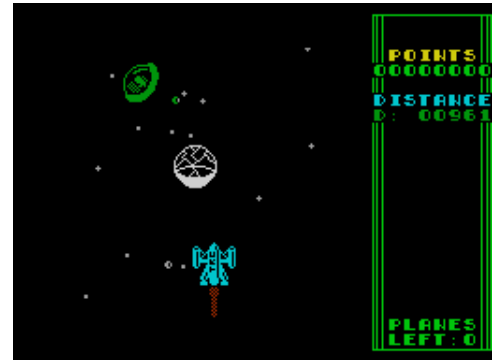

Starfox (Cybexlab Software,1987)
Arcade

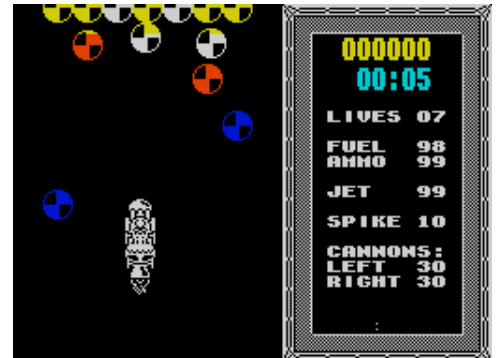

Starfox (Reaktor,1987)
Arcade



Stargazer (Eclipse Software,1985)
Educational



Starglider 2 (Rainbird Software Ltd,1989)
Arcade

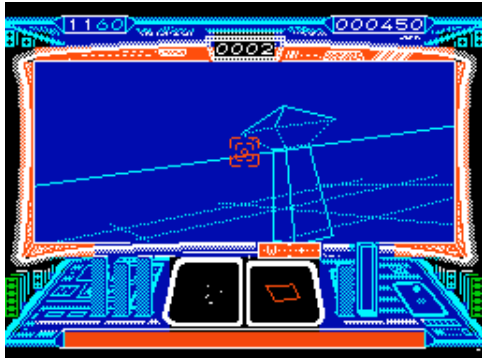

Star Inheritance: Black Cobra (STEP,1995)
Strategy

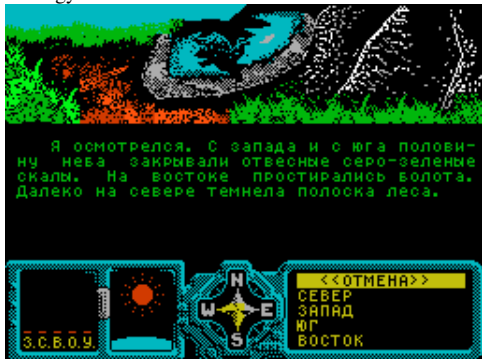

Starlike (MicroHobby,1989)
Arcade

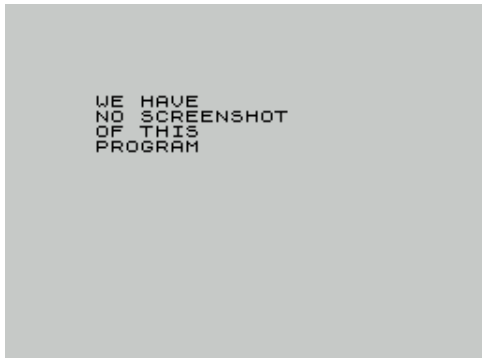

Star Games II (Gremlin Graphics Software Ltd,1987)
Compilation



Stargazer Secrets (CRL Group PLC,1983)
Utility: Astronomy/Astrology

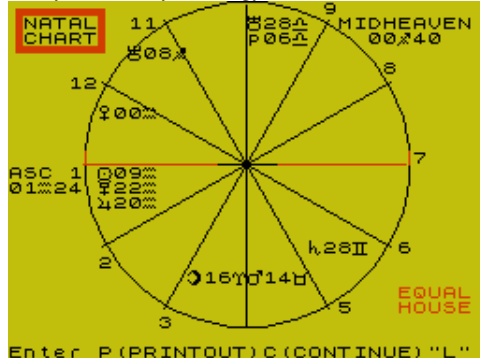

Star Heaven (Johnny Hazzard,1990)
Scene Demo



Starion (Melbourne House,1985)
Arcade



Star Lord (Maelstrom Games Ltd.)
Strategy



Star Games One (Gremlin Graphics Software Ltd,1987)
Compilation



Starglider (Rainbird Software Ltd,1986)
Arcade



Star Hero (Russian Bear Group,1996)
Arcade



Starlife (New Frontier,1988)
Arcade Adventure



Star Map From Sol (Pete Cooke,1986)
Utility: Astronomy/Astrology

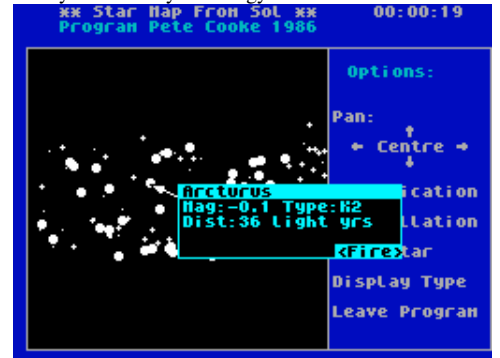

Star Paws (Software Projects Ltd,1988)
Arcade



Star Quest (Breadhill,1984)
Arcade

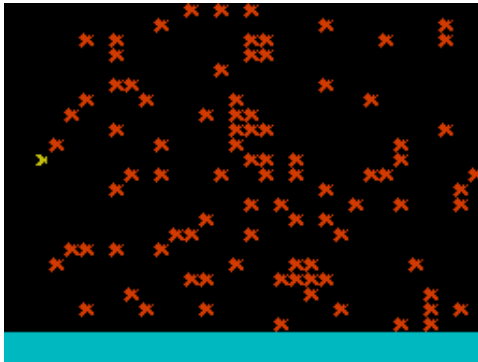

Star Reader (Scisoft,1985)
Educational

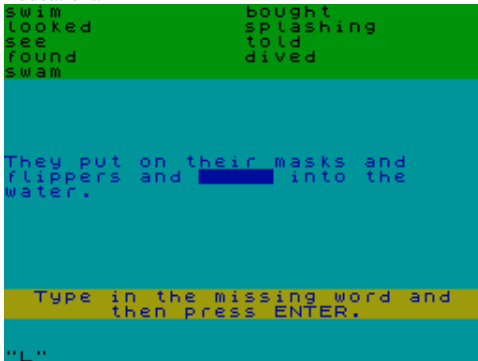

Star Runner (Code Masters Ltd,1987)
Arcade

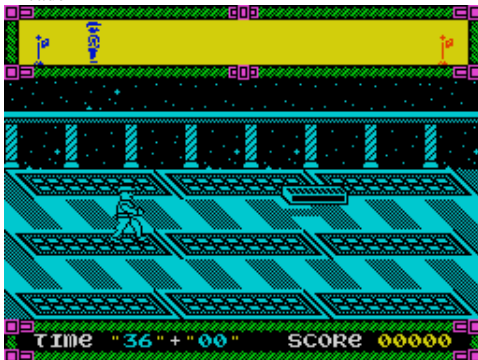

Starship (Mikro-Gen Ltd,1984)
Arcade



Star Pilot (Firebird Software Ltd,1987)
Arcade

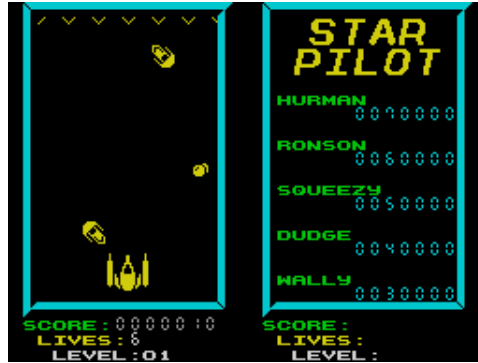

Star Quest (Church Army Resource Centre,1984)
Text Adventure

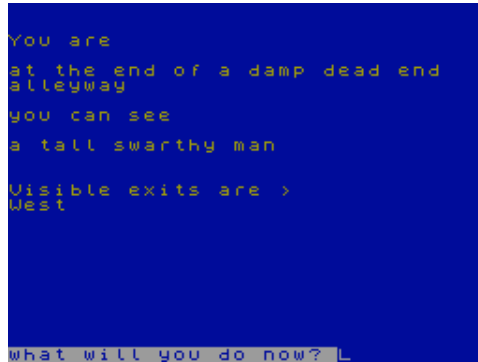

Star Reporter (Haggisoft,1987)
Text Adventure

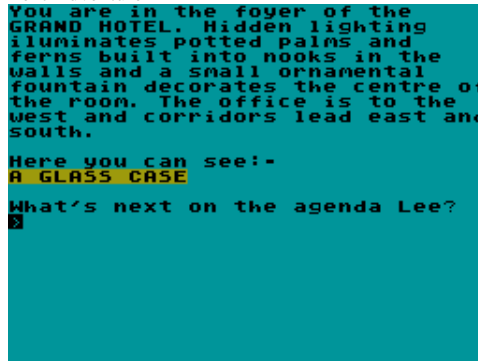

Star Searcher (Scorpio Software,1984)
Arcade

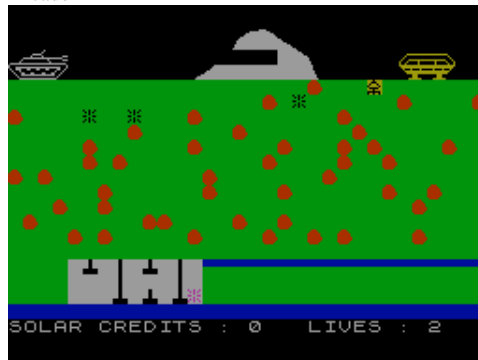

Starship 2100RD (Anik Microsystems,1984)
Arcade



Starquake (Bubblebus Software,1985)
Arcade

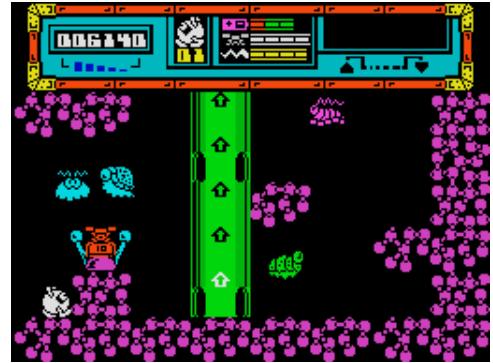

Star Raiders II (Electric Dreams Software,1987)
Arcade



Starring Charlie Chaplin (US Gold Ltd,1987)
Arcade Adventure



Star Seeker/Solar System (Mirrorsoft Ltd,1985)
Utility: Astronomy/Astrology

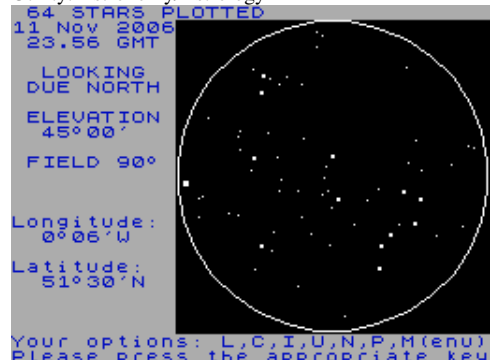

Starship Enterprise (Silversoft Ltd,1983)
Simulation



Starship Quest (FSF Adventures,1989)

Text Adventure



Stars on the 128K (Ocean Software Ltd,1986)

Compilation



Stars Spectrum - Juegos issue 02 (Stars,1985)

Covetape



Stars Spectrum - Juegos issue 05 (Stars,1985)

Covetape



Stars Spectrum - Utilidades issue 02 (Stars,1984)

Covetape



Starship Spectrum (Impact Software [1],1983)

Arcade

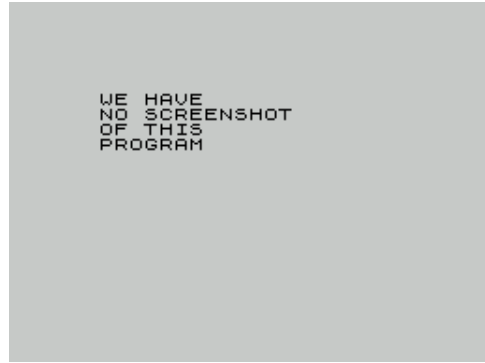

Starsphere (Eclipse Software,1985)

Educational



Stars Spectrum - Juegos issue 03 (Stars,1985)

Covetape



Stars Spectrum - Juegos issue XX (Stars,1985)

Covetape



Stars Spectrum - Utilidades issue 03 (Stars,1984)

Covetape



Star Soccer (Watson Software Services Ltd,1983)

Arcade



Stars Spectrum - Juegos issue 01 (Stars,1985)

Covetape



Stars Spectrum - Juegos issue 04 (Stars,1985)

Covetape



Stars Spectrum - Utilidades issue 01 (Stars,1984)

Covetape



Stars Spectrum - Utilidades issue 04 (Stars,1984)

Covetape



Stars Spectrum - Utilidades issue 05 (Stars,1984)
Covertape



Starstrike II (Realtime Games Software Ltd,1986)
Arcade



Starter's Orders (David C. Jackson,1984)
Simulation



Star Trader (Bug-Byte Software Ltd,1984)
Arcade



Startrek (Chromasoft,1982)
Strategy

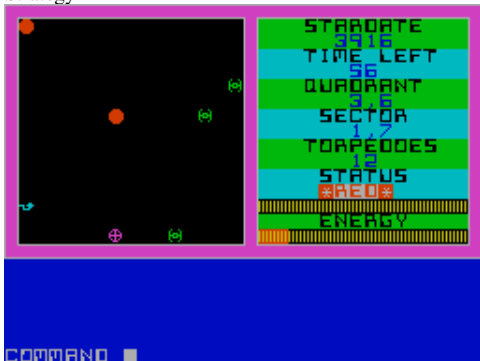

Stars, Stripes and Mr. Bush (Crash,1989)
Arcade

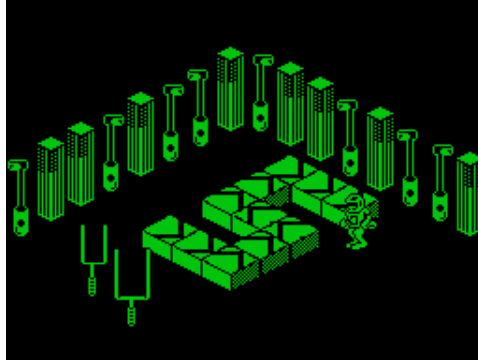

Starstrike I & II (Silverbird Software Ltd,1988)
Compilation

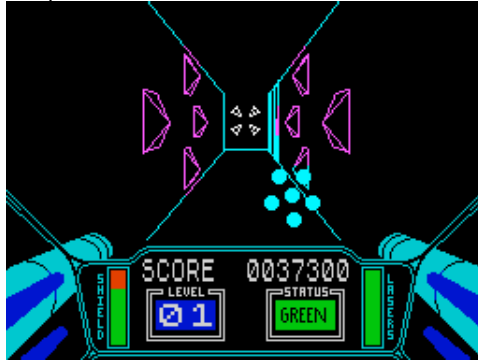

Starter Wordsplits (Sulis Software Ltd,1986)
Educational
Place

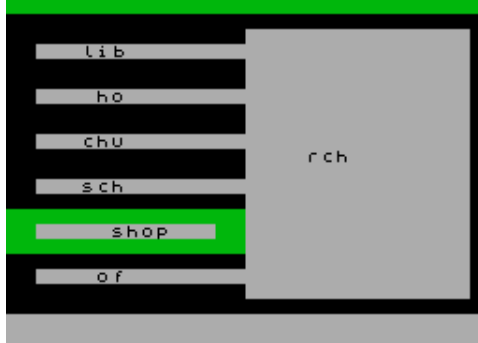

Star Trader (EMM Software,1984)
Simulation

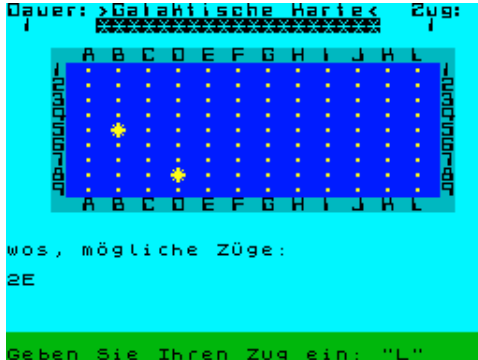

Startrek (EMM Software,1983)
Arcade



Starstrike, 3D (Realtime Games Software Ltd,1984)
Arcade

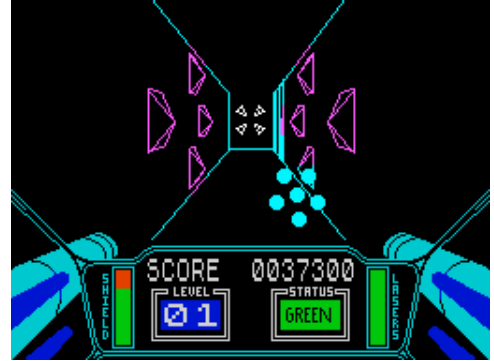

Star Swallow (TRC Software,1987)
Arcade

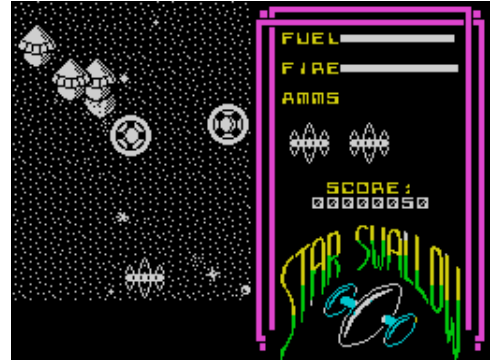

Star Trade (Digital Dexterity,1984)
Board/Card Game



Star Trek (Beyond Software,)
Text Adventure



Star Trek (FASA,1984)
Board/Card Game



Star Trek (Fuller Micro Systems Ltd,1983)
Arcade



Star Trek (Neptune Computing,1983)
Arcade



Startrek 3000 (DK'Tronics Ltd,1983)
Simulation



Star Trek - The Computer Game (Airline Software,1989)
Arcade



Star Trip (Pegasus Developments,1991)
Text Adventure



Startrek (Gemini Marketing Ltd,1982)
Arcade



Startrek + Towers of Brahma (Star Dreams,1982)
Compilation



Star Trek 3050 (Microparadise Software,1984)
Strategy



Star Trek - The Computer Program (R&R Software Ltd,1982)
Arcade



Star Trip (Sinclair User,1992)
Arcade

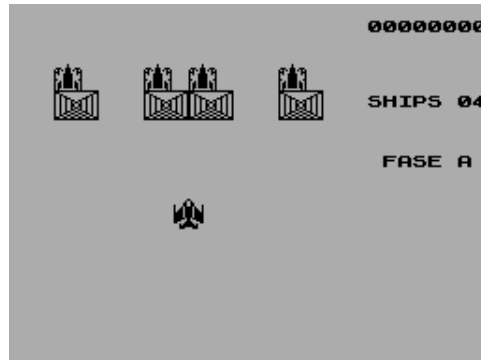

Star Trek (Mikro-Gen Ltd,1982)
Arcade

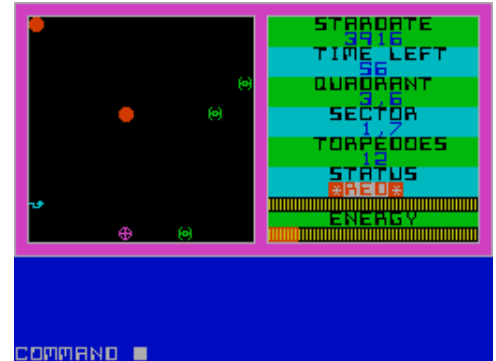

Star Trek 16K (Impact Software [1],1982)
Arcade

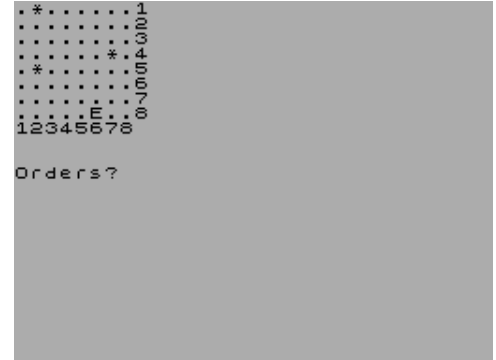

Startrek Adventure (Program Direct,1982)
Text Adventure



Star Trek - The Next Generation 1997 (Rider Software,1997)
Arcade



Start to Program (St. Michael,1984)
Educational

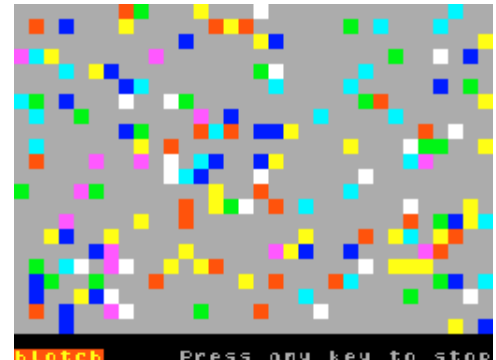

Star Warrior (Thomas Busse,) Arcade



Star Wars (Parker Software,1984) Arcade



Star Wars Trilogy, The (Domark Ltd,1989) Compilation



Star Wreck (Alternative Software Ltd,1987) Text Adventure



Station (Robert Spahl,1985) Arcade



Star Warrior (Visions Software Factory,1982) Arcade

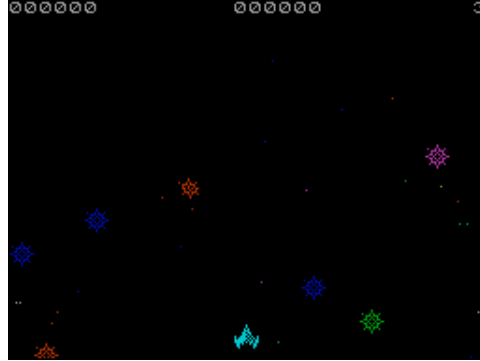

Star Wars, 3D (Custom Cables International Ltd,1983) Arcade



Starwash (Ricardo Villalba Martinez,1991) Text Adventure

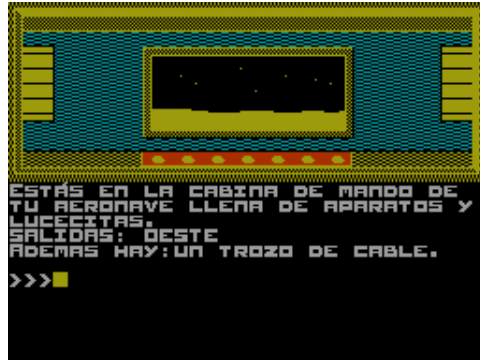

Stasteroids (C&VG,1983) Arcade



Station 9-Zero Under Attack (Armadillo Soft,1987) Text Adventure



Star Wars (Domark Ltd,1987) Arcade



Star Wars Droids (Mastertronic Added Dimension,1988) Arcade Adventure

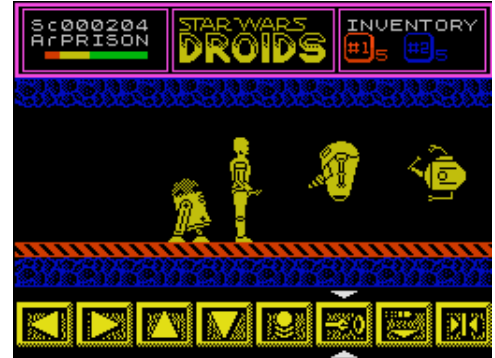

Star Watcher (Collins Educational,1985) Educational

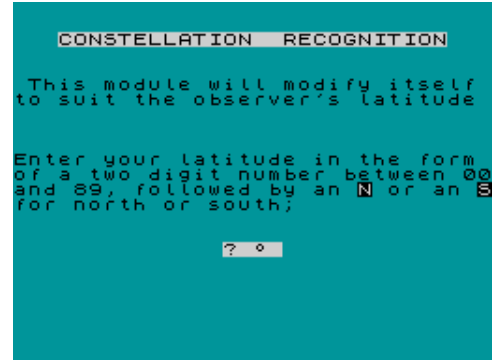

Statement (Fountain Drinks,) Utility: Spreadsheet



Statistics (Bridge Software,1983) Utility

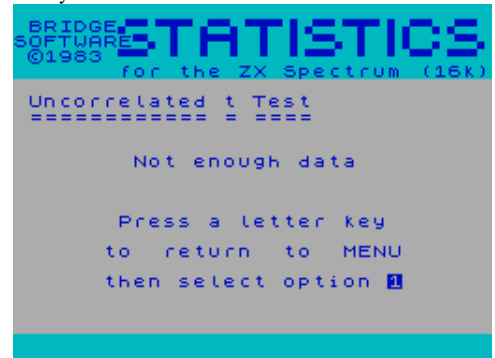

Statistics (Greg Turnbull,1983)

Utility: Mathematics

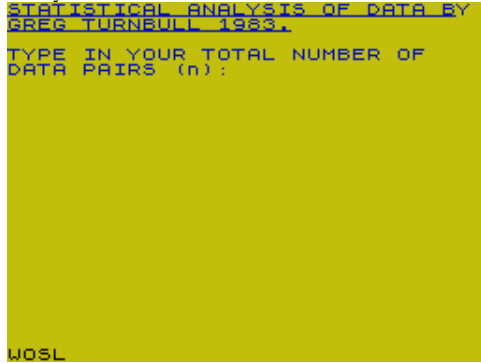

Statistics - Multiple Observation Designs (Bridge Software,1983) Utility

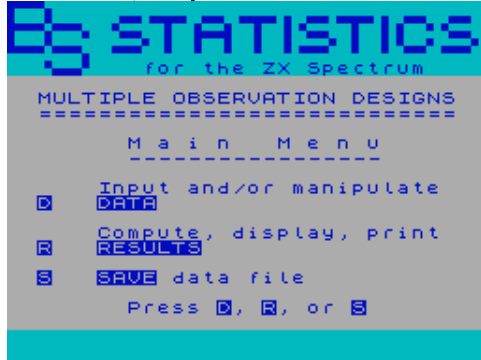

Stay Kool (Bug-Byte Software Ltd,1984)

Arcade

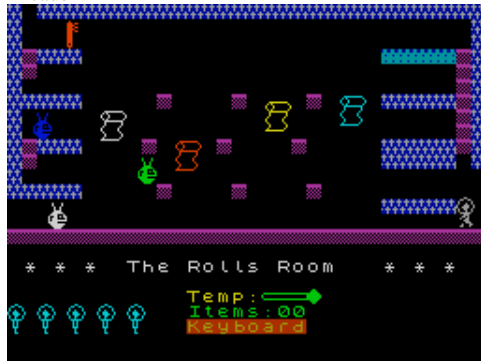

Stealth (Martin Vodicka,1987)

Arcade



Steep Way (Mastertronic Ltd,1987)

Arcade



Statistics II (Bridge Software,1984)

Utility

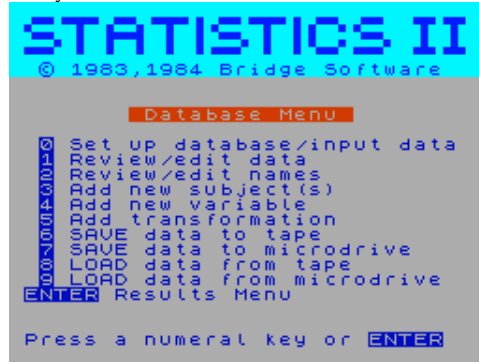

Statutory Sick Pay (Hilderbay Ltd,1983)

Utility



St. Crippens (Sparklers,1985)

Arcade



Steel Eagle (Players Premier Software,1990)

Arcade



Steg (Code Masters Ltd,1992)

Arcade



Statistics Made Simple (Shiva Publishing Ltd,1983)

Utility

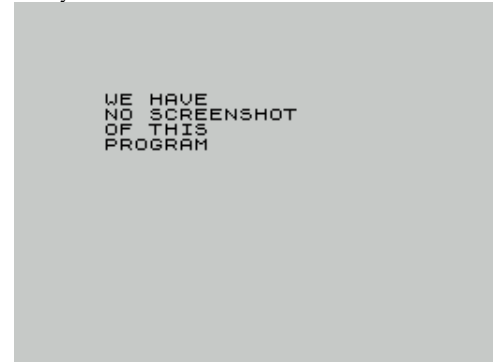

Stavka (Svosatasoft,1989)

Text Adventure

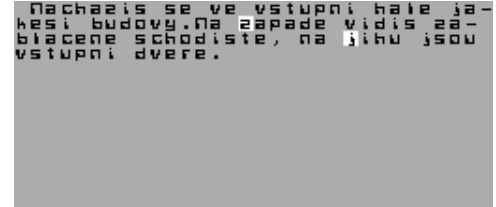

WOSL

St. Dragon (Storm Software [2],1990)

Arcade



Steelyard Blues, The (Tynesoft,1987)

Arcade



Steigar (Screen 7 Ltd,1989)

Arcade



Stein (.)
Arcade

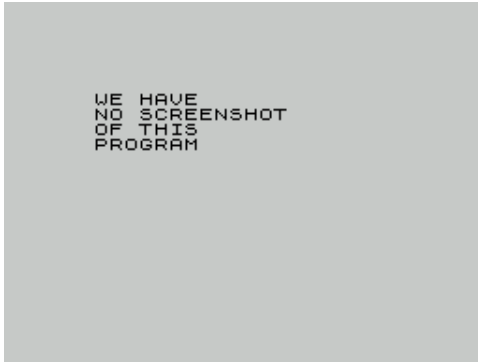

Stek (MPF Software,1990)
Board/Card Game

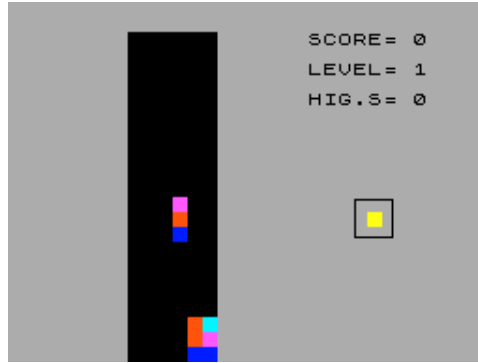

Stelar (Ventamatic,1983)
Arcade

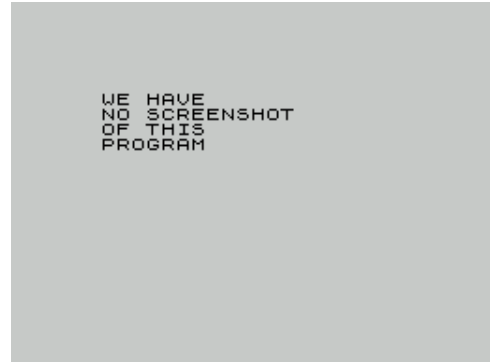

Stellar Attack (Spectrum Computing,1985)
Arcade



Stellar Duel (Tricoder Cambridge,1982)
Arcade

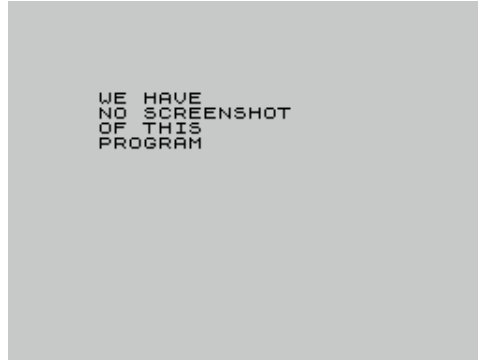

Stellar Holocaust (A'n'F Software,.)
Arcade Adventure



Stena (THD,1992)
Arcade

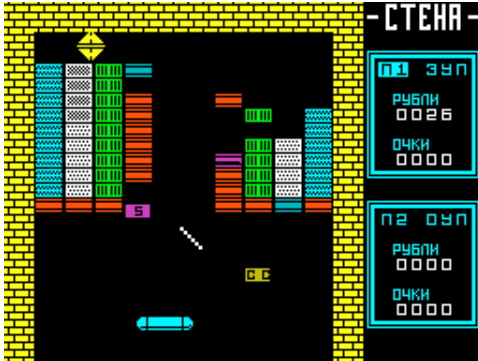

Stensontron (Sybilsoft,1987)
Text Adventure

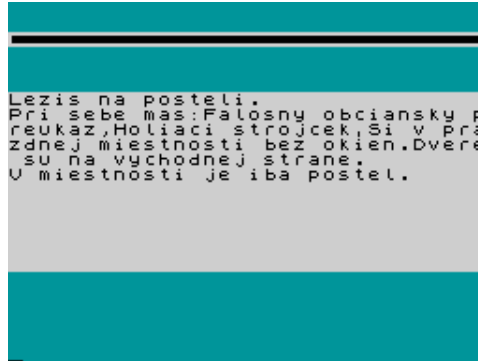

Steppingstone (D-B Software,1987)
Arcade



Stereoscopic Television (PW Marketing,1993)
Utility



Steve Davis Snooker (CDS Microsystems,1984)
Arcade



Steve Silver Adventure 1 (WB Software,1983)
Text Adventure

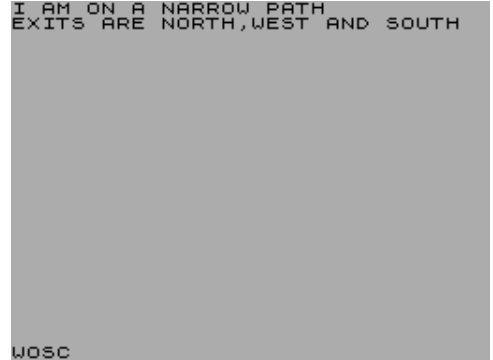

Steve Silver Adventure 2 (WB Software,1983)
Text Adventure

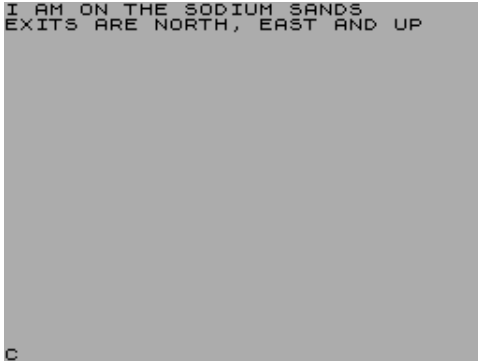

Stevie Dotman (Matthew Westcott,1999)
Arcade

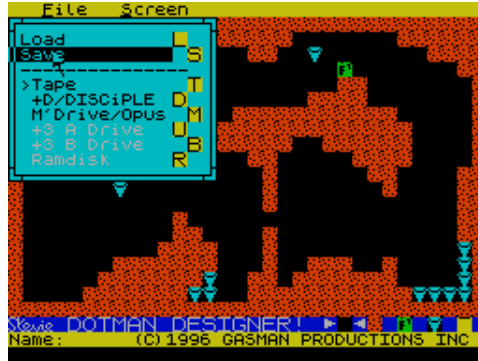

S.T.I. (Bug-Byte Software Ltd,1988)
Text Adventure



Stickman in the Olympics (,1984)
Sport



Still One More Big Disk (Zenobi Software,)
Compilation



St. Moritz (Shiva Publishing Ltd,1983)
Arcade



Stock Cars II, 3D (E&J Software,1992)
Arcade

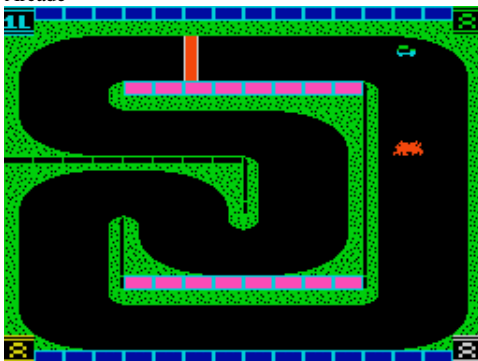

Stock Control (Kemp Ltd,1984)
Utility



Stiffflip & Co. (Palace Software,1987)
Arcade Adventure



Stir Crazy Featuring Bobo (Infogrames,1990)
Arcade Adventure



Stockcar (5D Software,)
Arcade

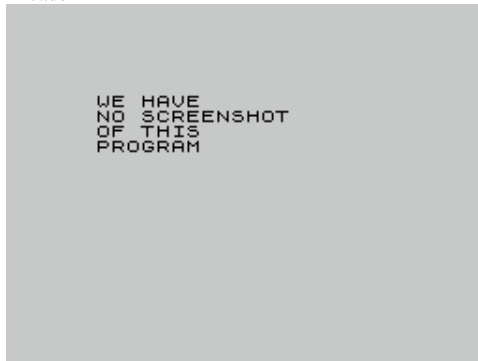

Stock Control (Gemini Marketing Ltd,1984)
Utility: Spreadsheet



Stock Control (Transform Ltd,1983)
Utility

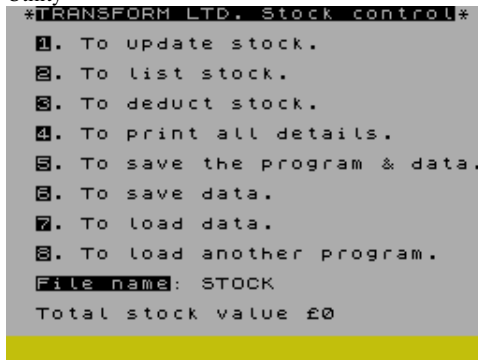

Still Another Big Disk (Zenobi Software,1992)
Compilation



STK (Your Sinclair,1992)
Utility: Programming

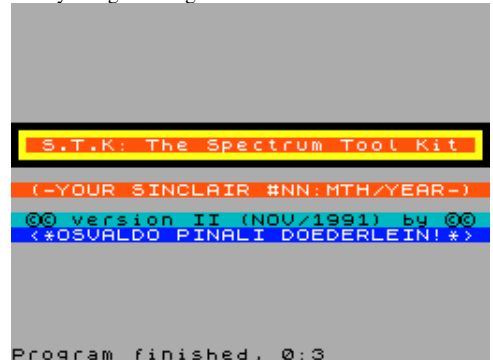

Stock Car Championship, 3D (Firebird Software
Ltd,1988)
Arcade



Stock Control (Hilderbay Ltd,1983)
Utility

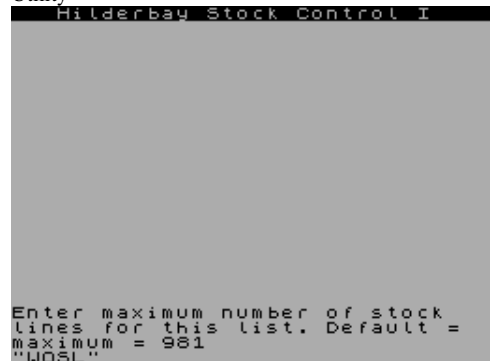

Stocking Filler (,)
Utility



Stock Market (ASP Software Ltd,1983)

Simulation

Shares held by WOS	MARKET PRICES
LEAD 10	Multibody 10.00
ZINC 0	Lead Mine 50.00
TIN 0	T.I.A.F. 250.00
GOLD 0	Zinc Inc. 1250.00
BANK 900.00	Erskine
	Tin Plate
	S. Beere
	Gold Mine

Type "B" to buy, "S" to sell, or "0" to end your turn

Stock Market (CCS,1983)

Simulation

SHARE PRICES	TREND 0 TO 6
MAXILL Ltd. 213	3
SEECHO & SONS. 29	5
WARMSLEY & Co. 224	3
DYNAX p.l.c. 227	3
EVORLEYS Co-op. 213	5
PUTAX. 213	0

SHARES INDEX : 175 (0)
PRESS 'S' FOR A GRAPH
PRESS ENTER TO CONTINUE

Stocks and Shares (Deryck Banks,1985)

Simulation

SHARES	NO. OF SHARES	PRICE
ZINC	0	2.67
TIN	0	16.01
LEAD	0	98.1
GOLD	0	1999.9

INPUT BUY (B), SELL (S), OR END (E)
MONEY = £100
"L"

Stolen Data (Extacy-3,1994)

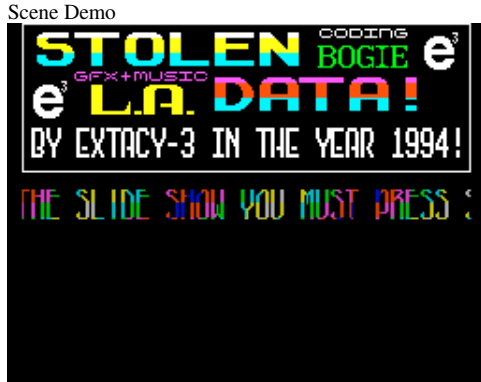

Stomp (DK'Tronics Ltd,1985)



Stomp (Omega Software Ltd,1985)

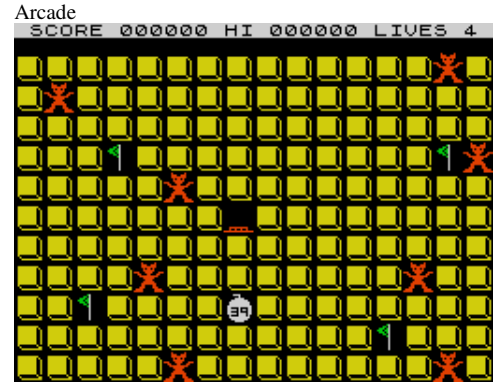

Stomping Stan (Britannia Software Ltd,1983)

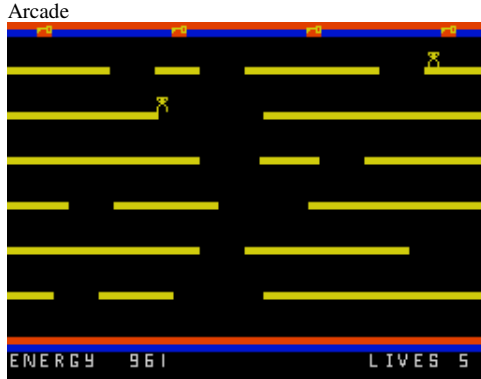

Stone (MicroHobby,1985)



Stoned on Bananas (The United Minds,1995)



Stonkers (Imagine Software Ltd,1983)



Stop Ball (Dro Soft,1987)

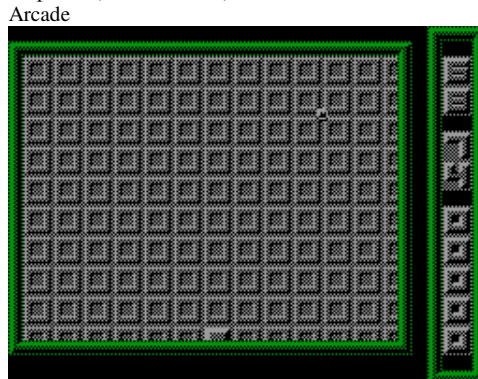

Stopit (HSC,1985)

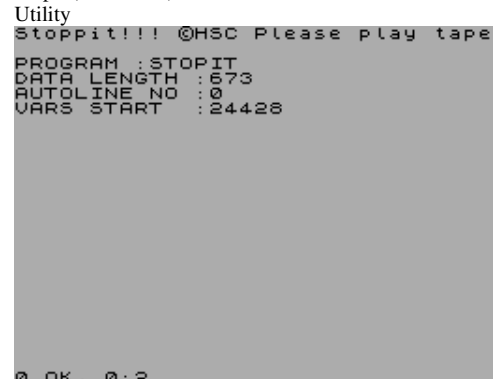

Stop Reset (Busy Software,1989)

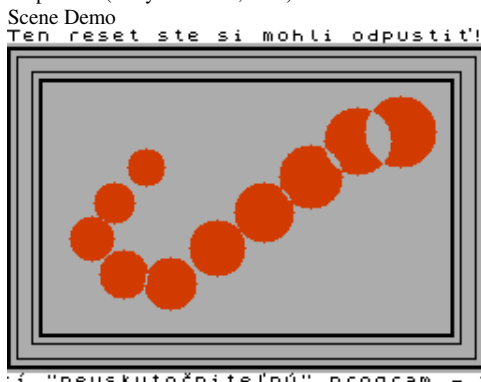

Stop-Reveal (Kerr,1985)



Stop That There Alien!!!! (David Swann,1984)



! "neuskutočniteľný" program - 3

Stop the Express (Sinclair Research Ltd,1983)

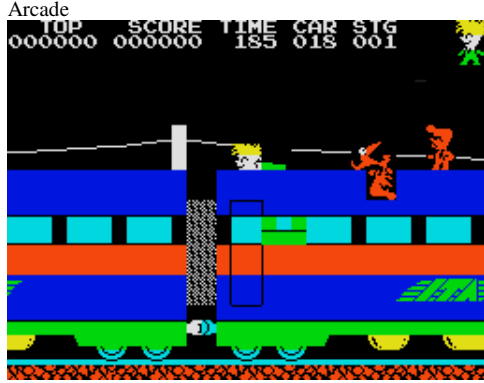

Storm-Fighters (Dixie Software,1982)



Stormlord (Hewson Consultants Ltd,1989)



Storymaker (Arnold Wheaton Software,1986)



Story So Far Vol 1, The (Elite Systems Ltd,1989)



Storm (Mastertronic Ltd,1986)



Stormforce (Meow Micros,1983)



Stormlord II: Deliverance (Hewson Consultants Ltd,1990)

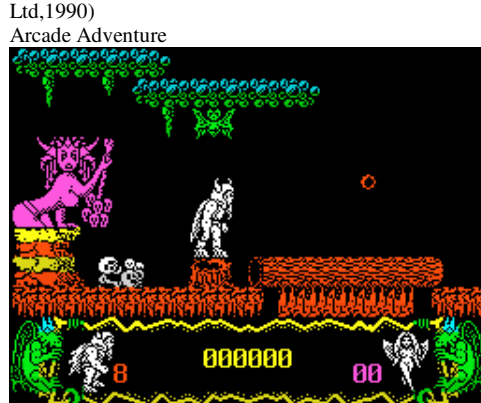

Story of Dave 2, The (MNL Software,1984)



Story So Far Vol 2, The (Elite Systems Ltd,1989)



Stormbringer (Mastertronic Added Dimension,1987)



Stormforce + Starbuster (Meow Micros,1983)

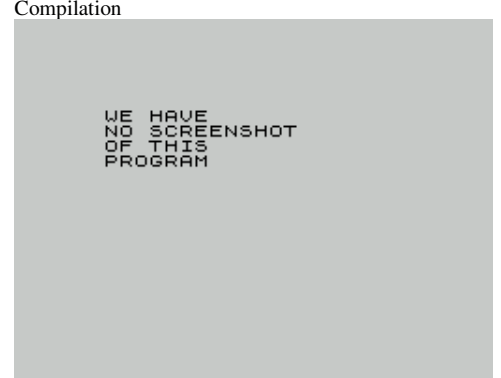

Story House (Creative Sparks,1984)



Story of Dave 3, The (MNL Software,1984)



Story So Far Vol 3, The (Elite Systems Ltd,1989)



Story So Far Vol 4, The (Elite Systems Ltd,1989)
Compilation

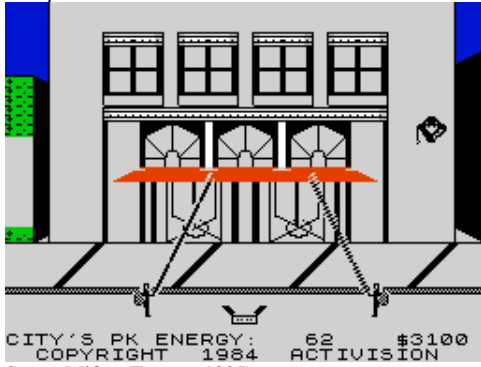

Strana Mifov (Fantasy,1995)
Strategy



Stranded (Zenobi Software,1992)
Text Adventure

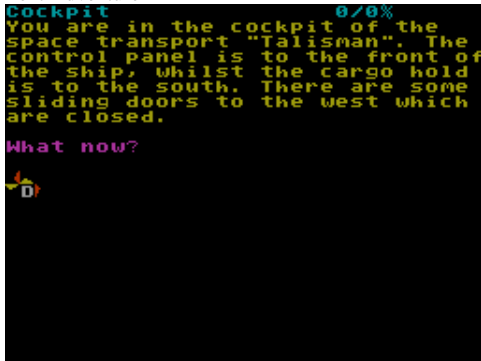

Stranger 1 (Hacker Jim Goer,1990)
Scene Demo

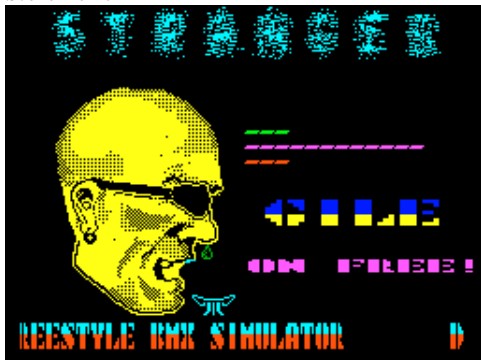

Strange World (Pelagon Software,1989)
Text Adventure



St. Petersburg Ikon, The (R.D. Foord Software,1986)
Text Adventure



Stranded (.)



Strangeloop (Virgin Games Ltd,1984)
Arcade



Stranger 2 (Hacker Jim Goer,1990)
Scene Demo



Stratego (Accolade Inc.)
Board/Card Game



Straight Dealer (Stephen Hartley Software,1984)
Board/Card Game

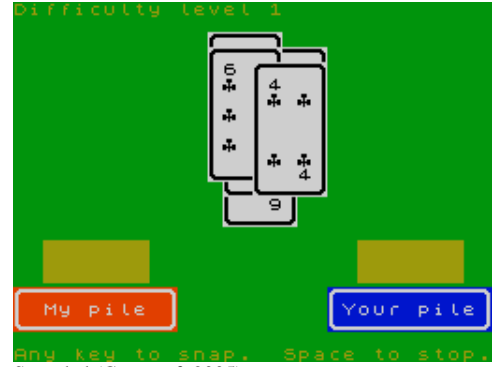

Stranded (Cronosoft,2005)

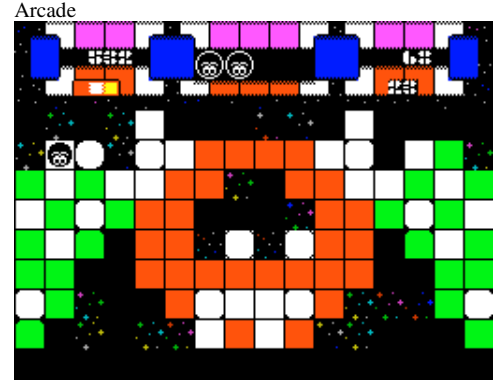

Strange Odyssey (Adventure International,1984)
Text Adventure

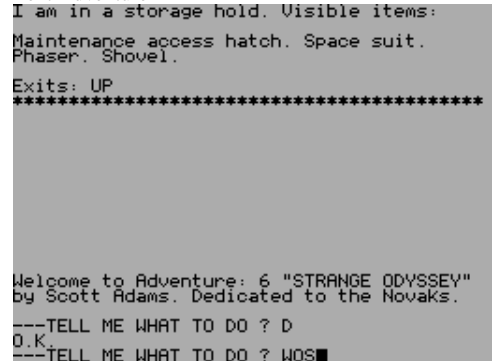

Strangers from Outer Space (Gadtek Games,1995)
Arcade



Strategy, 3D (Quicksilva Ltd,1983)
Board/Card Game

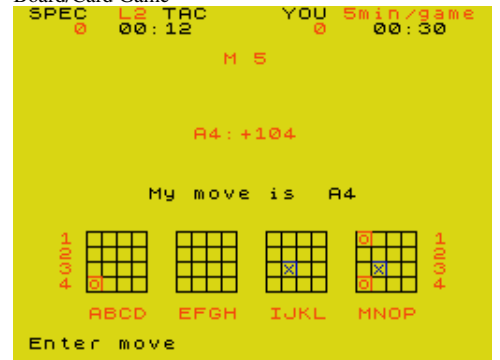

Strategy 8 (Nite Owl,1984)
Board/Card Game

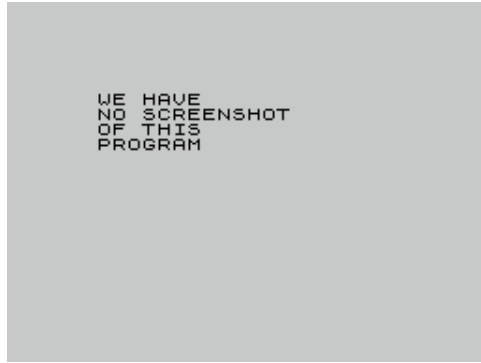

Streaker (Bulldog,1987)
Arcade Adventure



Street Cred' Boxing (Players Premier Software,1989)
Sport



Street Fighter (Shards Software,1983)
Arcade



Street Gang Football (Code Masters Ltd,1989)
Arcade

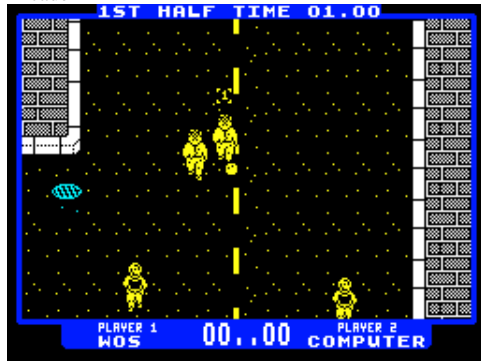

Stratford Depotmaster (Ashley Greenup,1991)
Simulation

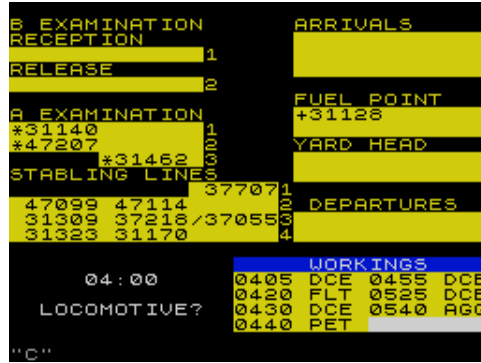

STR Edit (Jury Nikolskiy,1987)
Utility

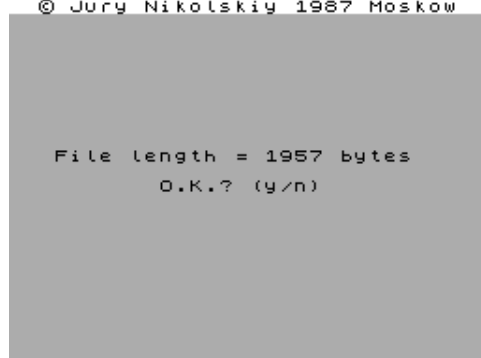

Street Cred' Football (Players Premier Software,1989)
Arcade

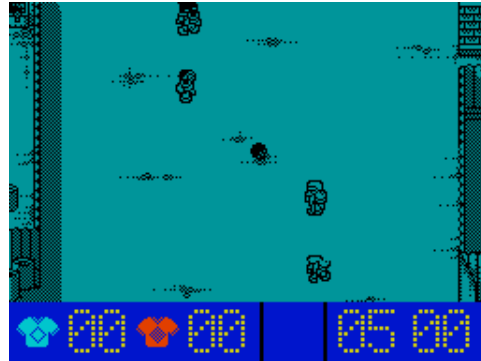

Street Fighter II (Go!,1993)
Arcade

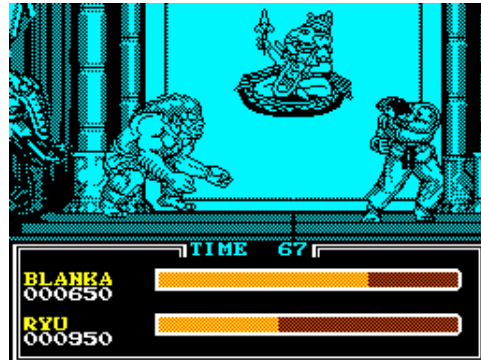

Street Hassle (Melbourne House,1988)
Arcade

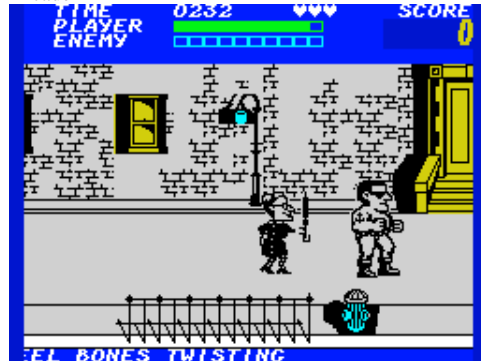

Strawberry Fields (The United Minds,1995)
Scene Demo



Street Cred (Mainstream Software,1988)
Arcade



Street Fighter (Go!,1988)
Arcade



Street Gang (Players Software,1989)
Arcade



Street Hawk (Ocean Software Ltd,1986)
Arcade

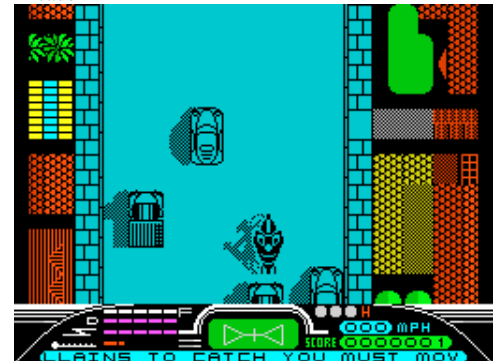

Street Hawk - Crash Subscribers Edition (Ocean Software Ltd,1985) Arcade



Street Sports Basketball (US Gold Ltd,1988) Arcade

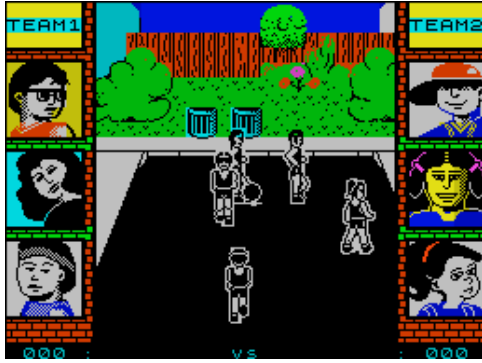

Strider (US Gold Ltd,1989) Arcade

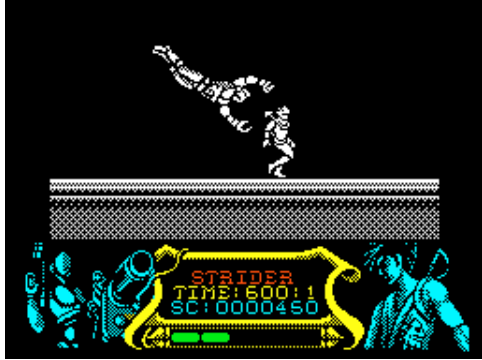

Strike 2 (Mirrosoft Ltd.) Arcade



Strike Force Cobra (Piranha,1986) Arcade

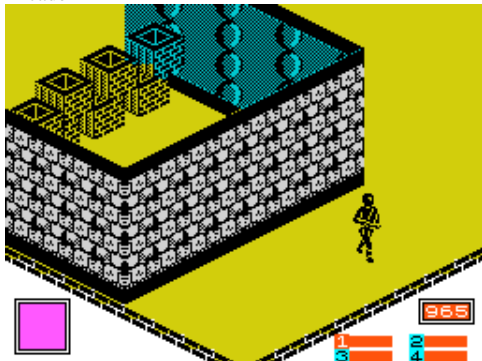

Street Racer (Profisoft,1983) Arcade

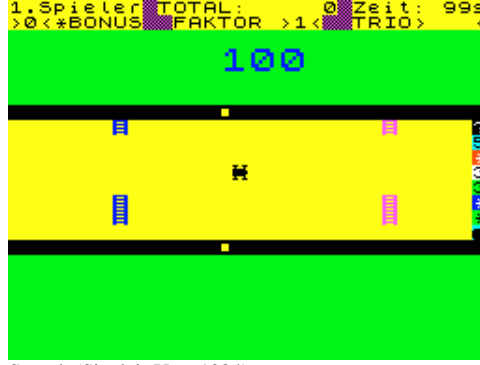

Stretch (Sinclair User,1984) Utility: BASIC Related



Strider II (US Gold Ltd,1990) Arcade



Strike Attack (Micro-Mart Software,1984) Arcade

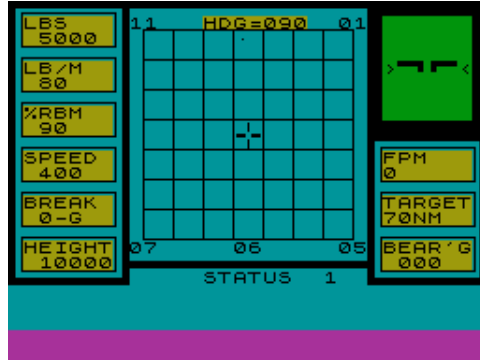

Strike Force Harrier (Mirrosoft Ltd,1986) Arcade



Street Soccer (Code Masters Gold,1988) Sport



Strgol (Kybso,1987) Text Adventure



Strike! (Mastertronic Added Dimension,1987) Sport

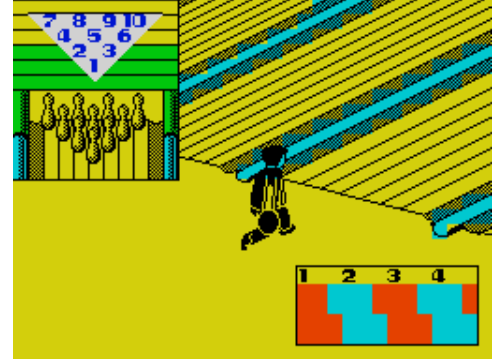

Strike Attack 2 (Micro-Mart Software,1984) Arcade

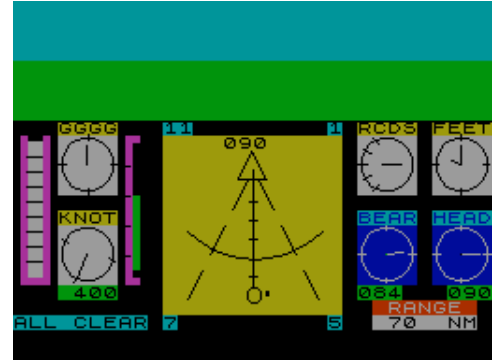

Strike Force SAS (Mikro-Gen Ltd,1987) Arcade



Strike Four (Spectre Soft,1984)
Compilation



Striker (Cult Games,1989)
Simulation



Striker (Top Spec,1986)
Simulation



Striker Manager (Cult Games,1991)
Simulation



Stringing the Ton (Shiva Publishing Ltd,1983)
Educational



Strip (Busy Software,1989)
Scene Demo



Strip Black-Jack (Load 'n' Run [Ita],1986)
Board/Card Game



Strip Demo (.)
Scene Demo



Strip-Dice (S&S Software,1985)
Board/Card Game



Strip Game (Diamond Software,1988)
Board/Card Game



Strip Jack (Carlos Correia,1985)
Board/Card Game



Strip Jack (J. Weigner/M. Reimann,1984)
Board/Card Game



Strip Logik (Double-Pig-Soft,1990)
Board/Card Game



ST Ripper (Dominic Morris,1993)
Utility: Sound Manipulation

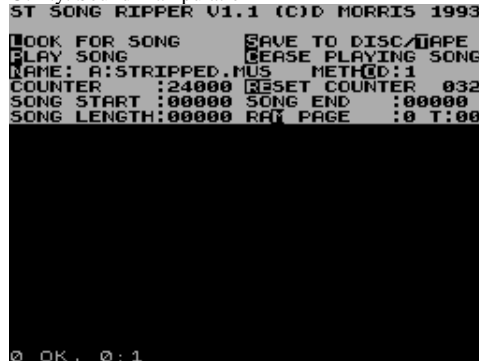

Strip Poker (Vlama,1986)
Board/Card Game



Strip Poker Demo, The (The Mad Guys,1992)
Scene Demo

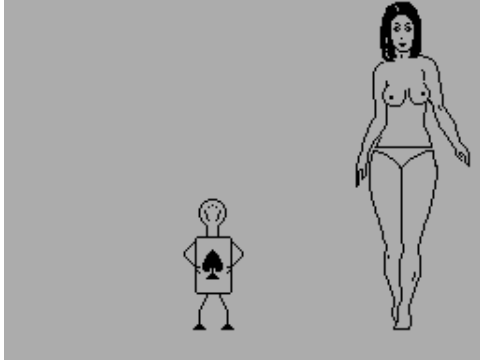

Strip Reversi (Outland Corp,1996)
Board/Card Game



Stroll in the Bleak Forest, A (Zenobi Software,1989)
Arcade Adventure

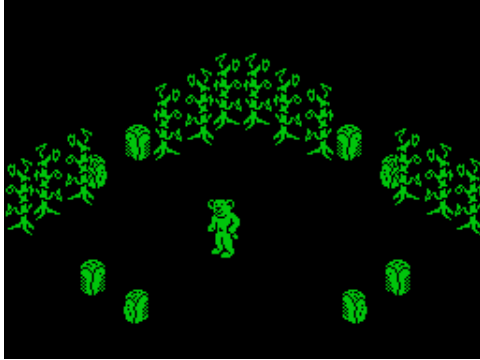

Stroper (Zigurat Software,.)
Arcade



Stryker - In the Crypts of Trogan (Code Masters Ltd,1992)
Arcade



Strip Poker II Plus (Anco Software Ltd,1988)
Board/Card Game



Striptise (Andreas Niemann,1984)
Board/Card Game



Strong Demo (Intruders,1991)
Scene Demo



Structure of the Flower, The (Calpac Educational Software,1983) Educational



Stuart Henry's Pop Quiz (Bellflower Software,1984)
Board/Card Game

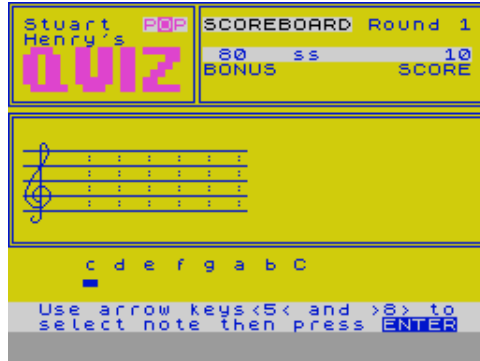

Strip Pontoon (High Voltage,1985)
Board/Card Game



Stroke4 (16/48 Tape Magazine,1983)
Arcade



Strontium Dog: The Killing (Quicksilva Ltd,1984)
Arcade



Strumpfovi (Xenon,1986)
Text Adventure



Stuart Period, The (Akadimias Software,1985)
Educational



Study Biology - 13 years+ (Scisoft,1983)

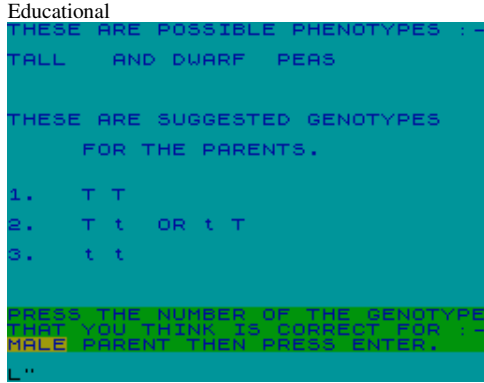

Study Maths I - 9-13 years (Scisoft,1983)

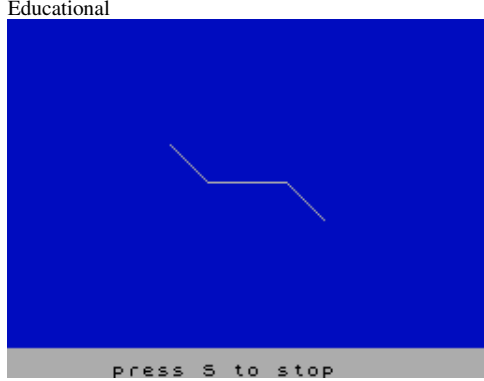

Stuff Me Another Big Disk (Zenobi Software,)

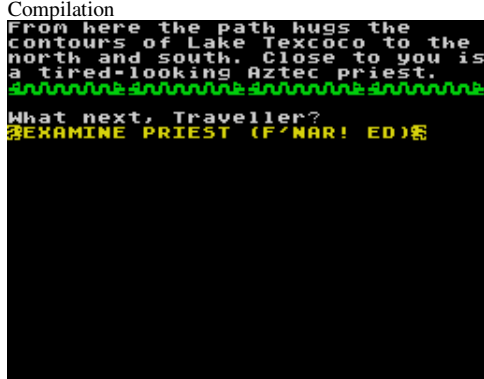

Stunt Car Racer (Micro Style,1989)

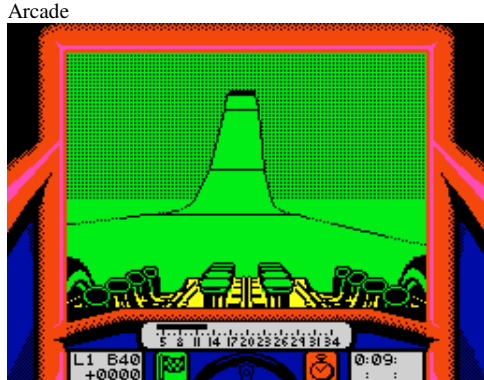

Stupid Sports (XFAWORLD Software,2005)

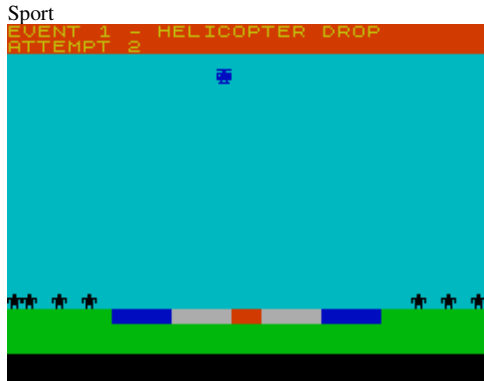

Study Chemistry - 13 years+ (Scisoft,1983)

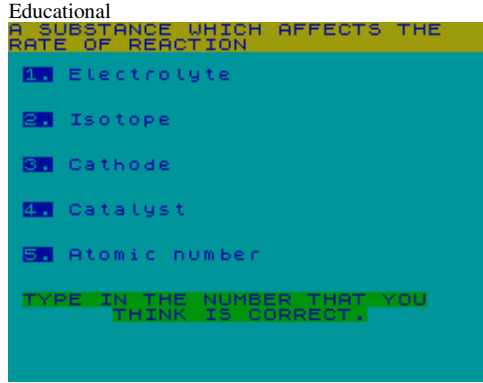

Study Maths II - 9-13 years (Scisoft,1983)

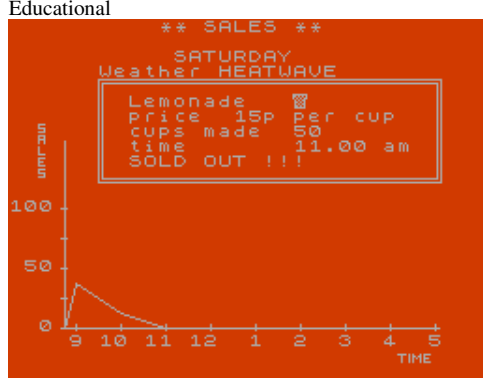

S.T.U.N. Runner (Domark Ltd,1990)



Stuntman Seymour (Code Masters Ltd,1992)



Style (Saga Systems Ltd,1985)



Study Maths I - 13 years+ (Scisoft,1983)

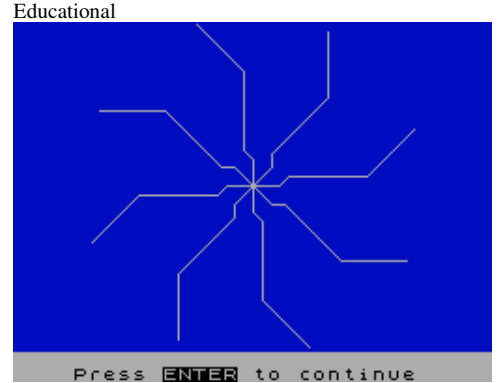

Study Physics - 13 years+ (Scisoft,1983)

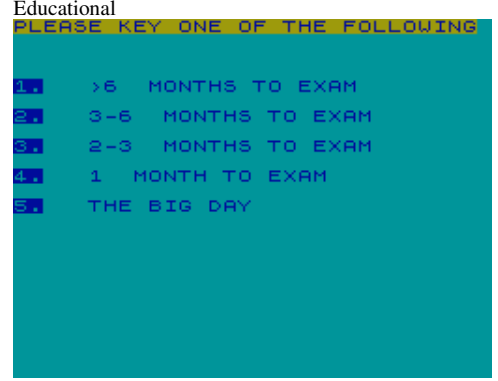

Stunt Bike Simulator (Silverbird Software Ltd,1988)



Stupid (Sebastian Gomez Antelo,)



Styx (Bug-Byte Software Ltd,1983)



SU2 Advanced Tape Utility (Kobrahssoft,1987)
Utility: Copier



Subbuteo (Rob Morris,)
Simulation



Subgame (Rob Morris,)
Simulation



Sub Hunt (Fontana Publishing,1984)
Arcade

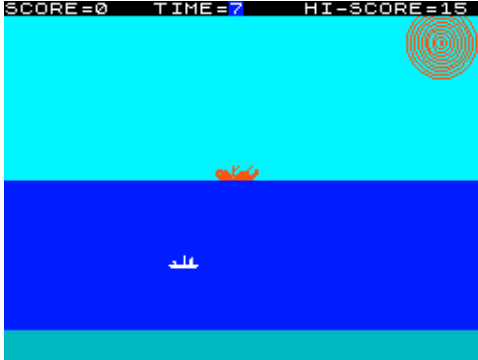

Subliminal Extacy 0 (Extacy-3,1994)
Covertape

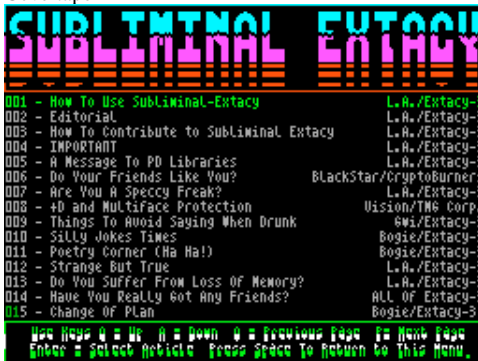

SU4 Advanced Tape Utility (Kobrahssoft,)
Utility: Copier



Subbuteo + Subgame (Rob Morris,)
Compilation



Sub Hunt (Anco Software Ltd,1983)
Arcade



Sub Hunt (Micro Press [1],1983)
Arcade

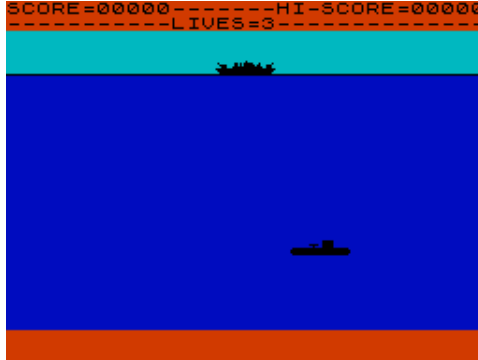

Subliminal Extacy 1 (Extacy-3,1995)
Covertape

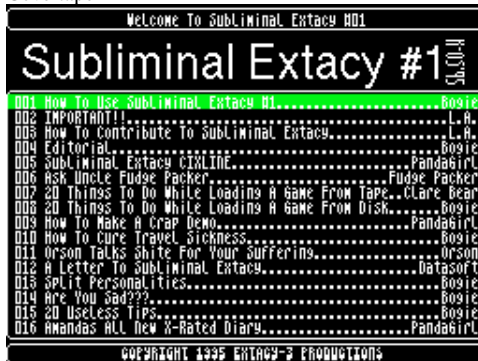

Subbuteo (Electronic Zoo,1990)
Arcade



Sub Chase (Gem Software,1983)
Arcade

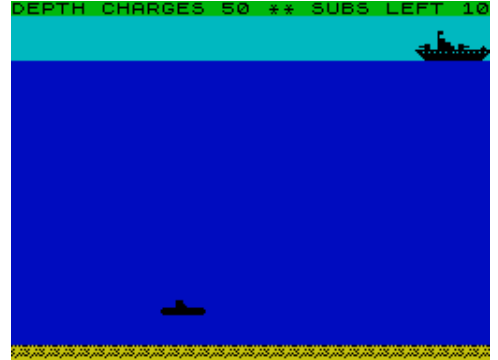

Sub Hunt (C-Tech,1982)
Arcade



Sub Hunter (Micro-Mart Software,1984)
Arcade

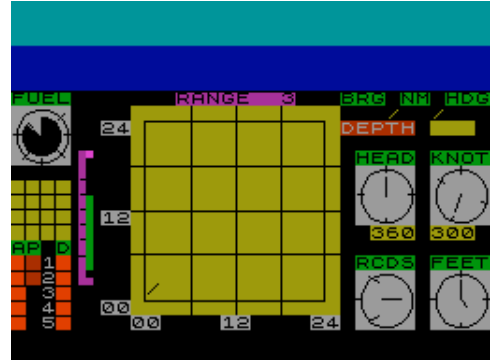

Subliminal Extacy 2 (Extacy-3,1995)
Covertape



Submarine (Romik Software,1983)

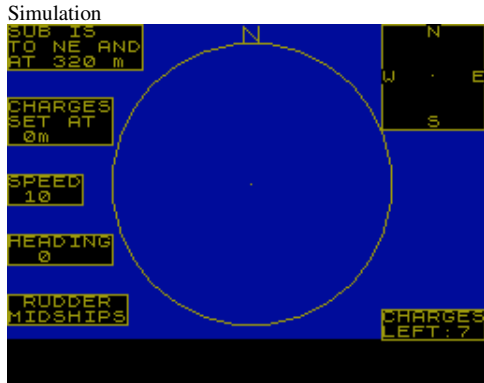

Submarine Attack (Richard Shepherd Software Ltd,1982)



Submarino (,)



Submarinos U-95 Batalla Naval (Microparadise Software,1984)



Subsunk (Firebird Software Ltd,1985)

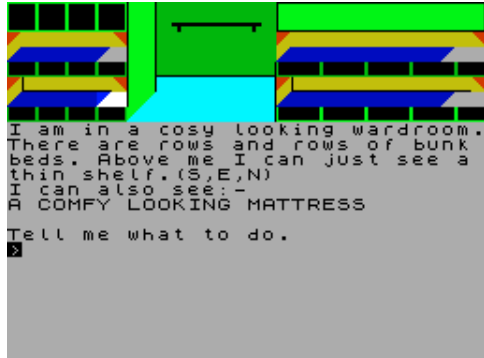

Submarine (Sinclair Programs,1983)



Submariner (Atlantis Software Ltd,1988)



Submarino Amarillo (Ventamatic,1984)



Sub-Sonic (Extacy-3,1993)



Subterranean Nightmare (Americana Software Ltd,1986)



Submarine (ZX Computing,1984)



Submarine Strike (Pulsonic,1984)

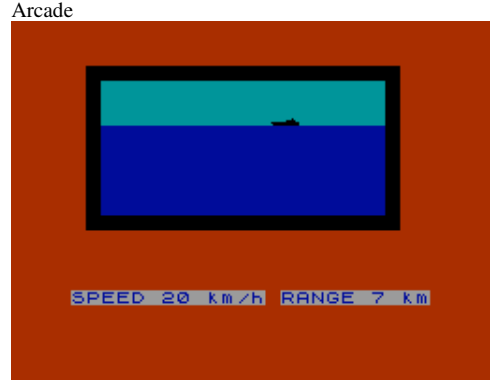

Submarinos, Los (MicroHobby,1985)



Sub-Sonic 2 (Extacy-3,1993)

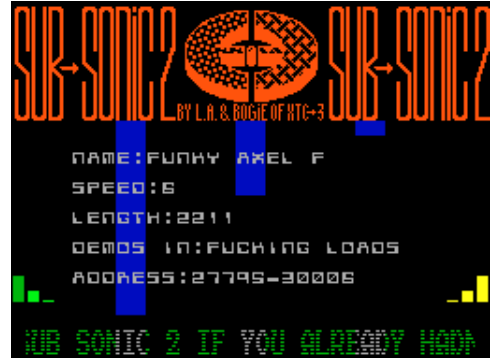

Subterranean Stryker (Insight Software,1985)



Sub Track (Amba Software,1986)
Arcade



SU Crew, The (Sinclair User,1992)
Board/Card Game

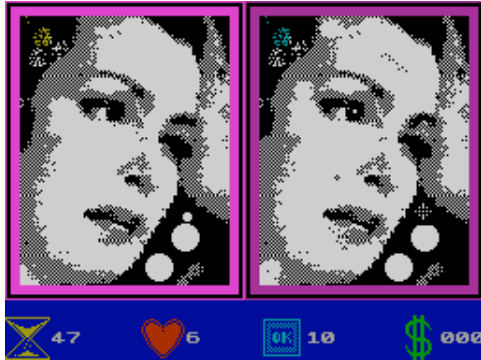

Suicida, El (MicroHobby,1985)
Arcade



SU issue 101: Double Hits 2 (Sinclair User,1990)
Covertape



SU issue 104: Double Hits 5 (Sinclair User,1990)
Covertape



Subway Vigilante (Players Premier Software,1989)
Arcade

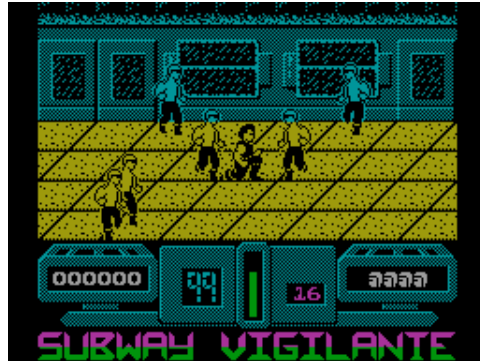

Sudoku (Miguel Angel Rodriguez Jodar,2005)
Board/Card Game

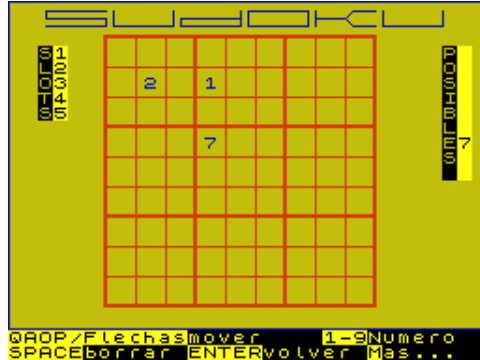

Suicide Island (Dollarsoft,1984)
Text Adventure

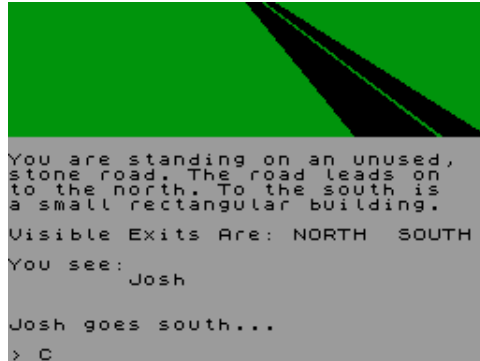

SU issue 102: Double Hits 3 (Sinclair User,1990)
Covertape



SU issue 105: Six of the Best 1 (Sinclair User,1990)
Covertape

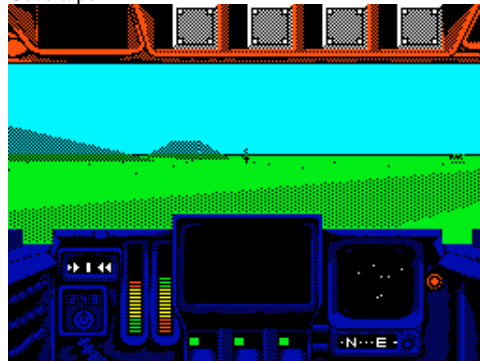

Sucker Demo, The (The United Minds,1995)
Scene Demo



Suffrage? (Garry Rowland,)
Simulation

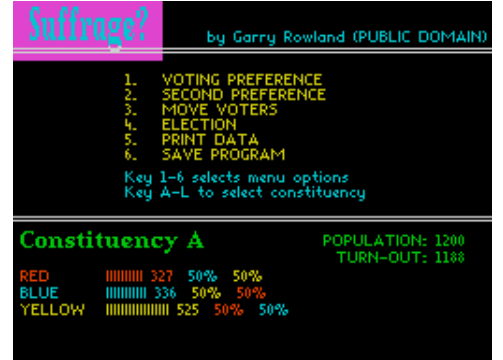

SU issue 100: Double Hits 1 (Sinclair User,1990)
Covertape

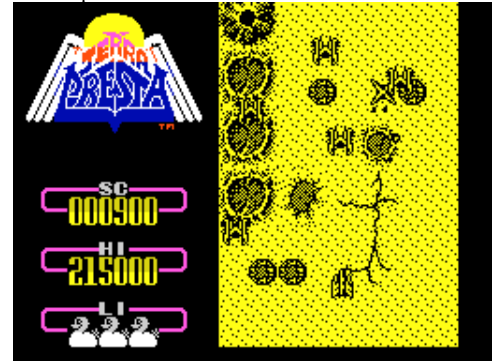

SU issue 103: Double Hits 4 (Sinclair User,1990)
Covertape



SU issue 106: Six of the Best 2 (Sinclair User,1990)
Covertape



SU issue 107: Six of the Best 3 (Sinclair User,1991)
Covertape

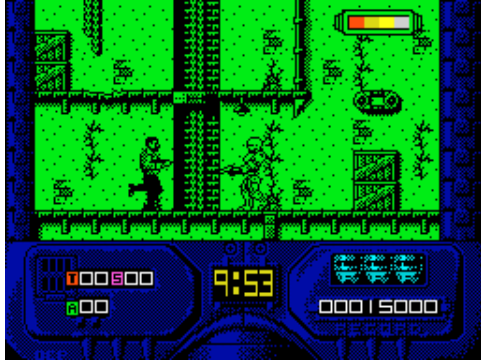

SU issue 110: Great Eight 2 (Sinclair User,1991)
Covertape

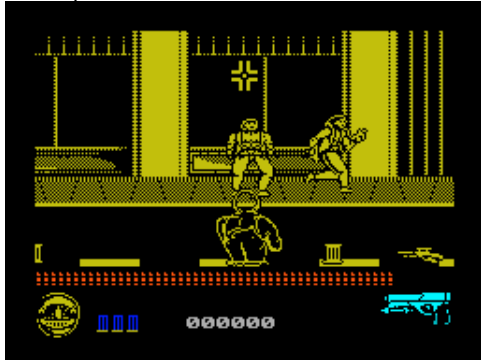

SU issue 113: Great Eight 3 (Sinclair User,1991)
Covertape



SU issue 116: Great Eight 5 (Sinclair User,1991)
Covertape



SU issue 119: Great Eight 8 (Sinclair User,1992)
Covertape



SU issue 108: Six of the Best 4 (Sinclair User,1991)
Covertape



SU issue 111: Ten Pack (Sinclair User,1991)
Covertape

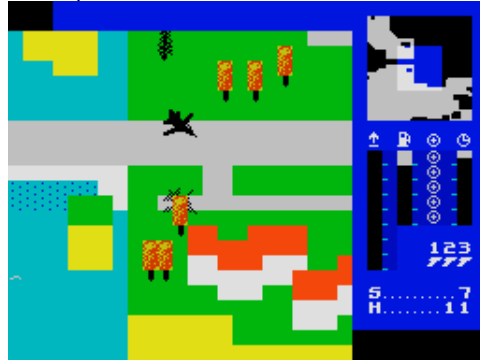

SU issue 114: Great Eight 4 (Sinclair User,1991)
Covertape

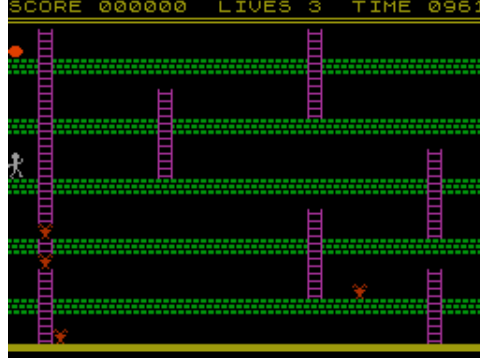

SU issue 117: Great Eight 6 (Sinclair User,1991)
Covertape



SU issue 120: Great Eight 9 (Sinclair User,1992)
Covertape

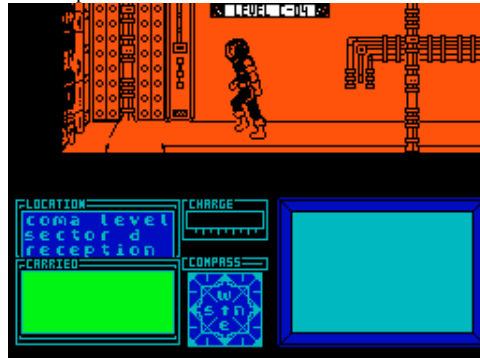

SU issue 109: Great Eight 1 (Sinclair User,1991)
Covertape



SU issue 112: Twelve Pack 1 (Sinclair User,1991)
Covertape

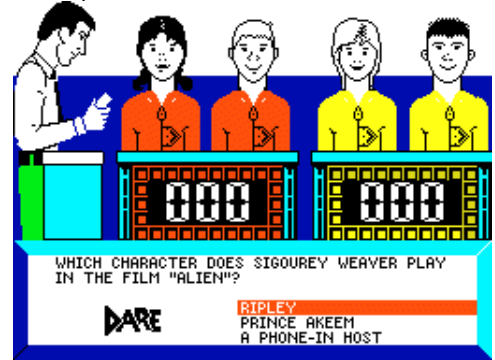

SU issue 115: Fab Four (Sinclair User,1991)
Covertape

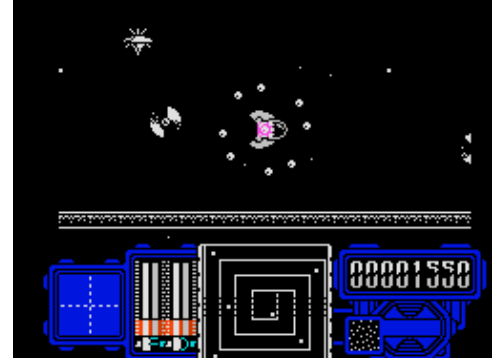

SU issue 118: Great Eight 7 (Sinclair User,1991)
Covertape



SU issue 121: Great Eight 10 (Sinclair User,1992)
Covertape

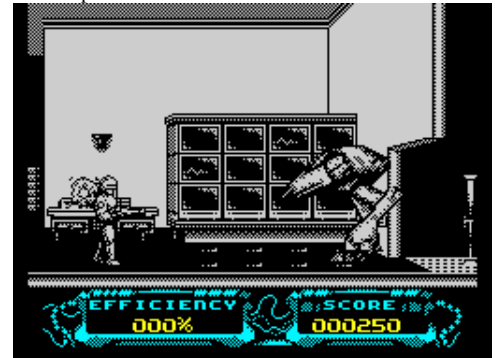

SU issue 122: Great Eight 11 (Sinclair User,1992)
Covertape

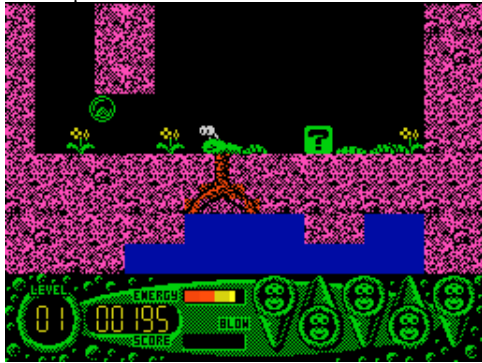

SU issue 125: Great Eight 14 (Sinclair User,1992)
Covertape



SU issue 128: Great Eight 17 (Sinclair User,1992)
Covertape



SU issue 131: Fun Four 1 (Sinclair User,1993)
Covertape



SU issue 134: Fun Four 4 (Sinclair User,1993)
Covertape



SU issue 123: Great Eight 12 (Sinclair User,1992)
Covertape



SU issue 126: Great Eight 15 (Sinclair User,1992)
Covertape



SU issue 129: Great Eight 18 (Sinclair User,1992)
Covertape



SU issue 132: Fun Four 2 (Sinclair User,1993)
Covertape



SU issue 72: Megatape 1 (Sinclair User,1988)
Covertape



SU issue 124: Great Eight 13 (Sinclair User,1992)
Covertape



SU issue 127: Great Eight 16 (Sinclair User,1992)
Covertape



SU issue 130: Great Eight 19 (Sinclair User,1992)
Covertape



SU issue 133: Fun Four 3 (Sinclair User,1993)
Covertape



SU issue 73: Megatape 2 (Sinclair User,1988)
Covertape

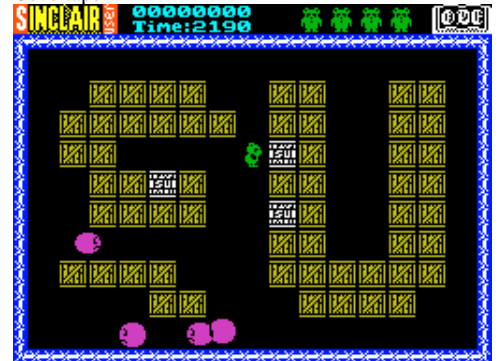

SU issue 74: Megatape 3 (Sinclair User,1988)
Covertape



SU issue 77: Megatape 6 (Sinclair User,1988)
Covertape



SU issue 80: Megatape 9 (Sinclair User,1988)
Covertape

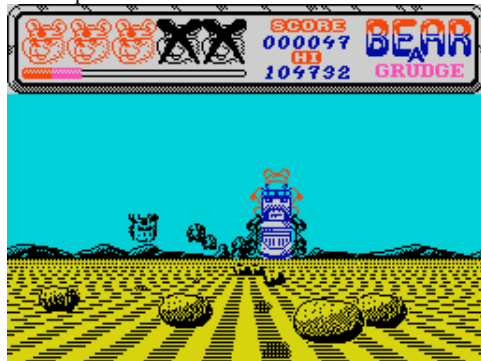

SU issue 83: Megatape 12 (Sinclair User,1989)
Covertape



SU issue 86: Megatape 15 (Sinclair User,1989)
Covertape

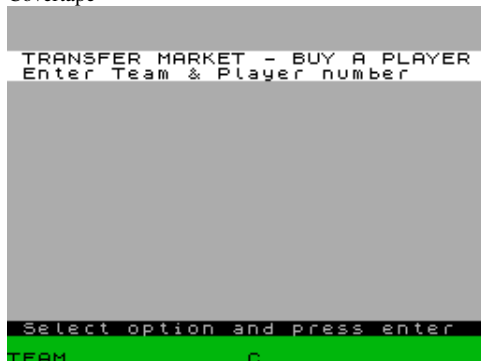

SU issue 88: Megatape 17 (Sinclair User,1989)
Covertape



SU issue 75: Megatape 4 (Sinclair User,1988)
Covertape



SU issue 78: Megatape 7 (Sinclair User,1988)
Covertape

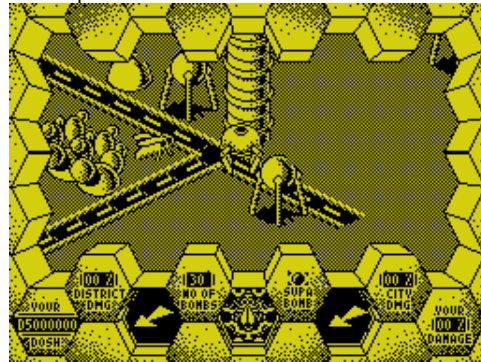

SU issue 81: Megatape 10 (Sinclair User,1988)
Covertape



SU issue 84: Megatape 13 (Sinclair User,1989)
Covertape



SU issue 87: Megatape 16 (Sinclair User,1989)
Covertape

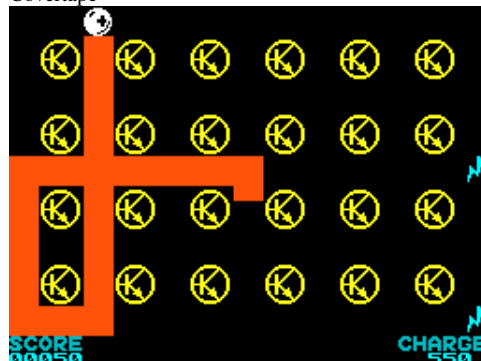

SU issue 88: Megatape 17 (Sinclair User,1989)
Covertape



SU issue 76: Megatape 5 (Sinclair User,1988)
Covertape



SU issue 79: Megatape 8 (Sinclair User,1988)
Covertape



SU issue 82: Megatape 11 (Sinclair User,1989)
Covertape



SU issue 85: Megatape 14 (Sinclair User,1989)
Covertape



SU issue 88: Megatape 17 (Sinclair User,1989)
Covertape

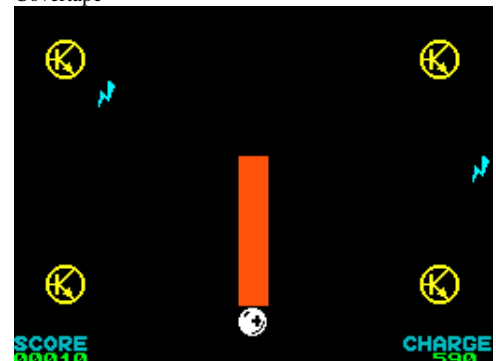

SU issue 88: Megatape 17 (Sinclair User,1989)
Covertape



SU issue 89: Megatape 18 (Sinclair User,1989)
Covertape

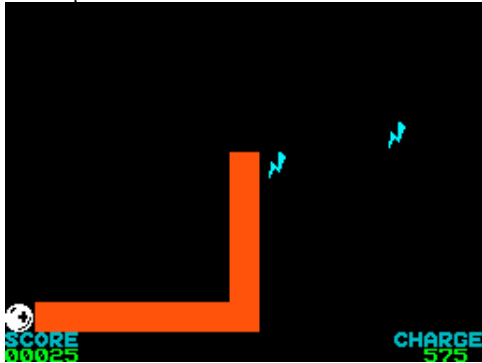

SU issue 92: 6 Amazing Coin-Op Tracks (Sinclair User,1989)
Covertape



SU issue 94: Megatape 23 (Sinclair User,1990)
Covertape

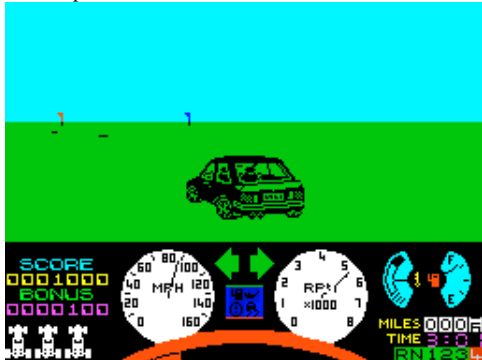

SU issue 98: Megatape 26 (Sinclair User,1990)
Covertape

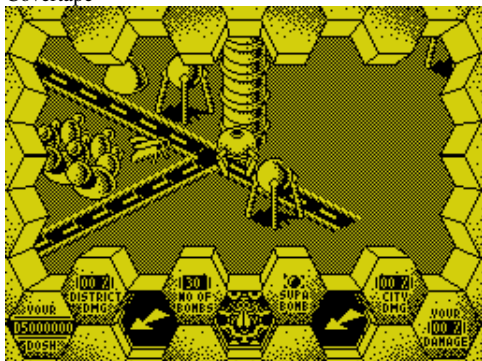

Summer Games II (US Gold Ltd,1988)
Sport



SU issue 90: Megatape 19 (Sinclair User,1989)
Covertape



SU issue 92: Megatape 21 (Sinclair User,1989)
Covertape



SU issue 95: Megatape 24 (Sinclair User,1990)
Covertape



SU issue 99: Megatape 27 (Sinclair User,1990)
Covertape



Summer Gold (US Gold Ltd,1987)
Compilation

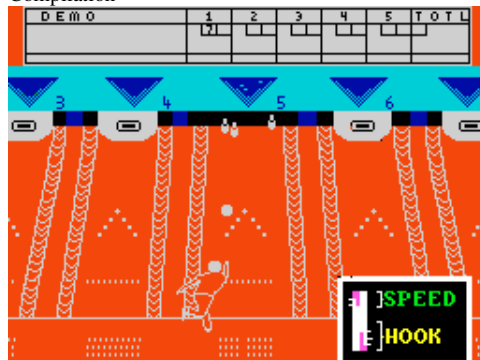

SU issue 91: Megatape 20 (Sinclair User,1989)
Covertape



SU issue 93: Megatape 22 (Sinclair User,1989)
Covertape



SU issue 96: Megatape 25 (Sinclair User,1990)
Covertape



Summer Games (US Gold Ltd,1988)
Sport



Summer Olympiad (Tynesoft,1988)
Sport



Summer Pack (Opera Soft S.A.,1989)
Compilation



Summertime Specials (US Gold Ltd,1988)
Compilation



Sun Computer Crosswords Volume 2, The (Akorn Ltd,1988)
Compilation



Sun Computer Crosswords Volume 5, The (Akorn Ltd,1988) Compilation

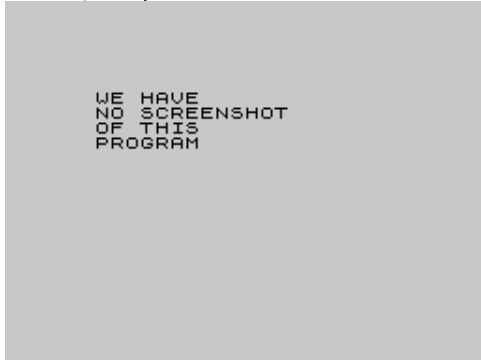

Sunflower Number Show, The (Macmillan Software Ltd,1985) Educational

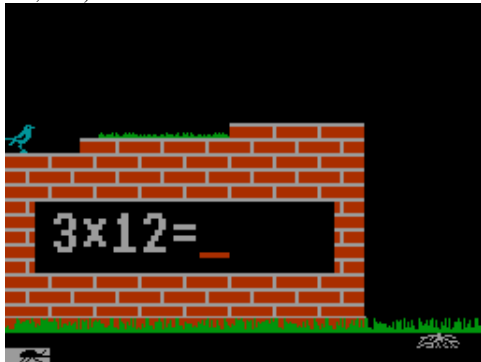

Summer Santa (Alpha-Omega Software,1986)
Arcade



Sum Scruncher (Longman Software,1983)
Educational



Sun Computer Crosswords Volume 3, The (Akorn Ltd,1988)
Compilation

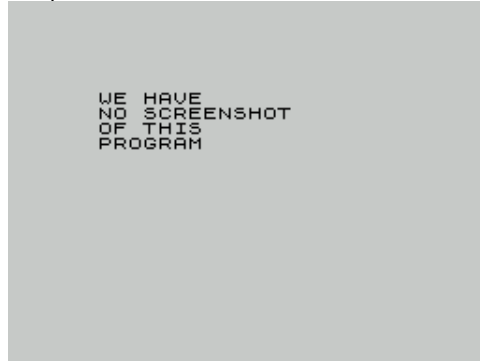

Sun Computer Crosswords Volume 6, The (Akorn Ltd,1988) Compilation



Sunglass Sam Goes Alpine Skiing (Spectrum Computing,1984) Arcade



Summer Sounds (Tarzan Boy,1989)
Scene Demo



Sun Computer Crosswords Volume 1, The (Akorn Ltd,1988)
Compilation



Sun Computer Crosswords Volume 4, The (Akorn Ltd,1988)
Compilation



Sundered Sword, The (Red Rat Software,1987)
Text Adventure



Sunrise over Bethselamine (Armadillo Soft,1986)
Text Adventure

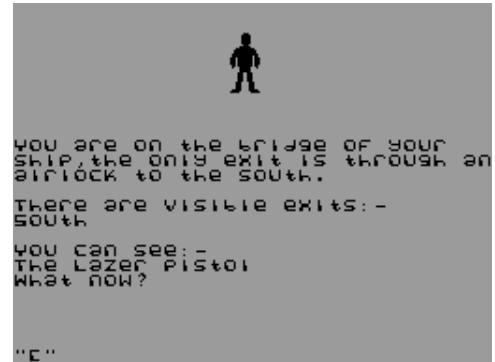

Sunshine (MicroHobby,1991)
Music



Supaplex (Flymansoft,1999)
Arcade

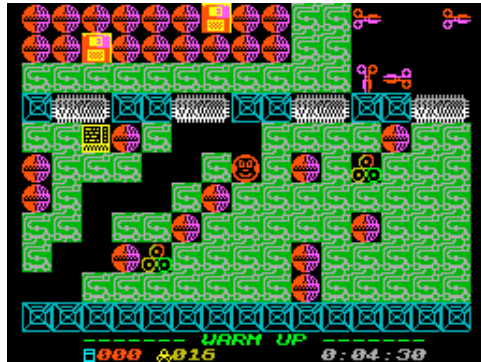

Super All-Stars Collection (Code Masters Ltd,1992)
Compilation



Super Bike TransAm (Code Masters Ltd,1989)
Arcade



Super Bridge (Buffer Micro Ltd,1984)
Board/Card Game

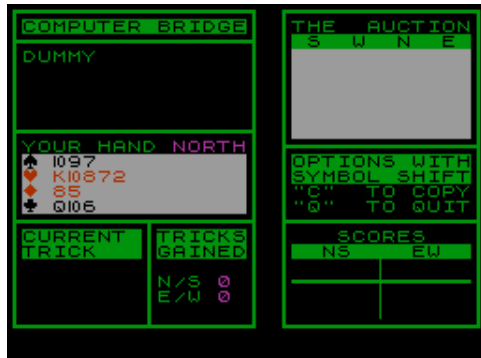

Sun Star (CRL Group PLC,1987)
Arcade



Super 10, El (Erbe Software S.A.,)
Compilation



Superball (Axis Software,1983)
Arcade

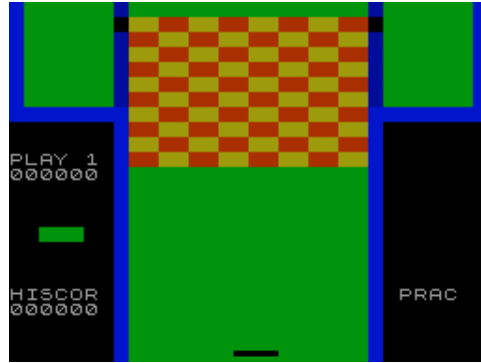

Superbowl (Ocean Software Ltd,1986)
Sport

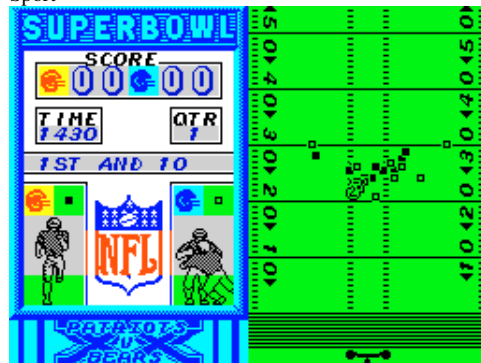

Super Cars (Gremlin Graphics Software Ltd,1990)
Arcade

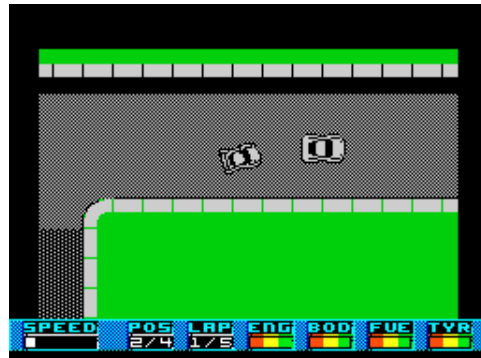

Supadrive (Transform Ltd.)
Utility

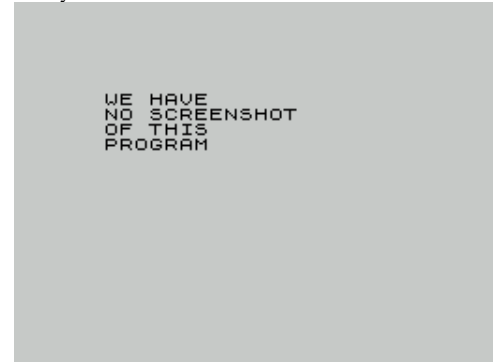

Super Advanced Lawnmower Simulator Adventure 2: The Sequel (Creative.Radical.Alternative.Production Games,1993) Text Adventure



Superbasic (MicroHobby,1986)
Utility

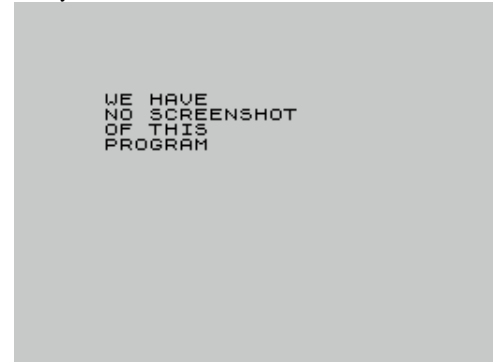

Super Brat (Atlantis Software Ltd,1985)
Sport

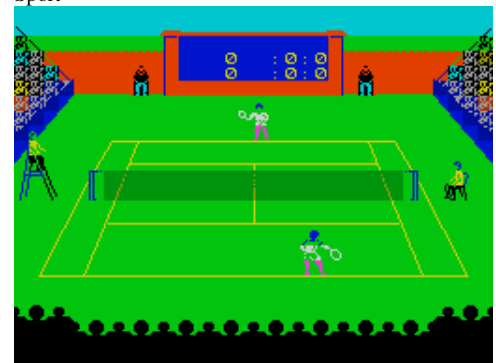

Super Centipede (C-Tech,1983)
Arcade



Super Champs (Torchraven Ltd,1985)
Arcade



Super Chopper (Software Super Savers Ltd,1984)
Arcade



Supercode 2 (CP Software,1984)
Utility: Programming

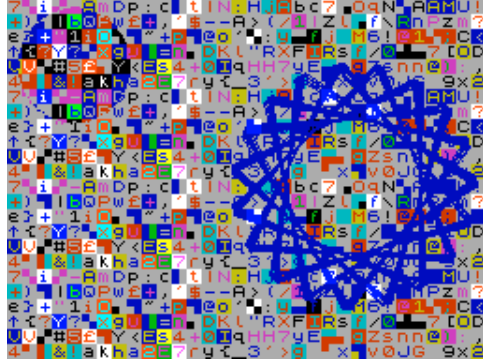

SuperCom (Atlantis Software Ltd,1986)
Simulation



Supercopier 2 (Kobrahssoft,)
Utility: Copier



Super Chess 2 (CP Software,1983)
Board/Card Game

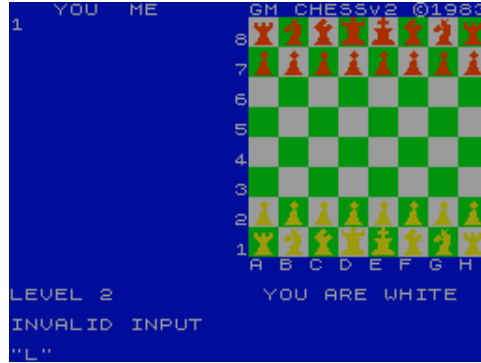

Super Cobra (Robert Spahl,1983)
Arcade



Supercode 3 (CP Software,1984)
Utility: Programming



Super Copiador (Polythene Soft,1984)
Utility: Copier



Supercopier SC7 (Kobrahssoft,1991)
Utility: Copier

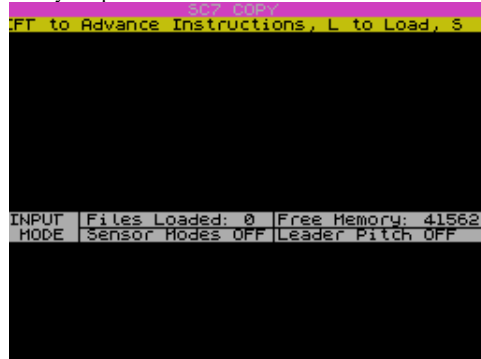

Super Chess 3 (CP Software,1984)
Board/Card Game

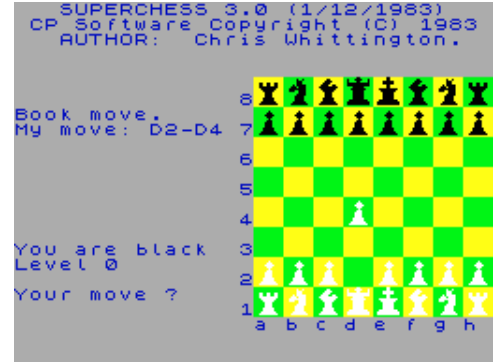

Supercode (CP Software,1983)
Utility: Programming



SuperColour (Your Sinclair,1986)
Utility

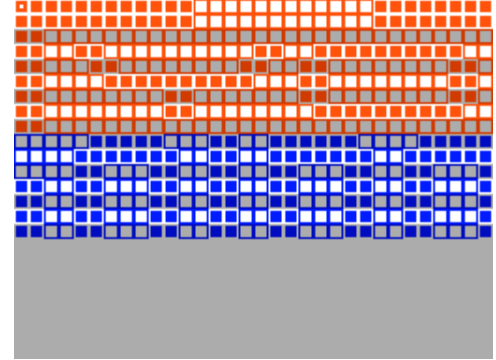

Super Copiador 68K (Alfonso Aguirre,1984)
Utility: Copier

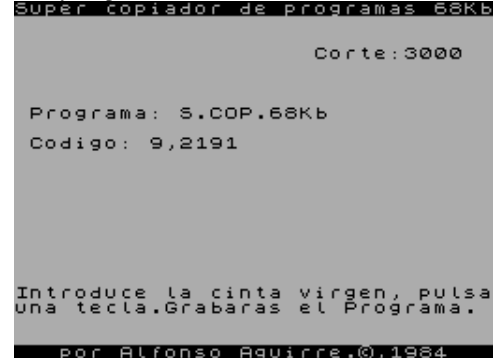

Supercopy (Simcic Milen,1985)
Utility: Copier

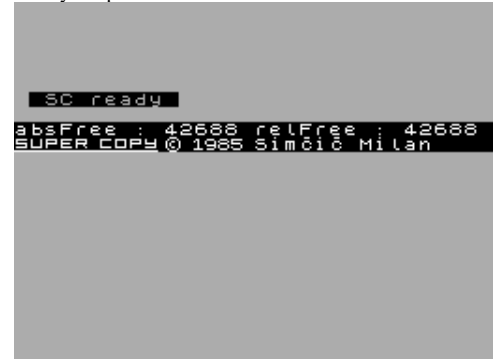

Super Copy (YU-Soft,1985)
Utility: Copier

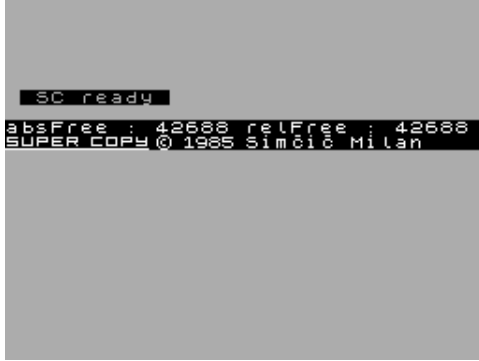

Superdeflex (Llamasoft,1982)
Arcade

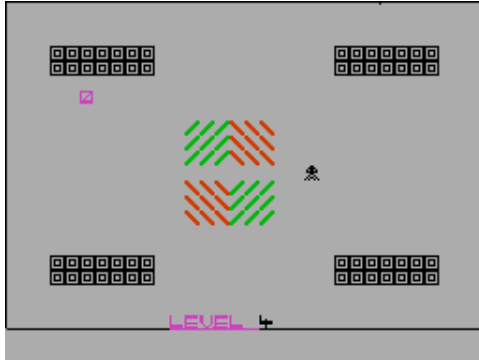

Super Discus (Sybilasoft,1988)
Text Adventure



Super Draw (.)
Utility: Drawing

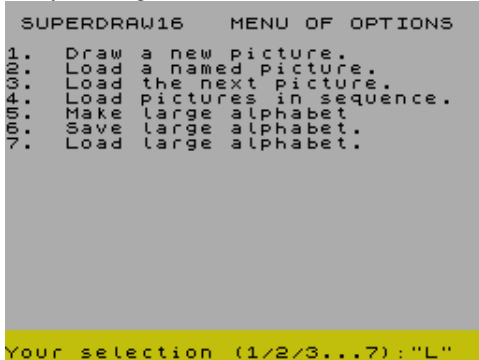

Super Fighter (Ocean Software Ltd,1993)
Compilation



Super Cup Football (Hewson Consultants Ltd,1990)
Arcade

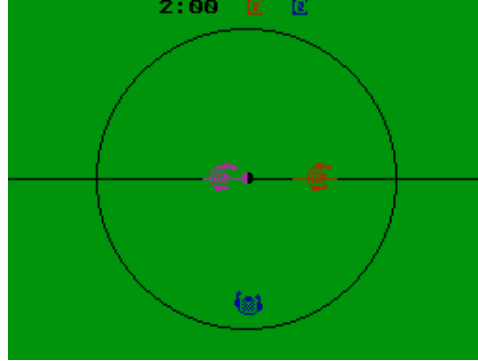

Super Digger (Abacus Programs,1984)
Arcade

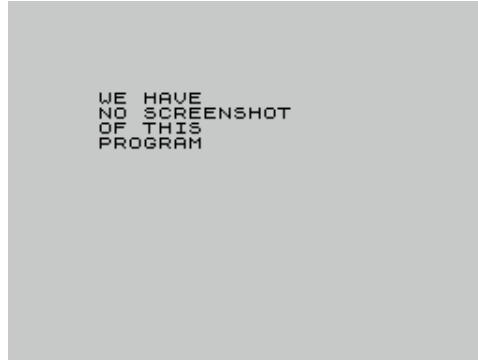

Super Dragon Slayer (Code Masters Ltd,1989)
Arcade Adventure

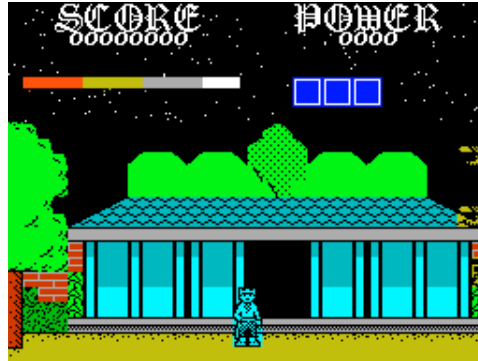

Superdraw (Video Software Ltd,1982)
Utility: Drawing

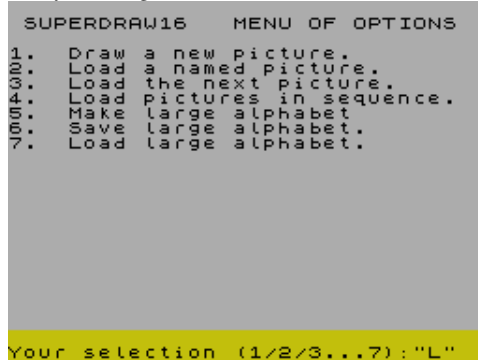

Superfile (Contrast Software.)
Utility: Music Creation



Super Cycle (US Gold Ltd,1987)
Sport



Super Digger + Chase (Abacus Programs,1984)
Compilation



Super Draughts (S. Roe,1983)
Board/Card Game

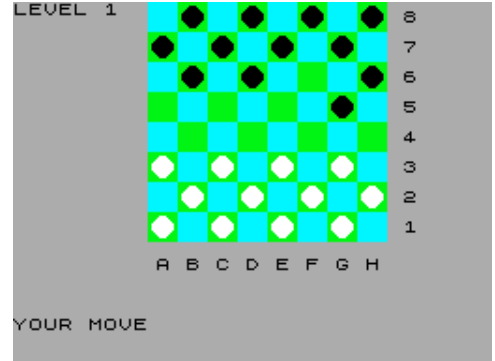

Super Dustbin (Clive Smith,1985)
Utility: Copier



Super File (Data-Skip Software,1985)
Utility

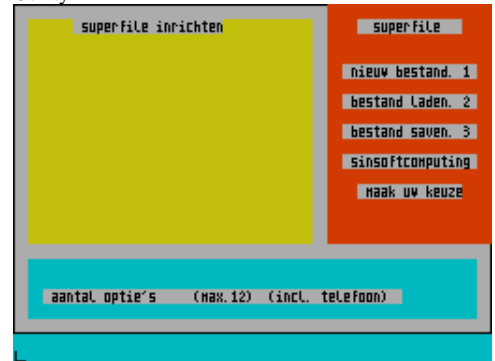

Superfile (Transform Ltd,1983)
Utility: Database

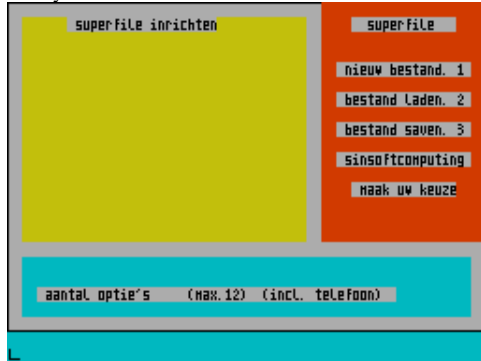

Superfile 2 and Listfile 3 (ZX-Guaranteed,1986)
Compilation



Super G-Man (Code Masters Ltd,1987)
Arcade

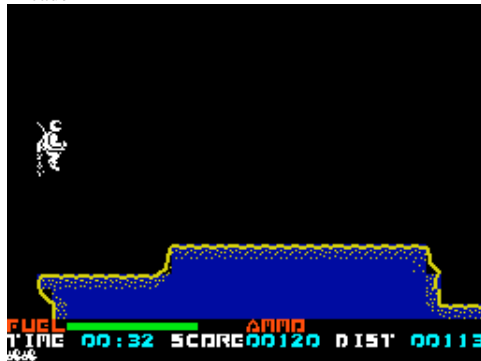

Super Gran - The Adventure (Adventure International,1985)
Text Adventure



Super Hero (Code Masters Ltd,1988)
Arcade Adventure



Superfile (Tynesoft,1985)
Utility: Database

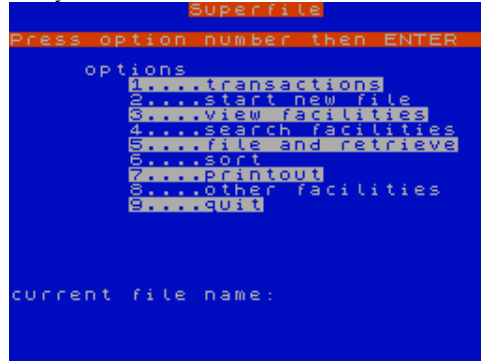

Super Fruit Machine (Sinclair User,1992)
Arcade



Super Golf (Q Bit,1984)
Arcade



Super Handicap (Humphrey Software,1986)
Simulation



Super Heroes (Domark Ltd,1992)
Compilation



Superfile 2 (ZX-Guaranteed,1986)
Utility



Super Ghost Attack (Kettl,1984)
Arcade



Super Gran (Tynesoft,1985)
Arcade



Super Hang-On (Electric Dreams Software,1986)
Arcade



Superhirm (Bernd Schissler,1984)
Board/Card Game



Superkey (.)
Utility

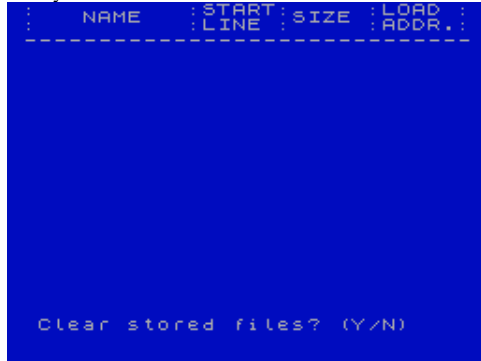

Superland (SuperSoft [2],1998)
Arcade Adventure



Super League Manager (Audiogenic Software Ltd,1991)
Simulation



Superman (US Gold Ltd.)
Arcade Adventure



Superman.olo (MicroHobby,1989)
Arcade



Superkid (Atlantis Software Ltd,1989)
Arcade



Super League (Cross Software,1983)
Simulation



Superleague Soccer (Audiogenic Software Ltd,1990)
Simulation



Superman: The Game (Firebird Software Ltd,1985)
Arcade

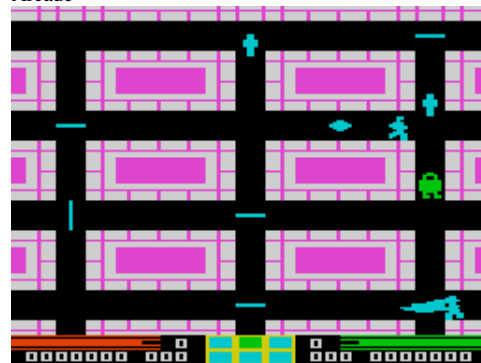

Super Mario (Master Home Computers Group,1999)
Arcade

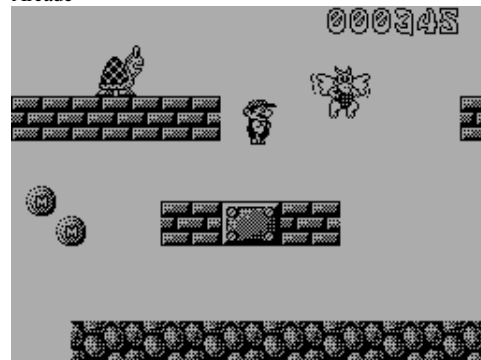

Superkid in Space (Atlantis Software Ltd,1990)
Arcade



Super League (Players Premier Software,1989)
Simulation



Super Load Editor (LH Soft,1987)
Utility



Superman - Man of Steel (Tynesoft,1989)
Arcade

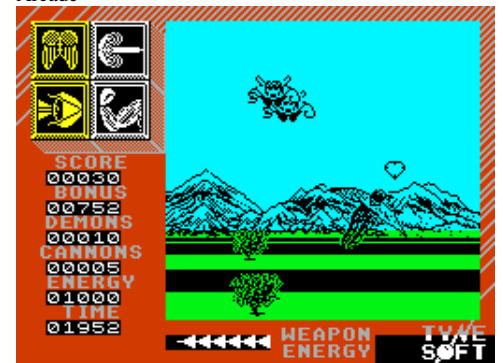

Super Monaco GP (US Gold Ltd,1991)
Arcade



Super Mutt (Silversoft Ltd,1984)
Arcade Adventure



Super Olympia (M. Soor,1984)
Arcade



Super Pacman (Shuric Program,1997)
Arcade



Superplan Pack 1 (Video Software Ltd,1982)
Compilation



Superpower (CCS,1985)
Strategy

	INDUSTRY		
Nation	Tax on profits	Capacity (\$m)	Usage
Ascol !	20%	600	100%
Berge *x	30%	800	100%
Cobal #	40%	1100	100%
Dina !	30%	1400	100%
Epina #	30%	900	100%
Fero *x	30%	1600	100%
Giben !	20%	1300	100%
Honsu #	40%	600	100%
Ialpr *x	20%	1100	100%

Press ENTER to continue. "L"

Super Nova (Players Software,1987)
Arcade Adventure

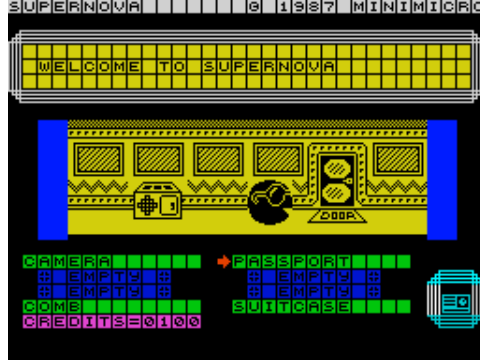

Super Packmen (Hipocrates Soft,)
Arcade



Super Pipeline II (Taskset Ltd,1985)
Arcade

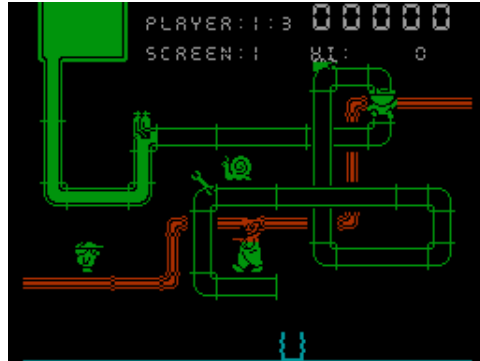

Superplan Pack 2 (Video Software Ltd,1982)
Compilation



Superpower (Howard Marketing,1984)
Strategy

SUPERPOWER PLAYER 2					
A	B	C	D	E	F
G	H	I	J	K	L
M	N	O	P	Q	R
S	T	U	V	W	X

AUL

ARMIES: 6 FOOD: 12
MISSILES: 0 MONEY: £45000
SHELTERS: 0 FACTORIES: 1

'X' TO EXIT

Super Nudge 2000 (Mastertronic Ltd,1989)
Arcade



Supercapman (E. Schabenberger,1984)
Arcade



Superplan Generator (Video Software Ltd,1982)
Utility

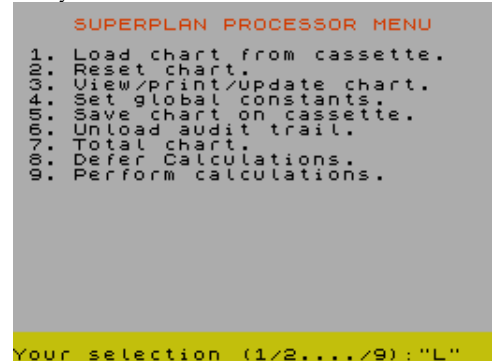

Superplay-1 (Video Software Ltd,1983)
Compilation



Super President (Balaganoff,1992)
Strategy

НАЛИЧНЫЕ СРЕДСТВА: 2000\$	
МОЖЕТЕ КУПИТЬ	цена
1. КВАРТИРУ	665\$
2. МАШИНУ	3450\$
3. ВИЛЛУ	11125\$
4. ЯХТУ	66250\$
5. САМОЛЕТ	184375\$

РАСХОДЫ НА СОДЕРЖАНИЕ: 45% СТОИМОСТИ В ГОД.

продажа [0] / покупка [1]

Super Print (Tim Johns,1983)
Utility

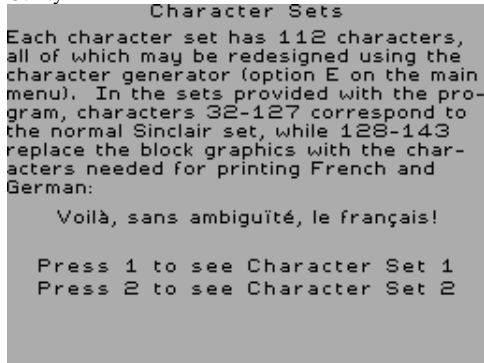

Super Quiz 1 (The Scripture Union,1984)
Board/Card Game

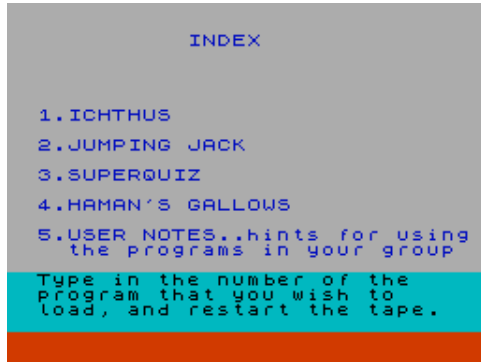

Super Robin Hood (Code Masters Ltd,1987)
Arcade Adventure



Super Save (.)
Utility: Copier



Super Sega (US Gold Ltd,1991)
Compilation

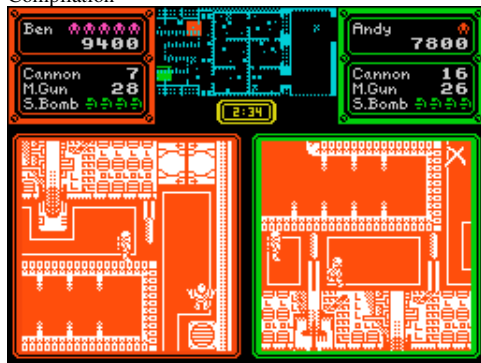

Super Quiniela (Gianluca Lazzarin,1984)
Simulation

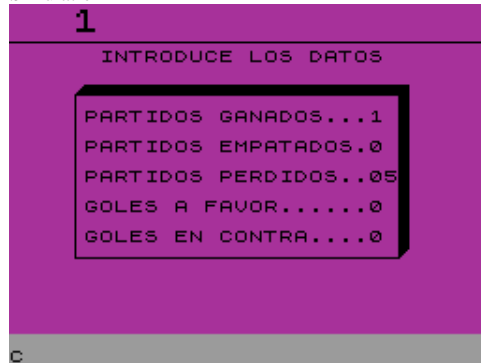

Super Quiz 2 (The Scripture Union,1984)
Board/Card Game

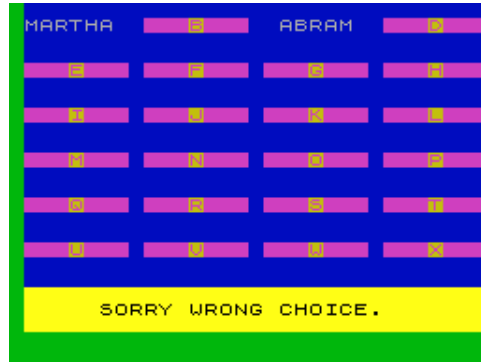

Super Sam (Budgie Budget Software,1985)
Arcade



Super Scramble Simulator (Gremlin Graphics Software Ltd,1989) Arcade



Super Series (Dinamic Software,)
Compilation



SuperQuiz (Top Spec,1986)
Simulation



Super Quiz 3 (The Scripture Union,1984)
Board/Card Game

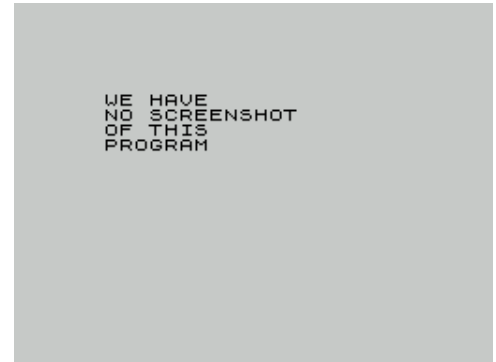

Super Sapiens (Proein Soft Line,1989)
Board/Card Game



Superscript (Keyword Software,1982)
Utility: Font/UDGs



Super Seymour Saves the Planet (Code Masters Ltd,1991)
Arcade



Super Shuffle (Sparklers,1986)
Arcade

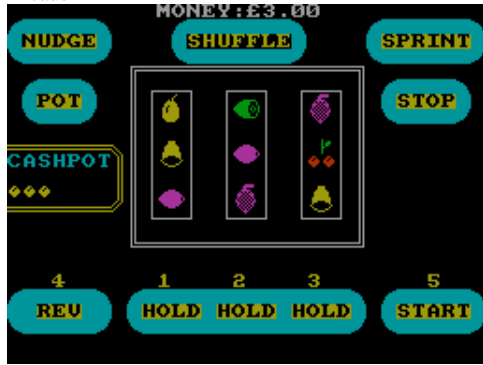

Super Slammer (Cathedral Software,1983)
Arcade

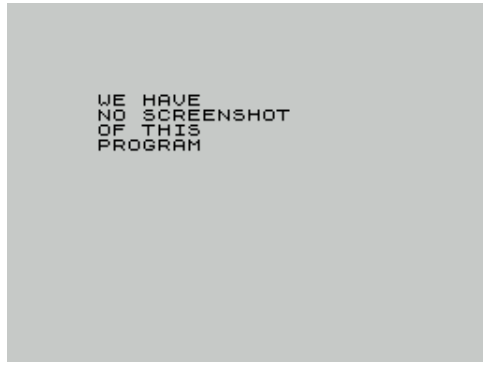

Super Soccer (Imagine Software Ltd,1986)



Super Software Pack (Spartan Software,1983)
Arcade



Super Sound 128K Part II (Hacker Jack Davis,1989)
Scene Demo



Super Sim Pack (US Gold Ltd,1991)
Compilation

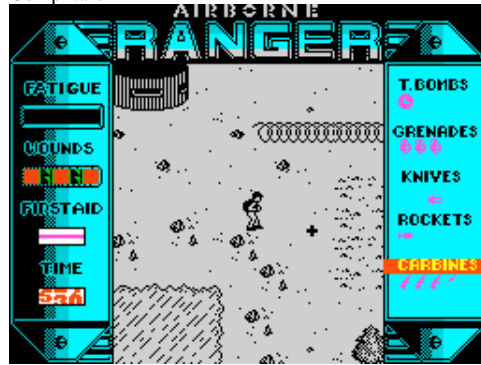

Super Slammer + Passage 3D (Cathedral Software,1983)
Compilation



Super Soccer (Wintersoft,1983)



Super Sonic (Klav,1993)
Scene Demo



Super Space Invaders (Domark Ltd,1991)
Arcade

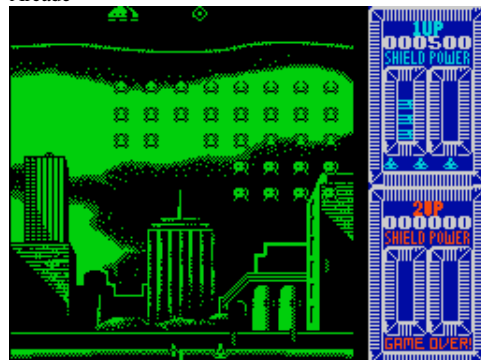

Super Sync (J. Soft.)
Compilation

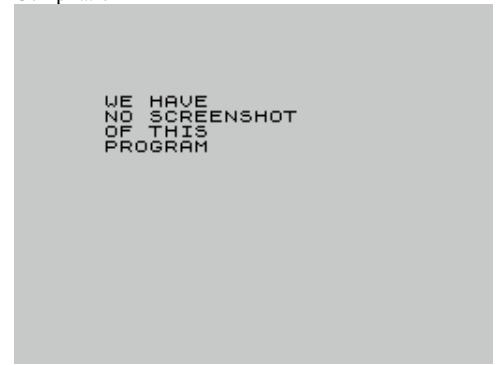

Super Snails (Games Machine Ltd,1984)
Arcade

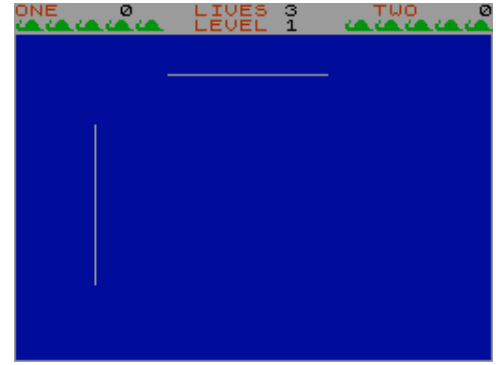

SuperSoft DOS (SuperSoft [2],1997)

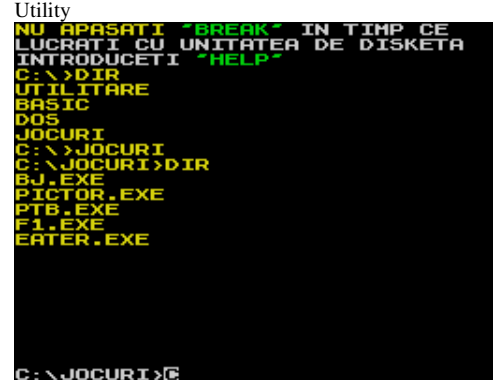

Super Sound 128K I (Hacker Jack Davis,1989)
Scene Demo



Super Spekulant (M.G.B. Software,1985)
Simulation



Super Tank (Code Masters Ltd,1989)
Arcade

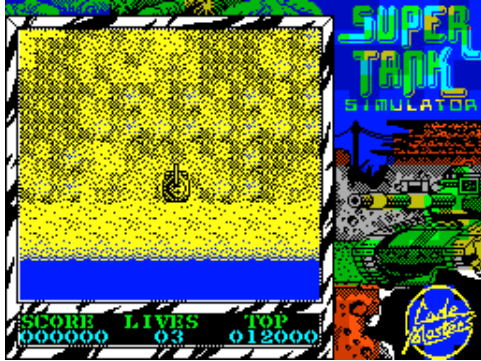

Super Ted: The Search for Spot (Alternative Software Ltd,1990) Arcade Adventure

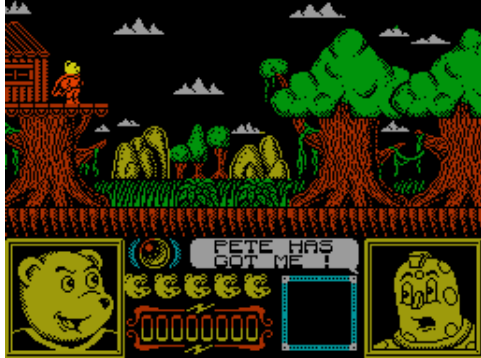

Superthunder, 3D (MicroHobby,1985)
Arcade

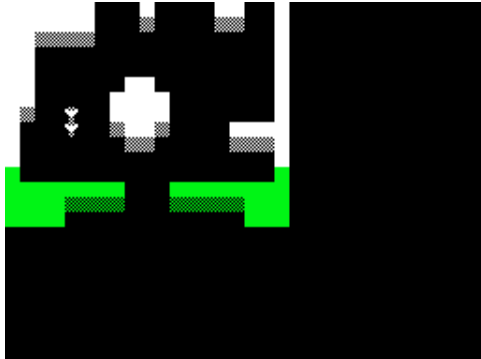

Super Trolley (Mastertronic Ltd,1988)
Arcade



Supervivencia (Aventuras AD S.A.,1988)
Text Adventure



Supertassword (Saursoft,1991)
Utility: Word Processor



Super Tetris (Yunior Soft/TK Ltd,1993)
Arcade

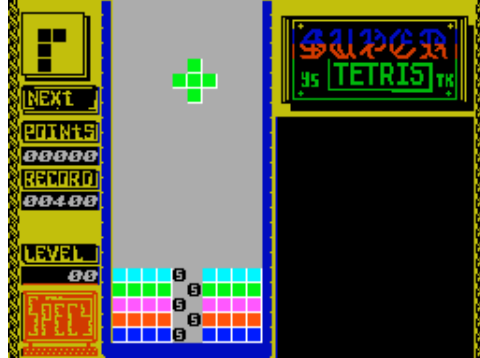

Super Toolkit (.)
Utility

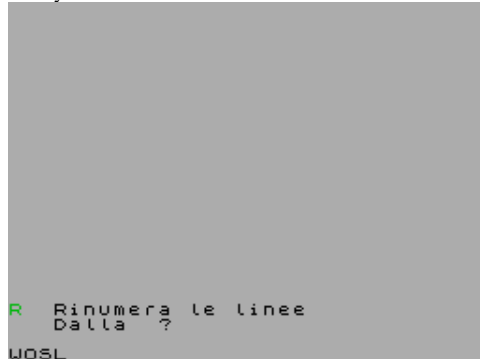

Supertrux (Elite Systems Ltd,1988)
Arcade



Super Wonder Boy (Activision Inc,1989)
Arcade Adventure



Super Ted (Longman Software,1984)
Arcade



Super Text Search (Purv,1988)
Utility

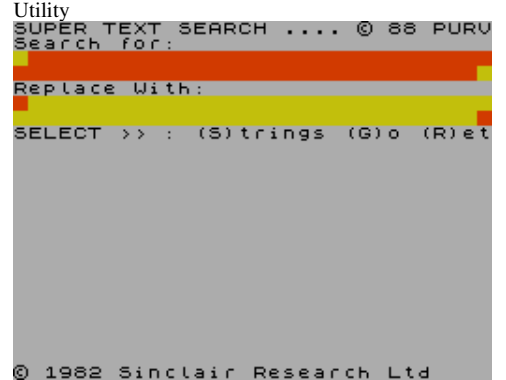

Super Toolkit (Nectarine,1983)
Utility



Superview (Video Software Ltd,1983)
Utility



Super Wonder Dog (Beyond Belief,1993)
Arcade Adventure



Super Writer (Collins Educational,1984)

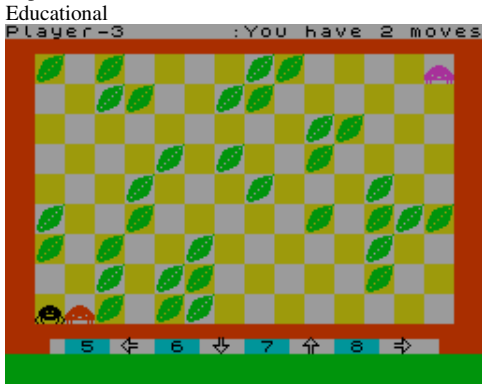

Supreme Challenge (Beau-Jolly Ltd,1988) Compilation



Sur le Bon Chemin (Individual Software Service/Hueber Software,1984) Educational



Survival (Central Solutions,1985) Text Adventure

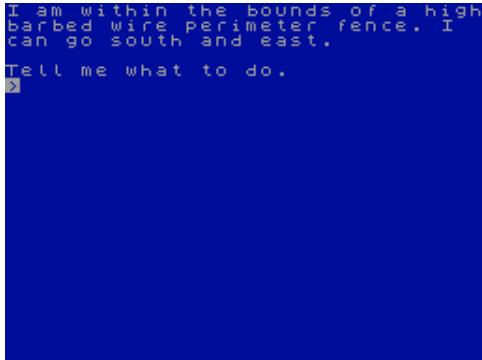

Survive (.)



Super Zeeslag (Sir Clive and Mr ZX,1991)

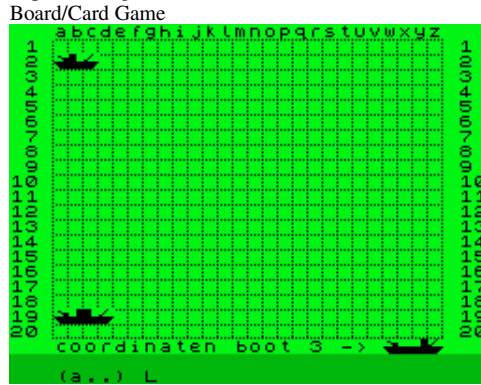

Surface Tension (Crash,1990) Arcade



Surround (Micro Press [1],1983) Arcade

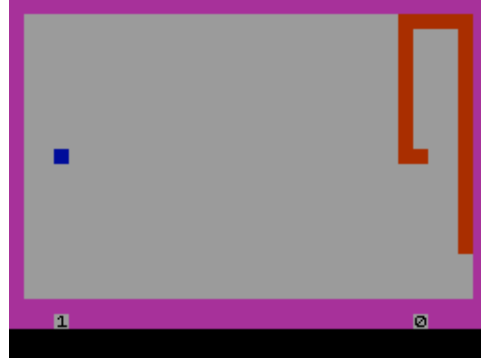

Survival (Macmillan Software Ltd/Sinclair Research Ltd,1984) Board/Card Game

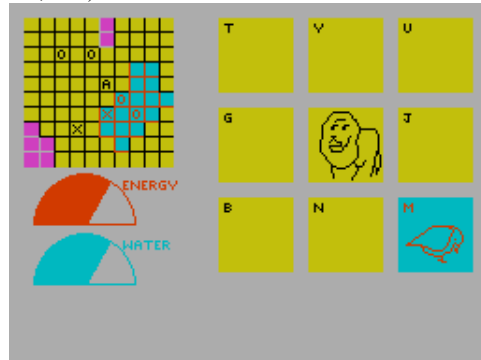

Survivor (Global Games [1],1989)



Supremacy (Dominic Morris,1991)

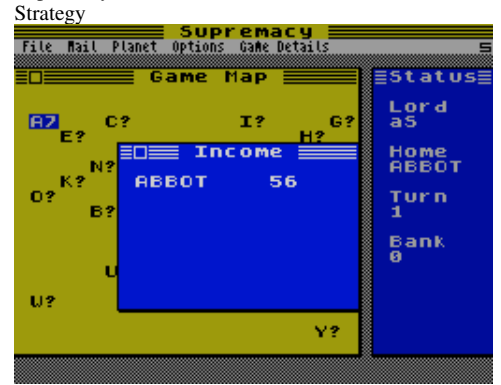

Surf Champ (New Concepts,1985) Simulation



Survey 2 (Lobos Software,1985) Utility



Survival (The Guild,)

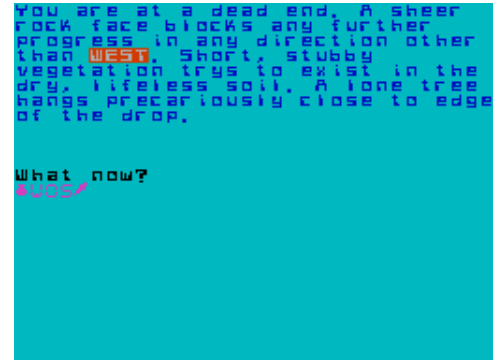

Survivor (Topo Soft,1987)

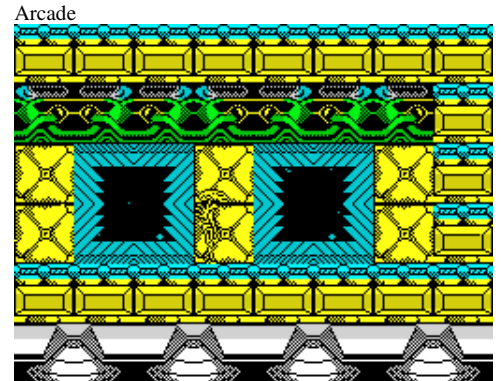

Survivors (Atlantis Software Ltd,1986)
Arcade



Swamp, The (Birdwing Software,1984)
Text Adventure

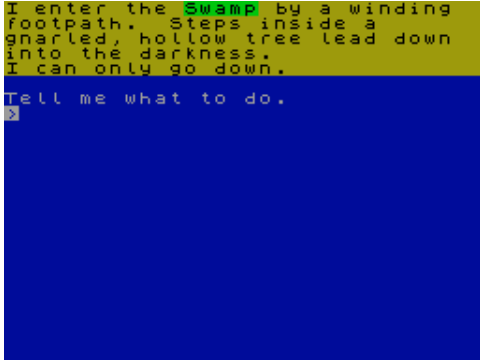

Sweevo's World (Gargoyle Games,1986)
Arcade



SWIV (Storm Software [2],1991)
Arcade



Sword and Shield (The Power House,1986)
Strategy

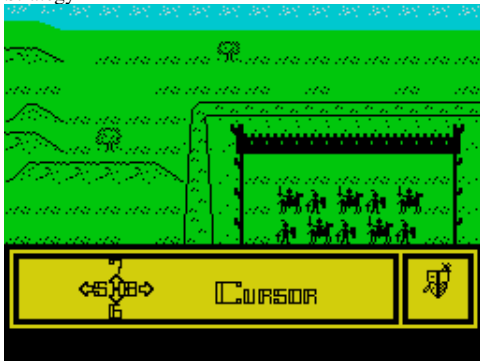

Svemirska (Suzy Soft,1985)
Simulation



Swat! (The Power House,1987)
Arcade Adventure



Swettibitz in Space (Automata UK Ltd,1985)
Arcade



Swoop (D. Sievers.)
Arcade



Swordfight at Midnight (Sunshine Books,1983)
Arcade



SW1 Tape To Wafa Drive Utility (KobraSoft,1988)
Utility

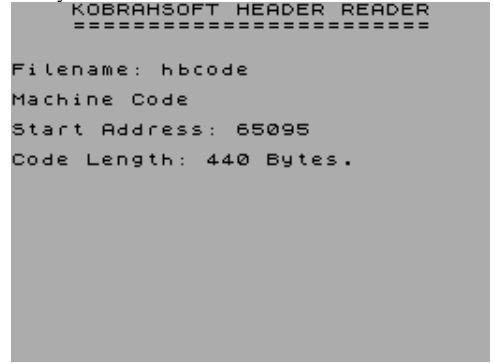

Sweevo's Whirled (Gargoyle Games,1986)
Arcade

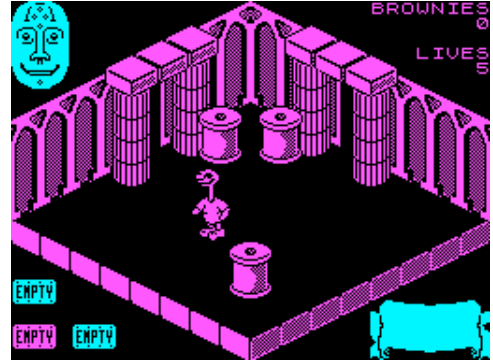

Switchblade (Gremlin Graphics Software Ltd,1991)
Arcade Adventure



Sword and Scythe (Nemesis Productions,1984)
Strategy



Sword of Kings (Interceptor Micros Software,1987)
Text Adventure



Sword of the Samurai (Adventuresoft UK Ltd,1986)
Text Adventure

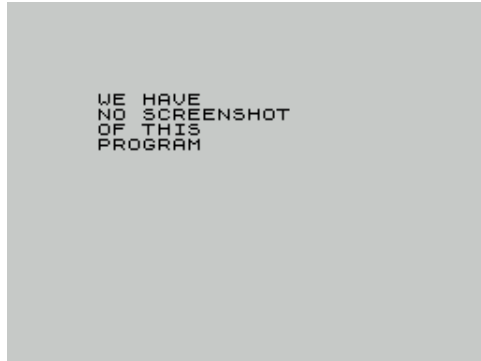

Sword Slayer (Players Software,1988)
Arcade

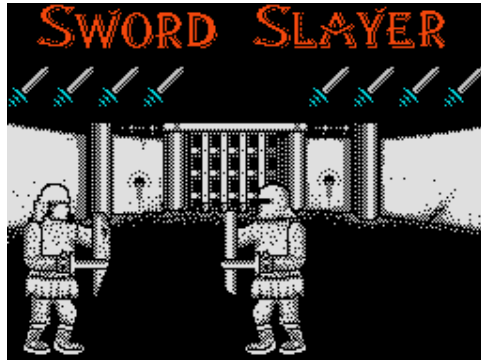

Synsounds (.)
Utility: Sound Manipulation

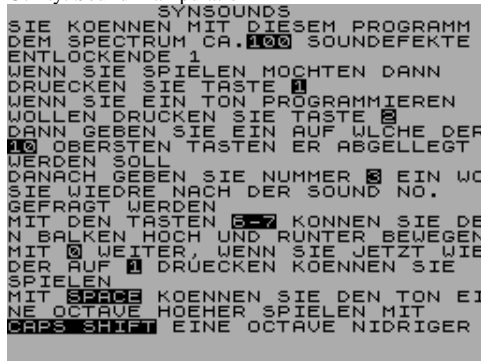

Synthetizer (Maly,1990)
Scene Demo

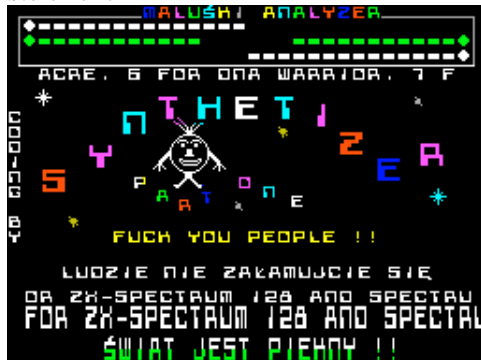

Sys 64 (Artic Computing Ltd,1983)
Utility

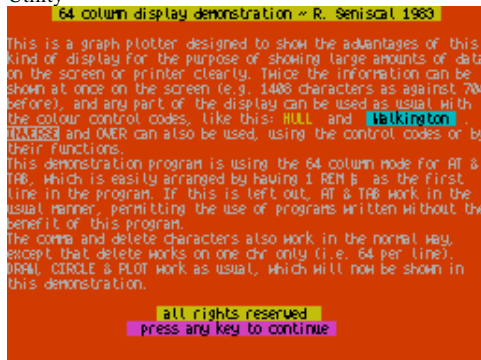

Sword of the Samurai (Zeppelin Games Ltd,1992)
Arcade



Swordsman of Kraxis 7, The (.)
Arcade Adventure



Syntax (Blue Ribbon Software,1989)
Arcade



Synti (Radio Student,1984)
Utility: Music Creation

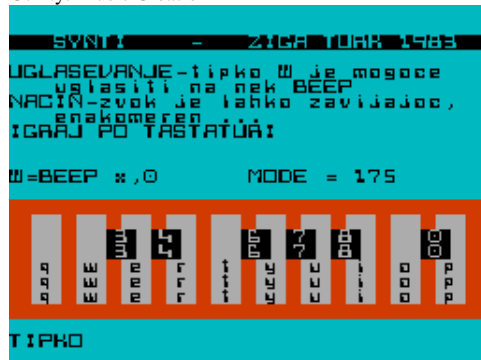

System 15000 (Craig Communications Ltd,1984)
Simulation



Swords and Sorcery (PSS,1985)
Arcade Adventure



Swords of Bane (CCS,1986)
Strategy



Synthensyser (.)
Utility: Music Creation

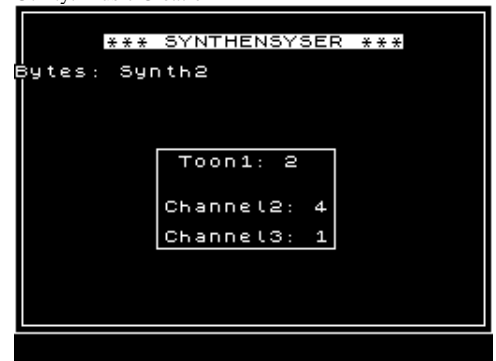

Syrinx 2 (Black Knight Software,1986)
Arcade



System 15000 - 2nd Edition (Craig Communications Ltd,1984)
Simulation



System 3 Pack (US Gold Ltd,1991)
Compilation



Szafran Demo (.)
Scene Demo



Sz-Pa-Tasm (Krakow,1987)
Utility



Table Invaders (Stell Software,1985)
Educational



Tablespeed (AVP Computing,1986)
Educational

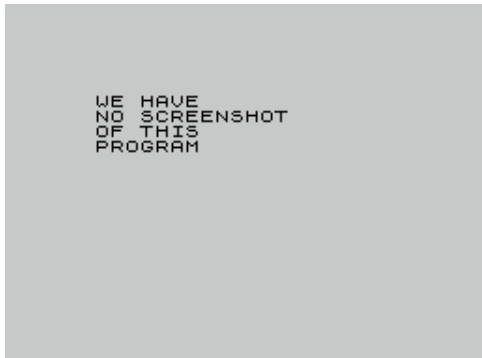

System 8: The Pool Predictor (Blue Ribbon
Software,1988)



Szorejto (Laszlo Nyitrai,2004)
Board/Card Game



Tabla Periodica (MicroHobby,1985)
Utility



Tables (16/48 Tape Magazine,1983)
Educational



Tablesums (Griffin Software,1982)
Educational



System-File (Dirk Buchwald,1984)
Utility

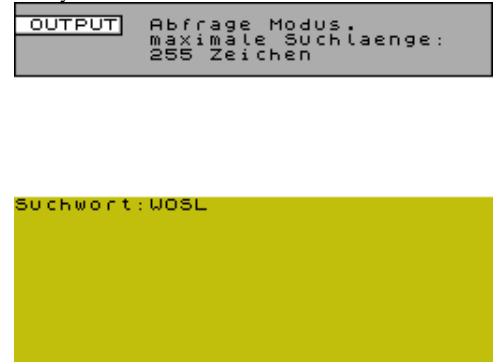

Szorejto Jatek (Laszlo Nyitrai,2005)
Board/Card Game



Table Football (Budgie Budget Software,1987)
Arcade



Tables: 1985/86 Football Season (J. Moore,1985)
Sport



Tables Wizard (Hill MacGibbon,1984)
Educational

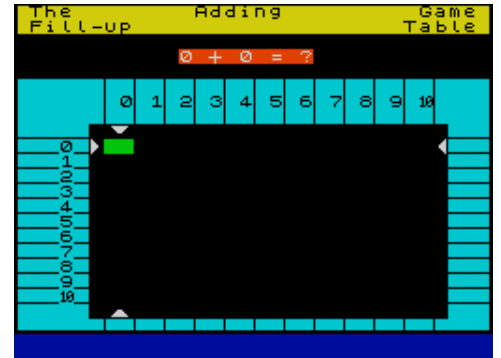

Tablut (MicroHobby,1985)
Board/Card Game

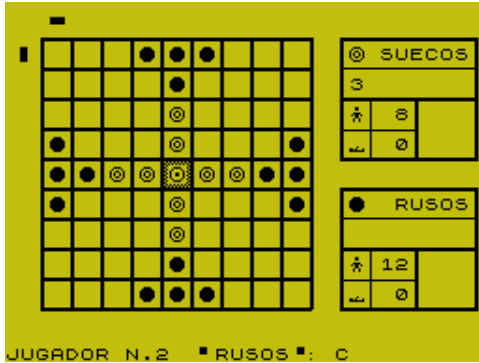

Tact Meter (Vyacheslav V. Strunov,2006)
Utility



Taipam (Joaquin Bayon.)
Strategy



Tai Pan (Mikro-Gen Ltd,1984)
Strategy

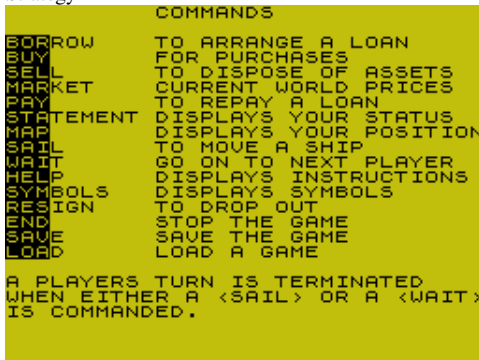

Take (Jorge Perez Barreiro,1986)
Arcade



Tachyon Command (Century Software [1],1985)
Arcade



Taffy Turner (Silversoft Ltd,1985)
Arcade



Taipam (MicroHobby,1986)
Arcade



Tai-Pan (Ocean Software Ltd,1987)
Arcade



Take 2: Spectrum Safari + Winged Warlords (Blue Ribbon Software.)
Compilation

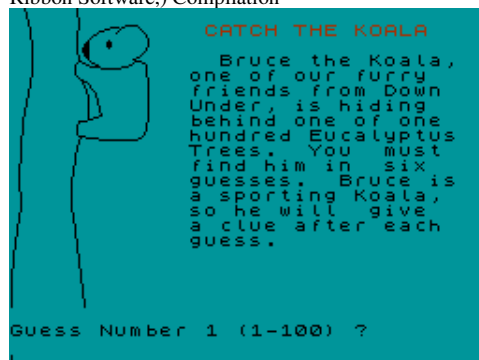

Tactics (16/48 Tape Magazine,1984)
Strategy



Tai Chi Tortoise (Zeppelin Games Ltd,1991)
Arcade



Taipan (Jaysoft,1983)
Arcade



Taito Coin-op Hits (Imagine Software Ltd,1989)
Compilation

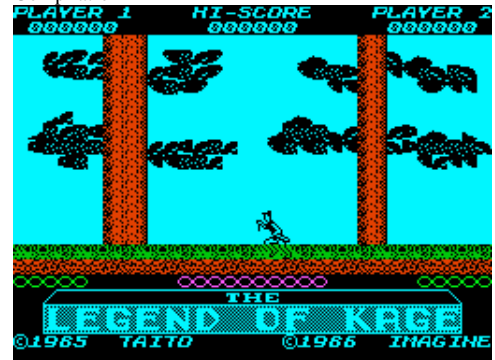

Take 2: Timebomb + Magic Meanies (Blue Ribbon Software.)
Compilation

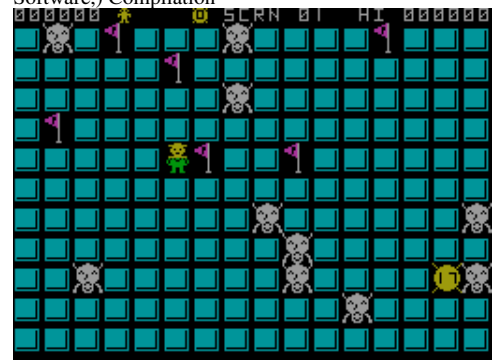

Take 3 Sports (Blue Ribbon Software,1988)
Compilation



Take Five (Pirate Software Ltd.)
Compilation

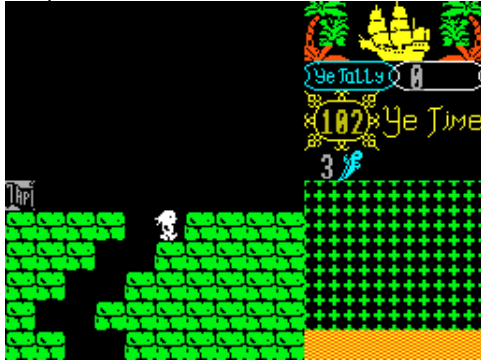

Talfrank (.)
Utility



Talisman (Pegasus Software.)
Text Adventure

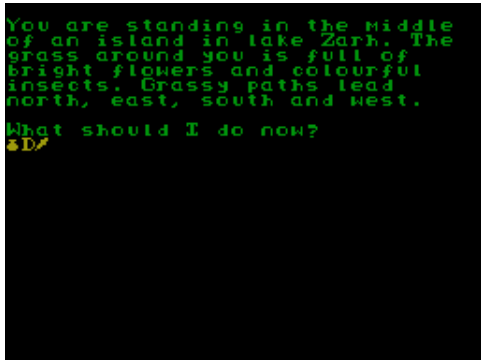

Talking Watch (.)
Utility



Take 4 (unpublished,1982)
Board/Card Game

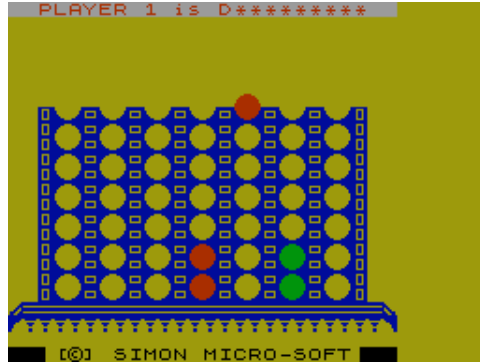

Tales of Mathematica, The (Zenobi Software,1990)
Text Adventure

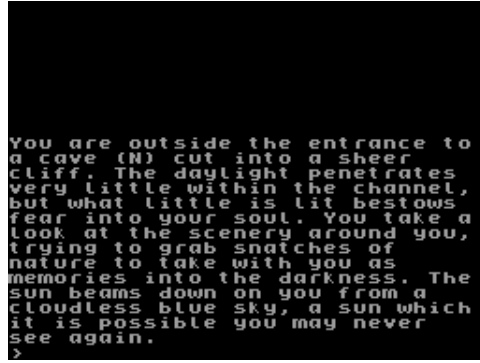

Talisman (Crash,1991)
Board/Card Game

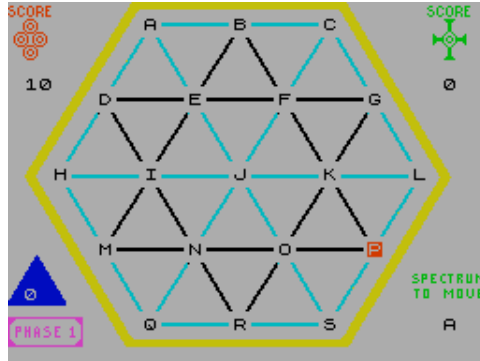

Talisman of Lost Souls (The Guild,1991)
Text Adventure

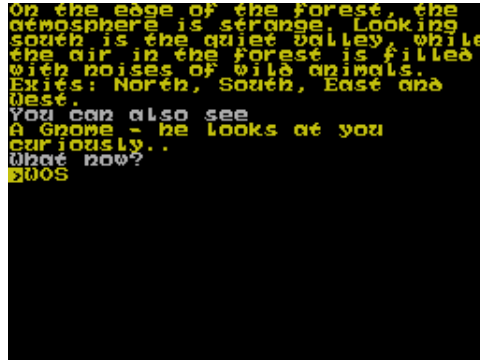

Talos (Silversoft Ltd,1985)
Arcade



Take 4 Games (Gremlin Graphics Software Ltd,1987)
Compilation



Tales of the Arabian Nights (Interceptor Micros Software,1985) Arcade



Talisman (Games Workshop,1985)
Arcade Adventure



Talking Hedz (Hellenic Software,1990)
Board/Card Game



Tam (THD/Alex Boy,1993)
Scene Demo



Tandem Lunar (MicroHobby,1985)
Arcade



Tangled Tale, A (Double Play Adventures,1985)
Text Adventure

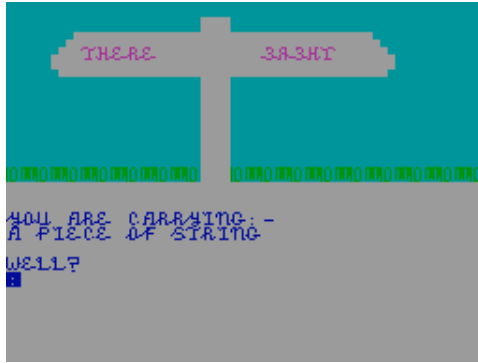

Tango (Proxima Software,1993)
Board/Card Game



Tango + Magic Dice (Proxima Software,1993)
Compilation



Tanium (Players Software,1988)
Arcade



Tank (Ocean Software Ltd,1987)
Arcade

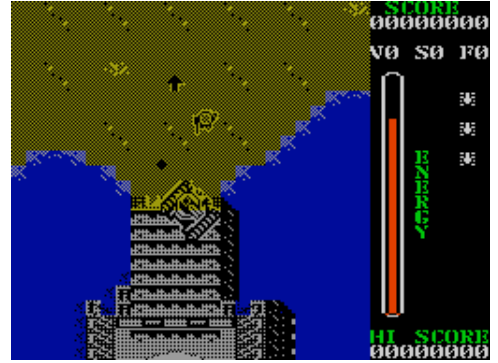

Tank Assault (E&J Software,1989)
Strategy



Tank Attack (CDS Microsystems,1988)
Board/Card Game



Tank Battle (Wintersoft,1983)
Arcade



Tank Command (Atlantis Software Ltd,1988)
Arcade



Tank Duel, 3D (Realtime Games Software Ltd,1984)
Arcade

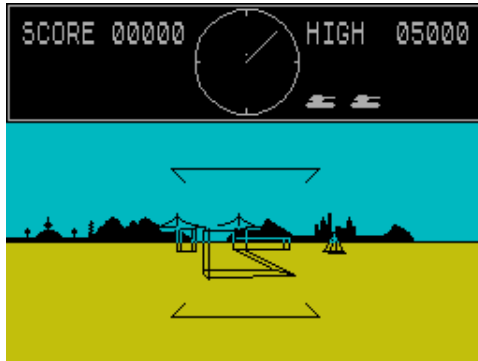

Tanker (C&VG,1983)
Arcade



Tankodrom (Copper Feet,1992)
Arcade

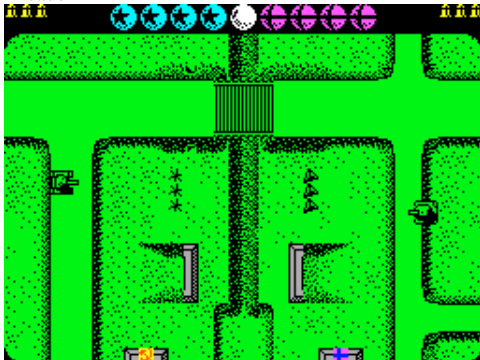

Tank Trax (Amoeba Software,1983)
Arcade

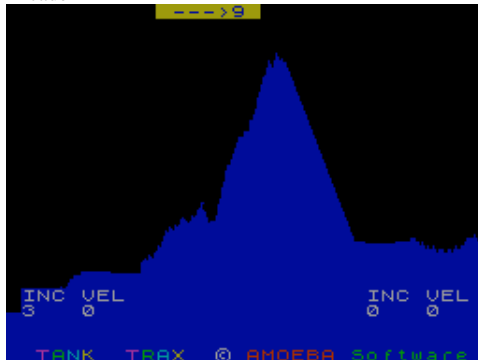

Tank Trax + Bullseye (Mastertronic Ltd,1983)
Compilation

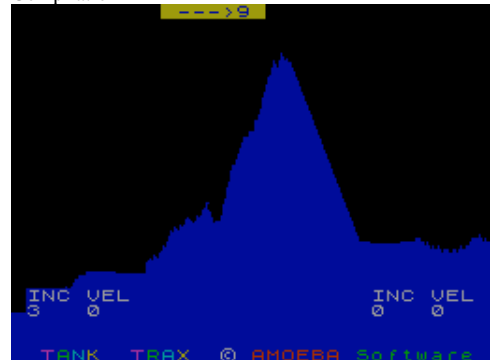

Tank War (Ametist,1995)
Arcade



Tantalus (Quicksilva Ltd,1986)
Arcade



Tape 3 (ZX-Guaranteed,1984)
Utility



Tapecopy (R. Dannhoefer,1983)
Utility: Copier

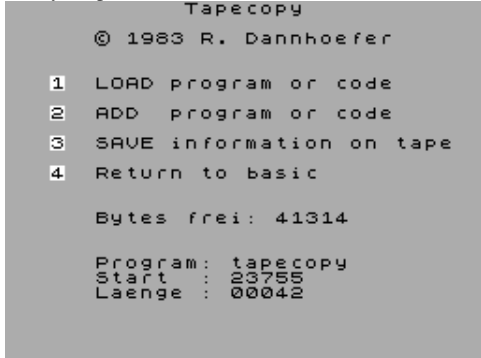

Tapefile (MiCROL,1982)

Utility: Database

```

A=ADD D=DELETE F=FIND C=CHANGE
L=LIST TAPE CONTENT T=LIST TAPES
S=SAVE FILE X=DELETE TAPE Q=QUIT

item number 1 of 1

cassette identifier: Wo3

tape counter reading: 0123

name: Wibble
    
```

Tank War (Interceptor,1995)
Arcade



Tanx, 3D (DK'Tronics Ltd,1982)
Strategy



Tape Back-Up Program (J.B. Jensen,)
Utility: Copier



Tape Diagnostics (.)
Utility

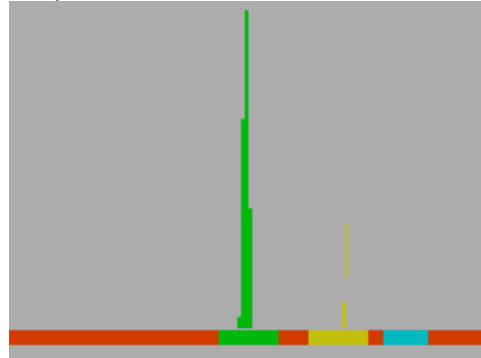

Tape-File Copy (Arnost Vecerka,1986)

Utility: Copier

```

44032

WAIT:456 SAMPLE:2400 cursN
    
```

Tanque (Microparadise Software,1984)
Arcade

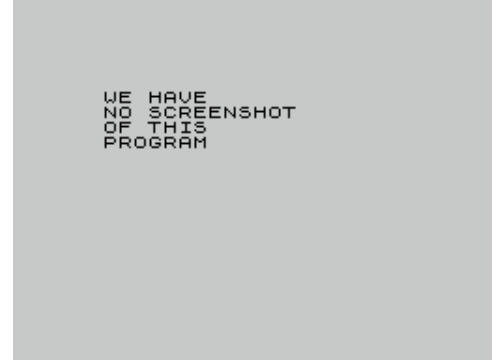

Tape 1 (The PResS Adventure,)
Compilation



Tapecopy (Michael Bayer,1984)
Utility: Copier



Tape Examiner (Your Computer,1983)
Utility



Tape-File Copy 128K (Kato,1989)

Utility: Copier

```

124672

LOAD SAVE VERIFY CLEAR

COPY 128
    
```

Tape Header (D.A.P.,1986)

Utility

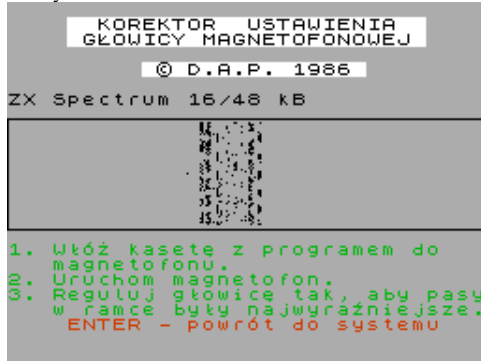

Tape Reg (.)

Utility

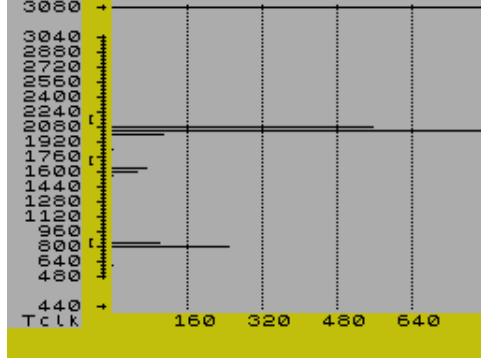

TapeSys (Your Computer,1984)

Utility

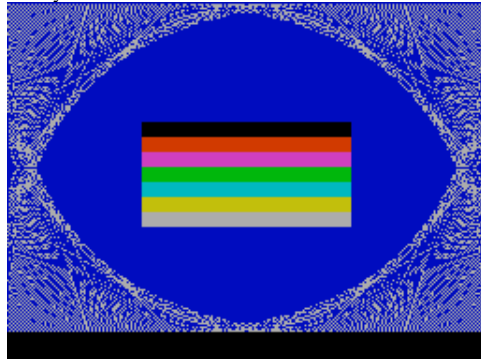

Tape to Tape Copier (Jury Nikolskiy,1986)

Utility: Copier

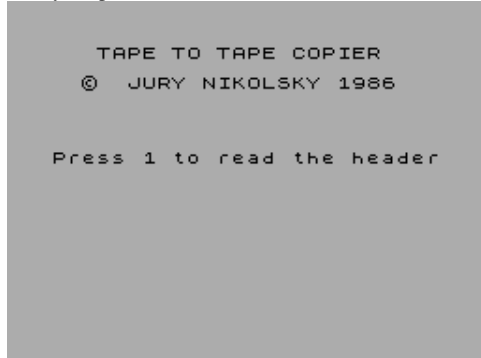

Tapper (US Gold Ltd,1985)

Arcade



Tape Header Reader (16/48 Tape Magazine,1984)

Utility



Tape Signal Analyser (Sinclair User,1993)

Utility

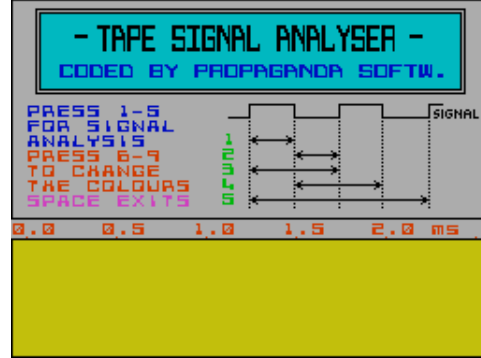

Tape to Disk Copier (Technology Research Ltd,)

Utility: Copier



Tapeworm (Your Computer,1986)

Arcade



Tarantula (Creative Sparks,1987)

Arcade

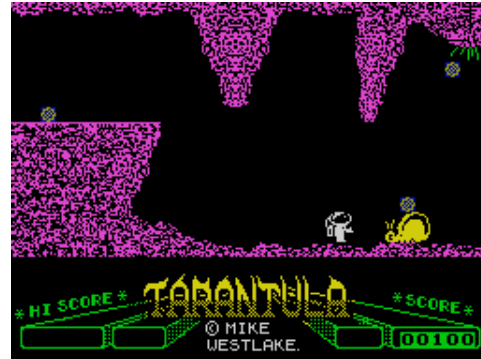

Tapelook (.)

Utility

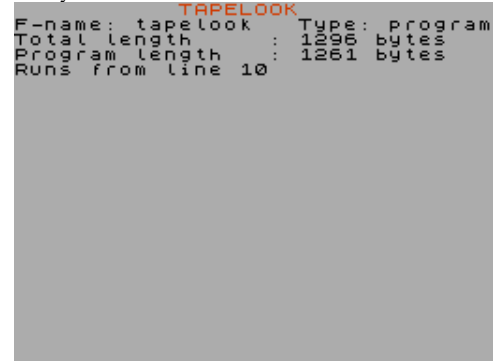

Tape-Snap (INDUG,1988)

Utility



Tape to Tape (Swiecie Software Company,)

Utility: Copier

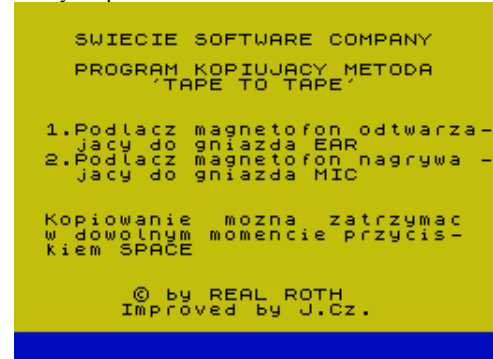

Tapon (MicroHobby,1986)

Arcade

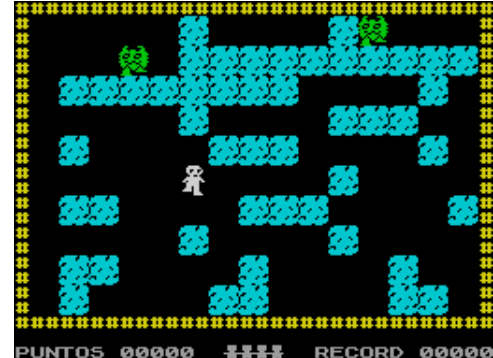

Tarantula (MicroHobby,1986)

Arcade

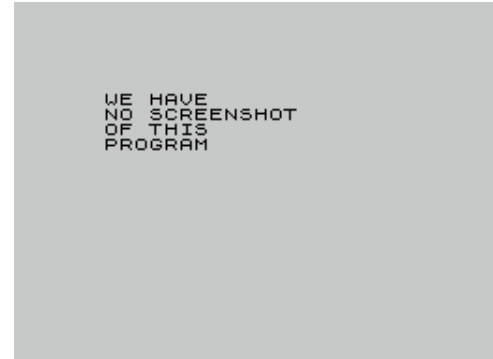

Tarantulas (.)
Arcade

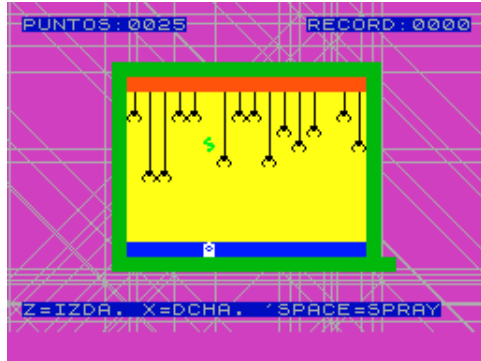

Target Plus (Dinamic Software,1988)
Arcade

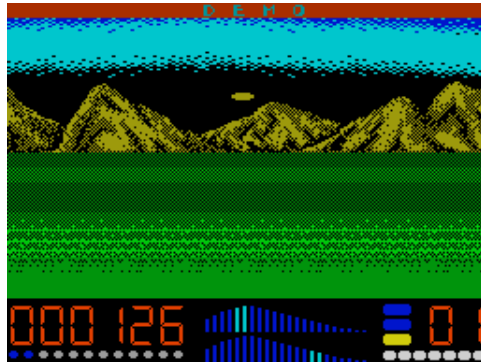

Tarot Appave, El (MicroHobby,1985)
Simulation



Tartan Eleven Plus Two, The (Tartan Software,)
Compilation



Tartan Five, The (Tartan Software,)
Compilation



Target (Martech Games Ltd,1989)
Arcade

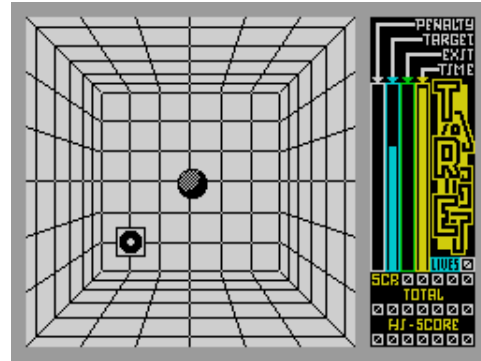

Target Practice (.)
Arcade



Tarot Cibernetico (Creativos Editoriales S.A.,1985)
Simulation



Tartan Eleven, The (Tartan Software,)
Compilation

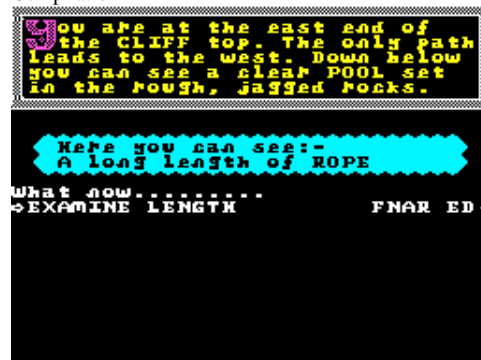

Tartan Seven Plus Two, The (Tartan Software,)
Compilation



Target Earth (The United Minds,1994)
Scene Demo

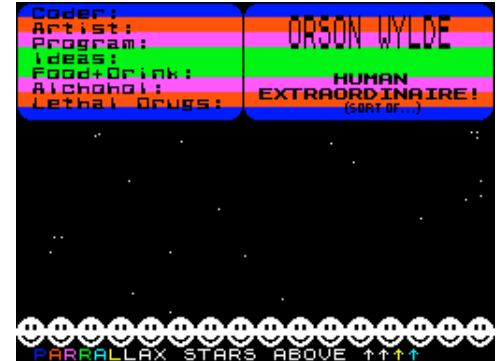

Target; Renegade (Imagine Software Ltd,1988)
Arcade

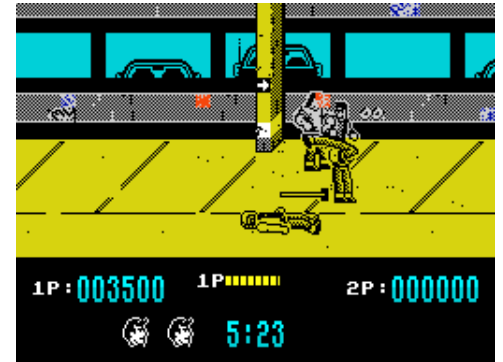

Tarot, The (Psychic Software,1986)
Board/Card Game



Tartan Five Plus Two, The (Tartan Software,)
Compilation



Tartan Seven, The (Tartan Software,)
Compilation



Tarzan (Martech Games Ltd,1986)
Arcade Adventure

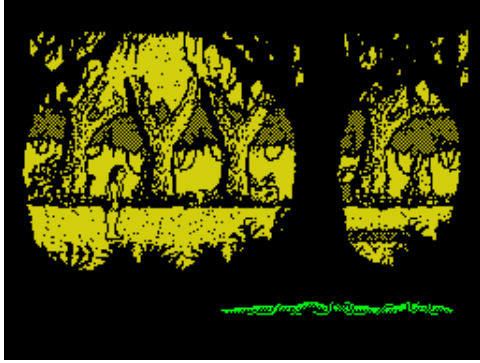

Tarzan (Wicosoft,1983)
Arcade

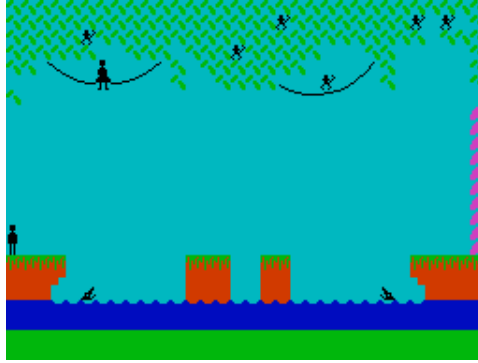

Tarzan Goes Ape (Code Masters Ltd,1991)
Arcade



TasCalc (Tasman Software,1988)
Utility: Spreadsheet

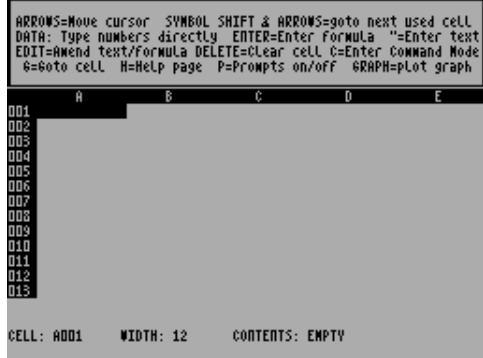

Tascon +2 (Format,1989)
Utility



TasCopy (Tasman Software,1984)
Utility

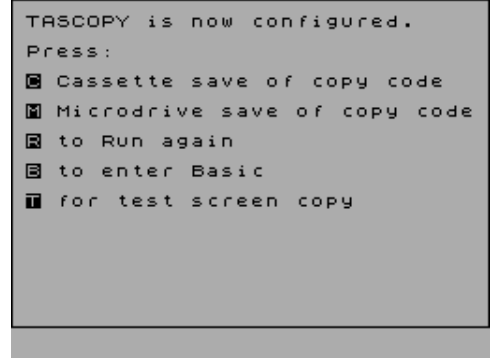

Tas-Diary (Tasman Software,1985)
Utility

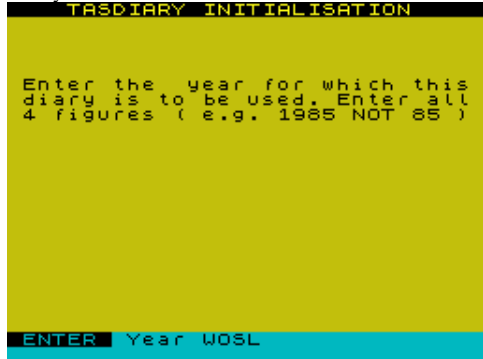

Tasimeq - Simultaneous Equations (Tasman Software,1983)
Educational

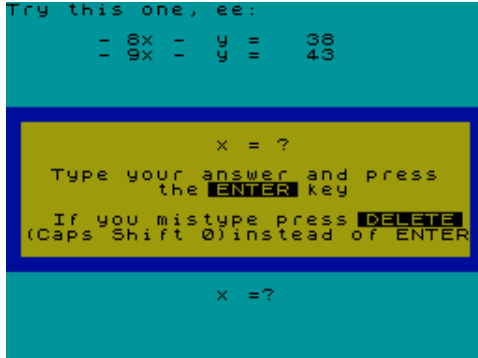

Task Force (Players Premier Software,1989)
Arcade



Tasks (Gilsoft International,1983)
Utility



Tasmath 1 (Tasman Software,1983)
Compilation

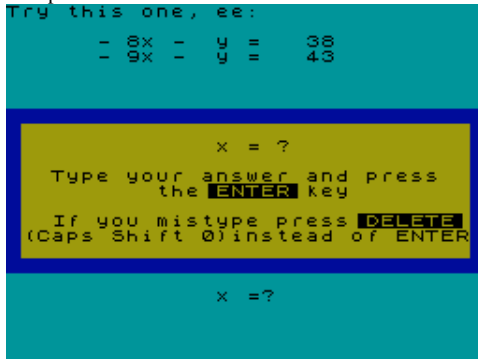

TasMerge (Tasman Software,1985)
Utility



TasPrint (Tasman Software,1983)
Utility

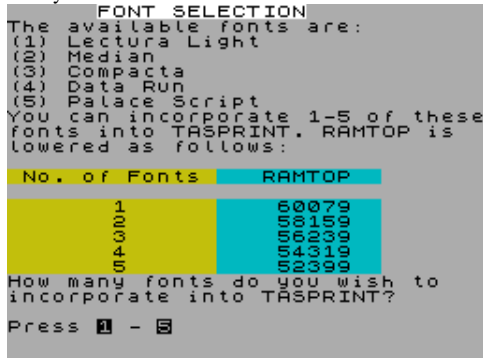

TasPrint +3 (Tasman Software,1987)
Utility: Word Processor

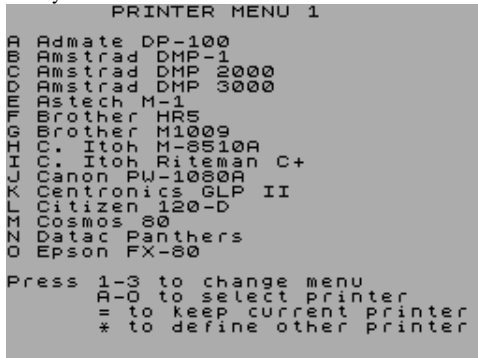

TasPro (Seven Stars Publishing,1985)
Utility: Word Processor

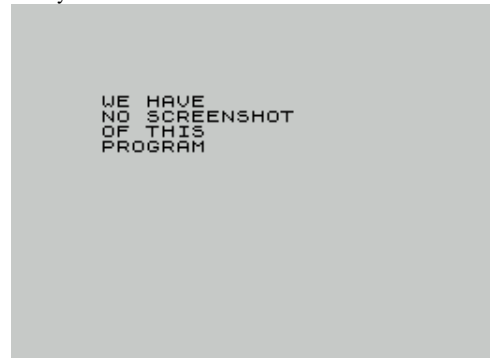

Tasquad - Quadratic Equations (Tasman Software,1983)

```
Try this one, wos:
x2 +12x + 36 = 0
x = ?
Type your answer and press
the ENTER key
If you mistype press DELETE
(Caps Shift 0) instead of ENTER
x =?
AND
x =?
```

TasSpell +3 (Tasman Software,1988)
Utility: Word Processor

```
WE HAVE
NO SCREENSHOT
OF THIS
PROGRAM
```

TasWord (Betterbytes Software,1989)
Utility: Word Processor

```
WE HAVE
NO SCREENSHOT
OF THIS
PROGRAM
```

Tasword +2A (Alchemist Research,1991)
Utility: Word Processor

```
CURSOR MOVEMENT
3t start of text $6 scroll up 3; start of paragraph
3i end of text $F scroll down 3c end of paragraph
3e start of line 36 fast scroll up 3d next page
3p end of line 3F fast scroll down 3' start of page
3Q word left 3E word right 3x start of screen
3=EXTEND $=SVNB SHIFT TRUE/INU UID=UP/DOWN HELP 3I=HELP OFF
WOS
Line 3 Col 4 R/L on W/W on Insert off Pg/Bk off EDIT=help
```

Tasword 2 (Tasman Software,1983)
Utility: Word Processor

```
Rgl. 1 Col 4 Bit/lines aan W/O aan Invoeg uit EDIT = Help
```

TasSign (Tasman Software,1988)
Utility: Word Processor

```
Remove the TAS-SIGN tape, insert
your configuring data tape,
and press PLAY.
```

Tas-Trig - Basic Trigonometry (Tasman Software,1983)
Educational

```
Hello again WOS
Side BC = ?
Type your answer and press
the ENTER key
If you mistype press DELETE
(Caps Shift 0) instead of ENTER
```

Tasword (Tasman Software,1982)
Utility: Word Processor

```
TASWORD
© Tasman Software 1982
Welcome!
You have just loaded the Tasword
demonstration tape. You are
looking at some text that has
been typed using Tasword.
Press the ENTER key on your
Spectrum and you will see the
flashing cursor that is at the
top of the screen move down a
line. Keep pressing ENTER until
you see a message that tells you
to stop.
Line 10 W/W on EDIT for Help
```

Tasword +3 (Tasman Software,1987)
Utility: Word Processor

```
WE HAVE
NO SCREENSHOT
OF THIS
PROGRAM
```

Tasword 2 Colour Modifier (Brian Gaff,1989)
Utility

```
Program: tasword
Bytes: tasword
TASWORD 2 SCREEN colour changer
Follow the prompts and your
Tasword could be the envy of
everyone!
Origins: thanks to Mike Sun and
an article in 'FORMAT' by
Ken Elston.
Border Colour? (0 - 7) WOSL
```

TasSign 128K (Tasman Software,1988)
Utility: Word Processor

```
WE HAVE
NO SCREENSHOT
OF THIS
PROGRAM
```

TasWide (Tasman Software,1984)
Utility: Word Processor

```
TASWIDE README FILE
Using TASWIDE in basic programs.
(1) Short basic programs .
If the basic program in to which
you wish to incorporate taswide
is under 12 K bytes in length ,
then merging the taswide basic
program in to your basic program
will not be a problem.
(1) Longer basic programs .
Longer basic programs will need
to use the program "PRELOAD"
provided . This will work if the
last line loads your program .
The space available for basic
programs is reduced from 42K
bytes to 37K bytes by TASWIDE .
0 OK, 70:1
```

Tasword +2 (Alchemist Research,1991)
Utility: Word Processor

```
CURSOR MOVEMENT
3t start of text $6 scroll up 3; start of paragraph
3i end of text $F scroll down 3c end of paragraph
3e start of line 36 fast scroll up 3d next page
3p end of line 3F fast scroll down 3' start of page
3Q word left 3E word right 3x start of screen
3=EXTEND $=SVNB SHIFT TRUE/INU UID=UP/DOWN HELP 3I=HELP OFF
WOS
Line 1 Col 4 R/L on W/W on Insert off Pg/Bk off EDIT=help
```

Tasword 128K (Tasman Software,1986)
Utility: Word Processor

```
CURSOR MOVEMENT
3t start of text THEN scroll up 3; start of paragraph
3i end of text TO scroll down 3c end of paragraph
3e start of line 36 fast scroll up 3d next page
3p end of line 3F fast scroll down 3' start of page
3Q word left 3E word right 3x start of screen
3=EXTEND TRUE UID=UP HELP INU UID =DOWN HELP 3I=HELP OFF
WOS
Line 1 Col 4 R/L on W/W on Insert off Pg/Bk off EDIT=help
```

Tasword 2 Demonstration (Tasman Software,1983)
Utility: Word Processor

```
WE HAVE
NO SCREENSHOT
OF THIS
PROGRAM
```

Tasword 3 (Tasman Software,1986)
Utility



Tatris (CIR,1990)
Arcade



Tau Ceti (CRL Group PLC,1985)
Arcade

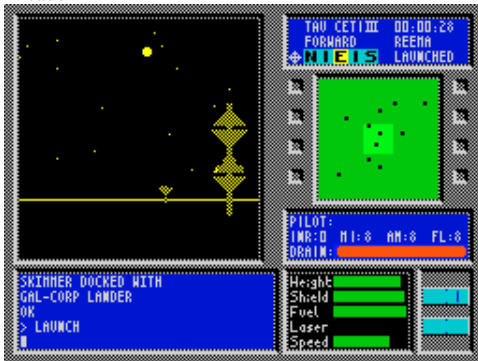

Taxi! (Digital Integration,1983)
Arcade

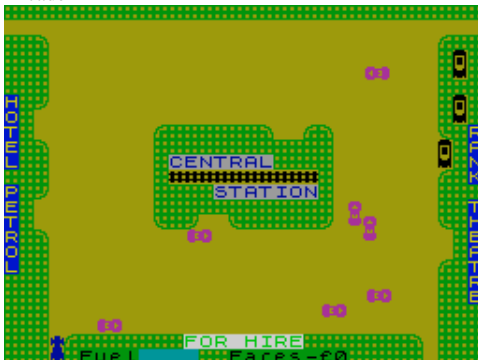

Taxman Cometh, The (Zenobi Software,1991)
Text Adventure



Tasword 4 (B.E. Software,1984)
Utility: Word Processor

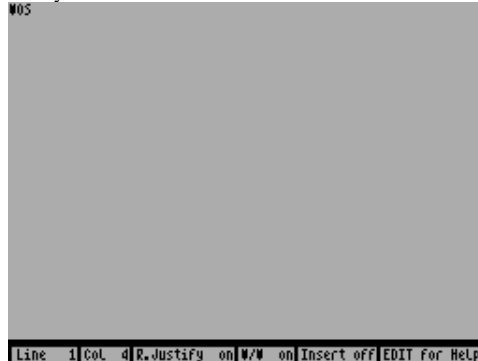

Tattoo (Dream World Adventures,1995)
Text Adventure



Tau Ceti - The Special Edition (CRL Group PLC,1987)
Arcade

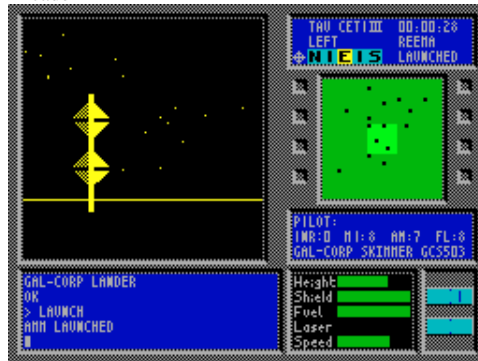

Taxi Driver (Develon Software,1985)
Arcade

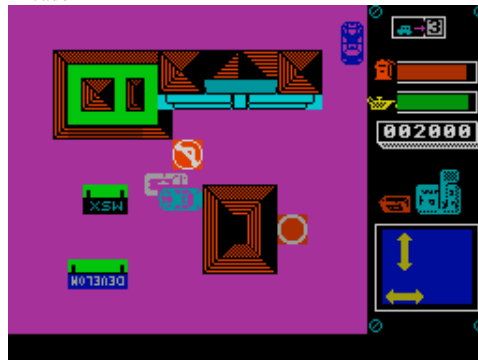

Tax Returns (Zenobi Software,1992)
Text Adventure



Tasword Reader (Rola Software,1985)
Utility: Word Processor

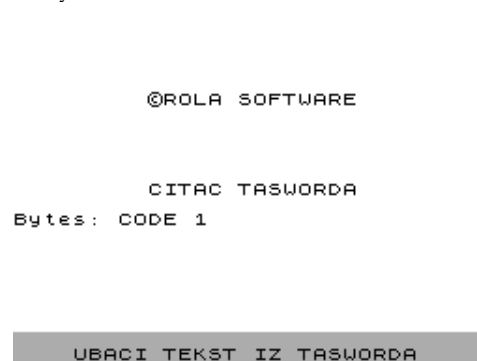

Tattoo (Ignacio Prini Garcia,1998)
Music

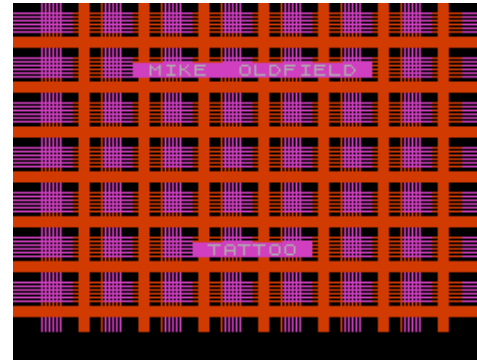

Tax Bills (Zenobi Software,)
Compilation



Tax Man (C-Tech,1983)
Arcade



T-Bird (Mastertronic Plus,1989)
Arcade

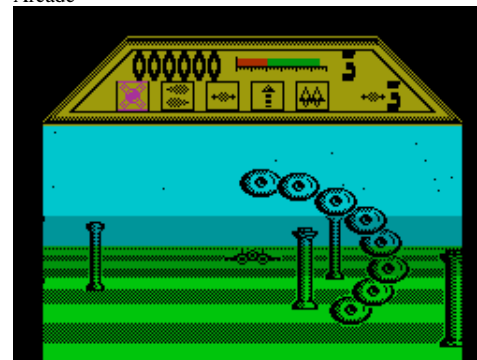

TDL (The Drak Lord,1988)
Scene Demo



Teach Words (Avalon,1998)
Educational



Teastrainer (Paul Jameson,1988)
Arcade

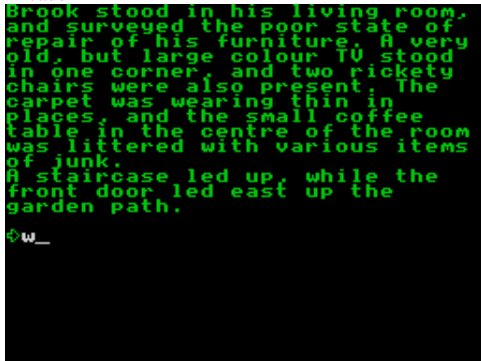

Technician Ted (Hewson Consultants Ltd,1984)
Arcade



Techno 2 (TechnoSoft,1993)
Scene Demo



Teacher Data (Brian Farris,1983)
Educational

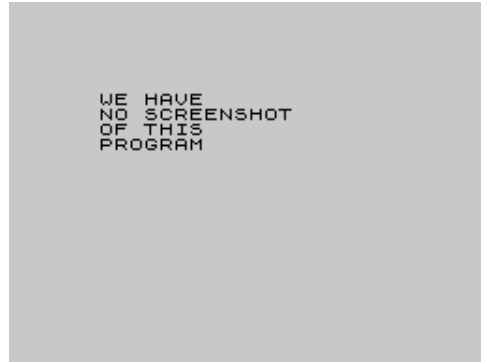

Team Results (Hobby Software,1985)
Simulation



Teatar (Suzy Soft,1986)
Text Adventure

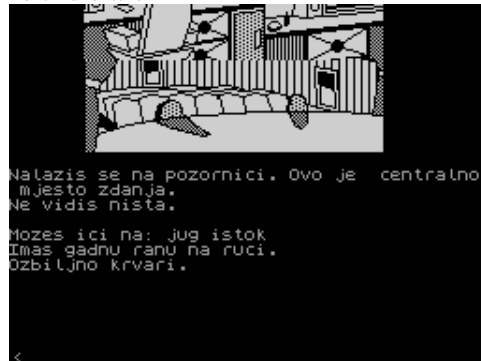

Technician Ted: The Megamix (Hewson Consultants Ltd,1986)
Arcade



Techno93 Demo (Oleg Moskalenko,1993)
Scene Demo



Teacher Trouble (Pegasus Software,1989)
Text Adventure



Tears of the Moon (Zenobi Software,1992)
Text Adventure



Tebbit, The (Applications Software Specialities,)
Text Adventure



Techno (Oscar & Spielberg,)
Scene Demo



Techno Chaos (CBM Software,1993)
Scene Demo



Techno-Cop (Gremlin Graphics Software Ltd,1988)
Arcade



Teenage Emergency (Zenobi Software,1995)
Text Adventure



Tees Tyne Pullman (Dee-Kay Systems.)
Simulation

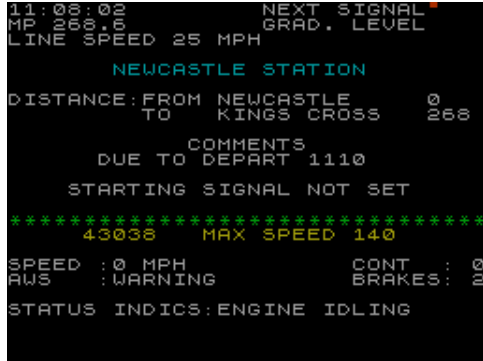

Teladon (Destiny Software,1988)
Arcade

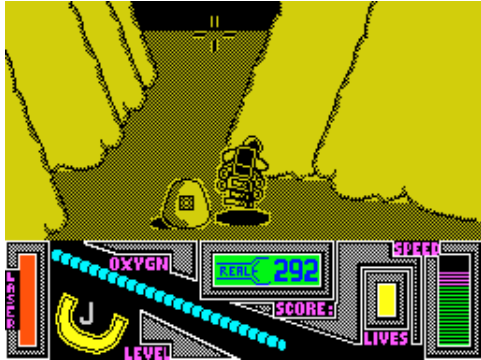

Telefonos (Compulogical S.A.,1985)
Utility



Technodrom (Real Software,1997)
Arcade

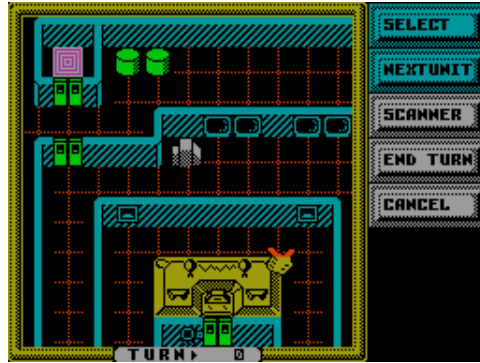

Teenage Mutant Hero Turtles (Image Works,1990)
Arcade Adventure

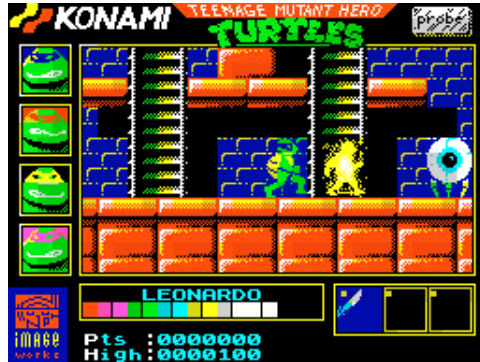

Tekst Ed (Tadeusz Wilczek,1985)
Utility: Word Processor

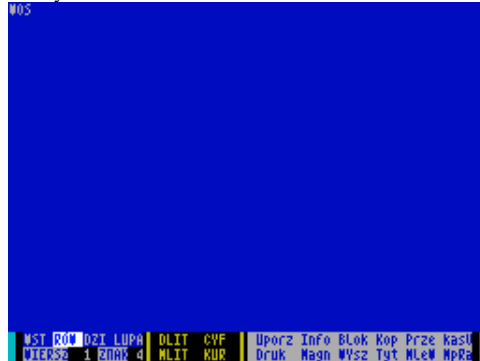

Tele (H.H.,1984)

Utility: Screen Manipulation



Telefonski Imenik (FV,1985)

Utility: Database

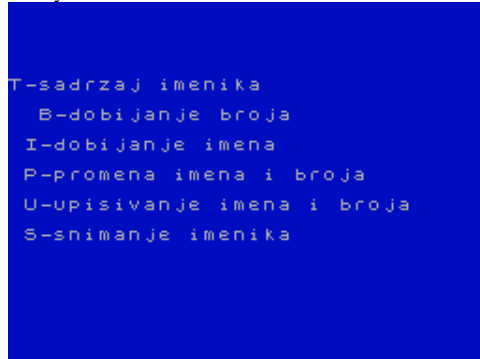

Teclastick (MicroHobby,1985)
Utility

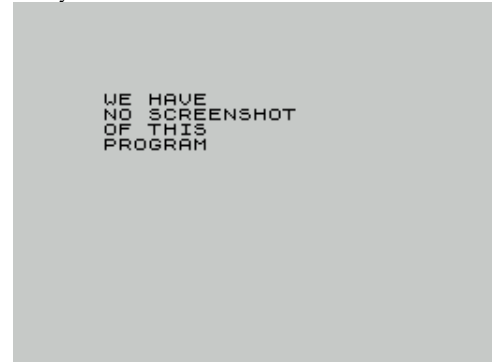

Teenage Mutant Hero Turtles - The Coin-Op (Image Works,1991)
Arcade



Tekuci Racun (Svet Kompjuteru,1985)

Utility: Spreadsheet

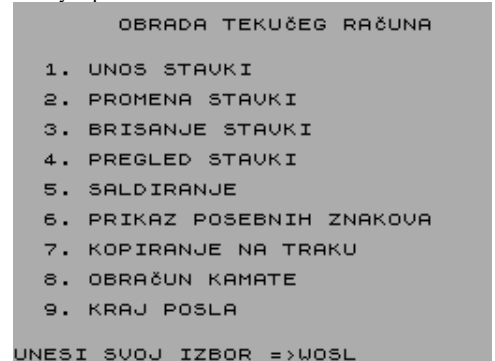

UNESI SVOJ IZBOR =>WOSL

Telealcala (Videograf,)

Utility



N.DE PELICULAS (MATINAL) :WOSL

Telefony (Proxima Software,1992)

Arcade



Telegrafiedecoder (H.J. Woicke),
Utility

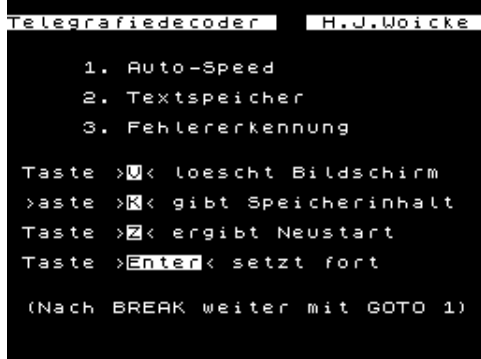

Teleport (Compiuter Soft,2005)
Arcade

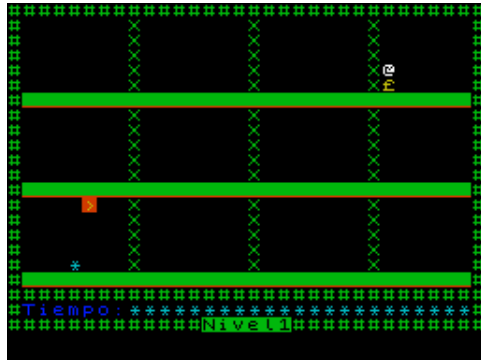

Television Demo, The (Spectec,1993)
Scene Demo



Telling the Time + Money (Poppy Programs,1983)
Compilation

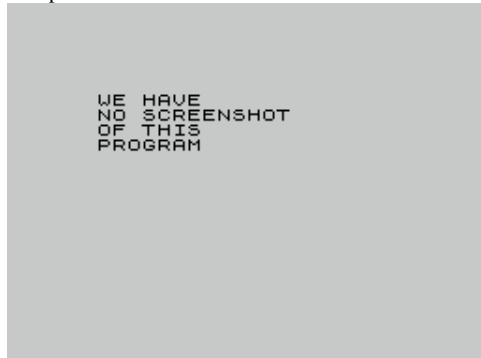

Telly Wise (Fastback,1990)
Simulation



Telemark Warrior (Silicom Games,1990)
Arcade



Telesoftware Uploader (Steve Marsh,1987)
Utility

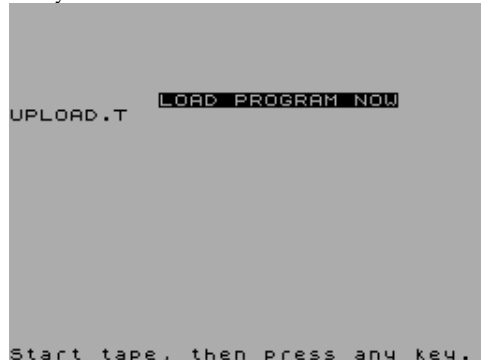

Tele Zoom (,)
Utility: Screen Manipulation

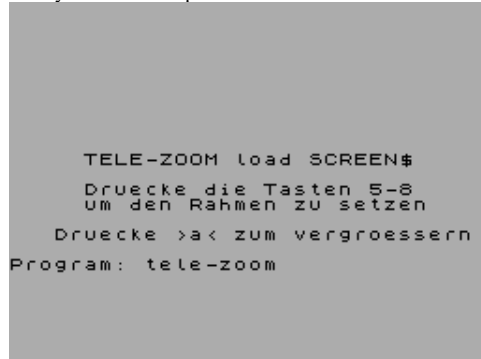

Tells Overture, The (Rocky Crackingservice,)
Music

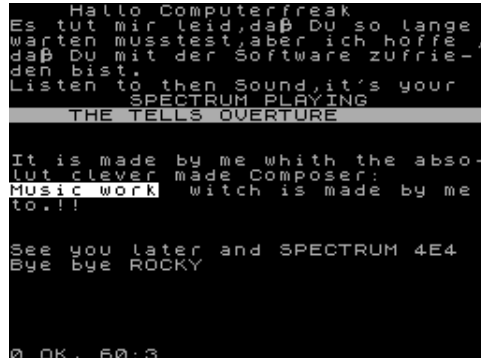

Temperament (Martin Stepanek,1984)
Simulation



Telephone & Address Pad (,)
Utility



Tele Terminal 300 Sp1.1 (Siegfried Lohberg,1985)
Utility



Telling the Time (Poppy Programs,1983)
Educational

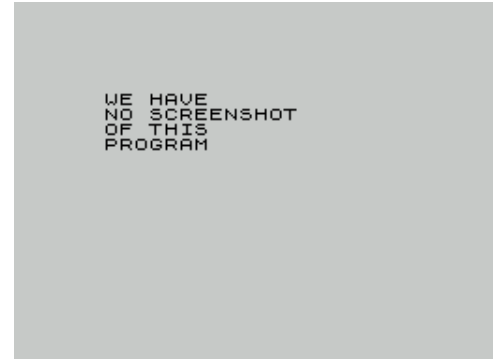

Telly Tennis (Amstrad,1986)
Arcade



Tempest (Electric Dreams Software,1987)
Arcade

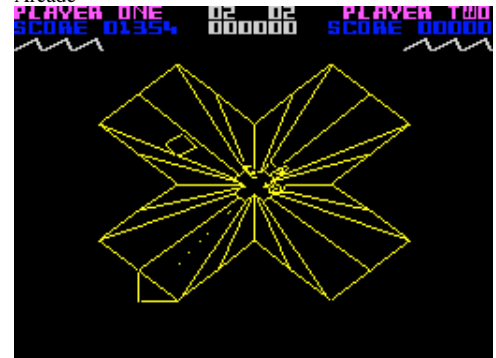

Tempest (EMM Software,1983)
Arcade

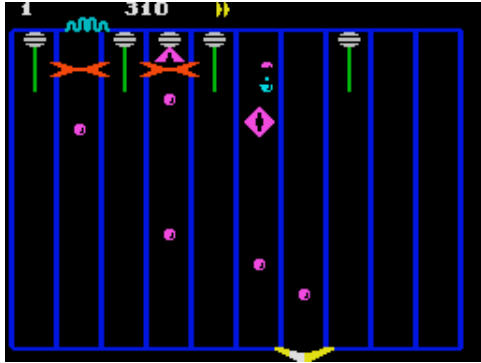

Temple of Vran (Incentive Software Ltd,1984)
Text Adventure

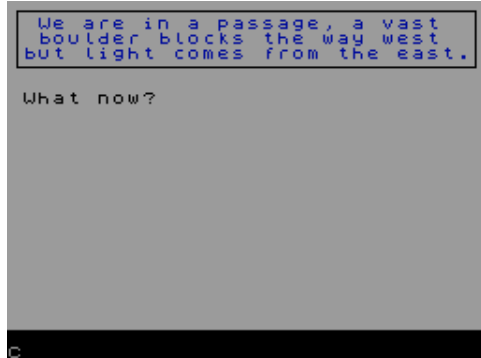

Templo de la Llama, El (Jaime Tejedor Gomez,2006)
Text Adventure

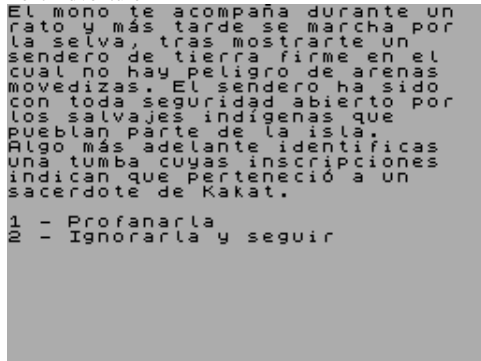

Tengen Trilogy, The (Domark Ltd,1990)
Compilation



Ten Little Adventurers (Adventure Probe Software,2001)
Text Adventure

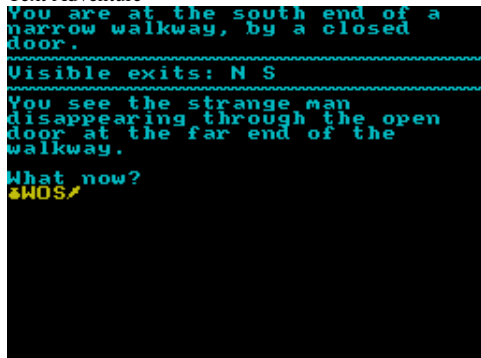

Tempest (Mikro-Gen Ltd,1983)
Arcade

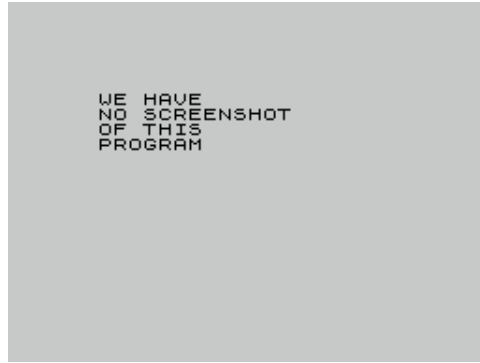

Temple Terror (Atlantis Software Ltd,1985)
Text Adventure

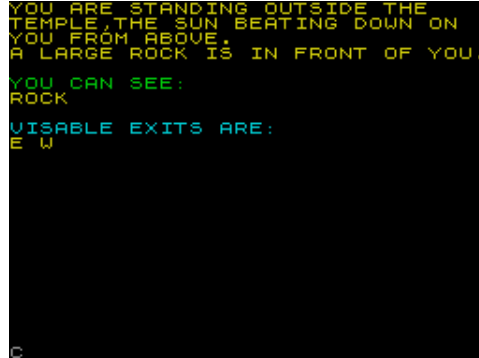

Templo Maldito, El (Micromania [2],1985)
Arcade

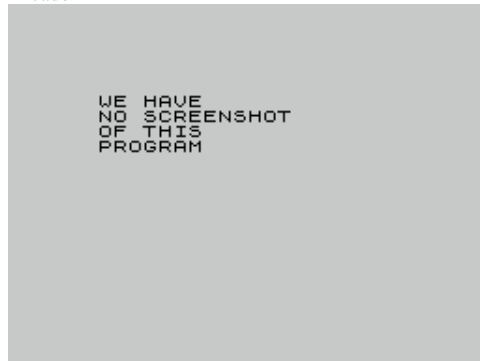

Ten Green Bottles (Zenobi Software,1995)
Text Adventure

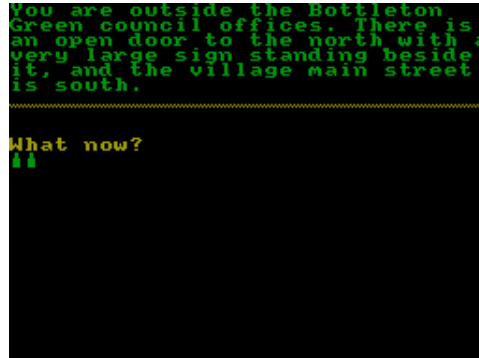

Ten Little Indians (Digital Fantasia,1984)
Text Adventure



Temple of Terror (Adventuresoft UK Ltd,1987)
Text Adventure



On the banks of the Catfish River which is spanned by a rope bridge. Moored nearby is an ancient sailing boat, the crew of which are shouting and yelling in a drunken and very threatening manner.

Restore a saved game ?

Temple, The (16/48 Tape Magazine,1985)
Arcade



Templos Sagrados, Los (Aventuras AD S.A.,1991)
Text Adventure



Tenkolek Light Pen (Tenkolek,)
Utility



Tenner (D.V.B.,1989)
Scene Demo

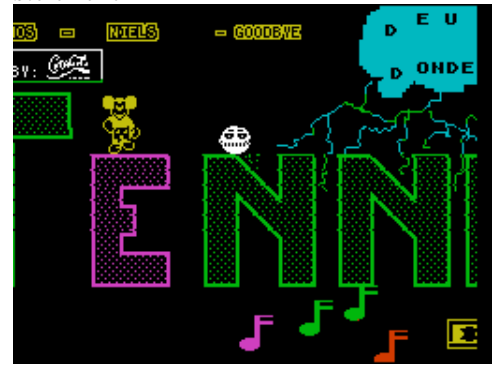

Tennis (Imagine Software Ltd,1986)
Sport



Tennis (Wintersonft,1983)
Sport



Ten-Pin Challenge (Atlantis Software Ltd,1987)
Sport

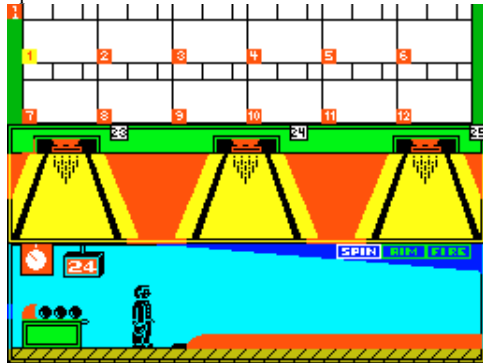

Tense French (Sulis Software Ltd,1984)
Educational



Teoria de la Musica - Curso II (Music Soft,1984)
Utility: Music Creation

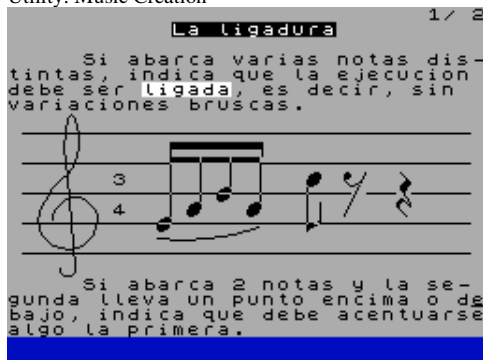

Tennis (Omikron Software [1],1986)
Arcade

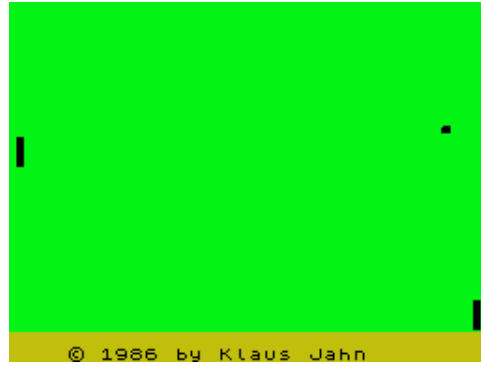

Tennis Champ (Lambourne Games,1989)
Simulation

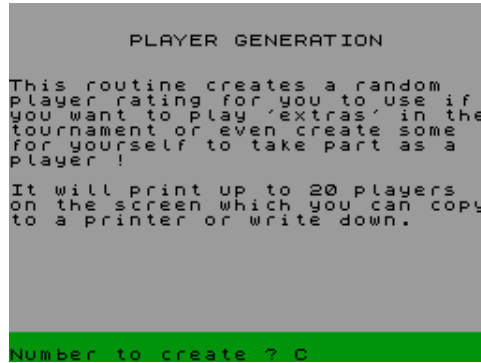

Tens and Units Addition (Calpac Educational Software,1983)
Educational



Teonw (.)
Utility

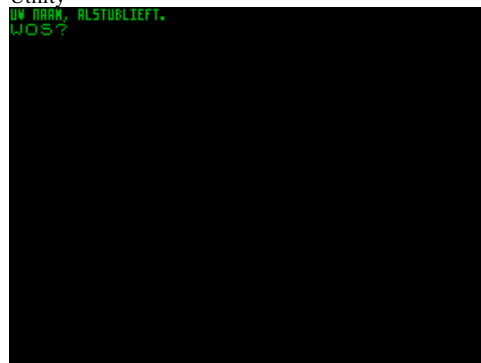

Termination (Sinclair User,1992)
Arcade Adventure



Tennis (Spectrum Computing,1984)
Arcade

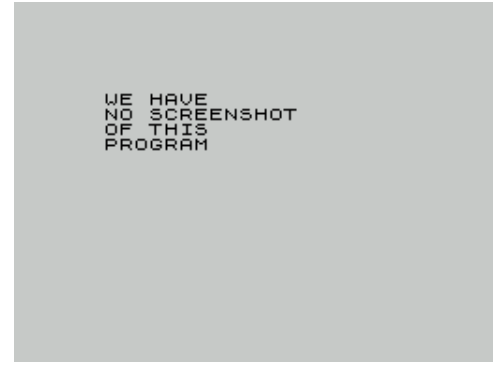

Tennis Master (Lambourne Games,1988)
Simulation

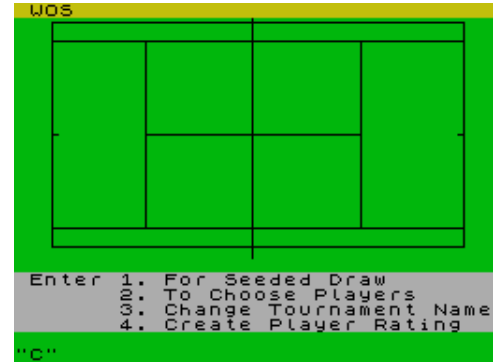

Tens and Units Subtraction (Calpac Educational Software,1983)
Educational



Teoria de la Musica - Curso I (Music Soft,1984)
Utility: Music Creation

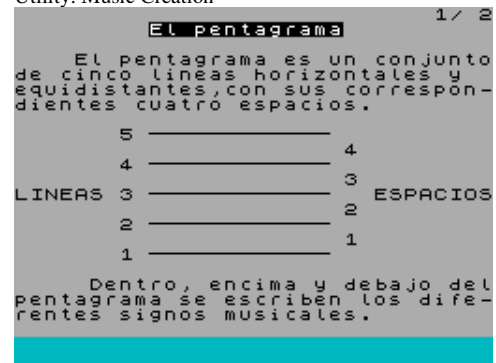

Terminator 2: Judgement Day (Ocean Software Ltd,1991)
Arcade

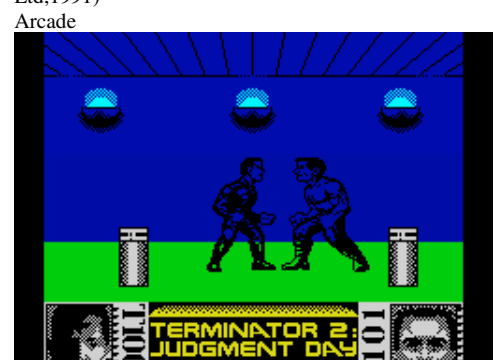

Terminus: The Prison Planet (Mastertronic Added Dimension,1986) Arcade

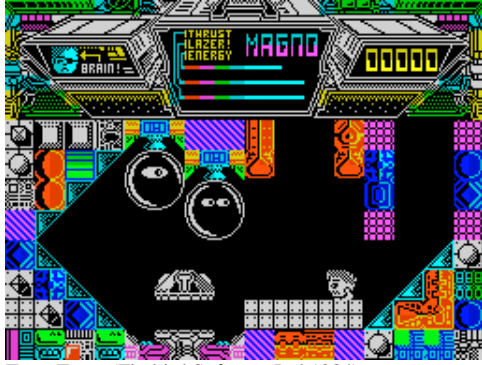

Terra Force (Firebird Software Ltd,1984) Arcade



Terramex (Grandslam Entertainments Ltd,1987) Arcade



Terror-Daktil 4D (Melbourne House,1983) Arcade

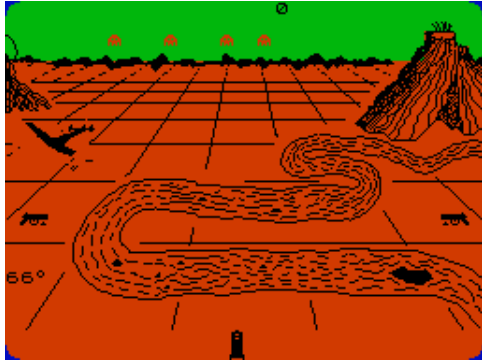

Terrormolinos (Melbourne House,1985) Text Adventure

A narrow hallway filled with the smells of cabbage and damp wellingtons. The garishly patterned wallpaper is obscured in places by works of art purchased at Boots and Woolworth

There is also a coal scuttle and a telephone.

UP/EAST/SOUTH/NORTH

You can also see:-

LITTLE KEN

3

Pics taken 00 Successful pics 00
Your score is 00% in 0001 turns

Terra Cognita (Code Masters Ltd,1986) Arcade

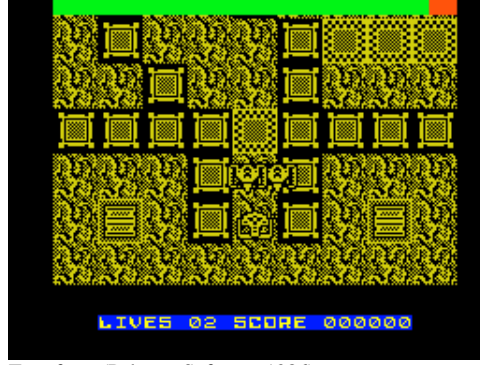

Terraform (Pelagon Software,1986) Text Adventure

day 1 *am*
you are in the control room of your spaceship, terraform a.

you can see:-
an exit hatch
a metal box

possible exits are:
south west

you are becoming weak and in need of food

what now?

Terrapin (Your Computer,1985) Arcade

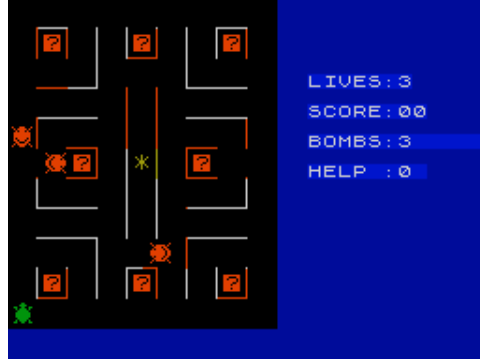

Terror from the Deep (Kayde Software Ltd,1983) Text Adventure

YOU ARE IN THE SEA BESIDES THE S.S. CELESTIAL

EXITS:-
NORTH
SOUTH
EAST
WEST

THERE IS:-
A ROPE

1

Terror of the Deep (Mirrorsoft Ltd,1987) Arcade

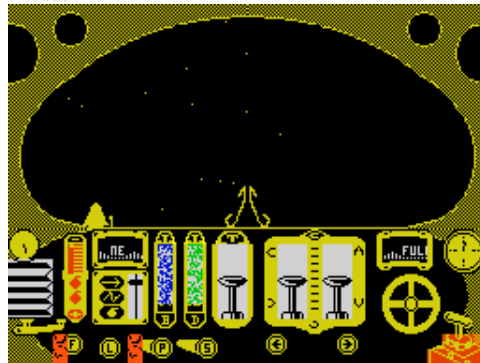

Terra Cresta (Imagine Software Ltd,1986) Arcade

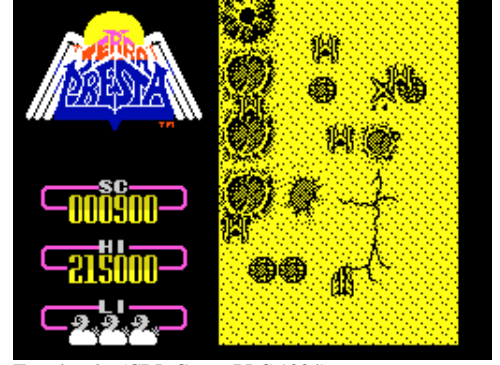

Terrahawks (CRL Group PLC,1984) Arcade

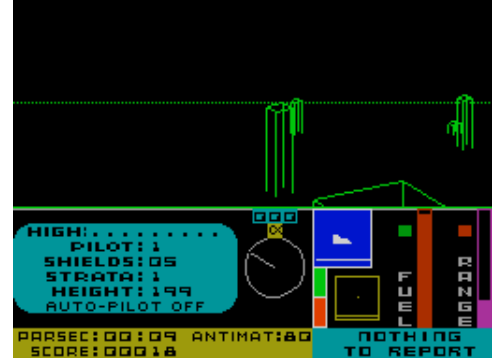

Terroids (Add-On Electronics Ltd,1983) Arcade



Terrorist, De (F. Bui venga,1985) Strategy

JAAR = 1985 MAAND = 2

MENU

1 KOOP MEER WAPENS.
2 HUUR MEER VEILIGHEIDS AGENTEN
3 OVERZICHT BANK
4 INKOOP
5 VERKOOP
6 VERZEKERINGEN
7 GA EEN MAAND VERDER!!

Terrorpods (Melbourne House,1989) Arcade



Terrors of Trantoss, The (Ariolasoft UK Ltd,1986)
Text Adventure



Tesla (Softhouse Ltd,1994)
Scene Demo

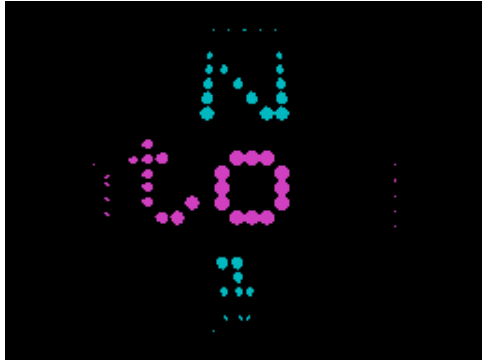

Test de Adaptacion (DIMensionNEW/Idealogic S.A.,1984)
Educational

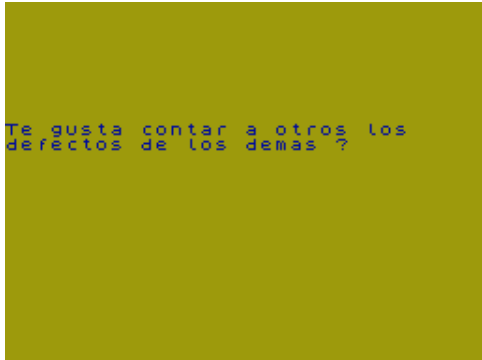

Test Inteligencji (Janusz Gajewicz,1985)
Utility

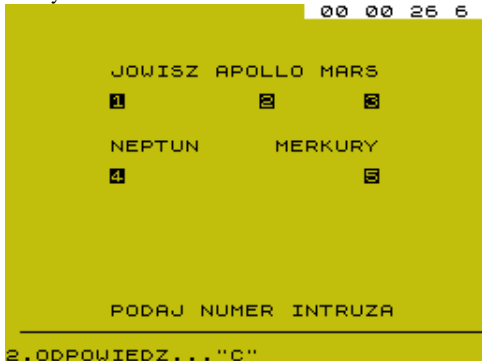

Test Match Cricket (CRL Group PLC,1983)
Simulation



Terry on the Move (BIBLEchip,1985)
Arcade

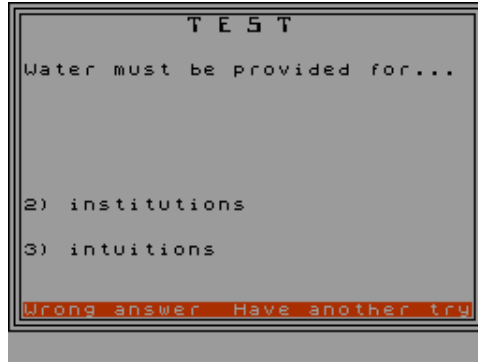

Tesoro del Faraon, El (MicroHobby,1985)
Arcade

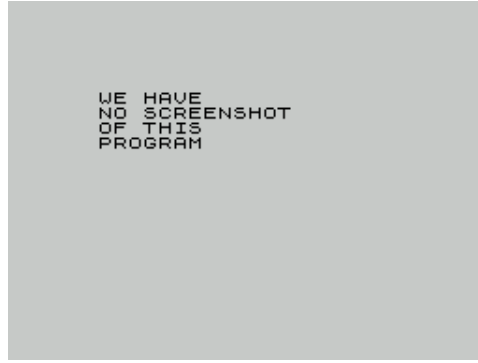

Terry's Travels (Algray Software,1983)
Arcade

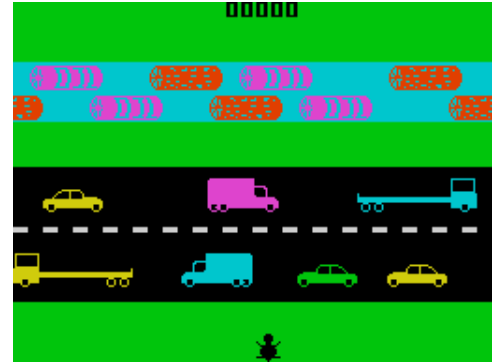

Test (MicroHobby,1985)
Utility



Test de Capacidad de Concentracion (DIMensionNEW/Idealogic S.A.,1984) Educational

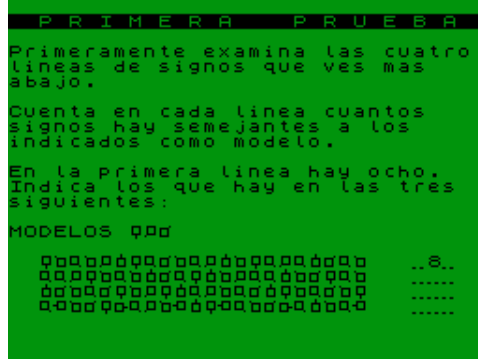

Test de Caracer (DIMensionNEW/Idealogic S.A.,1984)
Educational

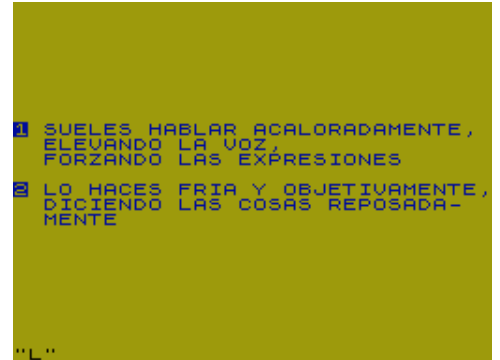

Test Master (E&J Software,1988)
Simulation

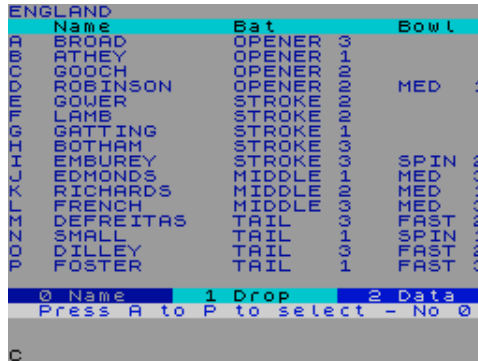

Test Program (Sinclair Research Ltd,1985)
Utility

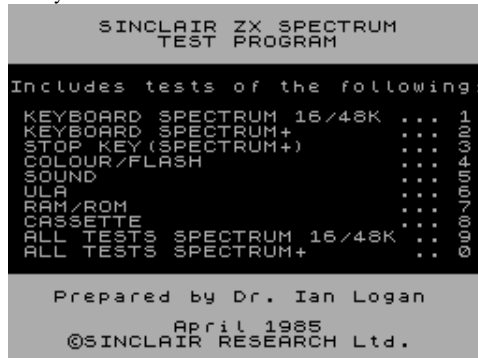

Test Match + One Day Cricket (CRL Group PLC,1983)
Compilation



Test Program K-3 (Happy-Computer,1992)
Utility



Test Tape (Sinclair Research Ltd.)
Utility



Test Vseobecnynh Vedomosti (CV Software,1988)
Educational



Tetriller (Advanced Computer Exotic,1992)
Arcade



Tetris (Mirrosoft Ltd,1988)
Board/Card Game

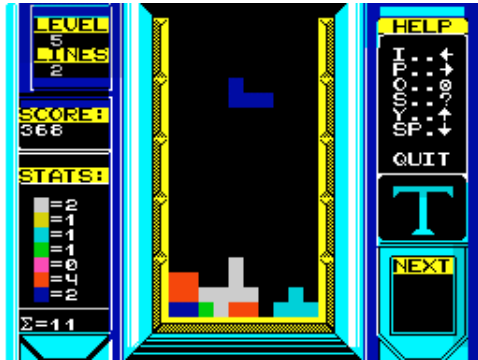

Tetris (Tera Software,1991)
Arcade



Test, The (.)
Text Adventure

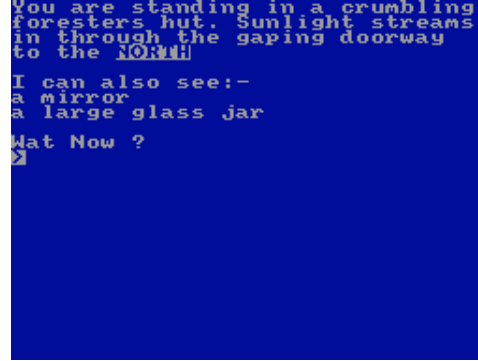

Test Zpusobu Zivota (CV Software,.)
Educational

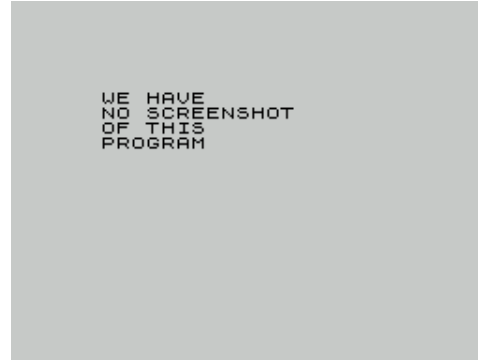

Tetris (AcademySoft,1986)
Board/Card Game

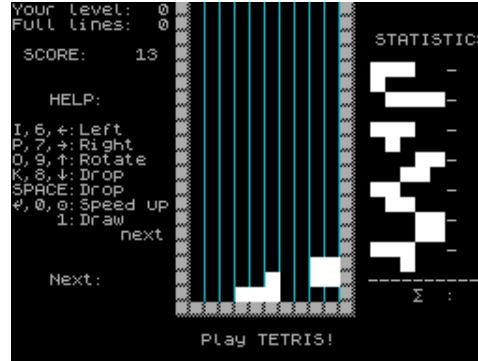

Tetris (Rafii Soft,1988)
Arcade



Tetris (V.A. Baliasov,1986)
Arcade



Test, The (The Guild,1993)
Text Adventure

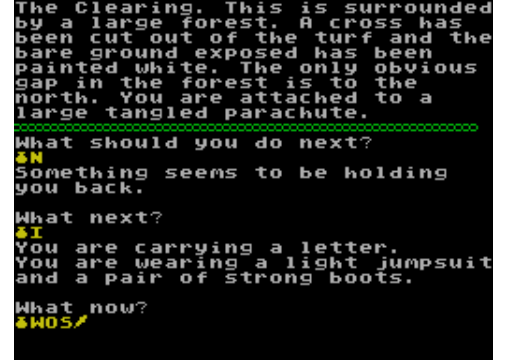

Tetra & the Chessboard Saga (Fogsoft,1985)
Arcade



Tetris (Andic Software,1986)
Arcade

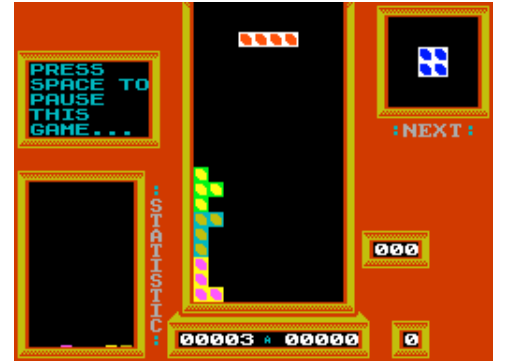

Tetris (R&S Compani,1995)
Arcade

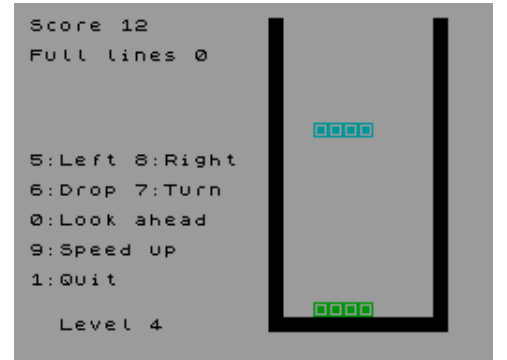

Tetris (V. Balyasov/P. Trubinov,1990)
Arcade



Tetris 2 (Fuxoft,1990)
Board/Card Game



Tetroid (Your Sinclair,1991)
Arcade

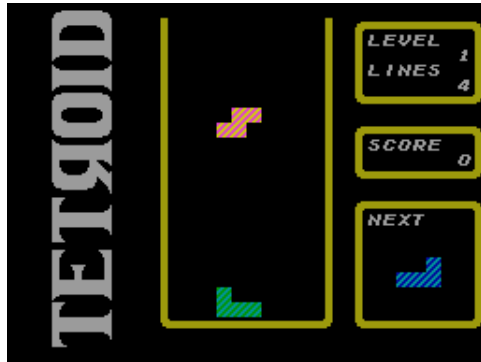

Text 5 Korrespondenz (.)
Utility: Word Processor



Textele (16/48 Tape Magazine,1984)
Simulation



TFF 2 (TFF Team,1989)
Scene Demo



Tetris 4 (.)
Arcade

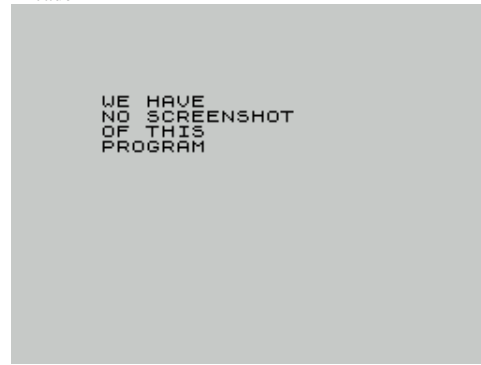

Teufels-Fahrer (Wicosoft,1984)
Arcade

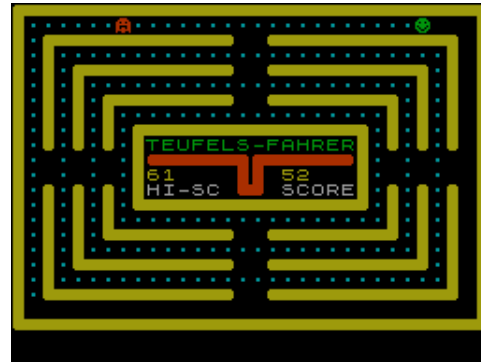

Text Conversion Program (J.T.,1986)
Utility



Textstar (Omikron Software [1].)
Utility: Word Processor



TFF 3 (TFF Team,1989)
Scene Demo



Tetris-Sokoban (Ivan Krut,1997)
Arcade

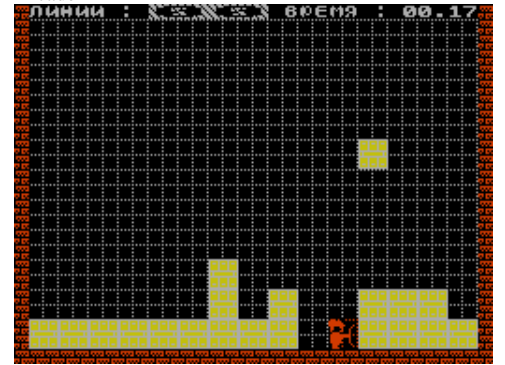

Texas Oil (MicroHobby,1985)
Strategy



Textedit (.)
Utility: Word Processor



TFF 1 (TFF Team,1989)
Scene Demo



TFF 4 (TFF Team,1989)
Scene Demo



TFF 5 (TFF Team,1989)

Scene Demo



Thanatos (Durell Software Ltd,1986)

Arcade



That's the Spirit (The Edge Software,1985)

Arcade



Their Finest Hour (Century Communications Ltd,1985)

Strategy

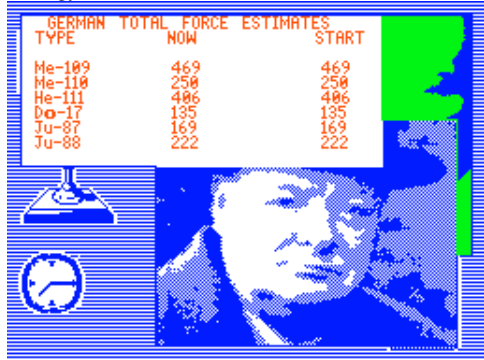

The Mad Guys Intro 2 (The Mad Guys,1990)

Scene Demo



TFF 6 (TFF Team,1989)

Scene Demo



Thank You (Oni Records,2000)

Demo



Theatre Europe (PSS,1986)

Strategy

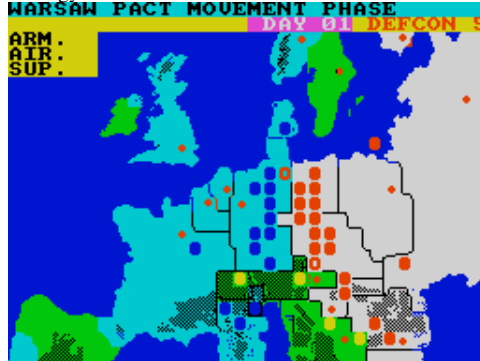

Them (Pirate Software Ltd,1988)

Arcade



The Mad Guys Intro 3 (The Mad Guys,1990)

Scene Demo



Thames Local (Dec-Kay Systems,1986)

Simulation

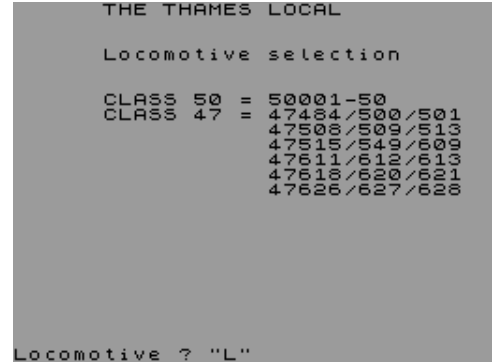

Thanos (MicroHobby,1989)

Arcade



Theatre of Death, The (Dave Watson,)

Text Adventure



The Mad Guys Intro 1 (The Mad Guys,1990)

Scene Demo



The Mad Guys Intro 4 (The Mad Guys,1990)

Scene Demo



The Mad Guys Intro 5 (The Mad Guys,1990)
Scene Demo

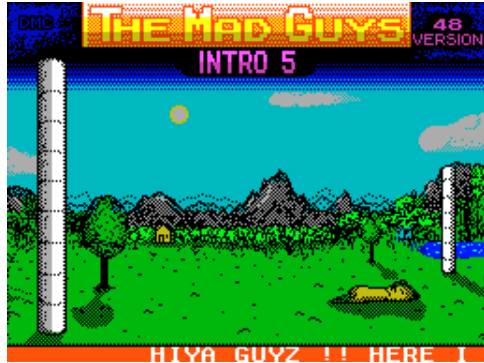

Theorem of Pythagoras, The (Griffin Software,1984)
Educational



There's a Bomb Under Parliament (Zenobi Software,1991)
Text Adventure



Theseus and the Minotaur (The Guild,1990)
Text Adventure

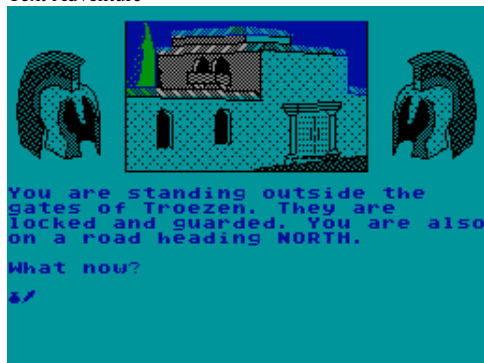

They Sold a Million (Ocean Software Ltd,1985)
Compilation



Theme Park U.K. (Zenobi Software,1993)
Text Adventure



Theory of Music to Grade 5 (Ted Kirk,1987)
Educational



There's a Hole in Your Bucket (Adventure Probe Software,1997) Text Adventure

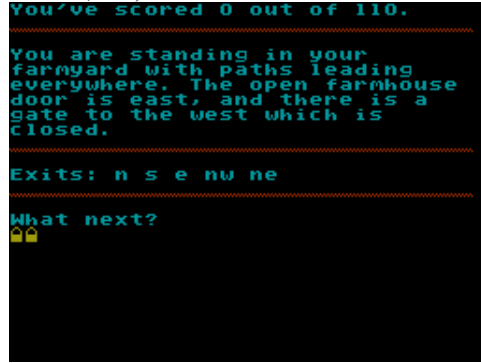

They Call Me Trooper (CRL Group PLC,1987)
Arcade

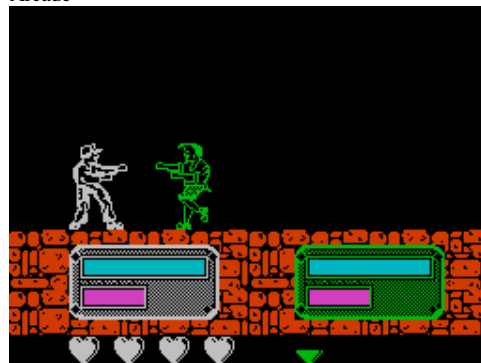

They Sold a Million 3 (Ocean Software Ltd,1986)
Compilation



Theme Park U.S.A. (Zenobi Software,1993)
Text Adventure



Therbo (Arcade Software,1984)
Arcade



Thermo-Nuclear War (Zircon Software,1985)
Strategy



They Say the World Will Die in Fire and Ice (Electric Software,1984) Text Adventure

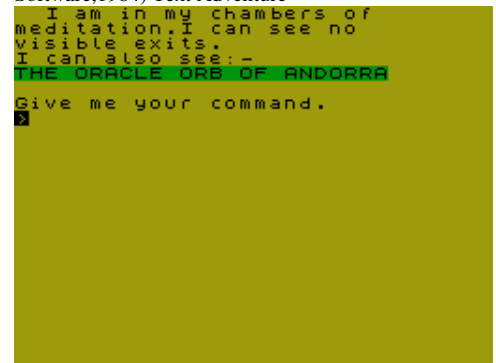

They Sold a Million (alternative) (Ocean Software Ltd,1985) Compilation



They Sold a Million II (Ocean Software Ltd,1986)



Thief (Stars Software,1987)



Thieves Like Us (Coolguys Ltd,1989)

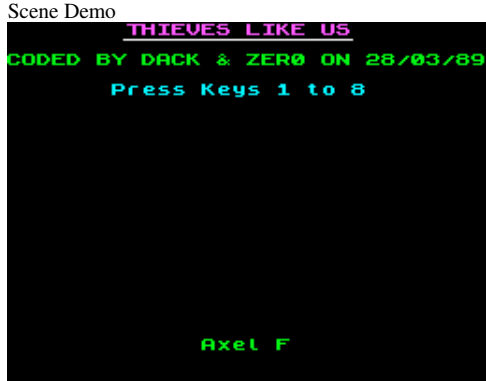

Thing Bounces Back (Gremlin Graphics Software Ltd,1987)

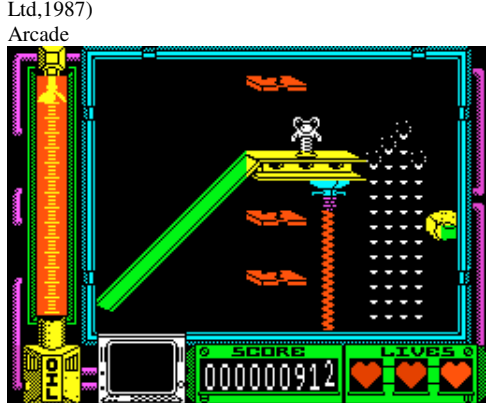

Think! (Ariolasoft UK Ltd,1985)

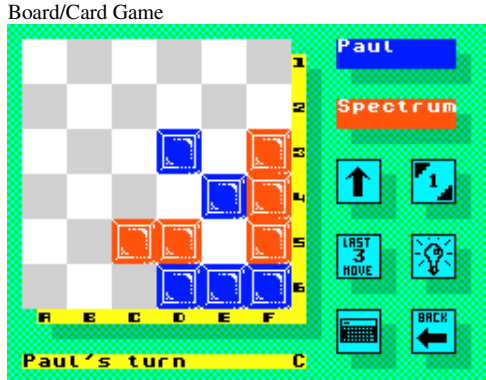

They Stole a Million (39 Steps,1986)



Thief in the Night, A (Westy Productions,1989)



THIMBLE (Triumph Game Labs,2001)

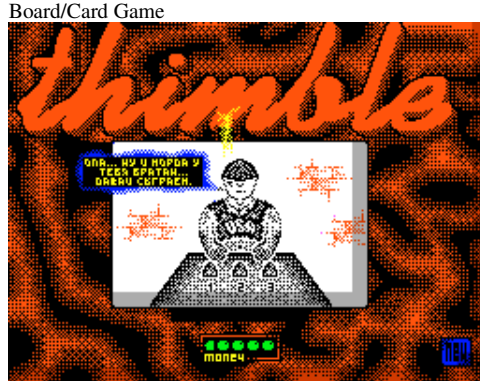

Things! (Advanced Adventure Creations,)



Thinker, The (Atlantis Software Ltd,1985)

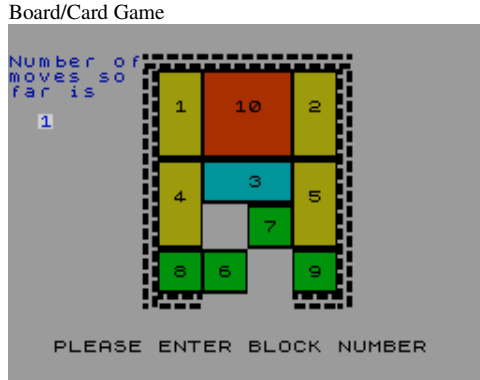

Thief (Corrupt Code,1989)

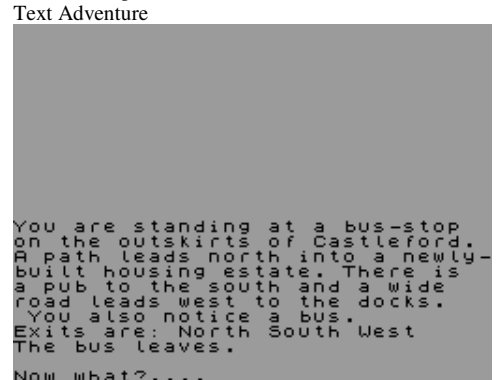

Thief's Tale, A (The Guild,1991)



Thing! (Players Software,1988)



Thingy and the Doodahs (Americana Software Ltd,1986)

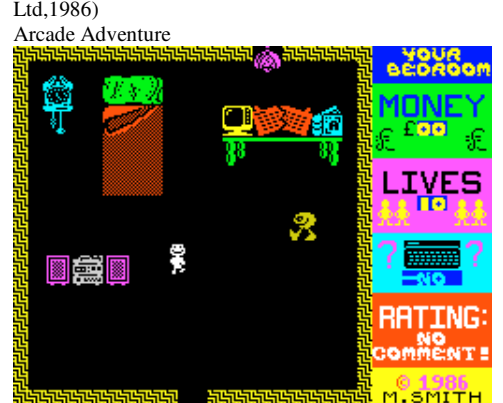

Third Dimension, The (M.D. White,1989)

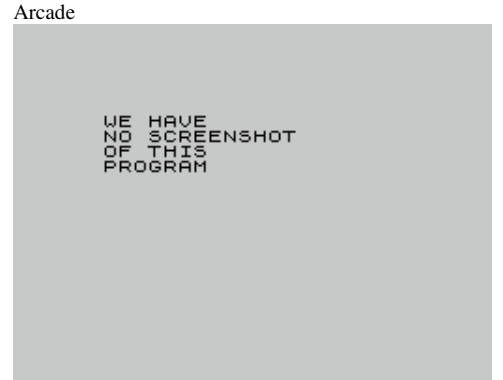

Thirty-Nine Steps, The (Zenobi Software,1995)
Text Adventure

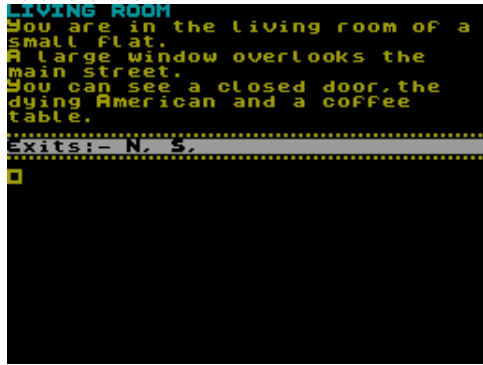

Thompson Twins Adventure, The (C&VG,1984)
Text Adventure



Thor y la Cria del Dragon (Grupo de Trabajo Software S.A.,1987) Arcade Adventure



Three-D Maze (Interface Publications Ltd,1983)
Arcade

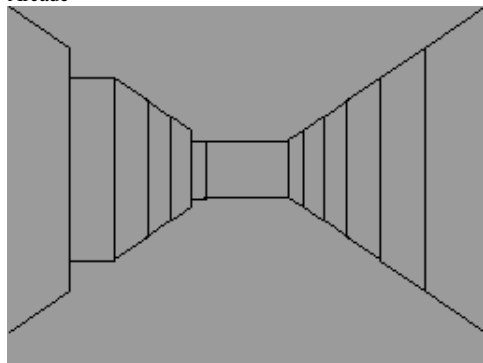

Three Weeks in Paradise (Mikro-Gen Ltd,1985)
Arcade



Thomas the Tank Engine & Friends (Alternative Software Ltd,1991) Arcade



Thor (Global Games [1],1989)
Text Adventure



Three Coin-Op Classics (US Gold Ltd,1987)
Compilation



Three in One (Video Showcase,1984)
Compilation



Thriller (Amazing Games,1985)
Text Adventure



Thomas the Tank Engine's Fun With Words (Britt Allcroft [Thomas] Ltd,1990) Educational

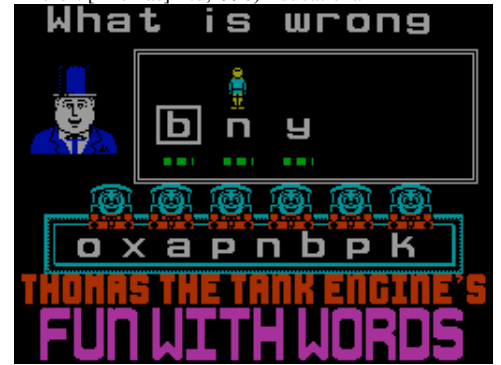

Thor (Proein Soft Line,1988)
Arcade

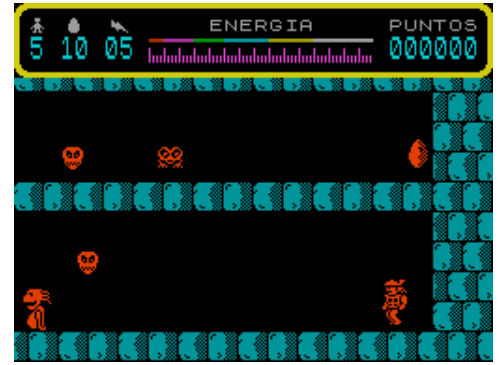

Three Days in Carpathia (The RamJam Corporation,1984)
Text Adventure



Three Musketeers, The (Computer Novels,1986)
Text Adventure



Thriller Pack, The (Paxman Promotions,1987)
Compilation



Thrill Time Gold 1 (Elite Systems Ltd,1990)
Compilation

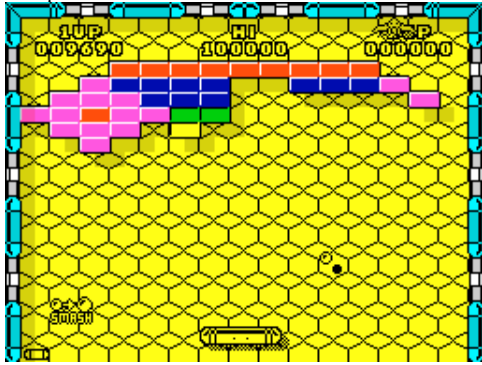

Thrill Time Platinum (Elite Systems Ltd,1990)
Compilation

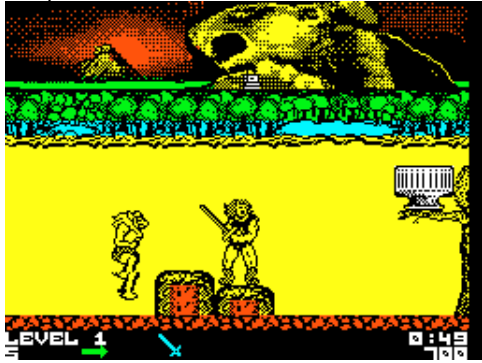

Through the Trap Door (Piranha,1987)
Arcade Adventure



Thrust II (Firebird Software Ltd,1987)
Arcade



Thunderbirds (Firebird Software Ltd,1985)
Arcade



Thrill Time Gold 2 (Elite Systems Ltd,1990)
Compilation

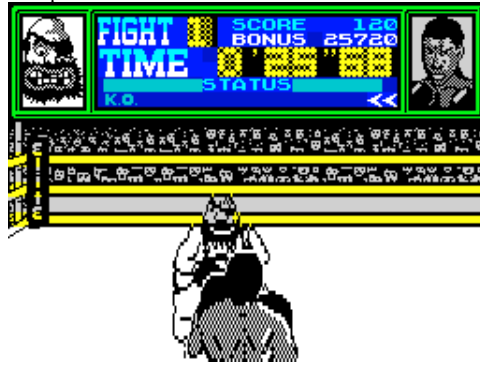

Throne of Fire (Melbourne House,1987)
Arcade Adventure

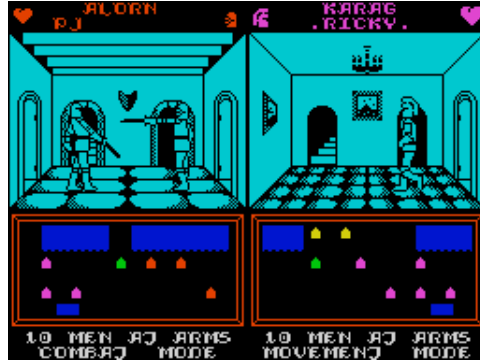

Thrust (Firebird Software Ltd,1986)
Arcade

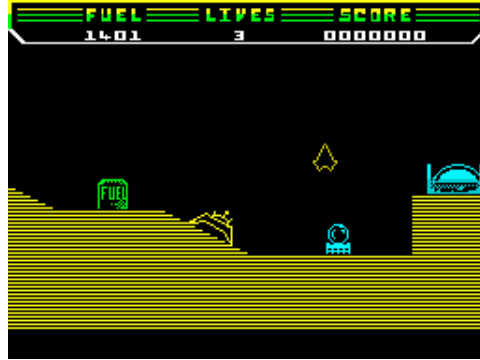

Thunderbasic (Thunderteam,1985)
Utility: BASIC Related



Thunderbirds (Grandslam Entertainments Ltd,1989)
Arcade



Thrill Time Gold 3 (Elite Systems Ltd,1990)
Compilation



Thro' the Wall (Sinclair Research Ltd,1982)
Arcade

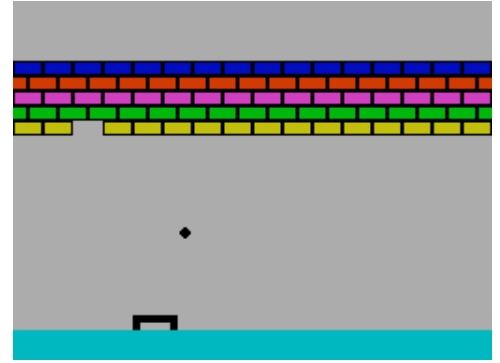

Thrusta (Software Projects Ltd,1983)
Arcade

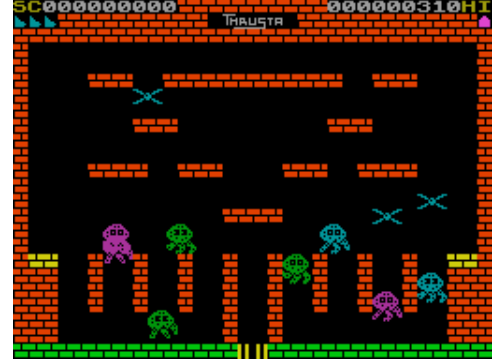

Thunderbird (Digital Integration,1984)
Arcade



Thunder Blade (US Gold Ltd,1988)
Arcade



Thundercats (Elite Systems Ltd,1987)
Arcade

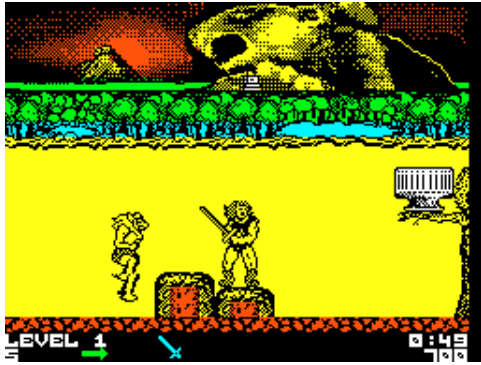

ThunderJaws (Domark Ltd,1991)
Arcade Adventure



Ticket to Ride, A (Mastertronic Ltd,1986)
Arcade Adventure



TicTacToe (Stephan Slabihoud,1986)
Board/Card Game

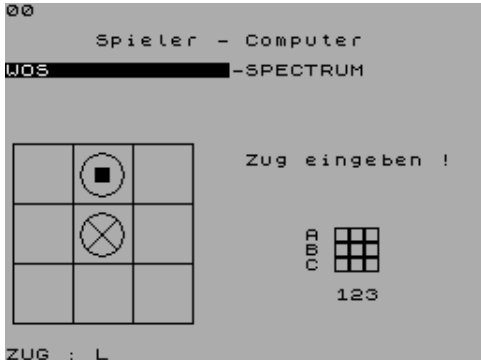

Tiddly Drinks (Gremlin Graphics Software Ltd,1987)
Arcade



Thunderceptor (Go!,1987)
Arcade

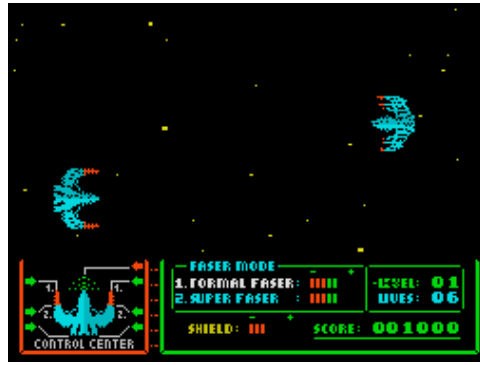

Tiburcio (MicroHobby,1985)
Arcade

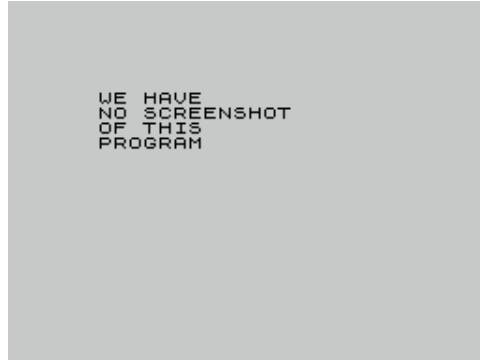

Tick-Land (MicroHobby,1986)
Arcade



Tic-Tac-Toe, 3D (Orwin Software,1983)
Board/Card Game



Tidy Tony (Tynesoft,1987)
Arcade



Thunderhawks (Lyversoft,1984)
Arcade



Ticket, The (Gilsoft International,1986)
Text Adventure

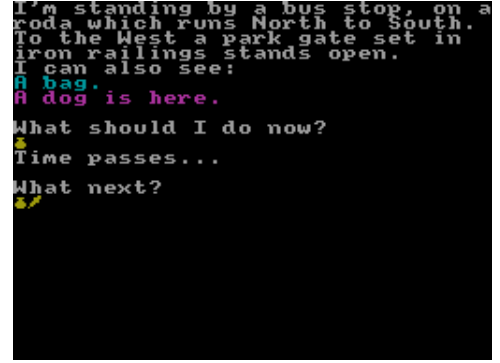

Tick Tock Clock (Your Sinclair,1993)
Utility

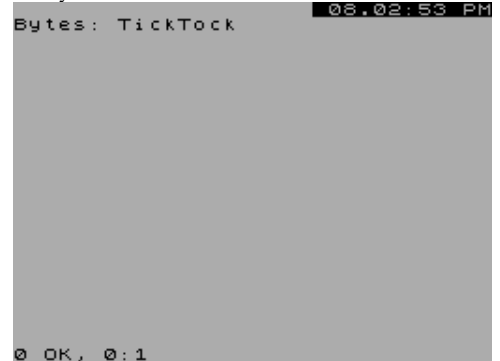

Tic Tac Toe, 3D (Orwin Software,1983)
Board/Card Game



Tiempo Mortal (Alien Software,1993)
Text Adventure



Tiger Hunt (Shiva Publishing Ltd,1983)
Arcade

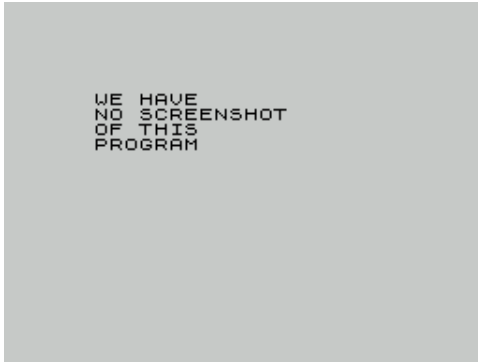

Tiger Mission (Status Software,1987)
Arcade



Tiger Road (Go!,1988)
Arcade Adventure



Tigers in the Snow (US Gold Ltd,1986)
Arcade



Tiler (Interceptor Micros Software,1984)
Arcade



Tiler Tim (Microwish,1984)
Simulation



Tiles (DJR,1993)
Board/Card Game

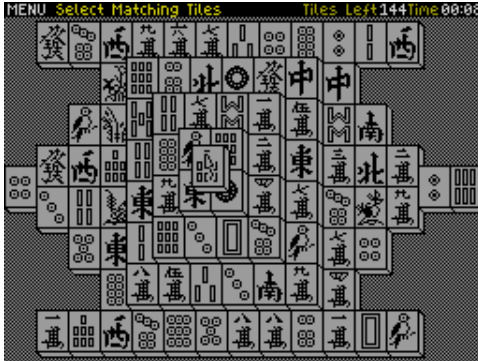

Tiless (Beyker Soft,2005)
Board/Card Game



Tili-Toli (Laszlo Nyitrai,1998)
Board/Card Game

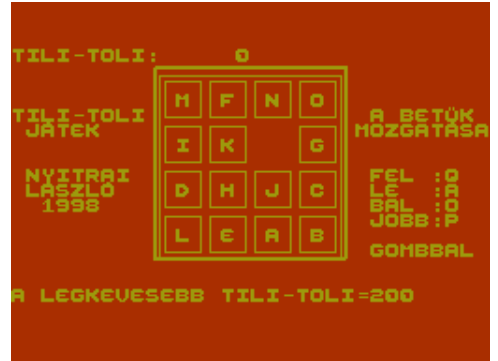

Tilt (Code Masters Ltd,1990)
Arcade



Tilt (Linell Software,1992)
Arcade



Tim (Janusz Gajewicz,1986)
Arcade

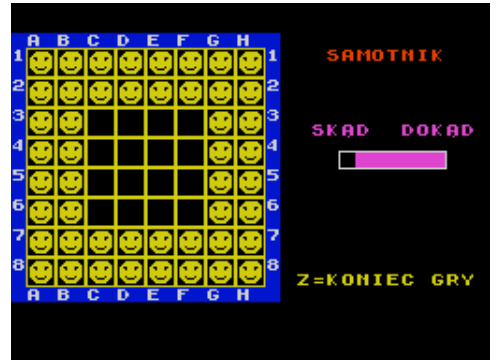

Timber! (Your Computer,1985)
Arcade

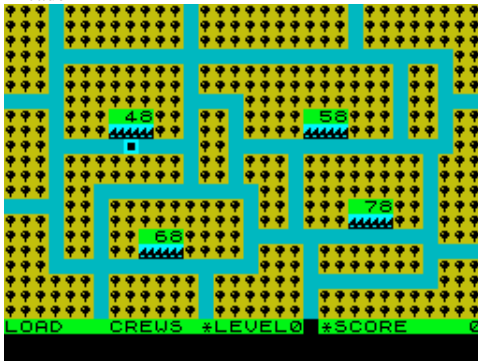

Time (AVP Computing,1986)
Educational

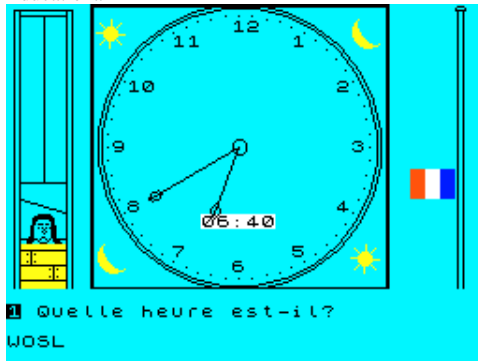

Time (Stell Software,1983)
Educational



Time and Magik (Mandarin Software,1988)
Compilation



Timebomb (CDS Microsystems,1984)
Arcade

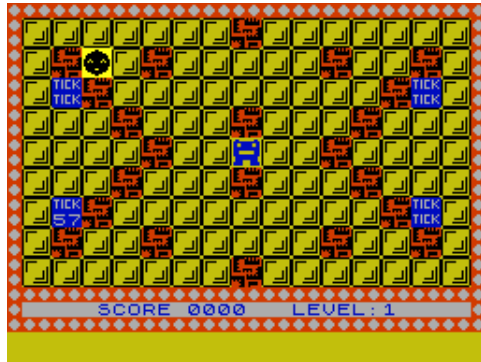

Time Cop (Rover Soft,1996)
Arcade



Time-Gate (Quicksilva Ltd,1983)
Arcade



Time Machine (5D Software,1984)
Text Adventure



Time and Motion (Design Design Software,1986)
Compilation

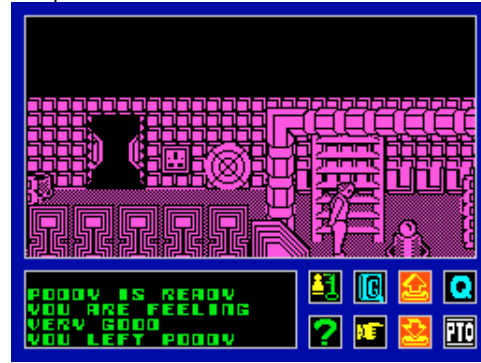

Time Bomb (Your Sinclair,1986)
Arcade

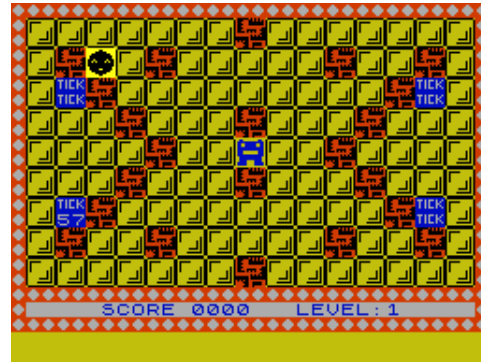

Time Flies (Firebird Software Ltd,1988)
Arcade

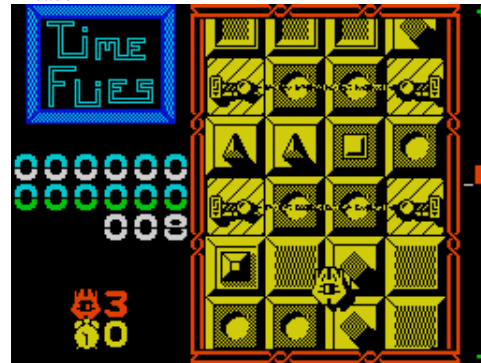

Time-Line (Gilsoft International,1983)
Text Adventure

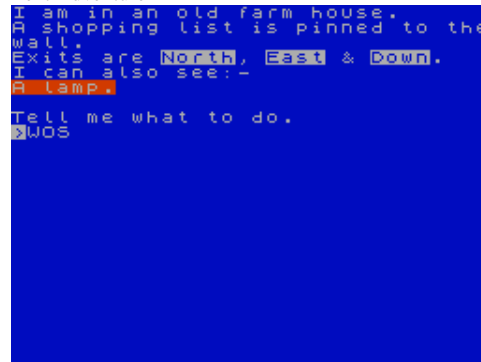

Time Machine (Activision Inc,1990)
Arcade Adventure



Time Bandits (Newsoft Products,1982)
Arcade

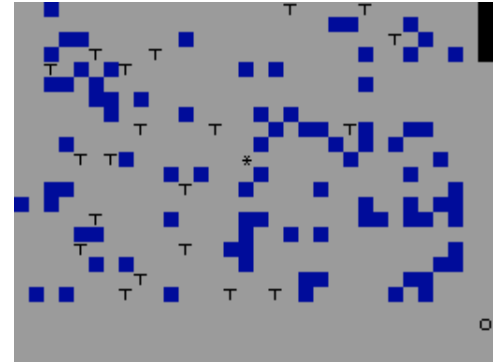

Time Bug (Procom Software,1984)
Arcade

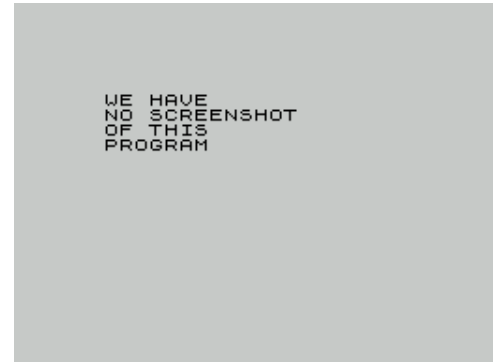

Time Flight (The Power House,1986)
Arcade



Time Lords Amulet, The (Steven Kendall,1984)
Text Adventure

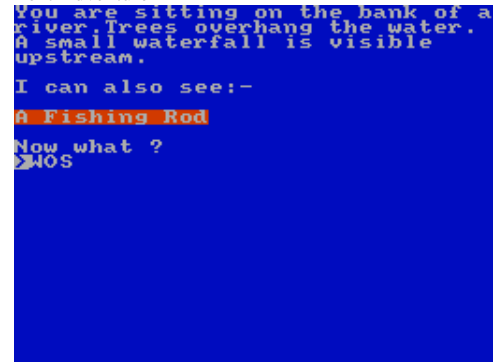

Time Machine, The (Digital Fantasia,1983)
Text Adventure



Time of the End, The (Mandarin Software,1986)

Text Adventure

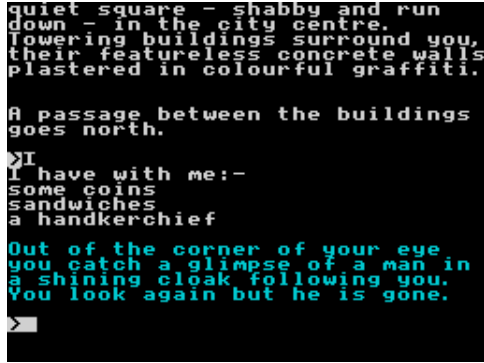

Time Port 1 (Wizard Software,1984)

Arcade



Time Quest (Scorpio Gamesworld,1985)

Text Adventure



Times Book of Computer Puzzles & Games, The (Newtech Publishing Ltd,1984) Compilation



Times Computer Crosswords Volume 1, The (Akorn Ltd,1988)

Compilation



Time Out (Zafiro Software Division,1988)

Arcade



Timequest (Mikro-Gen Ltd,1983)

Arcade



Time Robbers, The (Indescomp S.A.,)

Arcade



Time Scanner (Activision Inc,1989)

Arcade



Times Computer Crosswords Volume 2, The (Akorn Ltd,1988)

Compilation

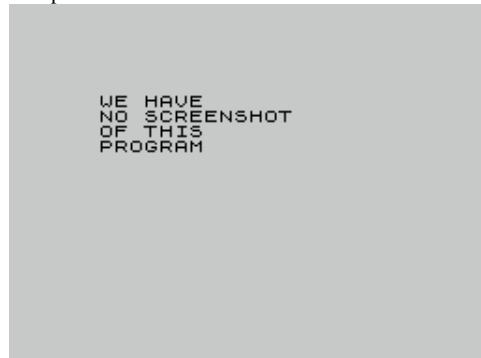

Timepolice (V. Dittmar,1984)

Text Adventure

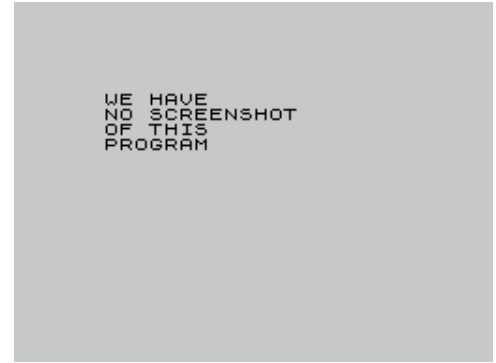

Time Quest (Peter L. Robinson,)

Text Adventure



Time Sanctuary (MC Lothlorien Ltd,1986)

Arcade Adventure



Times Computer Crosswords Jubilee Puzzles 1932-87, The (Akorn Ltd,1988) Compilation



Times Computer Crosswords Volume 3, The (Akorn Ltd,1988)

Compilation



Timesearch (Millenium Software,1985)
Text Adventure

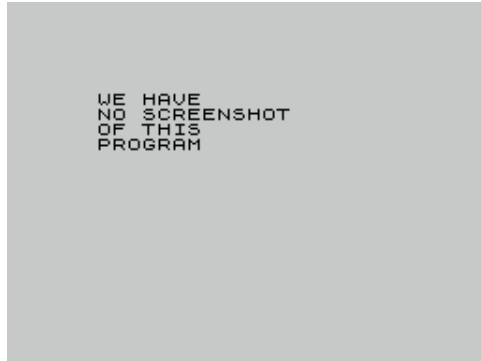

Time Switch (Your Computer,1983)
Text Adventure

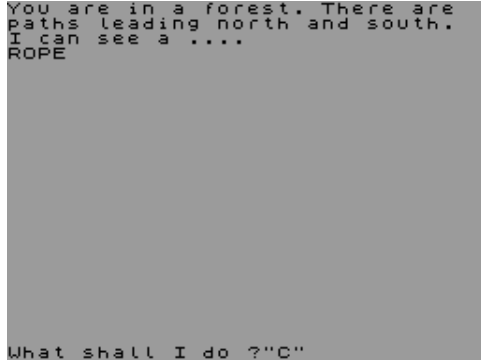

Time Tunnels (Christopher James Software Ltd,1985)
Strategy



Time Watch (Matthew Wilson,1986)
Text Adventure

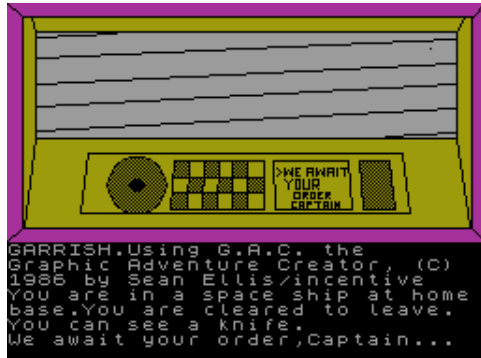

Timezone (Atlantis Software Ltd,1985)
Arcade Adventure



Times of Lore (Origin Software,1988)
Arcade Adventure

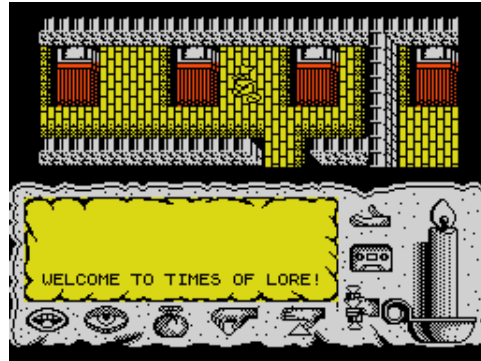

Time Traveller (Sulis Software Ltd,1983)
Arcade

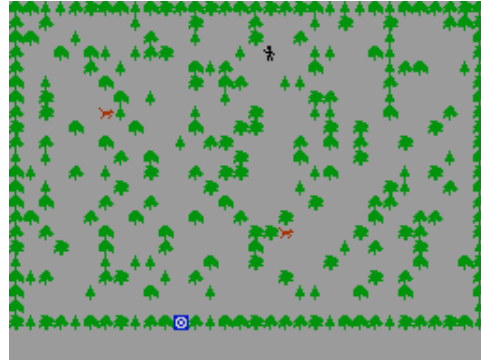

Time Warp (Cabssoft,1983)
Text Adventure



Timewise (Incentive Software Ltd,1986)
Text Adventure



Time Zone (R.D. Foord Software,1985)
Text Adventure



Time Switch (R.D. Foord Software,1985)
Text Adventure



Time Trax (Mind Games,1986)
Arcade



Time Warrior (Zenobi Software,1991)
Text Adventure



Time Wreck (Sparklers,1985)
Arcade Adventure

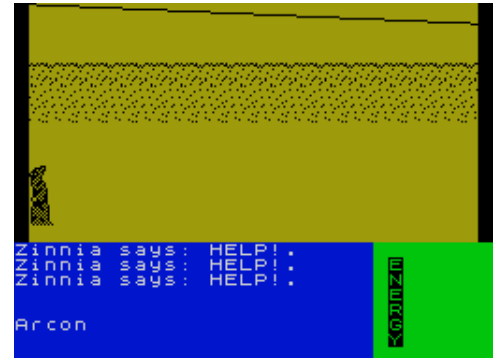

Tim Follin's Music (TDM Software,1997)
Scene Demo



Timoty Follin 2 (Mat & Zutek,
Scene Demo



Tintin on the Moon (Infogrames,1989)
Arcade

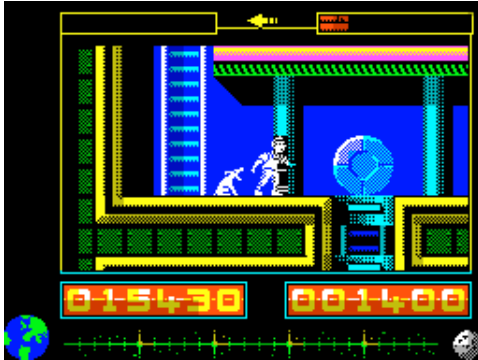

Tiny Touch 'n' Go (Sinclair Research Ltd,1984)
Educational



Tiro de Pichon (MicroHobby,1985)
Arcade



Titanic (Newsoft Products,1982)
Arcade



Tinderbox (Gremlin Graphics Software Ltd,1985)
Text Adventure

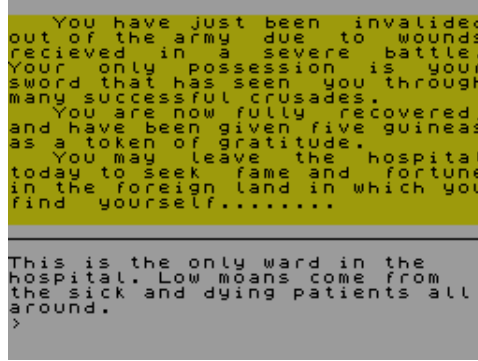

Tiny Code (Amazing Games,1984)
Utility: Programming



Tired of the Boring Sinclair Font (5th Dimension,1986)
Utility



Titan (Titus,1989)
Arcade

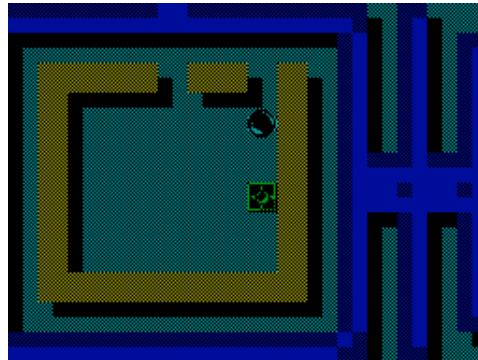

Titanic (R&R Software Ltd,1984)
Simulation

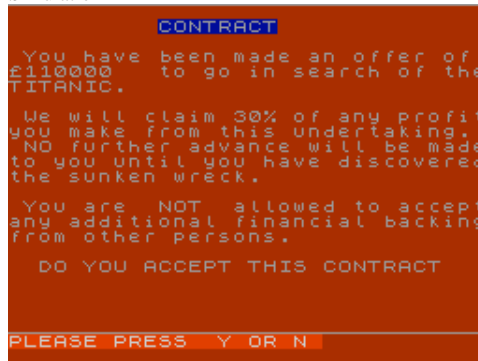

Tinny (Proxima Software,1992)
Arcade

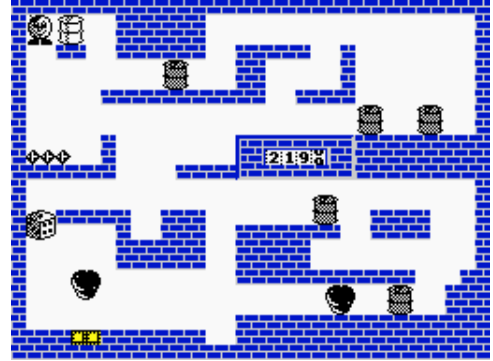

Tiny Tot's Seven (Anirog Software,1983)
Compilation



Tir Na Nog (Gargoyle Games,1984)
Arcade Adventure



Titan (Tomorrow's Dream Software,1985)
Utility: Programming



Titanic (Topo Soft,1989)
Arcade

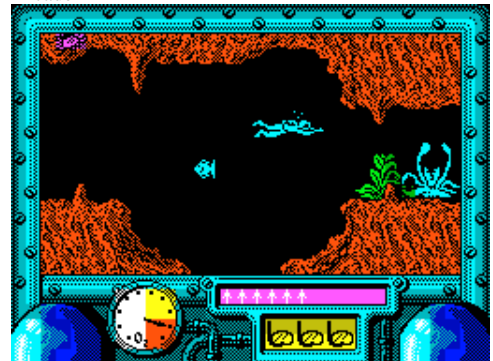

Titanic 50 (.)
Arcade

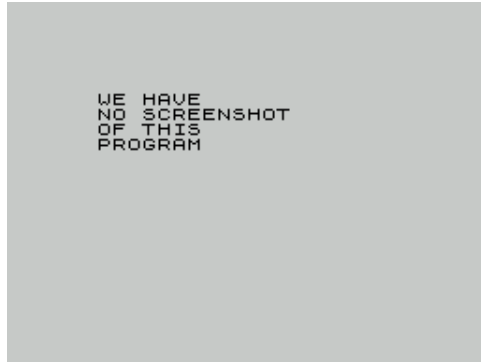

Titulos en 3D (MicroHobby,1985)
Utility



TK50 Toolkit (Sinclair User,1992)
Utility: Programming



T.N.T. (MicroHobby,1986)
Arcade



Toady (Spectrum Computing,1983)
Arcade



Titanic Blinky (Zeppelin Games Ltd,1991)
Arcade



Tizmatrix (Laszlo Nyitrai,2003)
Board/Card Game



T.L.L. (Vortex Software,1984)
Arcade

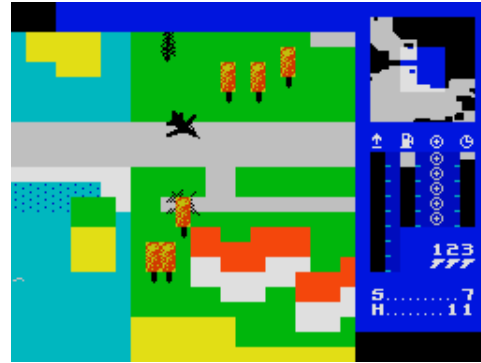

TNT 2: Double Dynamite (Domark Ltd,1992)
Compilation



Tobias Kalandjai (Interbit Software,1984)
Arcade

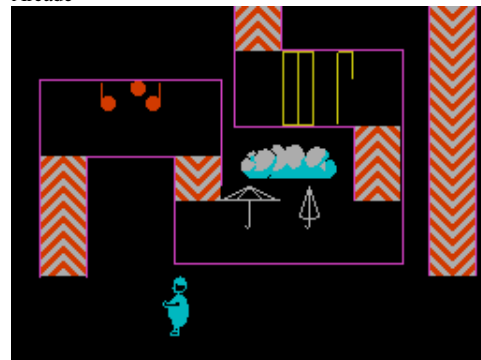

Titratons (Cloud 9 Software,1983)
Educational

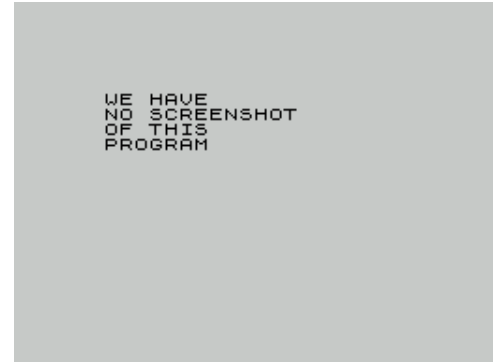

Tizpan, Lord of the Jungle (The Adventure Workshop,1990)
Text Adventure



TNT (Domark Ltd,1990)
Compilation



Toadrunner (Ariolasoft UK Ltd,1986)
Arcade



Tobogan (MicroHobby,1985)
Arcade



Tobor (Elfin Software Ltd,1982)

Arcade
00000 P1 ELFIN SOFTWARE P2 00000

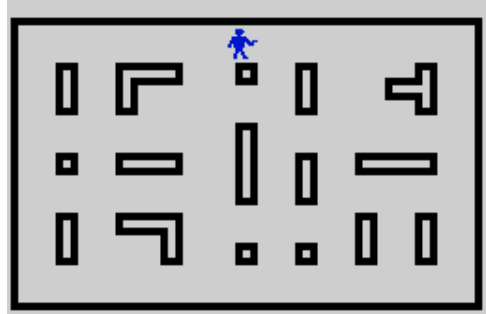

TOBOR 00000 HIGH

Toda Maquina, A (Erbe Software S.A.,1989)

Compilation



To Format UDG Code (Megasoft [3],1985)

Utility: Font/UDGs



Toilet Truble (Automata UK Ltd,1985)

Arcade

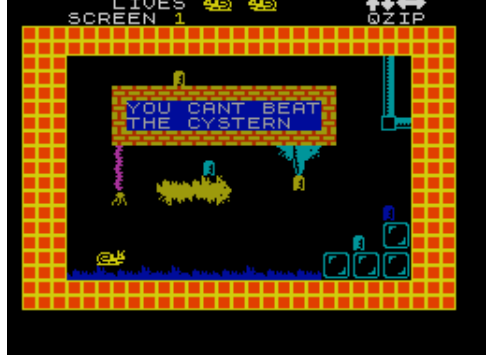

Toki (Ocean Software Ltd.)

Arcade



ToBoS Fp (Torun,1986)

Utility



Toda Maquina II, A (Erbe Software S.A.,1990)

Compilation

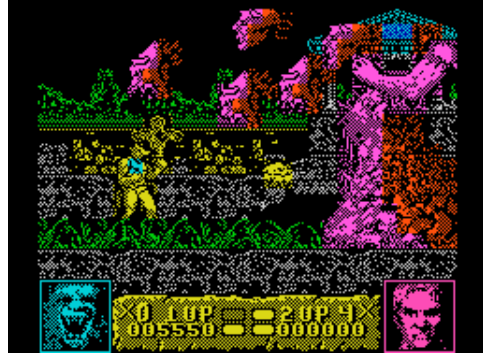

Toi Acid Game (Iber Software,1989)

Arcade

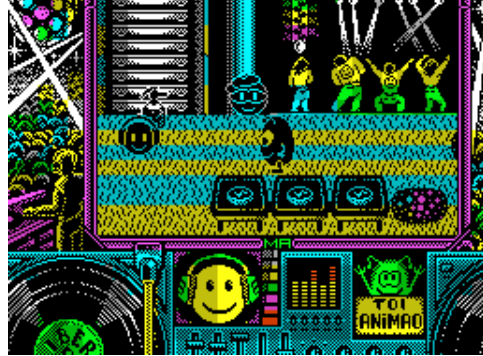

To Je Jedno (The Unbelievables,1996)

Scene Demo



Tokyo Gang (G.LL. Software,1990)

Arcade



Tobruk 1942 (PSS,1987)

Strategy

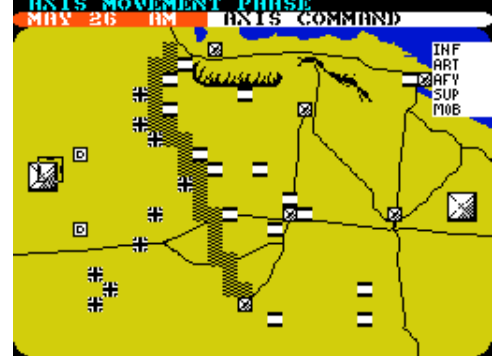

Toddler Trouble (Zenobi Software,1996)

Text Adventure

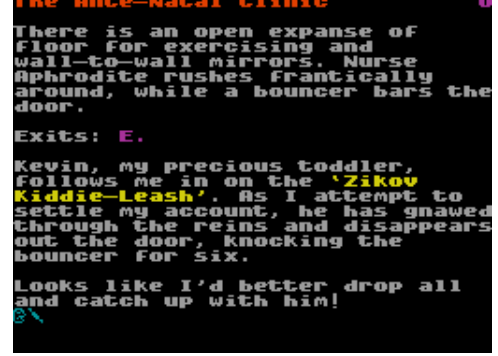

Toilet Paper 1 (Pete Novak/Alex Kiselev,1993)

Scene Demo



To Je On (Cidsoft,1987)

Board/Card Game



Tol (Bobek Software,1988)

Arcade

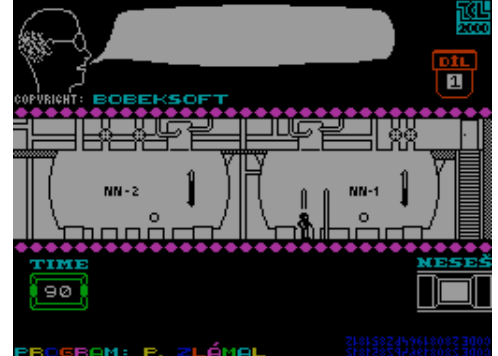

Tolkien Trilogy, The (Beau-Jolly Ltd,1989)
Compilation



Tomb of Akhenaten (CCS,1984)
Arcade



Tomb of the Minotaur (Mole Software,1985)
Arcade



Tomcat (Players Software,1989)
Arcade

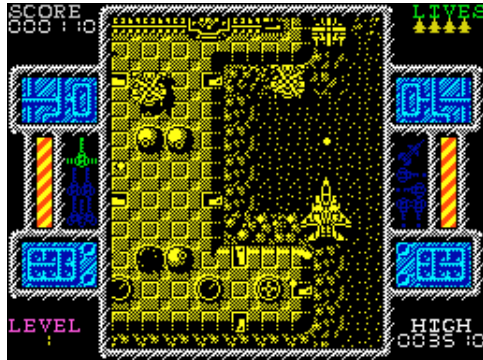

Tom Jones (Proxima Software,1990)
Text Adventure

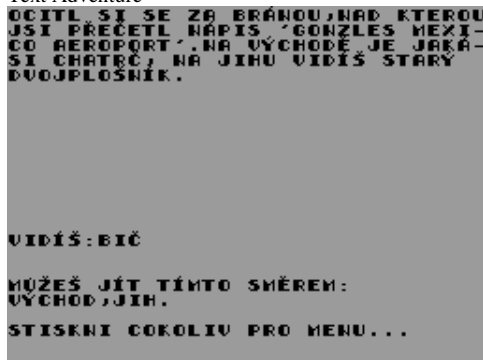

Tomahawk (Digital Integration,1985)
Simulation

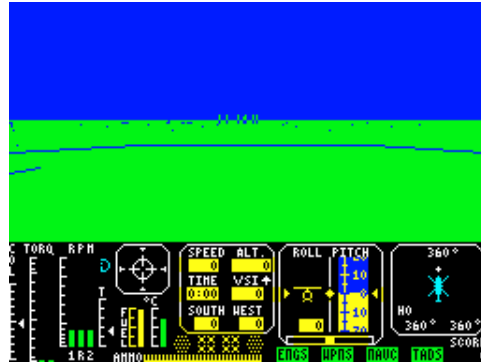

Tomb of Dracula, The (Felix Software,1983)
Text Adventure



Tombola (Dragan Soft,1987)
Board/Card Game

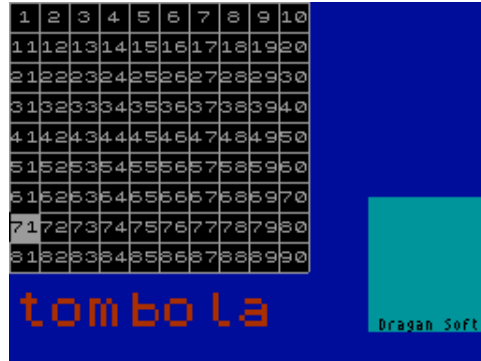

Tom Frost's Six Pack (Tartan Software,1988)
Compilation

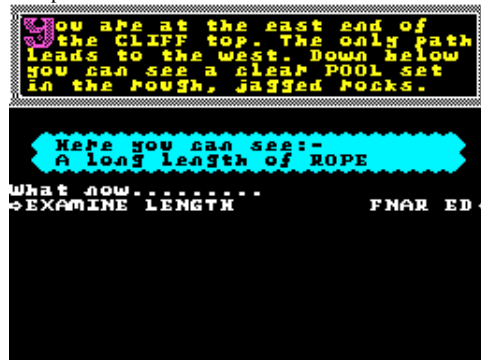

Tommy (Future Stars,1986)
Arcade Adventure



Tomato Catch-Up (Spectrum Computing,1984)
Arcade

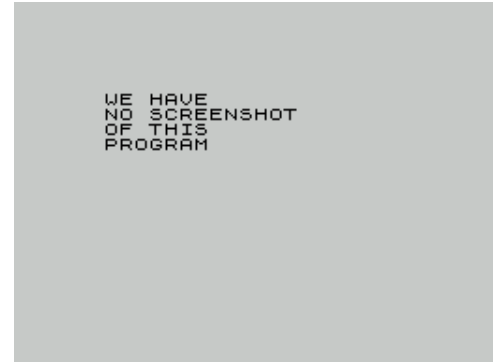

Tomb of Syrinx (The Power House,1987)
Arcade



Tombola (Ina,1986)
Board/Card Game

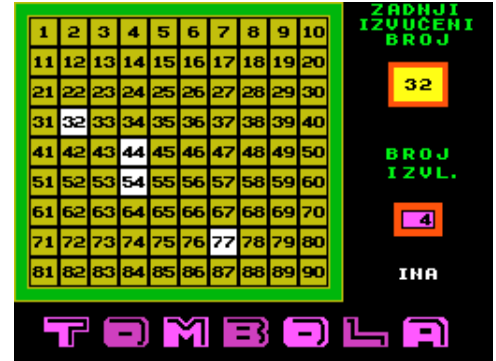

Tom & Jerry 2 (Magic Bytes,1989)
Arcade Adventure



Tom Pom Pom (MicroHobby,1985)
Arcade

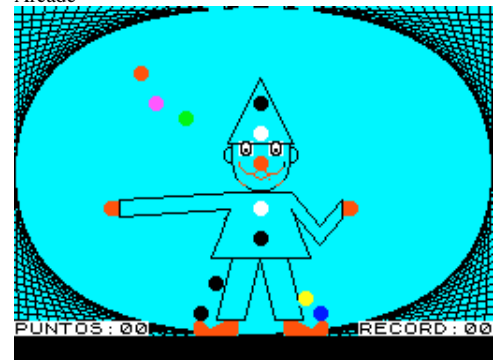

Toobin' (Domark Ltd,1989)
Arcade



Toolkit (Profisoft,)
Utility



Tootie Fruity (Dream Software Ltd,1983)
Arcade



Top By Topo 2 (Topo Soft,1991)
Compilation

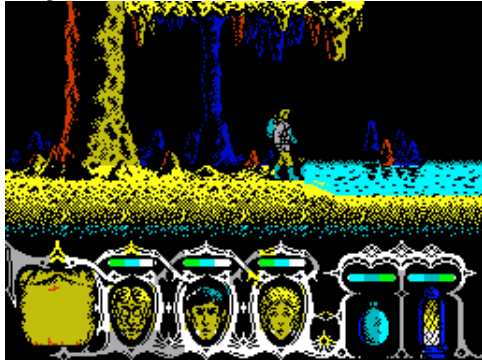

Top Dog (Hartland Software,1984)
Strategy



Toolkit (,)
Utility

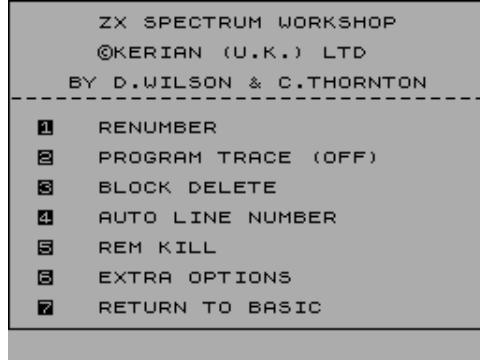

Toolman (SM Independant Software,1984)
Board/Card Game



Toot 'n' Come in (Epsilon Software,1987)
Text Adventure

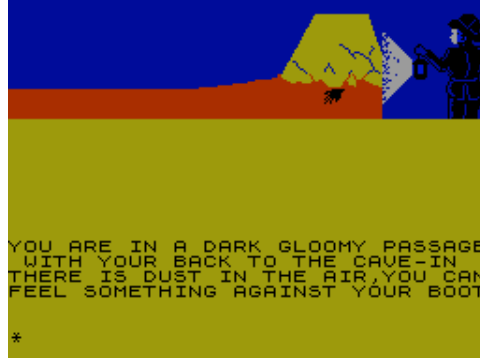

Top Cat in Beverly Hills Cats (Hi-Tec Software Ltd,1991)
Arcade

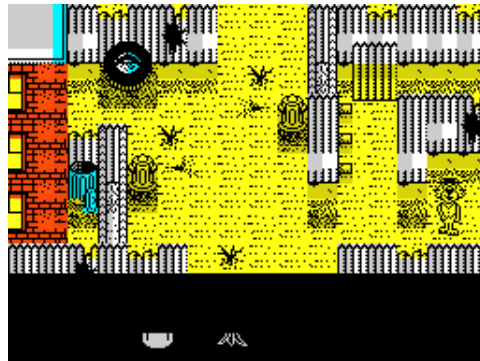

Top Fruitmachine, The (Your Sinclair,1991)
Simulation

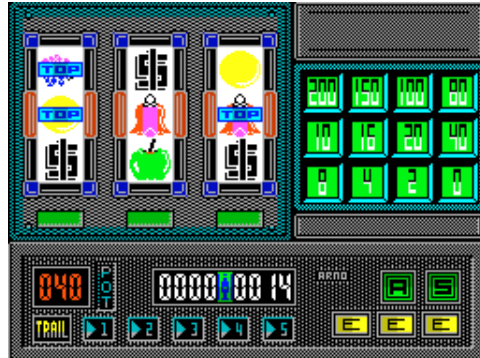

Tool Kit (Kerian UK Ltd,1984)
Utility

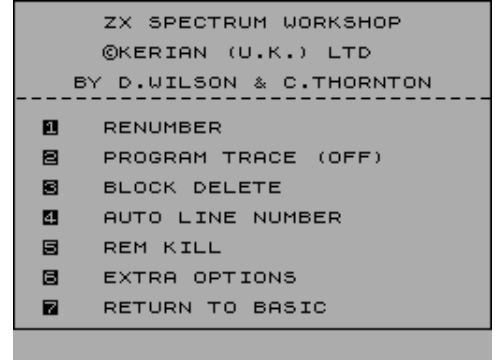

Toolman 2 (SM Independant Software,1987)
Board/Card Game

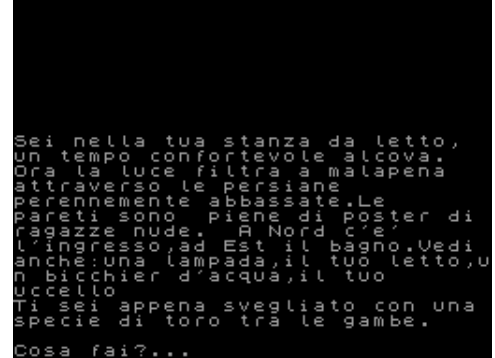

Top By Topo (Topo Soft,1989)
Compilation

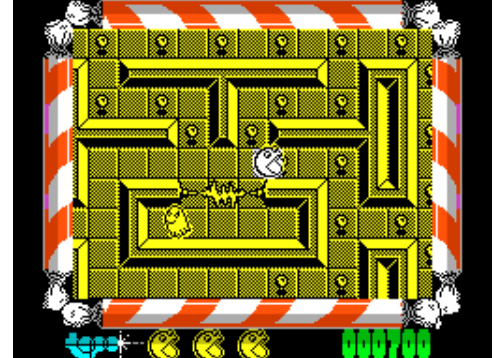

Topdog (Bosoft,1984)
Arcade



Top Gear: Crazy Cars 3 (U99,1999)
Arcade



Top Gun (Ocean Software Ltd,1987)

Simulation

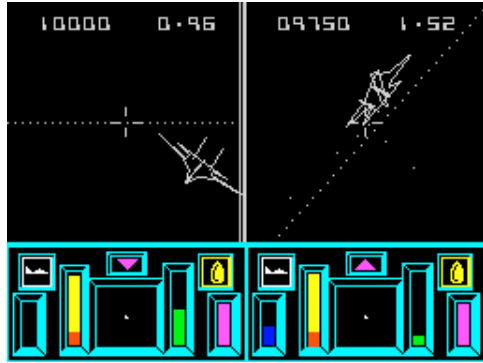

Top Secret (Load 'n' Run [Spa,])

Arcade



Tormozilka (Amaliya Inc,1999)

Board/Card Game

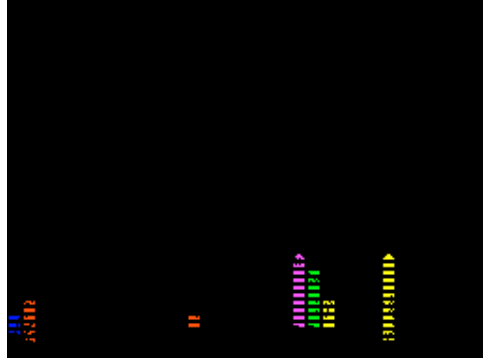

Torpedo (Laszlo Nyitrai,1998)

Arcade



Torres, Las (MicroHobby,1985)

Arcade



Topsail (Roelof Koning,1992)

Utility: Assembler/Disassembler/Monitor
Z80-disass. TOPS R.Koning '92
***** Control keys *****
[Alt] Hex/dec [Scroll]
[Go] Back [Printer]
[Enter] = next line
[Space] = abort
Startaddr: >



Top Ten Collection (Hit-Pak,1988)

Compilation

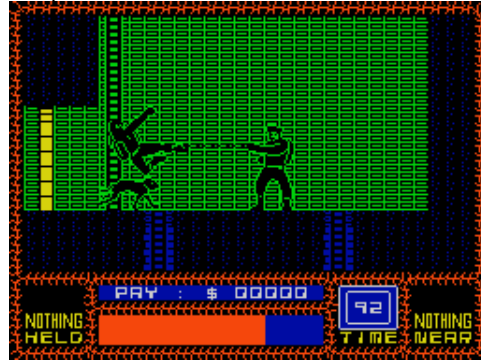

Tornado Assembler (Roelof Koning,1991)

Utility: Assembler/Disassembler/Monitor

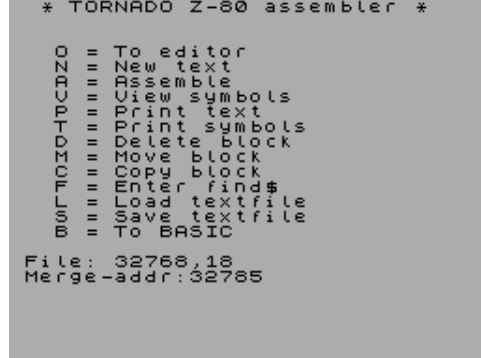

Torre Oscura, La (Alien Software,1993)

Text Adventure



Tortuga, La (MicroHobby,1985)

Arcade



Tops and Tails (Macmillan Software Ltd,1985)

Educational

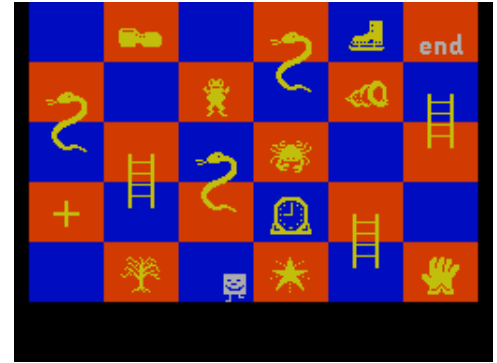

Torens van Hanoi (.)

Simulation

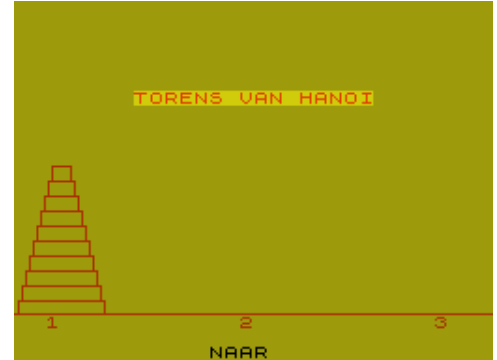

Tornado ECR (Code Masters Ltd,1991)

Arcade



Torres de Hanoi, Las (MicroHobby,1985)

Board/Card Game



Total (Erbe Software S.A.,1989)

Compilation

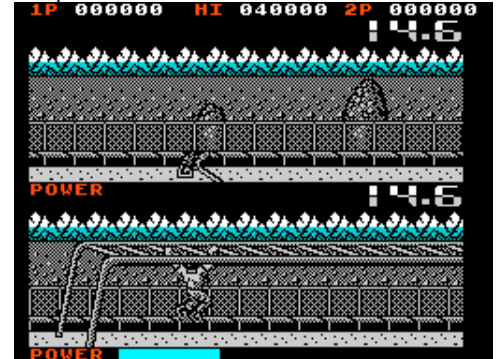

Total Eclipse (Incentive Software Ltd,1988)
Arcade



Total Eclipse's Talisman Demo (Total Eclipse,1991)
Scene Demo



Total Recall (Ocean Software Ltd,1991)
Arcade



Total War 2 (Thomas' Software,1992)
Text Adventure

Stojiš v koutě své cely. Hned před tebou jsou dveře, ty ovšem vypadají zamčené.

Vidíš : Dveře od cely

Můžeš jít : Na východ

Stiskni libovolnou klávesu!

To the Unknown Man (MicroHobby,1991)
Music

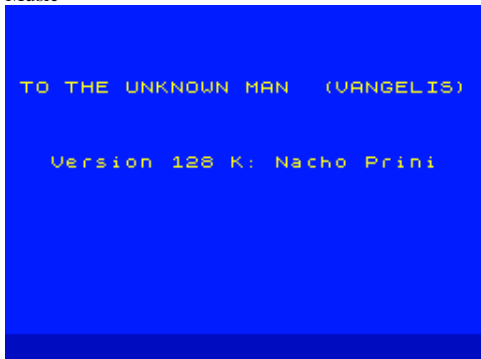

Total Eclipse + The Sphinx Jinx (Incentive Software Ltd,1989) Compilation



Total Reality Delusion (The Guild,1991)
Text Adventure

You're standing alone in a clearing in a strange wood. Wordless voices whisper faintly all around you and a teasing wind ruffles your hair with invisible hands. Exits lead North, East, South and West.

I'm waiting...

Total Recall Animation (Outlet Disk Magazine,1991)
Scene Demo



To the Manor Bourne (Central Solutions,1984)
Text Adventure

I am in the Main Entrance Hall. Gloomy dark oak panelled walls contrast a sweeping staircase leading upwards. Doors lead to the north and east.

I can see..
A LOCKED FRONT DOOR

What shall I do now?

Touchdown (D&H Games,)
Simulation

TEAM SELECTIONS LMTG=16 Week 1
Please select your offense.

QUARTERBACKS						
#	NAME	AGE	STR	FT	SPE	%
1	STARR	26	72	70	74	
30	McGEE	31	69	67	71	
3	SCHROEDER	33	72	70	74	

COLTS >> 30 63 64 63

QB RB RB OL OL OL OL OL WR WR TE

Total Eclipse 2: The Sphinx Jinx (Incentive Software Ltd,1989) Arcade

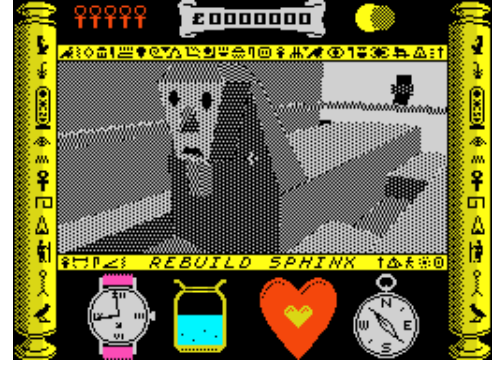

Total Reality Delusion + Warlock (The Guild,1991)
Compilation

You're standing alone in a clearing in a strange wood. Wordless voices whisper faintly all around you and a teasing wind ruffles your hair with invisible hands. Exits lead North, East, South and West.

I'm waiting...

Total War (Thomas' Software,1992)
Text Adventure

WE HAVE
NO SCREENSHOT
OF THIS
PROGRAM

To the Top (Your Computer,1985)
Arcade

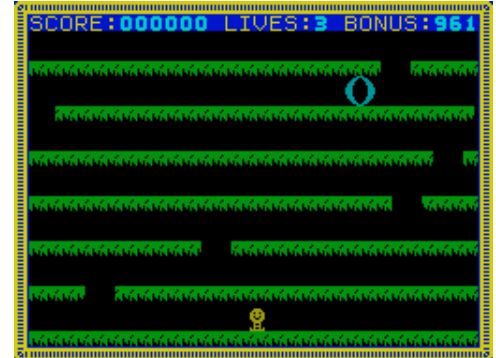

Touchdown on Mars (Virgin Books,1983)
Arcade

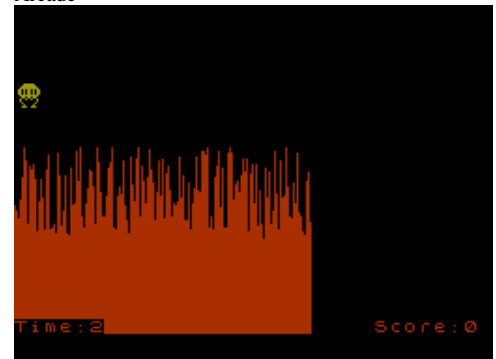

Touch Me (The Lords,)
Scene Demo



Tour de Force (Gremlin Graphics Software Ltd,1988)
Arcade



Tourist Trouble (ESP Software,)
Text Adventure

You are at a small oasis in the desert. All you can see here, is a bit of greenery. Exits lead South and East.
I can also see:-
water.

Tournament Tennis - Mens & Ladies (Lambourne Games,1992)
Strategy

1	2	3	4	PLAYER	S	G	P
5				HOAD	*	0	3 0
7				BORG		1	4 40

HOAD SERVES
2nd KICKING
BORG - ON THE BACKHAND
RETURNED
DOWN SIDELINES

Tower of Brahma (Precision Software Engineering,1983)
Arcade



Tour (MicroHobby,1985)
Arcade

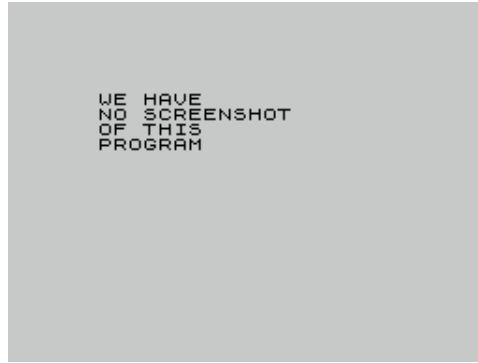

Tour de France (Loricels,1985)
Sport

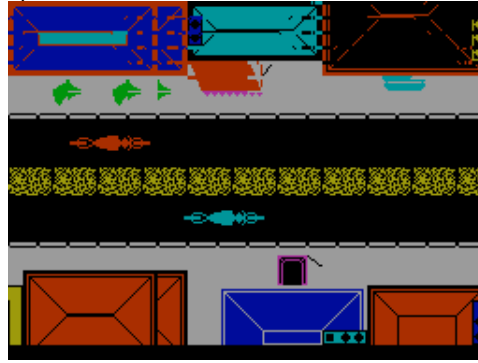

Tournament Snooker (Magnificent 7 Software,1986)
Simulation



Towdie (Ultrasoft,1994)
Arcade Adventure



Tower of Despair (Games Workshop,1984)
Text Adventure

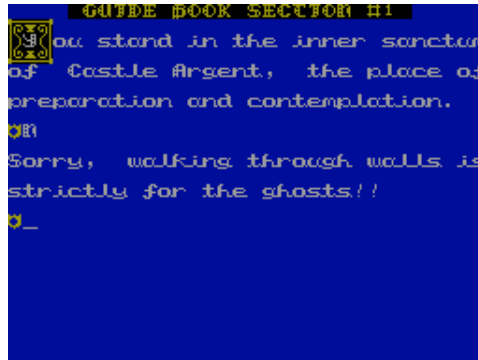

Tour 91 (Topo Soft,1991)
Sport

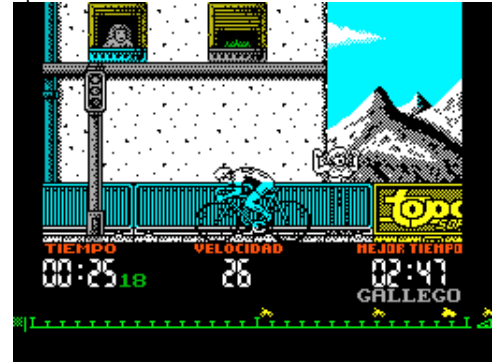

Tourist Trap (ZX Computing,1983)
Board/Card Game



Tournament Tennis (Lambourne Games,1992)
Strategy

1	2	3	4	PLAYER	S	G	P
				HOAD		2	40
				LENDL	*	1	30

LENDL SERVES
2nd SHORT
HOAD - ON THE FOREHAND
PASSING SHOT
WINNER

Tower of Benares (16/48 Tape Magazine,1984)
Board/Card Game



Tower of Evil (Creative Sparks,1984)
Arcade



Tower of Hanoi (Finsbury Software,1984)
Board/Card Game

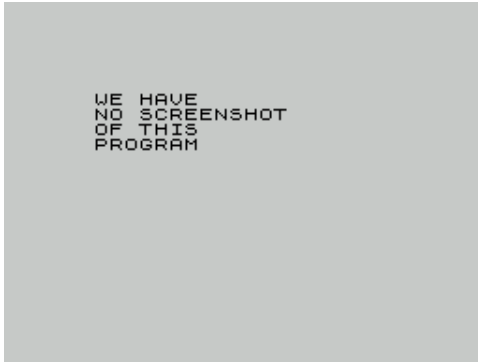

Tower of Hanoi (Shiva Publishing Ltd,1983)
Arcade



Tower of Hanoi (Sinclair Research Ltd,1982)
Arcade

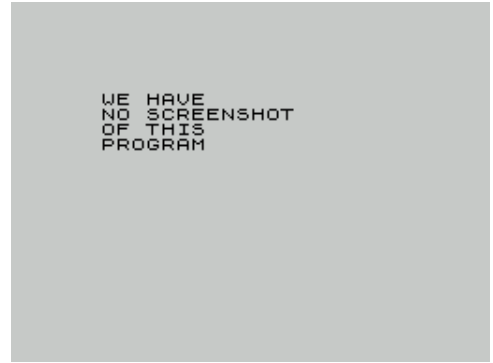

Tower of Hanoy (16/48 Tape Magazine,1985)
Simulation

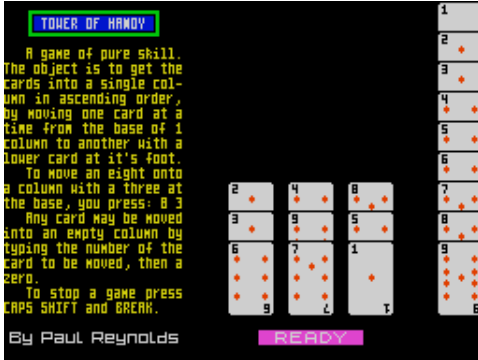

Tower of Light (Caris Software,1989)
Text Adventure



Tower of London (Newsoft Products,1982)
Arcade



Tower Pod (Studio Stall,1999)
Arcade

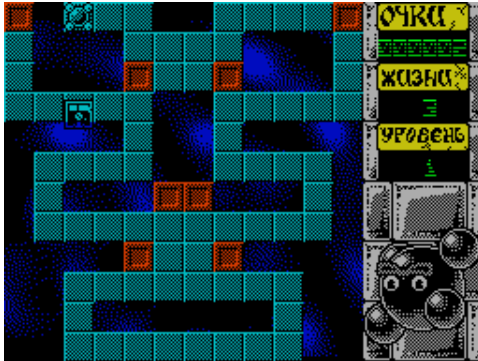

Toxi 15 (Busy Software,1996)
Scene Demo

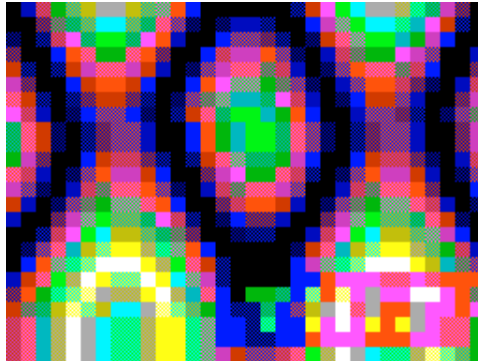

Toxic Elephant (Your Sinclair,1992)
Scene Demo



Toy Bizarre (Activision Inc,1985)
Arcade



Toyota Celica GT Rally (Gremlin Graphics Software Ltd,1991) Arcade

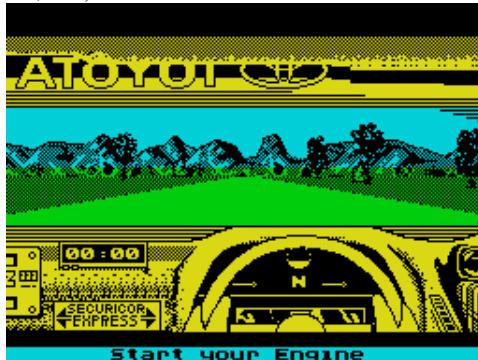

TR-32 (Darryl LeCount,1993)
Arcade

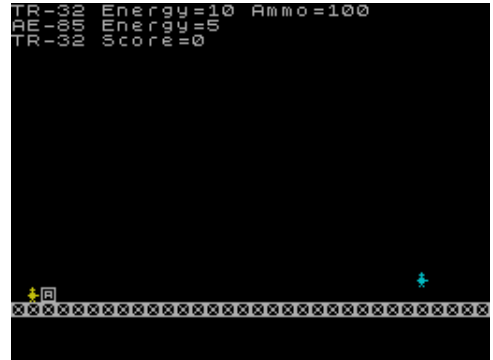

Trace (Texgate Computers Ltd,1983)
Utility: Programming

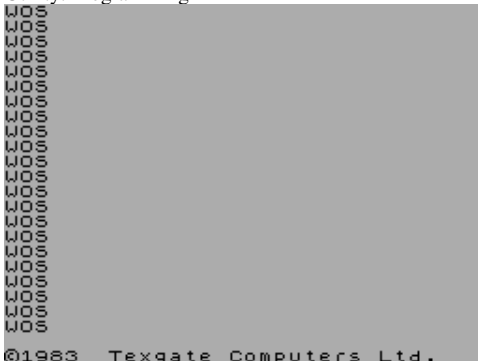

TRaceON (Work Force,1983)
Arcade

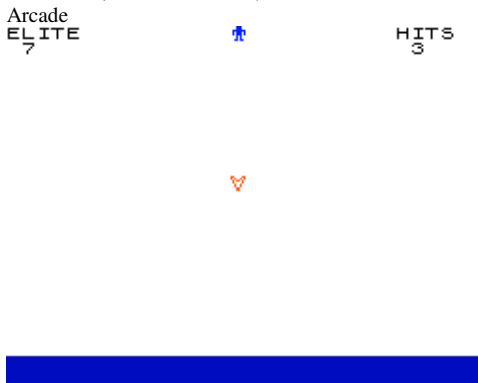

Tracer (Spectrum Computing,1985)
Utility



Trace Utility (Radio Student,1984)

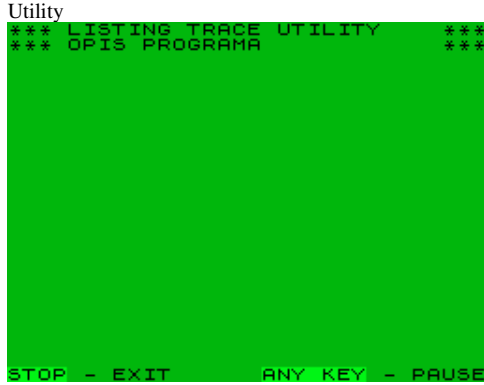

Trackbasher (Ashley Greenup,1988)



Track n Attack (Keyword Software,1982)



Trader (F. Shillito,1990)



Trading Game, The (Reelax Games,1986)



Track and Field (Ocean Software Ltd,1988)

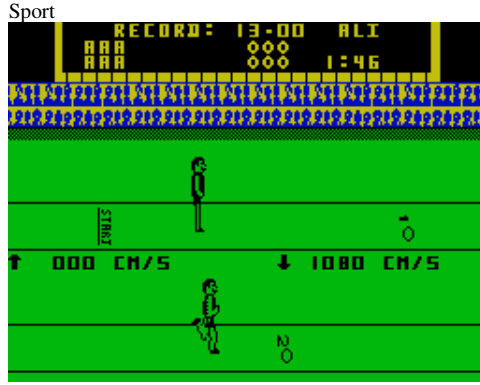

Trackmaster (Destiny Software,1988)



Track Suit Manager (Goliath Games,1988)

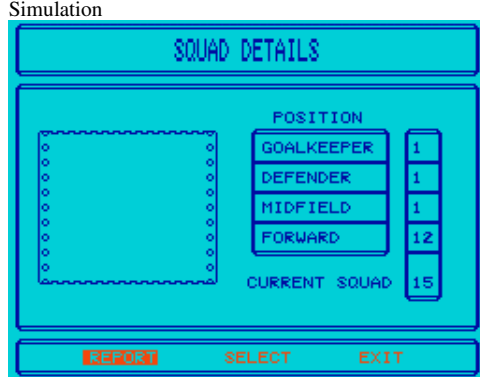

Trader Trilogy, The (Pixel Productions,1983)

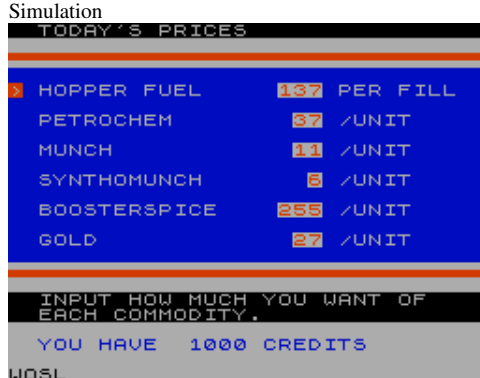

Traductor 3.0 (MicroHobby,1988)



Trackball (.)

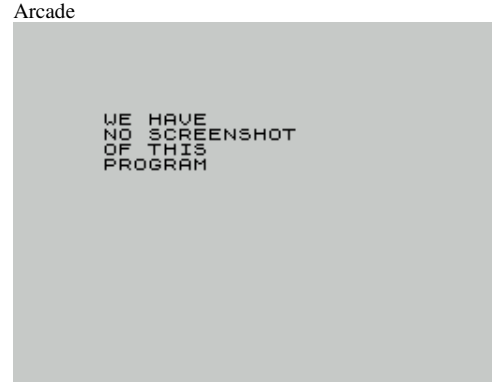

Trackmaster (Intraset Ltd,1991)



Track Trap (Virgin Books,1983)

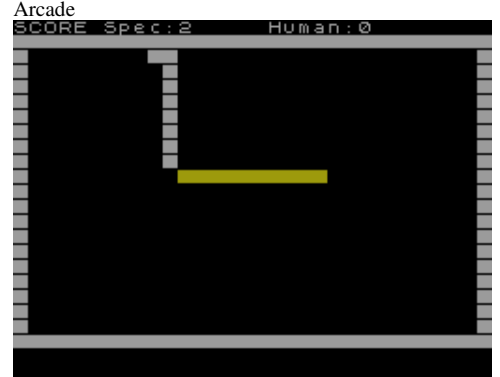

Tradewind (WD Software,1983)



Traductor de la Memoria (MicroHobby,1986)

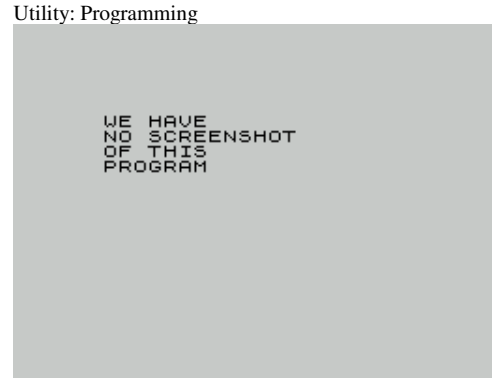

Traffic Control (Alchemist PD,)
Simulation



Trail (Pocket Money Software,1985)
Text Adventure

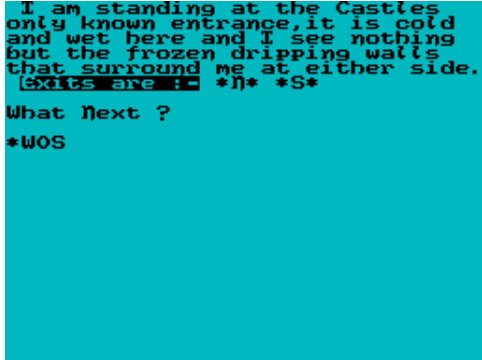

Trail Racer (Jorgen Bech,1987)
Arcade



Train Race (Sinclair Research Ltd,1982)
Arcade



Tramping (MicroHobby,1986)
Arcade



Tragaldba (Microparadise Software,)
Utility: Copier



Trailblazer (Gremlin Graphics Software Ltd,1986)
Arcade



Train: Escape to Normandy, The (Electronic Arts,1988)
Arcade

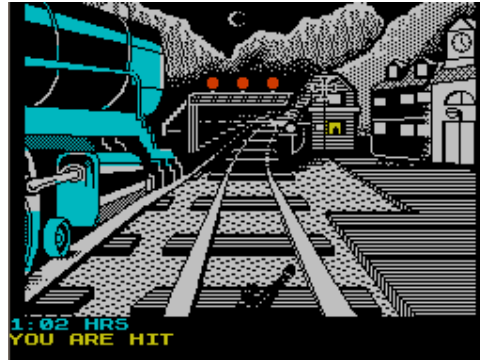

Tramas (MicroHobby,1985)
Board/Card Game

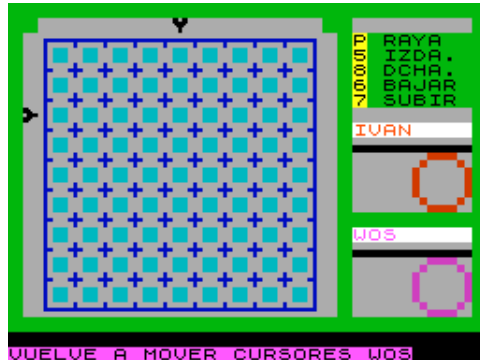

Trance (Program Software,1984)
Arcade

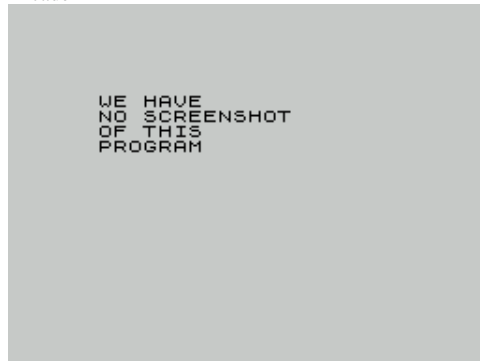

Traga-Perras (Gabriel Rodriguez Calzada,1996)
Simulation

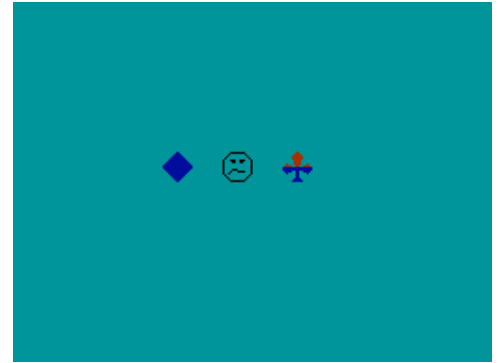

Trailer 2 (Your Sinclair,1993)
Arcade

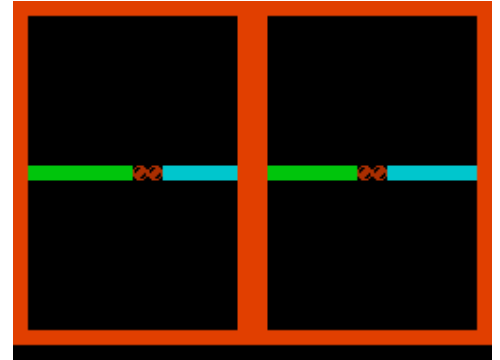

Train Game, The (Microsphere,1983)
Simulation

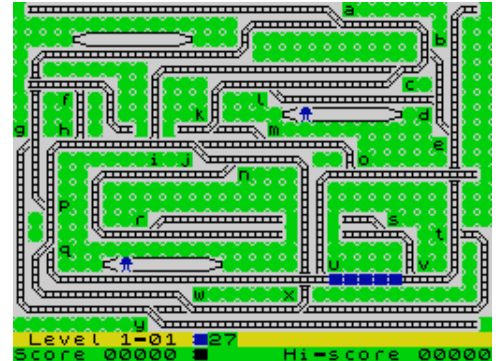

Tramix (DK'Tronics Ltd,1983)
Arcade



Trans-Atlantic Balloon Challenge (Virgin Games
Ltd,1987)
Arcade



Trans-Europe Rally (ABC Soft,1984)
Arcade

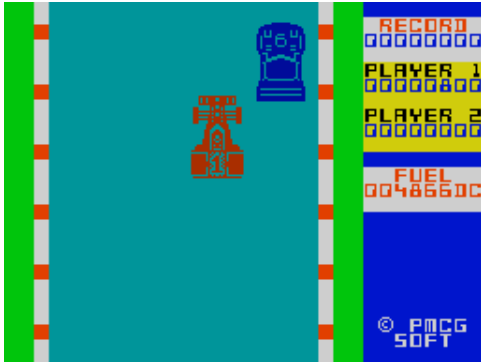

Trans-Express 85.2 (Romantic Robot UK Ltd,1985)
Utility: Copier



Transfer (MicroHobby,1985)
Arcade



Trans-Former (ACS Software,1985)
Utility



Translate Words (Znahr,2004)
Educational

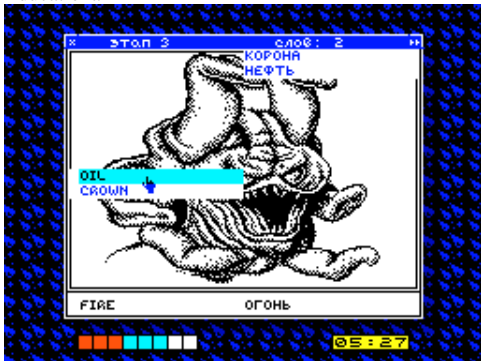

Trans Express (MicroHobby,1986)
Arcade

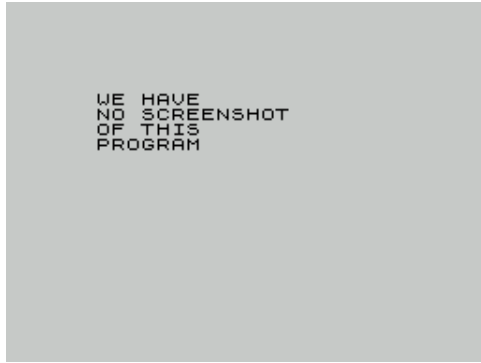

Trans-Express Tape to Cartidge (Romantic Robot UK Ltd,1985) Utility: Copier



Transfer +3 (Topo Soft,)
Utility: Copier



Transformers, The (Ocean Software Ltd,1986)
Arcade

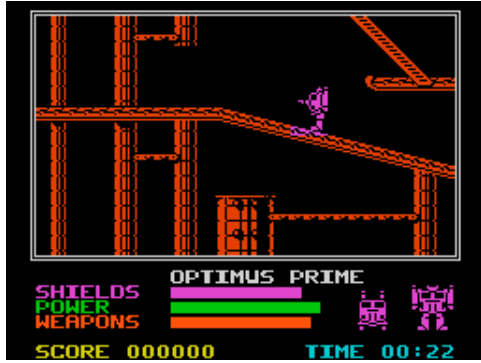

Translator (MicroHobby,1985)
Utility

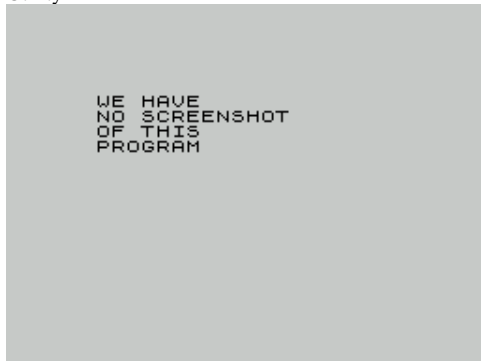

Trans-Express (Romantic Robot UK Ltd,1984)
Utility: Copier



Trans-Express - Tape To Microdrive (Romantic Robot UK Ltd,1985) Utility



Transferencia Rapida de Pantallas (MicroHobby,1985)
Utility



Transistorberechnung (Ing. Kurt,1984)
Utility: Electronics

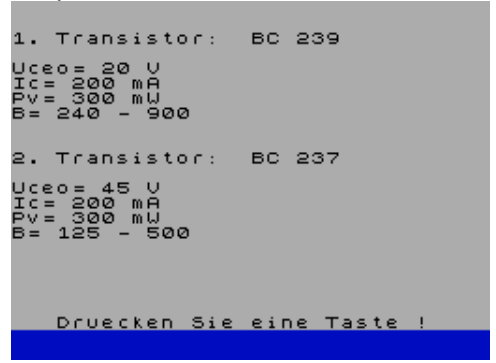

Transmat (Video Showcase,1984)
Arcade

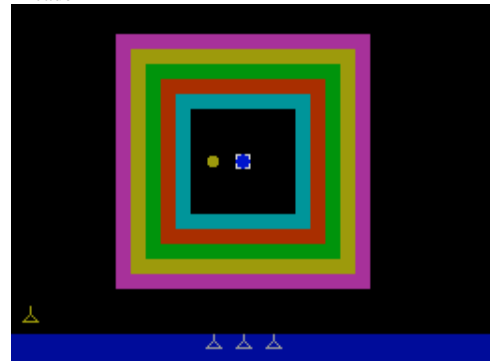

Transmate (16/48 Tape Magazine,1984)
Arcade

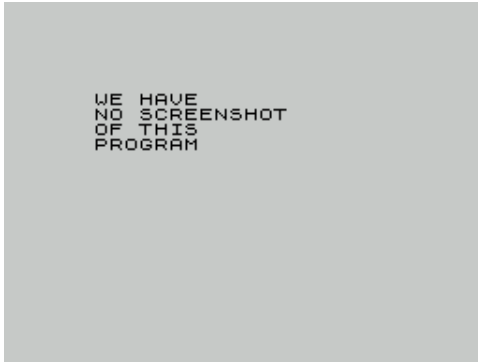

Transmission Morse (Ediciones y Textos S.A.,1985)
Utility



Transmuter (Code Masters Ltd,1987)
Arcade



Trans-Pennine Express (Dee-Kay Systems,)



Transpo '95 (The Adventure Workshop,1996)



Transtuctor (Beto,1987)

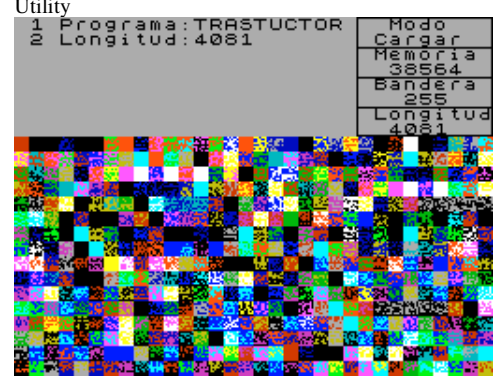

Transversion (Ocean Software Ltd,1984)



Transylvanian Tower (Richard Shepherd Software Ltd,1982)

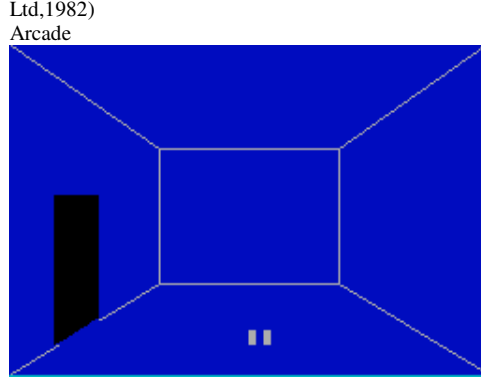

Trantor: The Last Stormtrooper (Go!,1987)



Tranz Am (Ultimate Play The Game,1983)



Trap (Alligata Software Ltd,1987)

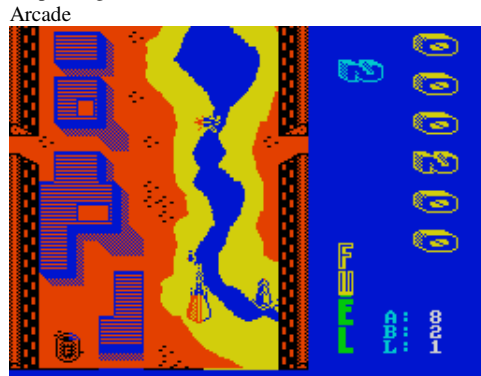

Trap Door + Through the Trap Door (Alternative Software Ltd,1987) Compilation



Trap Door, The (Piranha,1986)



Trapper (Fontana Publishing,1984)

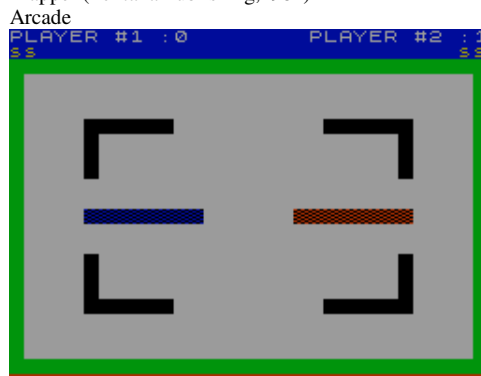

Trash-E (E-Mage,1996)

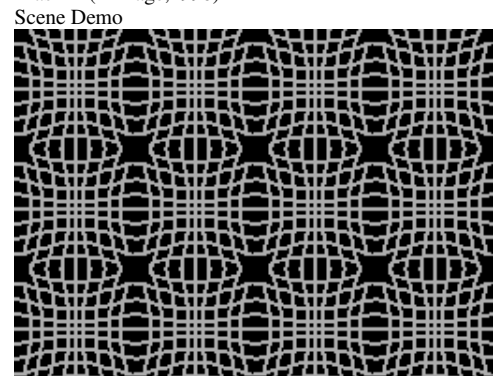

Trashman (New Generation Software,1984)

Arcade



Trasochin (Thomas' Software,)

Text Adventure

```
Stojíš jako opášený na svém W.C.
Ti saouci z RESET FORCE ti strčí-
li hlavu do misy a zamkli tě. No
prostě hrůza!

Vidiš : Záchodovou mísu
        Obrázky
        Dveře

Můžeš jít : Nikam!

Stiskni libovolnou klávesu!
```

Travelling Salesman Problem (Hartland Software,1984)

Strategy



Trax (Soft Joe's Software,1983)

Arcade



Traz (Game Busters,1989)

Arcade

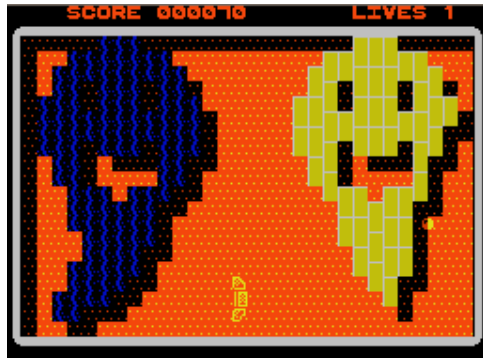

Traskskatten (Softed,1987)

Text Adventure

```
Jag är på en stig vid en flod
som rinner förbi öster om mej.
Någon kilometer söderut kan jag
se en sjö, och norrut fortsätter
stigen mot en liten äng. Det går
också en väg åt väster som leder
in i en skog.

Ge mej nya kommandon.
>
```

Traveller's Tales (Zenobi Software,1993)

Compilation

```
You are currently standing
beside a small spinney of oak
trees on the road that winds its
way south to Castle Malekin and
north towards the villages of
Finvarra and Dunatis.

The traveller was not able to
understand any of that. Please
try again.

What next, Traveller ?
>I DONT CARE
You have with you:
a PAIR OF LEATHER BOOTS (worn)
a BLACK ROBE (worn)
a RAZOR-SHARP KNIFE

What should you do now?
>BOOTS AND A ROBE... YOU FASHION
DISASTER, YOU...$
```

Travel with Trashman (New Generation Software,1984)

Simulation

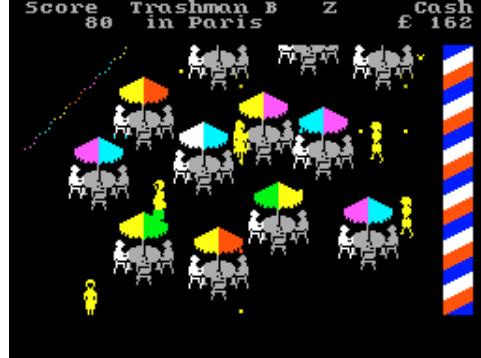

Traxx (Quicksilva Ltd,1983)

Arcade



Treachery (C&VG,1984)

Strategy



Tras la Venta del Cuadro (Palamar Software,2006)

Text Adventure

```
Has tras los pasos de Rosa ya
que los conoces bien por
haberla seguido otras veces.
Mientras caminas te encuentras
con el guitarrista del andén
que te pide, como de costumbre,
unas monedas

LE DAS LAS MONEDAS (TIPEA 300)
LO IGNORAS (TIPEA 350)
REGRESAS A LA OFICINA (TIPEA 60)
```

Traveller, The (Double Play Adventures,1984)

Text Adventure

```
You are in the main control room
of your time ship, in the centre
of the room is the control panel
EXIT: W
You can also see:-
The closed doors.
>KEY
What are your instructions?
>
```

Traverse (X Software,1988)

Arcade



Traxxion (CRL Group PLC,1987)

Arcade



Treasure (Andromeda Inc.)

Arcade



Treasure (Fernleaf Educational Software,1986)
Educational

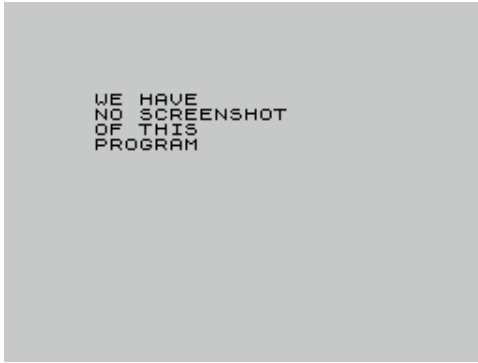

Treasure (The Guild,1986)
Text Adventure

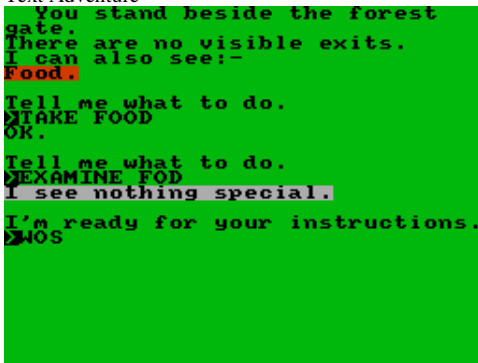

Treasure Hunt (Macsen Software,1986)
Text Adventure



Treasure Island (Mr. Micro Ltd,1984)
Arcade



Treasure of Meathos (J. Copland,1985)
Text Adventure



Treasure (Jeroen Kwast,1984)
Arcade



Treasure Chests (Cowl Systems,1988)
Arcade



Treasure Hunt Tool-Kit (G.W. Components UK Ltd,1984)
Utility



Treasure Island (River Software,1991)
Text Adventure

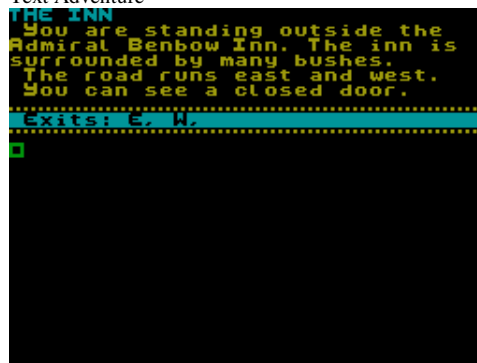

Treasure of the Santa Maria, The (Zenobi Software,1991)
Text Adventure

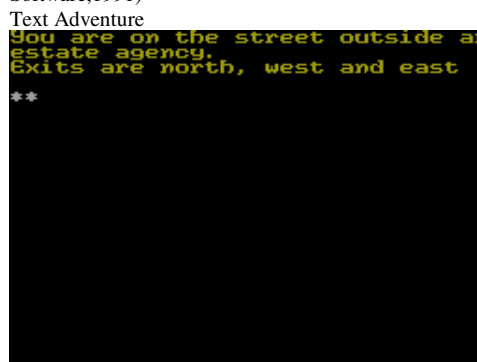

Treasure (Sirius Group,1996)
Arcade



Treasure Hunt (Amba Software,1983)
Arcade

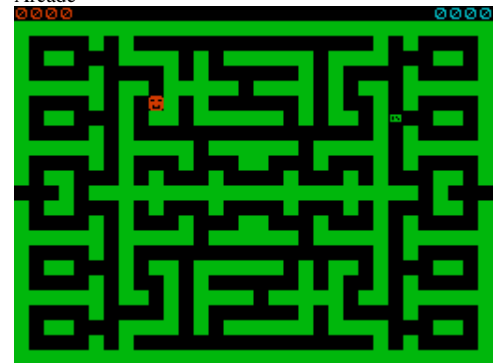

Treasure Island (Granada Publishing,1983)
Arcade

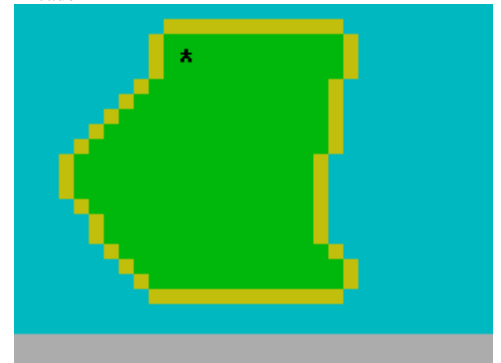

Treasure Island Dizzy (Code Masters Ltd,1988)
Arcade



Treasure Trail (J. Theakston/S. Richards,)
Arcade



Treble Champions (Challenge Software,1989)
Simulation

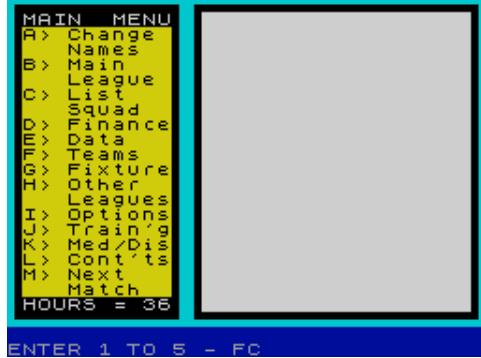

Tree Stones, The (The Guild,1987)
Text Adventure



Tres en Raya (Ediciones y Textos S.A.,1985)
Board/Card Game



Trevor Brooking's World Cup Glory (Challenge Software,1990) Simulation



Trial of Arnold Blackwood, The (.)
Text Adventure



Treble Chance (E&J Software,1989)
Simulation



Tremor (Americana Software Ltd,1986)
Arcade



Tres en Raya (MicroHobby,1985)
Board/Card Game



Tria (Sybilsoft,1987)
Text Adventure

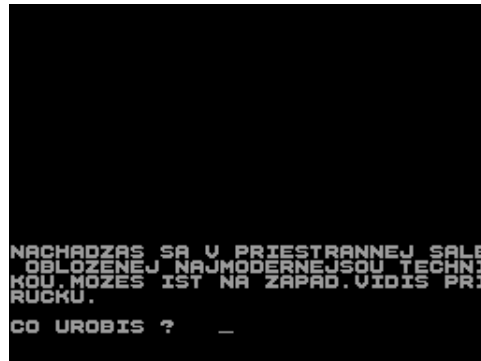

Trials of Kronos, The (SDL Adventures,)
Text Adventure



Tree Eaters (Sinclair Programs,1984)
Arcade



Tren 8 (.)
Arcade



Tres Luces de Glaurung, Las (Erbe Software S.A.,1986)
Arcade



Triad (Amba Software,1983)
Compilation

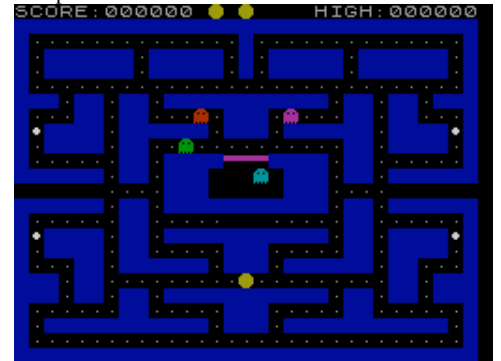

Triangl (Megasoft [3],1985)
Utility: Mathematics

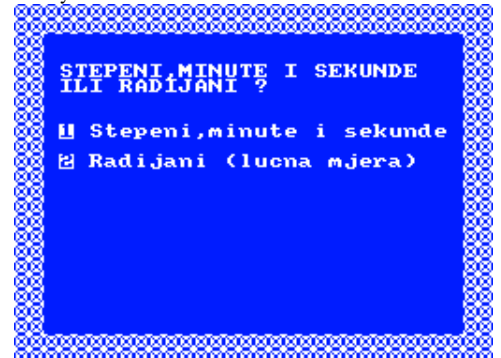

Triangulo, El (MicroHobby,1986)
Arcade



Tribble Trubble (Software Projects Ltd,1984)
Arcade



Trick of the Tale, A (Central Solutions,1986)
Arcade



Trigger (Opera Soft S.A.,1989)
Arcade



Trinia (Romas,1996)
Board/Card Game



Triasun 2 (Mirage,1989)
Scene Demo



Tribe, The (Fontana Publishing,1984)
Strategy



Trick Ramp Crazy (Firebird Software Ltd,)
Arcade



Trigonometria (Boalox Informatica.)
Educational



TriNitroToluene (The President,1992)
Scene Demo



Triaxos (39 Steps,1987)
Arcade Adventure



Triblox (Mike Dowman,1993)
Board/Card Game

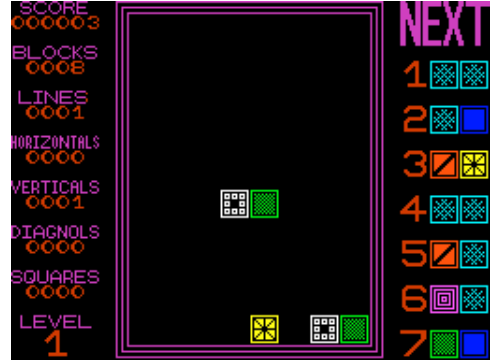

Trifidos (MicroHobby,1985)
Arcade



Triller (DJ Television,)
Scene Demo

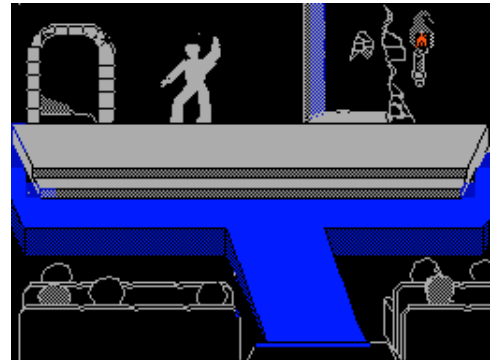

Trio (Hit-Pak,1987)
Compilation

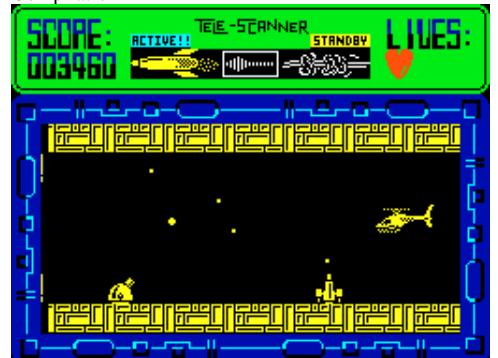

Trio (Silicon Joy,1985)
Compilation

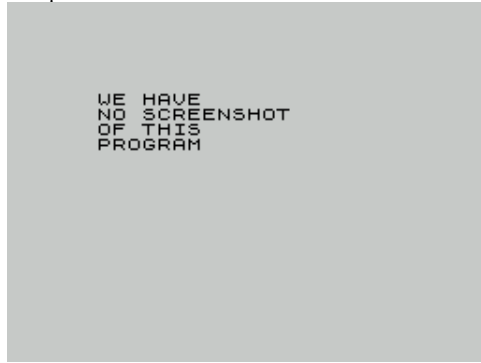

Trio (Sparklers,1985)
Compilation



Trip (Icabod,1993)
Scene Demo

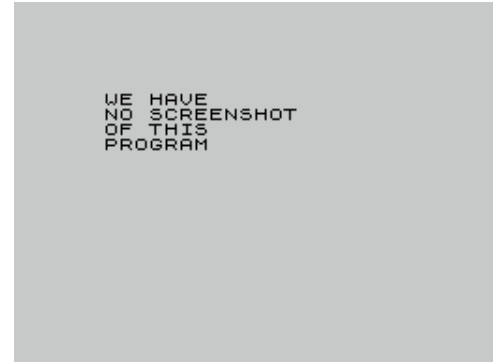

Triple Comando (Dro Soft,1987)
Arcade



Triple Crown Quiz, The (Sport And Racing Software,1985)
Board/Card Game

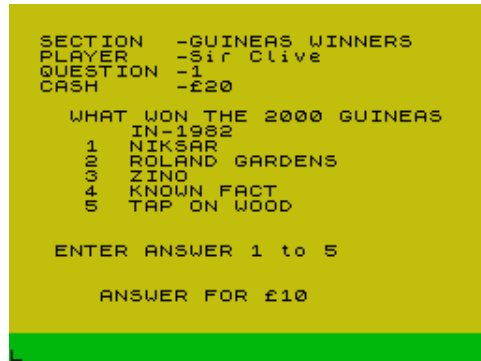

Triple Decker 1 (Alternative Software Ltd,1987)
Compilation



Triple Decker 2 (Alternative Software Ltd,1987)
Compilation



Triple Decker 3 (Alternative Software Ltd,1987)
Compilation



Triple Decker 4 (Alternative Software Ltd,1987)
Compilation



Triple Pack, The (Leisure Genius,1990)
Compilation



Triplet (Wizard Software,1983)
Compilation



Triplets (Nick Phillips,1985)
Board/Card Game



Triplex (Work Force,1983)
Arcade

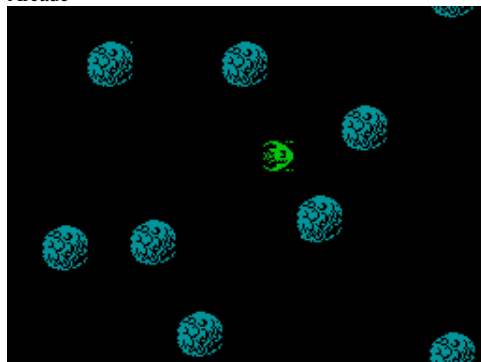

Triple Yathzee (E.J. Zwart,1985)
Board/Card Game

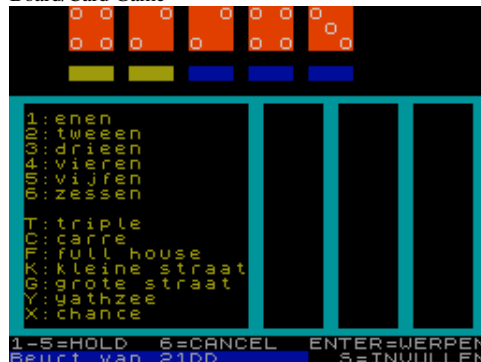

TriPods, The (Red Shift Ltd,1985)
Arcade Adventure



Trisom-Compiler 100.01 (Aackosoft,1984)

Utility: BASIC Related

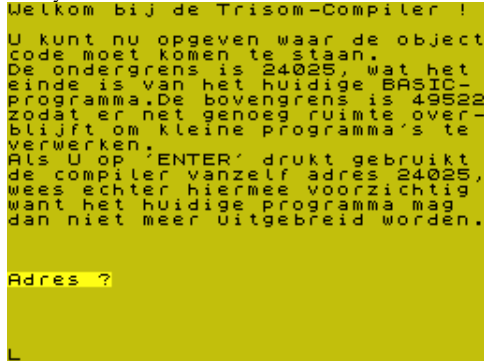

Tritz (CRL Group PLC,1984)

Board/Card Game

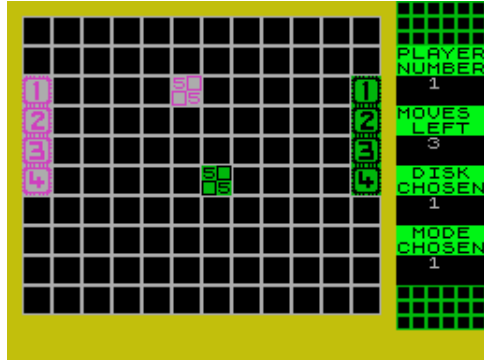

Trivia 2000 (Ramex International Ltd,1986)

Board/Card Game



Trivial Pursuit: Baby Boomer Edition (Domark Ltd,1986)

Board/Card Game



Trixie's Quest (Arthur Simmons,)

Text Adventure

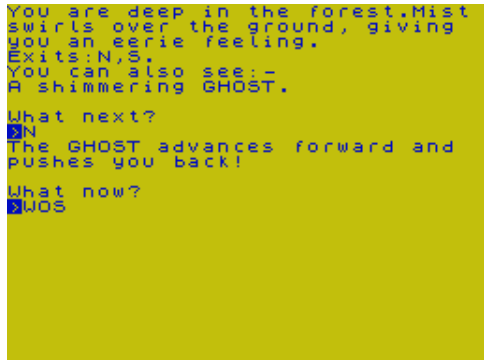

Trisp (Megasoft [3],1985)

Utility: Electronics

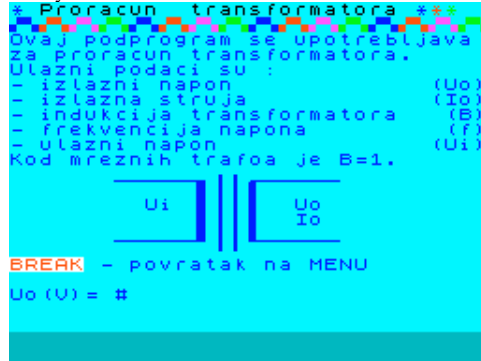

Trivia (Bartle Electronics,1986)

Board/Card Game



Trivial Fruit (Pirate Software Ltd,1987)

Board/Card Game



Trivial Pursuit: Young Players Edition (Domark Ltd,1987)

Board/Card Game



Trog (Macronics Systems Ltd,1983)

Arcade



Triton Mix (Spectravision,1995)

Scene Demo



Trivia: The Ultimate Quest (Grandslam Entertainments Ltd,1989)

Board/Card Game



Trivial Pursuit (Domark Ltd,1986)

Board/Card Game



Trivial Pursuit 2: A New Beginning (Domark Ltd,1988)

Board/Card Game



Troglodita (MicroHobby,1985)

Arcade



Trojans (Elite Systems Ltd.)
Arcade

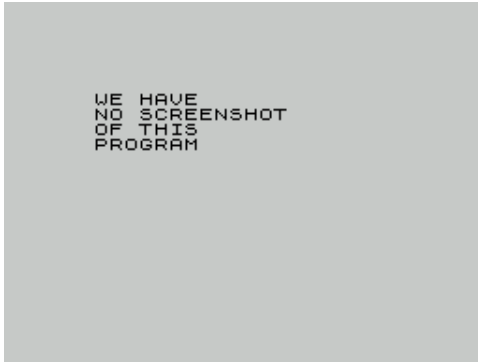

Troka (Cibercomp S.A.,1984)
Board/Card Game



Troll (Kixx,1988)
Arcade

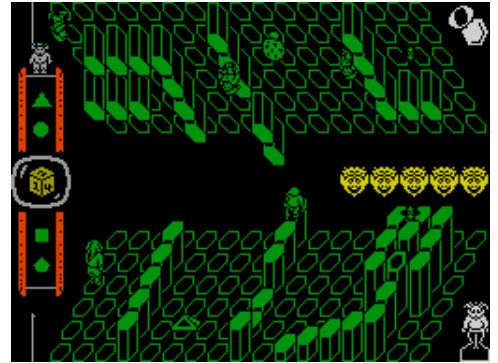

Trollkarlens slott (Dentan Software Ltd,1984)
Text Adventure



Trom (DK'Tronics Ltd,1983)
Arcade

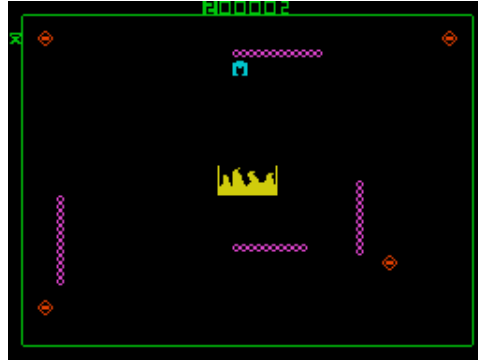

Tron (.)
Arcade

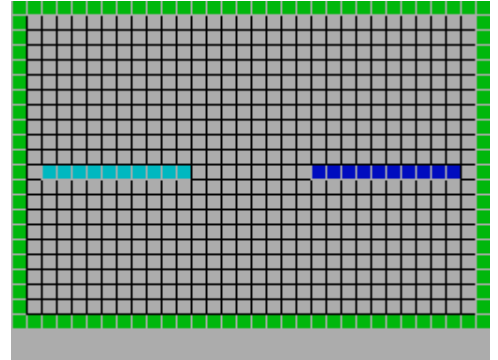

Tron (Blaby Computer Games,1984)
Arcade

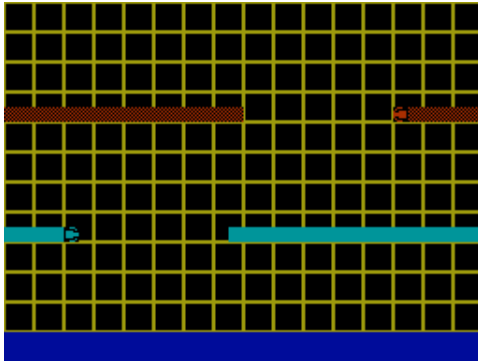

Tron (C. Knight,)
Arcade

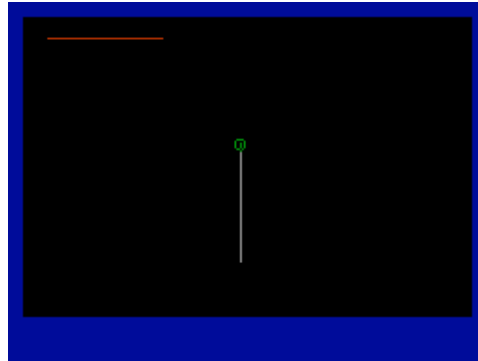

Tron (EMM Software,1983)
Arcade

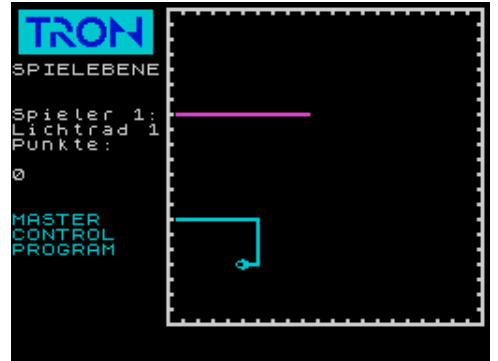

Tron (P.N. Software,1984)
Arcade



Tron (Werner Spahl,1983)
Arcade

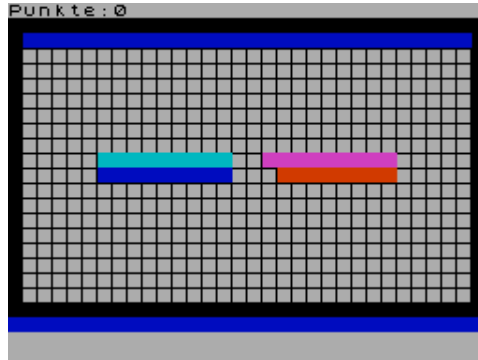

Tron [1] (MicroHobby,1985)
Arcade



Tron [2] (MicroHobby,1985)
Arcade



Tron [3] (MicroHobby,1986)
Arcade

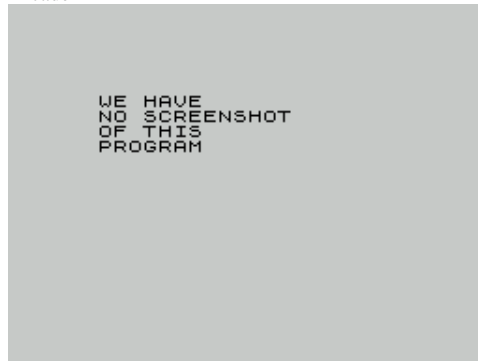

Tronn (.)
Arcade

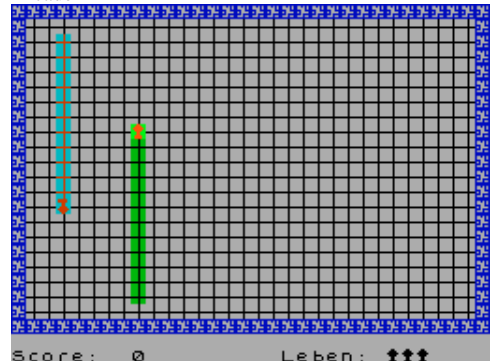

Tronn 2 (.)
Arcade

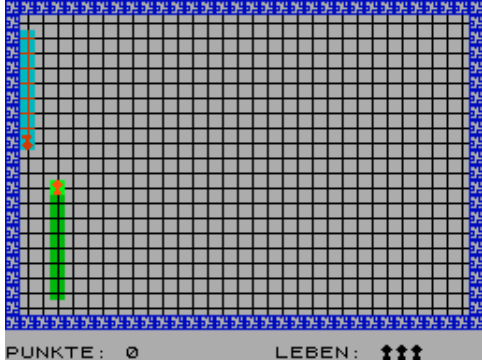

Trouble at Bridgeton (The Adventure Workshop,1991)
Text Adventure



Trubes (Panc Software,1996)
Arcade

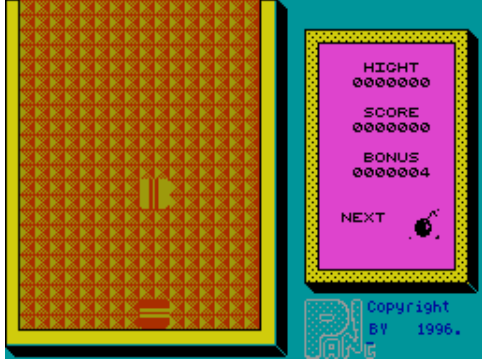

Trudnaya Doroga (Blacksoft,1989)
Text Adventure



TT Racer (Digital Integration,1986)
Arcade



Tronn 3 (.)
Arcade

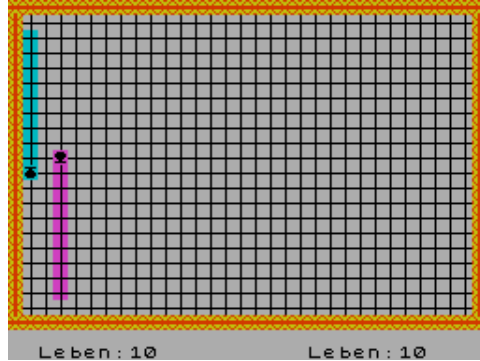

Trouble Brewin' (Silversoft Ltd,1984)
Arcade

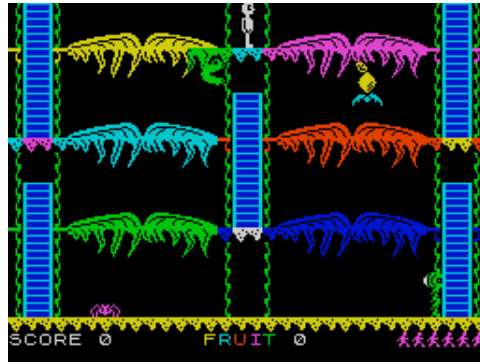

Trubis (Sunny Tram,1995)
Board/Card Game

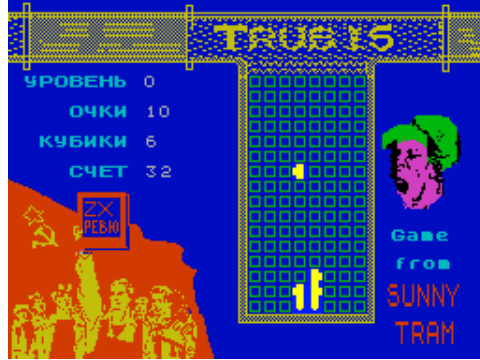

Trun (Popular Computing Weekly,1984)
Arcade

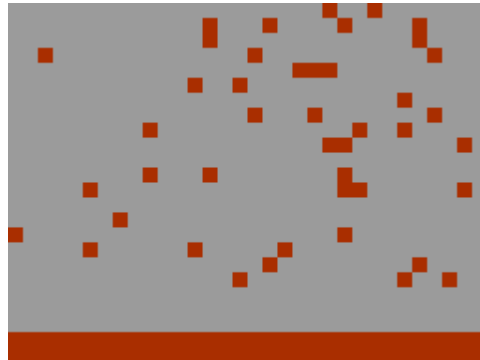

TT Racing Simulator (The Power House,.)
Arcade

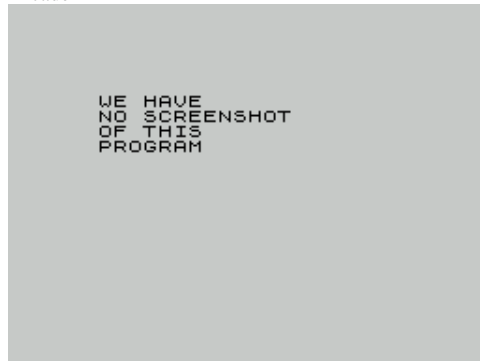

Troon (Hornby Software,1983)
Sport

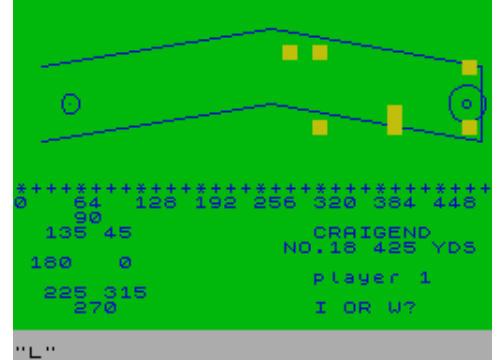

Trouble with Trolls (Zenobi Software,1996)
Text Adventure



Truck Race (Brian Fitton,1985)
Simulation



Tsifromania (Cyber Team/Area Soft,1998)
Board/Card Game



TT-S (Timedata Ltd,1984)
Utility: Programming

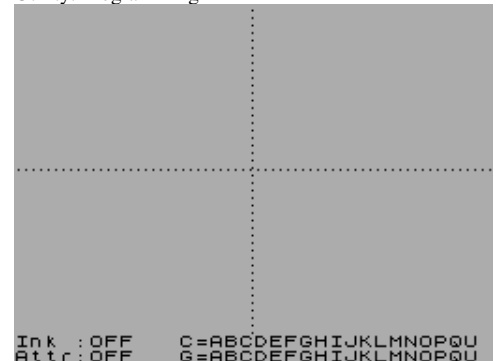

Tuareg (MicroHobby,1986)
Arcade

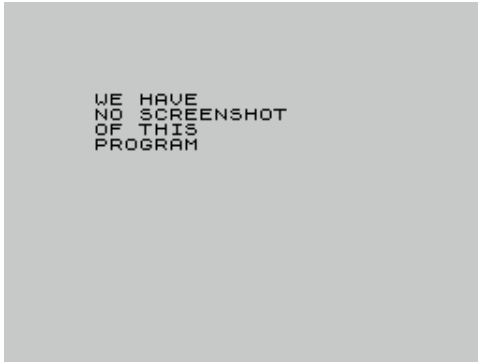

Tube Cube (ASP Software Ltd,1983)
Simulation



Tube Train Terror (JRS Software Ltd,1983)
Arcade

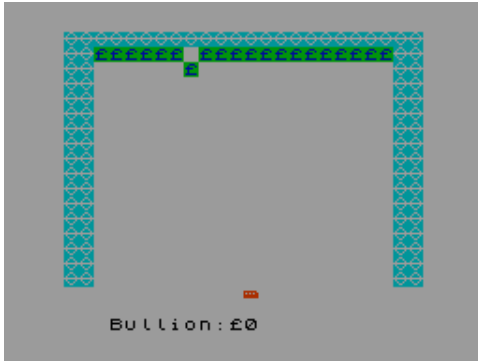

Tuck Shop (Magic Software,1985)
Simulation



Tujad (Ariolasoft UK Ltd,1986)
Arcade

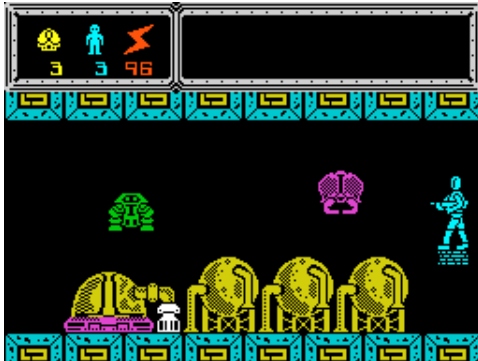

Tuareg (Topo Soft,1988)
Arcade

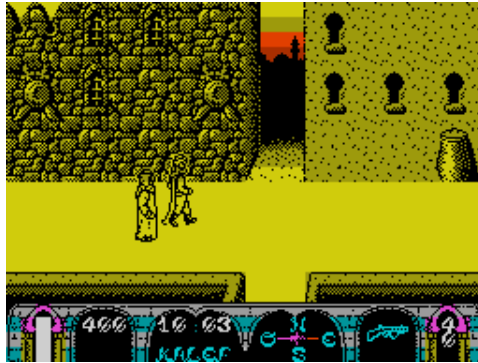

Tube Mix (THD,1993)
Board/Card Game

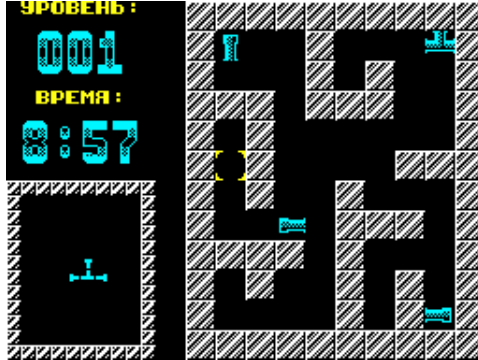

Tubewar (Your Computer,1983)
Arcade

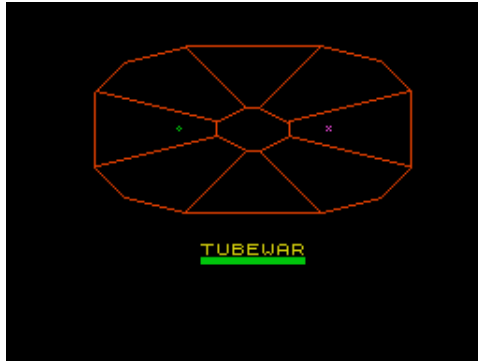

Tuerme von Hanoi (Omega-Soft,1983)
Simulation



Tuma 7 (Delta Software,1990)
Arcade



Tubaruba (Firebird Software Ltd,1987)
Arcade

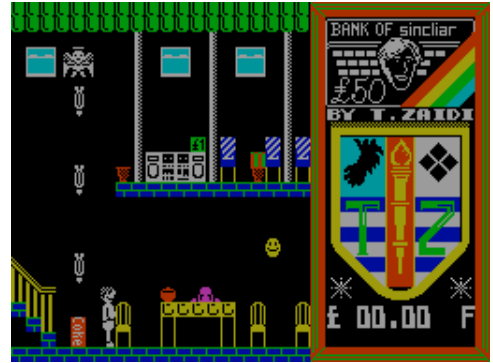

Tube, The (Quicksilva Ltd,1987)
Arcade



Tubular Bells (Ignacio Prini Garcia,1988)
Music



Tuetenvolumen-Interpolation (Claus Jahn,)
Utility



Tu Micro issue 01 (Ingelek Jackson,1985)
Covertape



Tumler (Viking Software,1983)
Arcade

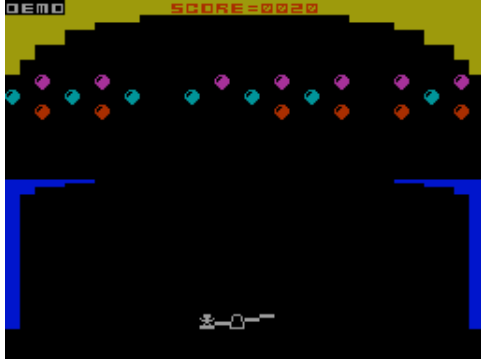

Tuner (Software Cottage,1983)
Educational



Tunnel Adventure (.)
Text Adventure

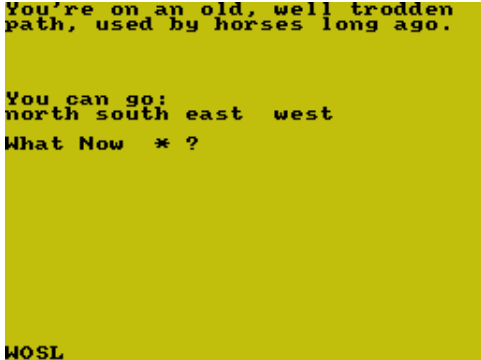

Tupichok (Systematic,1996)
Arcade

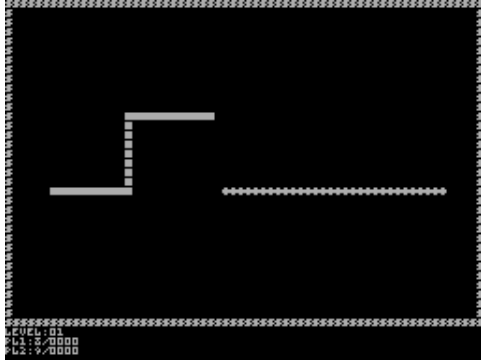

Turbo 1 (Galaksija,1983)
Utility: Database

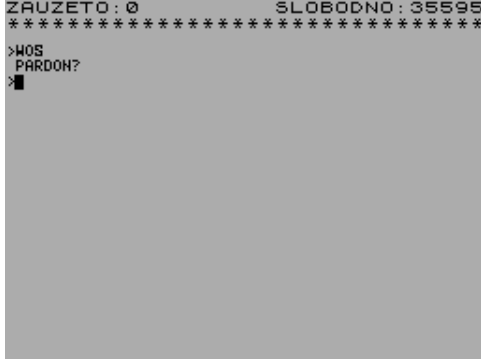

Tuneles Marcianos (Ventamatic,1983)
Arcade



Tunnel, 3D (New Generation Software,1983)
Arcade

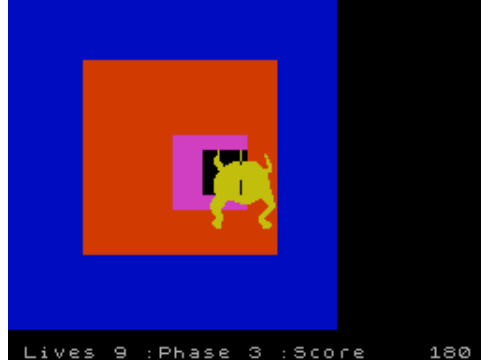

Tunnel Raider (.)
Arcade

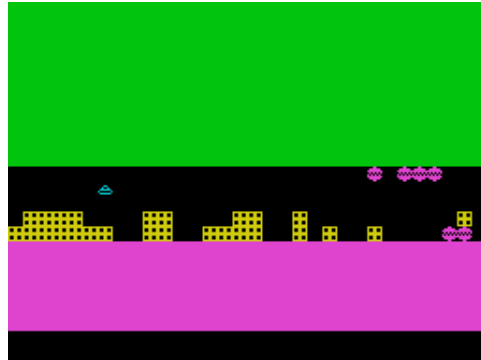

Tupik (KYO Corp,1996)
Arcade



Turbo Accounts (Robtek,1986)
Utility



Tuneller Raider 2079 (VTS,2002)
Arcade

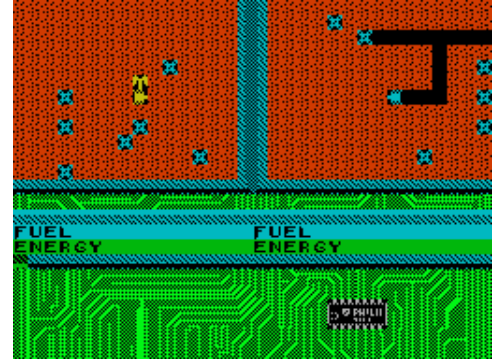

Tunnel 4K (,1998)
Scene Demo

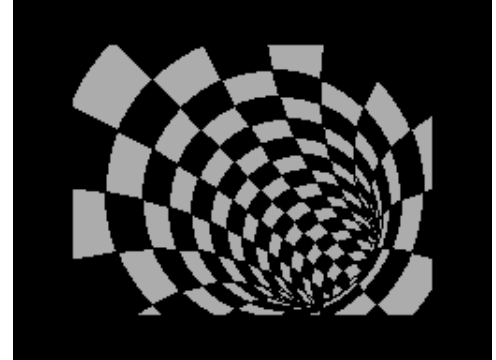

Tunnel Vision (Rack-It.)
Arcade



Turbo (MicroHobby,1985)
Arcade



Turbo Base (Robtek,1986)
Utility



Turbo Boat Simulator (Silverbird Software Ltd,1988)
Arcade

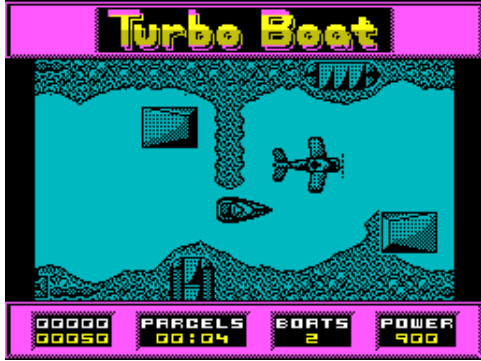

Turbo Chess (Kerian UK Ltd,1984)
Board/Card Game



Turbo Copy (Fuxoft,1986)
Utility: Copier

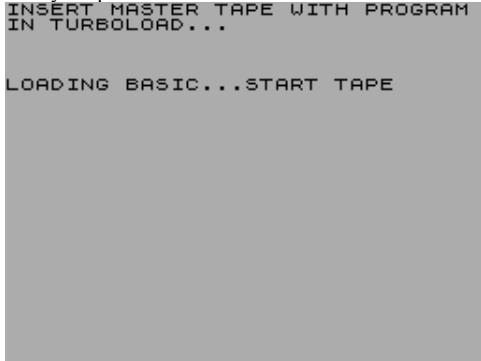

Turbo Driver (Boss Software,1983)
Arcade



Turbo Girl (Dinamic Software,1988)
Arcade



Turbo Calc (Robtek,1986)
Utility



Turbo Compiler (Jonathan Cauldwell,1994)
Utility



Turbo Copy (Mirage Software,1988)
Utility: Copier

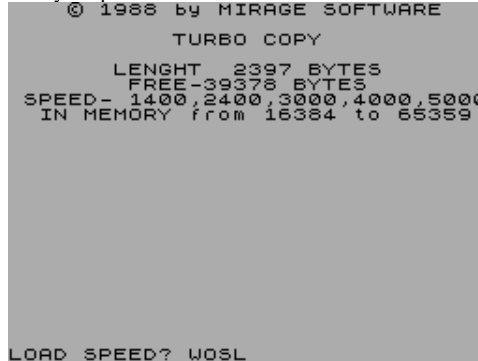

Turbo Dustbin (Clive Smith,1984)
Utility: Copier



Turbo Imploder (Saposoftware,1992)
Utility



Turbo Cassette LOAD/SAVE Creator (Tom Prince/Simon N. Goodwin,1988)
Utility



Turbo Copy (Bogdanov V.G.,1987)
Utility: Copier



Turbo Cup Challenge (Loricieis,1989)
Arcade

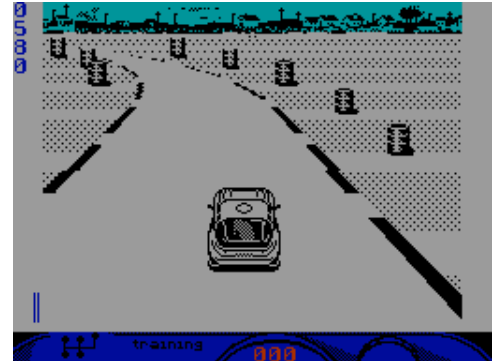

Turbo Esprit (Durell Software Ltd,1986)
Arcade



Turbo Kart Racer (Players Software,1991)
Arcade



Turbo Load (Your Sinclair,1988)

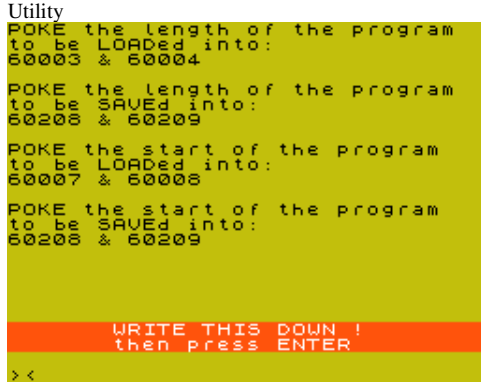

Turbo Out Run (US Gold Ltd,1990)



Turbo Tape 5 (ZX-Guaranteed,)

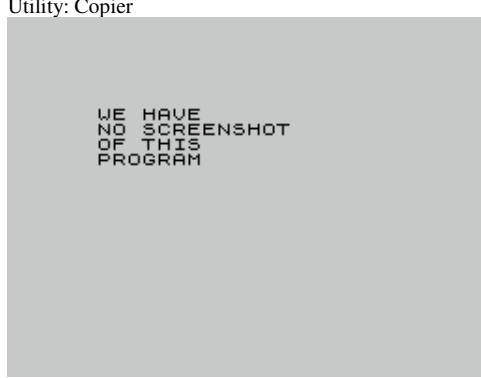

Turbulence (Beyond Belief,1993)



Turn or XOR'em All! (Mad Max Product,1995)



Turbomania (Jonathan Cauldwell,2005)

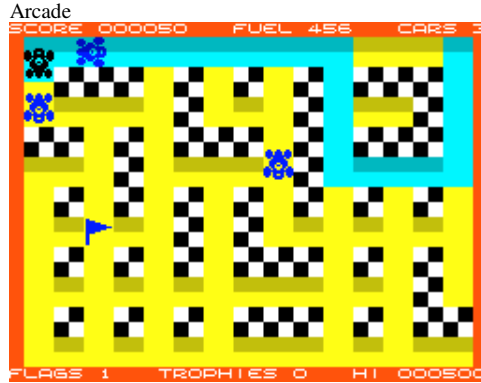

Turbo Pascal (Szafran Soft,1989)



Turbo Text (Robtek,1986)



Turf-Form (Blue Ribbon Software,1988)

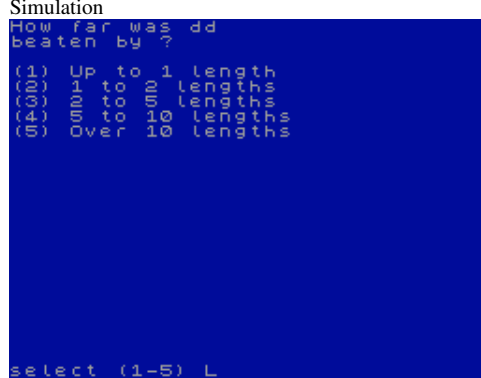

Turntaking (The Learning Process,1985)

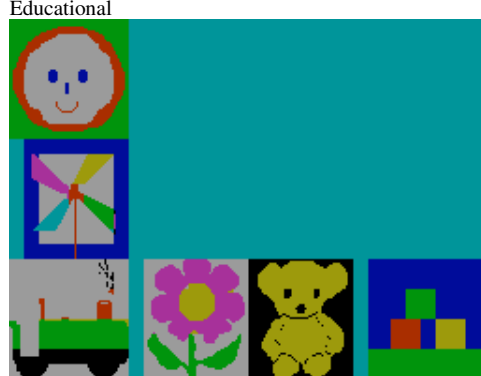

Turbo Master (Players Premier Software,)



Turbo Skate Fighter (Zeppelin Games Ltd,1989)



Turbo the Tortoise (Hi-Tec Software Ltd,1992)

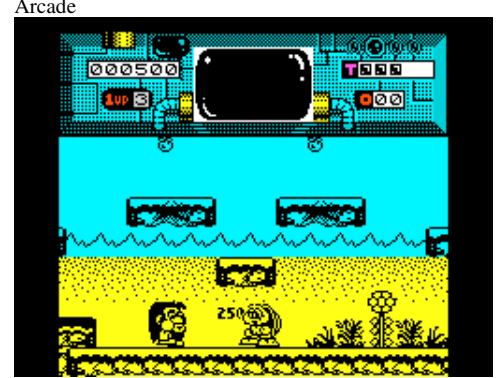

Turmoil (Bug-Byte Software Ltd,1984)



Turrican (Rainbow Arts,1990)



Turrican II (Rainbow Arts,1991)
Arcade

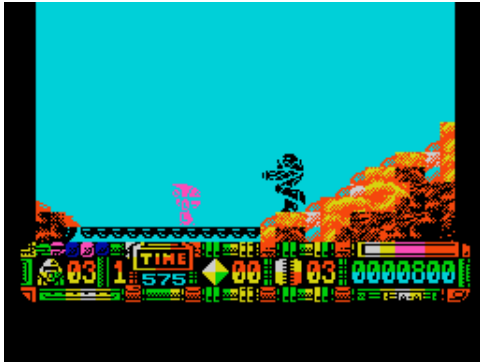

Turtle Timewarp (Perfection Software,1984)
Board/Card Game

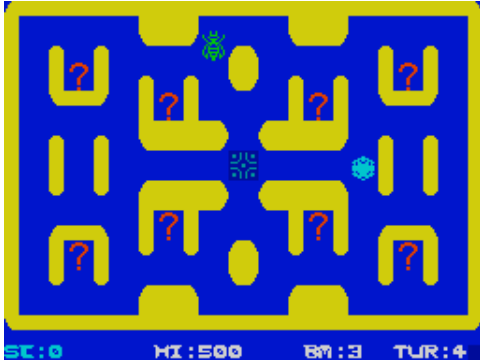

Tus Juegos 2 (Monser S.A.,1984)
Compilation

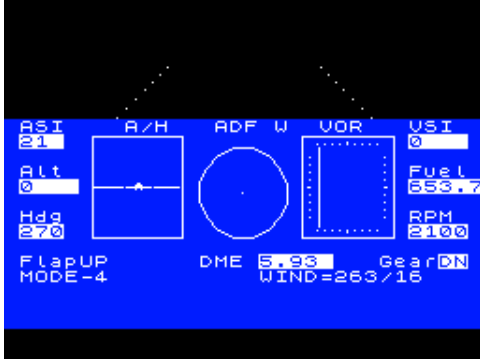

Tus Juegos Single 3 (Monser S.A.,)
Compilation



Tusker (System 3 Software Ltd,1989)
Arcade Adventure



Turrican II Music Demo (Rainbow Arts,1993)
Scene Demo



Turtulle Panic (GDP Software,1985)
Arcade

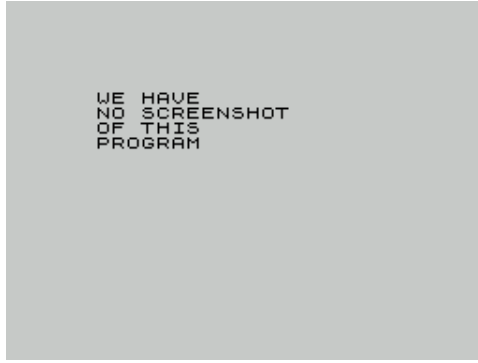

Tus Juegos Single 1 (Monser S.A.,)
Compilation



Tus Juegos Single 4 (Monser S.A.,)
Compilation



Tutankhamun (Micromania,1983)
Arcade



Turtle 2 (AVC Software,1982)
Utility

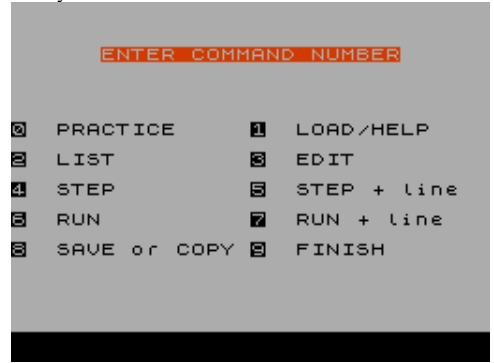

Tus Juegos 1 (Monser S.A.,)
Compilation



Tus Juegos Single 2 (Monser S.A.,1984)
Compilation

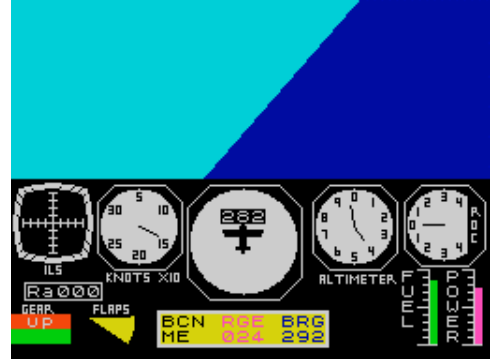

Tus Juegos Single 5 (Monser S.A.,)
Compilation



Tute (Investronica S.A.,1984)
Board/Card Game

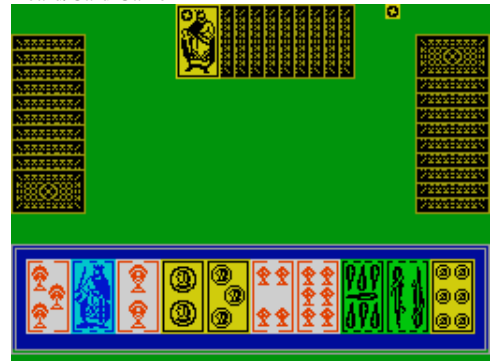

Tut-Ench-Amun (Pw/Mcs,1985)
Text Adventure

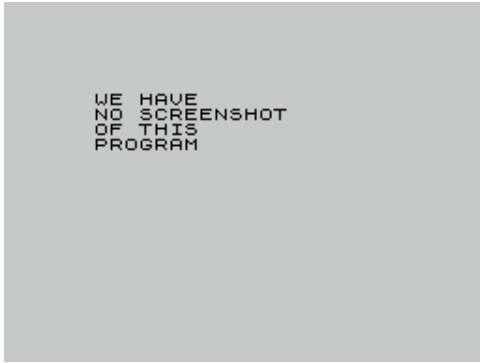

Tutor (Investronica S.A.)
Educational



Tutor de Ingles (ABC Soft,1984)
Educational

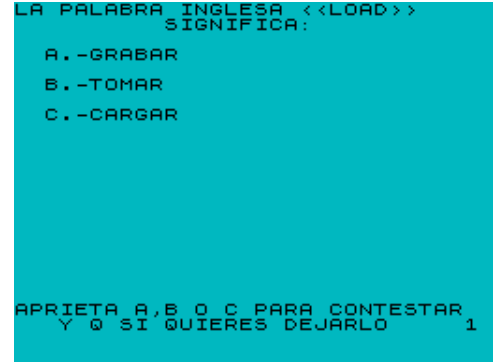

Tutor de Ingles (Boalox Informatica,1983)
Educational

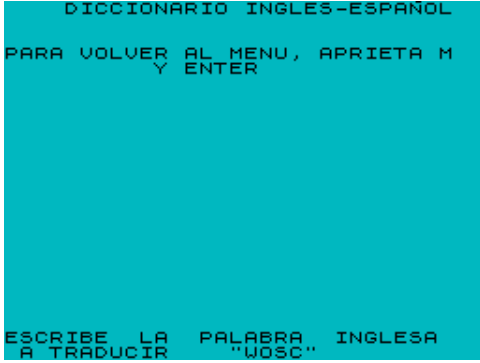

Tutor Musical (Micromania [2],1985)
Utility: Music Creation

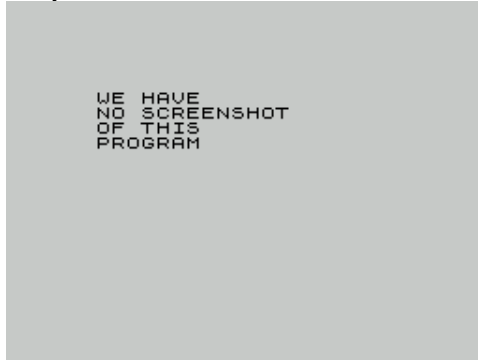

Tutti Fruti (Ventamatic,1986)
Arcade



TV Game (Weird Science Software,2004)
Arcade

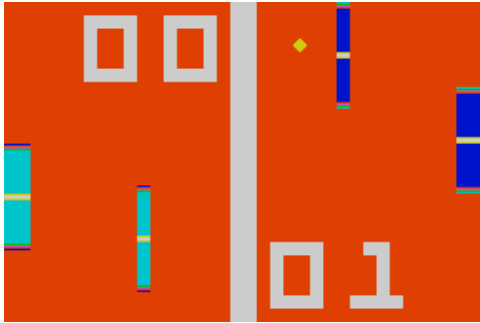

TV Pursuit (E. Lewis,1986)
Board/Card Game



TV Special (TV Games,1991)
Compilation



TV-X (Die Krupps,1998)
Scene Demo

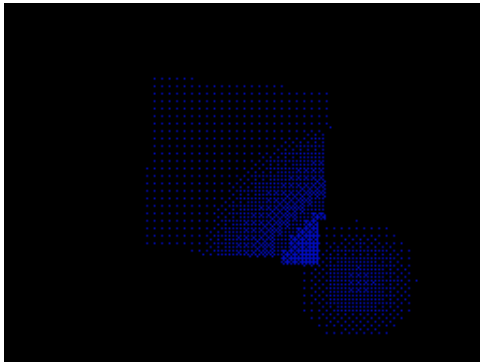

Twelve Days of Christmas, The (Zenobi Software,1994)
Text Adventure



Twenty Crossword Puzzles (National Extension College Trust Ltd,1984)
Compilation



Twice Shy (Mosaic Publishing Ltd,1986)
Text Adventure



Twilight (,1987)
Arcade



Twilight: Krajina Tienov (Ultrasoft,1995)
Strategy

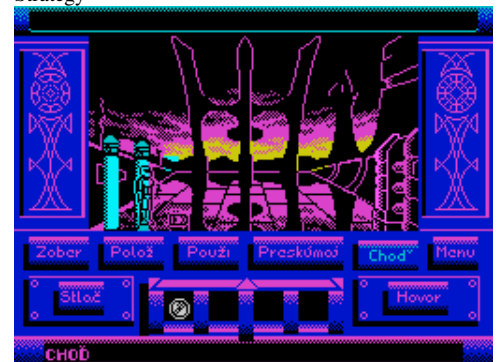

Twilight Zone (Thor Computer Software,1984)
Arcade

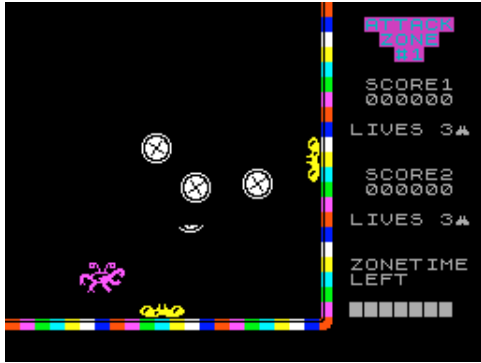

Twin Sounds (Rumatisoft,1991)
Scene Demo



Twin Turbo V8 (Code Masters Ltd,1989)
Arcade



Twister Fruit Machine (E.S.A. Productions,1998)
Arcade



Two-in-One (Tartan Software,1987)
Compilation



Twin Dealer (MFM Data Services Ltd,1984)
Board/Card Game

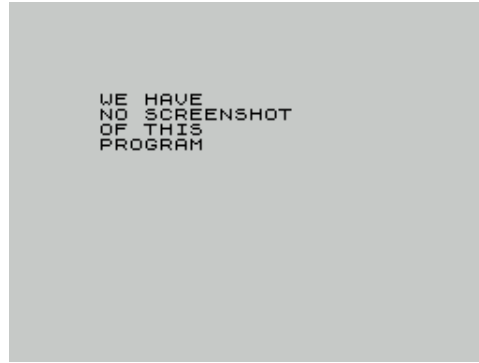

Twins, The (FX Illusion,1997)
Arcade

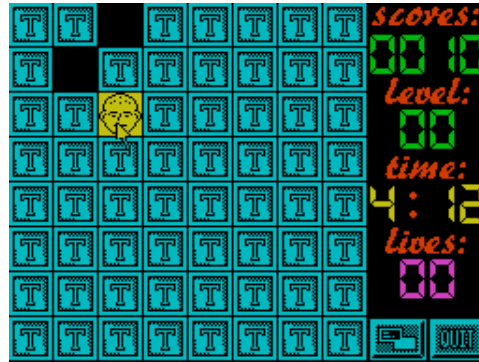

Twin World (Ubi Soft Ltd,1990)
Arcade



Twister, Mother of Charlotte (System 3 Software Ltd,1986)
Arcade



Twilight Zone, The (Kez Gray,1990)
Demo



Twin Kingdom Valley (Bug-Byte Software Ltd,1984)
Text Adventure



Twintris (Zack,1995)
Arcade

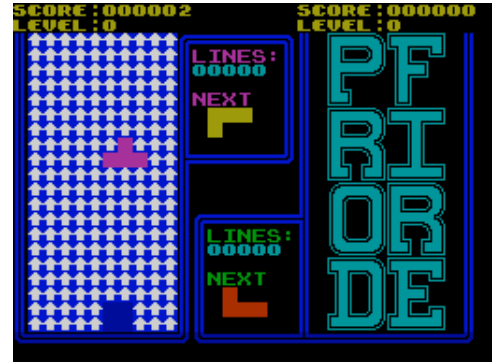

Twinz! (Sinclair User,1991)
Board/Card Game

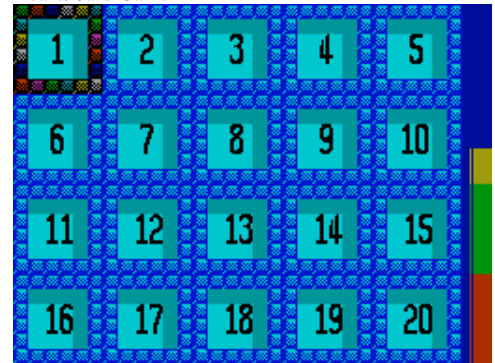

Two Gun Turtle (MC Lothlorien Ltd,1984)
Arcade



Tycoon, The Crossword Business Game (Duckworth Educational Computing/Newtech Publish,1985)
Arcade



Typeliner & Font Editor (Cardex Computer Software,1987)
Utility

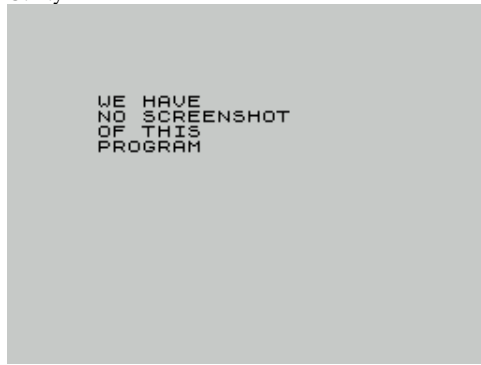

Typewriter (Claus Jahn,)
Utility

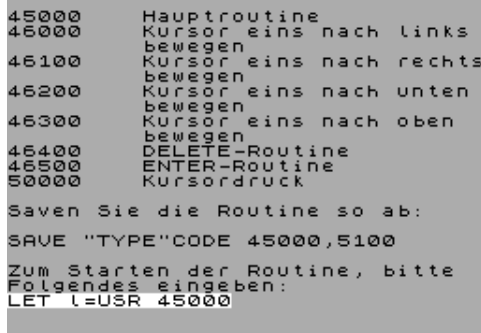

Typical Computer Shop, The (Spectrum Computing,1985) Demo



Tyrant of Athens (MC Lothlorien Ltd,1982)
Strategy

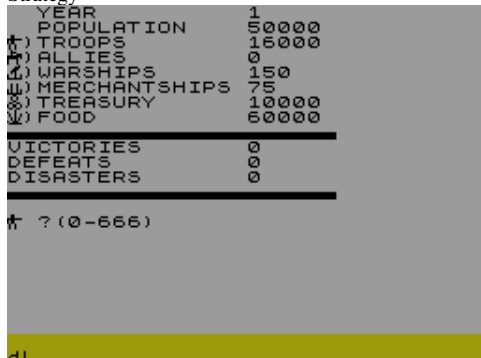

U-Boat Hunt (Protek Computing Ltd,1983)
Simulation

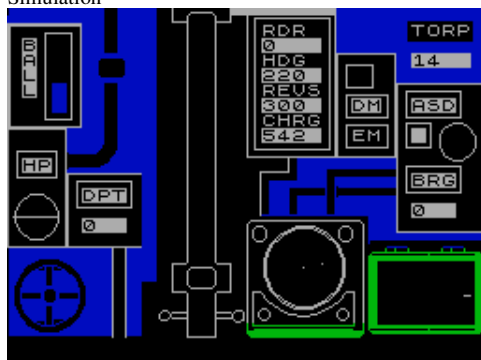

Type-Rope (Mastertronic Ltd,1986)
Arcade

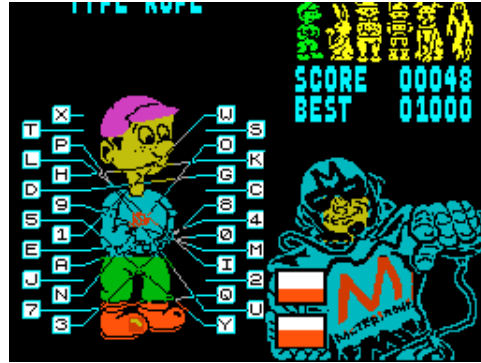

Typhoon (Imagine Software Ltd,1988)
Arcade



Typing Tutor (16/48 Tape Magazine,1984)
Educational

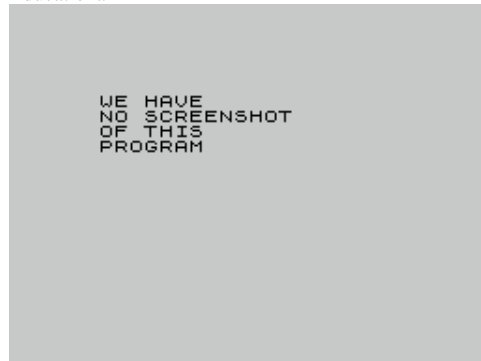

U-33 (MicroHobby,1985)
Arcade



Uchi Mata (Martech Games Ltd,1987)
Arcade



Typeset (Micro-Kraft,1984)
Utility

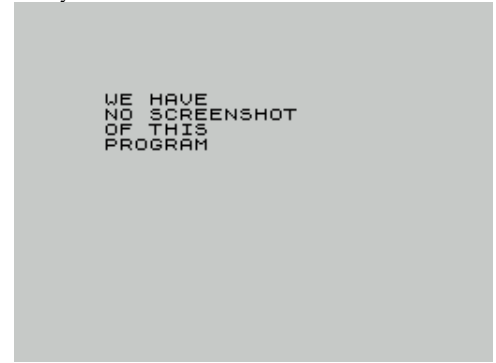

Typical Arcade Player, The (Spectrum Computing,1984)
Demo

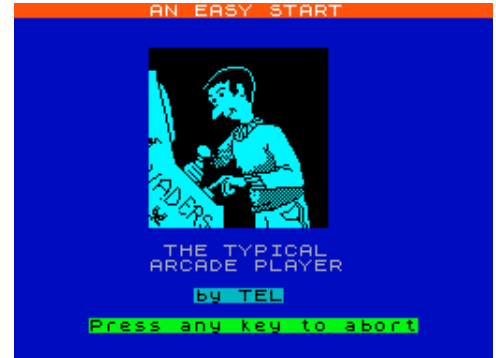

Typograph (Profisoft,1983)
Utility



U-Boat (EMS Software,1984)
Arcade



Udav Tsifroed (A. Kornienok,1993)
Arcade



UDG Aid (Simon Micro-Soft,1982)
Utility

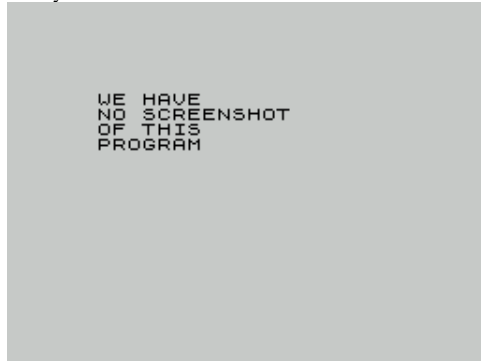

UDG Designer (Klaus Jahn,)
Utility: Font/UDGs



UDG Generator (Dorling Kindersley Software,1984)
Utility



UDG Maker (HL Software,1987)



UDG Print (Uwe Gebhardt,1985)

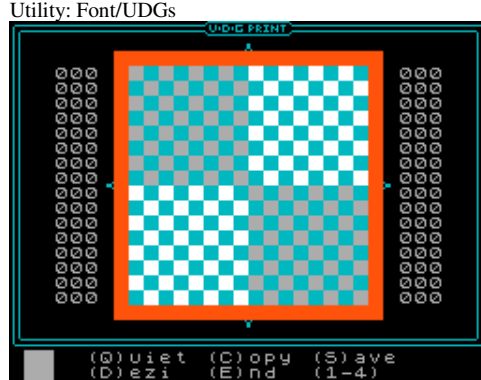

UDG's Machine (Sagesoft,1985)

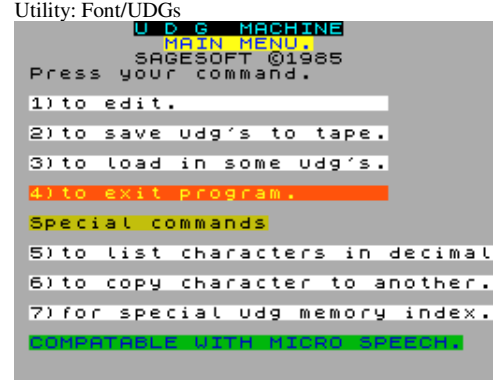

UDG-Tris (Jose Juan Rodenas,2006)
Arcade

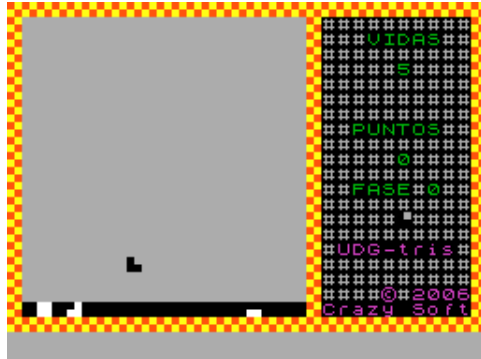

Ufo (J.K. Greye Enterprises Ltd,1982)
Arcade

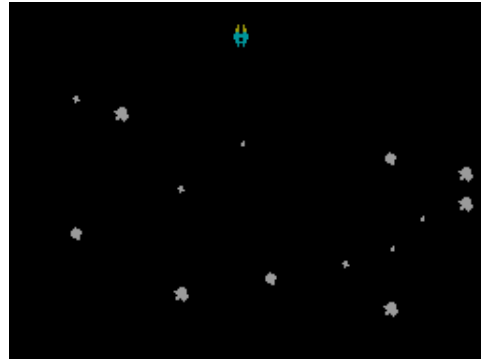

Ufo (Laszlo Nyitrai,1998)
Arcade

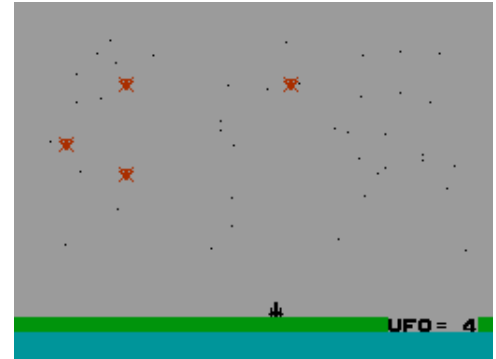

Ufo (MCT,)
Arcade



U-F-O (Sinclair User,1983)
Arcade

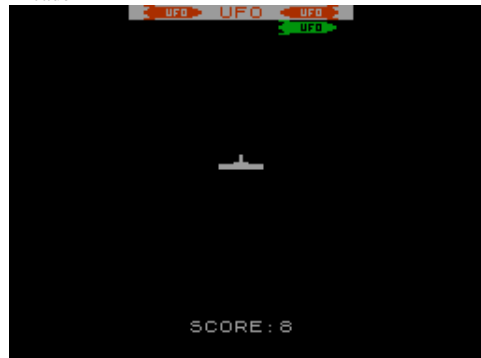

Ufo (Yoav Kaveh,1984)
Arcade

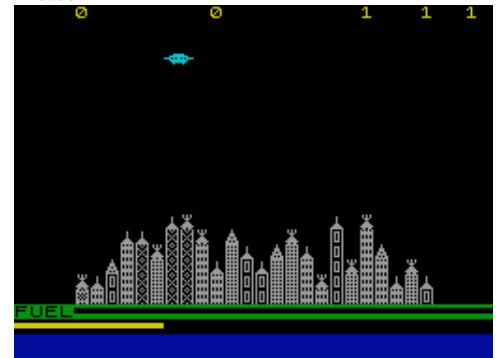

UFO: Enemy Unknown (Copper Feet,1995)
Strategy

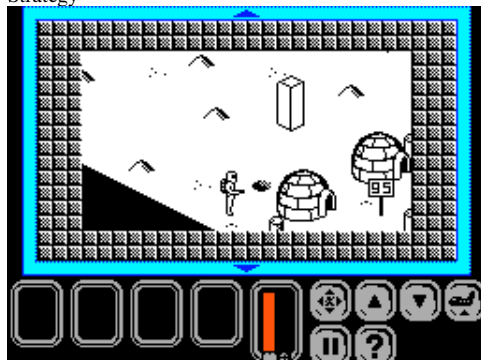

UFO 2: Devils of Abyss (Copper Feet,1996)
Strategy

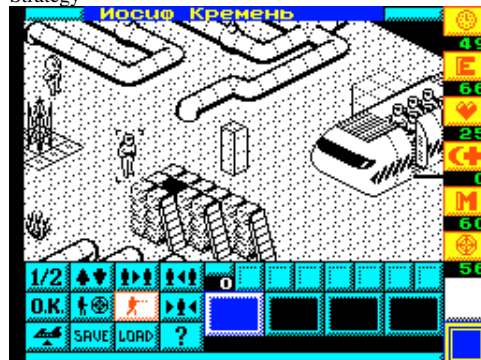

UFO-Adventure (Joachim Glaubercht,1983)
Arcade

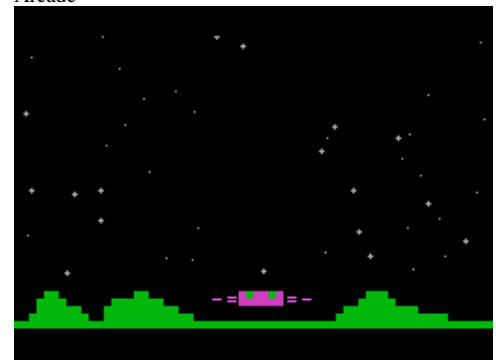

UGH! (Softek Software International Ltd,1984)
Arcade



Ugolki (Electrical Brain,1996)
Board/Card Game

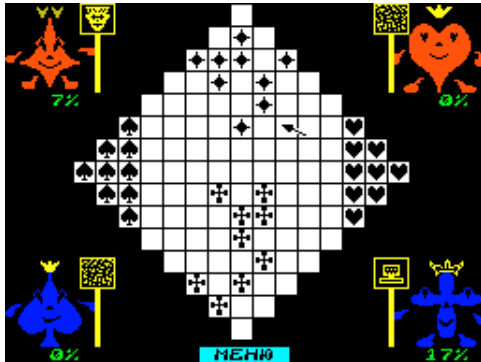

Ultima 2 (Tuc,1988)
Scene Demo



Ultimate Combat Mission (Mastertronic Added Dimension,1987) Arcade

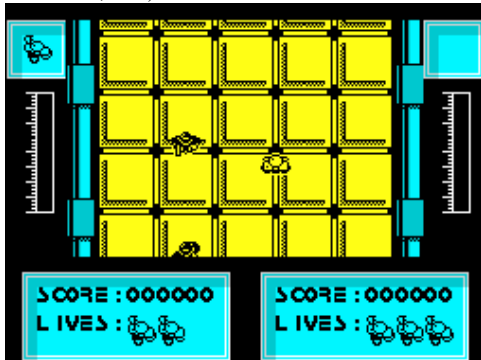

Ultimate Play The Game: The Collected Works (Ultimate Play The Game,1988) Compilation



Ugly Blaster (Stupidius,1997)
Arcade



Ulises (Opera Soft S.A.,1989)
Arcade Adventure



Ultima Ratio (Firebird Software Ltd,1987)
Arcade

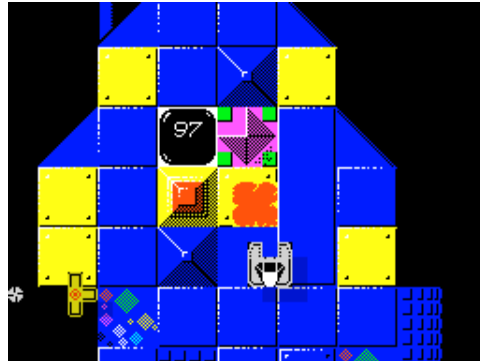

Ultimate Experience, The (Anco Software Ltd,1983)
Compilation



Ultimate Soccer Quiz, The (Marksman Software,1985)
Board/Card Game

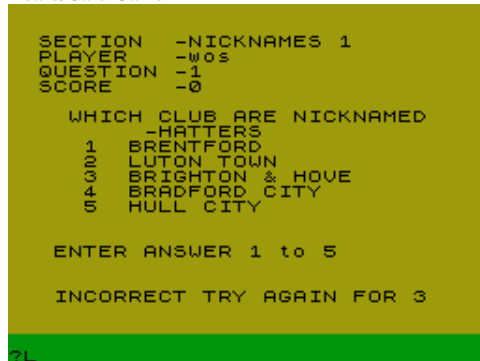

Ugly Scroll Routines (AC.)
Scene Demo



Ultifile (Ultrasoft,1984)
Utility: Copier

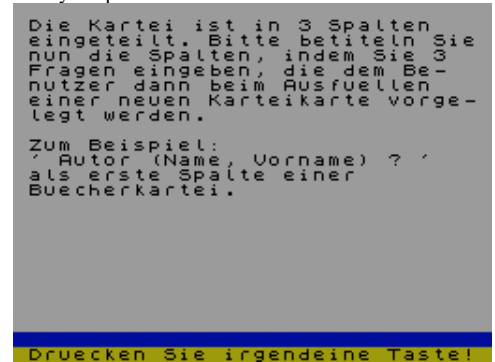

Ultimate Collection, The (Ubi Soft Ltd,1991)
Compilation



Ultimate Golf (Gremlin Graphics Software Ltd.)
Sport



Ultimate Warrior (Crash,1989)
Arcade

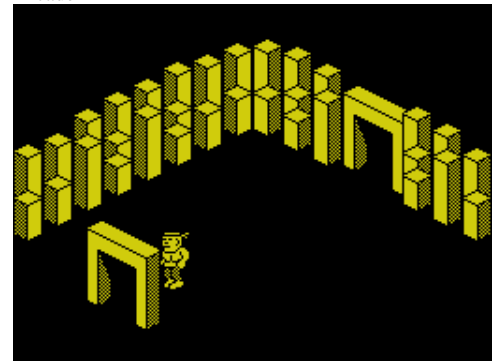

Ultimatum (EP Software,) Arcade

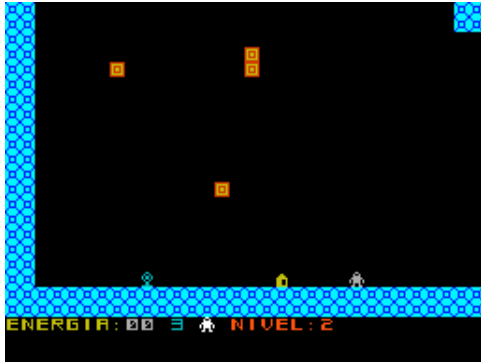

Ultracopy (Ultrasoft,1984) Utility: Copier

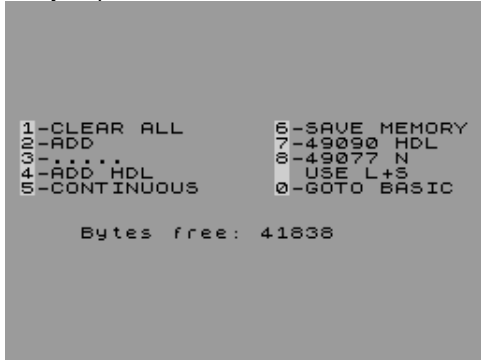

Ultra Reflect (Tiger's Claw,1995) Arcade

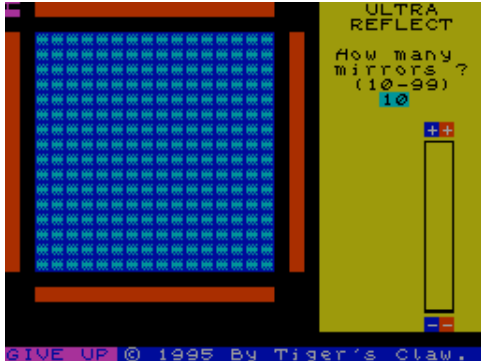

Ultraviolet (ACS Software,1982) Utility: Assembler/Disassembler/Monitor

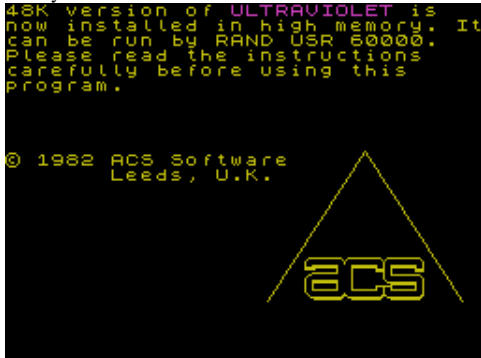

Unbelievable! Ultimate 2 (US Gold Ltd,1987) Compilation



Ultra-208 (Digital Reality [1],1991) Utility

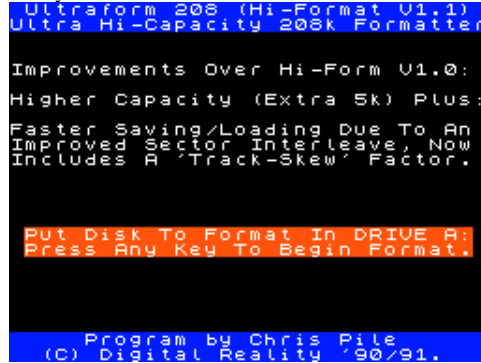

Ultrafile (Juergen Stessun/Superknack,1984) Utility: Copier

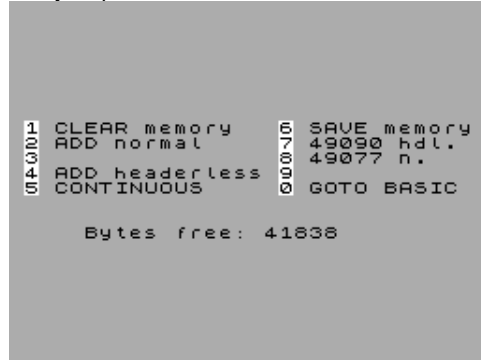

UltraSet (Markus F.X.J. Oberhumer,1986) Utility: Font/UDGs

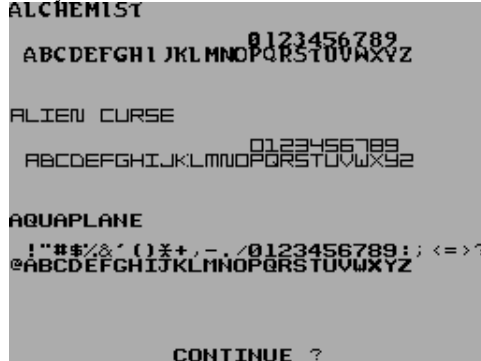

Umbral, El (Jaime Cristobal Urbicain,1989) Text Adventure



Uncle Ben's Bordello Beauties (Spermasoft Masturbatories,1989) Scene Demo



Ultracop (Crazy Soft,1990) Arcade



Ultra LX/LQ (Proxima Software,1993) Utility



Ultratumba (MicroHobby,1985) Utility



Unbelievable! Ultimate (US Gold Ltd,1987) Compilation

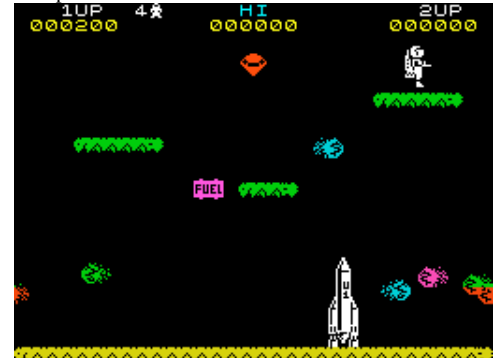

Uncle Jack (J.J. Soft,1984) Arcade



Underground (16/48 Tape Magazine,1985)

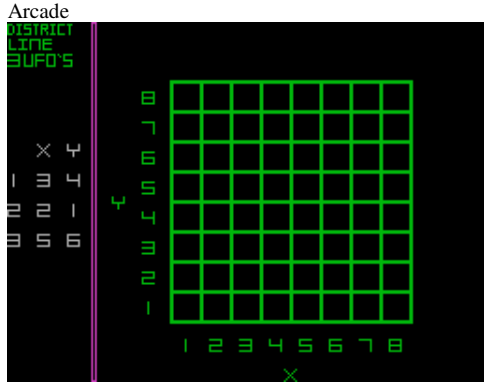

Underground Adventure (Duckworth Educational Computing,1984) Text Adventure

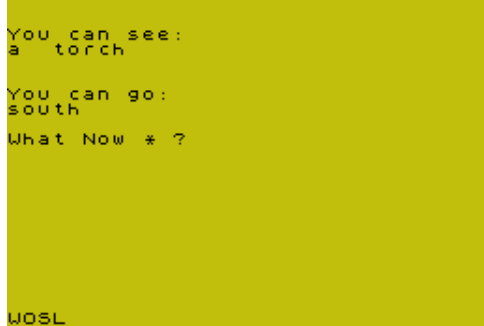

Underworld - The Village (Orpheus Ltd,1985)

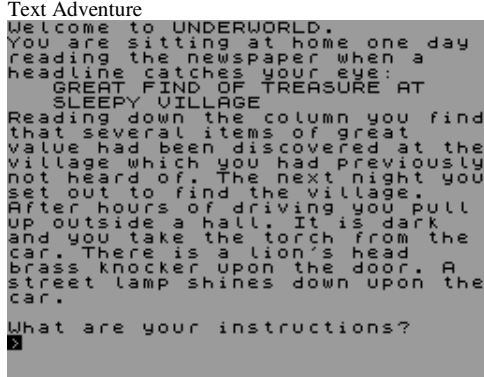

Uni-Dos (Format,1991)



United (CCS,1984)

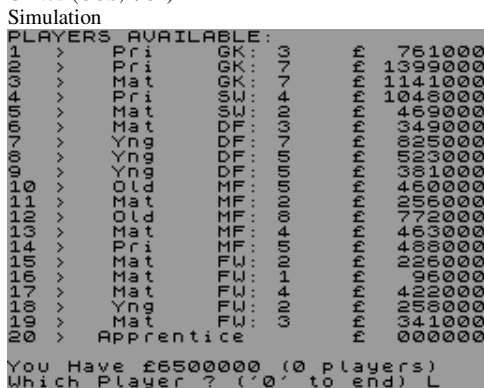

Underground (Micromania [2],1985)



Understanding Evolution (Sinclair Programs,1983)

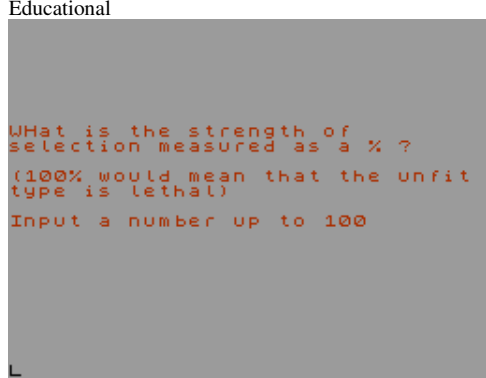

Underwurde (Ultimate Play The Game,1984)



Unifile (Individual Software Service,1984)



Unitrax (Streetwise,1987)



Under Ground (System 4,1988)

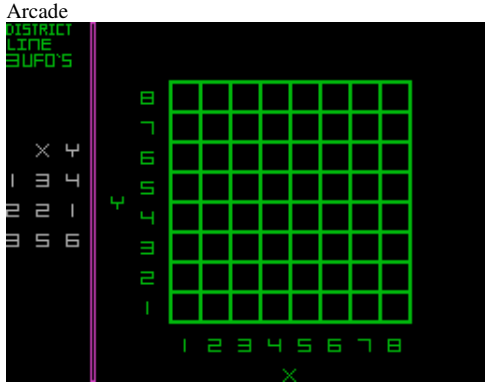

Underworld, The (Kevin Rae,1985)



Un, Dos, Tres Responda Otra Vez (Belltons Informatica/Paraninfo Soft S.A.,1984)

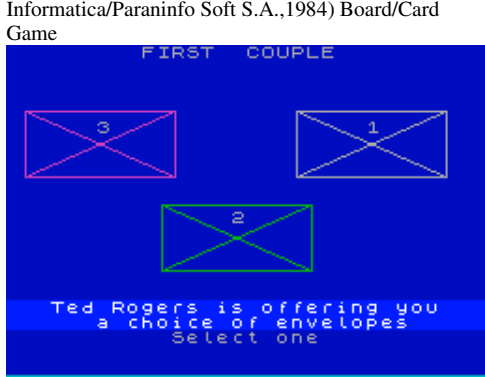

UNISTAT (University Software,1985)

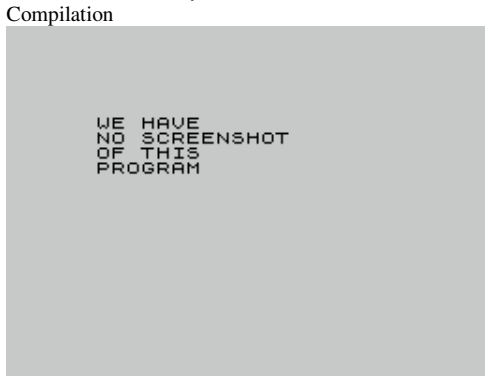

Unitrust Program, The (Michael Slatford,1985)



Universal Hero (Mastertronic Ltd,1986)
Arcade

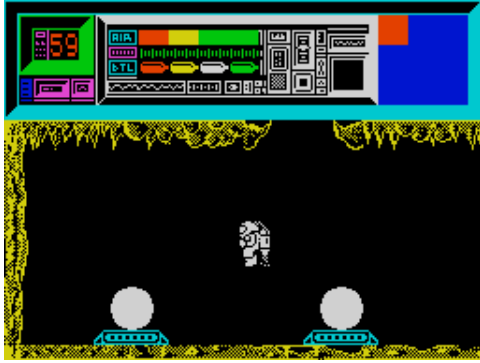

Unlimited Specky Minidemo (Dream Makers Software,)
Scene Demo



Uno (Luis Babbioni,)
Board/Card Game



Unresident Evil 3: Enter the Laboratory (XFAWORLD Software,2004) Arcade

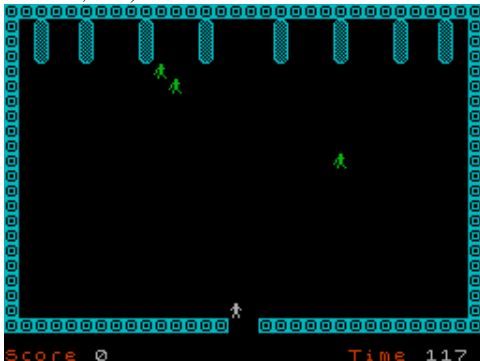

Untouchables, The (Ocean Software Ltd,1989)
Arcade

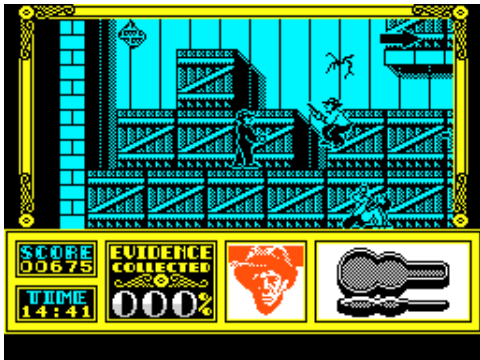

Universalschrift (.)
Utility: Font/UDGs



Unlimited Spirits (The Mad Guys,1992)
Scene Demo



Unresident Evil (XFAWORLD Software,2003)
Arcade

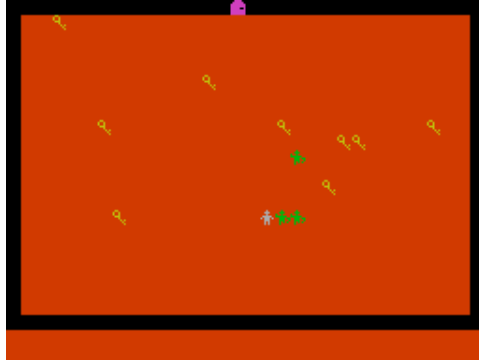

Unresident Evil 4: The Final Showdown (XFAWORLD Software,2004) Arcade



Unused Demo (Omega Software Graphics NLtd,1994)
Scene Demo



Unknown (DMT,1993)
Scene Demo



Un Mundo Feliz (Zael,2006)
Text Adventure

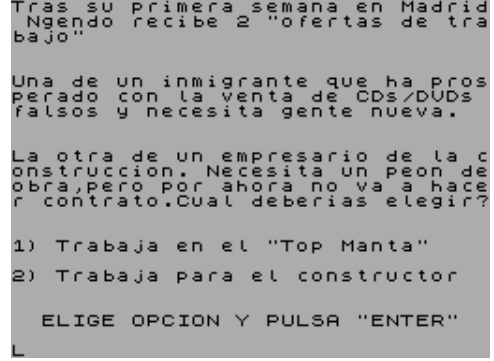

Unresident Evil 2: Escape from the Courtyard (XFAWORLD Software,2003) Arcade

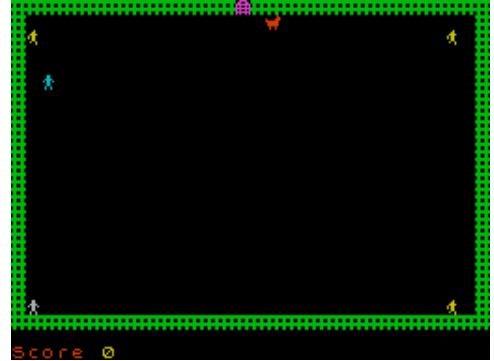

U.N. Squadron (US Gold Ltd,1990)
Arcade Adventure



Unwetter (EMM Software,1984)
Arcade



UO2-EAR (G4IDE Micro Systems,1985)
Utility

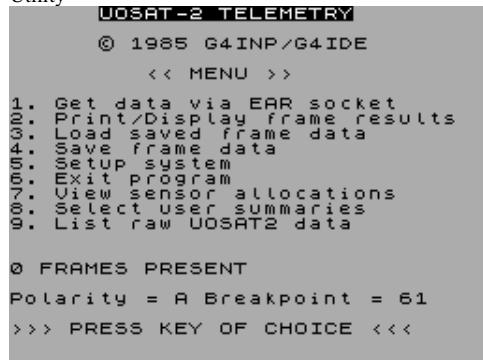

Up 'n Down (US Gold Ltd.)
Arcade



Urban (Zenobi Software,1991)
Text Adventure

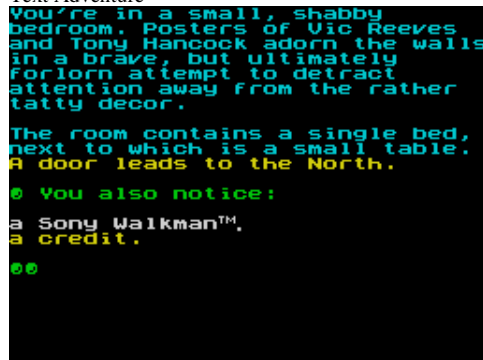

Uridium + Firelord (Hewson Consultants Ltd,1986)
Compilation

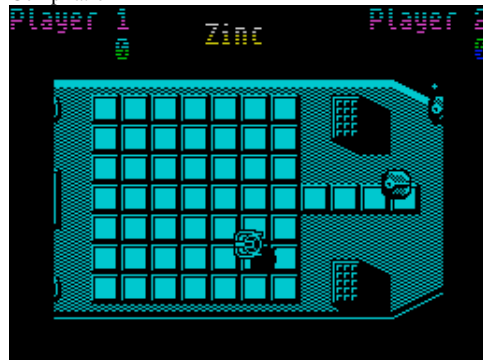

Urwald (Pw/Mcs,1985)
Text Adventure



Up for Grabs (Summit Software,1988)
Simulation



Upper Gumtree (Richard Shepherd Software Ltd,1984)
Text Adventure



Urban Upstart (Richard Shepherd Software Ltd,1983)
Text Adventure

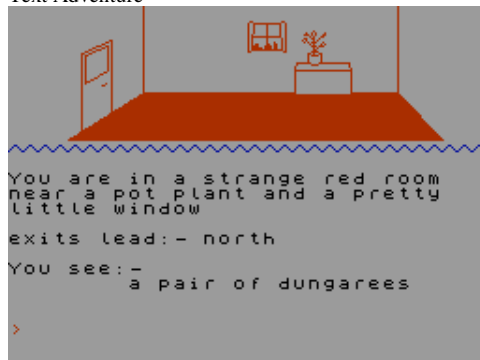

Uridium Plus (Hewson Consultants Ltd,1986)
Arcade

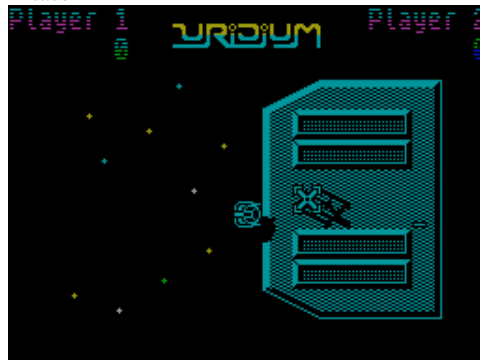

Uschi Compiler (Happy-Computer,1987)
Utility: BASIC Related

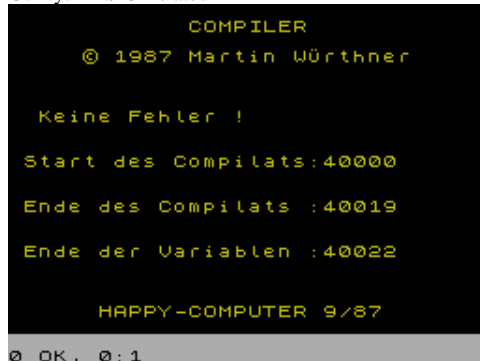

Upir (.)
Text Adventure

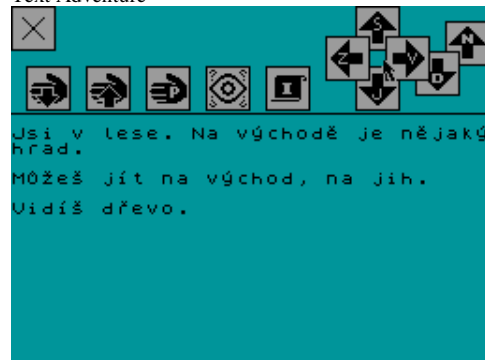

Urano (Grupo de Trabajo Software S.A.,1987)
Arcade



Uridium (Hewson Consultants Ltd,1986)
Arcade

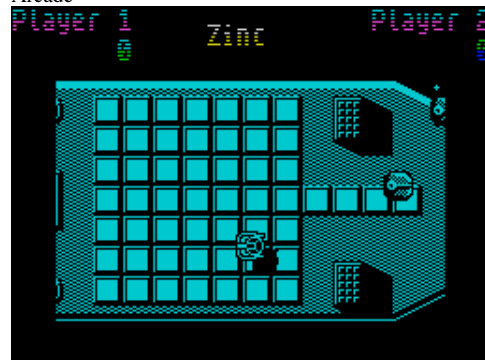

Urquahart Castle (Central Solutions,1985)
Text Adventure

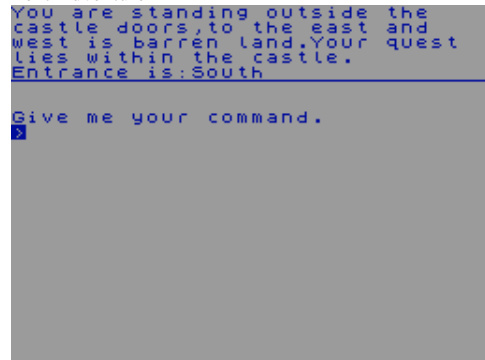

Use and Learn (MiCROL,1982)
Compilation



User (Anestis Koutsoudis,1998)
Scene Demo

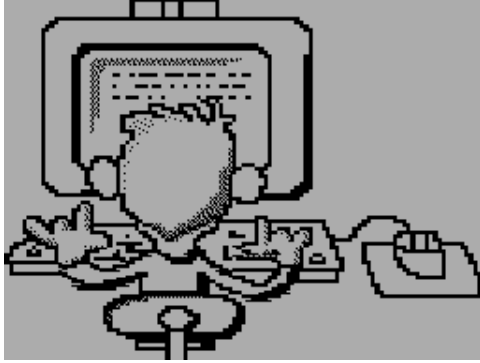

Usergraphics-Program Generator (16/48 Tape Magazine,1984)
Utility: Font/UDGs



Using Your Computer III (BBC Software,)
Educational

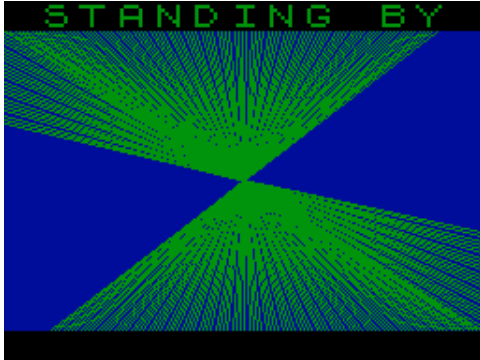

Usurper (Assassin Software,1984)

Text Adventure



Utility1 (Outlet Microdrive Magazine,1989)
Utility: Font/UDGs



User-1 (Proxima Software,1991)
Compilation



User Graphic Tablet (,)

Utility

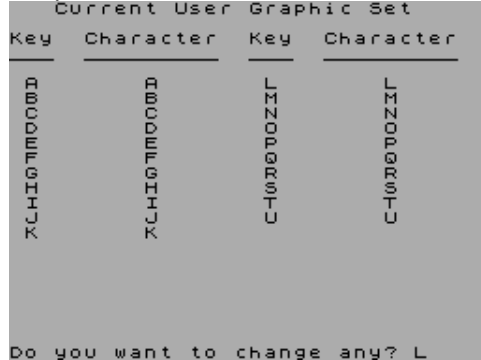

USP-232D (U-Microcomputers Ltd,1983)

Utility



U.T.E. (,1984)

Utility

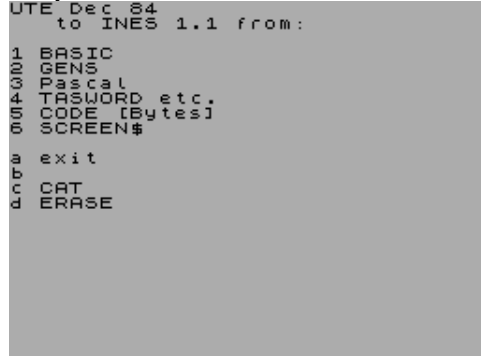

Utility2 (Outlet Microdrive Magazine,1989)
Utility: BASIC Related

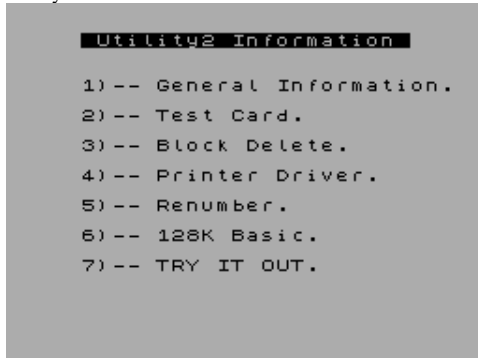

User Defined Graphics (Oxford Computer Publishing,1982)

Utility: Font/UDGs

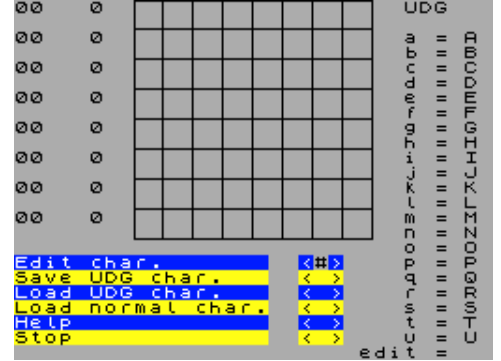

Use Your Loaf (The Guild,1992)

Text Adventure

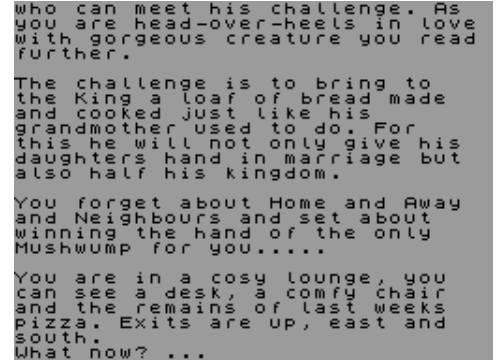

USS Enterprise (Anik Microsystems,1984)

Arcade



Utilidades 1 (Microparadise Software,1984)

Compilation



Utility3 (Geoff Wearmouth,1989)

Utility: Assembler/Disassembler/Monitor



Utility A (Chezron Software,1987)
Utility



Utility Draw (Sinclair Programs,1983)
Utility: Drawing

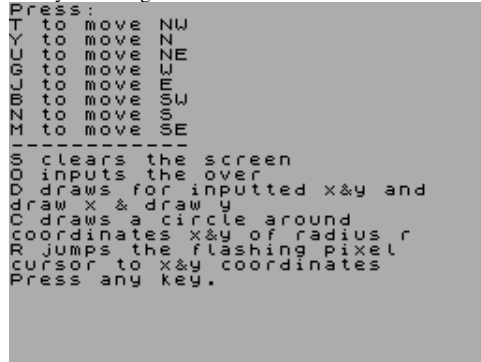

Utils 2 (Alchemist Research,)
Utility



Utils 3 (Alchemist Research,)
Utility



Utok Bile Mysky (Proxima Software,1993)
Arcade Adventure



V (Ocean Software Ltd,1986)
Arcade

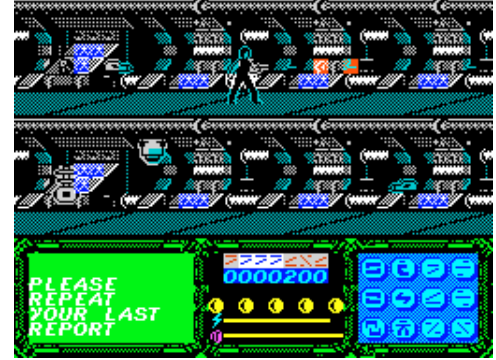

V (Stephen Nichols,1985)
Arcade



Vadaszat (Interbit Software,1984)
Arcade



Vagan Attack (Atlantis Software Ltd,1983)
Arcade



Valhalla (Legend,1983)
Text Adventure

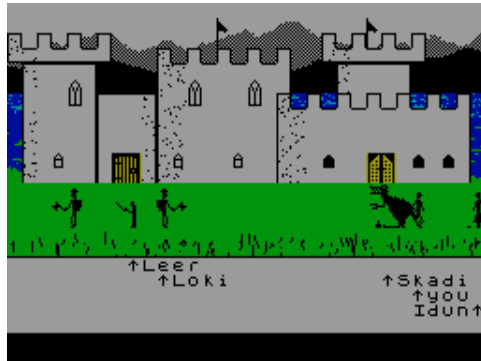

Valkyrie 17 (The RamJam Corporation,1984)
Text Adventure



Valley of the Dead (Pocket Money Software,1985)
Arcade

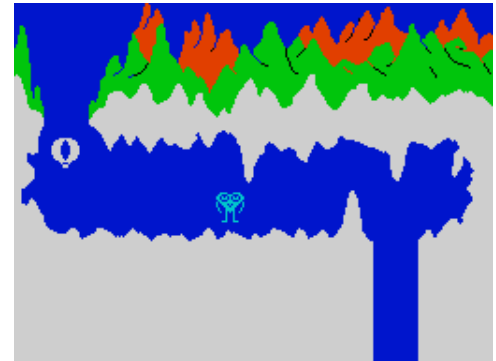

Valley of the Kings (Monk Soft,1984)
Text Adventure

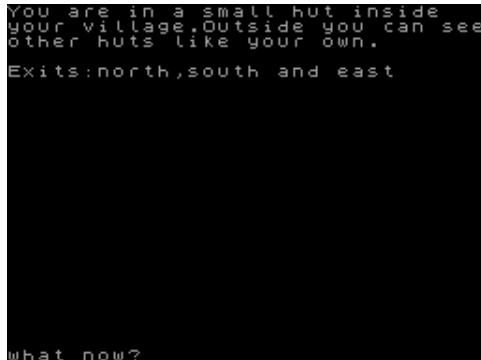

Valley, The (ASP Software Ltd,1982)
Arcade Adventure



Valley, The (Kayde Software Ltd,1983)
Arcade Adventure

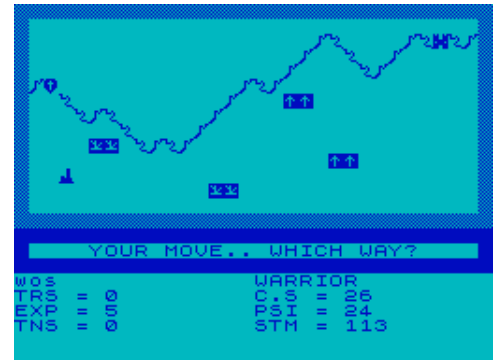

Valley, The (Outlet Microdrive Magazine,)
Arcade Adventure

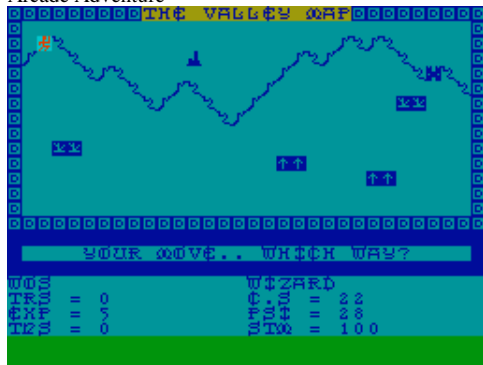

Vampire (16/48 Tape Magazine,1983)
Arcade



Vampire's Empire (Gremlin Graphics Software Ltd,1988)
Arcade Adventure



Van Driver (Profisoft,1984)
Arcade



Variador de Velocidad (MicroHobby,1985)
Utility



Value Pack 16K (Beau-Jolly Ltd,1983)
Compilation



Vampire Killer (Scorpio Gamesworld,1984)
Arcade Adventure



Vampire Village (Terminal Software,1983)
Arcade Adventure



Vanquisher (Elephant Software,1983)
Arcade

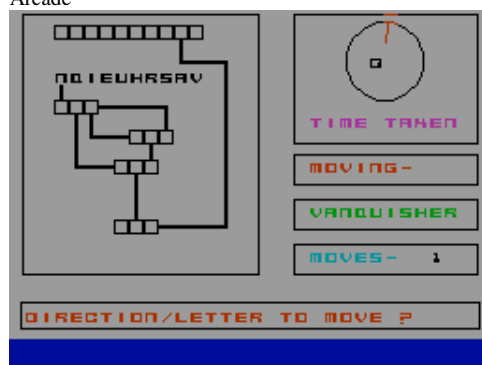

Variload (Foraits Software,1985)
Utility



Value Pack 48K (Beau-Jolly Ltd,1984)
Compilation

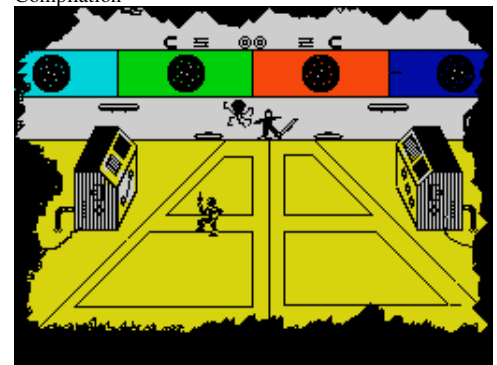

Vampire Ring (Ricochet,)
Arcade



Vampyre Castle (Jim Williams,1985)
Arcade



Variables Founder (.)
Utility: BASIC Related

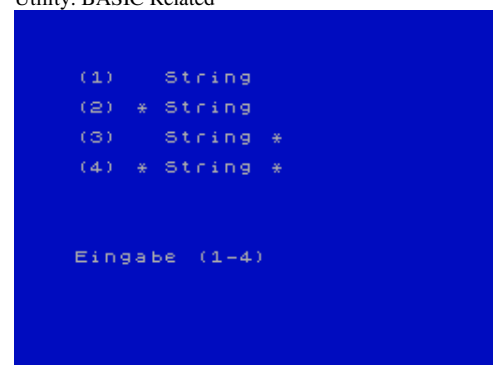

Varitalk (ITS Software,1985)
Utility: Sound Manipulation



Vaseline (The Knuckle Girls,1994)
Scene Demo



VAT Manager (Oxford Computer Publishing,1984)
Utility

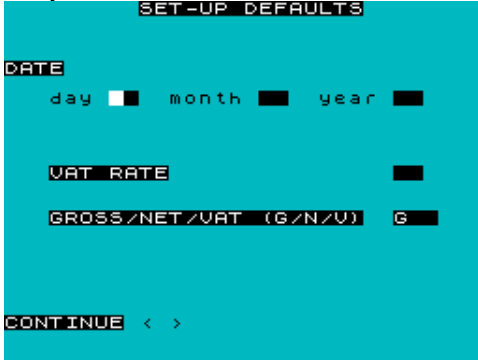

Vector Mathematics (WH Smith,1983)
Educational

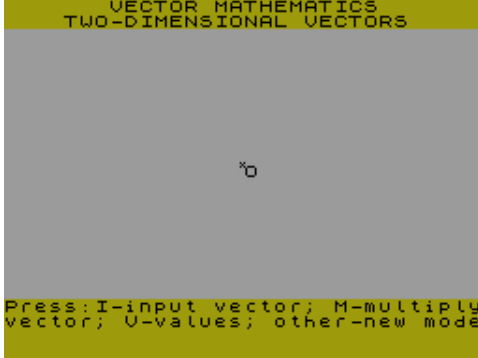

Vegas Jackpot (Mastertronic Ltd,1984)
Arcade

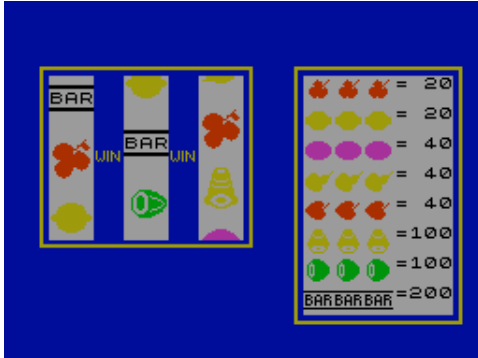

Vegetable Crash (Kuma Computers Ltd,1984)
Arcade



Vast + (.)
Utility: Assembler/Disassembler/Monitor

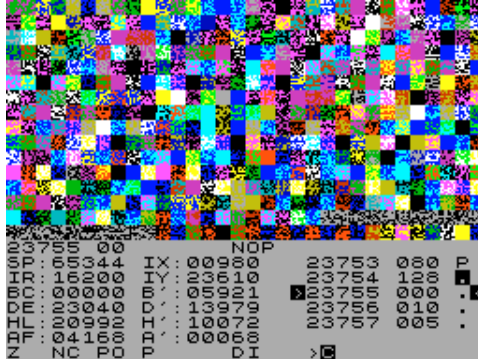

Vector (Jacek Michalak,)
Scene Demo

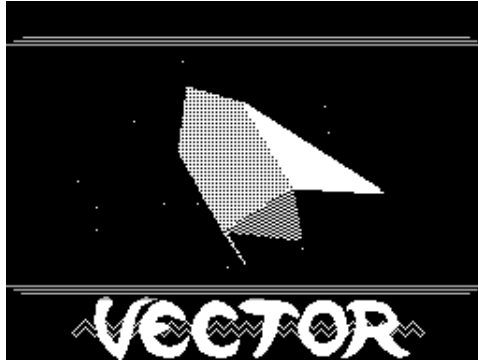

Vectron (Insight Software,1985)
Arcade



Vega Solaris (Quasar/Eclipse [1],1989)
Arcade



Velika Akcija (Radio Ventilator 202,1984)
Text Adventure



Vatman (Your Sinclair,1989)
Arcade



Vector Ball (Mastertronic Added Dimension,1988)
Arcade

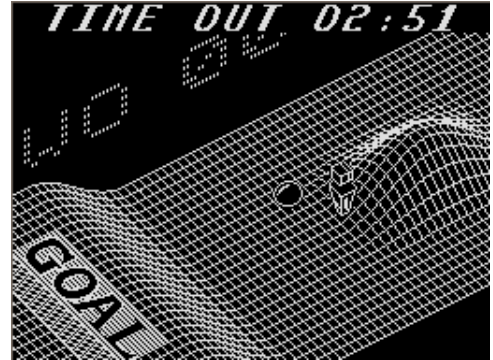

Vedrunien (Alien Software,1994)
Text Adventure



Vega-Table (Vega Space Systems Ltd,1984)
Utility



Velnor's Lair (Neptune Computing,1983)
Text Adventure

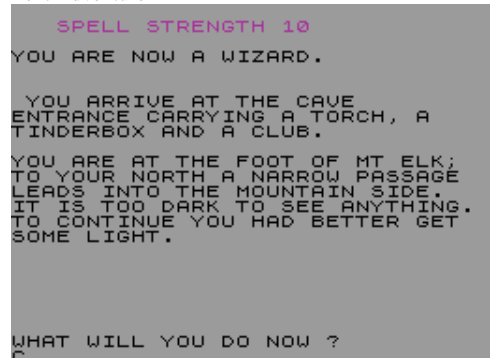

Vendelin v Zakletem Dome (J.H.C.S.,1995)
Arcade

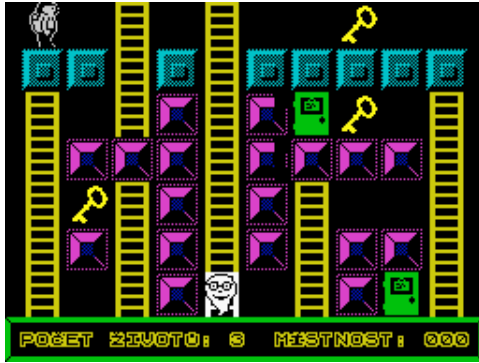

Venganza de Johny Comomolo, La (Dro Soft,1987)
Arcade

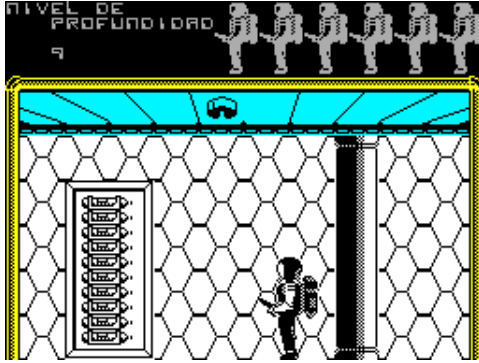

Venom (Mastertronic Ltd,1988)
Text Adventure



Venturama (Your Sinclair,1992)
Arcade



Verbos (MicroHobby,1985)
Educational



Vendetta (System 3 Software Ltd,1990)
Arcade Adventure

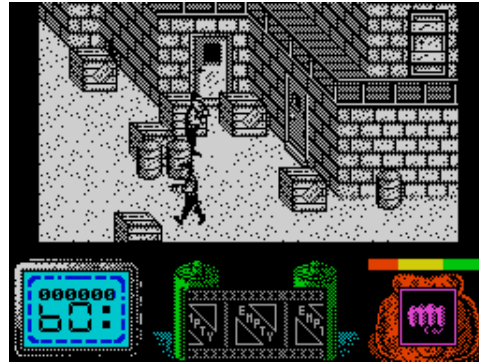

Venganza de Rufo, La (Quasimodo Soft,1989)
Text Adventure



Ventamatic Centronics (Ventamatic,1983)
Utility

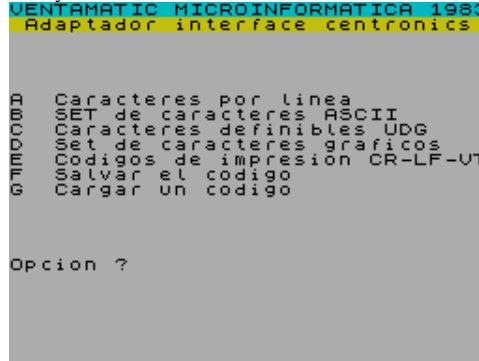

Venture (ZX-Guaranteed,1982)
Arcade

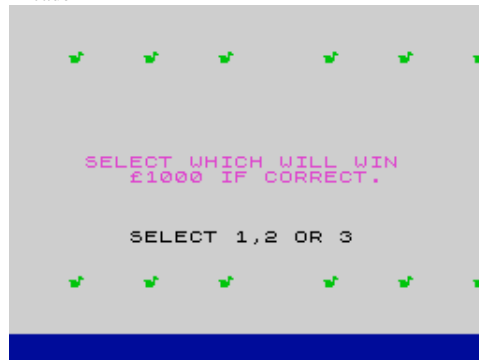

Verbos Irregulares (,)
Educational

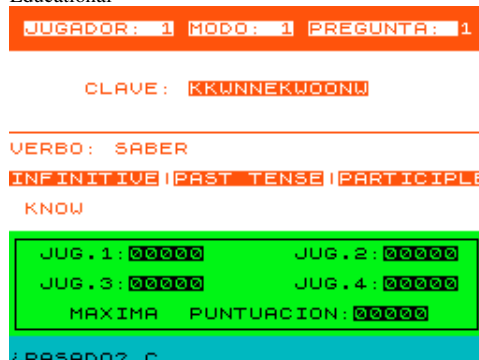

Venedig (Individual Software Service,)
Text Adventure



Vengeance (CRL Group PLC,)
Arcade



Ventamatic MIDI Interface (Ventamatic,1984)
Utility

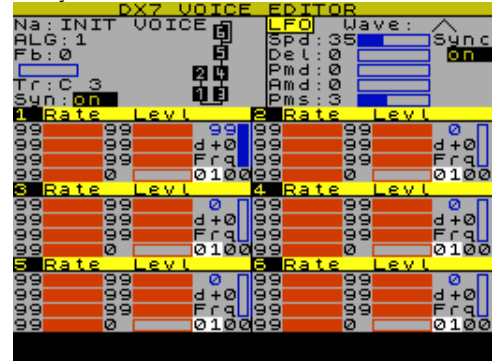

Vera Cruz Affair, The (Infogrames,1985)
Text Adventure



Verb Practice (Calpac Educational Software,1983)
Educational



Verdugo (.)
Board/Card Game

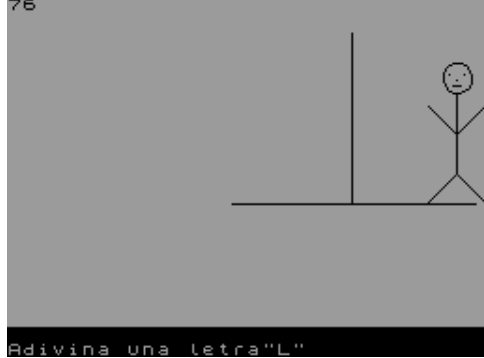

Adivina una letra "L"
Very Big Cave Adventure, The (CRL Group PLC, 1986)
Text Adventure



VGA Demo volume 3 (Theo Devil, 1993)
Scene Demo



Vibe MM2 (.)
Utility: Copier

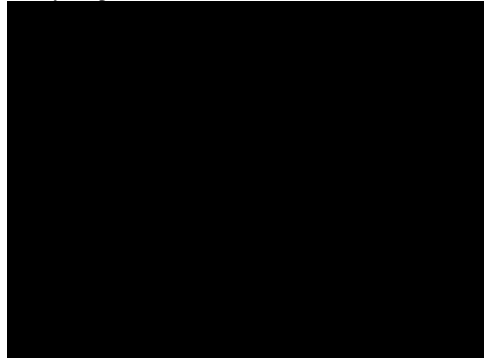

Vicomm Modem 2 (Flash Inc, 1997)
Scene Demo

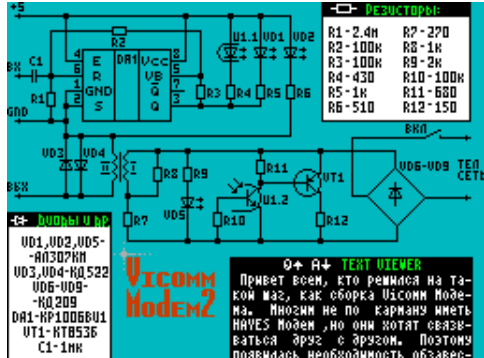

Verisimilitude (Zack, 1995)
Scene Demo



Very Nasty Mountains (Giltrole Ltd, 1982)
Strategy



VGA Demo volume 4 (Theo Devil, 1993)
Scene Demo

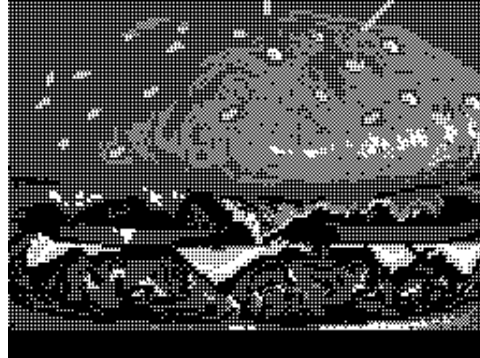

Vibrations (Dream Makers Software, 1996)
Scene Demo

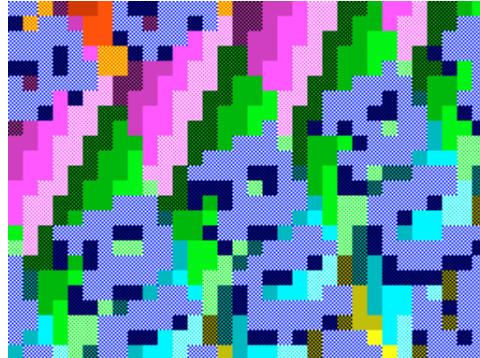

Victory Road (Imagine Software Ltd, 1989)
Arcade

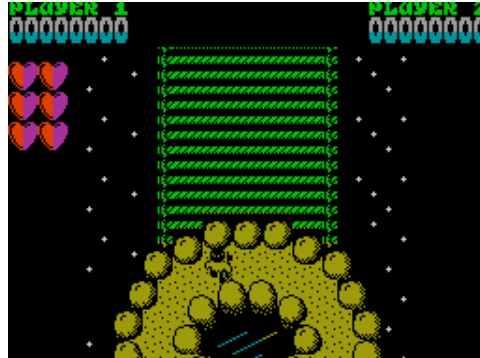

Vertigo (Ventamatic, 1984)
Arcade



Vesele Velikonoce (Proxima Software, 1993)
Text Adventure

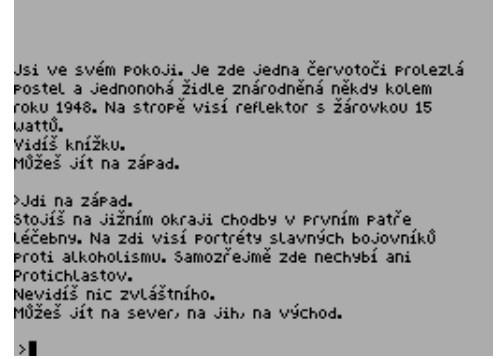

Viaje al Centro de la Tierra (Topo Soft, 1989)
Arcade

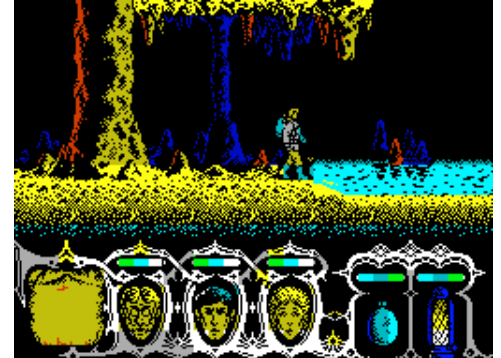

Vice Versa (Pirate Software Ltd, 1987)
Board/Card Game



Vida, La (Software Editores, 1986)
Simulation



Video Basic issue 01 (Gruppo Editoriale Jackson,1985)
Covertape

WE HAVE
NO SCREENSHOT
OF THIS
PROGRAM

Video Basic issue 02 (Gruppo Editoriale Jackson,1985)
Covertape

WE HAVE
NO SCREENSHOT
OF THIS
PROGRAM

Video Basic issue 03 (Gruppo Editoriale Jackson,1985)
Covertape

WE HAVE
NO SCREENSHOT
OF THIS
PROGRAM

Video Basic issue 04 (Gruppo Editoriale Jackson,1985)
Covertape

WE HAVE
NO SCREENSHOT
OF THIS
PROGRAM

Video Basic issue 05 (Gruppo Editoriale Jackson,1985)
Covertape

WE HAVE
NO SCREENSHOT
OF THIS
PROGRAM

Video Basic issue 06 (Gruppo Editoriale Jackson,1985)
Covertape

WE HAVE
NO SCREENSHOT
OF THIS
PROGRAM

Video Basic issue 07 (Gruppo Editoriale Jackson,1985)
Covertape

WE HAVE
NO SCREENSHOT
OF THIS
PROGRAM

Video Basic issue 08 (Gruppo Editoriale Jackson,1985)
Covertape

WE HAVE
NO SCREENSHOT
OF THIS
PROGRAM

Video Basic issue 09 (Gruppo Editoriale Jackson,1985)
Covertape

WE HAVE
NO SCREENSHOT
OF THIS
PROGRAM

Video Basic issue 10 (Gruppo Editoriale Jackson,1985)
Covertape

WE HAVE
NO SCREENSHOT
OF THIS
PROGRAM

Video Basic issue 11 (Gruppo Editoriale Jackson,1985)
Covertape

WE HAVE
NO SCREENSHOT
OF THIS
PROGRAM

Video Basic issue 12 (Gruppo Editoriale Jackson,1985)
Covertape

WE HAVE
NO SCREENSHOT
OF THIS
PROGRAM

Video Basic issue 13 (Gruppo Editoriale Jackson,1985)
Covertape

WE HAVE
NO SCREENSHOT
OF THIS
PROGRAM

Video Basic issue 14 (Gruppo Editoriale Jackson,1985)
Covertape

WE HAVE
NO SCREENSHOT
OF THIS
PROGRAM

Video Basic issue 15 (Gruppo Editoriale Jackson,1985)
Covertape

WE HAVE
NO SCREENSHOT
OF THIS
PROGRAM

Video Basic issue 16 (Gruppo Editoriale Jackson,1985)
Covertape



Video Basic issue 19 (Gruppo Editoriale Jackson,1985)
Covertape



Video Classics (Silverbird Software Ltd,1989)
Compilation



Videomaster (Chris Brown,1991)
Utility



Video Poker (Entertainment USA,1986)
Board/Card Game



Video Basic issue 17 (Gruppo Editoriale Jackson,1985)
Covertape



Video Basic issue 20 (Gruppo Editoriale Jackson,1985)
Covertape



Video Graffiti (AGF,1982)
Utility: Drawing

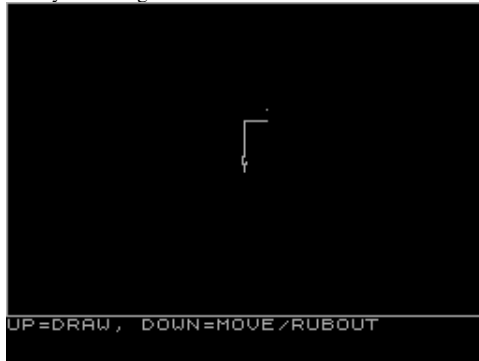

Video Olimpic (Dinamic Software,1986)
Sport



Video Pool (Oxford Computer Publishing,1985)
Sport

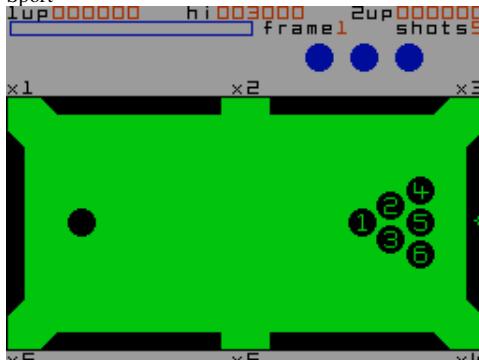

Video Basic issue 18 (Gruppo Editoriale Jackson,1985)
Covertape



Video Card Arcade (CDS Microsystems,1988)
Arcade



Video Hell (Phipps Associates,1984)
Arcade

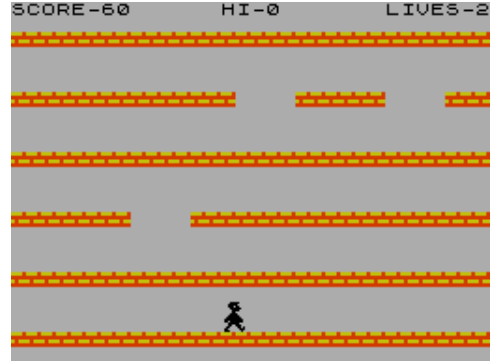

Videopac Emulator (YRS,2000)
Simulation

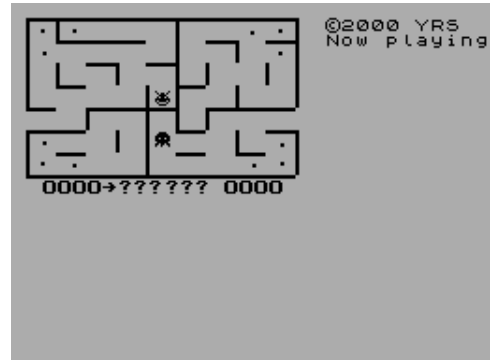

Video Salesman (Virgin Books,1983)
Arcade

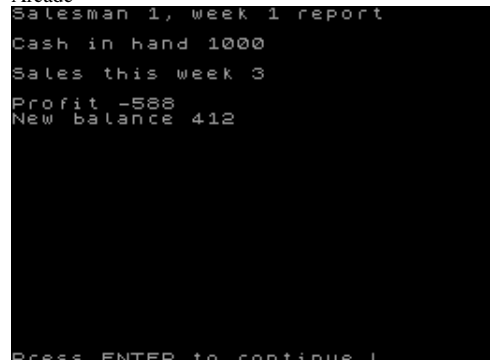

Video Spectrum issue 01 (Video Spectrum,1984)
Covertape

WE HAVE
NO SCREENSHOT
OF THIS
PROGRAM

Video Spectrum issue 02 (Video Spectrum,1984)
Covertape

WE HAVE
NO SCREENSHOT
OF THIS
PROGRAM

Video Spectrum issue 03 (Video Spectrum,1984)
Covertape

WE HAVE
NO SCREENSHOT
OF THIS
PROGRAM

Video Spectrum issue 04 (Video Spectrum,1984)
Covertape

WE HAVE
NO SCREENSHOT
OF THIS
PROGRAM

Video Spectrum issue 05 (Video Spectrum,1985)
Covertape

WE HAVE
NO SCREENSHOT
OF THIS
PROGRAM

Video Spectrum issue 06 (Video Spectrum,1985)
Covertape

WE HAVE
NO SCREENSHOT
OF THIS
PROGRAM

Video Spectrum issue 07 (Video Spectrum,1985)
Covertape

WE HAVE
NO SCREENSHOT
OF THIS
PROGRAM

Video Spectrum issue 08 (Video Spectrum,1985)
Covertape

WE HAVE
NO SCREENSHOT
OF THIS
PROGRAM

Video Spectrum issue 09 (Video Spectrum,1985)
Covertape

WE HAVE
NO SCREENSHOT
OF THIS
PROGRAM

Video Spectrum issue 10 (Video Spectrum,1985)
Covertape

WE HAVE
NO SCREENSHOT
OF THIS
PROGRAM

Video Spectrum issue 11 (Video Spectrum,1985)
Covertape

WE HAVE
NO SCREENSHOT
OF THIS
PROGRAM

Video Spectrum issue 12 (Video Spectrum,1985)
Covertape

WE HAVE
NO SCREENSHOT
OF THIS
PROGRAM

Video Spectrum issue 13 (Video Spectrum,1985)
Covertape

WE HAVE
NO SCREENSHOT
OF THIS
PROGRAM

Video Spectrum issue 14 (Video Spectrum,1985)
Covertape

WE HAVE
NO SCREENSHOT
OF THIS
PROGRAM

Video Spectrum issue 15 (Video Spectrum,1985)
Covertape

WE HAVE
NO SCREENSHOT
OF THIS
PROGRAM

Video Spectrum issue 16 (Video Spectrum,1985)
Covertape

WE HAVE
NO SCREENSHOT
OF THIS
PROGRAM

Video Spectrum issue 17 (Video Spectrum,1986)
Covertape

WE HAVE
NO SCREENSHOT
OF THIS
PROGRAM

Video Spectrum issue 18 (Video Spectrum,1986)
Covertape

WE HAVE
NO SCREENSHOT
OF THIS
PROGRAM

Video Spectrum issue 19 (Video Spectrum,1986)
Covertape

WE HAVE
NO SCREENSHOT
OF THIS
PROGRAM

Video Spectrum issue 20 (Video Spectrum,1986)
Covertape

WE HAVE
NO SCREENSHOT
OF THIS
PROGRAM

Video Spectrum issue 21 (Video Spectrum,1986)
Covertape

WE HAVE
NO SCREENSHOT
OF THIS
PROGRAM

Video Spectrum issue 22 (Video Spectrum,1986)
Covertape

WE HAVE
NO SCREENSHOT
OF THIS
PROGRAM

Video Spectrum issue 23 (Video Spectrum,1986)
Covertape

WE HAVE
NO SCREENSHOT
OF THIS
PROGRAM

Video Spectrum issue 24 (Video Spectrum,1986)
Covertape

WE HAVE
NO SCREENSHOT
OF THIS
PROGRAM

Video Spectrum issue 25 (Video Spectrum,1986)
Covertape

WE HAVE
NO SCREENSHOT
OF THIS
PROGRAM

Video Spectrum issue 26 (Video Spectrum,1986)
Covertape

WE HAVE
NO SCREENSHOT
OF THIS
PROGRAM

Video Spectrum issue 27 (Video Spectrum,1986)
Covertape

WE HAVE
NO SCREENSHOT
OF THIS
PROGRAM

Video Spectrum issue 28 (Video Spectrum,1986)
Covertape

WE HAVE
NO SCREENSHOT
OF THIS
PROGRAM

Video Spectrum issue 29 (Video Spectrum,1987)
Covertape

WE HAVE
NO SCREENSHOT
OF THIS
PROGRAM

Video Spectrum issue 30 (Video Spectrum,1987)
Covertape

WE HAVE
NO SCREENSHOT
OF THIS
PROGRAM

Video Spectrum issue 31 (Video Spectrum,1987)
Covertape



Video Vault (Video Vault Ltd,1987)
Compilation

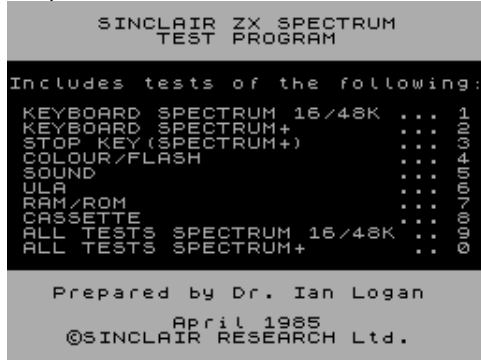

Vientos del Walhalla, Los (Grupo Creators Union,1992)
Text Adventure

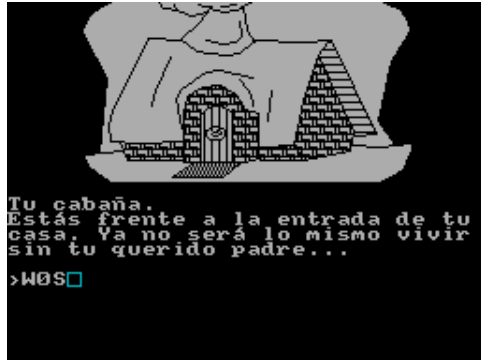

Viewpoint (ACS Software,1982)
Utility: Drawing

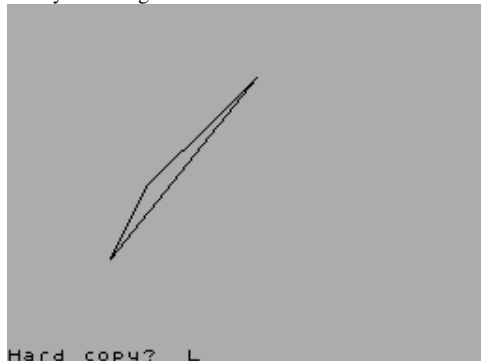

Vigilante (US Gold Ltd,1989)
Arcade



Video Sport (Copper Feet,1992)
Arcade

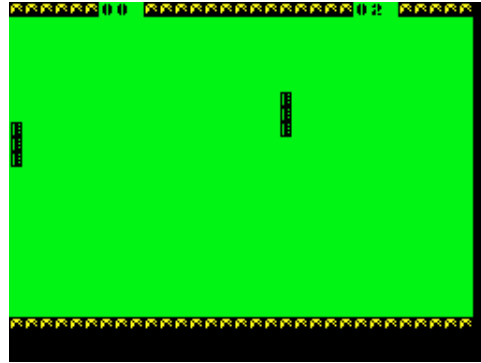

Vidi Party Show (Pentagram,1991)
Scene Demo



Vier Gewinnt (Supersoft [3],1984)
Board/Card Game



View to a Chip, A (Futuresoft,1989)
Text Adventure



Vigilante Patrol (Grafix Wizards,1989)
Arcade



Videostop (CV Software,)
Simulation

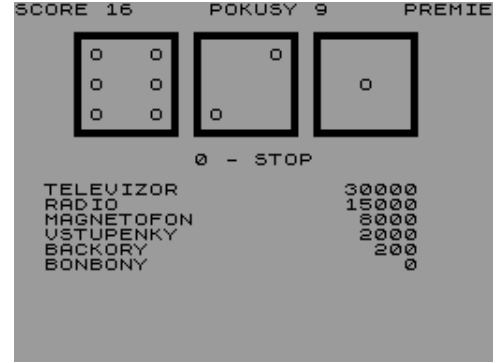

Viejo Archivero, El (Aventuras Level 10,1988)
Text Adventure



Vier op een Rij (,1982)
Board/Card Game

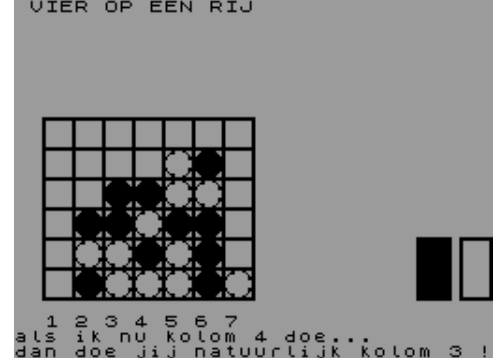

View to a Kill, A (Domark Ltd,1985)
Arcade

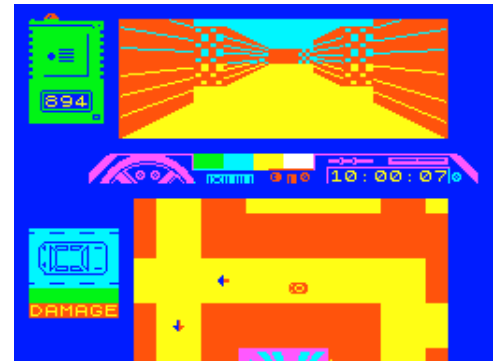

Vigocopy (Relampago de Fuego,1993)
Utility: Copier

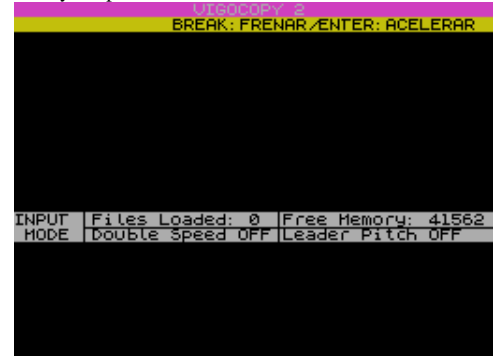

Viking Quest 1: Holmgard (SAM Style,2004)
Arcade Adventure



Vikings (Challenge Software,1989)
Strategy



Village of the Death (Specsoft,)
Text Adventure



Vindicator! (Imagine Software Ltd,1988)
Arcade Adventure

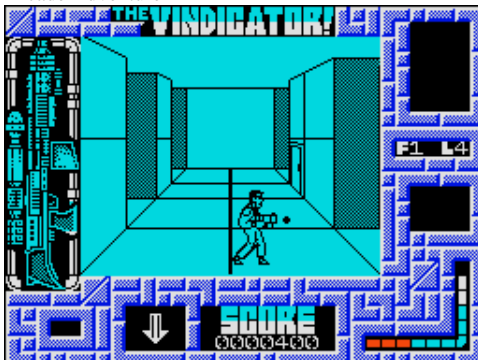

Vino File (Peter Dominic,1985)
Utility

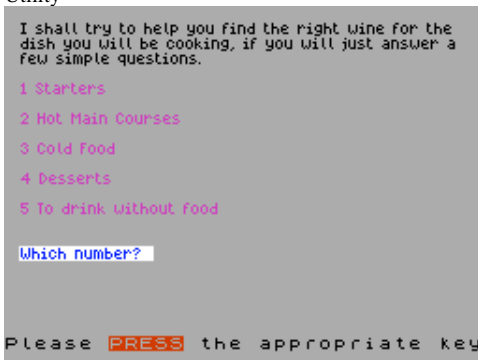

Viking Quest 2: Heart of Town (SAM Style,2005)
Arcade Adventure

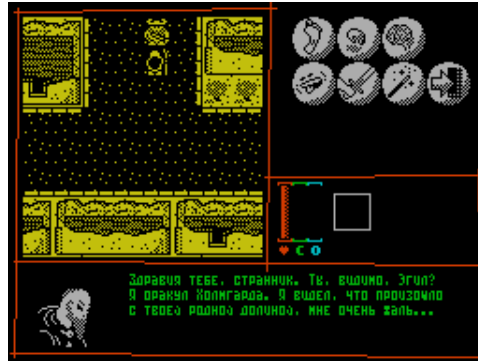

Vikings (Creative Sparks,1987)
Arcade



Village, The (Spectrum Computing,1985)
Text Adventure



Vindicators (Domark Ltd,1989)
Arcade



Violator of Voodoo, The (Zenobi Software,1991)
Text Adventure



Viking Raiders (Firebird Software Ltd,1984)
Board/Card Game



Vikings, The (Status Software,)
Arcade



Ville Fantome, La (,1986)
Text Adventure



Vinnie Jones' Soccer Spectacular (Screen 7 Ltd,1989)
Sport



Violent Universe (Quest Microsoftware,1983)
Arcade



Viper III (Mastertronic Ltd,1984)
Arcade



Virtual Synthesiser (Copyright Control,1985)
Utility: Music Creation

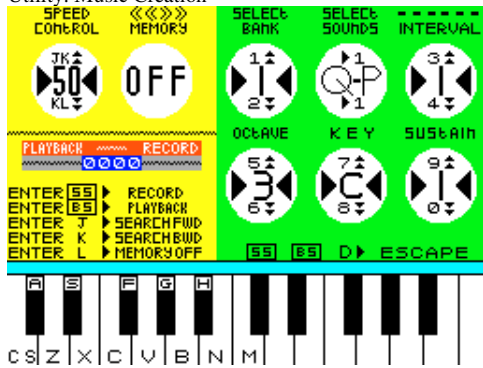

Virus (Orange Software,1984)
Text Adventure



Virus II (S. Kukoviakin,1995)
Board/Card Game

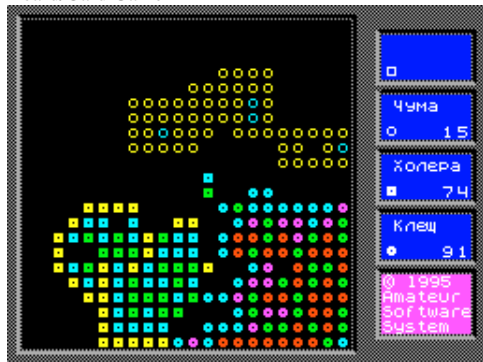

Viselitsa (S.Y.B.,1997)
Arcade



Virgin Atlantic Challenge (Virgin Games Ltd,1986)
Simulation



Virtual Worlds (Domark Ltd,1991)
Compilation



Virus (S. Kukoviakin,1995)
Board/Card Game

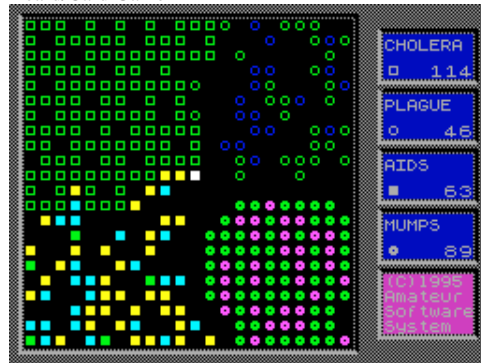

Virus-Maker (Jacek Michalak,1992)
Scene Demo

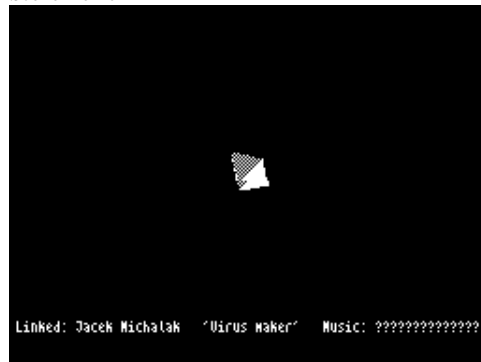

Vises Sten, De (Xcellent Software,)
Text Adventure

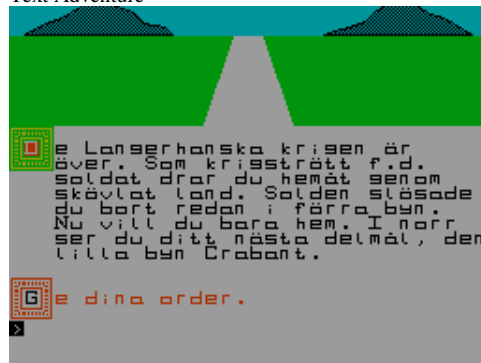

Virgula (Free Group,1994)
Educational

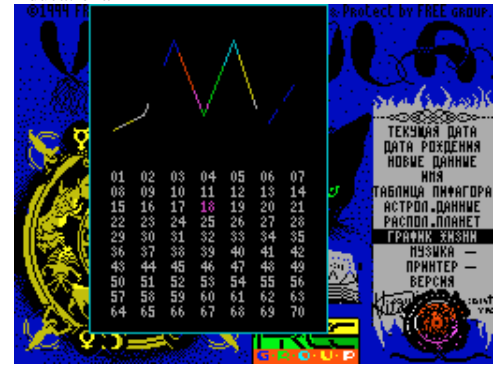

Virus (Firebird Software Ltd,1988)
Arcade



Virus (Spectrum Adventure Exch Club,1988)
Text Adventure



Viscious Vermin (Anik Microsystems,1984)
Arcade



Visibraille (Brian Gaff,1993)
Utility

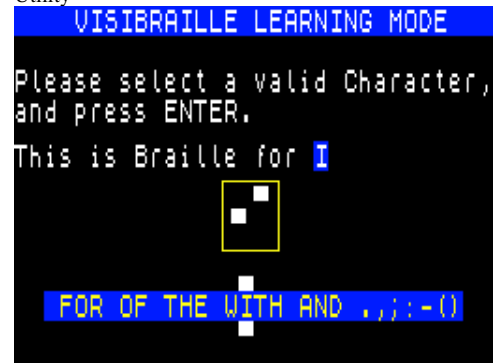

Vision (Individual Software,1987)
Utility



Vityaz Svyatogor & Koldun Karachun (Alexey Shirokov,1995)
Text Adventure

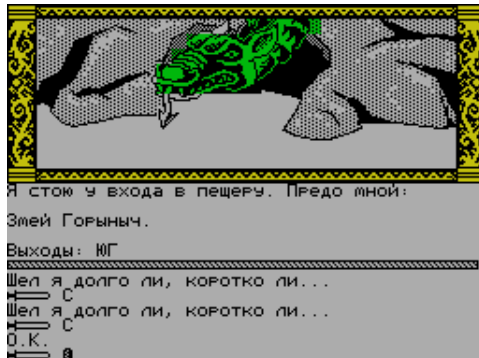

Viz (Fudgepacker,1994)
Scene Demo



VK Devpac 7.8 (Racunari,1985)
Utility: Assembler/Disassembler/Monitor



V-notch (Transform Ltd,1985)
Utility

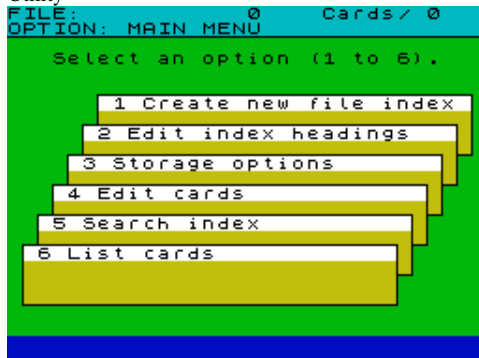

Visual Processor, The (Gilsoft International,1982)
Utility



Vixen (Martech Games Ltd,1988)
Arcade Adventure



Viz - The Computer Game (Virgin Games Ltd,1991)
Arcade



VK Turbo Load (Vladimir Kostic,1985)
Utility: Copier

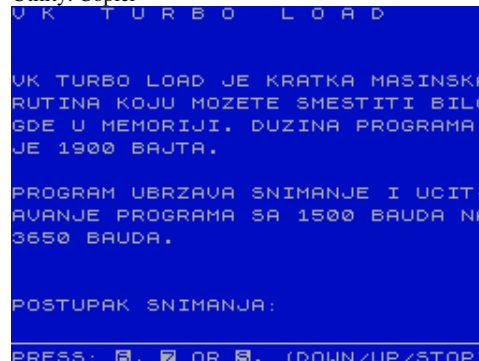

Vocabulario Aleman (Investronica S.A.,1984)
Educational

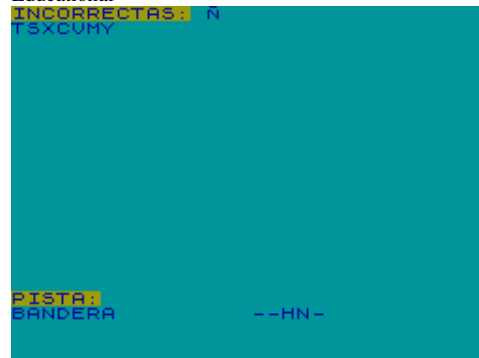

Vitaminas (Erbe Software S.A.,1989)
Compilation

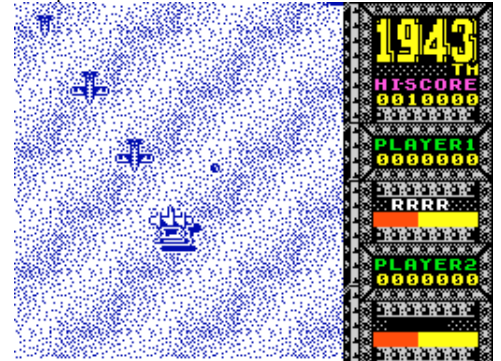

Vix Vix (,)
Arcade



Vjetrenjaca (Suzy Soft,1986)
Arcade



Vlajky II (Jozef Vavrinc,1987)
Simulation



Vocabulario Frances (Investronica S.A.,1984)
Educational

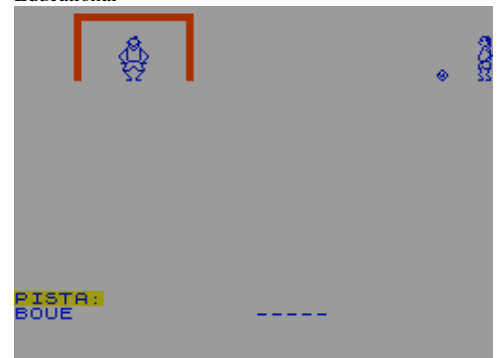

Vocabulario Infantil Aleman (Investronica S.A.,1984)
Educational



Vocabulario Ingles (Investronica S.A.,1984)
Educational

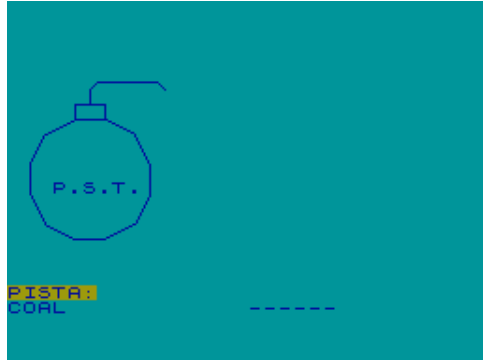

Voice Editor and File Manager (Quasar Software,1988)
Utility



Voice Recognition (.)
Utility: Sound Manipulation

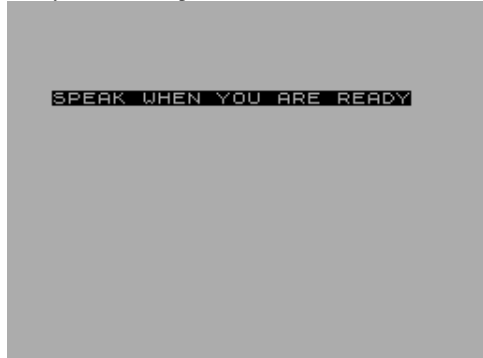

Vokabeltrainer (.)
Educational

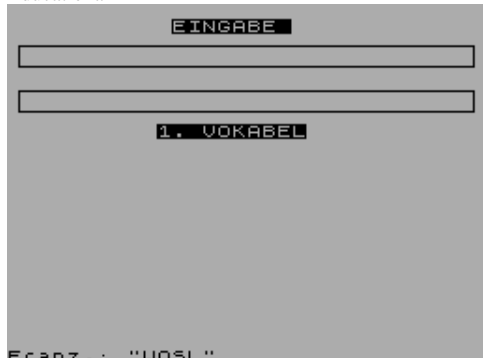

Franz.: "WOSL"

Vocabulario Infantil Frances (Investronica S.A.,1984)
Educational

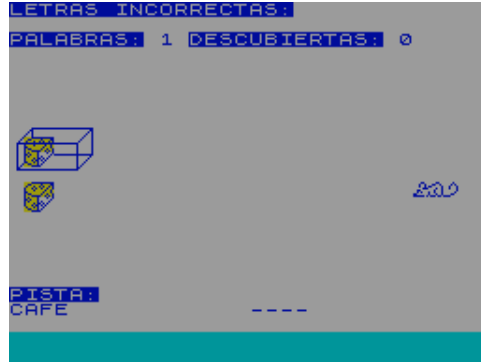

Vocabulary Tests Level 2 (Danik Educational,)
Educational

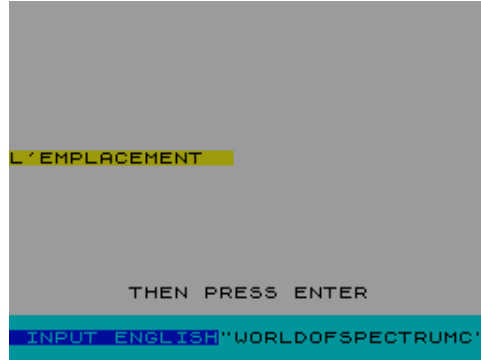

Voice Machine, The (The Israeli Team,1989)
Utility: Sound Manipulation

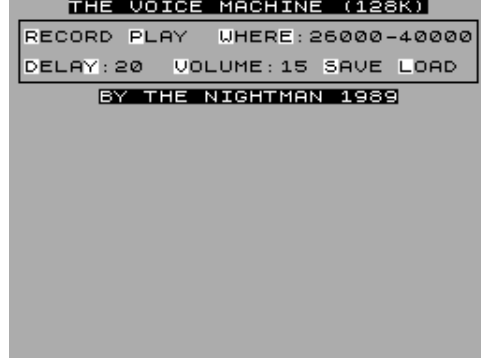

Voidrunner (Mastertronic Added Dimension,1987)
Arcade



Volcanic Dungeon (Carnell Software,1983)
Text Adventure

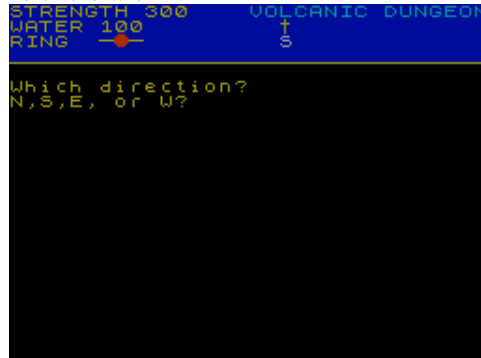

Vocabulario Infantil Ingles (Investronica S.A.,1984)
Educational

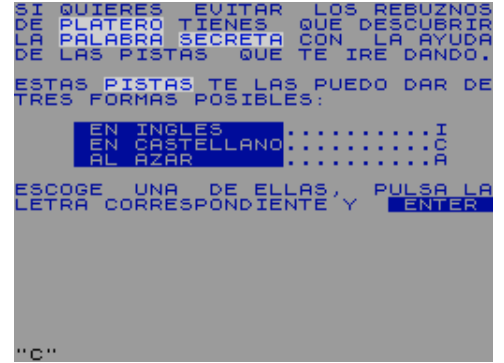

Vogue Cocktails (Boxsoft,1985)
Utility



Voice Manipulator 2 (Crash,1991)
Utility: Sound Manipulation



Vokabeln Lernen (.)
Educational



Volcanic Planet (Thorn Emi Video Ltd,1983)
Arcade



Volcano (Computer Magic,1985)
Arcade



Voodoo Music Pack (VooDoo,)
Scene Demo



VOX (ERE Informatique,1984)
Utility: Sound Manipulation

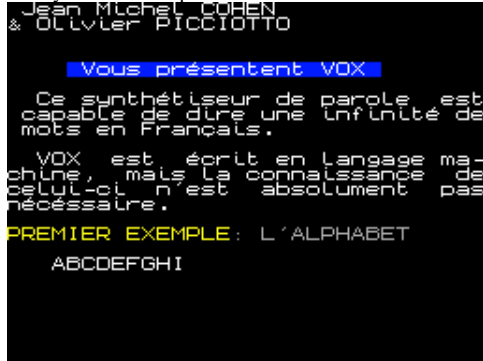

Voyager (Quinstertronic,1987)
Arcade

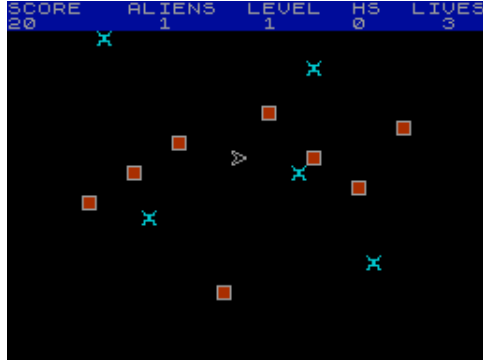

Vruce Letovanje (Suzy Soft,1985)
Text Adventure



Volk (Atrox Programming Co,1989)
Text Adventure

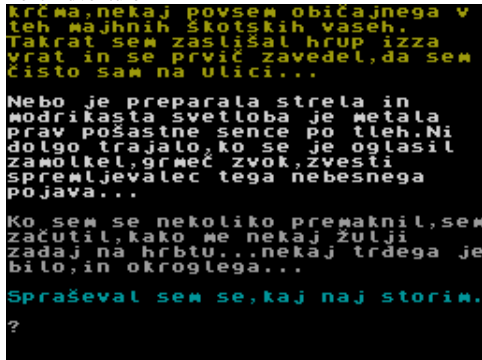

Vortex (16/48 Tape Magazine,1984)
Arcade



Voyage into the Unknown (Mastertronic Ltd,1984)
Arcade

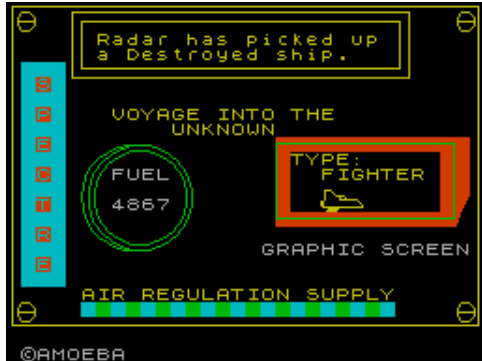

Voyage, The (DEV Software,1986)
Text Adventure



Vs (Bes,1997)
Strategy



Voodoo Castle (Adventure International,1984)
Text Adventure

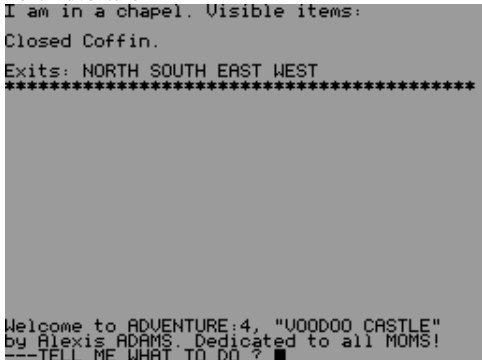

Vortex, 3D (J.K. Greye Enterprises Ltd,1983)
Arcade



Voyager (MicroHobby,1986)
Arcade



Vreme T1/2 (Aleksandar Pavlovic,1986)
Educational

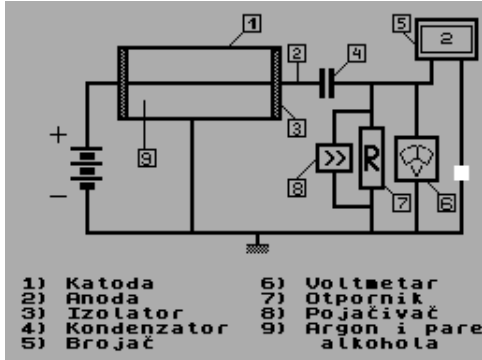

V - The Adventure (Sirius Software,1985)
Text Adventure



V - The Final Battle (Lee Tonks,1984)
Text Adventure

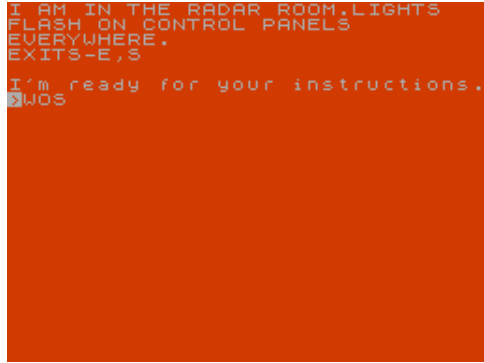

V - The Silver Saucer (Micronet 800 Telesoftware.)
Text Adventure

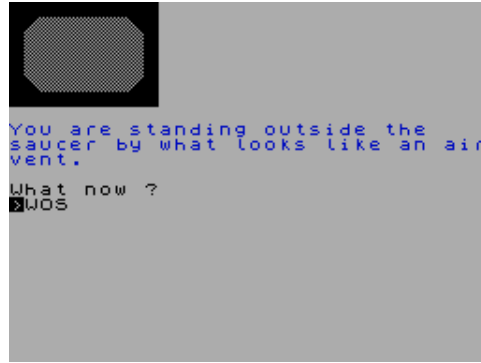

VTX 5000 User To User Communications Software
(O.E. Ltd,1984) Utility



VTX Editor 4.6 (D. Gorski,1985)
Utility



VU-3D (Sinclair Research Ltd,1982)
Utility: Drawing

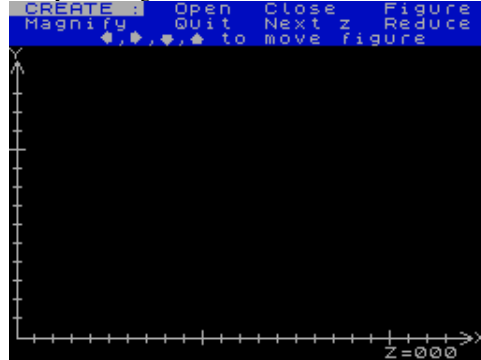

VU-Calc (Sinclair Research Ltd,1982)
Utility: Spreadsheet



Vuelo Espacial (Micromania [2],1985)
Arcade



Vuelta Ciclista (MicroHobby,1985)
Sport



VU-File (Sinclair Research Ltd,1982)
Utility: Database



Vulcan (CCS,1987)
Strategy



Vulcan Missionpack (Daniel Thorlby,2006)
Compilation



Vurro Olimpic (Loko Soft,1992)
Arcade



Wacky Darts (Code Masters Ltd,1991)
Sport

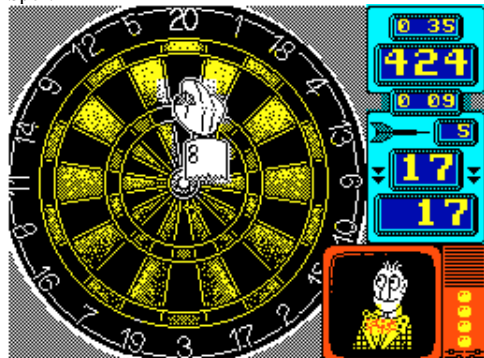

Wacky Races (Hi-Tec Software Ltd,1992)
Arcade

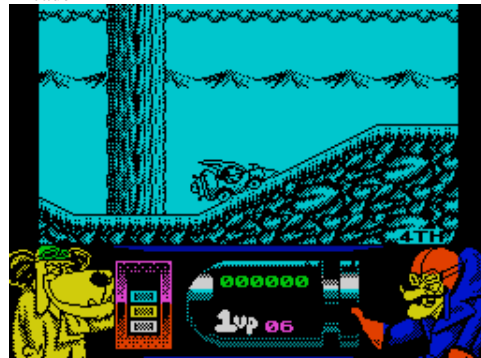

WA Copy (,1985)



Wafa-Drive 1 (Lerm Software,1985)
Utility

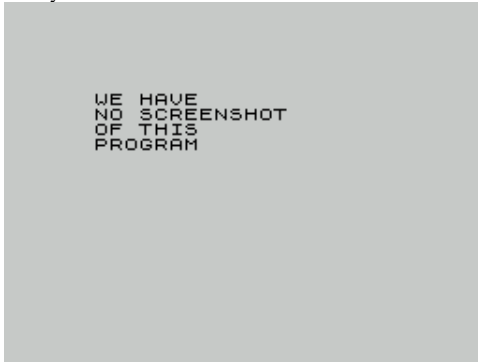

Wage Rate Analysis (Pricing Building Works,1984)
Utility



Wages Records (Transform Ltd,1983)
Utility



Waggle-O-Mania (Dominic Morris,1993)
Arcade



Waiter, Waiter (Coolguys Ltd,1988)
Scene Demo

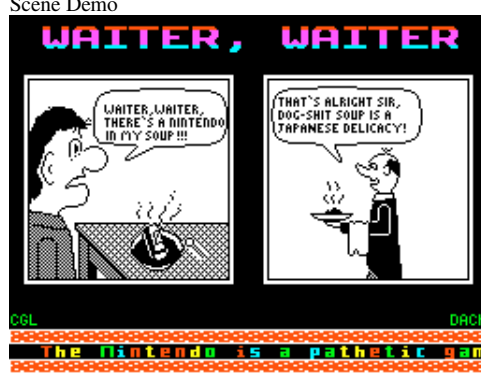

Walker (Alien Factory,1996)
Arcade

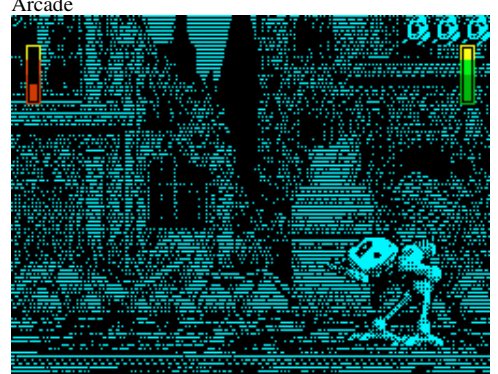

Walkman (Softhouse Ltd,1993)
Scene Demo

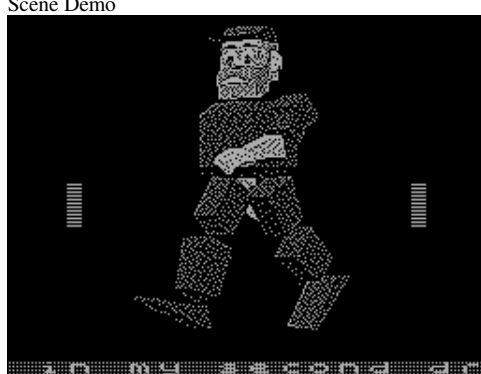

Wall (Softhouse Ltd,1992)
Scene Demo



Wallet (Supersoft [3],1983)
Arcade

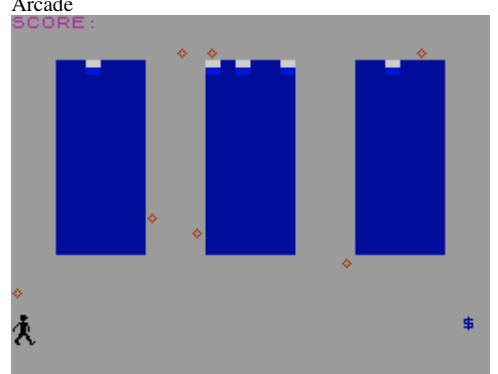

Wall Walk (T. Tang,1983)
Arcade

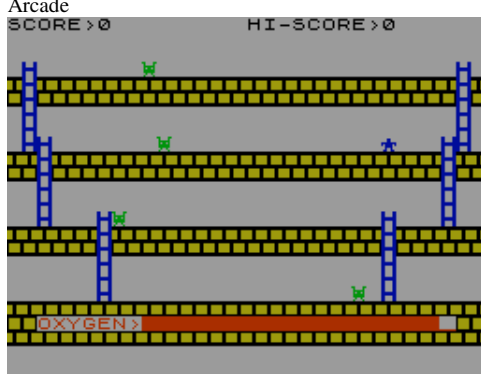

Wally Kong (Walltone Software,1984)
Arcade

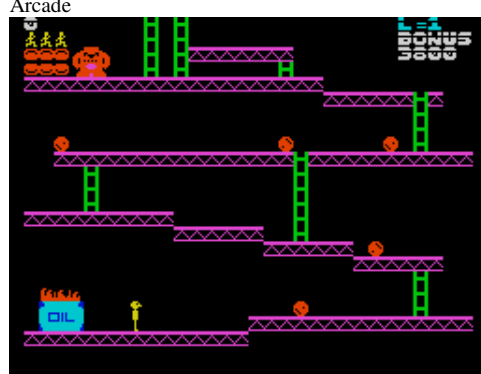

Wamwort (David Calandra Reula,1989)
Text Adventure



Wanderer (Elite Systems Ltd,1989)
Arcade



Wanker (Fudgepacker,1996)
Scene Demo

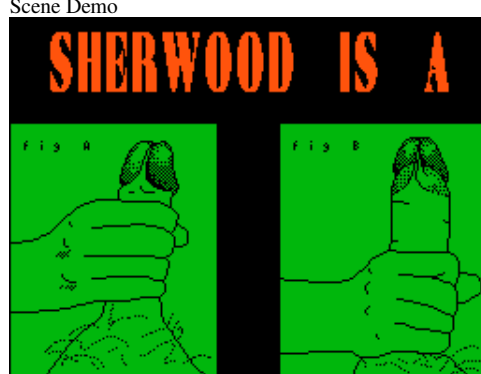

Wanted: Monty Mole (Gremlin Graphics Software Ltd,1984)
Arcade



W.A.R. (Martech Games Ltd,1986)
Arcade

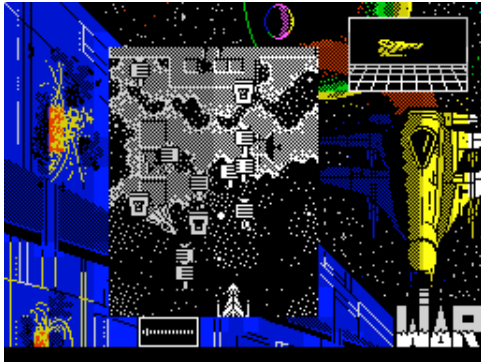

Warcraft (G-Software,1997)
Strategy

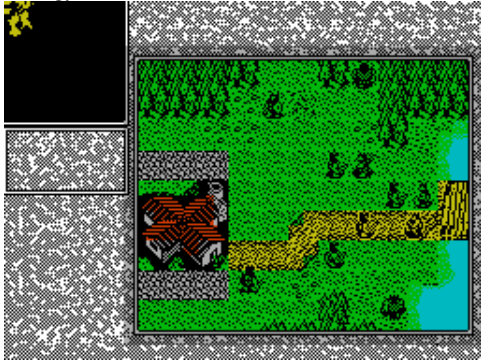

War Game (Abbex Electronics,1984)
Arcade



War Game 1812 (Reelax Games,1985)
Strategy



War in the East (Tk Computerware,1985)
Strategy



War 70 (CCS,1983)
Strategy

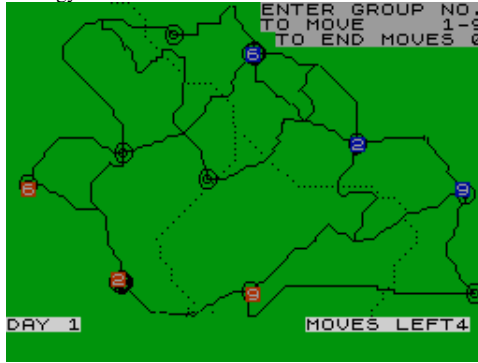

Warcry! (Arena Software,1987)
Text Adventure



War Game (MicroHobby,1985)
Strategy



Wari (16/48 Tape Magazine,1984)
Board/Card Game



Warland (MicroHobby,1986)
Arcade



War Cars Construction Set (Firebird Software Ltd,1987)
Arcade

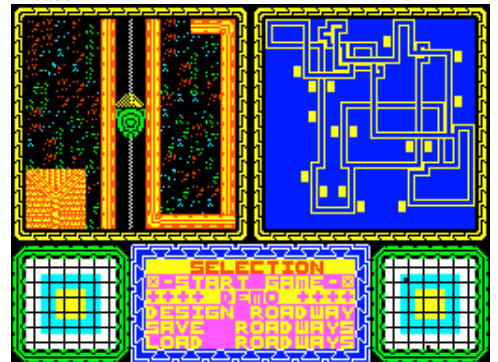

War for Territory (D. Morozz,1998)
Strategy

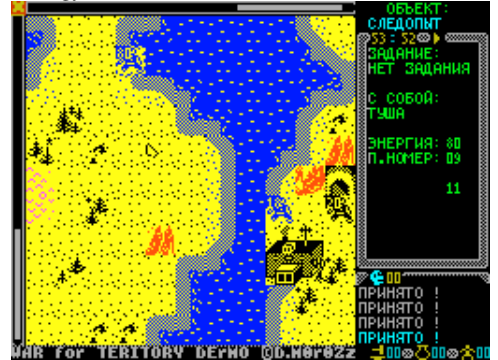

War Game (Reelax Games,1986)
Strategy



War in Middle Earth (Melbourne House,1989)
Strategy

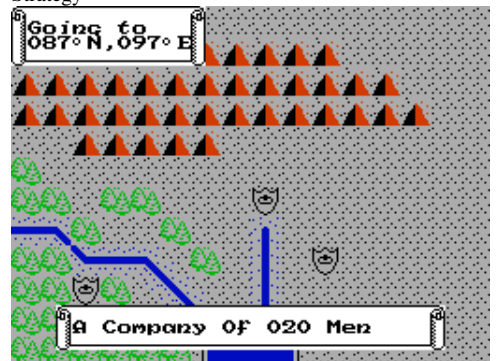

Warlock (The Edge Software,1988)
Arcade Adventure



Warlock of Firetop Mountain, The (Puffin Books,1984)
Arcade Adventure



Warlord (Interceptor Micros Software,1985)
Text Adventure



War Machine (Players Premier Software,1989)
Arcade



War of the Worlds (Meow Micros,1983)
Arcade



Warp 10 (Mole Software,1985)
Arcade



Warlock's Treasure, The (CRL Group PLC,1984)
Text Adventure

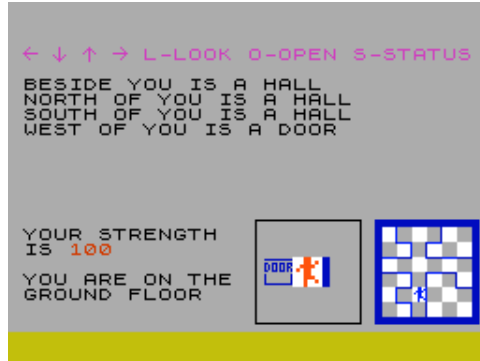

Warlord (MC Lothlorien Ltd,1982)

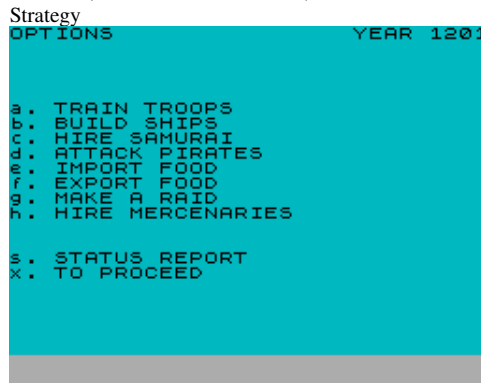

Warmaster Pack (Paxman Promotions,)
Compilation

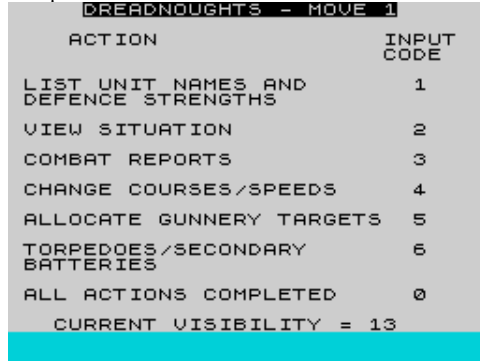

War of the Worlds (Oscar Systems,1983)
Strategy



Warp Factor 6 (Wildest Dreams,1986)
Arcade

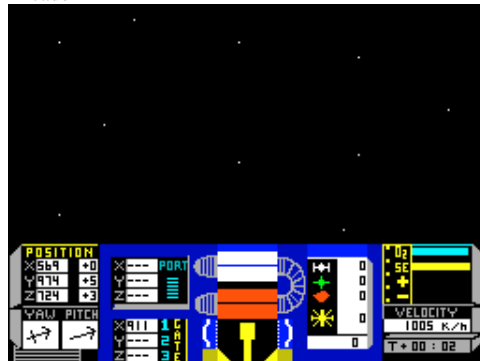

War-Lord (.)
Text Adventure

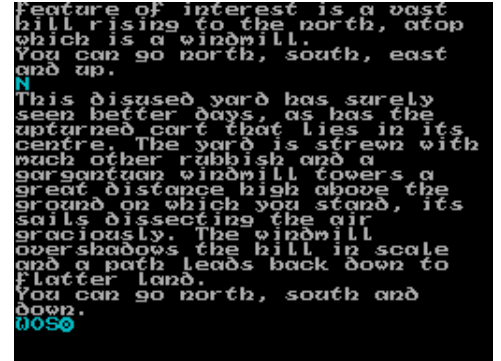

Warlords (Century Software [1],1985)
Arcade



Warning Demo (Flash Inc,1996)
Scene Demo



War of the Worlds, The (CRL Group PLC,1984)
Text Adventure



Warrior Mage (Fontana Publishing,1982)
Text Adventure



Warriors Revenge (Video Force,1984)
Text Adventure

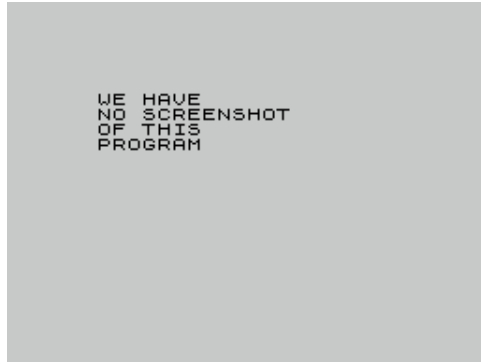

War Tower (Loko Soft,1993)
Arcade



W.A.S.P. (Alpha-Omega Software,)
Arcade



Watermill (THD,1993)
Arcade

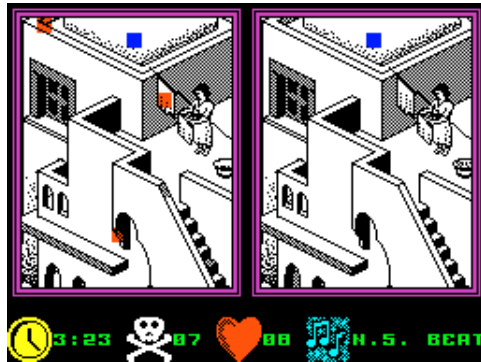

Watson (J. Branegan,)
Utility

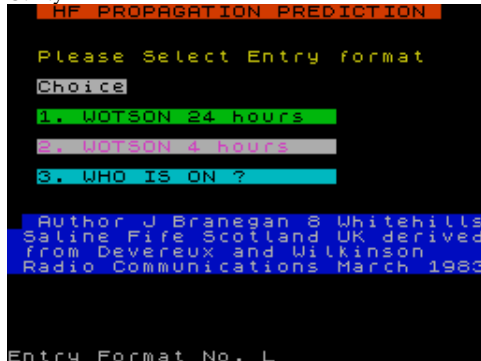

Wars of the Roses, The (CCS,1991)
Strategy



War Zone (CCS,1984)

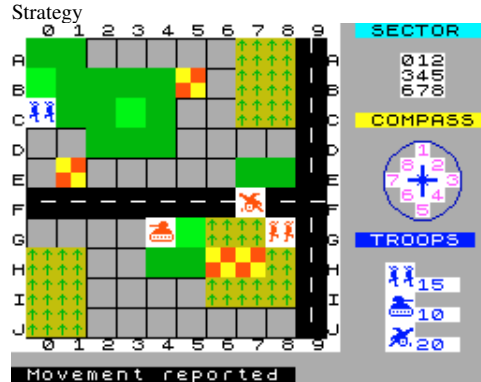

Watching You (Peter Rennefeld,1996)
Scene Demo

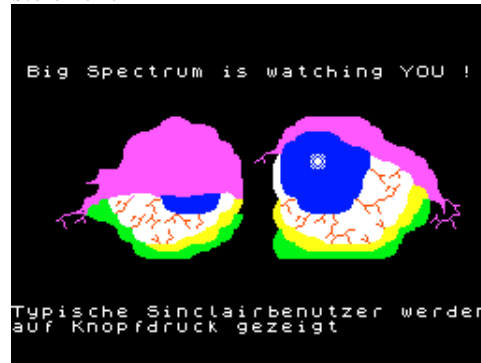

Water Music (Software Cottage,1983)
Educational



Waves (Sinclair Research Ltd,1982)
Educational



Warstat (View Software,1985)
Strategy



Wash 'n' Slosh (5D Software,1984)
Arcade

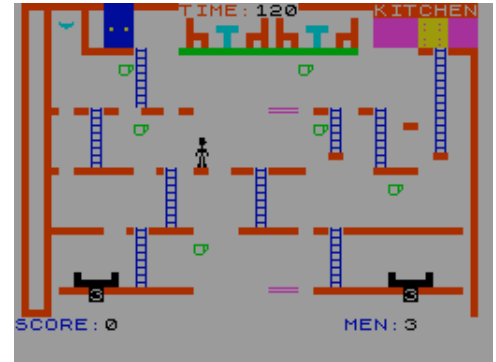

Waterloo (MC Lothlorien Ltd,1985)
Strategy



Waterworks (FREDSOFT,1993)
Text Adventure



WAV Play (Datasoft,1985)
Utility

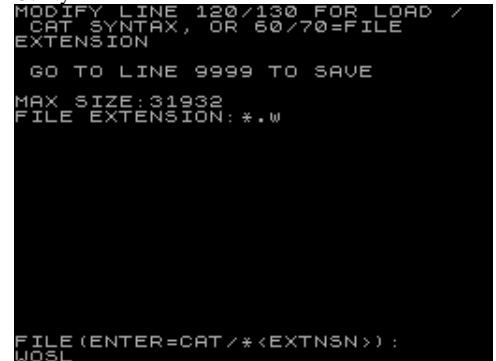

Waxworks (Digital Fantasia,1983)
Text Adventure



Way of the Exploding Fist, The (Melbourne House,1985)
Sport



Way Out (KYO Corp,1996)
Arcade

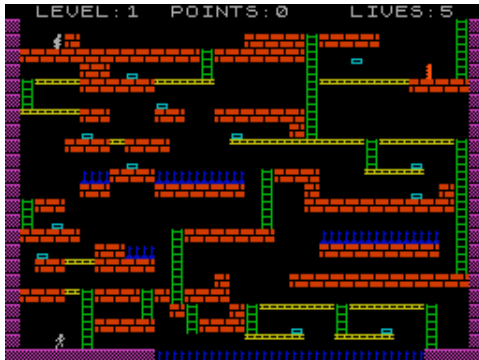

Weasel Willy (Firebird Software Ltd,1985)
Arcade



Weather Station (Arnold Wheaton Software,1985)
Educational



Waydor (IMS Software,1984)
Text Adventure



Way of the Exploding Tits, The (Shattered Dreams,1988)
Text Adventure

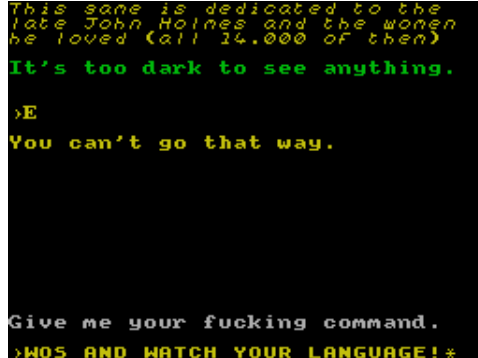

WD1b - Tape to Drive (Lerm Software,.)
Utility: Copier



Weathermaster (Macmillan Software Ltd/Sinclair Research Ltd,1984) Educational

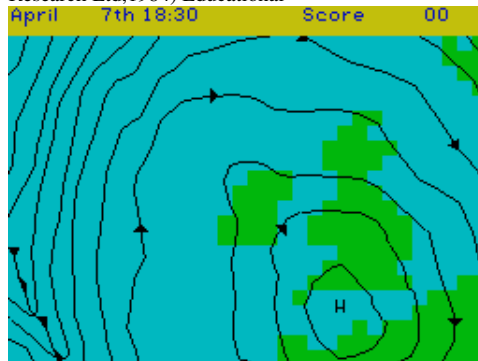

Weaver of Her Dreams, The (8th Day Software,1988)
Text Adventure

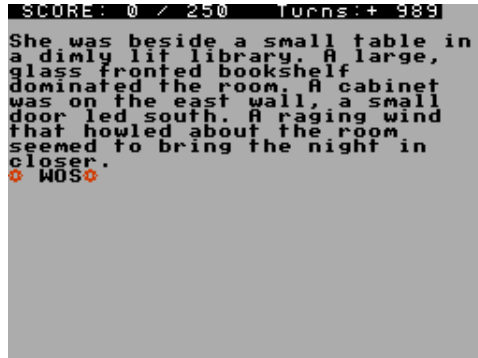

Way of Clans, The (Orion,1996)
Arcade

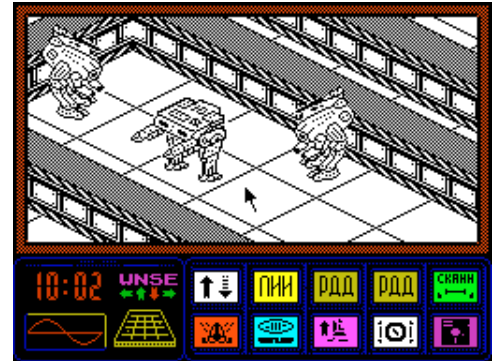

Way of the Tiger, The (Gremlin Graphics Software Ltd,1986)
Sport



We Are the Champions (Ocean Software Ltd,1988)
Compilation



Weather Picture Printing (C. Grant Dixon,1988)
Utility



Web Runner (Sinclair Programs,1984)
Arcade

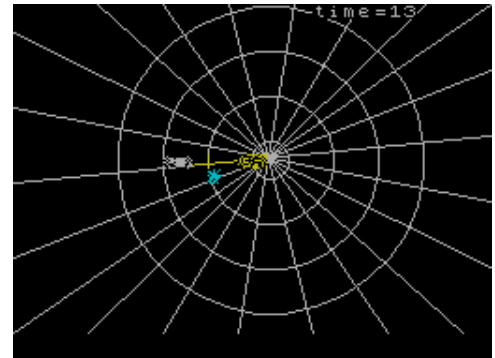

WEC Le Mans (Imagine Software Ltd,1988)

Sport



Wee Adventure (Enigma Software

Developments,1991)

Text Adventure



Weed Attack (5D Software,1985)

Arcade

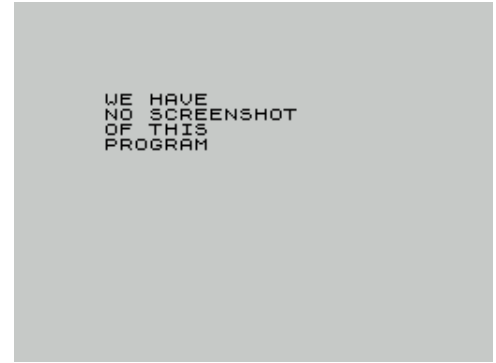

Weedkiller (Your Computer,1983)

Arcade



Weeny Drumkit, The (ACP,1990)

Utility: Music Creation



Weetabix versus The Titchies (Romik Software,1984)

Arcade



Weichi 84 (A.B. Wang,1984)

Board/Card Game

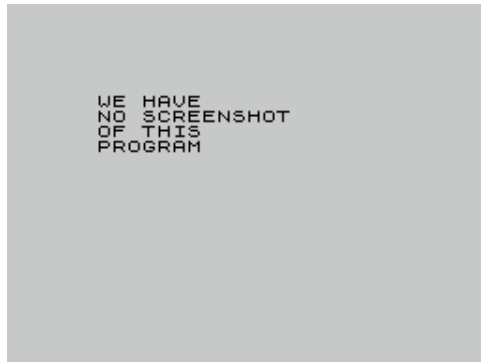

Weird Dreams (Rainbird Software Ltd.)

Arcade Adventure

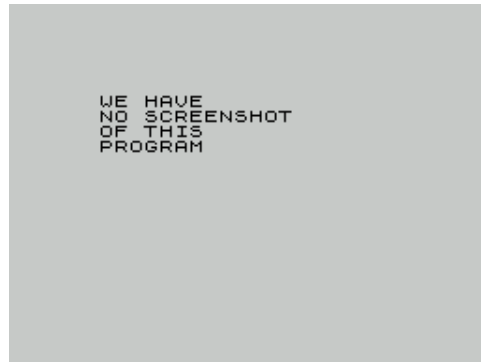

Weird Science Megademo 1 (Weird Science

Software,1992)

Scene Demo



Welcome to Amiga World (Fanatic Stas.)

Scene Demo



Well 2, The (Beyker Soft,2006)

Arcade



Wellington at Waterloo (CCS,1989)

Strategy



Well of Zol, The (Zenobi Software,1994)

Text Adventure

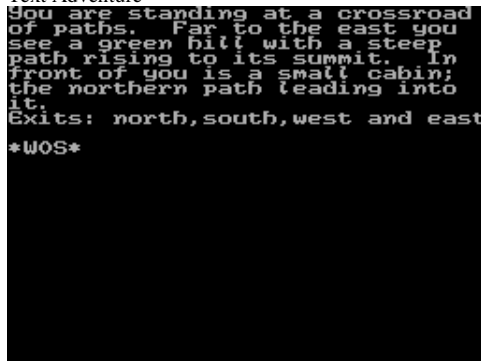

Wells 'n' Fargo (Topo Soft,1988)

Arcade

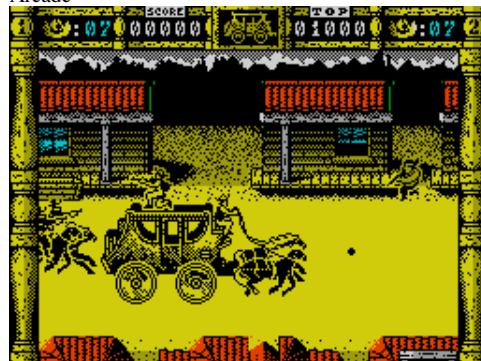

Welltris (Infogrames,1991)

Arcade

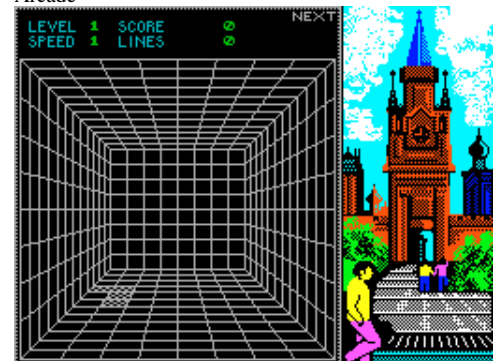

Weltuhr (.)
Utility



Wender Bender - Question Tape 2 (Rankshigh Ltd,1984)
Board/Card Game



Werewolves of London (Mastertronic Ltd,1989)
Arcade Adventure



West Bank (Dinamic Software,1985)
Arcade

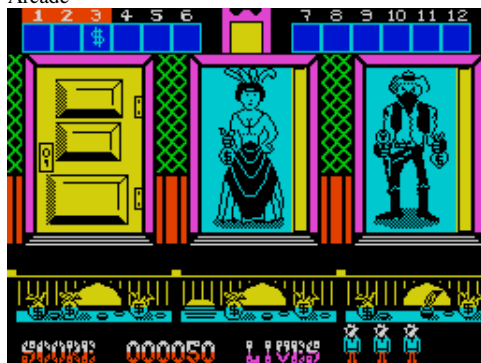

Westminster (Mr. Chip Software,1984)
Simulation



Wembley Greyhounds (D&H Games,1988)
Simulation



Wentworth West and East (Hornby Software,1983)
Sport

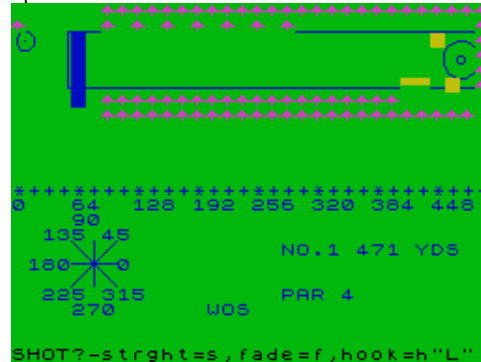

Wergild (Bugbear Software,1989)
Text Adventure

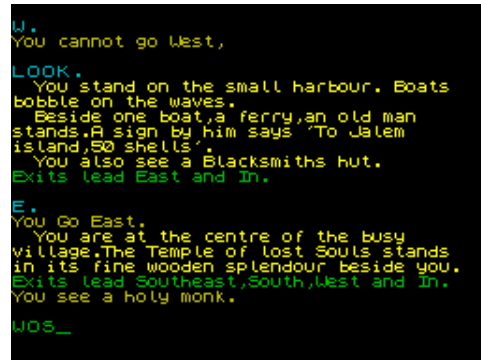

Western Girl, The (Spu,1988)
Arcade



Westrail (Dee-Kay Systems,1984)
Simulation

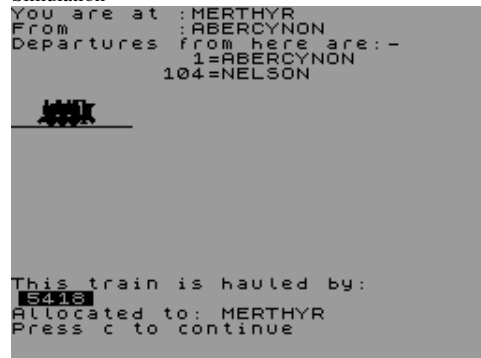

Wender Bender (Rankshigh Ltd,1984)
Board/Card Game



Werewolf Simulator (Top Ten Software,1988)
Text Adventure



Werner's Quest (Lars Persson,1986)
Text Adventure

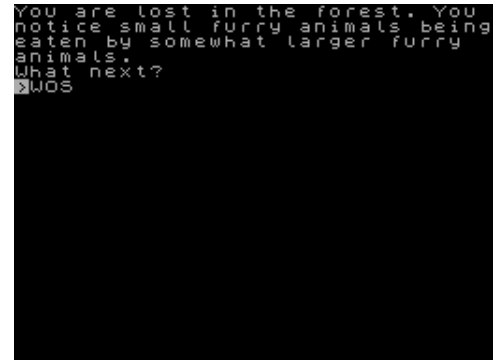

West Gun (Beyker Soft,2004)
Arcade

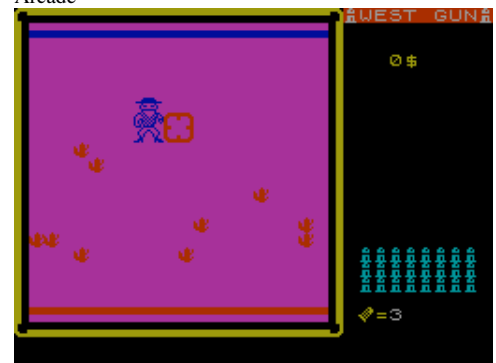

Wesly (.)
Arcade



Wham! The Music Box (Melbourne House,1985)
Utility: Music Creation



What Now 1 (Venturesoft,1993)
Compilation



What the Butler Saw (R'n'H Microtec,1987)
Compilation

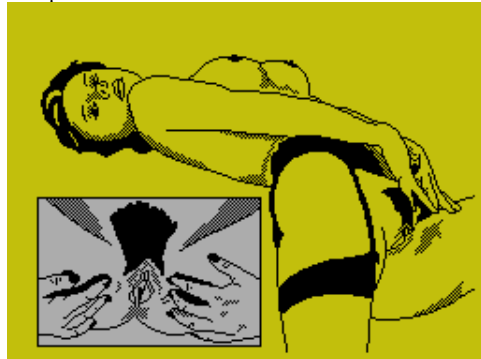

Wheelin Wallie (Interceptor Micros Software,1985)
Arcade



Where Time Stood Still (Ocean Software Ltd,1988)
Arcade Adventure



What Demo (Snow Man,1991)
Scene Demo



What Now issue 1b (What Now Tapezine,1993)
Simulation



Wheeler Dealer (Mr. Chip Software,1983)
Simulation



Wheels of Fire (Domark Ltd,1990)
Compilation



Which? Taxcalc 1983-84 (Sinclair Research Ltd,1984)
Utility

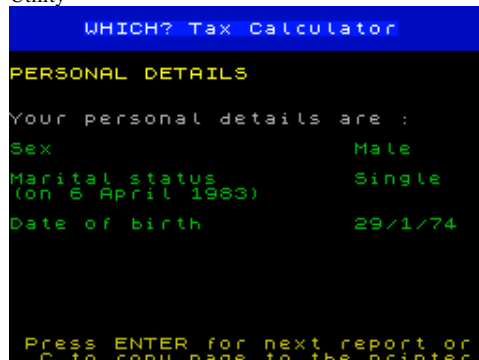

What is Inflation? (Garry Rowland,1993)
Utility

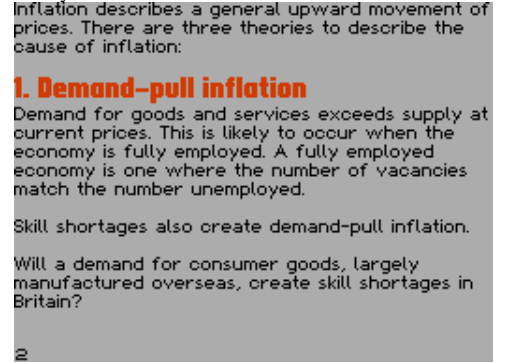

What's the Time? (Collins Educational,1983)
Educational

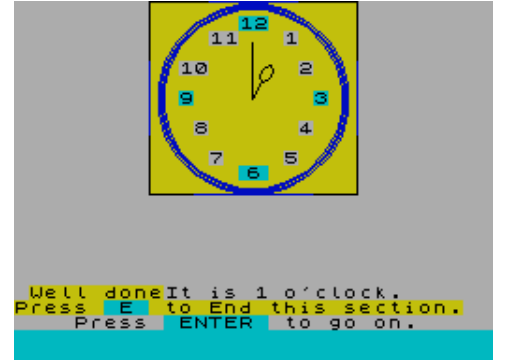

Wheelie (Microsphere,1983)
Arcade



Where Is Zeus (The Adventure Workshop,1996)
Text Adventure



Which? Taxcalc 1984-85 (Consumers' Association,1985)
Utility

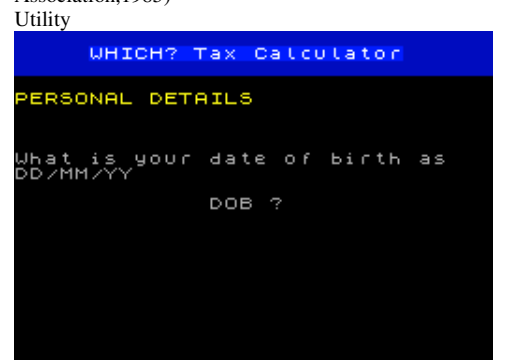

Which? Taxcalc 1985-86 (Consumers' Association,1986)
Utility

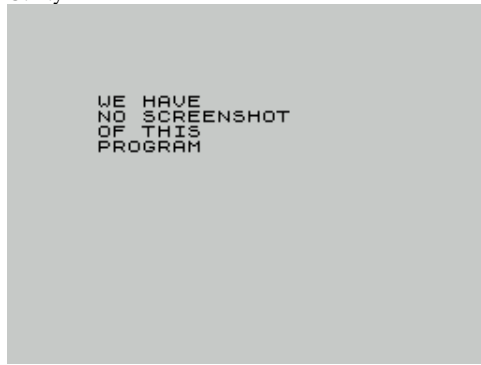

Which? Taxcalc 1986-87 (Consumers' Association,1987)
Utility

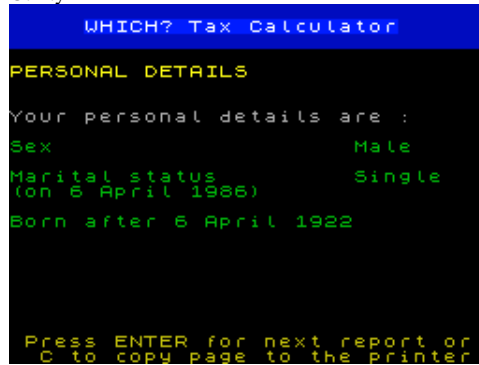

Which? Taxcalc 1987-88 (Consumers' Association,1988)
Utility

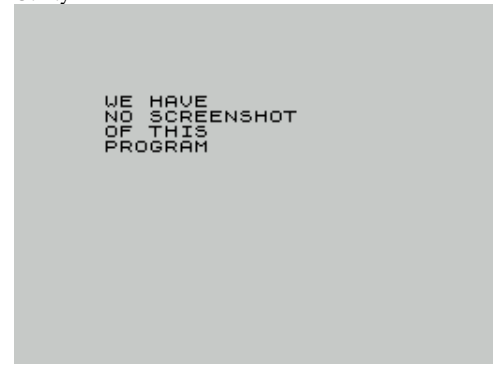

Which? Taxcalc 1988-89 (Consumers' Association,1989)
Utility

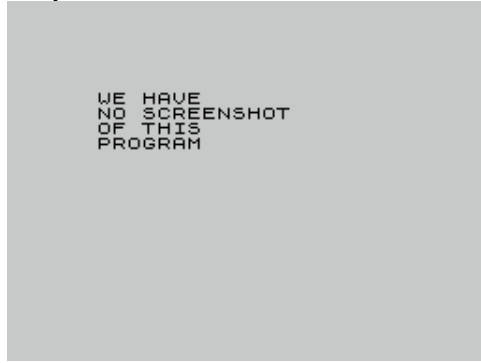

Whirlwind (Lyndenhurst Ltd,1983)
Arcade



Whistle (,)
Text Adventure

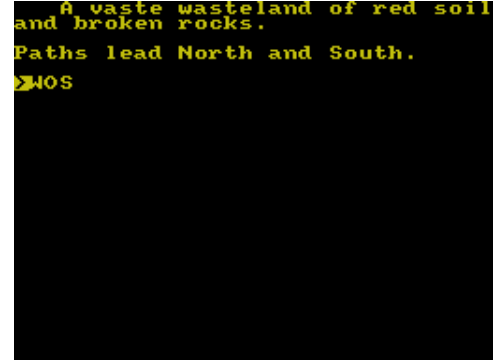

White Barrows, The (ASP Software Ltd,1983)
Text Adventure

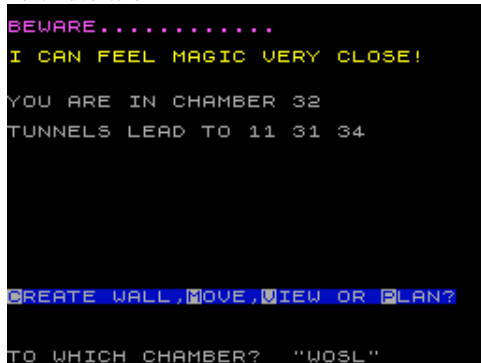

White Door, The: Crisis at Christmas (Tartan Software,1987) Text Adventure

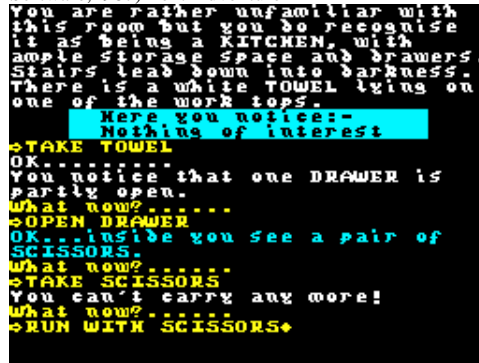

White Feather Cloak, The (Zenobi Software,1992)
Text Adventure

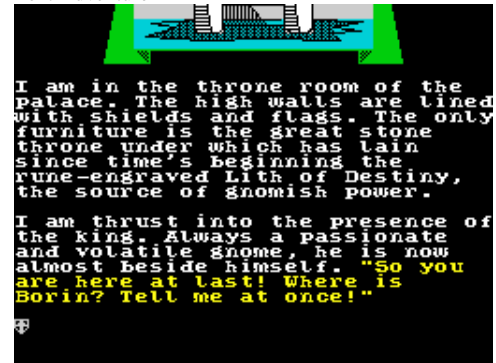

White Heat (Code Masters Ltd,1987)
Arcade



White House Assault (,1984)
Text Adventure



White Lightning (Oasis Software,1984)
Utility: Programming



White Noise and Graphics (Gilsoft International,1984)
Utility



Whitman Day (Advanced Adventure Creations,1992)
Text Adventure



Whizz Kid (Ocean Software Ltd,)
Arcade



Whizz Kid (Unique,1984)
Arcade

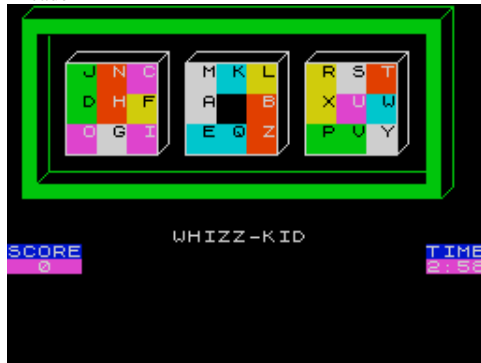

Whodunnit? (CCS,1984)
Board/Card Game

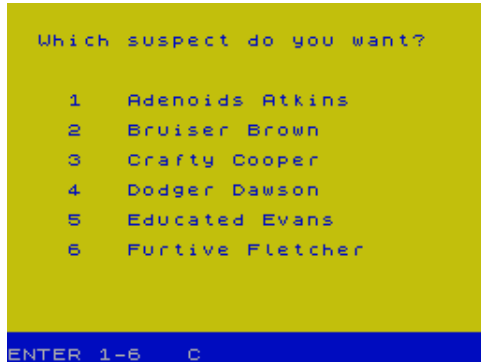

Who Framed Roger Rabbit? (Activision Inc.)
Arcade

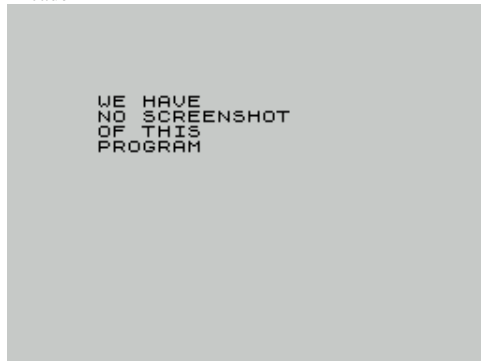

Whole New Ball Game, A (Crash,1989)
Arcade

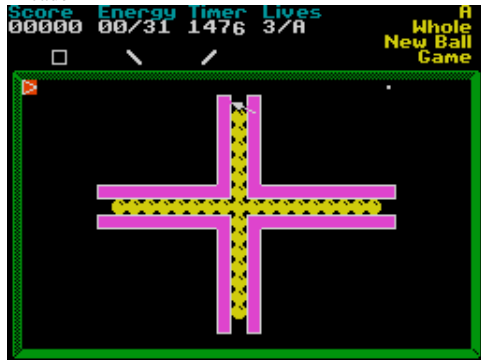

Who Said That? (Tynesoft,1987)
Arcade



Who Dares Wins (East Midland Software,1983)
Text Adventure



Whodunnit (Mastertronic Ltd,1984)
Board/Card Game



Who Helps? (Teacher's Pet Software,1988)
Educational



Whoops! Another Big Disk (Zenobi Software,)
Compilation

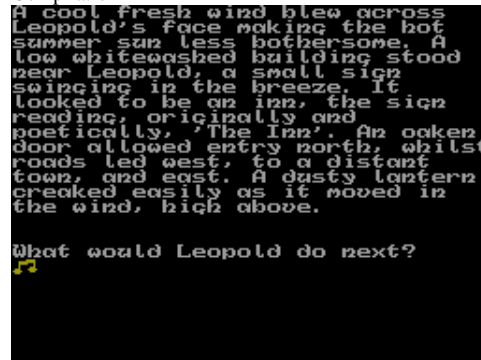

Who Would Be King (David Bayliss,1983)
Strategy



Who Dares Wins II (Alligata Software Ltd,1986)
Arcade



Whodunnit + Alcatraz Harry (Mastertronic Ltd,1984)
Compilation



Who Killed Cock Robin? (Widgit Software Ltd,1983)
Educational



Whopper Chase (Erbe Software S.A.,1987)
Arcade

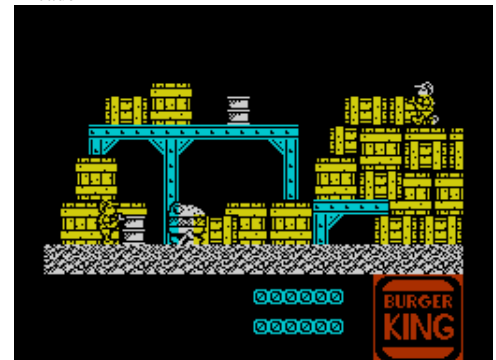

Why is the World Round Anyway ...? (Zenobi Software,1995)
Text Adventure

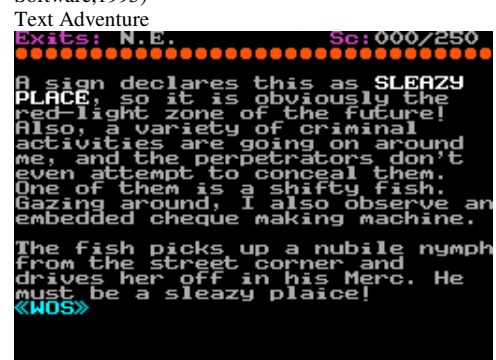

Wibstars (A'n'F Software,1987)



Wiking (M.K. Circuits,1987)



Wild Cat Part 2 (Sean Adams,1990)



Wild Water (Bug-Byte Software Ltd,1989)

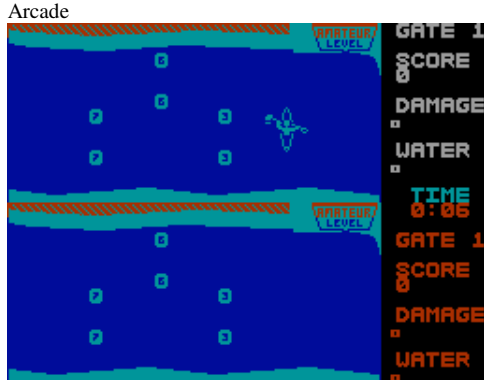

Wild West Seymour (Code Masters Ltd,1992)

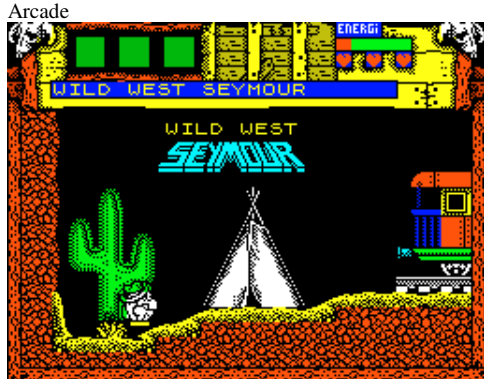

Wicked (Cat Man,1991)

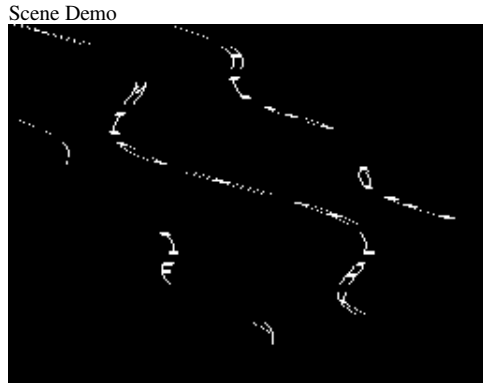

Wild Bunch, The (Firebird Software Ltd,1984)



Wild Cat Part 3 (Sean Adams,1990)



Wild West (Omega Software Ltd,1983)



Wild Words (Longman Software,1983)



Width of the World, The (Mosaic Publishing Ltd,1984)

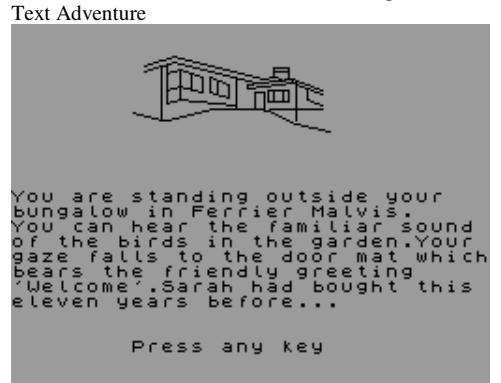

Wild Cat Part 1 (Sean Adams,1990)



Wild Streets (Titus,1990)

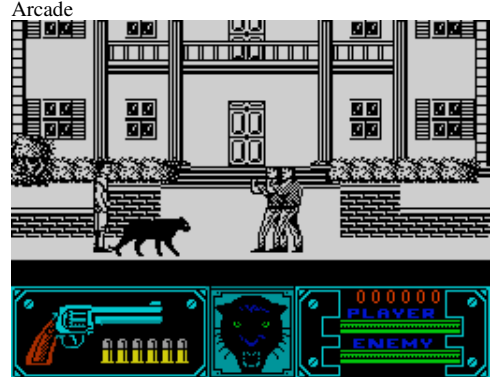

Wild West Hero (Timescape Software,1983)



Wilfred the Hairy, Olaf the Hungry (Microbyte,1984)

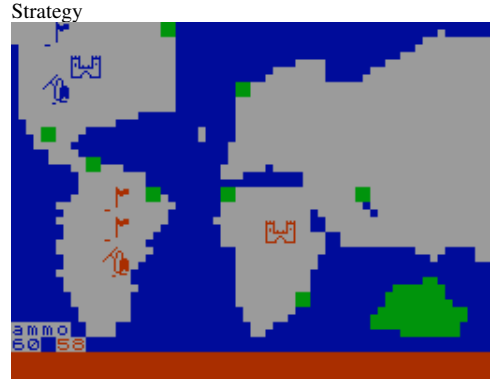

William Wobbler (Wizard Software,1986)
Arcade



Willow Pattern (Firebird Software Ltd,1985)
Arcade Adventure



Windows - Division (Busy Bee Software,1983)
Educational



Winged Avenger + Cowboy (Investronica S.A.,1983)
Compilation



Winged Warlords (CDS Microsystems,1983)
Arcade



Willibald (Zuheir Urwani,1984)
Text Adventure

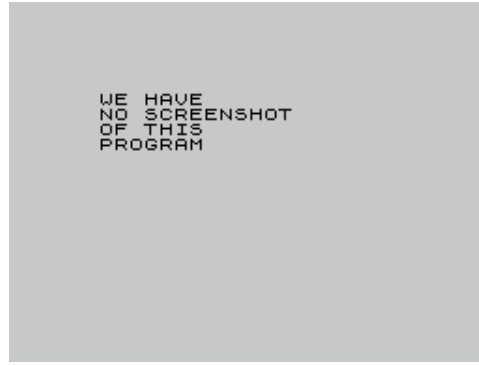

Willy Tournament 2004 (Mark Woodmass,2004)
Arcade



Wind Surfer (K'Soft Ltd,1986)
Arcade



Winged Avenger MkII, The (Work Force,1982)
Arcade



Winners (US Gold Ltd,1990)
Compilation



Willie "El Travieso" (MicroHobby,1986)
Arcade

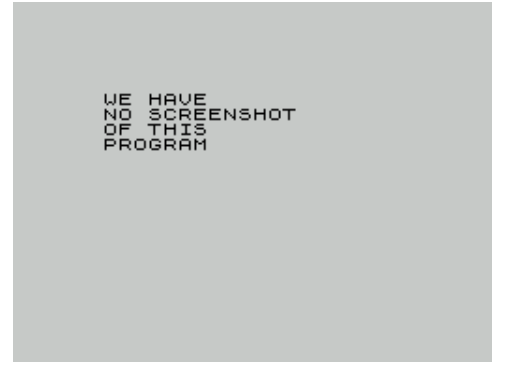

Wimbledon Challenge (T.J. Adcock,1985)
Sport



Winer Milly (Bug Bitten Ltd,)
Arcade



Winged Avenger, The (Work Force,1982)
Arcade

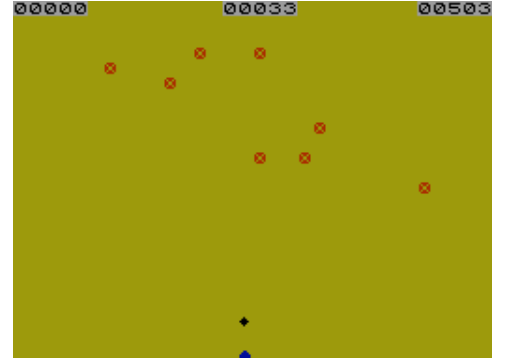

Winner Takes a Holiday (AVP Computing,1986)
Educational



Winner Takes All (Jemel Soft,1983)
Board/Card Game



Winner Takes It All (Djh Software,1984)
Board/Card Game



Winnie-the-Pooh (Softland,1996)
Arcade Adventure



Winning Games on the ZX Spectrum (Ellis Horwood Ltd,1984)
Compilation



Winning Team, The (Domark Ltd,1991)
Compilation



Winter Games (US Gold Ltd,1986)
Sport



Winter Olympiad '88 (Tynesoft,1988)
Sport



Winter Sports (Electric Dreams Software,1985)
Sport



Winter Term (Ad. Lomer,1989)
Text Adventure



Winter Wonderland (Incentive Software Ltd,1986)
Text Adventure



Wipe-Out (Precision Software Engineering,1983)
Arcade



Wipper (Load 'n' Run [Spa],1985)
Arcade

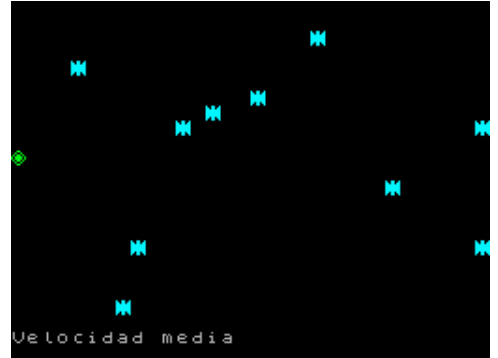

Wise and Fool of Arnold Blackwood (,)
Text Adventure



Witchcraft (Josep Coletas Caubet,2006)
Text Adventure

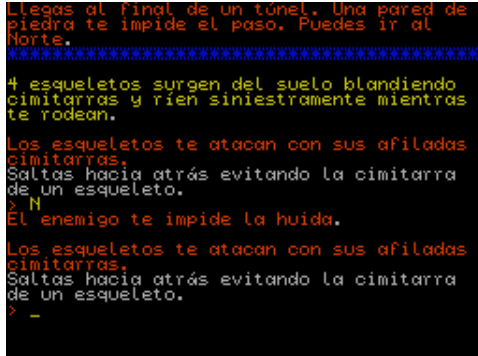

Witch Cult (Aventuras AAC,)
Text Adventure



Witchfiend (Strobe,1986)

Arcade Adventure



Witchfiend + Odd Job Eddie (Strobe,1985)

Compilation



Witch Hunt (River Software,1987)

Text Adventure

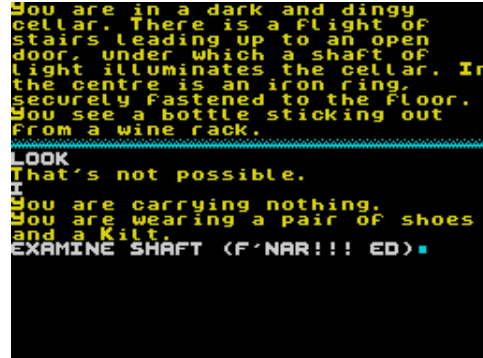

Witch Hunt + The Cup (River Software,1987)

Compilation

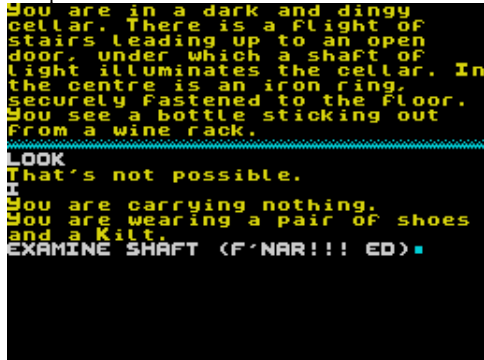

Witch Hunter (Pocket Money Software,1986)

Text Adventure

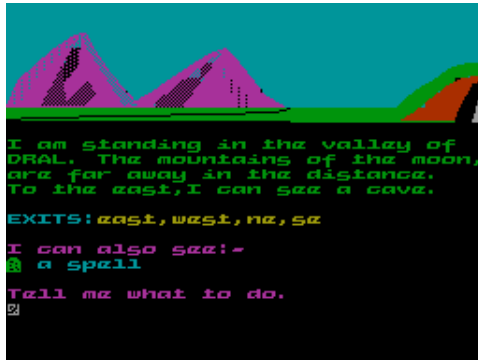

Witch's Cauldron (Mikro-Gen Ltd,1985)

Text Adventure



Without Name 1 (Kassoft,1989)

Scene Demo



Without Name 2 (Kassoft,1989)

Scene Demo

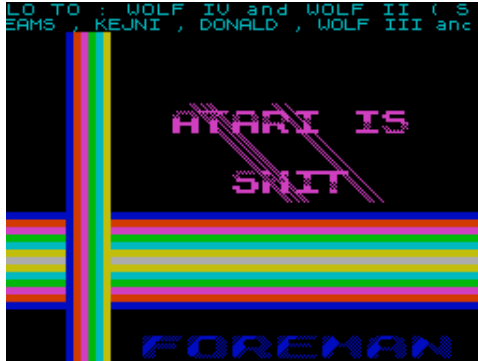

Without Sense (Primitive Software,1990)

Scene Demo



Wix 1 (Hacker Chris,1989)

Scene Demo



Wix 2 (Hacker Chris,1989)

Scene Demo

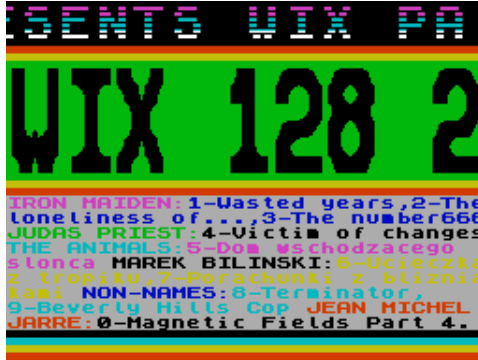

Wix 3 (Hacker Chris,1989)

Scene Demo



Wiz (Melbourne House,1987)

Arcade Adventure

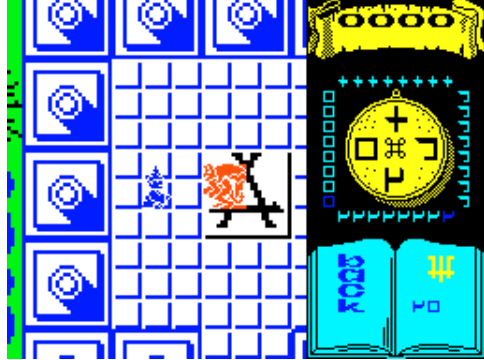

Wizard (Ariolasoft UK Ltd,1985)

Arcade



Wizard Box (Scisoft,1984)

Educational

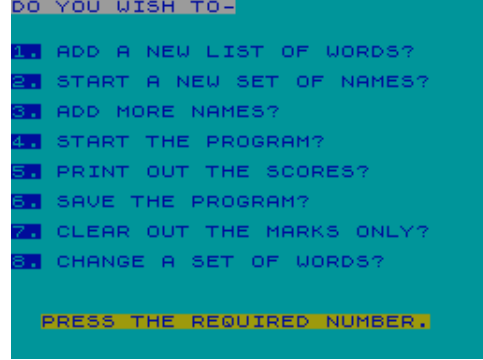

Wizard of Akyrz (Digital Fantasia,1983)
Text Adventure



Wizard of Tallyron, The (Star Dreams,1986)



Wizardry (Sir-Tech,1984)
Text Adventure



Wizard's Lair (Bubblebus Software,1985)



Wizard's Scrolls, The (Double Play Adventures,1984)



Wizard of Land Oz (Famous Faces Factory,1997)
Arcade Adventure



Wizard Prang's Rotating Rainbow (Spectrum Computing,1983)
Utility: BASIC Related



Wizard's Citadel, The (Triffid Software Research,1985)
Strategy



Wizard's Lair (Yodasoft,1984)



Wizards Skull, The (Compass Software,1986)



Wizard of Oz, The (Zenobi Software,1995)
Text Adventure

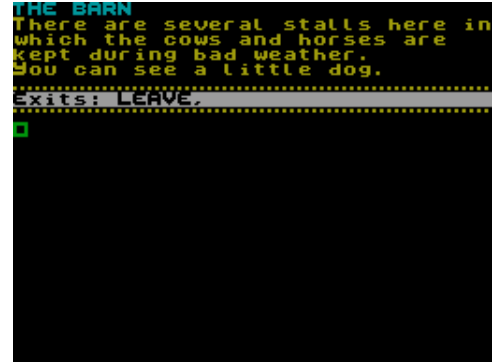

Wizard Quest (Zenobi Software,1992)



Wizard's Hooter (Spectrum Computing,1983)
Utility: BASIC Related



Wizard's Orb, The (C. Davie/Gordon Yacomine,1986)

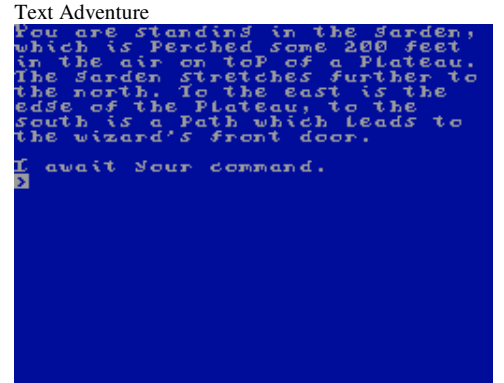

Wizards Spell (Tynesoft,1986)



Wizard's Warrior (Crusader Computing,1987)
Text Adventure



Wizard Willy (Cartoon Time,1990)
Arcade

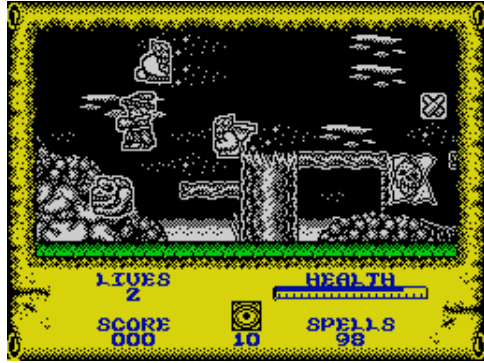

Wlezley7+ (Proxima Software,1991)
Utility



Wolfan (Bulldog,1987)
Arcade

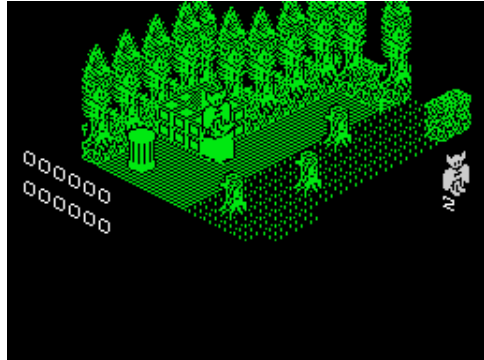

Wolf Puzzle (Shiva Publishing Ltd,1983)
Arcade



Wizard's Warriors, The (Abersoft,1983)
Arcade

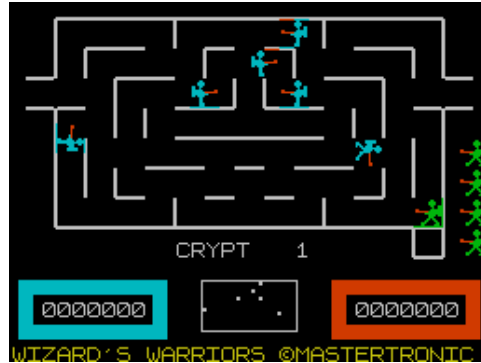

Wizball (Ocean Software Ltd,1987)
Arcade

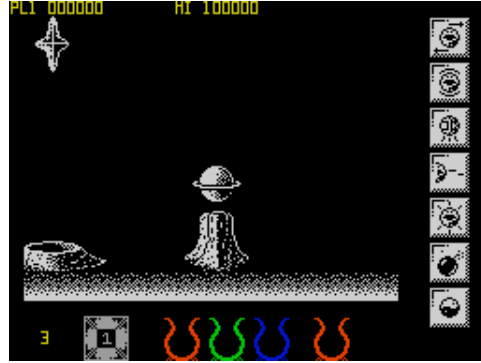

Wojownij (.)
Utility: Assembler/Disassembler/Monitor



Wolfenstein 2004 (Alone Coder,2004)
Arcade



Wombles, The (Alternative Software Ltd,1990)
Arcade Adventure

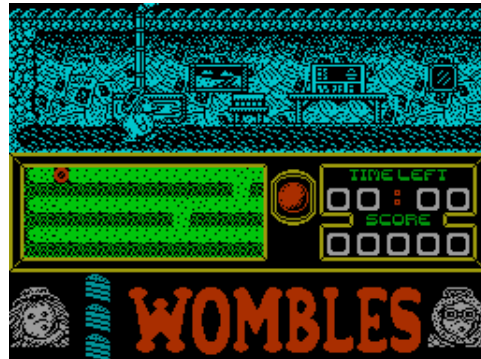

Wizard Warz (Go!,1988)
Arcade Adventure

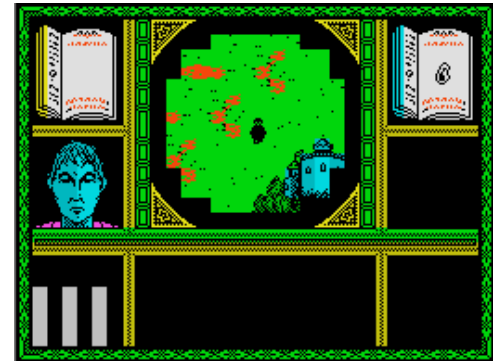

Wiz-Biz (Alternative Software Ltd,1987)
Text Adventure



Wolf (Alone Coder,1998)
Arcade

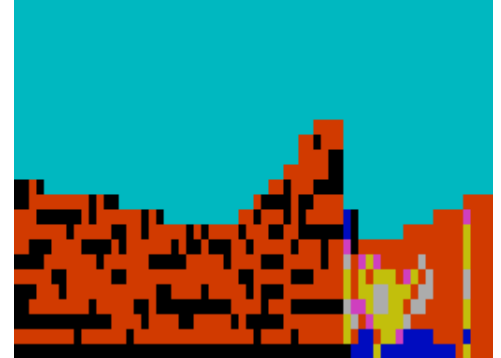

Wolfman (CRL Group PLC,1987)
Text Adventure

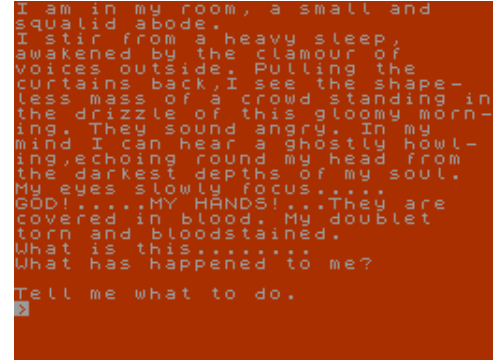

Wonder Boy (Activision Inc,1987)
Arcade



Wondergirl (St. Bride's School,) Text Adventure

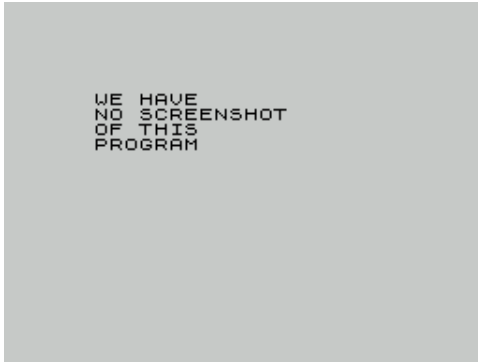

Woolstock (Colin Jelley,) Utility

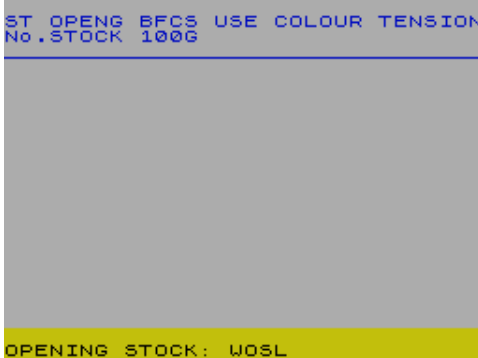

Word Finder (Bradway Software,1987) Utility



Word Games with the Mr. Men (Mirrorsoft Ltd,1986) Educational



Word Likeness (Teacher's Pet Software,1988) Educational



Wonky Chateau (Wildest Dreams,1985) Arcade

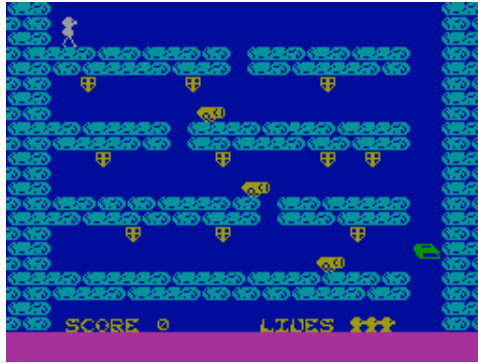

Wooden Maken (Edusystems,1984) Educational



Word Finder (Heinemann,1983) Educational

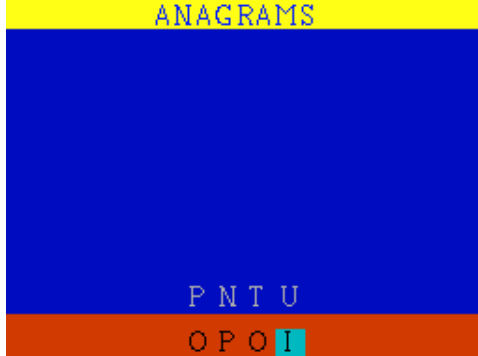

Word Hunt (Spectrum Computing,1986) Board/Card Game

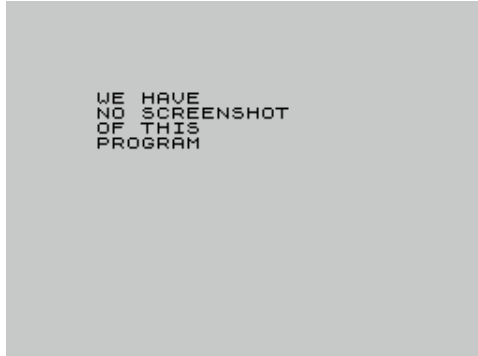

Word Manager (Oxford Computer Publishing,1984) Utility: Word Processor



Woods of Winter, The (CRL Group PLC,1984) Text Adventure



Wordvanger (Malmberg,) Educational



Wordgames (Griffin Software,1983) Educational



Word Life (Computer Rats Group,1998) Board/Card Game

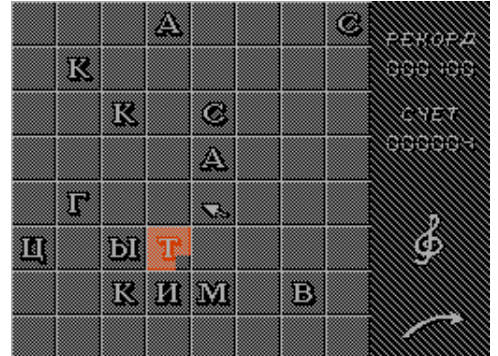

Word-Master (Cardex Computer Software,1987) Utility: Word Processor

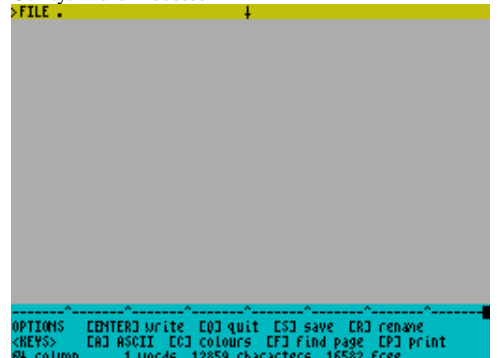

Word Power (Sulis Software Ltd,1983)
Educational

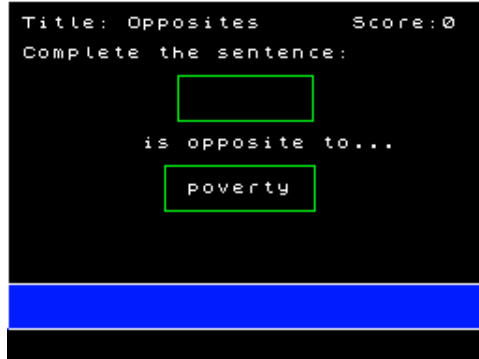

Word Processor (Quicksilver Ltd,1983)
Utility: Word Processor



Words and Pictures (Chalksoft Ltd,1984)
Educational

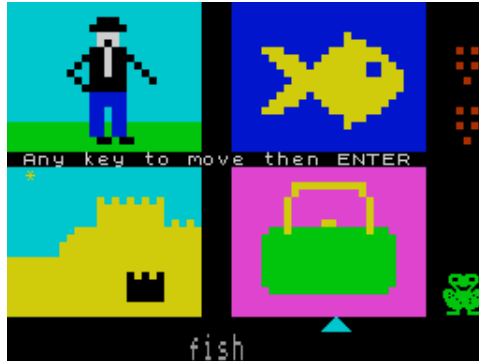

Word Search + Challenge (Azed Software,1986)
Compilation

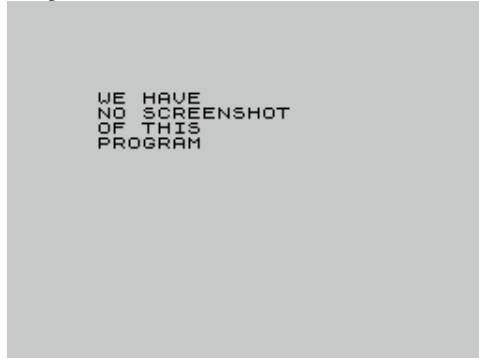

Wordsetter (Macmillan Software Ltd/Sinclair Research Ltd,1985) Educational



Word Pro (.)
Utility: Word Processor
WOS

S.1 EDIT: Menu: naechste S.: copy
Word Processor, The (MiCROL,1983)
Utility: Word Processor



Word Search (Azed Software,1986)
Board/Card Game



Wordsearch, The (16/48 Tape Magazine,1985)
Utility

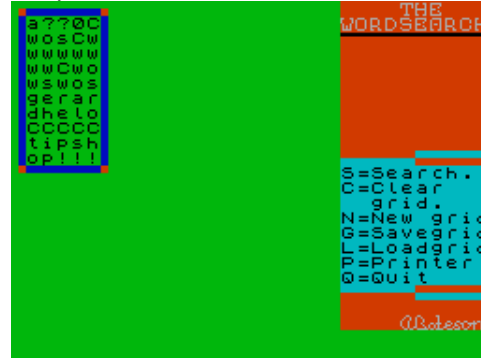

Wordspell (Griffin Software,1983)
Educational

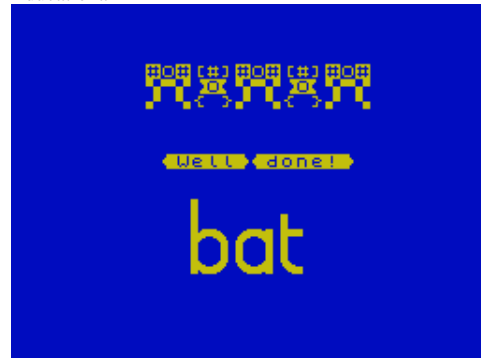

Word Pro (Popular Computing Weekly,1985)
Utility: Word Processor
WOS



Words and Letters (Webco,1984)
Educational



Wordsearch (CDS Microsystems,1988)
Board/Card Game



Word Seeker (Perfection Software,1983)
Board/Card Game



Word Wizard (Longman Software,1985)
Board/Card Game

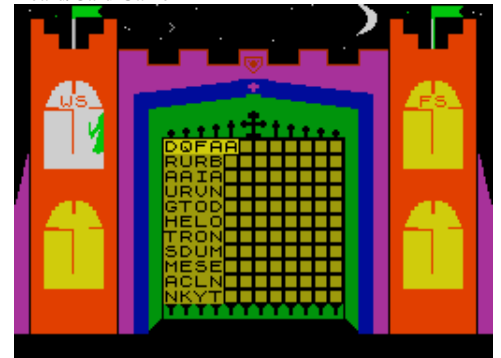

Workbox (MiCROL,1982)
Utility: Font/UDGs

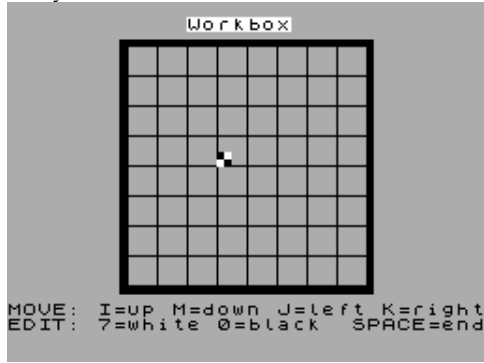

World Champions (E&J Software,1986)
Simulation



World Championship Boxing Manager (Goliath Games,1990)
Simulation



World Championship Soccer (Elite Systems Ltd,1991)
Sport

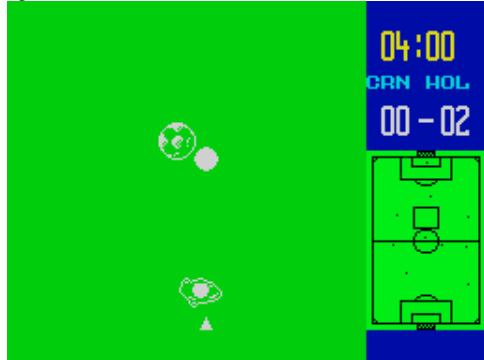

World Class Cricket (Audiogenic Software Ltd.)
Sport



World Class Darts (Alphasoft,1983)
Sport

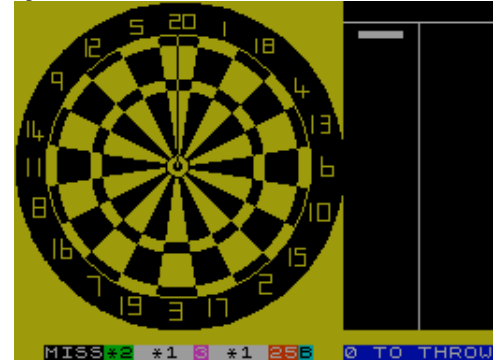

World Class Leader Board (US Gold Ltd,1987)
Sport



World Class Rugby (Audiogenic Software Ltd,1991)
Sport

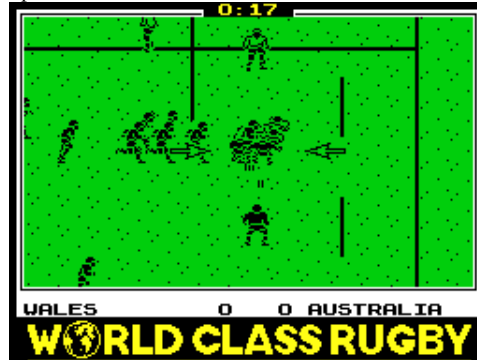

World Cricket (Zeppelin Games Ltd,1991)
Sport



World Cup (Cult Games,1992)
Simulation



World Cup (D&H Games,1992)
Simulation



World Cup '86 (Home Entertainments,1984)
Sport



World Cup '86 (Nite Owl,1984)
Simulation



World Cup Carnival (US Gold Ltd,1986)
Sport



World Cup Challenge (Players Premier Software,1990)
Simulation

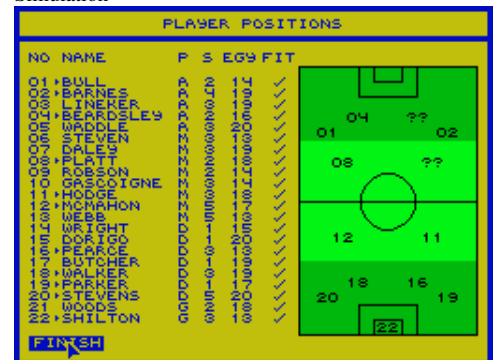

World Cup Cricket + Champions of Cricket - Sides 2 (Lambourne Games,1991) Compilation



World Cup Football (Hill MacGibbon,1985) Sport



World Cup - Mexico 86 (D. Corbishley,1986) Sport

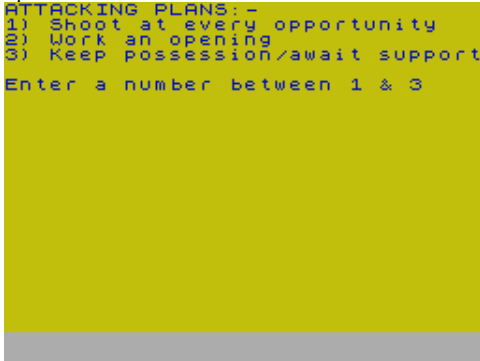

World Destruction (Ventamatic,) Arcade



World Globe (Eclipse Software,1985) Simulation

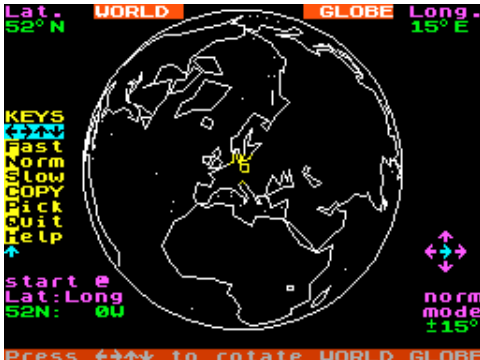

World Cup Cricket - Special (Lambourne Games,) Simulation

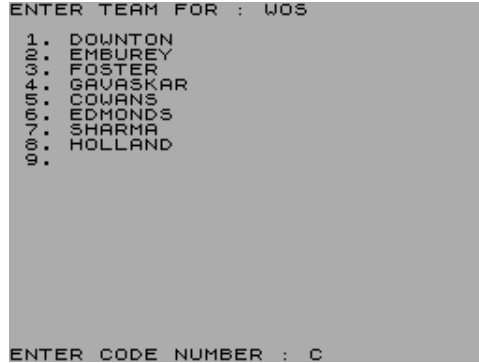

World Cup Glory (Challenge Software,1990) Sport



World Cup Soccer (Macmillan Software Ltd,1986) Simulation



World Flags (Micro-Mart Software,1984) Educational



World Info (Wimsoft,1983) Educational



World Cup Football (Artic Computing Ltd,1984) Sport



World Cup Manager (Stuttard,) Arcade



World Cup Year 90 Compilation (Empire Software,1990) Compilation



World Games (US Gold Ltd,1987) Sport



World Map (Shiva Publishing Ltd,1983) Educational



World of Grand Prix Racing - 1950s All Time Greats, The (Lambourne Games,1993) Strategy



World of Grand Prix Racing - 1993 (Lambourne Games,1993) Simulation

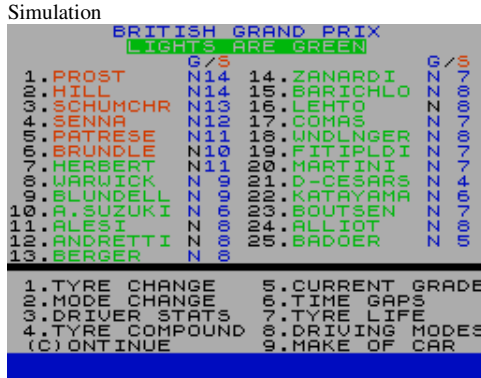

World of Soccer (Challenge Software,) Simulation



Worlds at War (Esteem More Than Equal,1984) Arcade

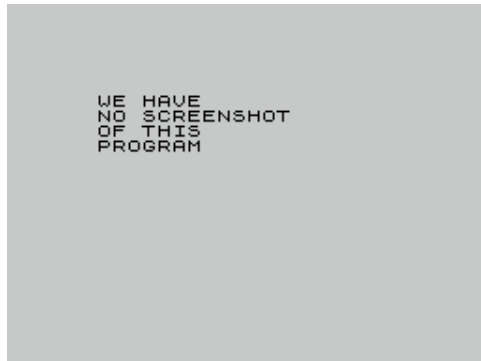

World Series Cricket (Bosoft,1984) Sport

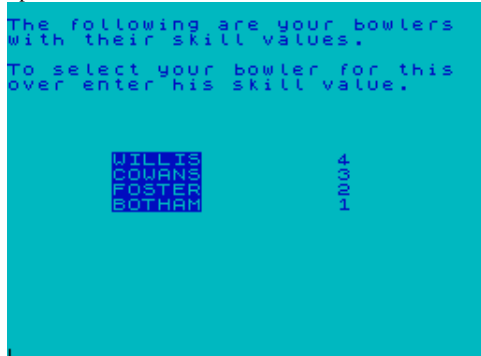

World of Grand Prix Racing - 1960s All Time Greats, The (Lambourne Games,1993) Strategy



World of Grand Prix Racing 2, The (Lambourne Games,1993) Strategy



World Rally (MicroHobby,1989) Arcade

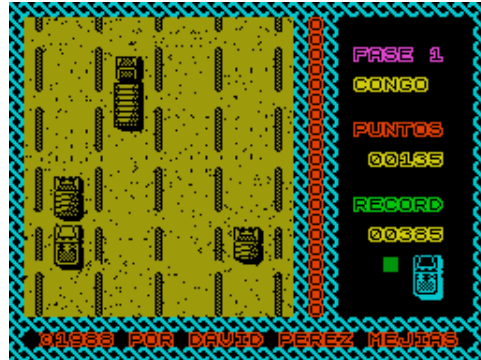

World Series Baseball (Imagine Software Ltd,1985) Sport



World's First Computer Joke Book (Computerworld,1985) Utility

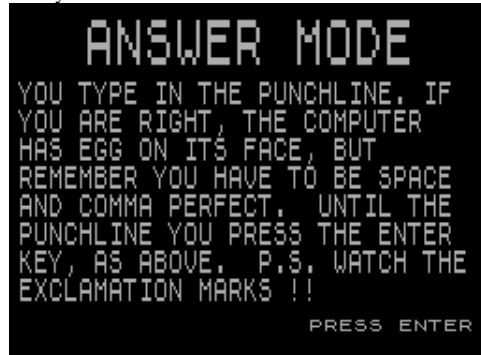

World of Grand Prix Racing - 1964-1967 & 1989-1991, The (Lambourne Games,1993) Strategy

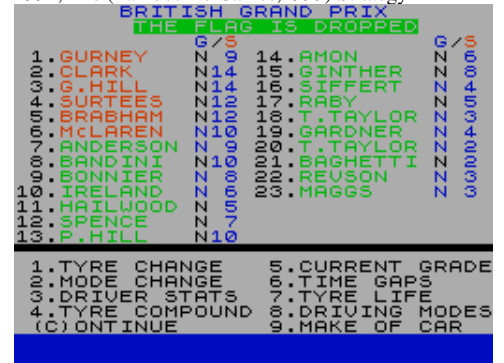

World of Grand Prix Racing, The (Lambourne Games,1993) Strategy



World Rugby (Zeppelin Games Ltd,1993) Simulation



World Series Basketball (Imagine Software Ltd,1985) Sport



World Soccer (Zeppelin Games Ltd,1990) Simulation



World Soccer League (E&J Software,1989)
Simulation



Worldwise: Nuclear Weapons (Richardson Institute,1985)
Educational



Worm (Sinclair Programs,1983)
Arcade



Worm in Paradise, The (Level 9 Computing Ltd,1985)
Text Adventure

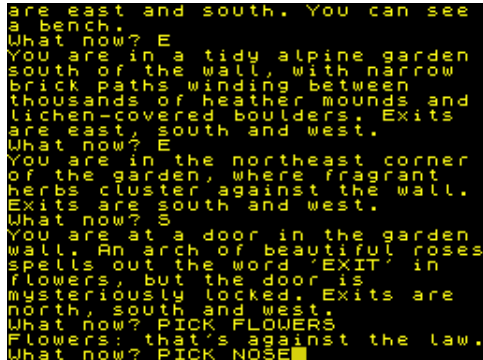

Worms (Silicon Brains Software Ltd,1997)
Arcade

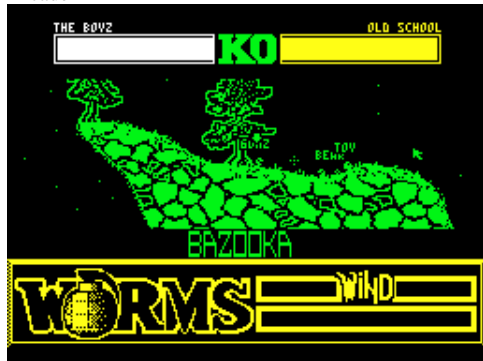

World Team Championships (ET Computer Software,)
Simulation



Worm (Chromasoft,1982)
Arcade



Worm Attack (Pulsonic,1984)
Arcade

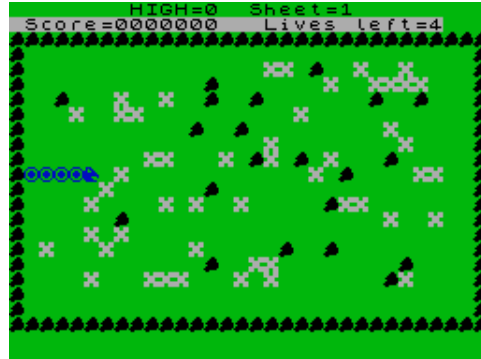

Worms (Evgeny Bystrov,1997)
Arcade

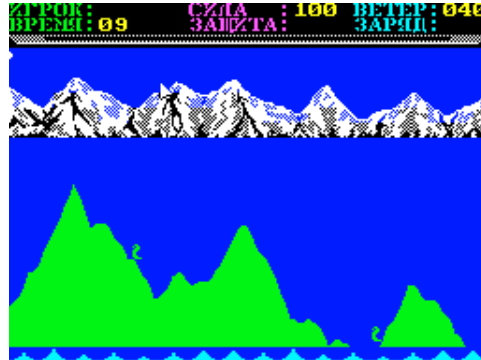

Wormywave (Luca Missora,1984)
Arcade



World War 1 (MC Lothlorien Ltd,1987)
Strategy



Worm (Master Home Computers Group,1998)
Arcade

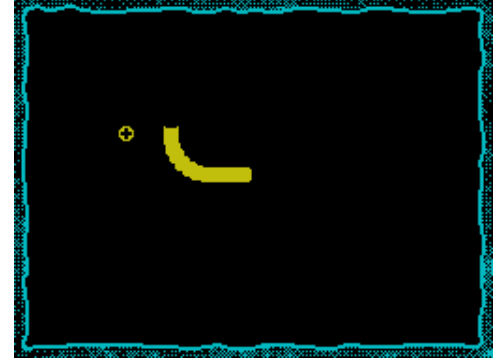

Worm Castle (MicroHobby,1985)
Arcade



Worms (Multiplex Group,1999)
Arcade

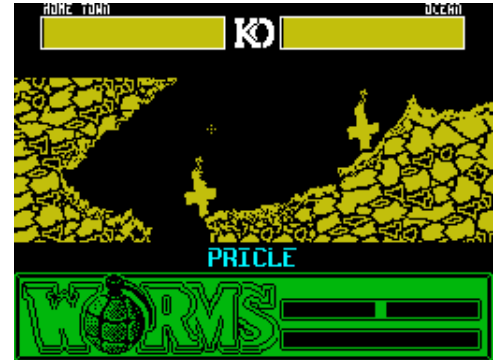

Worse Things Happen at Sea (Silversoft Ltd,1984)
Arcade

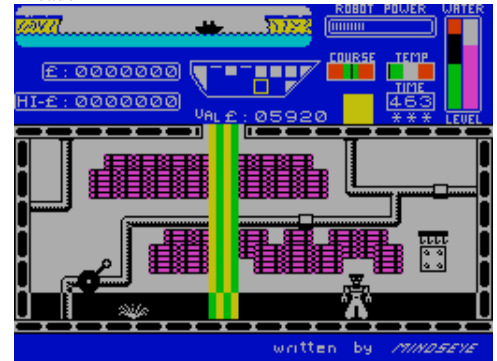

WOW Games (War On Want,1986)

Compilation

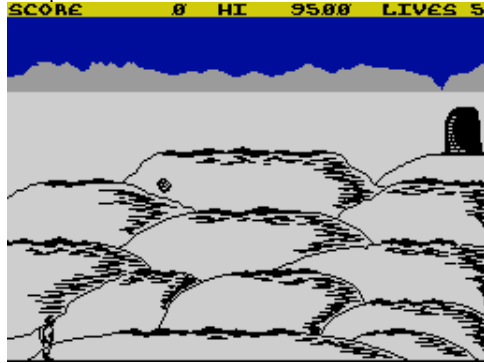

Wreckage (Ventamatic,1984)

Arcade



Wiggler (Romantic Robot UK Ltd,1985)

Arcade



Write On (System Software,1988)

Educational



Wulfpack (Blue Ribbon Software,1988)

Strategy



Wrath of Magra, The (Carnell Software,1984)

Text Adventure



Wreckers (Audiogenic Software Ltd.)

Arcade Adventure

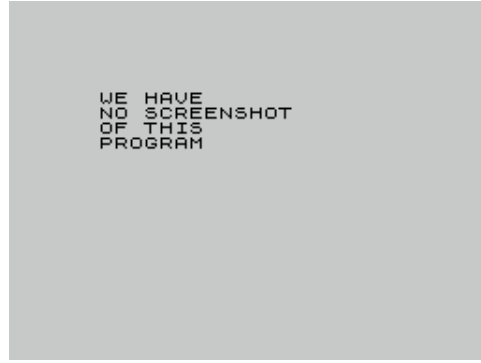

Write Equations (Cloud 9 Software,1984)

Educational



Writer, The (Softechnics,1985)

Utility: Word Processor



Wurfelspiel 2000 (A. Kollross,1985)

Board/Card Game



Wrath of the Killer Pigs (Krypton Force,1985)

Arcade

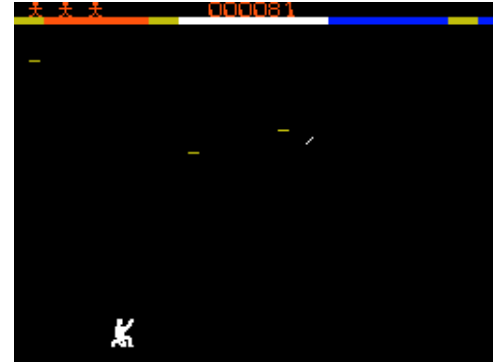

Wrestling Superstars (Code Masters Ltd,1993)

Arcade



Write Large (Spectrum Computing,1983)

Utility



Wuestenkrieg (.)

Arcade



Wurmi (.)

Arcade

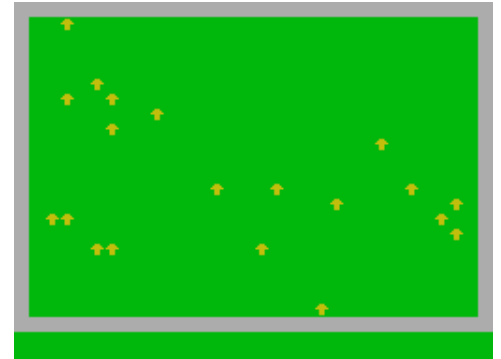

Xeel (Activision Inc,1985)
Arcade

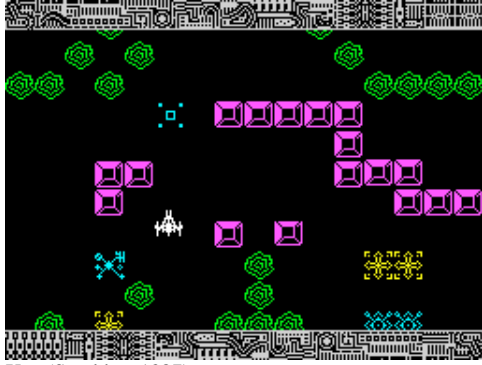

Xen (Sparklers,1987)
Arcade

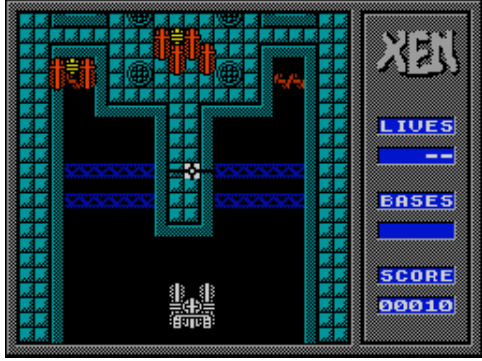

Xenon (Melbourne House,1988)
Arcade

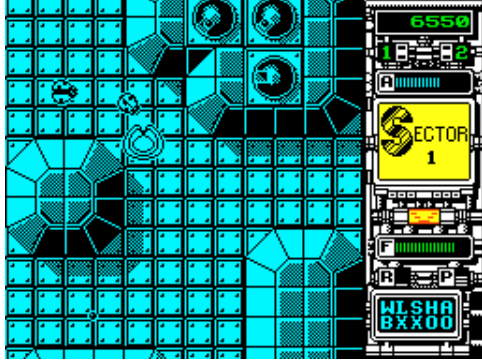

X-Files (Paul Howard,1995)
Scene Demo



XL1 (Genetic,1983)
Compilation



Xebec (Computer Gamer,1985)
Arcade



Xeno (A'n'F Software,1986)
Arcade

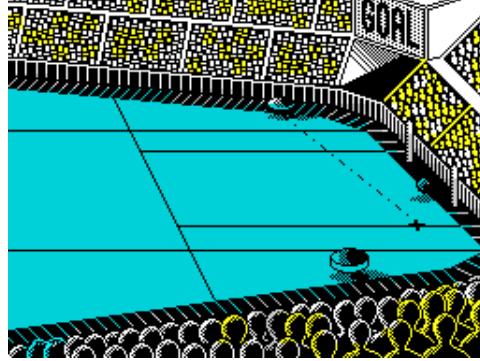

Xenophobe (Micro Style,1989)
Arcade Adventure

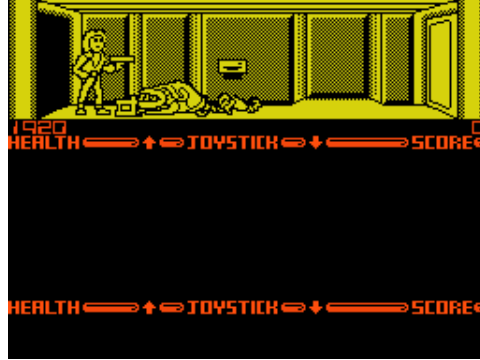

XIV Beogradska Gimnazija (Pandovisia Ltd,1984)
Text Adventure

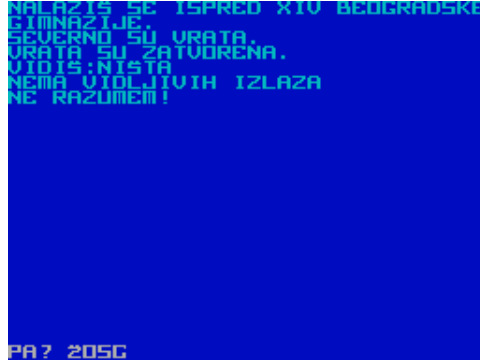

X-Loader (M.P. Sun,1988)
Utility

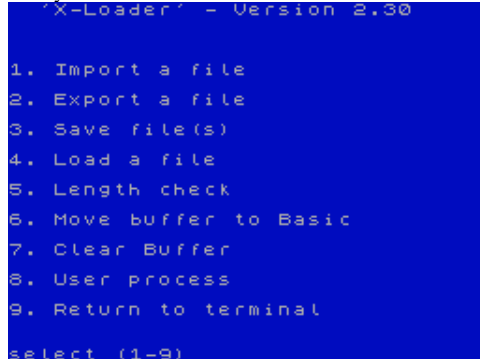

Xecutor (ACE Software [1],1987)
Arcade

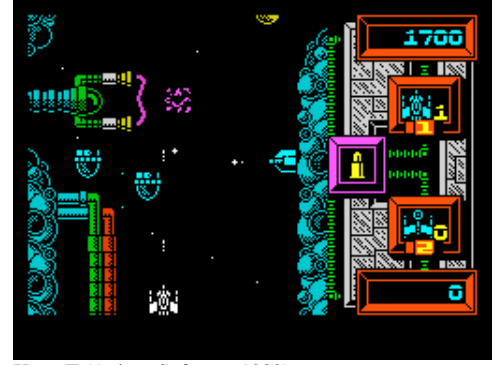

Xeno II (Anirog Software,1983)
Arcade



Xevious (US Gold Ltd,1987)
Arcade



Xixit (Real Software,1999)
Board/Card Game

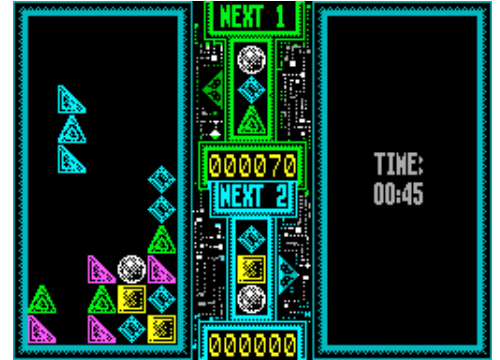

X-Loader Xmodem User Guide (M.P. Sun,1988)
Utility

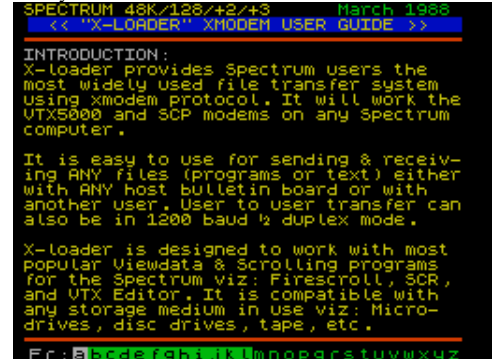

XLR-8 Demo - Basic Loader (Jon North,1990)
Utility



XLR-8 Mastering Utilities (Jon North,1990)
Utility

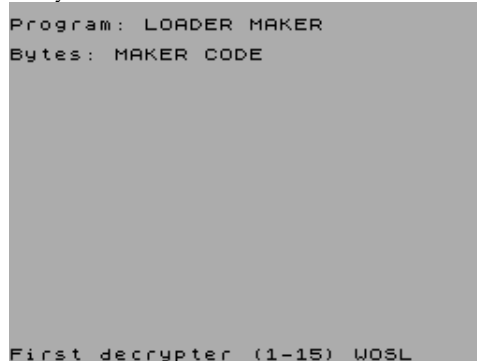

Xmas Card (Your Spectrum,1984)
Simulation



X-Mas Ludo (Gremlin Graphics Software Ltd,1987)
Arcade

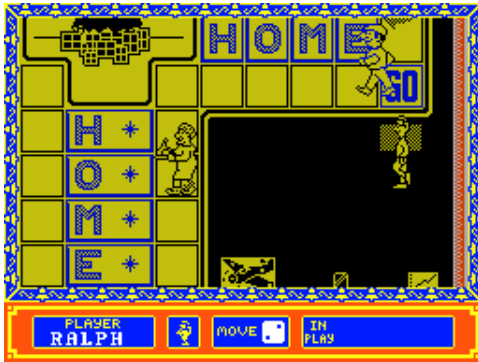

X-Maze (Arctic Computing Ltd,1983)
Arcade



X & O (SuperSoft [2],1999)
Board/Card Game



Xonix (A. Surna,1987)
Arcade



Xonix (C&C,1991)
Arcade



Xonix (Vlad Corp,1994)
Arcade

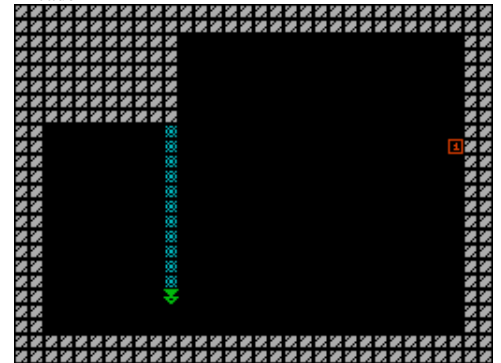

XOR (Logotron Ltd,1987)
Arcade

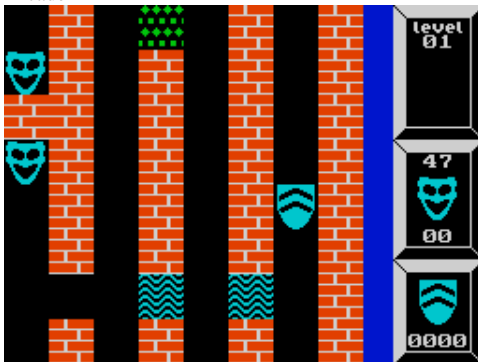

Xor (Proxima Software,1990)
Arcade



XOR 2000: Russian Invasion (D. Moroz,2000)
Arcade



Xorktrons (DK'Tronics Ltd.)
Arcade



X-Out (Rainbow Arts,1990)
Arcade

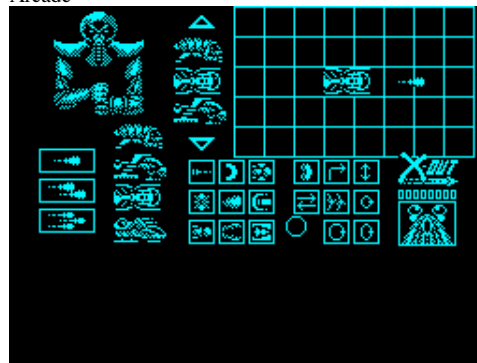

Xo-Word (Azed Software,1986)
Board/Card Game



Xreversy (Creator,1997)
Board/Card Game

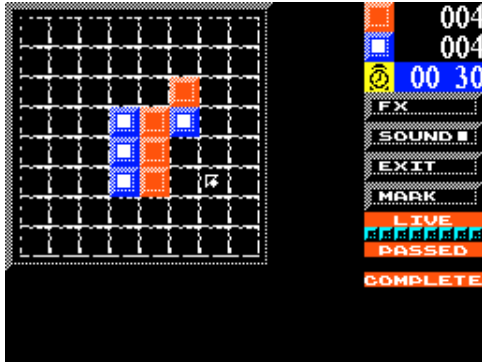

Xybots (Domark Ltd,1989)
Arcade Adventure

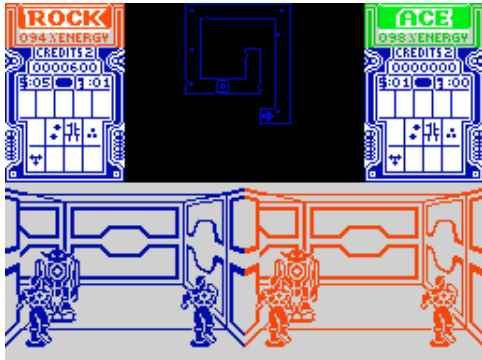

Yacht Race (Hill MacGibbon,1985)
Simulation



Yahtzee (Pegasus Developments,1983)
Board/Card Game



Yahtzie (Bob Hemmings,1983)
Board/Card Game

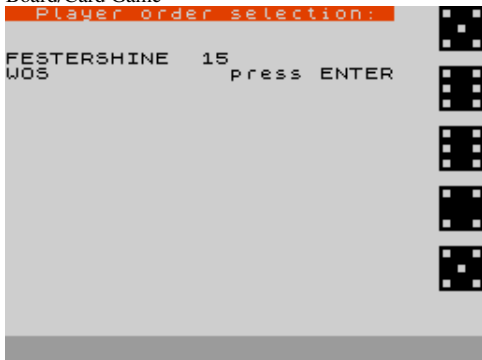

Xtarda Rescue (Sonic Software,1982)
Arcade

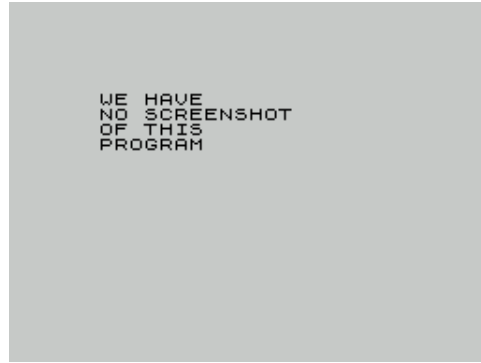

Y..... (Juana Pueblo Soft,)
Text Adventure

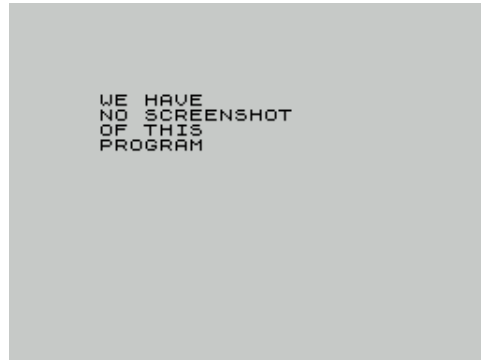

Yahtcee (Anik Microsystems,1984)
Board/Card Game



Yahtzee (Spectre,1983)
Board/Card Game



Yakzee! (Automata UK Ltd,1983)
Board/Card Game

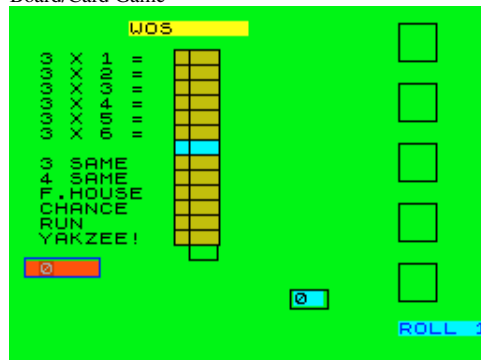

Xtroth - The Adventure (Automata UK Ltd,1985)
Text Adventure



Yabba Dabba Doo! (Quicksilver Ltd,1985)
Arcade



Yahtzee (16/48 Tape Magazine,1984)
Board/Card Game



Yahtzi (Work Force,1983)
Board/Card Game

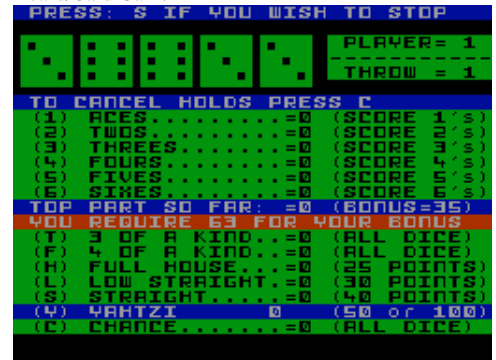

Yankee (CCS,1987)
Strategy



Yard Story (Orion,2001)
Text Adventure

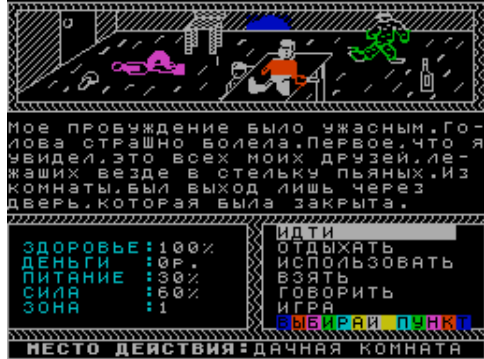

Yatzee (CP Software,1984)
Board/Card Game



Yellow Door, The (Tartan Software,1987)
Text Adventure

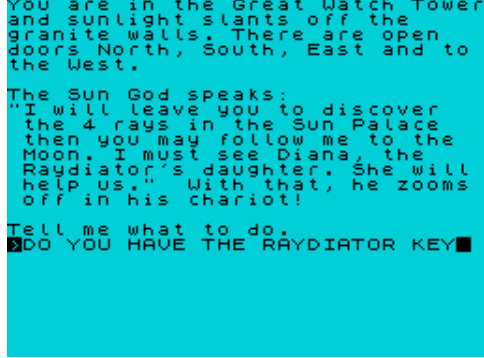

Yenght (Dinamic Software,1985)
Text Adventure



Yes, Prime Minister (Mosaic Publishing Ltd,1987)
Arcade



Yard Story II (Illusion Dreams,2001)
Text Adventure

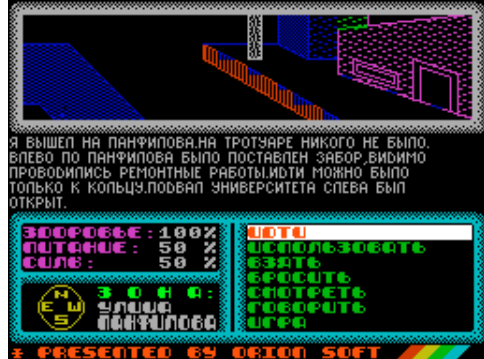

Ya Vendran Tiempos Mejores (Individual Software Service/Hueber Software,) Educational



Yellow Peril (Dorothy Millard,1994)
Text Adventure



Yeni Tragona (Microparadise Software,1984)
Arcade



Yet Another Big Disk (Zenobi Software,) Compilation

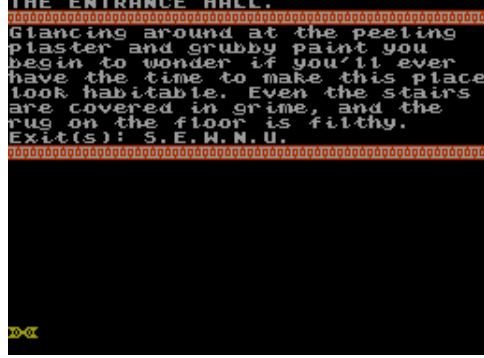

Y.A.S.G. (Dominic Morris,1992)
Arcade



Yazz - Stand Up For Your Love Rights (Alfa Soft,) Scene Demo



Yellow Umbrella Shop (Colin Jelley,1984)
Utility

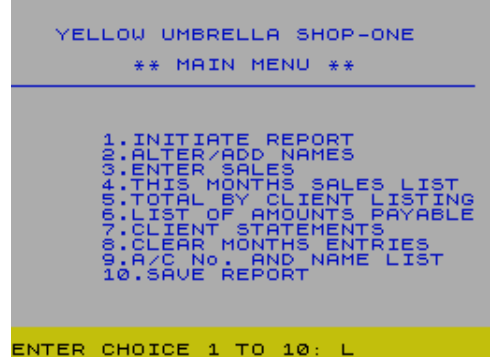

Yes (7 Gods,1997)
Scene Demo

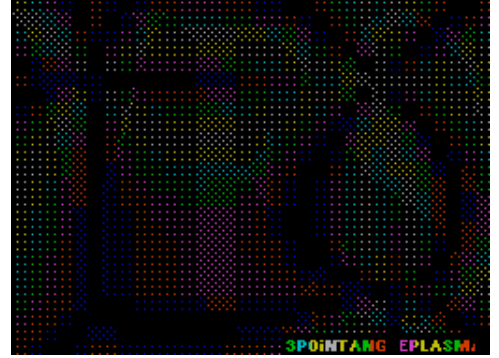

Yeti (Destiny Software,1988)
Arcade



Yie Ar Kung-Fu (Imagine Software Ltd,1985)

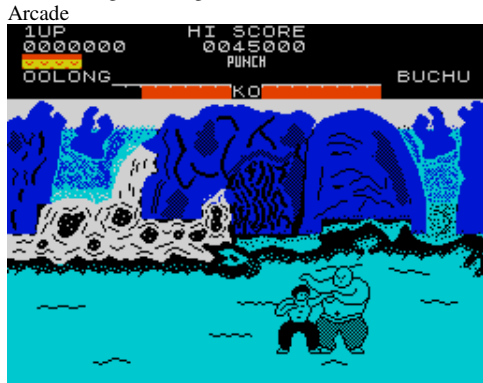

Yippee One More Big Disk (Zenobi Software,1993)



Yogi's Great Escape (Hi-Tec Software Ltd,1990)

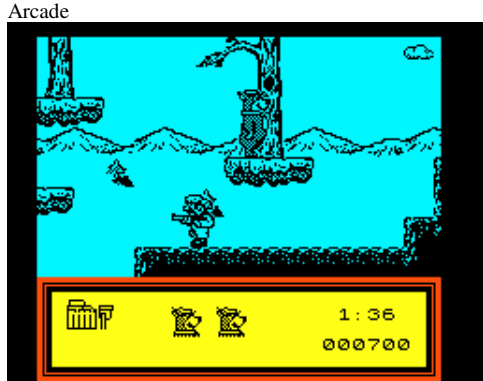

Yomp (Virgin Games Ltd,1983)



Young Ones, The (Orpheus Ltd,1986)



Yie Ar Kung-Fu II (Imagine Software Ltd,1986)



Yogi Bear (Piranha,1987)

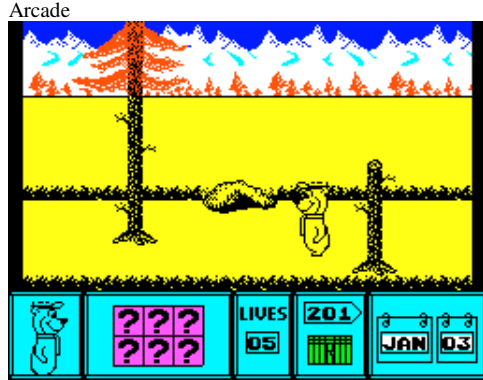

Yolka 97 (Dream Makers Software,1997)

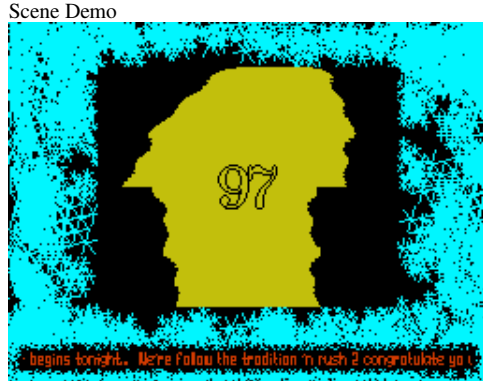

Young Learners 1 (Rose Software,1983)



Your Computer issue 1 (Syntax S.A.,1985)



Ying Yang (MicroHobby,1986)

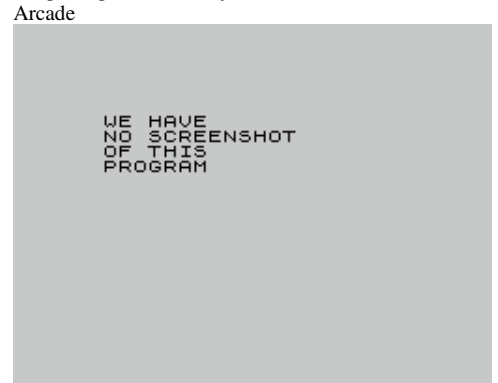

Yogi Bear & Friends: The Greed Monster (Hi-Tec Software Ltd,1990)



Yolka 98 (Dream Makers Software,1998)



Young Learners 2 (Rose Software,1983)



Your Computer issue 2 (Syntax S.A.,1985)



Your Computer issue 3 (Sintax S.A.,1986)
Covertape



Your Computer issue 4 (Sintax S.A.,1986)
Covertape



Your Computer issue 5 (Sintax S.A.,1986)
Covertape



Your Computer issue 6 (Sintax S.A.,1986)
Covertape



Your Computer issue 7 (Sintax S.A.,1986)
Covertape



Your Health (HiSoft,1986)
Utility



Your Horoscope (,1986)
Utility



Your Sinclair Digitape Issue 09 (Your Sinclair,1986)
Compilation



Your Sinclair Pokes Party Pack (Your Sinclair,)
Utility

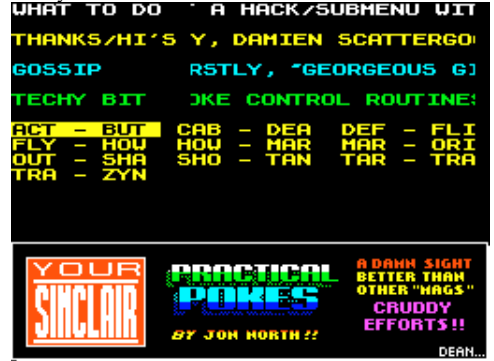

Your Sinclair Special Adventure Offer (Tartan Software,)
Compilation

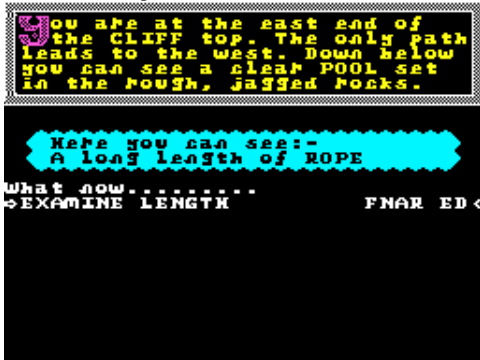

YOX Assembler (YOX,)
Utility: Assembler/Disassembler/Monitor



YS2 issue 1 (Y-Not Software,1993)
Simulation



YS2 issue 2 (Y-Not Software/Delta 4 Software,1993)
Simulation



YS2 issue 3 (Y-Not Software/Delta 4 Software,1993)
Simulation

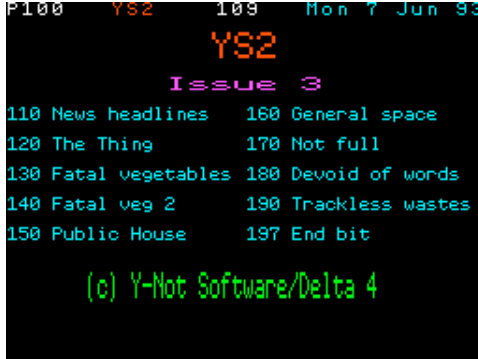

YS Border Print (Your Sinclair,1988)
Utility: BASIC Related

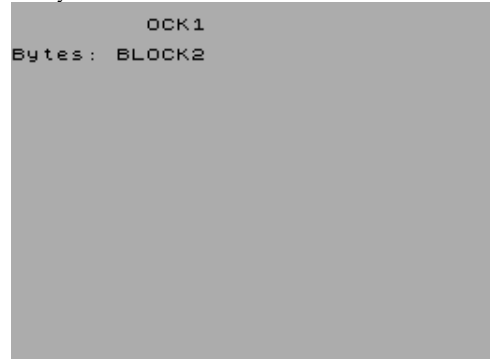

YS Capers (Your Sinclair,1990)
Arcade Adventure

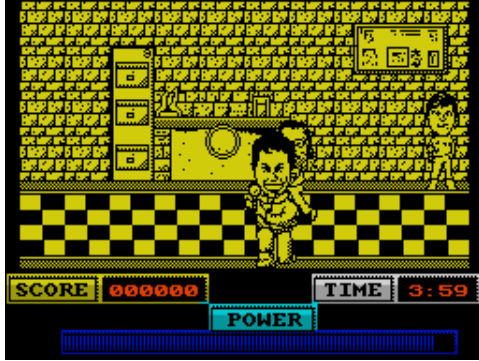

YS issue 1: Smash Tape 1 (Your Sinclair,1986)
Covertape

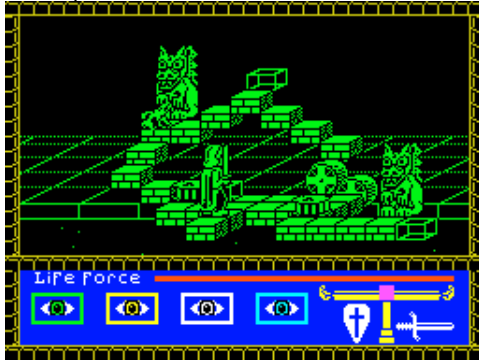

YS issue 24: Smash Tape 4 (Your Sinclair,1987)
Covertape

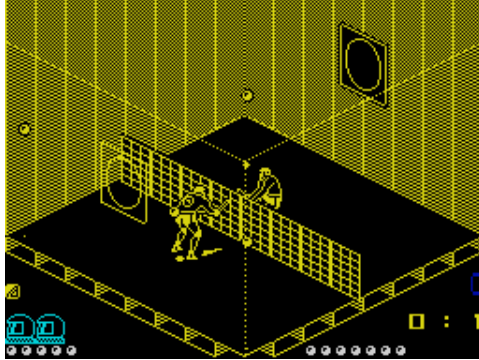

YS issue 30: Smash Tape 7 (Your Sinclair,1988)
Covertape



YS issue 35: Smash Tape 10 (Your Sinclair,1988)
Covertape

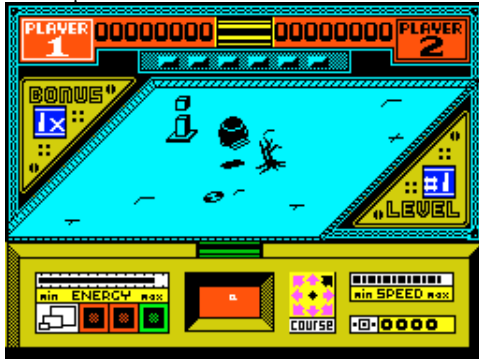

YS Flash Load (Your Sinclair,1987)
Utility

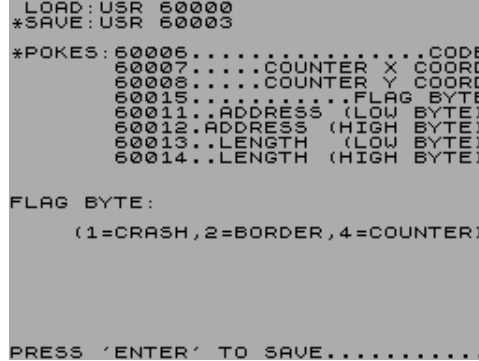

YS issue 17: Smash Tape 2 (Your Sinclair,1987)
Covertape



YS issue 25: Smash Tape 5 (Your Sinclair,1988)
Covertape

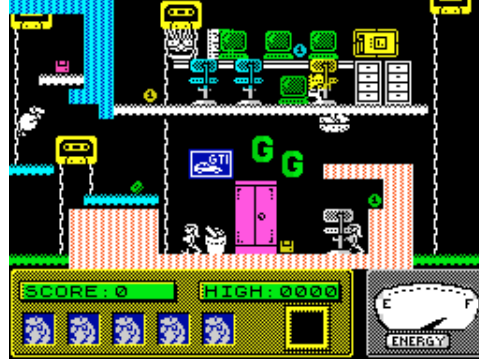

YS issue 31: Smash Tape 8 (Your Sinclair,1988)
Covertape



YS issue 36: Smash Tape 11 (Your Sinclair,1988)
Covertape



YS Hex Loader (Your Sinclair,)
Utility: BASIC Related



YS issue 22: Smash Tape 3 (Your Sinclair,1987)
Covertape

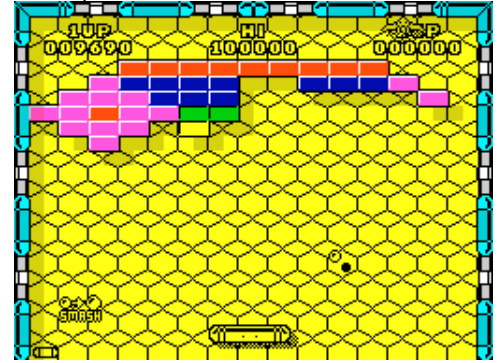

YS issue 29: Smash Tape 6 (Your Sinclair,1988)
Covertape



YS issue 34: Smash Tape 9 (Your Sinclair,1988)
Covertape

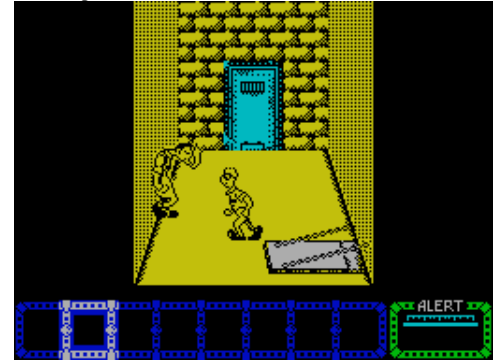

YS issue 36: Smash Tape 12 (Your Sinclair,1988)
Covertape



YS issue 37: Smash Tape 13 (Your Sinclair,1989)
Covertape

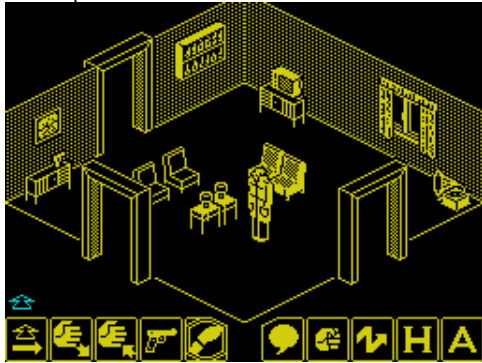

YS issue 40: Smash Tape 16 (Your Sinclair,1989)
Covertape



YS issue 43: Smash Tape 19 (Your Sinclair,1989)
Covertape

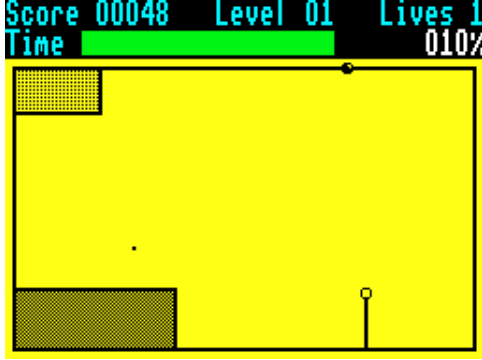

YS issue 46: Smash Tape 22 (Your Sinclair,1989)
Covertape



YS issue 48: Smash Tape 25 (Your Sinclair,1989)
Covertape



YS issue 38: Smash Tape 14 (Your Sinclair,1989)
Covertape



YS issue 41: Smash Tape 17 (Your Sinclair,1989)
Covertape

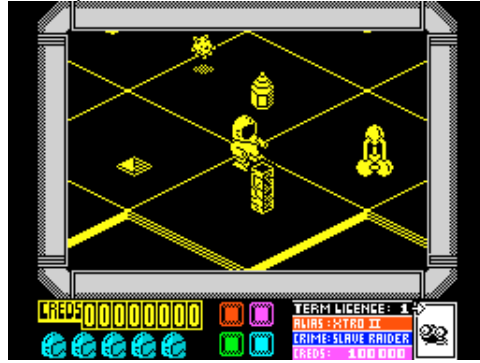

YS issue 44: Smash Tape 20 (Your Sinclair,1989)
Covertape

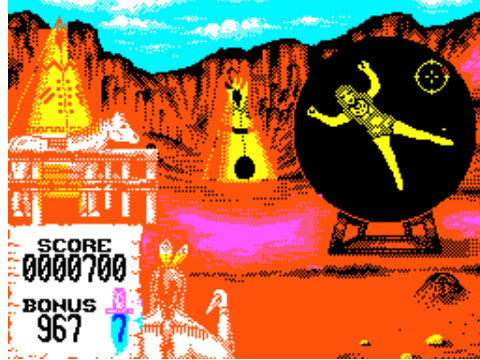

YS issue 47: Smash Tape 23 (Your Sinclair,1989)
Covertape

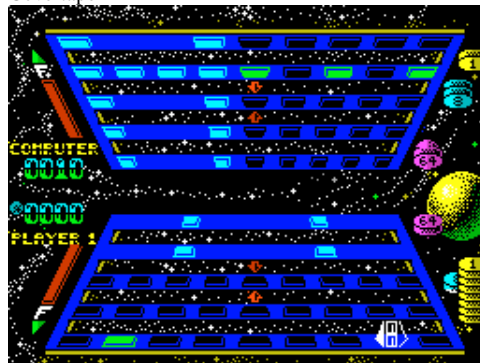

YS issue 49: Smash Tape 26 (Your Sinclair,1990)
Covertape

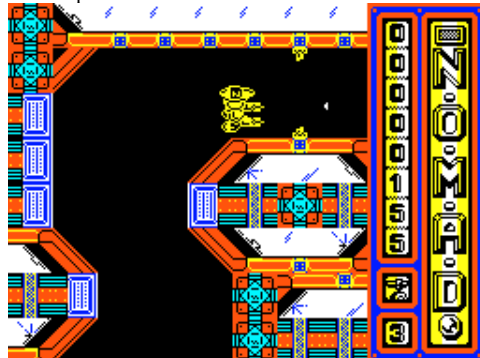

YS issue 39: Smash Tape 15 (Your Sinclair,1989)
Covertape



YS issue 42: Smash Tape 18 (Your Sinclair,1989)
Covertape



YS issue 45: Smash Tape 21 (Your Sinclair,1989)
Covertape



YS issue 48: Smash Tape 24 (Your Sinclair,1989)
Covertape



YS issue 50: Smash Tape 27 (Your Sinclair,1990)
Covertape



YS issue 51: Smash Tape 28 (Your Sinclair,1990)



YS issue 54: Smash Tape 31 (Your Sinclair,1990)

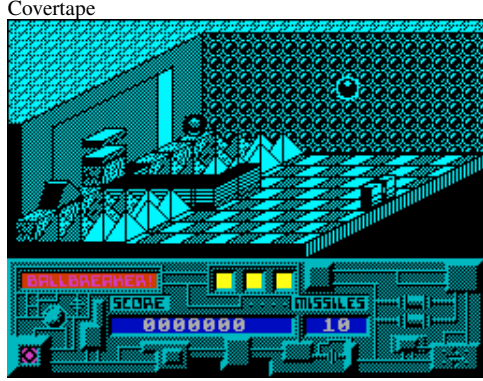

YS issue 57: Smash Tape 34 (Your Sinclair,1990)



YS issue 60: Four Pack 3 (Your Sinclair,1990)

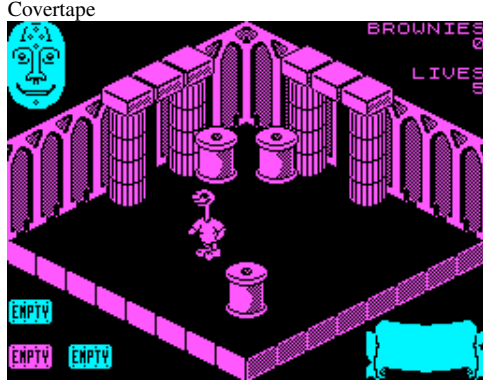

YS issue 63: Six Pack (Your Sinclair,1991)

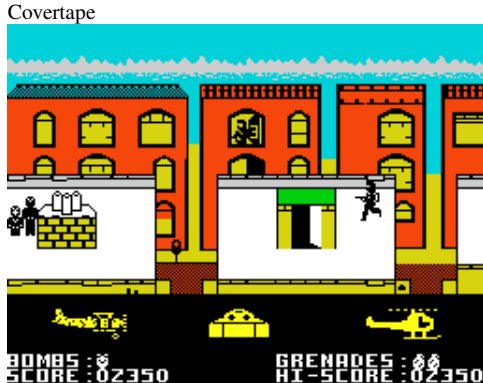

YS issue 52: Smash Tape 29 (Your Sinclair,1990)



YS issue 55: Smash Tape 32 (Your Sinclair,1990)

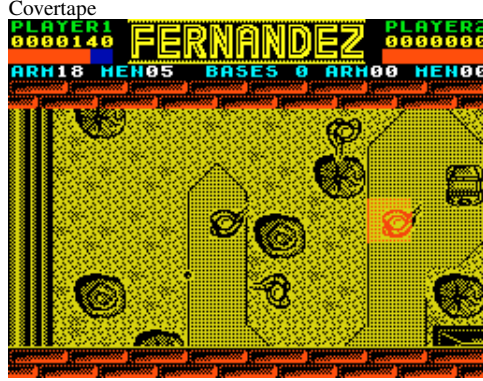

YS issue 58: Four Pack 1 (Your Sinclair,1990)

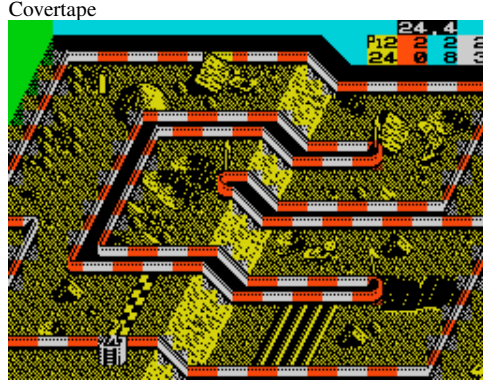

YS issue 61: Christmas Collection 1 (Your Sinclair,1991)

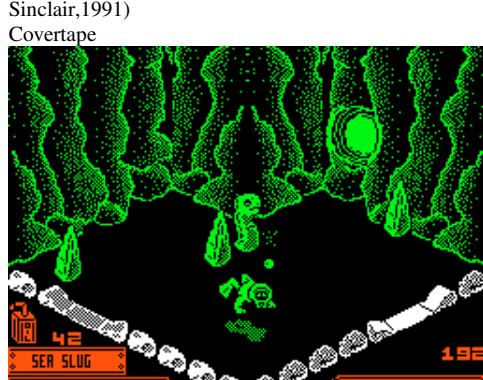

YS issue 64: Magnificent Seven 1 (Your Sinclair,1991)

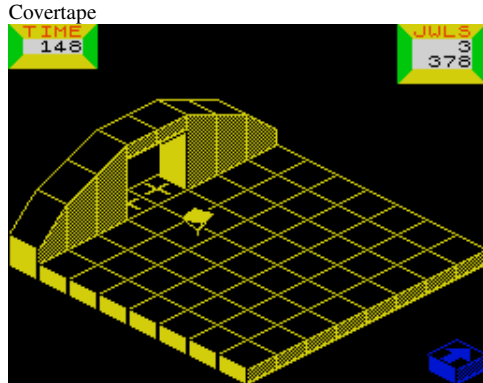

YS issue 53: Smash Tape 30 (Your Sinclair,1990)

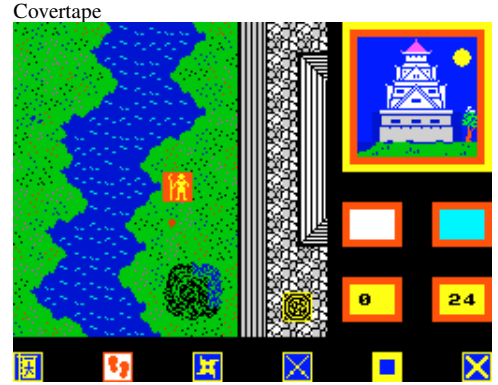

YS issue 56: Smash Tape 33 (Your Sinclair,1990)

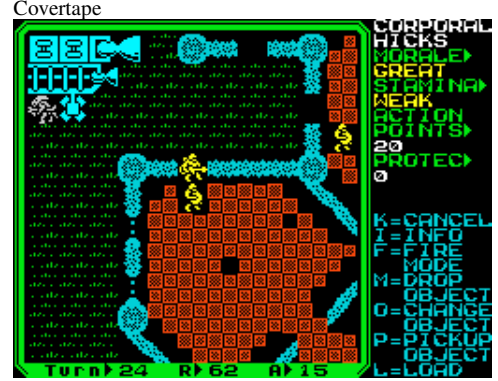

YS issue 59: Four Pack 2 (Your Sinclair,1990)



YS issue 62: Four Pack 4 (Your Sinclair,1991)

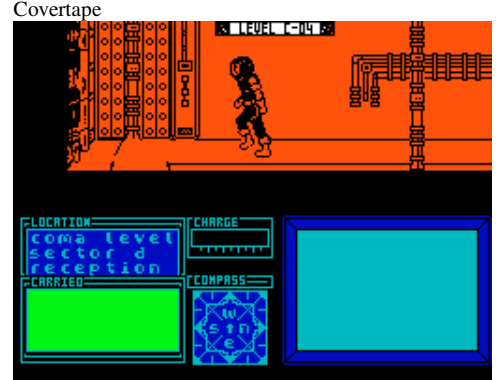

YS issue 65: Magnificent Seven 2 (Your Sinclair,1991)



YS issue 66: Magnificent Seven 3 (Your Sinclair,1991)
Covertape



YS issue 69: Magnificent Seven 6 (Your Sinclair,1991)
Covertape



YS issue 72: Magnificent Seven 9 (Your Sinclair,1991)
Covertape



YS issue 75: Magnificent Seven (Your Sinclair,1992)
Covertape



YS issue 78: Magnificent Seven (Your Sinclair,1992)
Covertape



YS issue 67: Magnificent Seven 4 (Your Sinclair,1991)
Covertape



YS issue 70: Magnificent Seven 7 (Your Sinclair,1991)
Covertape



YS issue 73: Magnificent Seven (Your Sinclair,1992)
Covertape



YS issue 76: Magnificent Seven (Your Sinclair,1992)
Covertape

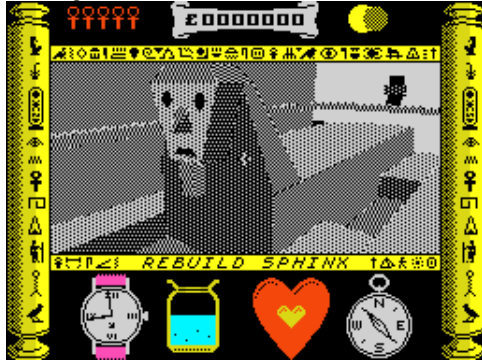

YS issue 79: Magnificent Seven (Your Sinclair,1992)
Covertape



YS issue 68: Magnificent Seven 5 (Your Sinclair,1991)
Covertape

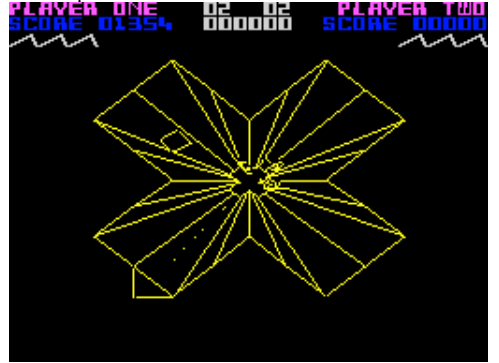

YS issue 71: Magnificent Seven 8 (Your Sinclair,1991)
Covertape



YS issue 74: Magnificent Seven (Your Sinclair,1992)
Covertape



YS issue 77: Magnificent Seven (Your Sinclair,1992)
Covertape

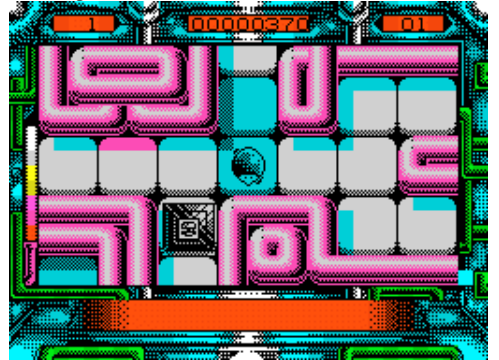

YS issue 80: Magnificent Seven (Your Sinclair,1992)
Covertape



YS issue 81: Magnificent Seven (Your Sinclair,1992)
Covertape

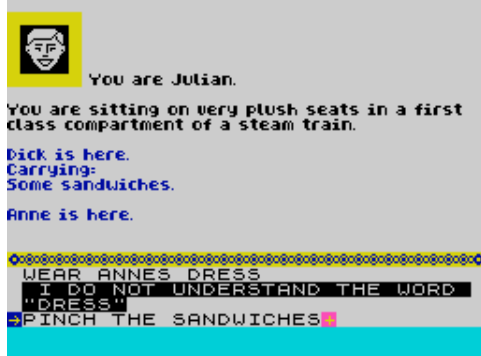

YS issue 84: Magnificent Seven (Your Sinclair,1992)
Covertape

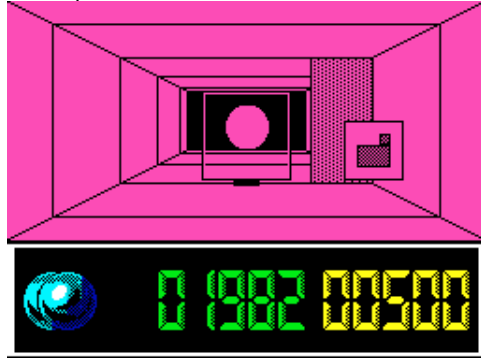

YS issue 87: Beaut Box 2 (Your Sinclair,1993)
Covertape



YS issue 90: Beaut Box 5 (Your Sinclair,1993)
Covertape



YS MegaBASIC (Your Sinclair,1984)
Utility: BASIC Related

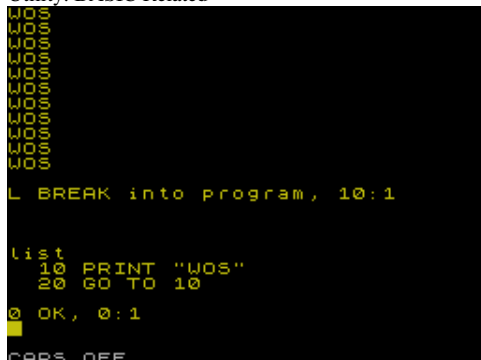

YS issue 82: Magnificent Seven (Your Sinclair,1992)
Covertape



YS issue 85: Christmas Collection 2 (Your Sinclair,1993)
Covertape



YS issue 88: Beaut Box 3 (Your Sinclair,1993)
Covertape



YS issue 91: Beaut Box 6 (Your Sinclair,1993)
Covertape

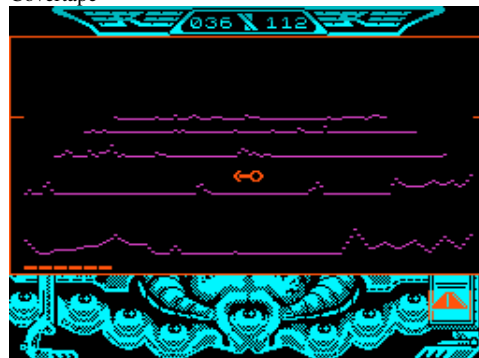

Yucan (MicroHobby,1989)
Arcade

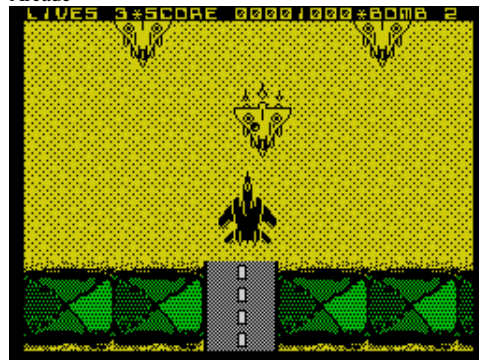

YS issue 83: Magnificent Seven (Your Sinclair,1992)
Covertape

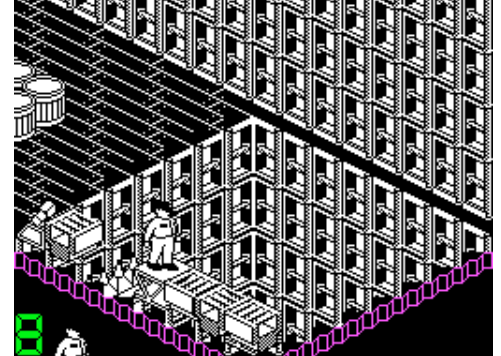

YS issue 86: Beaut Box 1 (Your Sinclair,1993)
Covertape



YS issue 89: Beaut Box 4 (Your Sinclair,1993)
Covertape



YS issue 92: Beaut Box 7 (Your Sinclair,1993)
Covertape



Yuppie (Mental Images,1988)
Text Adventure



Zamonarr (Slowglass,)
Arcade



Zanthrax (Crash,1989)
Arcade

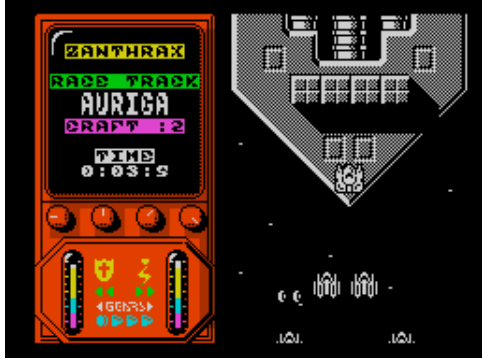

Zaphod Beeblebrox Intro 2 (The Mad Guys,1990)
Scene Demo



Zapper 2 (R. Thomas/J. I-Land Hill,1983)
Utility: Copier

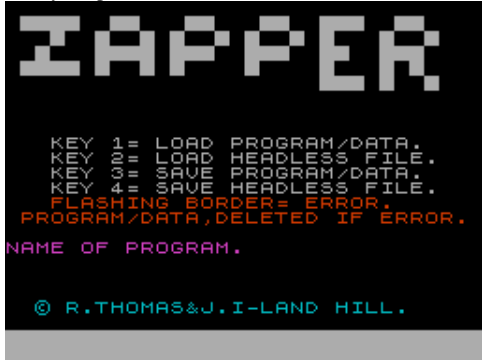

Zarathruster (.)
Arcade



Zamp (MicroHobby,1985)
Arcade



Zany Adventure (Timothy Betts/Steve Parry,1984)
Text Adventure



Zap-Pak (Players Premier Software,1988)
Compilation

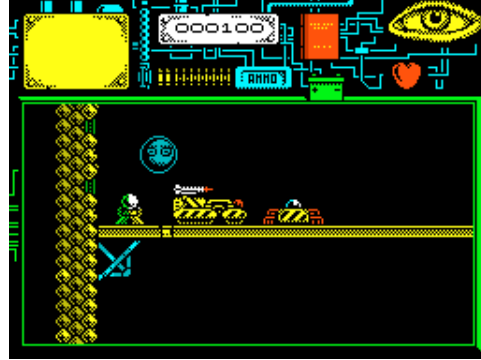

Zappo (.)
Utility: Sound Manipulation

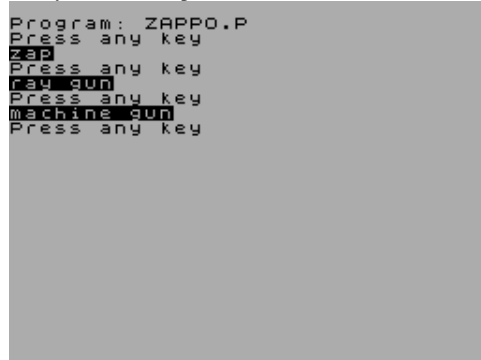

Zarjas (Sinclair User,1988)
Arcade

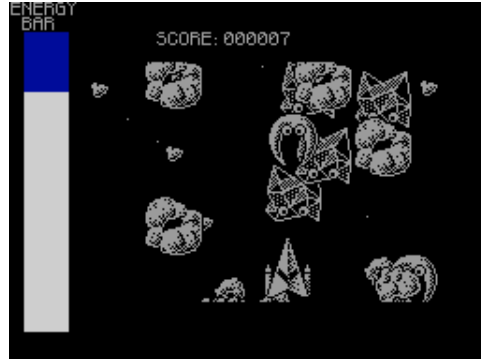

Zampabolas (System 4,1990)
Arcade

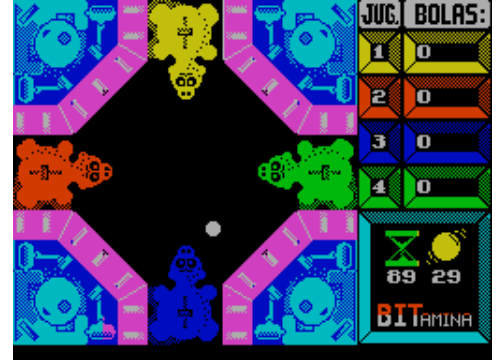

Zaphod Beeblebrox Intro 1 (The Mad Guys,1990)
Scene Demo



Zapper (Anco Software Ltd,1984)
Arcade



Zaraks (CRL Group PLC,1983)
Arcade



Zauberschloss (Achim Kern,)
Text Adventure



Zaxxon (Starzone Software,1983)
Arcade

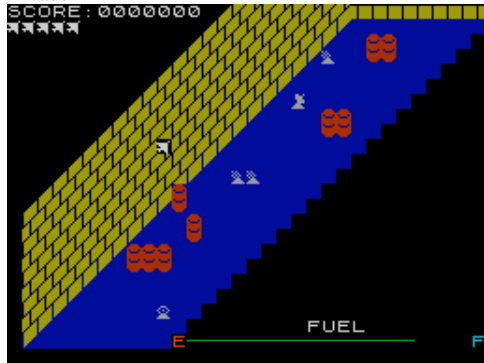

Zblast SD+ (Cronosoft,2003)
Compilation



Zebbedy (Your Computer,1984)
Arcade



Zeichen (.)
Utility: Font/UDGs

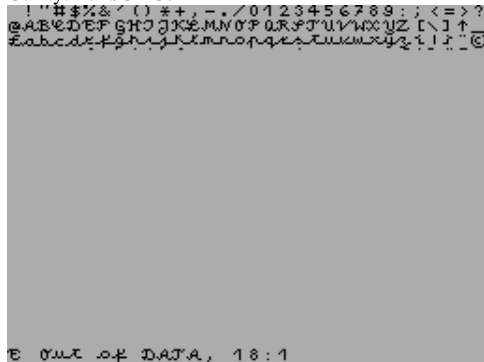

Zemepisny Test (CV Software,1987)
Educational



Zaxxon (D. Boettcher,)
Arcade

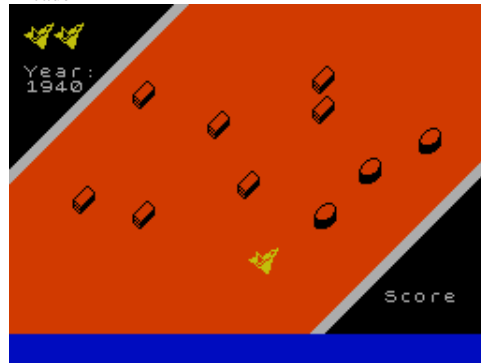

Zeroll 1 (Icabod,1994)
Scene Demo



Zeeslag (Richard Lander,1990)
Board/Card Game

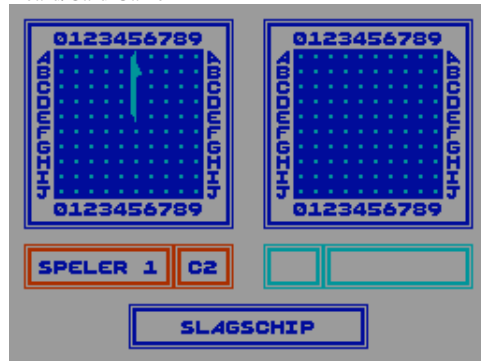

Zeichensatz (Individual Software Service,1984)
Utility

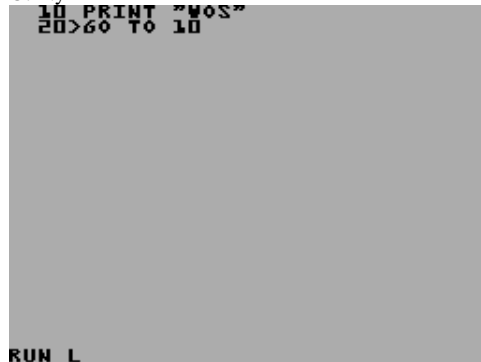

Zen (Kuma Computers Ltd,1984)
Utility: Programming



Zaxxon (US Gold Ltd,1985)
Arcade



Zeroll 2 (Icabod,1994)
Scene Demo

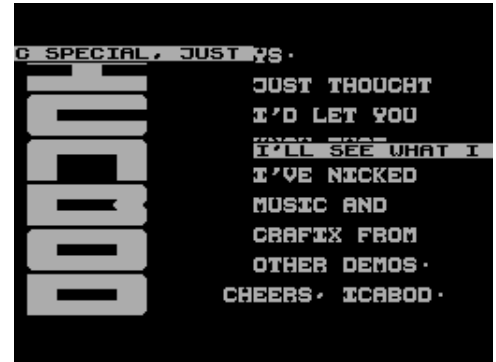

Zegar (Janusz Gajewicz,1985)
Educational

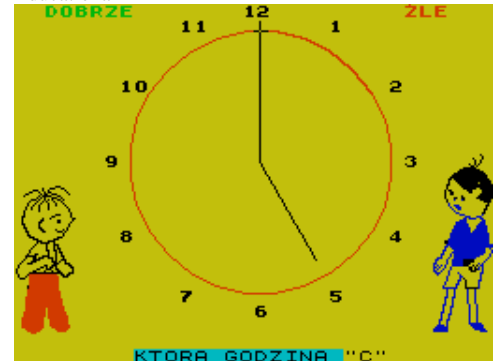

Zeichensatz-Generator (.)
Utility: Font/UDGs

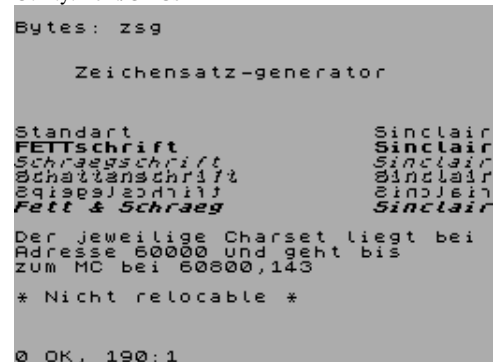

Zenji (Activision Inc,1984)
Arcade

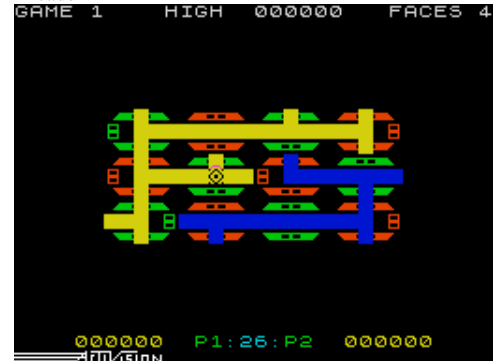

Zen Quest (Zenobi Software,1995)

Text Adventure

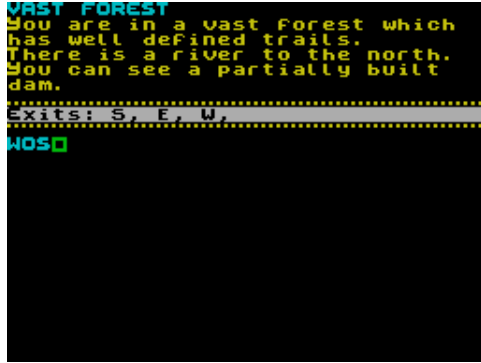

Zeon (Jorge Perez Barreiro,1986)

Arcade

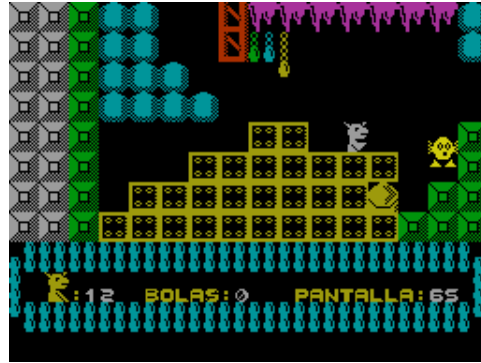

Zepherus (National Software Library,1985)

Text Adventure

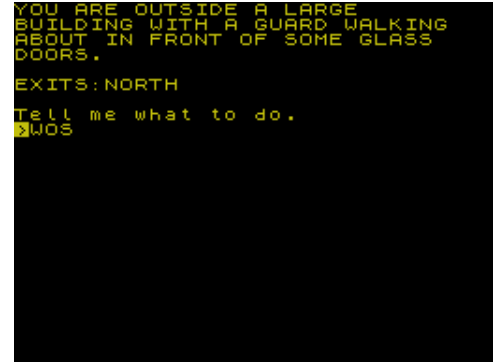

Zero 97 Info (Zer0,1997)

Scene Demo

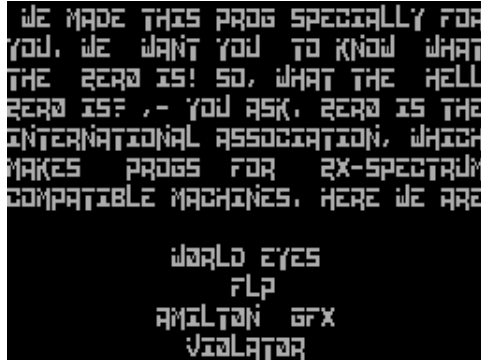

Zeus Assembler (Crystal Computing,1983)

Utility: Assembler/Disassembler/Monitor

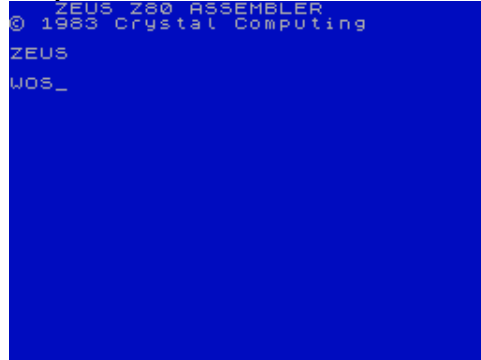

Z-Fred (AK Wood,1984)

Arcade

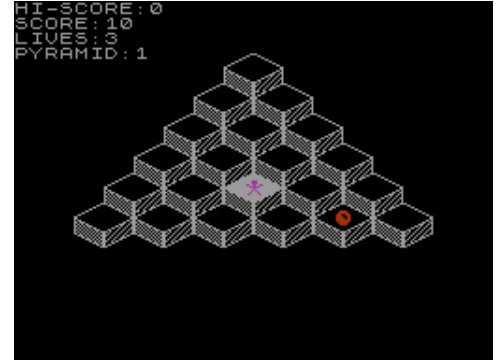

Zhak (MicroHobby,1989)

Arcade Adventure

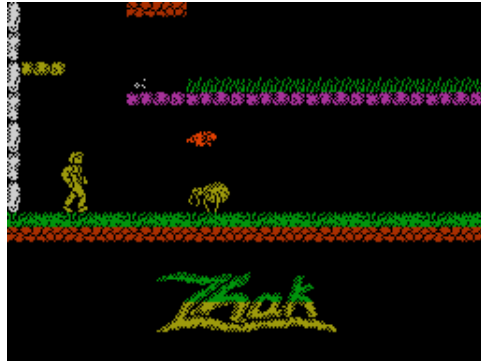

Zhor, el Rey de Oidumas (Rock'n'Soft,1994)

Text Adventure



Ziggurat of Dread (Custom Cables International Ltd,1983)

Text Adventure

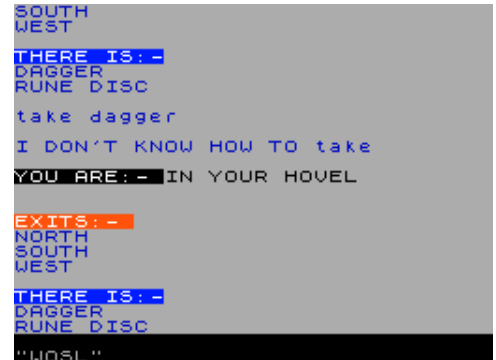

Ziggurat (Ariolasoft UK Ltd,1987)

Arcade



Ziggurat (Software Super Savers Ltd,1984)

Arcade Adventure



Zig Zag (DK'Tronics Ltd,1984)

Arcade



Zip Compiler (Simon N. Goodwin/Jonathan Smith [2],1984)

Utility: BASIC Related



Zipi y Zape (Dro Soft,1989)

Text Adventure



Zipper Flipper (Sinclair Research Ltd,1984)

Arcade



Zippy (Luca Bordini,1986)
Arcade

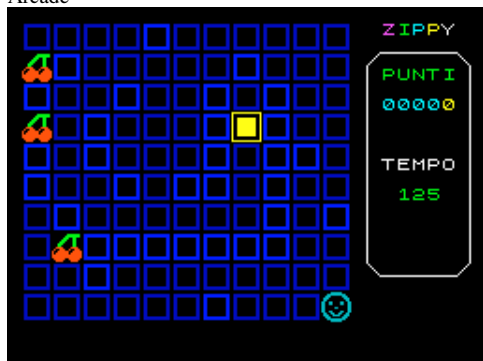

Zly sen Frantiska Koudelky (Proxima Software,1990)
Arcade Adventure



Zodiac Master (Longman Software,1984)
Educational



Zoids (Martech Games Ltd,1985)
Arcade

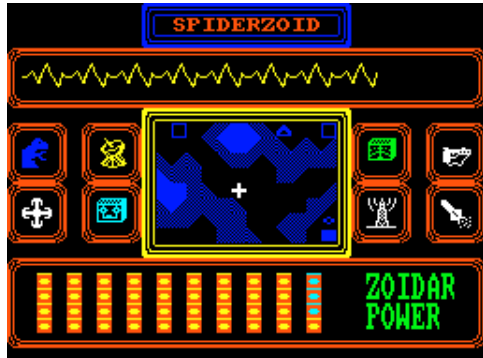

Zolyx (Firebird Software Ltd,1988)
Arcade

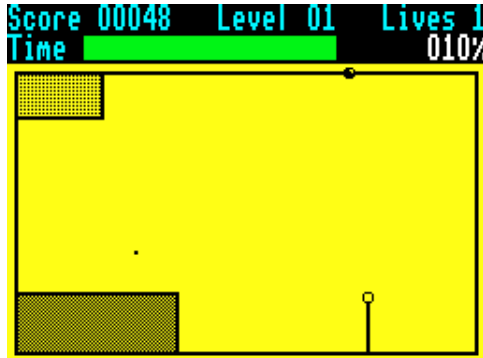

Zip-Zap (Imagine Software Ltd,1983)
Arcade



Z-Man (DJL Software Ltd,1983)
Arcade

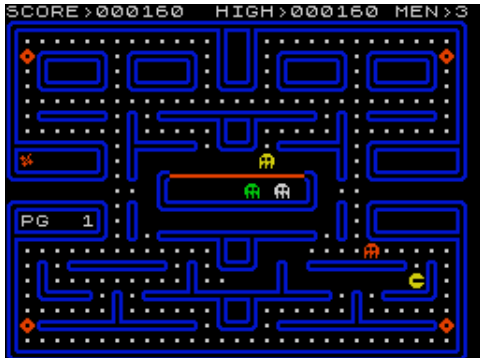

Zodiac Strip (Suzy Soft,1985)
Board/Card Game

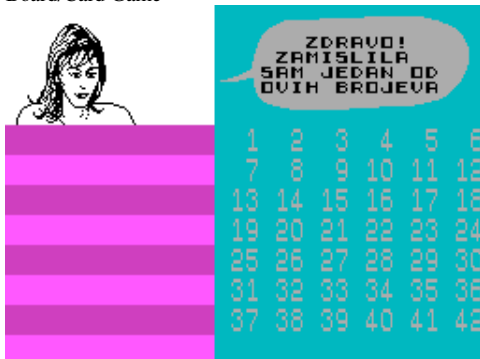

Zoink (MicroHobby,1985)
Arcade



Zombi (Ubi Soft Ltd,1990)
Arcade Adventure

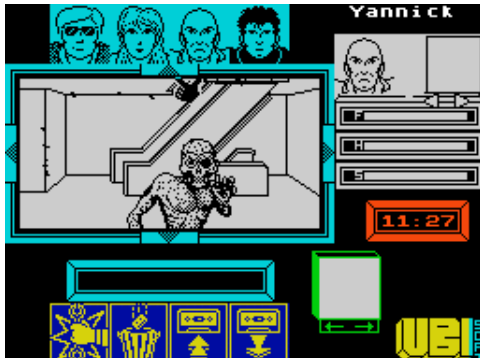

ZipZap (Omega Software Ltd,1988)
Utility



Zodiac FGP (Stellar Services,1983)
Utility: Astronomy/Astrology

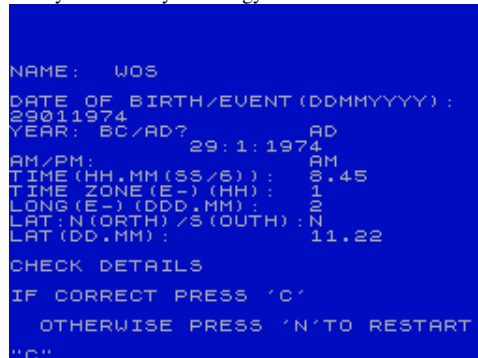

Zogan's Revenge (Compass Software,1986)
Text Adventure



Zolan Adventure, The (Softek Software International Ltd,1983) Text Adventure

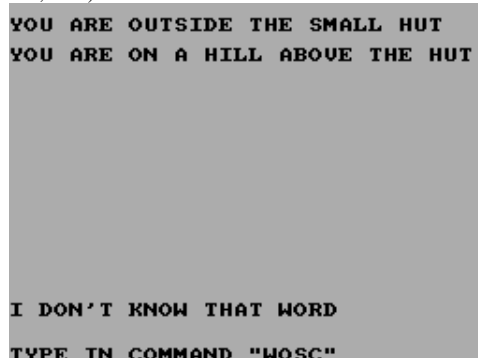

Zombie Island (Spectre Soft,1984)
Strategy



Zombies! (Century Communications Ltd,1983)
Arcade

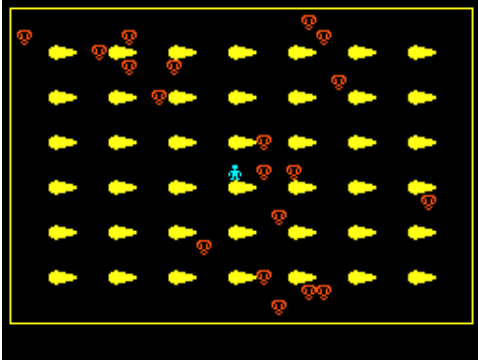

Zona de Combate (Eduardo Mena Nieto,2005)
Arcade

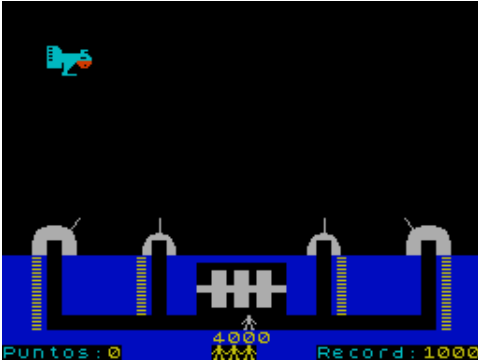

Zone 00 (Allanson Computing,1985)
Arcade



Zone Trooper (Game Busters,1989)
Arcade



Zoom (Omikron Software [1],1987)
Utility: Screen Manipulation

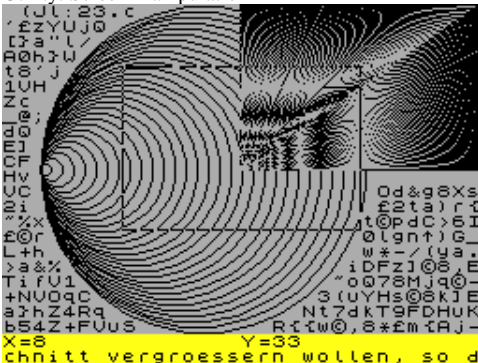

Zombie Zombie (Quicksilva Ltd,1984)
Arcade



Zona de Variables, La (MicroHobby,1985)
Utility: BASIC Related



Zone-M (Zuheir Urwani,1986)
Arcade

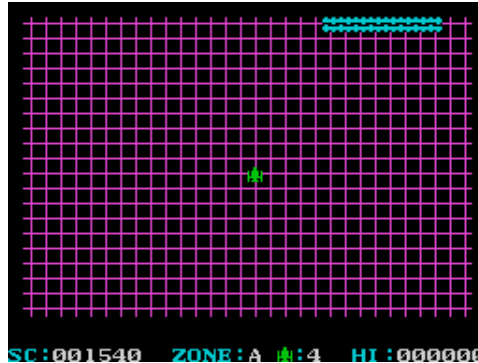

Zoo (L'Ensouleiado Software,1984)
Educational



Zoot (Bug-Byte Software Ltd,1985)
Arcade

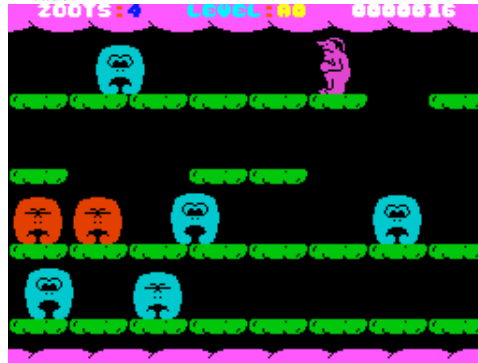

Zona 0 (Topo Soft,1991)
Arcade

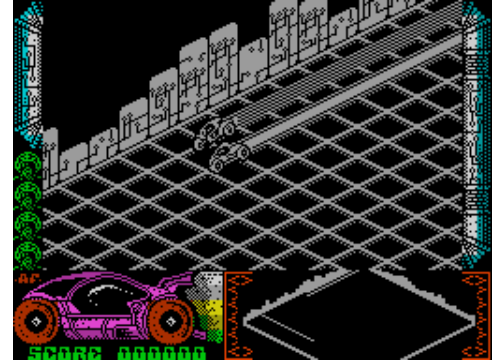

Zona Radioactiva (MicroHobby,1986)
Arcade



Zone, The (Arcade Software,1984)
Text Adventure



Zoom (Hackers Software,1985)
Utility: Screen Manipulation

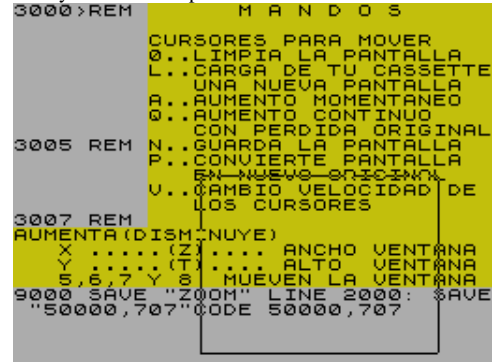

Zorro (US Gold Ltd,1986)
Arcade

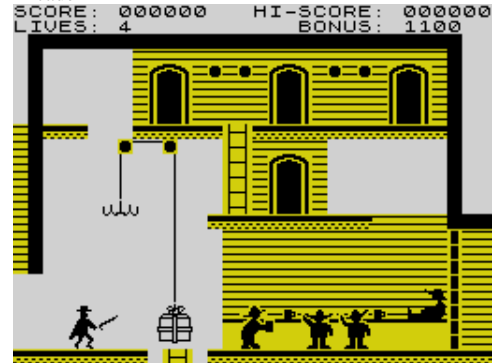

Zortron (Grupo de Trabajo Software S.A.,1987)
Arcade



Zozon (Ivan Benishek,1983)
Arcade

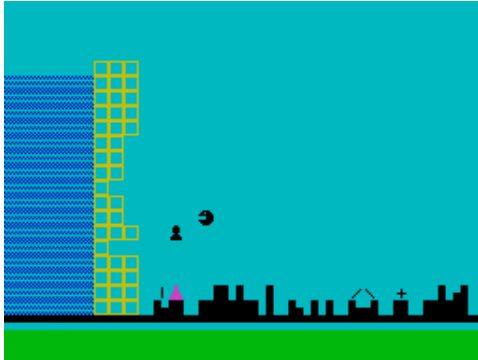

Zuckman (DJL Software Ltd,1982)
Arcade



Zunny II (StapleSoft,1995)
Arcade Adventure



ZX-7 (Ultrasoft,1991)
Utility: Music Creation

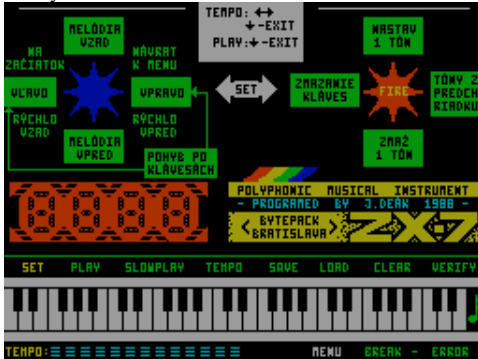

Zotyocopy + (Zoltan Graff,)
Utility: Copier



Z-Shell (Beyond Dreams,2002)
Utility: BASIC Related



Zulu Wars (CCS,1987)
Strategy



Zut Alors! (Aryxoft,1986)
Text Adventure

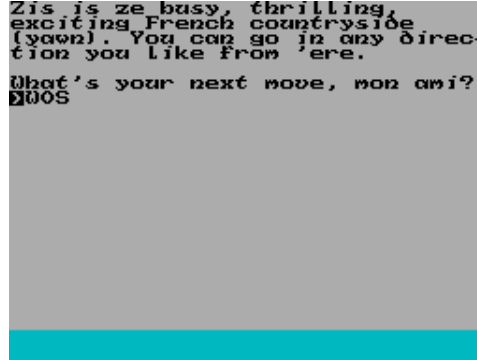

ZX81-Emulator (YRS,)
Simulation

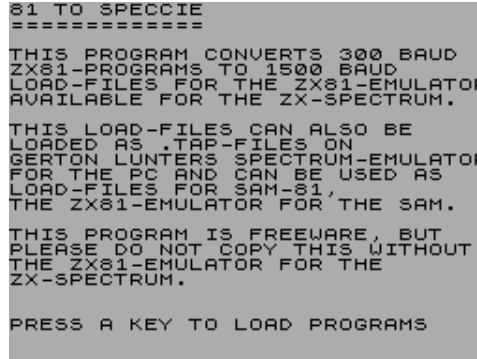

Zounds (16/48 Tape Magazine,1984)
Utility: Sound Manipulation



Zub (Mastertronic Added Dimension,1986)
Arcade

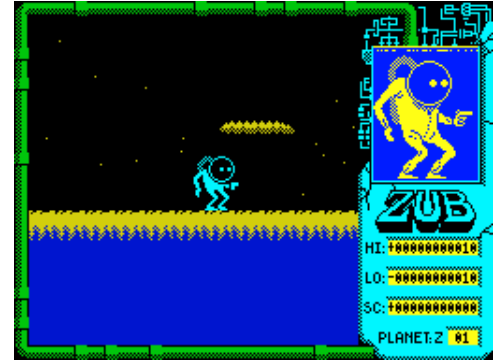

Zunny (StapleSoft,1995)
Arcade Adventure



Zvezdani Zatvorenik (Milivoy Kostic,1989)
Text Adventure



ZX81 Tape (,)
Utility

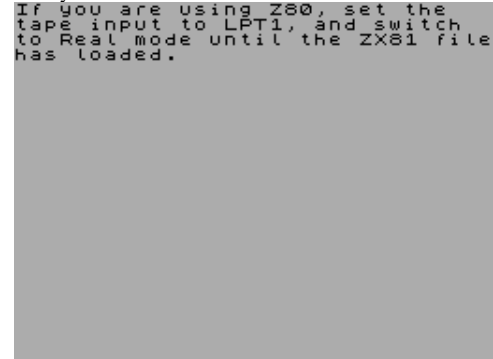

ZX99 (Richard Mark Bacon,1990)
Arcade



ZX Bomber (Matt Barber,2006)
Arcade



ZX Columns (Compiler Software,2005)
Arcade

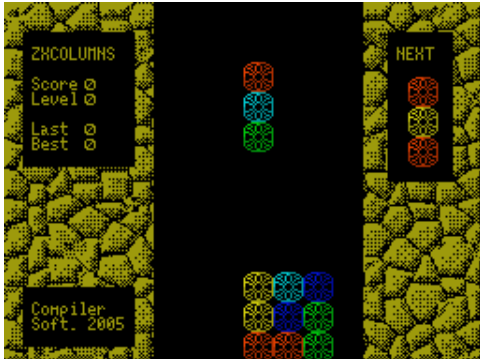

ZX-DISCOM (Michael Schramm,1986)
Utility



ZX Forth (,1983)
Utility: Programming



ZX Berserk (Jega Software,1982)
Arcade

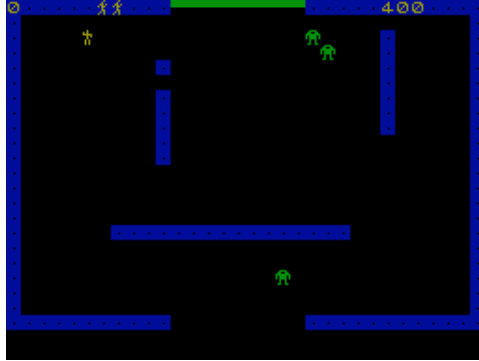

ZX Centi (Callum Gibson,1985)
Arcade



ZX Compiler MMIL.d (Threlfall & Hodgson,1984)
Utility: BASIC Related



ZXED Spectrum Toolkit (DK'Tronics Ltd,1982)
Utility

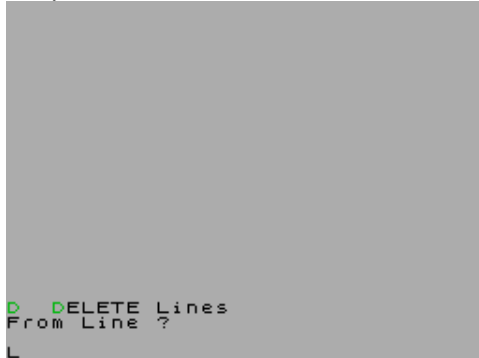

ZX-FX (Simon N. Goodwin,1988)
Utility

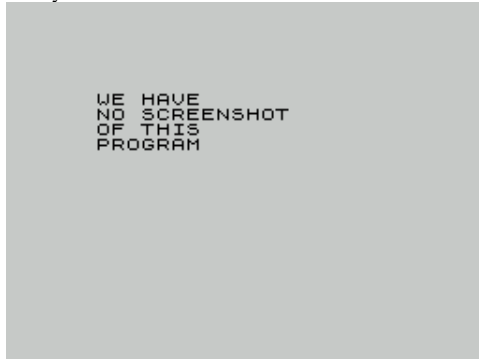

ZX Big-Shot (Buffercraft Software,1984)
Utility: Drawing



ZX-Cesil (Gilsoft International,1982)
Utility: Programming



ZX Defender (Sinclair Programs,1983)
Arcade



ZX Football Manager 2005 (Cronosoft,2005)
Simulation



ZX Gorilla (Panik Software,2006)
Arcade



ZX Graph (Guetano Marano)
Utility: Font/UDGs

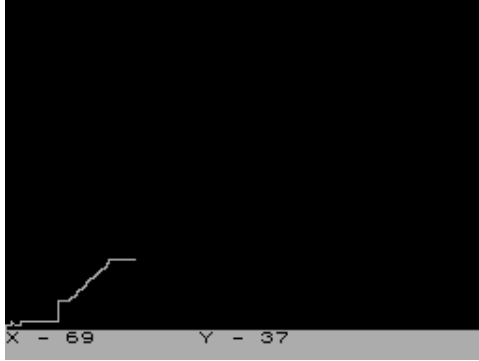

ZX Land 1 (Czerwiec,1992)
Cheat



ZX LPrint (ZX Power Prod,1983)
Utility



ZX Othello (Matt Barber,2006)
Board/Card Game



ZX Reactor (ASP Software Ltd,1983)
Arcade

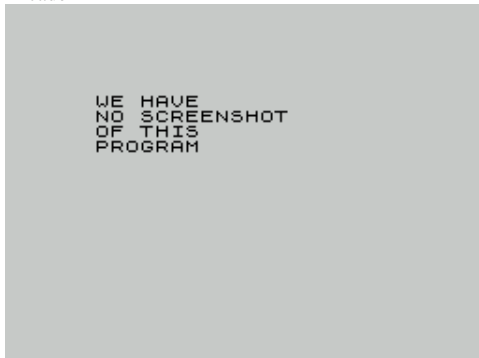

ZX-Karteisystem (Martin Gehrke,1983)
Utility: Database

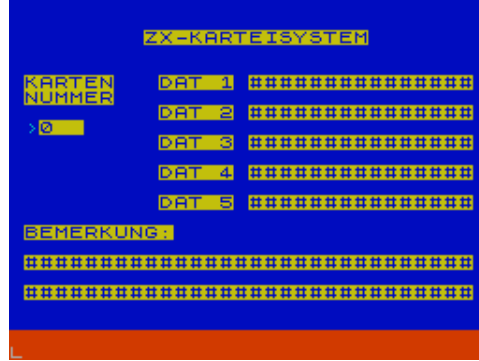

ZX Land 2 (Czerwiec,1992)
Cheat



ZX Mines (Compiler Software,2003)
Board/Card Game



ZX Poker (Compiler Software,2005)
Board/Card Game

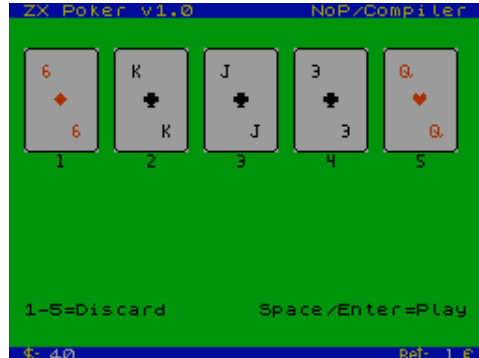

ZX-Reactor (Spectrum Computing,1983)
Arcade



ZX Land (Illusion Group,)
Scene Demo



ZX Link (F+K Ware,1983)
Utility

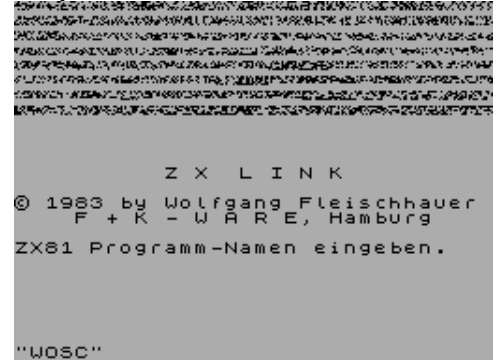

ZX Mines 2 (Compiler Software,2003)
Board/Card Game



ZX Poker (C&VG,1982)
Board/Card Game

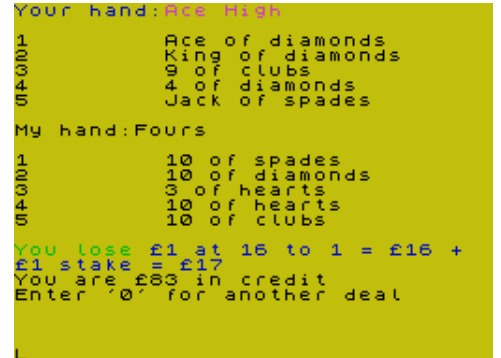

ZX Reversi (CP Software,1983)
Board/Card Game

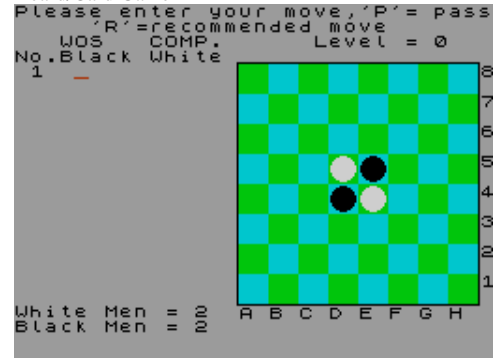

ZX Revija 1 (Stivsoft,1989)

Simulation

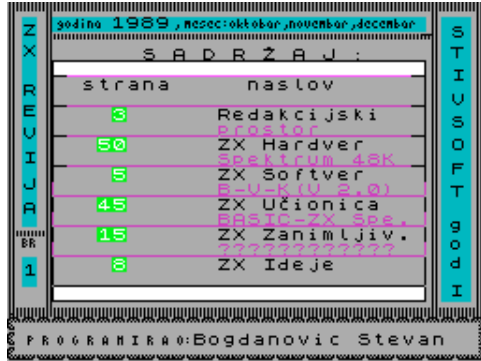

ZX RTTY (OZ1BII,1984)

Utility



ZX-Sideprint (Microsphere,1983)

Utility



ZXSimon (Compiuter Soft,2006)

Board/Card Game



ZX Slowloader (East London Robotics Ltd,1983)

Utility

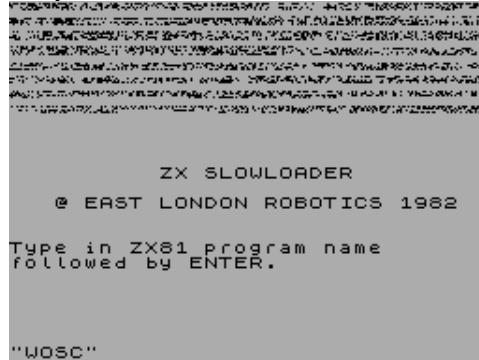

ZX Snake (Federico J. Alvarez Valero,2003)

Arcade



ZX Spectrum+ Graphics Pack (Dorling Kindersley Software,1986) Compilation



ZX Spectrum+ Guia de Funcionamiento (Investronica S.A.,1985) Educational

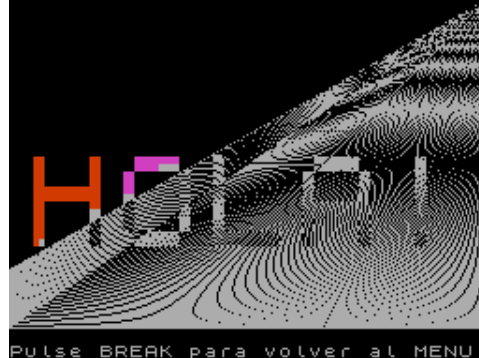

ZX Spectrum+ Starter Pack (Dorling Kindersley Software,1985) Compilation



ZX Spectrum+ User Guide Companion Cassette (Dorling Kindersley Software/Sinclair Research L,1984) Compilation



ZX Spectrum Assembler (McGraw-Hill Book Company UK Ltd,1984) Utility: Programming



ZX Spectrum Demo Cassette (Print'n'Plotter Productions,) Demo

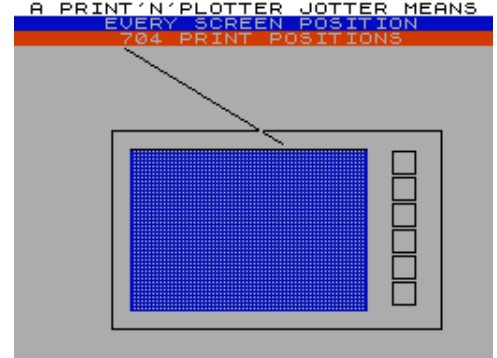

ZX Spectrum Disassembler (,)

Utility: Assembler/Disassembler/Monitor

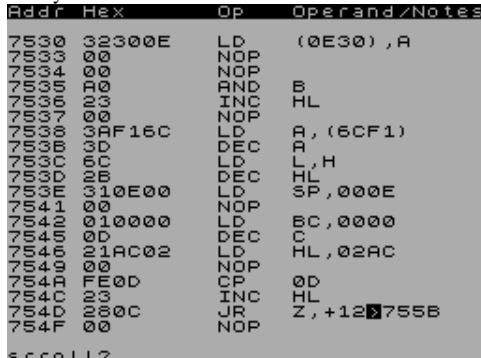

ZX Spectrum Emulator (Softhouse Ltd,1996)

Utility

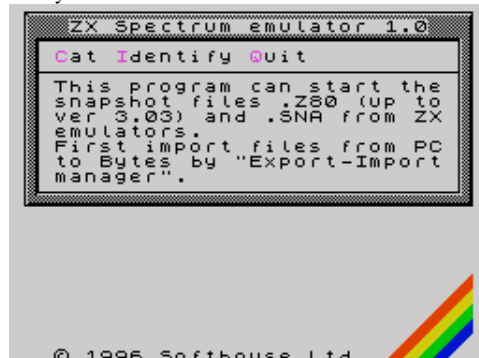

ZX Spectrum Games (JRS Software Ltd,1982)

Compilation

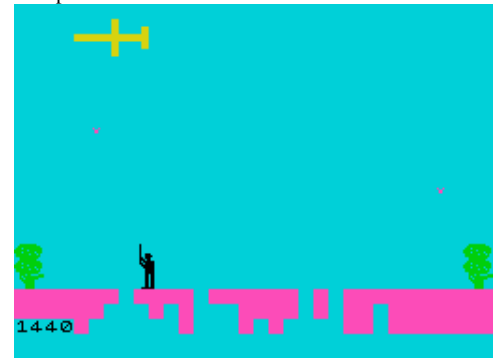

ZX Spectrum Interfacing Programs (McGraw-Hill Book Company UK Ltd,1983) Utility

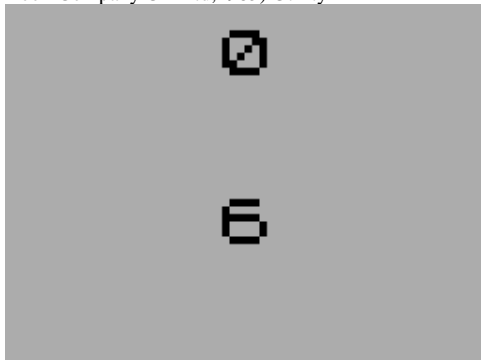

ZX Spectrum User Tape (Ionis Software International,) Compilation



ZX-Telecom (ZX-Software,1986) Utility

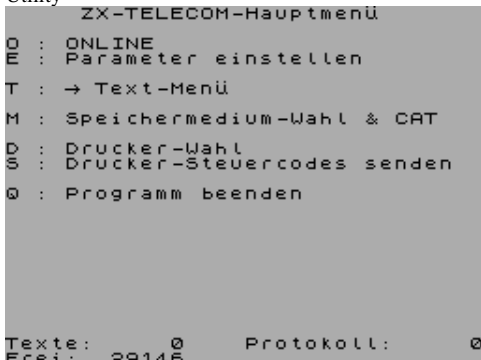

ZX Toolkit (Star Dreams,1983) Utility: Programming



Zybox (Zeppelin Games Ltd,1989) Arcade



ZX Spectrum Orchestra (Half Eaten - Warm Circuit,) Utility

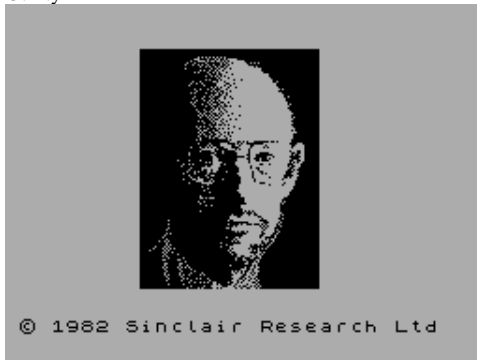

ZX Spectrum User Tape (Sinclair Research Ltd,1984) Compilation



ZX-Text (Ian Stewart,1983) Utility



ZX Trek (Impact Software [1],1982) Arcade



Zynaps (Hewson Consultants Ltd,1987) Arcade



ZX Spectrum Scan Converter (A. Tencati,1984) Utility



ZX Spider (XFAWORLD Software,2003) Simulation



ZX Toolkit (MW Gamesworld,1983) Utility



ZX-Word, The (16/48 Tape Magazine,1984) Board/Card Game



Zythum (Mirrorsoft Ltd,1986) Arcade



Zzoom (Imagine Software Ltd,1983)
Arcade



Zzzz (Mastertronic Ltd,1986)
Text Adventure

