

Kramer Electronics, Ltd.



USER MANUAL

Model:

VP-727T

Presentation Switcher Control Panel

Contents

| | | |
|----------|---|-----------|
| 1 | Introduction | 1 |
| 1.1 | About the VP-727T Presentation Switcher Control Panel | 1 |
| 2 | Getting Started | 1 |
| 2.1 | Quick Start | 1 |
| 3 | Overview | 2 |
| 4 | Your VP-727T Presentation Switcher Control Panel | 3 |
| 5 | Installing in a Desktop | 7 |
| 6 | Installing on a Rack | 9 |
| 7 | Connecting the VP-727T | 10 |
| 7.1 | Connecting via RS-485 | 12 |
| 7.2 | Connecting a PC (via RS-232) | 13 |
| 7.3 | Setting the Machine # | 13 |
| 8 | Operating the VP-727 using the VP-727T | 14 |
| 8.1 | Using the VP-727T WIPE DIRECTION Buttons | 14 |
| 8.2 | Making the Transition | 15 |
| 8.2.1 | Making a Transition Manually | 15 |
| 8.2.2 | Making a Transition Automatically | 15 |
| 9 | Technical Specifications | 15 |

Figures

| | |
|---|----|
| Figure 1: VP-727T Presentation Switcher Control Panel | 4 |
| Figure 2: VP-727T Presentation Switcher Control Panel (Side Panel) | 6 |
| Figure 3: Cut Out Dimensions | 7 |
| Figure 4: Inserting the VP-727T into the Prepared Cut Out Opening | 7 |
| Figure 5: Inserting the Mounting Brackets through the Bracket Slits | 8 |
| Figure 6: Securing the VP-727T into the Prepared Cut Out Opening | 8 |
| Figure 7: Connecting the VP-727T | 11 |
| Figure 8: Connecting the VP-727T RS-485 Ports | 12 |
| Figure 9: Connecting the PC | 13 |

Tables

| | |
|--|----|
| Table 1: VP-727T Presentation Switcher Control Panel Features | 5 |
| Table 2: VP-727T Presentation Switcher Control Panel (Side Panel) Features | 6 |
| Table 3: Defining the WIPE DIRECTIONS Buttons | 14 |
| Table 4: Technical Specifications of the VP-727T | 15 |

1 Introduction

Welcome to Kramer Electronics (since 1981): a world of unique, creative and affordable solutions to the infinite range of problems that confront the video, audio and presentation professional on a daily basis. In recent years, we have redesigned and upgraded most of our line, making the best even better! Our 500-plus different models now appear in 8 Groups¹, which are clearly defined by function. Congratulations on purchasing your Kramer **VP-727T Presentation Switcher Control Panel**, which is ideal for staging events, as well as:

- Presentation applications that require a preview option
- Projection systems in conference rooms, board rooms, auditoriums, hotels, and churches

1.1 About the VP-727T Presentation Switcher Control Panel

The Kramer **VP-727T Presentation Switcher Control Panel** is used to control the **VP-727 Universal Presentation Matrix Switcher / Scaler**². The Kramer **VP-727T** lets you remotely control switcher functions such as input selection, transition effects (that include cut, fade, and wipes) and transition speed.

Note that the **VP-727** needs firmware package Master FW 1.03 (Ver. 1.03) (or higher) to work with the **VP-727T**.

The package includes: the **VP-727T**, gooseneck lamp, null-modem adapter, power supply, rack ears kit³, table-top brackets, and this user manual⁴.

2 Getting Started

We recommend that you:

- Unpack the equipment carefully and save the original box and packaging materials for possible future shipment
- Review the contents of this user manual

2.1 Quick Start

This Quick start chart summarizes the basic steps when connecting a **VP-727T**:

1 GROUP 1: Distribution Amplifiers; GROUP 2: Video and Audio Switchers, Matrix Switchers and Controllers; GROUP 3: Video, Audio, VGA/XGA Processors; GROUP 4: Interfaces and Sync Processors; GROUP 5: Twisted Pair Interfaces; GROUP 6: Accessories and Rack Adapters; GROUP 7: Scan Converters and Scalers; and GROUP 8: Cables and Connectors

2 A true multi-standard video to graphics scaler and seamless switcher with 8 universal inputs comprised of 5 BNC connectors each of which can accommodate a composite video, s-Video (Y/C), component video (RGB/YUV), RGBS, or RGBHV signal. It has dual scalers, one for the preview and the other for the program output. Dual scalers are required to do "live" seamless transitions from one source to another

3 A pair of rack ears, two spacers and ten screws

4 Download up-to-date Kramer user manuals from the Internet at this URL: <http://www.kramerelectronics.com>

Step 1: Mount the machine - see sections 5 and 6

Mount in a desktop, table or a 19" rack-mount, or use freestanding on a table

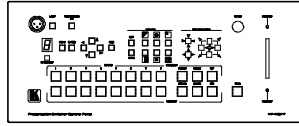

Step 2: Connect the VP-727T - see section 7

Connect the VP-727T to up to 4 VP-727 machines via the RS-485 ports:

Connections

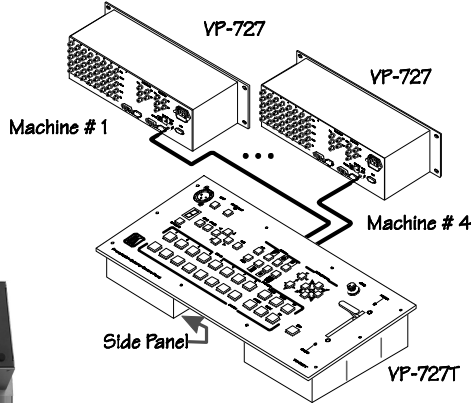

Step 3: Turn the power ON

Step 4: Operate the VP-727T - see section 8

Choose an EFFECT and WIPE DIRECTION - see section 8.1

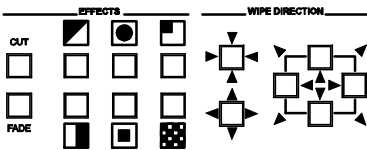

Make the Transition - see section 8.2

Manually make the transition using the T-bar control lever OR

Press the TAKE button to implement the transition (automatically), according to the setting of the SPEED knob

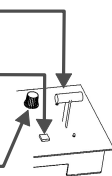

3 Overview

The **VP-727T** is a unique presentation switcher control panel dedicated specifically to control the **VP-727**. It is ergonomically and aesthetically designed in a rugged, professional 19" 4U rack-mountable metal enclosure with the button layout in the style of the **VP-727**. In particular, the **VP-727T**:

- Enables special effect transitions between two sources via a robust T-bar

(used for manual control of transition speeds). Alternatively, the effect can be implemented via a TAKE button, with a potentiometer to set the transition speed

- Features single button access to all inputs¹—both for the Preview and for the Program output—and the buttons have removable transparent caps to allow labeling
- Features dedicated single button actions for special effect selection, immediate freezing and blanking, PIP display, and the choice of wipe direction
- Has the user menu—conveniently located on the **VP-727T** panel—for complete control of the **VP-727** via its Preview OSD
- Consol can be simultaneously connected to up to four **VP-727** machines. Control communication is via the RS-485 port, thus allowing the panel to be located more than 1km from each **VP-727**
- Has an RS-232 port for field upgrading of its firmware
- With its angled faceplate, may be used freestanding on a table, or mounted in a desktop or in a 19" rack (when your switcher is rack-mounted near to the source devices, you can conveniently place the **VP-727T** on a table or desk away from the equipment rack)
- Has a gooseneck lamp (included) that can be plugged into the consol for use in low lighting environments
- Is powered by a 12V DC source

To achieve the best performance:

- Connect only good quality connection cables
- Avoid interference from neighboring electrical appliances, make sure not to block the ventilation holes and position your **VP-727T** away from moisture, excessive sunlight and dust. Be sure to position it straight in the correct horizontal position on the table, desk or rack



Caution – No operator-serviceable parts inside unit.

Warning – Use only the Kramer Electronics input power wall adapter that is provided with this unit².

Warning – Disconnect power and unplug unit from wall before installing or removing device or servicing unit.

4 Your VP-727T Presentation Switcher Control Panel

Figure 1 and Table 1 define the front panel of the **VP-727T**:

¹ Has two sets of input buttons: one that routes the input to the "PROGRAM" output and the other that routes to the "PREVIEW" output

² For example: model number AD2512C, part number 2535-000251

Your VP-727T Presentation Switcher Control Panel

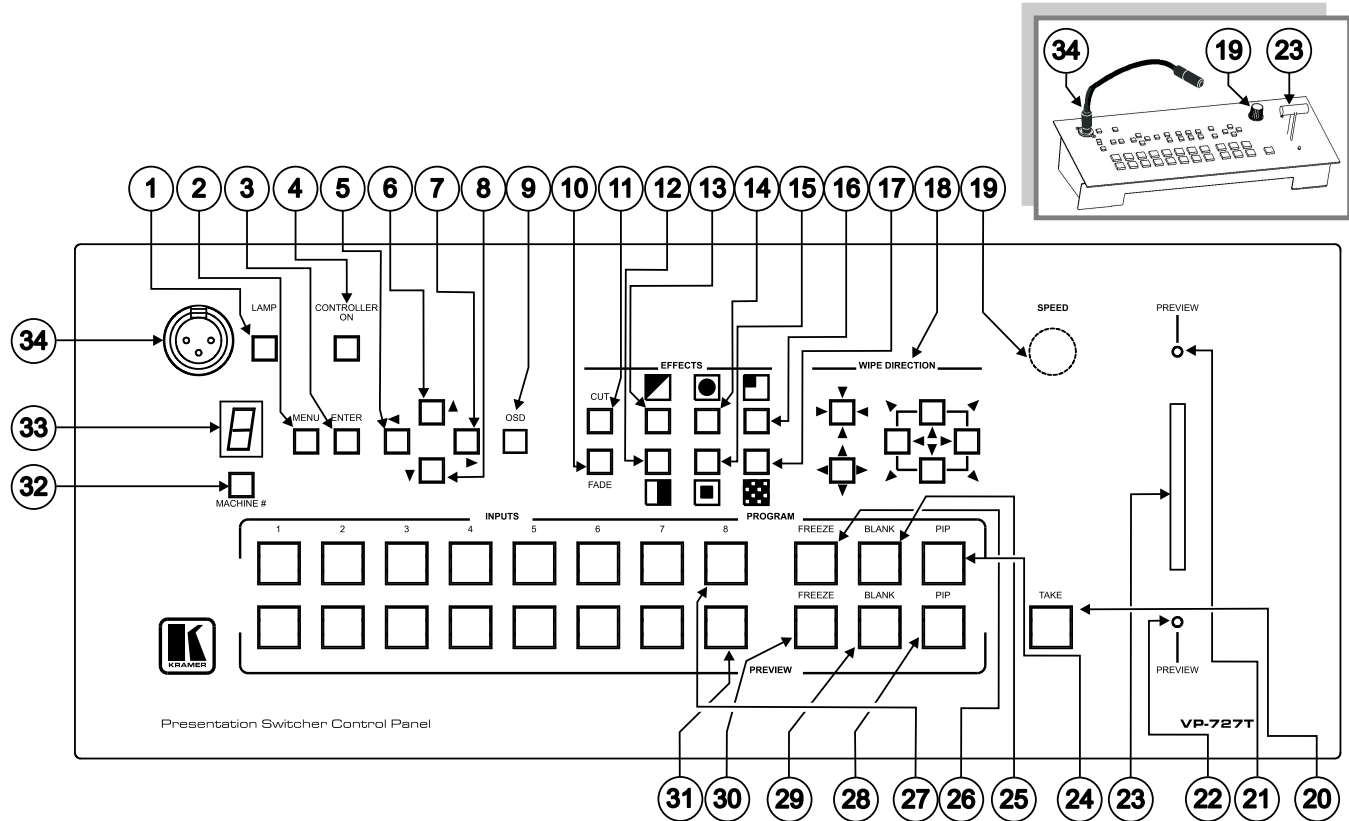







Figure 1: VP-727T Presentation Switcher Control Panel

Table 1: VP-727T Presentation Switcher Control Panel Features

| # | Feature | Function |
|----|--|---|
| 1 | LAMP Button | Toggles the gooseneck lamp ON/OFF |
| 2 | MENU Button | Displays the OSD Menu screen (or moves to the previous level in the OSD menu) |
| 3 | ENTER Button | Moves to the next level in the OSD menu |
| 4 | CONTROLLER ON Button | Toggles the VP-727T Presentation Switcher Control Panel ON/OFF |
| 5 | OSD NAVIGATION Buttons | ◀ Toggles within each level 2 command / decreases the range by one step |
| 6 | | ▲ Moves up one step (in the same level) in the OSD menu |
| 7 | | ▶ Toggles within each level 2 command / increases the range by one step |
| 8 | | ▼ Moves down one step (in the same level) in the OSD menu |
| 9 | OSD Button | Activates/deactivates access to the OSD Menu ¹ |
| 10 | FADE ² Button | Selects a dissolved transition from the PREVIEW to the PROGRAM output |
| 11 | CUT ² Button | Selects an instantaneous transition from the PREVIEW to the PROGRAM output |
| 12 | TRANSITION Buttons ^{3,5} |  Selects a WIPE transition effect |
| 13 | |  Selects a DIAGONAL transition effect |
| 14 | |  Selects a CIRCLE transition effect |
| 15 | |  Selects a SQUARE transition effect |
| 16 | |  Selects a CORNER transition effect |
| 17 | |  Selects a CHESSBOARD transition effect |
| 18 | WIPE DIRECTION Buttons | Choose the direction of the effect ⁴ : inwards, outwards, "left to right", "right to left", "up" or "down" (see section 8.2) |
| 19 | SPEED Knob | Adjusts the TAKE button transition speed |
| 20 | TAKE Button ⁵ | Pressing TAKE causes the transition to occur automatically |
| 21 | PREVIEW LED | Lights when the T-bar Controller is directed upwards |
| 22 | PREVIEW LED | Lights when the T-bar Controller is directed downwards |
| 23 | T-bar Control Lever ⁶ | Slide to manually implement the effect using the T-bar handle |
| 24 | PROGRAM Buttons | PIP Toggles the picture-in-picture function on and off |
| 25 | | BLANK Toggles between a blank screen and the selected input |
| 26 | | FREEZE Freezes the output video image (toggle) |
| 27 | INPUTS Selects one of the sources: R/PR, G/Y/CV, B/Pb/C, Hs/Cs, Vs (from 1 to 8) | |
| 28 | PREVIEW Buttons | PIP Toggles the picture-in-picture function on and off |
| 29 | | BLANK Toggles between a blank screen and the selected input |
| 30 | | FREEZE Freezes the output video image (toggle) |
| 31 | | INPUTS Selects one of the sources: R/PR, G/Y/CV, B/Pb/C, Hs/Cs, Vs (from 1 to 8) |
| 32 | MACHINE # Button | Pressing selects which MACHINE # is controlled |
| 33 | 7-segment LED Display | Shows the MACHINE # |
| 34 | Lamp Connector | Connects to the gooseneck lamp |

1 The LCD is not affected by the OSD setting

2 Only for setting up the unit for the effect. The effect will only occur when the Take button is pressed, or the T-bar is moved

3 Select a specific effect for the transition from the PREVIEW output to the PROGRAM output

4 From where the effect starts

5 The effect is only seen in PROGRAM Mode. The PREVIEW screen will blank during the transition

6 An alternative to using the TAKE button

Figure 2 and Table 2 define the side panel of the **VP-727T**:

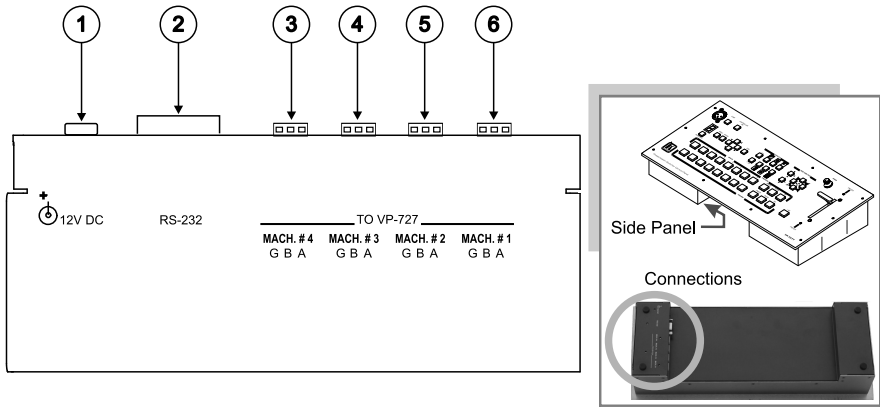

Figure 2: VP-727T Presentation Switcher Control Panel (Side Panel)

Table 2: VP-727T Presentation Switcher Control Panel (Side Panel) Features

| # | Feature | Function | |
|---|---|---|--|
| 1 | 12V DC | +12V DC connector for powering the unit | |
| 2 | RS-232 DB 9 Connector | Connects to the PC for upgrading the firmware | |
| 3 | TO VP-727 3-PIN Terminal Block | MACH. # 4 | Connects to the RS-485 port ¹ on the VP-727 which is recognized as machine # 4 |
| 4 | | MACH. # 3 | Connects to the RS-485 port ¹ on the VP-727 which is recognized as machine # 3 |
| 5 | | MACH. # 2 | Connects to the RS-485 port ¹ on the VP-727 which is recognized as machine # 2 |
| 6 | | MACH. # 1 | Connects to the RS-485 port ¹ on the VP-727 which is recognized as machine # 1 |

¹ Pin G is for the Ground connection, which is sometimes connected to the shield of the RS-485 cable. In most applications, the ground is not connected; pins B (-) and A (+) are for RS-485. The RS-485 PINOUT: GBA may not be printed on some VP-727T units

5 Installing in a Desktop

This section describes how to install the **VP-727T** in a desktop¹.

To install the **VP-727T** in a desktop:

1. Cut an opening in the desktop—making the cut out on a wooden surface using a sabre saw or a keyhole saw—at the location where you want to insert the **VP-727T**. Figure 3 illustrates the cut out template (not to scale) defining the surface that you have to cut out to install your **VP-727T**.

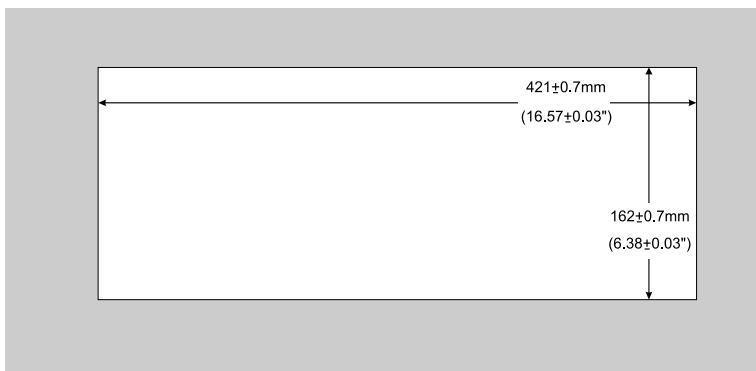

Figure 3: Cut Out Dimensions

2. Carefully insert the **VP-727T** unit into the prepared cut out opening, as illustrated in Figure 4.

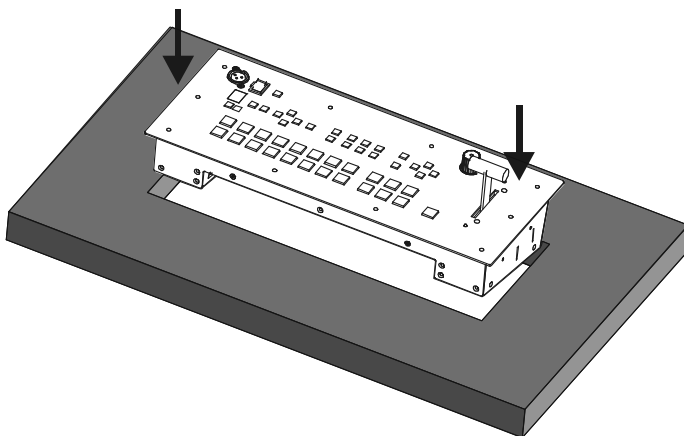

Figure 4: Inserting the VP-727T into the Prepared Cut Out Opening

¹ Alternatively, you can use it freestanding on a table, or mounted in a 19" rack (see section 6)

3. Insert the two mounting brackets through the bracket slits on both sides of the **VP-727T** unit (see Figure 5).

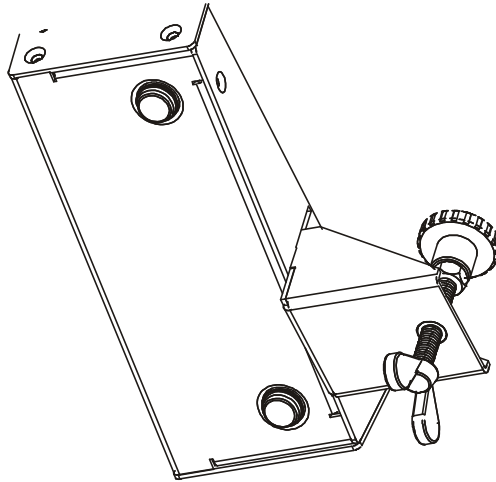

Figure 5: Inserting the Mounting Brackets through the Bracket Slits

4. Be sure that the upper outer rim is situated parallel to the edge of the desktop.
5. Screw the mounting butterfly screws until they reach the desktop surface (from the underneath).
6. Tighten the locking butterfly screws to lock the mounting butterfly screws. The **VP-727T** unit is now secured in place, as illustrated in Figure 6.

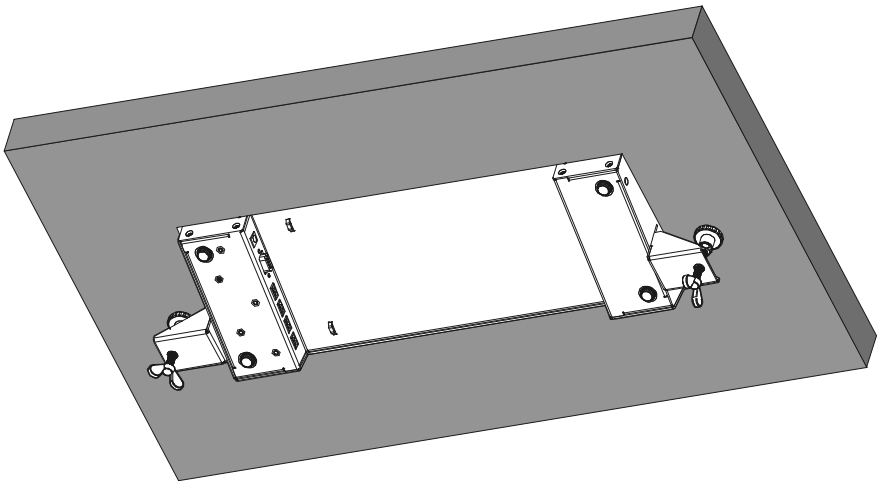

Figure 6: Securing the VP-727T into the Prepared Cut Out Opening

6 Installing on a Rack

This section describes what to do before installing on a rack and how to rack mount.

Before Installing on a Rack

| | |
|--|------------------------------|
| Before installing on a rack, be sure that the environment is within the recommended range: | |
| Operating temperature range | +5 to +45 Deg. Centigrade |
| Operating humidity range | 5 to 65% RHL, non-condensing |
| Storage temperature range | -20 to +70 Deg. Centigrade |
| Storage humidity range | 5 to 95% RHL, non-condensing |



CAUTION!!

When installing on a 19" rack, avoid hazards by taking care that:

- 1 It is located within the recommended environmental conditions, as the operating ambient temperature of a closed or multi unit rack assembly may exceed the room ambient temperature.
- 2 Once rack mounted, enough air will still flow around the machine.
- 3 The machine is placed straight in the correct horizontal position.
- 4 You do not overload the circuit(s). When connecting the machine to the supply circuit, overloading the circuits might have a detrimental effect on overcurrent protection and supply wiring. Refer to the appropriate nameplate ratings for information. For example, for fuse replacement, see the value printed on the product label.
- 5 The machine is earthed (grounded) in a reliable way and is connected only to an electricity socket with grounding. Pay particular attention to situations where electricity is supplied indirectly (when the power cord is not plugged directly into the socket in the wall), for example, when using an extension cable or a power strip, and that you use only the power cord that is supplied with the machine.

How to Rack Mount

To rack-mount a machine:

- 1 Attach both ear brackets to the machine. To do so, fasten the 5 screws on each side of the machine through the ear bracket via the spacer, securing both ear brackets to the machine.

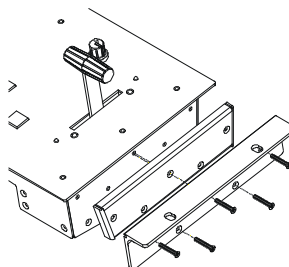

- 2 Place the ears of the machine against the rack rails, and insert the proper screws (not provided) through each of the four holes in the rack ears.

Note that:

- In some models, the front panel may feature built-in rack ears
- Detachable rack ears can be removed for desktop use
- Always mount the machine in the rack before you attach any cables or connect the machine to the power
- If you are using a Kramer rack adapter kit (for a machine that is not 19"), see the Rack Adapters user manual for installation instructions (you can download it at: <http://www.kramerelectronics.com>)

7 Connecting the VP-727T

To connect the **VP-727T** to up to four **VP-727** machines, as the example in Figure 7 illustrates¹, do the following²:

1. Connect the “TO VP-727” RS-485 3-PIN terminal block ports of the **VP-727T**, as follows (see section 7.1):
 - *MACH. # 1* to the RS-485 port of the **VP-727** which will be recognized as machine # 1
 - *MACH. # 2* to the RS-485 port of the **VP-727** which will be recognized as machine # 2
 - *MACH. # 3* to the RS-485 port of the **VP-727** which will be recognized as machine # 3
 - *MACH. # 4* to the RS-485 port of the **VP-727** which will be recognized as machine # 4
2. Connect the 12V DC power adapter to the power socket and connect the adapter to the mains electricity (not illustrated in Figure 7).

If you want to control all of the four units simultaneously, press the MACHINE # button until the letter A is selected in the 7-segment LED display
If you wish to connect less than four units and control them simultaneously, one of the units must be connected to port #1

¹ The RS-232 port is for firmware upgrade only, see section 7.2

² Switch OFF the power on each device before connecting it to your VP-727T. After connecting your VP-727T, switch on its power and then switch on the power on each device

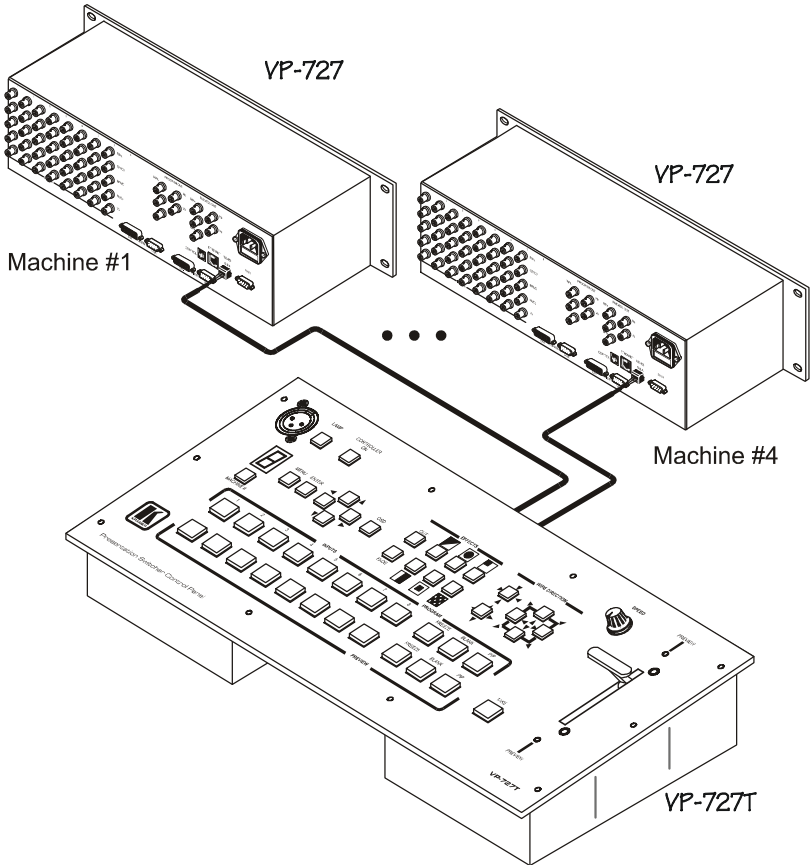

Figure 7: Connecting the VP-727T

7.1 Connecting via RS-485

When connecting the “TO VP-727” RS 485 3 PIN terminal block ports of the **VP-727T**, to the respective **VP-727** machine, connect the:

- “A” (+) PIN of the **VP-727T** to the “A” (+) PIN of the **VP-727**
- “B” (+) PIN of the **VP-727T** to the “B” (+) PIN of the **VP-727**
- If shielded twisted pair cable is used, the shield may be connected to the “G” (Ground) PIN on one of the units

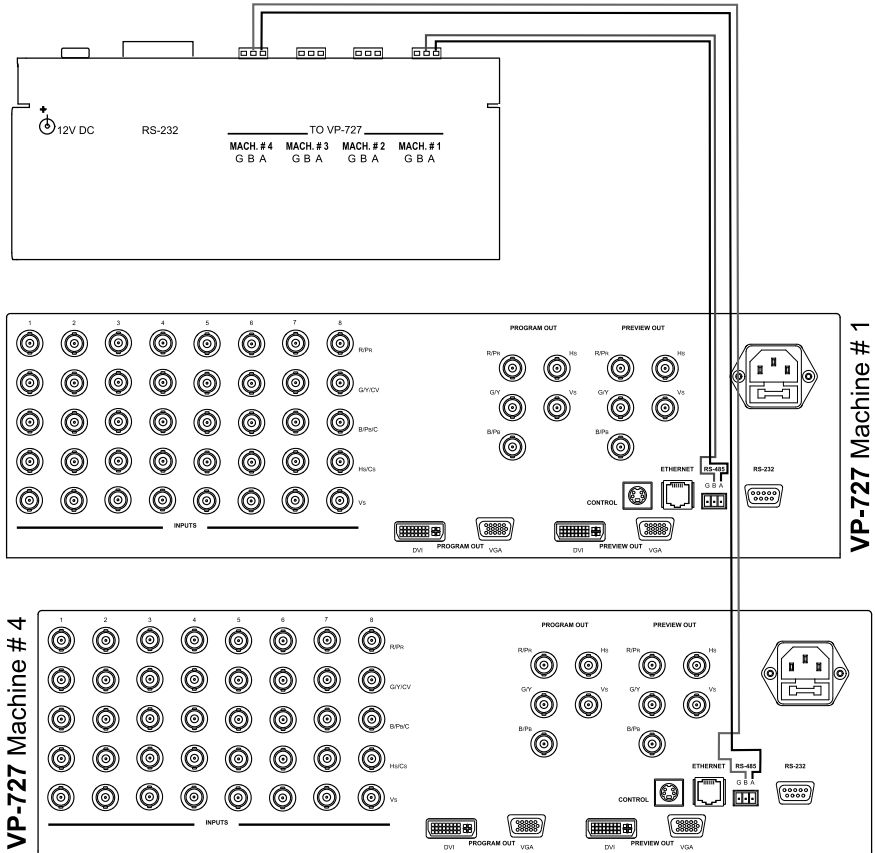

Figure 8: Connecting the VP-727T RS-485 Ports

7.2 Connecting a PC (via RS-232)

You can connect a PC (or other controller) to the **VP-727T** via the RS-232 port for **upgrading the firmware**.

To connect a PC to a **VP-727T** unit, using the Null-modem adapter provided with the machine (recommended):

- Connect the RS-232 DB9 rear panel port on the **VP-727T** unit to the Null-modem adapter and connect the Null-modem adapter with a 9 wire flat cable to the RS-232 DB9 port on your PC

To connect a PC to a **VP-727T** unit, without using a Null-modem adapter:

- Connect the RS-232 DB9 port on your PC to the RS-232 DB9 rear panel port on the **VP-727T** unit, forming a cross-connection¹, as Figure 9 illustrates

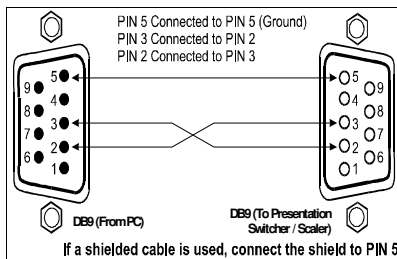

Figure 9: Connecting the PC

7.3 Setting the Machine

The **VP-727T** automatically recognizes the MACHINE # of each **VP-727** unit.

For example, the **VP-727** unit that is connected to the “TO VP-727” RS 485 port MACH. # 3 is recognized as the third **VP-727** unit: MACHINE # 3.

To access this particular **VP-727** unit from the **VP-727T**, press the MACHINE # button² until the number 3 is selected in the 7-segment LED display³.

¹ Also known as a Null-modem connection

² Item 32 in Figure 1 and Table 1

³ Item 33 in Figure 1 and Table 1

8 Operating the VP-727 using the VP-727T











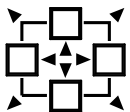

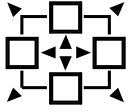
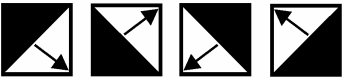
For details of how to operate the **VP-727** via the OSD Menu, LCD Display, ETHERNET, and/or RS-232, including using the TAKE button, refer to the **VP-727** user manual¹. For details of how to:

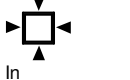
- Use the WIPE DIRECTION buttons, see section 8.1
- Adjust the transition speed, see section 8.2

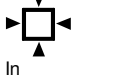
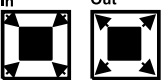
8.1 Using the VP-727T WIPE DIRECTION Buttons

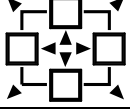
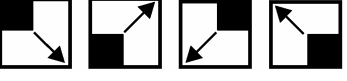
To set the wipe direction, use the WIPE DIRECTION buttons² (see Table 3):

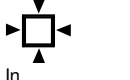
Table 3: Defining the WIPE DIRECTIONS Buttons

| EFFECTS | WIPE DIRECTIONS | | |
|---|---|---|---|
|  Wipe |  | Choice of four directions (only one button is selected) |  |
|  Diagonal |  | Choice of four directions (two buttons are selected simultaneously) |  |
|  Circle |  | In Out |  |
|  Square |  | In Out |  |
|  Corner |  | Choice of four directions (two buttons are selected simultaneously) |  |
|  Chessboard |  | In Out |  <p>Each block performs as shown in the "Square" above</p> |

¹ Download up-to-date Kramer user manuals from the Internet at this URL: <http://www.kramerelectronics.com>

² Item 18 in Figure 1 and Table 1

8.2 Making the Transition

You can make the transition in two ways:

- Manually, for each separate transition using the T-bar control lever¹
- Automatically, via the TAKE button, which implements the transition at the pace set by the SPEED² knob

8.2.1 Making a Transition Manually

To make the transition, manually:

- Slide the T-bar handle upwards³ or downwards⁴

8.2.2 Making a Transition Automatically

To make the transition, automatically:

- Rotate the SPEED knob² to the right (increasing the transition speed) or to the left (decreasing the transition speed). When the knob is turned to the extreme counter-clockwise position (off), the switch will be engaged to turn the knob off. In this position, the speed setting is controlled via the setting in the **VP-727** OSD menu
- Pressing the TAKE button⁵ causes the transition to occur automatically

9 Technical Specifications

Table 4 includes the technical specifications:

Table 4: Technical Specifications⁶ of the VP-727T

| | |
|---------------|---|
| PORTS: | 4 sets of RS-485 3-PIN Terminal Block Ports |
| CONTROLS: | Front panel buttons, RS-232, and RS-485 |
| POWER SOURCE: | 12 VDC, 240mA |
| DIMENSIONS: | 19" (W), 3.4" (D), 4RU (H) rack mountable ⁷ |
| WEIGHT: | 1.58kg. (3.5 lbs.) approx. |
| ACCESSORIES: | Gooseneck lamp, null-modem adapter, power supply, rack ears kit ⁸ , and table-top brackets |

1 Item 23 in Figure 1 and Table 1

2 Item 19 in Figure 1 and Table 1

3 The PREVIEW LED lights (item 21 in Figure 1 and Table 1)

4 The PREVIEW LED lights (item 22 in Figure 1 and Table 1)

5 Item 20 in Figure 1 and Table 1

6 Specifications are subject to change without notice

7 48.2cm (W), 8.6cm (D), 17.7cm (H)

8 A pair of rack ears, two spacers and ten screws

LIMITED WARRANTY

Kramer Electronics (hereafter *Kramer*) warrants this product free from defects in material and workmanship under the following terms.

HOW LONG IS THE WARRANTY

Labor and parts are warranted for seven years from the date of the first customer purchase.

WHO IS PROTECTED?

Only the first purchase customer may enforce this warranty.

WHAT IS COVERED AND WHAT IS NOT COVERED

Except as below, this warranty covers all defects in material or workmanship in this product. The following are not covered by the warranty:

1. Any product which is not distributed by Kramer, or which is not purchased from an authorized Kramer dealer. If you are uncertain as to whether a dealer is authorized, please contact Kramer at one of the agents listed in the Web site www.kramerelectronics.com.
2. Any product, on which the serial number has been defaced, modified or removed.
3. Damage, deterioration or malfunction resulting from:
 - i) Accident, misuse, abuse, neglect, fire, water, lightning or other acts of nature
 - ii) Product modification, or failure to follow instructions supplied with the product
 - iii) Repair or attempted repair by anyone not authorized by Kramer
 - iv) Any shipment of the product (claims must be presented to the carrier)
 - v) Removal or installation of the product
 - vi) Any other cause, which does not relate to a product defect
 - vii) Cartons, equipment enclosures, cables or accessories used in conjunction with the product

WHAT WE WILL PAY FOR AND WHAT WE WILL NOT PAY FOR

We will pay labor and material expenses for covered items. We will not pay for the following:

1. Removal or installations charges.
2. Costs of initial technical adjustments (set-up), including adjustment of user controls or programming. These costs are the responsibility of the Kramer dealer from whom the product was purchased.
3. Shipping charges.

HOW YOU CAN GET WARRANTY SERVICE

1. To obtain service on you product, you must take or ship it prepaid to any authorized Kramer service center.
2. Whenever warranty service is required, the original dated invoice (or a copy) must be presented as proof of warranty coverage, and should be included in any shipment of the product. Please also include in any mailing a contact name, company, address, and a description of the problem(s).
3. For the name of the nearest Kramer authorized service center, consult your authorized dealer.

LIMITATION OF IMPLIED WARRANTIES

All implied warranties, including warranties of merchantability and fitness for a particular purpose, are limited in duration to the length of this warranty.

EXCLUSION OF DAMAGES

The liability of Kramer for any effective products is limited to the repair or replacement of the product at our option. Kramer shall not be liable for:

1. Damage to other property caused by defects in this product, damages based upon inconvenience, loss of use of the product, loss of time, commercial loss; or:
2. Any other damages, whether incidental, consequential or otherwise. Some countries may not allow limitations on how long an implied warranty lasts and/or do not allow the exclusion or limitation of incidental or consequential damages, so the above limitations and exclusions may not apply to you.

This warranty gives you specific legal rights, and you may also have other rights, which vary from place to place.

NOTE: All products returned to Kramer for service must have prior approval. This may be obtained from your dealer.

This equipment has been tested to determine compliance with the requirements of:

| | |
|-----------|---|
| EN-50081: | "Electromagnetic compatibility (EMC); generic emission standard. Part 1: Residential, commercial and light industry" |
| EN-50082: | "Electromagnetic compatibility (EMC) generic immunity standard. Part 1: Residential, commercial and light industry environment". |
| CFR-47: | FCC Rules and Regulations: Part 15: "Radio frequency devices Subpart B Unintentional radiators" |

CAUTION!

- Servicing the machines can only be done by an authorized Kramer technician. Any user who makes changes or modifications to the unit without the expressed approval of the manufacturer will void user authority to operate the equipment.
- Use the supplied DC power supply to feed power to the machine.
- Please use recommended interconnection cables to connect the machine to other components.



For the latest information on our products and a list of Kramer distributors, visit our Web site: www.kramerelectronics.com, where updates to this user manual may be found. We welcome your questions, comments and feedback.



Caution

Safety Warning:

Disconnect the unit from the power supply before opening/servicing.



Kramer Electronics, Ltd.

Web site: www.kramerelectronics.com

E-mail: info@kramereel.com

P/N: 2900-000195 REV 2