

Quick Setup

IMPORTANT: Before using this product, make sure you read these instructions and the safety instructions in the online *User's Guide*.

Choose a location

Keep the projector level and place it at a height so its lens is even with the top or bottom of the screen and is centered horizontally. If this isn't possible, use the lens shift feature or the keystone correction button on the projector to reposition the image (see "Adjust the image").

In order to view 3D images correctly, RF 3D glasses must be worn within 32 feet (10 m) of the projector. Use the image below to determine the viewing distance for 3D projection (the shading represents the 3D viewing area):

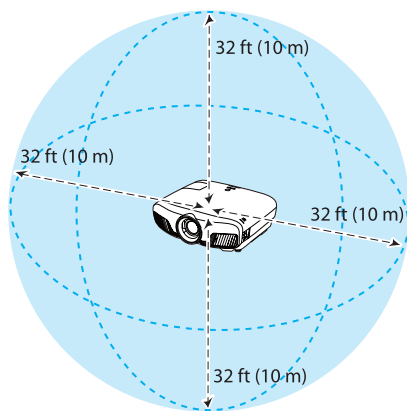

See the online *User's Guide* for more information on where to place your projector.

Connect the projector

Connect multiple video devices and use the Source buttons on the remote control or the  button on the projector to switch between them. For additional connection types, see the online *User's Guide*.

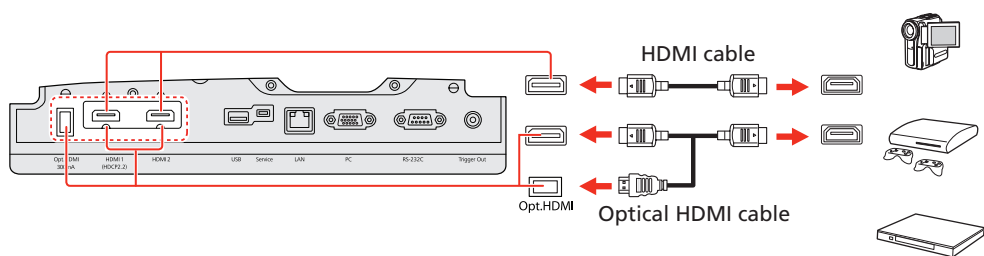



Note: When connecting a source that requires HDCP 2.2, you must use the HDMI1 port.

Turn on your equipment

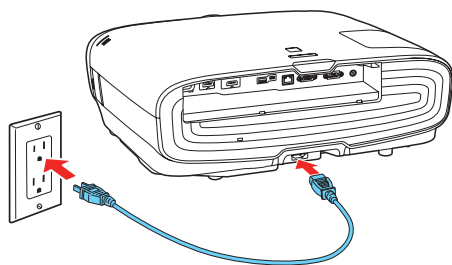
- 1 Turn on your video source.
- 2 Plug in the projector.



- 3 Press the  power button on the projector or the **On** button on the remote control. The shutter opens and the  power light flashes blue, then stays on.

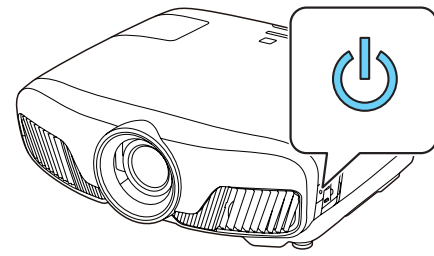

Note: To shut down the projector, press the  power button on the projector or the **Standby** button on the remote control, then press the button again to confirm, if necessary. Wait for cooldown to complete before unplugging the projector.

- 4 Use the arrow buttons on the remote control to highlight any of the options on the Home screen that appears, then press **Enter** to select it. You can display a QR code, switch between projection sources, and quickly access various adjustment options from this screen.

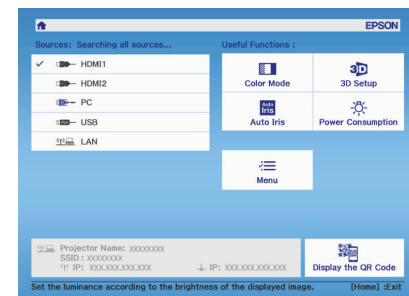

- 5 The default language of the menu system is English. To select another language, press the **Menu** button on the projector or remote control. Select **Extended** and press **Enter**. Select **Language** and press **Enter**. Select your language and press **Enter**. Press the **Menu** button to exit the menu system.

Using the remote control

Install the batteries as shown (two AA batteries).

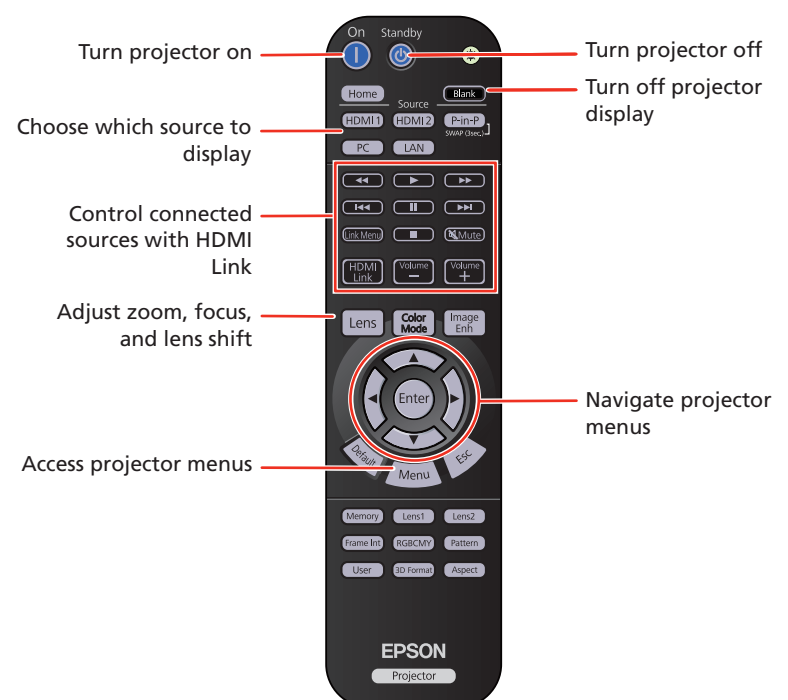
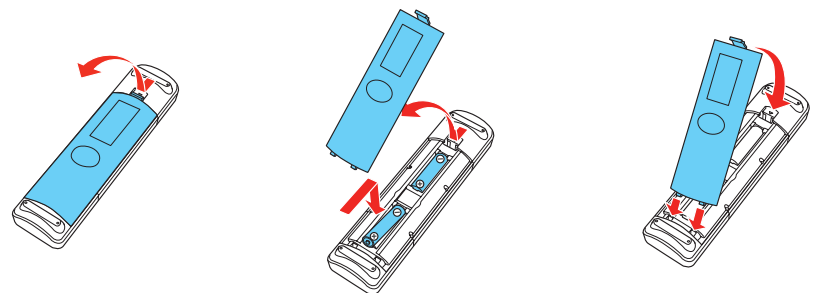

For more information on using the remote control, see the online *User's Guide*.



Adjust the image

- 1 Press the **Pattern** button on the remote control to display a test pattern.

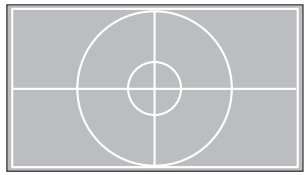

- 2 To raise the image or correct a tilted image, adjust the front feet as shown below.

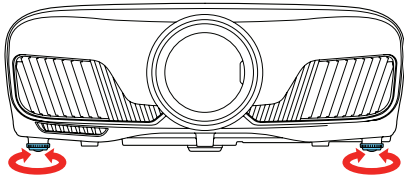

- 3 Press the **Lens** button on the remote control and use the ◀ and ▶ buttons to focus the image.

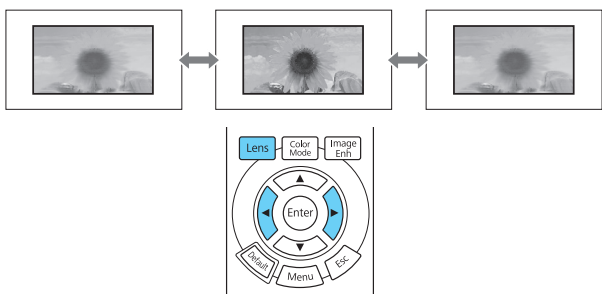

- 4 Press the **Lens** button on the remote control again and use the ◀ and ▶ buttons to reduce or enlarge the image.

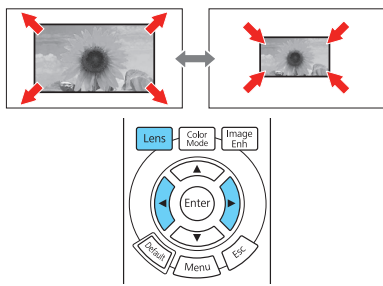

- 5 Press the **Lens** button on the remote control again and use the ▲, ▼, ◀, and ▶ buttons to reposition the image.

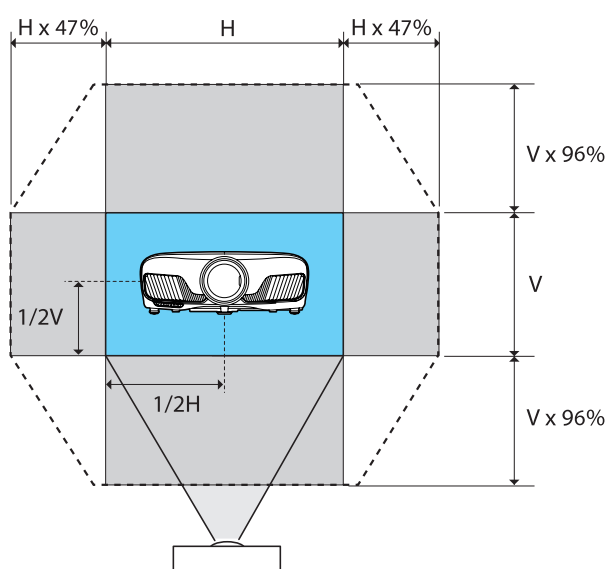

- 6 If your image looks like or , you can use the ◀ buttons on the projector to correct this.

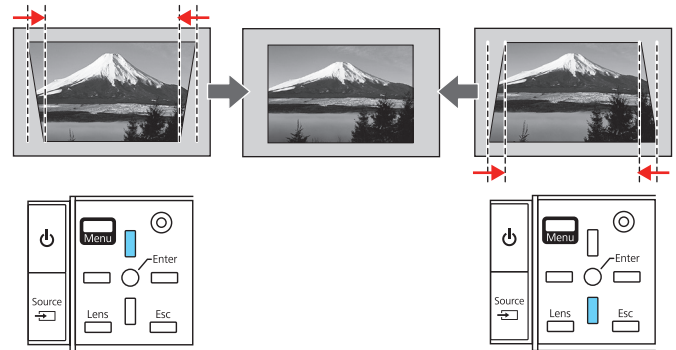

Note: Using the keystone adjustment can affect the size and effective resolution of your image. If possible, change the position of your projector to eliminate the keystone effect and use the lens shift option to position the image as necessary.

- 7 Press **Esc** to exit.

Viewing 3D images

To view 3D content, you must first connect a 3D-compatible video device to one of the HDMI ports on your projector. You also need a pair of Epson® (part number V12H548006) or Epson-compatible RF 3D active shutter glasses.

- 1 Turn on and begin playback on the 3D-compatible video device.

Note: Make sure you set the video device to play content in 3D mode.

- 2 Slide the power switch on your 3D glasses to the **On** position.

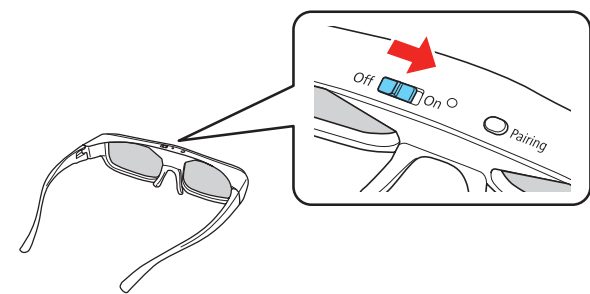

Note: If the glasses don't automatically display 3D content, you may need to pair them with the projector. Move the glasses within 10 feet (3 m) of the projector, then press and hold the **Pairing** button on the 3D glasses for at least 3 seconds. The status light on the glasses will alternately flash green and red, then remain green for 10 seconds if pairing is successful.

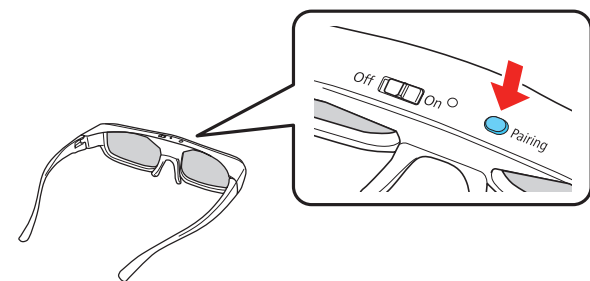



You can also automatically convert 2D 1080p HDMI content to 3D. To enable the 2D-to-3D Conversion option, press the **Menu** button on the projector or remote control. Select **Signal** and press **Enter**, then select **3D Setup** and press **Enter**. Select **2D-to-3D Conversion** and press **Enter**. Select the **Weak**, **Medium**, or **Strong** setting, then press **Enter**.

See the online *User's Guide* for more information on adjusting 3D images.

Troubleshooting

If you see a blank screen or the **No signal** message after turning on your video device or computer, check the following:

- Make sure the  power light on the projector is blue and not flashing.
- Press the  button on the projector or one of the Source buttons on the remote control to switch to the correct image source, if necessary.
- On some Windows® laptops, you may need to hold down the **Fn** key and press **F7** or the function key that lets you display on an external monitor. It may be labeled **CRT/LCD** or have an icon such as .

On Windows 7 or later, hold down the Windows key and press **P** at the same time, then click **Duplicate**.

- If you're using a Mac laptop, open **System Preferences** and select **Displays**. Click the **Arrangement** tab and select the **Mirror Displays** checkbox.

If 3D images aren't displaying properly, check the following:

- Press the **Menu** button, then select **Signal > 3D Setup > 3D Display** and make sure that the **3D** option is selected.
- Make sure that you are within the 3D viewing range. See "Choose a location" on the front of this sheet or the online *User's Guide* for more information.
- Check that your 3D glasses have not entered standby mode. Slide the power switch on the 3D glasses to the **Off** position, then back to the **On** position.
- Check that your video device and media are both 3D-compatible. Refer to the documentation that came with your video device for more information.
- Make sure you are not using a 4K source. The 2D-to-3D Conversion feature is not compatible with a 4K signal.

Where to get help

Manuals

For more information about using the projector, you can view or download the online manuals from the Epson website, as described below.

Telephone support services

To use the Epson PrivateLine® Support service, call (800) 637-7661. This service is available for the duration of your warranty period. You may also speak with a support specialist by calling (562) 276-4394 (U.S.) or (905) 709-3839 (Canada).

Support hours are 6 AM to 8 PM, Pacific Time, Monday through Friday, and 7 AM to 4 PM, Pacific Time, Saturday. Days and hours of support are subject to change without notice. Toll or long distance charges may apply.

Internet support

Visit www.epson.com/support/pc4050 (U.S.) or www.epson.ca/support/pc4050 (Canada) for solutions to common problems. You can download utilities and documentation, get FAQs and troubleshooting advice, or e-mail Epson.

Registration

Register today to get product updates and exclusive offers. You can register online at www.epson.com/webreg.

Optional accessories

For a list of optional accessories, see the online *User's Guide*.

You can purchase RF 3D glasses (part number V12H548006) or other accessories from an Epson authorized reseller. To find the nearest reseller, call 800-GO-EPSON (800-463-7766). Or you can purchase online at www.epsonstore.com (U.S. sales) or www.epsonstore.ca (Canadian sales).

Notices

Bluetooth Safety and Specifications

Contains Bluetooth® module model: DBUB-E207

This document provides safety instructions and describes the specifications. Read this document carefully before use to ensure your safety and product performance.

Data transmission is always initiated by software, which is then passed down through the MAC, through the digital and analog baseband, and finally to the RF chip. Several special packets are initiated by the MAC. These are the only ways the digital baseband portion will turn on the RF transmitter, which it then turns off at the end of the packet. Therefore, the transmitter will be on only while one of the aforementioned packets is being transmitted. In other words, this device automatically discontinues transmission in case of either absence of information to transmit or operational failure.

This equipment is restricted to indoor operation only.

U.S. FCC Notices

Contains FCC ID: BKMAE-E207

This device complies with Part 15 of the FCC Rules. Operation is subject to the following two conditions: (1) This device may not cause harmful interference, and (2) this device must accept any interference received, including interference that may cause undesired operation.

This equipment has been tested and found to comply with the limits for a Class B digital device, pursuant to Part 15 of the FCC Rules. These limits are designed to provide reasonable protection against harmful interference in a residential installation. This equipment generates, uses and can radiate radio frequency energy and, if not installed and used in accordance with the instructions, may cause harmful interference to radio communications. However, there is no guarantee that interference will not occur in a particular installation. If this equipment does cause harmful interference to radio or television reception, which can be determined by turning the equipment off and on, the user is encouraged to try to correct the interference by one of the following measures:

- Reorient or relocate the receiving antenna.
- Increase the separation between the equipment and receiver.
- Connect the equipment into an outlet on a circuit different from that to which the receiver is connected.
- Consult the dealer or an experienced radio/TV technician for help.

Caution: Changes or modifications not expressly approved by the party responsible for compliance could void the user's authority to operate this equipment. Properly shielded and grounded cables and connectors must be used for connection to host computers and / or peripherals in order to meet FCC emission limits.

This transmitter must not be co-located or operating in conjunction with any other antenna or transmitter.

This equipment complies with FCC radiation exposure limits set forth for an uncontrolled environment and meets the FCC radio frequency (RF) Exposure Guidelines. This equipment should be installed and operated with minimum distance 7.9 inches (20 cm) between the radiator and your body.

Industry Canada (IC) Notices

Contains IC: 1052D-E207

This device complies with Industry Canada license-exempt RSS standards. Operation is subject to the following two conditions: (1) This device may not cause harmful interference, and (2) this device must accept any interference received, including interference that may cause undesired operation.

CAN ICES-3(B) / NMB-3(B)

This equipment complies with IC RSS-102 radiation exposure limits set forth for an uncontrolled environment and meets RSS-102 of the IC radio frequency (RF) Exposure rules. This equipment should be installed and operated with minimum distance 20 cm (7.9 inches) between the radiator and your body.

Declaration of Conformity

According to 47CFR, Part 2 and 15, Class B Personal Computers and Peripherals; and/or CPU Boards and Power Supplies used with Class B Personal Computers.

We: Epson America, Inc.
Located at: 3840 Kilroy Airport Way
MS: 3-13
Long Beach, CA 90806
Telephone: (562) 981-3840

Declare under sole responsibility that the product identified herein, complies with 47CFR Part 2 and 15 of the FCC rules as a Class B digital device. Each product marketed, is identical to the representative unit tested and found to be compliant with the standards. Records maintained continue to reflect the equipment being produced can be expected to be within the variation accepted, due to quantity production and testing on a statistical basis as required by 47CFR 2.909. Operation is subject to the following two conditions: (1) this device may not cause harmful interference, and (2) this device must accept any interference received, including interference that may cause undesired operation.

Trade Name: Epson
Type of Product: LCD Projector
Model: H932A
Marketing Name: Pro Cinema 4050

Epson America, Inc. Limited Warranty

3 Year Projector Limited Warranty and 90 Day Lamp Limited Warranty Terms and Conditions

A. What Is Covered: Epson America, Inc. ("Epson") warrants to the original retail purchaser of the Epson projector product enclosed with this limited warranty statement that the product, if purchased new and operated in the United States, Canada, or Puerto Rico, will conform to the manufacturer's specifications and will be free from defects in workmanship and materials for a period of three (3) years from the date of original purchase. This limited warranty applies only to the projector and not to the projector lamp, which carries a limited warranty period of ninety (90) days from the date of original purchase. This warranty is not transferable.

B. What Epson Will Do To Correct Problems: Should your product prove defective during the limited warranty period, please call Epson at the number on the bottom of this limited warranty. This line will be answered during Epson's regular support hours (currently 6:00 AM to 8:00 PM Pacific Time, Monday through Friday, and 7:00 AM to 4:00 PM on Saturdays - subject to change). When you call, please be prepared to provide the service technician with proof of purchase information including the unit serial number and original date of purchase. You may also need to provide proof of purchase if warranty coverage cannot be verified by the serial number. If Epson confirms warranty service is required, Epson will, at its option, repair or replace the defective unit, without charge for parts or labor. If Epson authorizes an exchange for the defective unit, Epson will ship a replacement product to you, freight prepaid, so long as you use an address in the United States, Canada, or Puerto Rico. You are responsible for securely packaging the defective unit and returning it to Epson within five working days of receipt of the replacement. Epson requires a debit or a credit card number to secure the cost of the replacement product in the event you fail to return the defective one. If Epson authorizes repair instead of exchange, Epson will direct you to send your product to Epson or its authorized service center, where the product will be repaired and sent back to you. You are responsible for packing the product and for all postage or shipping costs to and from the Epson authorized service center. When warranty service involves the exchange of the product or of a part, the item replaced becomes Epson property. The exchanged product or part may be new or refurbished to the Epson standard of quality. If service cannot be provided on the product for any reason and Epson no longer sells the same model, Epson will replace your product with a model of equal or superior value. Replacement products or parts assume the remaining warranty period of the original product.

C. What This Warranty Does Not Cover:

1. Any damage caused by misuse, abuse, improper installation, neglect, improper packing or shipping; disasters such as fire, flood, or lightning, improper electrical currents, software problems, or interaction with non-Epson products
2. Any damage caused by, or any service for, third-party software, applications, parts, components, or peripheral devices added to the product after its shipment from Epson, such as, dealer or user-added boards, components, or cables
3. Any damage caused by installing the product next to a heat source, or directly in the path of an air vent, or an air conditioner
4. Damage due to excessive, continual usage
5. Damage caused by failure to properly maintain the projector (see your online *User's Guide* for details)
6. Service when the projector is used outside the U.S., Canada, or Puerto Rico
7. Service if the product label, logo, rating label, or serial number has been removed
8. Loss of data
9. Installation or removal
10. Any damage from service performed by other than an Epson Authorized Servicer
11. Damage resulting from operation in areas with smoke, high humidity, dust, or excessive vibration
12. Cosmetic damage caused by handling or normal wear and tear during usage
13. Any product or parts purchased as used, refurbished, or reconditioned
14. Any damage caused by using improper packaging materials or improper packaging and shipping when returning a product for repair or replacement. You will be invoiced for such shipping damage to product

This warranty is not transferable. Epson is not responsible for your data or applications, which cannot be restored and should be backed up by you. Postage, insurance, or shipping costs incurred in presenting your Epson product for carry-in warranty service are your responsibility. If a claimed defect cannot be identified or reproduced in service, you will be held responsible for costs incurred.

D. DISCLAIMER OF WARRANTIES: EPSON'S SOLE AND EXCLUSIVE LIABILITY AND YOUR EXCLUSIVE REMEDY FOR BREACH OF WARRANTY SHALL BE LIMITED TO EITHER, AT EPSON'S OPTION, REPAIR OR REPLACEMENT AS SET FORTH ABOVE. THE WARRANTY AND REMEDY PROVIDED ARE EXCLUSIVE AND IN LIEU OF ALL OTHER EXPRESSED OR IMPLIED WARRANTIES INCLUDING, BUT NOT LIMITED TO, THE IMPLIED WARRANTIES OF MERCHANTABILITY, FITNESS FOR A PARTICULAR PURPOSE AND NON-INFRINGEMENT. SOME LAWS DO NOT ALLOW THE EXCLUSION OF IMPLIED WARRANTIES. IF THESE LAWS APPLY, THEN ALL EXPRESS AND IMPLIED WARRANTIES ARE LIMITED TO THE WARRANTY PERIOD IDENTIFIED ABOVE. UNLESS STATED HEREIN, ANY STATEMENTS OR REPRESENTATION MADE BY ANY OTHER PERSON OR FIRM ARE VOID. SOME STATES DO NOT ALLOW LIMITATIONS ON HOW LONG IMPLIED WARRANTIES LAST, SO THE ABOVE LIMITATIONS MAY NOT APPLY TO YOU.

E. EXCLUSION OF DAMAGES; EPSON'S MAXIMUM LIABILITY: IN NO EVENT SHALL EPSON OR ITS AFFILIATES BE LIABLE FOR ANY SPECIAL, INCIDENTAL, OR CONSEQUENTIAL DAMAGES OR ANY LOST PROFITS, COST OF SUBSTITUTE EQUIPMENT, DOWNTIME, CLAIMS OF THIRD PARTIES, INCLUDING CUSTOMERS, OR INJURY TO PROPERTY, RESULTING FROM THE USE OR INABILITY TO USE THE EPSON PRODUCT, WHETHER RESULTING FROM BREACH OF WARRANTY OR ANY OTHER LEGAL THEORY. IN NO EVENT SHALL EPSON OR ITS AFFILIATES BE LIABLE FOR DAMAGES OF ANY KIND IN EXCESS OF THE ORIGINAL RETAIL PURCHASE PRICE OF THE PRODUCT. SOME STATES DO NOT ALLOW EXCLUSION OR LIMITATION OF INCIDENTAL OR CONSEQUENTIAL DAMAGES, SO THE ABOVE LIMITATIONS MAY NOT APPLY TO YOU.

F. Disputes, Arbitration, Governing Laws:

1. Both you and Epson agree that any controversy or claim arising out of or relating to Epson products or services or this agreement, shall be resolved by arbitration on an individual, non-class, non-representative basis, rather than in court. The arbitration shall be governed by the rules of JAMS that are in effect when the arbitration is filed, excluding any rules that permit arbitration on a class or representative basis and under the rules set forth in this agreement. The arbitrator, and not any federal, state, or local court or agency shall have the exclusive authority to resolve any dispute relating to the interpretation, applicability, enforceability, or formation, including but not limited to, any claim that all or any part is void or voidable. JAMS rules are available at <http://www.jamsadr.com> or by calling 1-800-352-5267. Disputes shall be resolved by a single neutral arbitrator, and both parties shall have a reasonable opportunity to participate in the selection of the arbitrator. If you wish, you may appear at the arbitration by phone. The arbitrator is bound by the terms of this agreement.
2. **Pre-Arbitration Steps and Notice.** Before submitting a claim for arbitration, you agree to try, for sixty (60) days, to resolve any dispute informally by contacting us at customer.inquires@ea.epson.com. Please include your name, address and contact information, the facts giving rise to the dispute, and the relief requested. You agree to act in good faith to resolve the dispute, but if you and Epson do not reach a resolution within the sixty (60) days, you may commence an arbitration.
3. **Opt-out.** You may elect to opt-out (exclude yourself) from the final, binding, individual arbitration procedure and waiver of class and representative proceedings specified in this agreement by sending a written letter to Epson America, Inc., ATTN: Legal Department, 3840 Kilroy Airport Way, Long Beach, CA 90806, within thirty (30) days of your purchase of the Epson products and/or services that specifies (i) your name, (ii) your mailing address, and (iii) your request to be excluded from the final, binding individual arbitration procedure and waiver of class and representative proceedings specified in this Section F. In the event that you opt-out consistent with the procedure set forth above, all other terms shall continue to apply, including the requirement to provide notice prior to litigation.
4. There is no judge or jury in arbitration and your grounds for appeal are limited, however, the arbitrator is empowered to grant relief and award you the same damages as a court could, including declaratory or injunctive relief. Judgment on the arbitration may be entered in any court having jurisdiction.
5. Notwithstanding the foregoing, you may bring an individual action in a small claims court of your state or municipality if the action is within that court's jurisdiction and is pending only in that court.
6. Notwithstanding the foregoing, we also both agree that you or we may bring suit in court to enjoin infringement or other misuse of trademark, patent infringement, copyright, or trade secret.
7. Any action must be brought within one (1) year of the expiration of the warranty.
8. If any provision in this Section F is found to be unenforceable, that provision shall be severed with the remainder of this agreement remaining in full force and effect. The foregoing shall not apply to the prohibition against class or representative actions. This means that if Section 9 (below) is found to be unenforceable, the entire Section 9 (but only Section 9) shall be null and void.
9. **We each agree that any dispute resolution proceedings will be conducted only on an individual basis and not in a class, consolidated or representative action.**
10. This Section F is governed by the Federal Arbitration Act.

G. Other Provisions:

1. **Other Rights You May Have:** This warranty gives you specific legal rights, and you may also have other rights which vary from jurisdiction to jurisdiction. Some jurisdictions do not allow limitations on how long an implied warranty lasts, or allow the exclusion or limitation of incidental or consequential damages, so the above limitations or exclusions may not apply to you.
2. **Warranties in Canada:** In Canada, warranties include both warranties and conditions.
3. **Governing Law:** Except for any claims subject to arbitration pursuant to Section F, you and Epson agree that the law of the state where you reside shall govern.
4. **Venue:** Except for claims subject to arbitration pursuant to Section F, in the event of a dispute you and Epson both consent to the jurisdiction of your state of residence or, if none, then of the courts in Los Angeles County, California.

To find the Epson Authorized Reseller nearest you, please visit: www.epson.com in the U.S. or www.epson.ca in Canada.

To find the Epson Customer Care Center nearest you, please visit www.epson.com/servicecenterlocator in the U.S. or www.epson.ca/servicecenterlocator in Canada.

To contact the Epson ConnectionSM, please call (800) 637-7661 or (562) 276-4394 in the U.S. and (905) 709-3839 in Canada or write to Epson America, Inc., P.O. Box 93012, Long Beach, CA 90809-3012.

EPSON
EXCEED YOUR VISION



EPSON is a registered trademark and EPSON Exceed Your Vision is a registered logomark of Seiko Epson Corporation. PrivateLine is a registered trademark and Epson Connection is a service mark of Epson America, Inc.

Mac is a trademark of Apple Inc., registered in the US and other countries.

Windows is a registered trademark of Microsoft Corporation in the United States and/or other countries.

General Notice: Other product names used herein are for identification purposes only and may be trademarks of their respective owners. Epson disclaims any and all rights in those marks.

This information is subject to change without notice.

© 2018 Epson America, Inc., 5/18

CPD-55712