



C-MAP CHART LEGEND

(Icons/Symbols/Objects sorted by Category – click the below links to access more info)

AREAS, LIMITS

[Anchorage area](#)

[Anchor berth](#)

[Military practice area](#)

[Restricted area](#)

SPORT FISHING

[Underwater structure](#)

MAN-MADE AND CULTURAL FEATURES

[Building](#)

NAVIGATION AIDS

[Beacon](#)

[Buoy](#)

[Daymark and Topmark](#)

[Fog signal](#)

[Lights](#)

[Light float and Light vessel](#)

[Notice mark](#)

[Radar reflector](#)

[Radar station, Radio station and Radar transponder beacon](#)

PORTS, INFRASTRUCTURES

[Bunker station](#)

[Mooring facility](#)

[Pile](#)

[Terminal](#)

OFFSHORE INSTALLATIONS, SUBMARINE CABLES AND PIPELINES

[Cable area](#)

[Cable, overhead](#)

[Cable, submarine](#)

[Pipeline area](#)

[Pipeline, overhead](#)

[Pipeline, submarine/on land](#)

SERVICE AND HARBOR FACILITIES

[Harbour facility](#)

[Port/Marina](#)

[Signal station traffic and signal station warning](#)

[Small craft facility](#)

TOPOGRAPHY, RELIEF, NATURAL FEATURES

[Land region](#)

[Vegetation](#)

LANDMARKS

[Landmark](#)

BOTTOM COMPOSITION

[Nature of seabed](#)

[Seabed area](#)

[Weed/Kelp](#)











ROCK, WRECKS, OBSTRUCTIONS

[Obstruction](#)











[Underwater/awash rock](#)

[Wrecks](#)







































Anchorage area







































Symbol (day)	Symbol (night)	Symbol description
		Anchorage area (on small scale charts)
<p>Small craft anchorage</p> 	<p>Small craft anchorage</p> 	Small craft anchorage
<p>Small craft moorings</p> 	<p>Small craft moorings</p> 	Small craft mooring area
<p>Anchorage area</p> 	<p>Anchorage area</p> 	Anchorage area
<p>Anchorage area Bravo Zone</p> 	<p>Anchorage area Bravo Zone</p> 	Anchorage area (with name)







































Anchor berth



































Symbol (day)	Symbol (night)	Symbol description
		Anchor berth (on small scale charts)
 	 	Anchor berth
 	 	Anchor berth (with name/number) (the indicated number is an example)





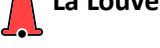
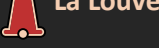



Beacon

Symbol (day)	Symbol (night)	Symbol description
		Stake, post, perch, post, withy
		Withy (port)
		Withy (starboard)
		Beacon tower, white
		Beacon tower, black
		Beacon tower, red
		Beacon tower, green
		Beacon tower, yellow
		Beacon tower, grey
		Beacon tower, orange
		Beacon tower, white/black (horizontal stripes)
		Beacon tower, black/white (horizontal stripes)
		Beacon tower, white/red (horizontal stripes)
		Beacon tower, red/white (horizontal stripes)
		Beacon tower, white/green (horizontal stripes)
		Beacon tower, green/white (horizontal stripes)
		Beacon tower, white/orange (horizontal stripes)
		Beacon tower, orange/white (horizontal stripes)
		Beacon tower, white/red/white (horizontal stripes)

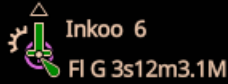
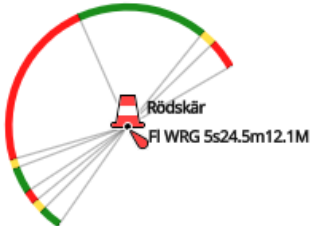
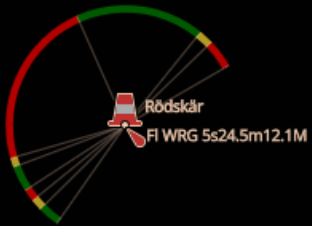
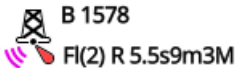
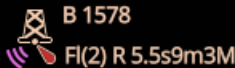



































Symbol (day)	Symbol (night)	Symbol description
		Beacon tower, red/white/red (horizontal stripes)
		Beacon tower, white/green/white (horizontal stripes)
		Beacon tower, green/white/green (horizontal stripes)
		Beacon tower, black/yellow (horizontal stripes)
		Beacon tower, yellow/black (horizontal stripes)
		Beacon tower, black/yellow/black (horizontal stripes)
		Beacon tower, yellow/black/yellow (horizontal stripes)
		Beacon tower, red/green (horizontal stripes)
		Beacon tower, green/red (horizontal stripes)
		Beacon tower, red/green/red (horizontal stripes)
		Beacon tower, green/red/green (horizontal stripes)
		Beacon tower, black/red/black (horizontal stripes)
		Beacon tower, white/red (vertical stripes)
		Beacon tower, red/white (vertical stripes)
		Beacon tower
		Lattice beacon
		Beacon, white
		Beacon, black
		Beacon, red







































Symbol (day)	Symbol (night)	Symbol description
		Beacon, green
		Beacon, yellow
		Beacon, grey
		Beacon, orange
		Beacon, white/black (horizontal stripes)
		Beacon, black/white (horizontal stripes)
		Beacon, white/red (horizontal stripes)
		Beacon, red/white (horizontal stripes)
		Beacon, white/green (horizontal stripes)
		Beacon, green/white (horizontal stripes)
		Beacon, white/orange (horizontal stripes)
		Beacon, orange/white (horizontal stripes)
		Beacon, white/red/white (horizontal stripes)
		Beacon, red/white/red (horizontal stripes)
		Beacon, white/green/white (horizontal stripes)
		Beacon, green/white/green (horizontal stripes)
		Beacon, black/yellow (horizontal stripes)
		Beacon, yellow/black (horizontal stripes)
		Beacon, black/yellow/black (horizontal stripes)







































Symbol (day)	Symbol (night)	Symbol description
		Beacon, yellow/black/yellow (horizontal stripes)
		Beacon, red/green (horizontal stripes)
		Beacon, green/red (horizontal stripes)
		Beacon, red/green/red (horizontal stripes)
		Beacon, green/red/green (horizontal stripes)
		Beacon, black/red/black (horizontal stripes)
		Beacon, white/red (vertical stripes)
		Beacon, red/white (vertical stripes)
		Beacon
		Cairn
		Beacon, black [NOAA symbol]
		Beacon, red [NOAA symbol]
		Beacon, green [NOAA symbol]
		Beacon [NOAA symbol]
 11	 11	Beacon, green, with name (the indicated number is an example)
 La Louve	 La Louve	Beacon tower, red, with name (the indicated name is an example)
 C	 C	Beacon, yellow, with name (the indicated name is an example)
 4	 4	Beacon, red, with name [NOAA symbol] (the indicated number is an example)







































Symbol (day)	Symbol (night)	Symbol description
		Beacon, black/red/black (horizontal stripes), with radar reflector
 Inkoo 6 FI G 3s12m3.1M	 Inkoo 6 FI G 3s12m3.1M	Lighted beacon, green, with topmark, radar reflector, radar transponder beacon, name, and light description
 Rödskär FI WRG 5s24.5m12.1M	 Rödskär FI WRG 5s24.5m12.1M	Beacon tower, red/white/red (horizontal stripes), with sector lights, name, and light description
 B 1578 FI(2) R 5.5s9m3M	 B 1578 FI(2) R 5.5s9m3M	Lighted lattice beacon, with fog signal, name, and light description
 Bramble Tide gauge	 Bramble Tide gauge	Lighted beacon, yellow, with signal station (tide gauge) and name
 1 FI G 2.5s5.1m3M	 1 FI G 2.5s5.1m3M	Lighted beacon, green, with topmark, radar reflector, name, and light description [NOAA symbol]
 26 FI R 4s4.8m5M	 26 FI R 4s4.8m5M	Lighted beacon, red, with topmark, name, and light description [NOAA symbol]







































Buoy

Symbol (day)	Symbol (night)	Symbol description
		Conical (nun) buoy, white
		Conical (nun) buoy, black
		Conical (nun) buoy, red
		Conical (nun) buoy, green
		Conical (nun) buoy, yellow
		Conical (nun) buoy, grey
		Conical (nun) buoy, orange
		Conical (nun) buoy, white/black (horizontal stripes)
		Conical (nun) buoy, black/white (horizontal stripes)
		Conical (nun) buoy, white/red (horizontal stripes)
		Conical (nun) buoy, red/white (horizontal stripes)
		Conical (nun) buoy, white/green (horizontal stripes)
		Conical (nun) buoy, green/white (horizontal stripes)
		Conical (nun) buoy, white/orange (horizontal stripes)
		Conical (nun) buoy, orange/white (horizontal stripes)
		Conical (nun) buoy, white/red/white (horizontal stripes)
		Conical (nun) buoy, red/white/red (horizontal stripes)
		Conical (nun) buoy, white/green/white (horizontal stripes)































Symbol (day)	Symbol (night)	Symbol description
		Conical (nun) buoy, green/white/green (horizontal stripes)
		Conical (nun) buoy, black/yellow (horizontal stripes)
		Conical (nun) buoy, yellow/black (horizontal stripes)
		Conical (nun) buoy, black/yellow/black (horizontal stripes)
		Conical (nun) buoy, yellow/black/yellow (horizontal stripes)
		Conical (nun) buoy, red/green (horizontal stripes)
		Conical (nun) buoy, green/red (horizontal stripes)
		Conical (nun) buoy, red/green/red (horizontal stripes)
		Conical (nun) buoy, green/red/green (horizontal stripes)
		Conical (nun) buoy, black/red/black (horizontal stripes)
		Conical (nun) buoy, white/red (vertical stripes)
		Conical (nun) buoy, red/white (vertical stripes)
		Conical (nun) buoy, blue/yellow (vertical stripes)
		Conical (nun) buoy
		Cylindrical (can) buoy, white
		Cylindrical (can) buoy, black
		Cylindrical (can) buoy, red
		Cylindrical (can) buoy, green
		Cylindrical (can) buoy, yellow



































Symbol (day)	Symbol (night)	Symbol description
		Cylindrical (can) buoy, grey
		Cylindrical (can) buoy, orange
		Cylindrical (can) buoy, white/black (horizontal stripes)
		Cylindrical (can) buoy, black/white (horizontal stripes)
		Cylindrical (can) buoy, white/red (horizontal stripes)
		Cylindrical (can) buoy, red/white (horizontal stripes)
		Cylindrical (can) buoy, white/green (horizontal stripes)
		Cylindrical (can) buoy, green/white (horizontal stripes)
		Cylindrical (can) buoy, white/orange (horizontal stripes)
		Cylindrical (can) buoy, orange/white (horizontal stripes)
		Cylindrical (can) buoy, white/red/white (horizontal stripes)
		Cylindrical (can) buoy, red/white/red (horizontal stripes)
		Cylindrical (can) buoy, white/green/white (horizontal stripes)
		Cylindrical (can) buoy, green/white/green (horizontal stripes)
		Cylindrical (can) buoy, black/yellow (horizontal stripes)
		Cylindrical (can) buoy, yellow/black (horizontal stripes)
		Cylindrical (can) buoy, black/yellow/black (horizontal stripes)
		Cylindrical (can) buoy, yellow/black/yellow (horizontal stripes)
		Cylindrical (can) buoy, red/green (horizontal stripes)





































Symbol (day)	Symbol (night)	Symbol description
		Cylindrical (can) buoy, green/red (horizontal stripes)
		Cylindrical (can) buoy, red/green/red (horizontal stripes)
		Cylindrical (can) buoy, green/red/green (horizontal stripes)
		Cylindrical (can) buoy, black/red/black (horizontal stripes)
		Cylindrical (can) buoy, white/red (vertical stripes)
		Cylindrical (can) buoy, red/white (vertical stripes)
		Cylindrical (can) buoy, blue/yellow (vertical stripes)
		Cylindrical (can) buoy
		Spherical buoy, white
		Spherical buoy, black
		Spherical buoy, red
		Spherical buoy, green
		Spherical buoy, yellow
		Spherical buoy, grey
		Spherical buoy, orange
		Spherical buoy, white/black (horizontal stripes)
		Spherical buoy, black/white (horizontal stripes)
		Spherical buoy, white/red (horizontal stripes)
		Spherical buoy, red/white (horizontal stripes)





































Symbol (day)	Symbol (night)	Symbol description
		Spherical buoy, white/green (horizontal stripes)
		Spherical buoy, green/white (horizontal stripes)
		Spherical buoy, white/orange (horizontal stripes)
		Spherical buoy, orange/white (horizontal stripes)
		Spherical buoy, white/red/white (horizontal stripes)
		Spherical buoy, red/white/red (horizontal stripes)
		Spherical buoy, white/green/white (horizontal stripes)
		Spherical buoy, green/white/green (horizontal stripes)
		Spherical buoy, black/yellow (horizontal stripes)
		Spherical buoy, yellow/black (horizontal stripes)
		Spherical buoy, black/yellow/black (horizontal stripes)
		Spherical buoy, yellow/black/yellow (horizontal stripes)
		Spherical buoy, red/green (horizontal stripes)
		Spherical buoy, green/red (horizontal stripes)
		Spherical buoy, red/green/red (horizontal stripes)
		Spherical buoy, green/red/green (horizontal stripes)
		Spherical buoy, black/red/black (horizontal stripes)
		Spherical buoy, white/red (vertical stripes)
		Spherical buoy, red/white (vertical stripes)





































Symbol (day)	Symbol (night)	Symbol description
		Spherical buoy, blue/yellow (vertical stripes)
		Spherical buoy
		Pillar buoy, white
		Pillar buoy, black
		Pillar buoy, red
		Pillar buoy, green
		Pillar buoy, yellow
		Pillar buoy, grey
		Pillar buoy, orange
		Pillar buoy, white/black (horizontal stripes)
		Pillar buoy, black/white (horizontal stripes)
		Pillar buoy, white/red (horizontal stripes)
		Pillar buoy, red/white (horizontal stripes)
		Pillar buoy, white/green (horizontal stripes)
		Pillar buoy, green/white (horizontal stripes)
		Pillar buoy, white/orange (horizontal stripes)
		Pillar buoy, orange/white (horizontal stripes)
		Pillar buoy, white/red/white (horizontal stripes)
		Pillar buoy, red/white/red (horizontal stripes)



































Symbol (day)	Symbol (night)	Symbol description
		Pillar buoy, white/green/white (horizontal stripes)
		Pillar buoy, green/white/green (horizontal stripes)
		Pillar buoy, black/yellow (horizontal stripes)
		Pillar buoy, yellow/black (horizontal stripes)
		Pillar buoy, black/yellow/black (horizontal stripes)
		Pillar buoy, yellow/black/yellow (horizontal stripes)
		Pillar buoy, red/green (horizontal stripes)
		Pillar buoy, green/red (horizontal stripes)
		Pillar buoy, red/green/red (horizontal stripes)
		Pillar buoy, green/red/green (horizontal stripes)
		Pillar buoy, black/red/black (horizontal stripes)
		Pillar buoy, white/red (vertical stripes)
		Pillar buoy, red/white (vertical stripes)
		Pillar buoy, blue/yellow (vertical stripes)
		Pillar buoy



















Symbol (day)	Symbol (night)	Symbol (day)
		Spar (spindle) buoy, white
		Spar (spindle) buoy, black
		Spar (spindle) buoy, red
		Spar (spindle) buoy, green
		Spar (spindle) buoy, yellow
		Spar (spindle) buoy, grey
		Spar (spindle) buoy, orange
		Spar (spindle) buoy, white/black (horizontal stripes)
		Spar (spindle) buoy, black/white (horizontal stripes)
		Spar (spindle) buoy, white/red (horizontal stripes)
		Spar (spindle) buoy, red/white (horizontal stripes)
		Spar (spindle) buoy, white/green (horizontal stripes)
		Spar (spindle) buoy, green/white (horizontal stripes)
		Spar (spindle) buoy, white/orange (horizontal stripes)
		Spar (spindle) buoy, orange/white (horizontal stripes)
		Spar (spindle) buoy, white/red/white or white/red/white/red (horizontal stripes)
		Spar (spindle) buoy, red/white/red or red/white/red/white (horizontal stripes)
		Spar (spindle) buoy, white/green/white or white/green/white/green (horizontal stripes)

Symbol (day)	Symbol (night)	Symbol (day)
		Spar (spindle) buoy, green/white/green or green/white/green/white (horizontal stripes)
		Spar (spindle) buoy, black/yellow (horizontal stripes)
		Spar (spindle) buoy, yellow/black (horizontal stripes)
		Spar (spindle) buoy, black/yellow/black (horizontal stripes)
		Spar (spindle) buoy, yellow/black/yellow (horizontal stripes)
		Spar (spindle) buoy, red/green (horizontal stripes)
		Spar (spindle) buoy, green/red (horizontal stripes)
		Spar (spindle) buoy, red/green/red (horizontal stripes)
		Spar (spindle) buoy, green/red/green (horizontal stripes)
		Spar (spindle) buoy, black/red/black (horizontal stripes)
		Spar (spindle) buoy, white/red (vertical stripes)
		Spar (spindle) buoy, red/white (vertical stripes)
		Spar (spindle) buoy, blue/yellow (vertical stripes)
		Spar (spindle) buoy
		Barrel (tun) buoy, yellow
		Barrel (tun) buoy
		Super-buoy, yellow
		Super-buoy



















Symbol (day)	Symbol (night)	Symbol (day)
		Buoy, white
		Buoy, black
		Buoy, red
		Buoy, green
		Buoy, yellow
		Buoy, grey
		Buoy, orange
		Buoy, white/black (horizontal stripes)
		Buoy, black/white (horizontal stripes)
		Buoy, white/red (horizontal stripes)
		Buoy, red/white (horizontal stripes)
		Buoy, white/green (horizontal stripes)
		Buoy, green/white (horizontal stripes)
		Buoy, white/orange (horizontal stripes)
		Buoy, orange/white (horizontal stripes)
		Buoy, white/red/white (horizontal stripes)
		Buoy, red/white/red (horizontal stripes)
		Buoy, white/green/white (horizontal stripes)







Symbol (day)	Symbol (night)	Symbol (day)
		Buoy, green/white/green (horizontal stripes)
		Buoy, black/yellow (horizontal stripes)
		Buoy, yellow/black (horizontal stripes)
		Buoy, black/yellow/black (horizontal stripes)
		Buoy, yellow/black/yellow (horizontal stripes)
		Buoy, red/green (horizontal stripes)
		Buoy, green/red (horizontal stripes)
		Buoy, red/green/red (horizontal stripes)
		Buoy, green/red/green (horizontal stripes)
		Buoy, black/red/black (horizontal stripes)
		Buoy, white/red (vertical stripes)
		Buoy, red/white (vertical stripes)
		Buoy, blue/yellow (vertical stripes)
		Buoy
		Buoy, black [NOAA symbol]
		Buoy, red [NOAA symbol]
		Buoy, green [NOAA symbol]
		Buoy, yellow [NOAA symbol]

Symbol (day)	Symbol (night)	Symbol (day)
		Buoy, white/orange (horizontal stripes) [NOAA symbol]
		Buoy, orange/white (horizontal stripes) [NOAA symbol]
		Buoy, red/white/red or red/white/red/white (horizontal stripes) [NOAA symbol]
		Buoy, green/white/green or green/white/green/white (horizontal stripes) [NOAA symbol]
		Buoy, black/yellow (horizontal stripes) [NOAA symbol]
		Buoy, yellow/black (horizontal stripes) [NOAA symbol]
		Buoy, black/yellow/black (horizontal stripes) [NOAA symbol]
		Buoy, yellow/black/yellow (horizontal stripes) [NOAA symbol]
		Buoy, red/green (horizontal stripes) [NOAA symbol]
		Buoy, green/red (horizontal stripes) [NOAA symbol]
		Buoy, red/green/red (horizontal stripes) [NOAA symbol]
		Buoy, green/red/green (horizontal stripes) [NOAA symbol]
		Buoy, black/red/black (horizontal stripes) [NOAA symbol]
		Buoy, red/white (vertical stripes) [NOAA symbol]
		Buoy [NOAA symbol]
		Conical (nun) buoy, green, with name (the indicated number is an example)
		Spar (spindle) buoy, red, with name (the indicated number is an example)



















Symbol (day)	Symbol (night)	Symbol (day)
 Blanchard	 Blanchard	Pillar buoy, black/yellow/black (horizontal stripes), with name
 AA	 AA	Buoy, yellow, with name [NOAA symbol]
		Spar (spindle) buoy, red/green/red (horizontal stripes), with radar reflector
 Moorhead Fl G 5s	 Moorhead Fl G 5s	Lighted conical buoy, green, with topmark, name, and light description
 APA S Q(6)+LFl 15s	 APA S Q(6)+LFl 15s	Lighted pillar buoy, yellow/black (horizontal stripes), with topmark, radar reflector, radar transponder beacon, name, and light description
 CH Mo(A) 8s	 CH Mo(A) 8s	Lighted pillar buoy, red/white (vertical stripes), with topmark, fog signal, radar transponder beacon, name, and light description
		Buoy, red, with radar reflector and name [NOAA symbol]
 7 Fl G 4s	 7 Fl G 4s	Lighted buoy, green, with name and light description [NOAA symbol]
 SF Mo(A) 8s	 SF Mo(A) 8s	Lighted buoy, red/white (vertical stripes), with topmark, fog signal, radar transponder beacon, name, and light description [NOAA symbol]

Nature of seabed





Symbol (day)		Symbol (night)	Symbol description
			Mud, clay, silt, sand, muck
			Stones, gravel, pebbles, cobbles, rubble
			Rock, boulders, bedrock, chunk rock
			Lava
			Coral, artificial reef, reef
			Shells, clam beds, zebra mussels
			Cattails
			Deadheads, submerged trees, flooded timber piles, deadfall
			Rock slides
			Mud, clay, silt, sand, muck
			Stones, gravel, pebbles, cobbles, rubble
			Rock, boulders, bedrock, chunk rock
			Lava
			Coral, artificial reef, reef
			Shells, clam beds, zebra mussels



Symbol (day)		Symbol (night)	Symbol description
			Cattails
			Deadheads, submerged trees, flooded timber piles, deadfall
			Rock slides

Building



Symbol (day)	Symbol (night)	Symbol description
		Harbour master's office
		Custom office
		Hospital, health office
		Post office
		Church, chapel, cross
		Temple
		Mosque, minaret, marabout
		Building
		Building

Bunker station







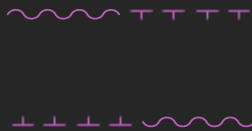

Symbol (day)	Symbol (night)	Symbol description
		Bunker station (diesel oil)
		Bunker station (water)

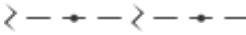
Symbol (day)	Symbol (night)	Symbol description
		Bunker station (ballast)



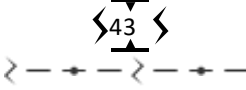



Cable area

Symbol (day)	Symbol (night)	Symbol description
		Submarine power cable area
		Submarine cable area































Cable, overhead



Symbol (day)	Symbol (night)	Symbol description
		Overhead power cable
		Overhead cable
		Overhead power cable with safe vertical clearance (the indicated number is an example)
		Overhead cable with vertical clearance (the indicated number is an example)

Cable, submarine































Symbol (day)	Symbol (night)	Symbol description
		Submarine power cable
		Mooring cable or chain
		Submarine cable

Daymark and Topmark



Symbol (day)	Symbol (night)	Symbol description
		Daymark/topmark, cone (point up) or triangle (point up), red
		Daymark/topmark, cone (point up) or triangle (point up), green
		Daymark/topmark, cone (point up) or triangle (point up), yellow
		Daymark/topmark, cone (point up) or triangle (point up)
		Daymark/topmark, cone (point down) or triangle (point down), red
		Daymark/topmark, cone (point down) or triangle (point down), green
		Daymark/topmark, cone (point down) or triangle (point down), yellow
		Daymark/topmark, cone (point down) or triangle (point down)
		Daymark/topmark, sphere or circle, red
		Daymark/topmark, sphere or circle, green
		Daymark/topmark, sphere or circle, yellow
		Daymark/topmark, sphere or circle, red/green
		Daymark/topmark, sphere or circle
		Daymark/topmark, 2 spheres, red
		Daymark/topmark, 2 spheres, green

Symbol (day)	Symbol (night)	Symbol description
		Daymark/topmark, 2 spheres, yellow
		Daymark/topmark, 2 spheres
		Daymark/topmark, cylinder/can or rectangle (vertical), red
		Daymark/topmark, cylinder/can or rectangle (vertical), green
		Daymark/topmark, cylinder/can or rectangle (vertical), yellow
		Daymark/topmark, cylinder/can or rectangle (vertical)
		Daymark/topmark, board or rectangle (horizontal), red
		Daymark/topmark, board or rectangle (horizontal), green
		Daymark/topmark, board or rectangle (horizontal), yellow
		Daymark/topmark, board or rectangle (horizontal)
		Daymark/topmark, x-shape, red
		Daymark/topmark, x-shape, green
		Daymark/topmark, x-shape, yellow
		Daymark/topmark, x-shape
		Daymark/topmark, upright cross, red
		Daymark/topmark, upright cross, green
		Daymark/topmark, upright cross, yellow
		Daymark/topmark, upright cross
		Daymark/topmark, cube (point up) or rhombus/diamond, red
		Daymark/topmark, cube (point up) or rhombus/diamond, green
		Daymark/topmark, cube (point up) or rhombus/diamond, yellow
		Daymark/topmark, cube (point up) or rhombus/diamond
		Daymark/topmark, 2 cones (point to point), red



Symbol (day)	Symbol (night)	Symbol description
		Daymark/topmark, 2 cones (point to point), green
		Daymark/topmark, 2 cones (point to point), yellow
		Daymark/topmark, 2 cones (point to point), red/green
		Daymark/topmark, 2 cones (point to point)
		Daymark/topmark, 2 cones (base to base), red
		Daymark/topmark, 2 cones (base to base), green
		Daymark/topmark, 2 cones (base to base), yellow
		Daymark/topmark, 2 cones (base to base)
		Daymark/topmark, 2 cones (points upward), red
		Daymark/topmark, 2 cones (points upward), green
		Daymark/topmark, 2 cones (points upward), yellow
		Daymark/topmark, 2 cones (points upward)
		Daymark/topmark, 2 cones (points downward), red
		Daymark/topmark, 2 cones (points downward), green
		Daymark/topmark, 2 cones (points downward), yellow
		Daymark/topmark, 2 cones (points downward)
		Daymark/topmark, besom (point up)
		Daymark/topmark, besom (point down)
		Daymark/topmark, flag, red
		Daymark/topmark, flag, green
		Daymark/topmark, flag, yellow
		Daymark/topmark, flag
		Daymark/topmark, square, red



















Symbol (day)	Symbol (night)	Symbol description
		Daymark/topmark, square, green
		Daymark/topmark, square, yellow
		Daymark/topmark, square
		Daymark/topmark, trapezium (up), red
		Daymark/topmark, trapezium (up), green
		Daymark/topmark, trapezium (up), yellow
		Daymark/topmark, trapezium (up)
		Daymark/topmark, trapezium (down), red
		Daymark/topmark, trapezium (down), green
		Daymark/topmark, trapezium (down), yellow
		Daymark/topmark, trapezium (down)
		Daymark/topmark, T-shape, red
		Daymark/topmark, T-shape, green
		Daymark/topmark, T-shape, yellow
		Daymark/topmark, T-shape











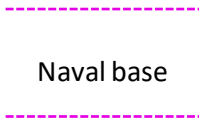
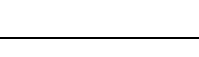
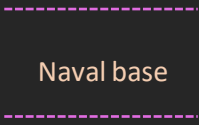
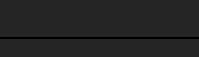
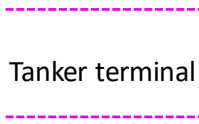
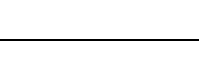
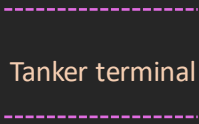
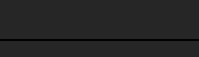

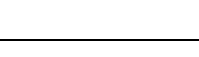
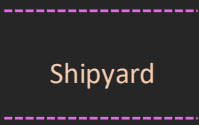
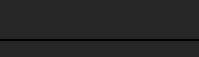
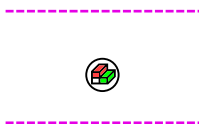

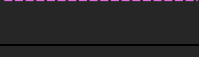

Fog signal

Symbol (day)	Symbol (night)	Symbol description
		Fog signal



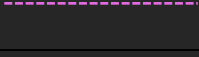

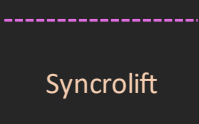
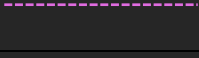
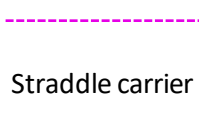

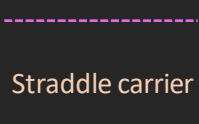
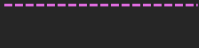
Harbour facility















Symbol (day)	Symbol (night)	Symbol description
		RoRo terminal

Symbol (day)	Symbol (night)	Symbol description
		Passenger or ferry terminal; terminal in general
		Fishing harbour
		Yacht harbour/marina
Naval base	Naval base	Naval base
Tanker terminal	Tanker terminal	Tanker terminal
Shipyards	Shipyards	Shipyards
		Container terminal
		Bulk terminal
Syncrolift	Syncrolift	Syncrolift
Straddle carrier	Straddle carrier	Straddle carrier
		RoRo terminal
		Passenger or ferry terminal; terminal in general
		Fishing harbour
		Yacht harbour/marina











Symbol (day)	Symbol (night)	Symbol description
 <p>Naval base</p> 	 <p>Naval base</p> 	Naval base
 <p>Tanker terminal</p> 	 <p>Tanker terminal</p> 	Tanker terminal
 <p>Shipyards</p> 	 <p>Shipyards</p> 	Shipyards
  	  	Container terminal
  	  	Bulk terminal
 <p>Syncrolift</p> 	 <p>Syncrolift</p> 	Syncrolift
 <p>Straddle carrier</p> 	 <p>Straddle carrier</p> 	Straddle carrier

Lights





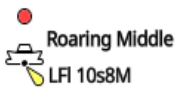

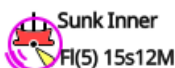
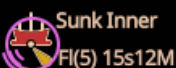
Symbol (day)	Symbol (night)	Symbol description
		Light, white or yellow
		Light, red
		Light, green







Symbol (day)	Symbol (night)	Symbol description
		Light, blue
		Light
		Floodlight, floodlighting
		Light, white or yellow [NOAA symbol]
		Light, red [NOAA symbol]
		Light, green [NOAA symbol]
		Light [NOAA symbol]

Light float and Light vessel



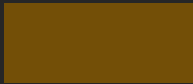

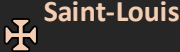



Symbol (day)	Symbol (night)	Symbol description
		Light float, red
		Light float
		Light vessel, red
		Light vessel
 <p>Roaring Middle LFI 10s8M</p>	 <p>Roaring Middle LFI 10s8M</p>	Light vessel with topmark, light, name, and light description
 <p>Sunk Inner FI(5) 15s12M</p>	 <p>Sunk Inner FI(5) 15s12M</p>	Light vessel with fog signal, light, radar transponder beacon, name, and light description

Landmark

Symbol (day)	Symbol (night)	Symbol description
		Cairn
		Cemetery
		Chimney
		Dish aerial
		Flagstaff, flagpole
		Flare stack
		Mast (television, radio, radar, microwave)
		Mast
		Monument
		Church, chapel, cross
		Dome
		Radar scanner
		Tower (television, radio, radar, microwave)
		Tower
		Windmill
		Wind motor
		Church, chapel, cross
		Mosque, minaret, marabout
		Large rock or boulder on land

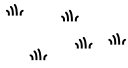



Symbol (day)	Symbol (night)	Symbol description
		Landmark
		Landmark (area)
		Church, chapel, cross (with name)
		Mast (television, radio, radar, microwave), with light [light description not shown for air obstruction lights]

Land region

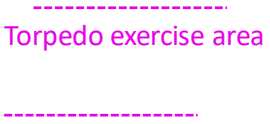
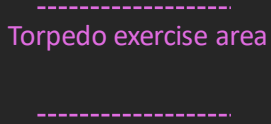
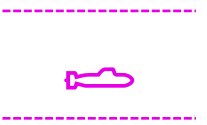
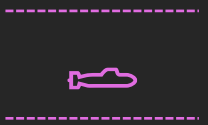



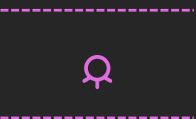

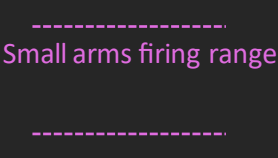
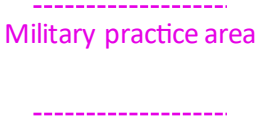
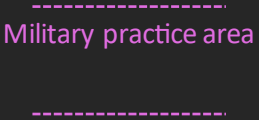





Symbol (day)	Symbol (night)	Symbol description
		Marsh
		Barrier free access
		Fen, marsh, moor, bog, swamp
		Salt pan
Upthegrove Beach	Upthegrove Beach	Land region (with name)











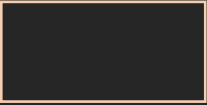



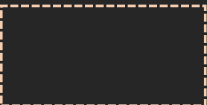











Military practice area



Symbol (day)	Symbol (night)	Symbol description
		Torpedo exercise area
		Submarine exercise area

Symbol (day)	Symbol (night)	Symbol description
		Firing danger area
		Mine-laying practice area
		Small arms firing range
		Military practice area

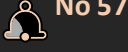





















Mooring facility

Symbol (day)	Symbol (night)	Symbol description
		Dolphin
		Deviation dolphin
		Pile, post, bollard
		Mooring facility (e.g. chain/wire), always dry or floating
		Mooring facility (e.g. chain/wire), awash or covers and uncovers
		Mooring facility (e.g. chain/wire), submerged









Symbol (day)	Symbol (night)	Symbol description
		Mooring facility, always dry or floating
		Mooring facility, awash or covers and uncovers
		Mooring facility, submerged
		Mooring buoy, blue
		Mooring buoy, blue/red/blue (horizontal stripes)
		Mooring buoy, blue/green/blue (horizontal stripes)
		Mooring buoy, blue/yellow/blue (horizontal stripes)
		Mooring buoy, blue/brown/blue (horizontal stripes)
		Mooring buoy, blue/orange/blue (horizontal stripes)
		Mooring buoy, pink
		Mooring buoy, cylindrical/can
		Mooring buoy
		Mooring buoy, with name
		Lighted dolphin

Symbol (day)	Symbol (night)	Symbol description
		Lighted mooring buoy, cylindrical/can, with topmark and light description

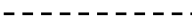

Notice mark

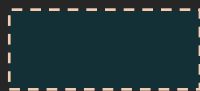
Symbol (day)	Symbol (night)	Symbol description
		Entry prohibited (inland waterways mark)
		Passing on left side prohibited (inland waterways mark)
		Passing on right side prohibited (inland waterways mark)
		Prohibition mark (inland waterways)
		Regulation or restriction mark (inland waterways)
		Recommended passage for both directions (inland waterways mark)
		Recommended passage for only one direction (inland waterways mark)
		Recommended passage on right side (inland waterways mark)
		Recommended passage on left side (inland waterways mark)
		Entry permitted (inland waterways mark)
		Recommendation or information mark (inland waterways)



Obstruction

Symbol (day)	Symbol (night)	Symbol description
		Obstruction
		Obstruction of known depth
		Obstruction (line)
		Obstruction or wreck (area)
		Obstruction of known depth (the indicated number is an example)

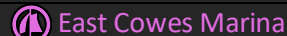

Port/Marina

Symbol (day)	Symbol (night)	Symbol description
		Yacht harbour/marina
		Yacht harbour/marina (with name)

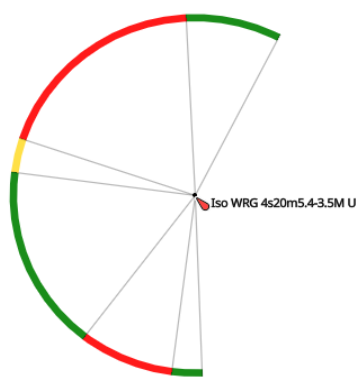
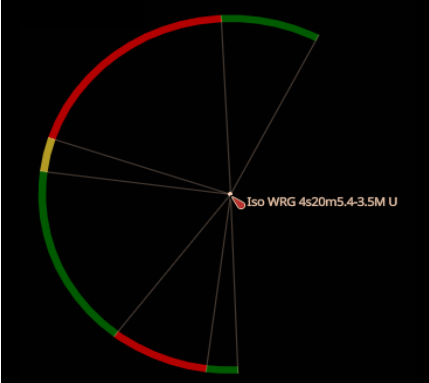

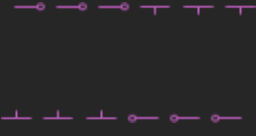

Pile

Symbol (day)	Symbol (night)	Symbol description
		Pile, post, bollard
		Pile with sector lights and light description



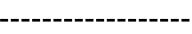

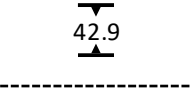
Pipeline area





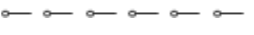



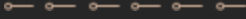

Symbol (day)	Symbol (night)	Symbol description
		Pipeline area (outfall, intake, or sewer)
		Pipeline area

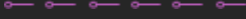
Pipeline, overhead

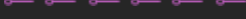

Symbol (day)	Symbol (night)	Symbol description
		Overhead pipeline
		Overhead pipeline with vertical clearance

Pipeline, submarine/on land

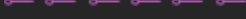

Symbol (day)	Symbol (night)	Symbol description
<p>Outfall</p> 	<p>Outfall</p> 	Submarine pipeline (outfall)
<p>Intake</p> 	<p>Intake</p> 	Submarine pipeline (intake)

Symbol (day)	Symbol (night)	Symbol description
<p>Sewer</p> 	<p>Sewer</p> 	Submarine pipeline (sewer)
<p>Oil</p> 	<p>Oil</p> 	Submarine pipeline (oil)
<p>Gas</p> 	<p>Gas</p> 	Submarine pipeline (gas)
<p>Water</p> 	<p>Water</p> 	Submarine pipeline (water)
<p>Chem</p> 	<p>Chem</p> 	Submarine pipeline (chemicals)
		Submarine pipeline







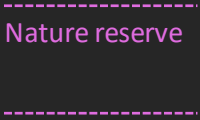
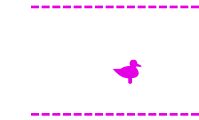

Radar reflector

Symbol (day)	Symbol (night)	Symbol description
		Radar reflector

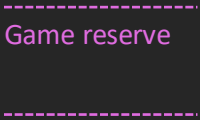

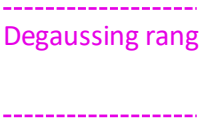
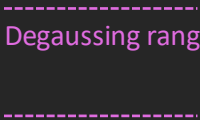

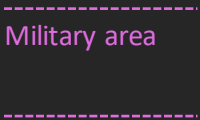

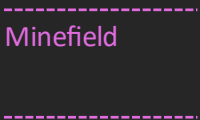
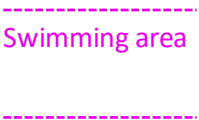
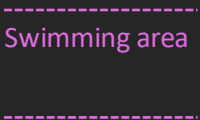

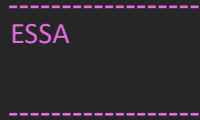

Radar station, Radio station and Radar transponder beacon

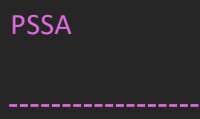
Symbol (day)	Symbol (night)	Symbol description
		Radio or radar station; radar transponder beacon (ramark or racon)

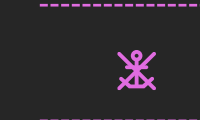
Restricted area



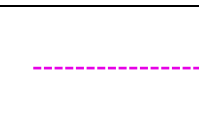
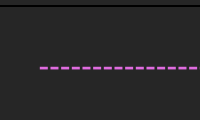
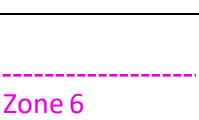
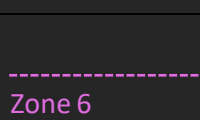

Symbol (day)	Symbol (night)	Symbol description
		Nature reserve
		Bird sanctuary
		Game reserve
		Seal sanctuary
		Degaussing range
		Military area
		Minefield
		Swimming area

Symbol (day)	Symbol (night)	Symbol description
<p>----- Waiting area -----</p>	<p>----- Waiting area -----</p>	Waiting area
<p>----- Research area -----</p>	<p>----- Research area -----</p>	Research area
<p>----- Dredging area -----</p>	<p>----- Dredging area -----</p>	Dredging area
<p>----- Fish sanctuary -----</p>	<p>----- Fish sanctuary -----</p>	Fish sanctuary
<p>----- Ecological reserve -----</p>	<p>----- Ecological reserve -----</p>	Ecological reserve
<p>----- No wake area -----</p>	<p>----- No wake area -----</p>	No wake area
<p>----- Swinging area -----</p>	<p>----- Swinging area -----</p>	Swinging area
<p>----- Water skiing area -----</p>	<p>----- Water skiing area -----</p>	Water skiing area



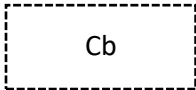
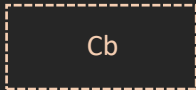

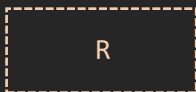
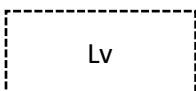

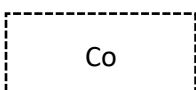
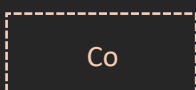
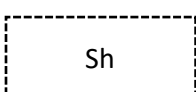
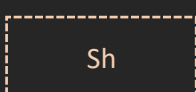
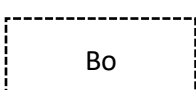
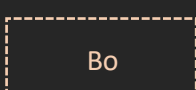



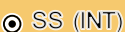
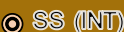
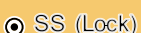
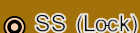
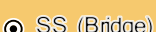

Symbol (day)	Symbol (night)	Symbol description
		Environmentally Sensitive Sea Area (ESSA)
		Particularly Sensitive Sea Area (PSSA)
		Anchoring prohibited area
		Fishing prohibited area
		Entry prohibited area
		Diving prohibited area
		Restricted area
		Restricted area (with name)

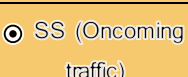
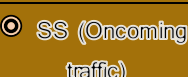





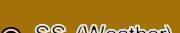



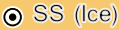
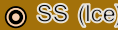
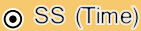
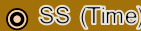
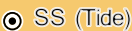
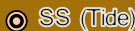

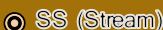

Seabed area

Symbol (day)	Symbol (night)	Symbol description
M	M	Mud
Cy	Cy	Clay
Si	Si	Silt
S	S	Sand
St	St	Stones
G	G	Gravel
P	P	Pebbles
Cb	Cb	Cobbles
R	R	Rock
Lv	Lv	Lava
Co	Co	Coral
Sh	Sh	Shells
Bo	Bo	Boulders
M	M	Mud
Cy	Cy	Clay
Si	Si	Silt
S	S	Sand
St	St	Stones
G	G	Gravel
P	P	Pebbles

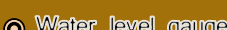

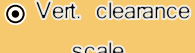
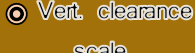
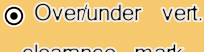
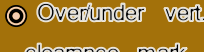







Symbol (day)	Symbol (night)	Symbol description
		Cobbles
		Rock
		Lava
		Coral
		Shells
		Boulders







































Signal station traffic and signal station warning















Symbol (day)	Symbol (night)	Symbol description
		Port control signal station
		Signal station showing International Port Traffic Signals
		Lock signal station
		Bridge passage signal station
		Bridge passage signal station
		Danger signal station
		Firing practice signal station
		Weather signal station, wind signal station
		Storm signal station

Symbol (day)	Symbol (night)	Symbol description
		Ice signal station
		Time signal station
		Tide signal station
		Tidal stream signal station
		Tide gauge
		Tide scale
		Water level gauge
		High water mark
		Vertical clearance scale
		Over/under vertical clearance mark
		Depth scale
		Signal station





















Small craft facility







Symbol (day)	Symbol (night)	Symbol description
		Visitors berth; visitors mooring
		Nautical club
		Boat hoist
		Sailmaker
		Boatyard

Symbol (day)	Symbol (night)	Symbol description
		Public inn
		Restaurant
		Chandler
		Provisions
		Doctor
		Pharmacy
		Water tap
		Fuel station
		Electricity
		Bottle gas
		Showers
		Launderette
		Public toilets
		Post box
		Public telephone; emergency telephone
		Refuse bin
		Car park
		Parking for boats and trailers
		Caravan site



















Symbol (day)	Symbol (night)	Symbol description
		Camping site
		Sewerage pump-out station
		Landing/launching place for boats
		Scrubbing berth
		Picnic area
		Mechanics workshop
		Guard and/or security service

Terminal

















Symbol (day)	Symbol (night)	Symbol description
		Passenger or ferry terminal; terminal in general
		Container terminal
		Bulk terminal
		Oil terminal
		Fuel terminal
		Chemicals terminal
		Liquid goods terminal
		Explosives terminal
		Fish terminal
		Cars terminal

Symbol (day)	Symbol (night)	Symbol description
		Transshipment terminal
		RoRo terminal
		Passenger or ferry terminal; terminal in general

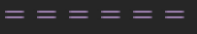



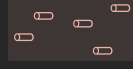









Underwater/awash rock















Symbol (day)	Symbol (night)	Symbol description
		Rock which does not cover (islet)
		Rock which covers and uncovers, shoaler than the range of depth of the surrounding depth area
		Rock which covers and uncovers
		Rock awash, shoaler than the range of depth of the surrounding depth area
		Rock awash
		Underwater rock, shoaler than the range of depth of the surrounding depth area
		Underwater rock
		Rock awash of known depth, shoaler than the range of depth of the surrounding depth area (the indicated number is an example)
		Underwater rock of known depth (the indicated number is an example)

Underwater structure



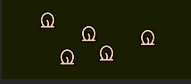

Symbol (day)	Symbol (night)	Symbol description
		Foundation, brush shelter
		Deadheads, submerged trees, flooded timber, stumps, piles, deadfall
		Fish attractor
		Submerged road
		Training wall
		Submerged jetty, levee, dyke
		Foundation, brush shelter
		Deadheads, submerged trees, flooded timber, stumps, piles, deadfall
 Fish Attractor - Cedars & Spiders	 Fish Attractor - Cedars & Spiders	Fish attractor (with additional information) (the indicated names are an example)

Vegetation















Symbol (day)	Symbol (night)	Symbol description
		Conifer
		Palm
		Nipa palm
		Casuarina
		Eucalypt
		Filao
		Vegetation, trees

Symbol (day)	Symbol (night)	Symbol description
		Trees
		Conifer
		Palm
		Nipa palm
		Casuarina
		Eucalypt
		Mangrove
		Filao

Weed/Kelp

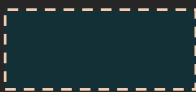
Symbol (day)	Symbol (night)	Symbol description
		Weed/kelp
		Weed/kelp (area)

Wrecks

Symbol (day)	Symbol (night)	Symbol description
		Non-dangerous wreck
		Wreck, covers and uncovers
		Remains of wreck (foul ground)
		Wreck showing masts, hull, or superstructure
		Wreck
		Obstruction or wreck (area)
		Non-dangerous wreck of known depth (the indicated number is an example)
		Wreck of known depth (the indicated number is an example)