

# Official Bulletin of the Industrial Property

Inventions

Utility Models

Designs

Trademarks

Appellations of Origin of Goods



საქართველოს ინტელექტუალური  
საკუთრების ეროვნული ცენტრი

**საქპატენტი**

**SAKPATENTI**

NATIONAL INTELLECTUAL PROPERTY  
CENTER OF GEORGIA

[www.sakpatenti.gov.ge](http://www.sakpatenti.gov.ge)

Date of Publication – 2022 12 26

**24(603)**

# INID CODES FOR IDENTIFICATION OF BIBLIOGRAPHIC DATA

## INVENTIONS, UTILITY MODELS

- (10) Number of publication for application, which has been examined
- (11) Number of patent and kind of document
- (21) Serial number of application
- (22) Date of filing of the application
- (23) Date of exhibition or the date of the earlier filing and the number of application, if any
- (24) Date from which patent may have effect
- (31) Number of priority application
- (32) Date of filing of priority application
- (33) Code of the country or regional organization allotting priority application number
- (44) Date of publication of application not granted, but examined and number of bulletin
- (45) Date of publication of registered document
- (51) International Patent Classification Index

- (54) Title of the invention
- (57) Abstract
- (60) Number of examined patent document granted by foreign patent office, date from which patent has effect and country code
- (62) Number of the earlier application and in case of divided application, date of filing an application
- (71) Name, surname and address of applicant (country code)
- (72) Name, surname of inventor (country code)
- (73) Name, surname and address of patent owner (country code)
- (74) Name, surname of representative or patent attorney
- (85) Date of commencement of the national phase of International Application
- (86) Number and date of filing of international application
- (87) Number and date of publication of international application
- (94) Calculated date of expiry of the SPC or the duration of the SPC

## DESIGNS

- (10) Number of publication for application
- (11) Number of patent and kind of document or number of registration
- (15) Date of registration/Date of patent renewal
- (18) Expected expiration date of patent or registration
- (21) Serial number of application
- (22) Date of filing of the application
- (23) Date of exhibition or the date of the earlier filing and the number of application, if any
- (24) Date from which patent may have effect
- (28) Number of designs included in the application
- (30) Data relating to priority (number of application, date of filing of application, two-letter code identifying the authority with whom the priority application was made)
- (31) Number of priority application
- (32) Date of filing of priority application
- (33) Code of the country or regional organization allotting priority application number
- (34) Two-letter code according to WIPO St.3 identifying the authority with which the priority application was made
- (44) Date of publication of design and number of bulletin (the first publication)
- (45) Date of publication of design registered by WIPO and number of bulletin

- (51) International Classification for designs (class and subclass of the Locarno Classification)
- (54) Title of the invention
- (55) Reproduction of the design
- (57) Description of characteristic features of the design including indication of colors
- (58) Date of recording of any kind of amendment in the Register
- (62) Number of the earlier application, registration and document number and if available the date of filing an application in case of divided application
- (71) Name, surname and address of applicant (country code)
- (72) Name, surname of creator (country code)
- (73) Name, surname and address of patent owner (country code)
- (74) Name, surname of representative or patent attorney
- (81) Contracting states concerned
  - II designated contracting states according to the 1960 Act
  - III designated contracting states according to the 1999 Act
- (85) Owner's permanent address
- (86) Owner's nationality
- (87) Owner's residence
- (88) State in which the owner has a real and effective industrial or commercial establishment

## TRADEMARKS

- (111) - Number of registration
- (151) - Date of registration
- (156) - Date of the renewal
- (181) - Expected expiration date of registration
- (186) - Renewal expiration date of registration
- (141) - Date of cancel of duration of the mark
- (210) - Serial number of application
- (220) - Date of filing of the application
- (230) - Data concerning exhibition
- (260) - Number of application, for which favorable decision of examination about registration has been taken (publication number)
- (310) - Number of the first application
- (320) - Date of filing of the first application
- (330) - Code, identifying national or regional Office where the first application was made
- (511) - International Classification of Goods and Services for the purposes of registration of trade marks and/or list of goods and/or services classified according thereto
- (526) - Disclaimer
- (531) - Description of figurative elements of Trade Marks according to the International Classification of the Figurative Elements of Marks

- (540) - Reproduction of Trade Mark
- (550) - Nature and kind of Trade Mark
- (551) - Indication to the effect that the mark is a collective mark, a certification mark or a guarantee mark
- (554) - Three-dimensional mark
- (580) - Date of recording of any kind changes in respect of applications or registrations
- (591) - Information concerning colors claimed
- (731) - Name and address of the applicant
- (732) - Name and address of the holder of the registration
- (740) - Name and address of the representative
- (750) - Addreses for correspondence
- (770) - Name and address of the previous applicant or holder in case of change in ownership
- (771) - Previous name and address of the applicant or holder in case of change in ownership
- (791) - Name and address of the licensee
- (793) - Indication of conditions and/or restrictions under the license (Type of license, number of license agreement, data of license, data of validity of license)
- (800) - Certain data relating to the international registration of Trade Marks under the Protocol Relating to Madrid Agreement (International registration number
- (852) - Partial cancellation of the list of goods and services
- (891) - Date of subsequent designation

## CODES FOR PUBLICATION IN BULLETIN

- (21) AP 0000 000000 - serial number of application for invention
- (10) AP 0000 0000 A - number of published application for invention (first publication)
- (11) P 0000 0000 B - number of patent for invention (second publication)
- (21) API 0000 000000 - number of application for imported patent
- (11) PI 0000 0000 A - number of imported patent (first publication)
- (21) AU 0000 000000 - serial number of application for utility model
- (10) AU 0000 000 U - number of published application for utility model (first publication)
- (11) U 0000 000 Y - number of patent for utility model (second publication)
- (21) AD 0000 000000 - serial number of application for design
- (10) AD 0000 000 S - number of published application for design (first publication)
- (11) D 0000 000 S - registered design

## INTERNATIONAL PATENT CLASSIFICATION FOR INVENTIONS AND UTILITY MODELS

- SECTION A - HUMAN NECESSITIES
- SECTION B - PERFORMING OPERATIONS; TRANSPORTING
- SECTION C - CHEMISTRY; METALLURGY
- SECTION D - TEXTILES; PAPER
- SECTION E - FIXED CONSTRUCTIONS
- SECTION F - MECHANICAL ENGINEERING; LIGHTING; HEATING; WEAPONS; BLASTING
- SECTION G - PHYSICS
- SECTION H - ELECTRICITY

- 
- M - Trade Mark
  - (210) AM 0000 000000 - Serial number of application;
  - (260) AAM 0000 00000 A - Publication number of application;
  - (111) M 0000 00000 R - Number of registration;
  - (111) MMM0000 00000 Rn - Number of renewals, in which n=1,2,3;
  - (111) M 0000 00000 R(P) - Number of registration under partial assignment of rights
-

# Official Bulletin of the Industrial Property

Inventions

Utility Models

Designs

Trademarks

Appellations of Origin of Goods

# CONTENT

<b>PUBLISHED TITLES OF PROTECTION</b> .....	3
<b>INVENTIONS</b>	
▪ APPLICATIONS APPROVED FOR GRANTING PATENT .....	4
▪ PATENTED INVENTIONS .....	7
<b>UTILITY MODELS</b>	
▪ APPLICATION APPROVED FOR GRANTING PATENT .....	8
▪ PATENTED UTILITY MODEL .....	9
<b>DESIGNS</b>	
▪ REGISTERED DESIGNS .....	10
▪ DESIGN REGISTERED ACCORDING TO THE ACCELERATED PROCEDURE .....	11
▪ DESIGNS, WHICH HAVE BEEN REGISTERED WITH THE INTERNATIONAL BUREAU CLAIMING PRIORITY ON THE TERRITORY OF GEORGIA .....	20
<b>TRADEMARKS</b>	
▪ APPLICATIONS FILED UNDER THE NATIONAL PROCEDURE APPROVED FOR REGISTRATION .....	26
▪ REGISTERED TRADEMARKS .....	41
▪ TRADEMARKS REGISTERED ACCORDING TO THE ACCELERATED PROCEDURE .....	44
▪ INTERNATIONAL TRADEMARKS FOR WHICH A DECISION ON GRANTING PROTECTION IS TAKEN .....	47
▪ INTERNATIONAL TRADEMARKS PROTECTED IN GEORGIA .....	159
<b>APPELLATIONS OF ORIGIN OF GOODS</b>	
▪ REGISTERED APPELLATION OF ORIGIN OF GOODS .....	164
▪ AMENDMENTS IN PDO WINE PRODUCTION SPECIFICATION .....	165
<b>OFFICIAL NOTIFICATIONS</b>	
<b>INVENTIONS</b>	
▪ RESTORATION OF PATENTS .....	166
▪ ABOLITION OF PATENTS WITH THE RIGHT TO RESTORE .....	166
▪ EXPIRATION OF PATENTS RESTORATION DATE .....	167
▪ EXPIRATION OF TERMS OF PATENTS .....	168
▪ TRANSFER OF RIGHT .....	168
▪ CHANGES OF NAME AND/OR ADDRESS OF PATENT OWNER .....	168
<b>UTILITY MODELS</b>	
▪ RESTORATION OF PATENT .....	169
▪ ABOLITION OF PATENT WITH THE RIGHT TO RESTORE .....	169
▪ EXPIRATION OF PATENT RESTORATION DATE .....	169
<b>TRADEMARKS</b>	
▪ EXTENSION OF TERMS OF TRADEMARKS REGISTRATION .....	170
▪ COMPLETE TRANSFER OF RIGHTS .....	172
▪ CHANGES OF NAMES AND/OR ADDRESSES OF TRADEMARKS OWNERS .....	173
▪ CANCELLATION OF TRADEMARKS REGISTRATION .....	173
<b>CLASSIFICATION INDEXES</b>	
INVENTIONS .....	174
UTILITY MODELS .....	175
DESIGNS .....	176
TRADEMARKS .....	178

## **PUBLISHED TITLES OF PROTECTION**

### **INVENTIONS**

- **APPLICATIONS APPROVED FOR GRANTING PATENT:**  
15261; 15719, 15720; 15407
- **PATENTED INVENTIONS:**  
7451, 7452

### **UTILITY MODELS**

- **APPLICATIONS APPROVED FOR GRANTING PATENT:**  
15738
- **PATENTED UTILITY MODEL:**  
2141

### **DESIGNS**

- **REGISTERED DESIGNS:**  
952, 953
- **DESIGN REGISTERED ACCORDING TO THE ACCELERATED PROCEDURE:**  
951
- **DESIGNS, WHICH HAVE BEEN REGISTERED WITH THE INTERNATIONAL BUREAU CLAIMING PRIORITY ON THE TERRITORY OF GEORGIA:**  
223835; 223839; 223841; 224233; 224309

### **TRADEMARKS**

- **APPLICATIONS FILED UNDER THE NATIONAL PROCEDURE APPROVED FOR REGISTRATION:**  
117272; 117308; 117433; 117613; 117623; 117625; 117650, 117651; 117659; 117664; 117669, 117670; 117711; 117720, 117721; 117727; 117730; 117733; 117805; 117807, 117808; 117814; 117818; 117824-117828; 117830; 117833; 117836; 117839; 117841; 117845; 117900-117903; 117906, 117907; 117910; 117914; 117916-117918; 117920; 117922; 117925; 117927; 117929; 117976; 117978, 117979; 117981-117983; 117990; 117992-117999; 118006; 118008, 118009; 118012; 118014-118017; 118020-118022; 118064; 118067; 118069; 118071; 118079; 118081, 118082; 118134, 118135; 118137; 118145; 118152
- **REGISTERED TRADEMARKS:**  
36167; 36174; 36189; 36191-36197; 36218-36225; 36227-36234; 36245
- **TRADEMARKS REGISTERED ACCORDING TO THE ACCELERATED PROCEDURE:**  
36256-36268
- **INTERNATIONAL TRADEMARKS FOR WHICH A DECISION ON GRANTING PROTECTIONS IS TAKEN:**  
114957; 115046; 115268; 115388; 116344; 116576; 116690-116693; 116695-116697; 116699- 116703; 116705, 116706; 116708; 116713; 116724; 116772-116776; 116783; 116789; 116796; 116799; 116804; 116812; 116826; 116870; 116873, 116874; 116876; 116879-116886; 116891-116894; 116898-116902; 116910-116912; 116923-116932; 116934-116942; 117003-117012; 117014-117031; 117052; 117061; 117110; 117112, 117113; 117117; 117148-117154; 117156, 117157; 117161; 117206-117210; 117213-117224; 117227; 117229, 117230; 117240; 117322-117326; 117338; 117345; 117347-117349; 117351; 117367; 117376; 117378, 117379; 117381-117383; 117385, 117386; 117473-117475; 117493; 117497, 117498; 117594, 117595; 117633-117635; 117637; 117671-117673; 117697-117701; 117793; 117796; 117874-117876; 117878-117883; 117969, 117970; 117974, 117975
- **INTERNATIONAL TRADEMARKS PROTECTED IN GEORGIA:**  
104485; 113221; 115443-115446; 115461; 115465-115468; 115484-115486; 115488-115492; 115494-115498; 115613-115615; 115617-115728; 115811-115819; 116254-116257; 116259-116663

### **APPELLATIONS OF ORIGIN OF GOODS**

- **REGISTERED APPELLATION OF ORIGIN OF GOODS:**  
985
- **AMENDMENTS IN PDO WINE PRODUCTION SPECIFICATION:**  
KISI MAGRAANI

# INVENTIONS

## APPLICATIONS APPROVED FOR GRANTING PATENT

The decision can be appealed at the Chamber of Appeal of Sakpatenti within 3 months from the publication or at the Mtskheta District Court Administrative Cases Board (Address: №17, Samkhedro St., Mtskheta), within 1 month following the publication.

### PART C

#### C 04

- (10) AP 2022 15261 A (51) Int. Cl. (2006)  
C 04 B 28/14  
C 04 B 11/00
- (21) AP 2017 15261 (22) 2017 08 04
- (71) Knauf Gips KG (DE)  
Am Bahnhof 7, 97346 Iphofen, Germany (DE)
- (72) DIETZ, Stephan (DE);  
HARTMANN, Alexander (DE);  
FRASER, Thomas (AU);  
BAIER, Manfred (DE);  
FÖRTHNER, Sebastian (DE);  
KARAKOUSSIS, Stergios (DE);  
PARASKOV, Georgi (DE);  
SCHNEIDERBANGER, Reiner (DE)
- (74) Larisa Amirkhanyan
- (85) 2020 01 23
- (86) PCT/EP2017/000946, 2017 08 04
- (54) IMPROVEMENT OF STUCCO PROPERTIES THROUGH AGING AT ELEVATED TEMPERATURES AND HIGH HUMIDITY LEVEL
- (57) A method for stabilizing stucco provides fresh stucco maintain at the temperature of at least 50°C; water is added to the fresh stucco to obtain moistened stucco, and the moistened stucco is maintained at the temperature of 50°C-100°C, for time interval from 30 minutes to 24 h-s, to obtain stabilized stucco, wherein it contains free moisture in the amount of 0.5 to 1.5 mass%, calculated on the mass of stabilized stucco. The invention also relates to the method of production of drywall plates by using of stabilized stucco.
- Claims: 3 independents  
8 dependents

#### C 07

- (10) AP 2022 15719 A (51) Int. Cl. (2006)  
C 07 B 59/00  
C 07 D 295/145
- (21) AP 2014 15719 (22) 2014 10 17
- (62) AP 2014 15377 2014 10 17
- (31) 13004991.9; 14175612.2
- (32) 2013 10 18; 2014 07 03
- (33) EP; EP
- (71) Deutsches Krebsforschungszentrum (DE)

Im Neuenheimer Feld 280, 69120 Heidelberg,  
Germany (DE);  
Ruprecht-Karls-Universität Heidelberg (DE)  
Grabengasse 1, 69117 Heidelberg,  
Germany (DE)

- (72) EDER, Matthias (DE);  
KOPKA, Klaus (DE);  
SCHÄFER, Martin (DE);  
BAUDER-WÜST, Ulrike (DE);  
HABERKORN, Uwe (DE);  
EISENHUT, Michael (DE);  
MIER, Walter (DE);  
BENESOVA, Martina (DE);  
KRATOCHWIL, Clemens (DE)
- (74) Shalva Gvaramadze
- (85) 2021 08 20
- (86) PCT/EP2014/002808, 2014 10 17
- (54) LABELED INHIBITORS OF PROSTATE SPECIFIC MEMBRANE ANTIGEN (PSMA), THEIR USE AS IMAGING AGENTS AND PHARMACEUTICAL AGENTS FOR THE TREATMENT OF PROSTATE CANCER
- (57) Metallic complex containing compound of formula:

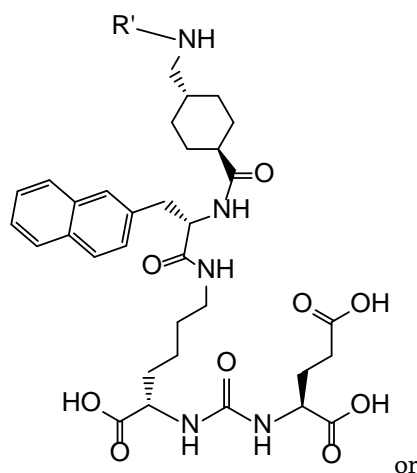

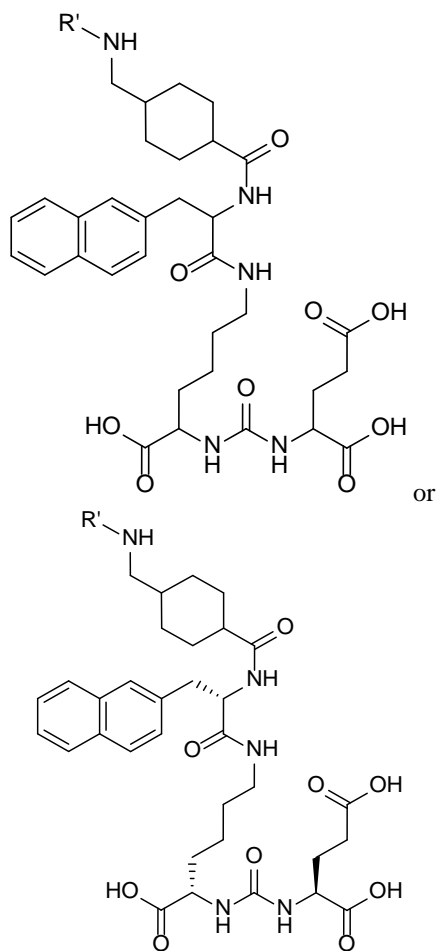

or salt thereof, wherein R' is a chelator of formula:

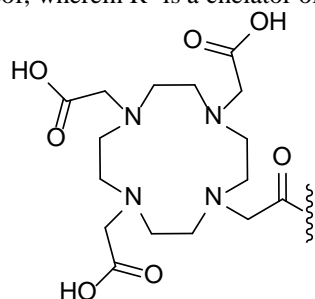

wherein the chelator is represented as a complex with  $^{225}\text{Ac}$ . Pharmaceutical composition comprising said metallic complex, and usage thereof prostate cancer and/or its metastases treatment, visualization or diagnosis.

Claims: 13 independents

8 dependents

Table: 4

Fig.: 20

- (10) AP 2022 15720 A (51) Int. Cl. (2006)  
C 07 B 59/00  
C 07 D 295/145  
(21) AP 2014 15720 (22) 2014 10 17  
(62) AP 2014 15377 2014 10 17  
(31) 13004991.9; 14175612.2

(32) 2013 10 18; 2014 07 03

(33) EP; EP

(71) Deutsches Krebsforschungszentrum (DE)  
Im Neuenheimer Feld 280, 69120 Heidelberg,  
Germany (DE);  
Ruprecht-Karls-Universität Heidelberg (DE)  
Grabengasse 1, 69117 Heidelberg,  
Germany (DE)

(72) EDER, Matthias (DE);  
KOPKA, Klaus (DE);  
SCHÄFER, Martin (DE);  
BAUDER-WÜST, Ulrike (DE);  
HABERKORN, Uwe (DE);  
EISENHUT, Michael (DE);  
MIER, Walter (DE);  
BENESOVA, Martina (DE);  
KRATOCHWIL, Clemens (DE)

(74) Shalva Gvaramadze

(85) 2021 08 20

(86) PCT/EP2014/002808, 2014 10 17

(54) LABELED INHIBITORS OF PROSTATE  
SPECIFIC MEMBRANE ANTIGEN (PSMA),  
THEIR USE AS IMAGING AGENTS AND  
PHARMACEUTICAL AGENTS FOR THE  
TREATMENT OF PROSTATE CANCER

(57) Metallic complex containing compound of  
formula:

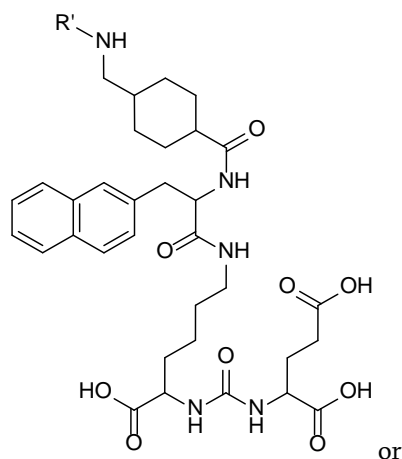
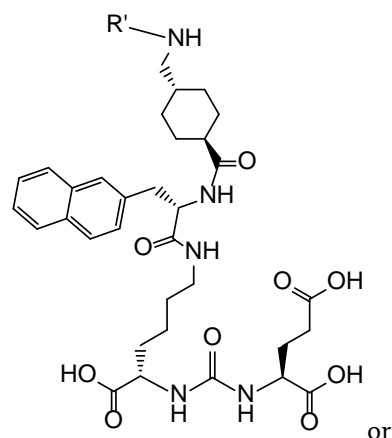

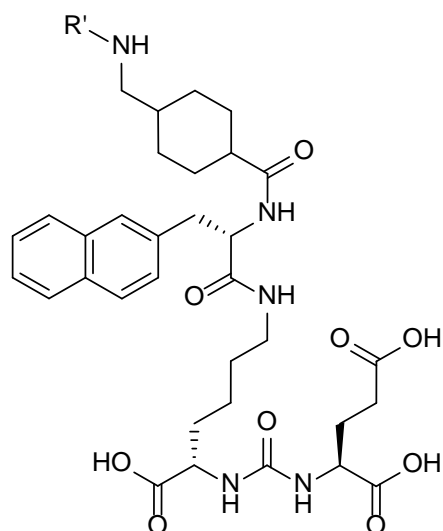

or salt thereof, wherein R' is a chelator of formula:

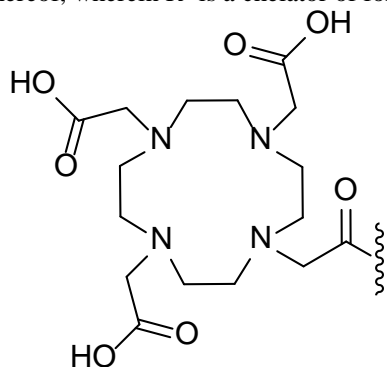

wherein the chelator is represented as a complex with radionuclide, selected from the following:

$^{89}\text{Zr}$ ,  $^{44}\text{Sc}$ ,  $^{111}\text{In}$ ,  $^{90}\text{Y}$ ,  $^{66}\text{Ga}$ ,  $^{67}\text{Ga}$ ,  $^{68}\text{Ga}$ ,

$^{99\text{m}}\text{Tc}$ ,  $^{61}\text{Cu}$ ,  $^{62}\text{Cu}$ ,  $^{64}\text{Cu}$ ,  $^{67}\text{Cu}$ ,  $^{149}\text{Tb}$ ,  $^{152}\text{Tb}$ ,

$^{155}\text{Tb}$ ,  $^{161}\text{Tb}$ ,  $^{153}\text{Gd}$ ,  $^{155}\text{Gd}$ ,  $^{157}\text{Gd}$ ,  $^{213}\text{Bi}$ ,

$^{230}\text{U}$ ,  $^{223}\text{Ra}$ ,  $^{165}\text{Er}$  or Fe.

Pharmaceutical composition containing said metallic complex, and usage thereof prostate cancer and/or its metastases treatment, visualization or diagnosis.

Claims: 13 independents

8 dependents

Table: 4

Fig.: 20

(72) SZABÓ, Tamás (HU);  
NEU, József (HU);  
GARADNAY, Sándor (HU)

(74) Liliana Darakhvelidze

(85) 2020 08 11

(86) PCT/IB2019/050213, 2019 01 11

(54) PROCESS FOR THE PREPARATION OF

4-(4-AMINOPHENYL)MORPHOLIN-3-ONE

(57) A process, suitable for the preparation of 4-(4-aminophenyl)morpholin-3-one of formula (I),

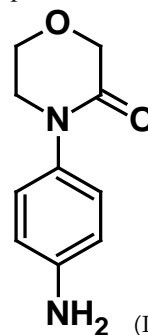

In the process 2-(2-chloroethoxy)ethanol of formula (XI) is oxidized to 2-(2-chloroethoxy)-acetic acid with aqueous sodium- or calcium-hypochlorite and a catalyst. The 2-(2-chloroethoxy)acetic acid of Formula (X) is reacted with 4-nitro-aniline of formula (VII) with phenylboronic acid catalyst. Then the 2-(2-chloroethoxy)-N-(4-nitrophenyl)acetamide of formula (IX) is transformed to 4-(4-nitrophenyl)morpholin-3-one of formula (IV) in "one-pot" procedure. 4-(4-nitrophenyl)morpholin-3-one of formula (IV) is hydrogenated to get 4-(4-aminophenyl)morpholin-3-one of formula (I).

Claims: 1 independent

4 dependents

(10) AP 2022 15407 A (51) Int. Cl. (2006)

C 07 C 231/02

C 07 C 51/16

C 07 D 265/32

(21) AP 2019 15407 (22) 2019 01 11

(31) P1800007

(32) 2018 01 12

(33) HU

(71) Richter Gedeon Nyrt. (HU)

Gyömrői út 19-21, H-1103 Budapest,  
Hungary (HU)



## PATENTED INVENTIONS

### PART C

#### C 04

- (11) P 2022 7452 B      (51) Int. Cl. (2006)  
C 04 B 7/36
- (10) AP 2022 15578 A    (44) 16(595)/2022
- (21) AP 2021 15578
- (22) 2021 03 03
- (24) 2021 03 03
- (73) Lepl "Shota Rustaveli National Scientific  
Foundation of Georgia" (GE)  
Merab Aleksidze Str. 1, 0193, Tbilisi,  
Georgia (GE);  
Razhden Skhvitaridze (GE)  
E. Ninoshvili Str. 3a, 0102, Tbilisi,  
Georgia (GE)
- (72) Teimuraz Kordzakhia (GE);  
Giorgi Tsintskaladze (GE);  
Irakli Giorgadze (GE);  
Shalva Verulava (GE);  
Givi Loladze (GE);  
Teimuraz Tcheishvili (GE);  
Giorgi Kavtiashvili (GE);  
Razhden Skhvitaridze (GE);  
Akaki Skhvitaridze (GE)
- (54) METHOD OF CEMENT PRODUCTION

- NINKOVIC, Sacha (US);  
SUTTON, Scott Channing (US)
- (74) Shalva Gvaramadze
- (54) 3-CARBONYLAMINO-5-CYCLOPENTYL-1  
H-PYRAZOLE COMPOUNDS HAVING  
INHIBITORY ACTIVITY ON CDK2

#### C 07

- (11) P 2022 7451 B      (51) Int. Cl. (2006)  
C 07 D 405/12  
C 07 D 403/14  
C 07 D 403/12  
C 07 D 401/14  
C 07 D 401/12  
C 07 D 231/40
- (10) AP 2022 15709 A    (44) 16(595)/2022
- (21) AP 2020 15709
- (22) 2020 01 28
- (24) 2020 01 28
- (31) 62/959,042
- (32) 2020 01 09
- (33) US
- (86) PCT/IB2020/050653, 2020 01 28
- (73) Pfizer Inc. (US)  
235 East 42<sup>nd</sup> Street, New York, NY 10017,  
USA (US)
- (72) BEHENNA, Douglas Carl (US);  
FREEMAN-COOK, Kevin Daniel (US);  
HOFFMAN, Robert Louis (US);  
NAGATA, Asako (US);

---

# UTILITY MODELS

## APPLICATION APPROVED FOR GRANTING PATENT

The decision can be appealed at the Chamber of Appeal of Sakpatenti within 3 months from the publication or at the Mtskheta District Court Administrative Cases Board (Address: №17, Samkhedro St., Mtskheta), within 1 month following the publication.

### PART E

#### E 02

- (10) AU 2022 15738 U (51) Int. Cl. (2006)  
E 02 B 8/06
- (21) AU 2021 15738 (22) 2021 09 20
- (71) Shota Rustaveli National Science  
Foundation of Georgia (GE)  
Merab Aleksidze Str., II Lane 2, 0193, Tbilisi,  
Georgia (GE);  
Eduard Kukhalashvili (GE)  
Ilia Chavchavadze Ave. 60-b, 0179, Tbilisi,  
Georgia (GE);  
Givi Gavardashvili (GE)  
Ilia Chavchavadze Ave. 60-b, 0179, Tbilisi,  
Georgia (GE);  
Inga Iremashvili (GE)  
Ilia Chavchavadze Ave. 60-b, 0179, Tbilisi,  
Georgia (GE);  
Tsothe Mirtskhulava Water Management  
Institute of Georgian Technical University (GE)  
Ilia Chavchavadze Ave. 60-b, 0179, Tbilisi,  
Georgia (GE)
- (72) Eduard Kukhalashvili (GE);  
Givi Gavardashvili (GE);  
Inga Iremashvili (GE)

#### (54) MUDFLOW PROTECTION DEVICE

(57) Mudflow protection device is penetrating, trampoline-type construction, the tip whereof is directed towards mudflow motion in river bed. It consists of sections made as right triangular prisms (2), and it is fixed into the bed by means of lateral braces (3). Elastic, sediment catching grids, made of metallic ropes (7) and creating elastic pockets (8), are fixed onto the braces of sections placed on upper surface of construction. Sizes of sections are made like that, they are decreasing step by step towards the direction of flow motion, from its front to central section shore.

Claims: 1 independent

Fig.: 4

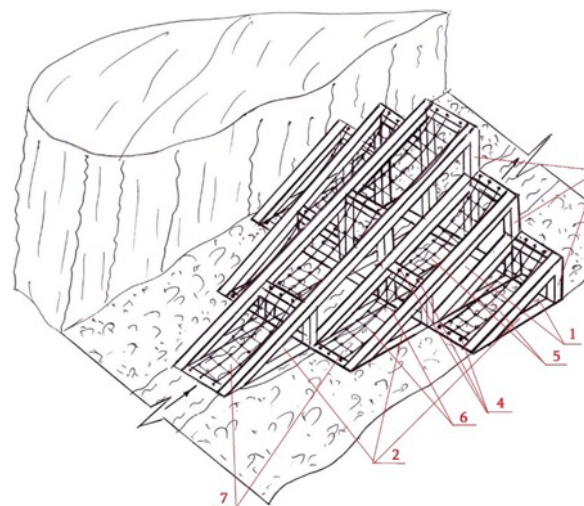

Fig. 1



---

## DESIGNS REGISTERED DESIGNS

(11) D 2022 952 S      (51) 09-01  
(10) AD 2022 1262 S    (44) 2022 09 12 №17  
(21) AD 2022 1262  
(22) 2022 03 21  
(24) 2022 03 21  
(28) 1  
(18) 2027 03 21  
(73) LTD "Global Brand" (GE)  
    Vazha-Pshavela Ave. 29 (plot 07/081), 0160,  
    Vake-Saburtalo District, Tbilisi, Georgia (GE)  
(72) Kevin Shaw (US)  
(54) BOTTLE

---

(11) D 2022 953 S      (51) 11-01  
(10) AD 2022 1264 S    (44) 2022 09 12 №17  
(21) AD 2022 1264  
(22) 2022 04 20  
(24) 2022 04 20  
(28) 2  
(18) 2027 04 20  
(73) Gurami Tabatadze (GE)  
    Rionhesi Str. 67, 0180, Gldani-Nadzaladevi  
    District, Tbilisi, Georgia (GE)  
(72) Gurami Tabatadze (GE)  
(54) 1.-2. HANDMADE JEWELRY

---

## DESIGN REGISTERED ACCORDING TO THE ACCELERATED PROCEDURE

The decision can be appealed at the Chamber of Appeal of Sakpatenti within 3 months from the publication.

- (11) D 2022 951 S (51) 07-01  
(21) AD 2022 1285 (22) 2022 11 30  
(24) 2022 11 30  
(28) 11  
(18) 2027 11 30  
(73) Gia Gamtkitsulashvili (GE)  
Vazha-Pshavela Ave. 71, bld. "C", ap. 7, 0186, Tbilisi, Georgia (GE);  
Gela Gamtkitsulashvili (GE)  
Vazha-Pshavela Ave. 71, bld. "C", ap. 7, 0186, Tbilisi, Georgia (GE)  
(72) Gia Gamtkitsulashvili (GE);  
Gela Gamtkitsulashvili (GE)  
(74) Nikoloz Gogilidze (GE)  
(54) 1.-11. QVEVRI

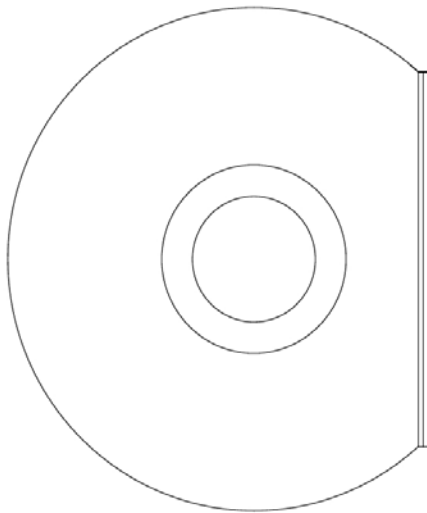

1.1

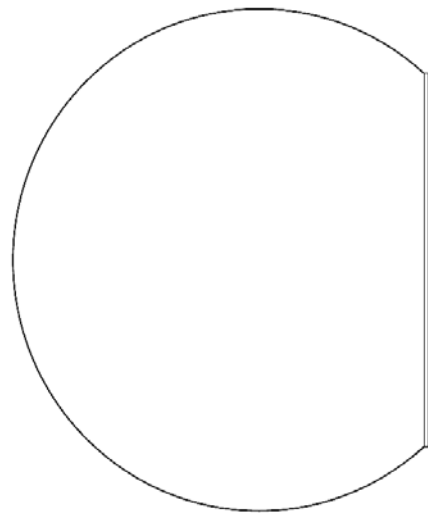

1.2

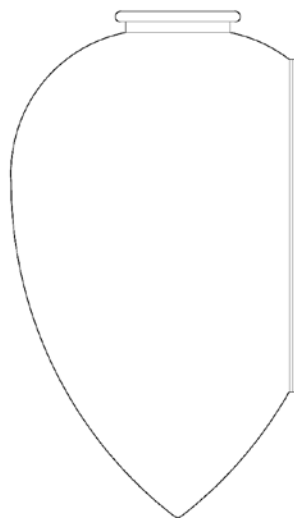

1.3

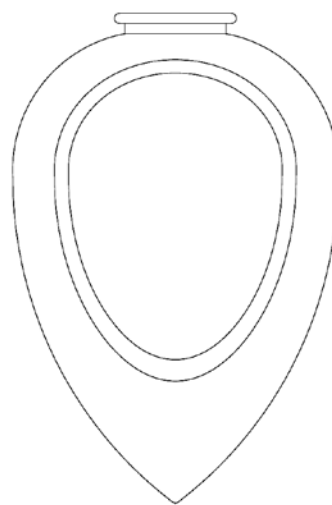

1.4

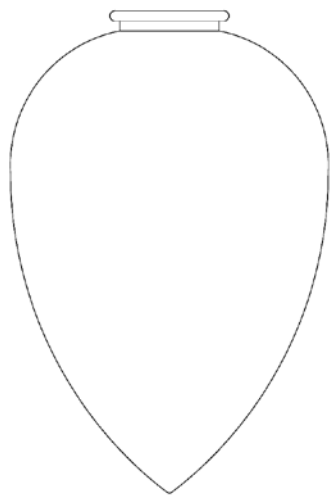

1.5

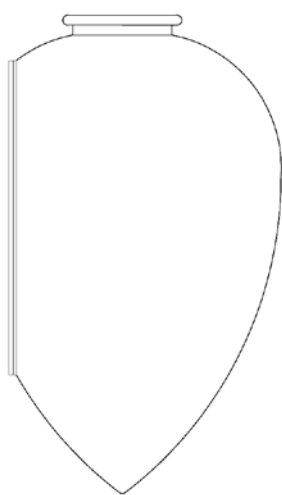

1.6

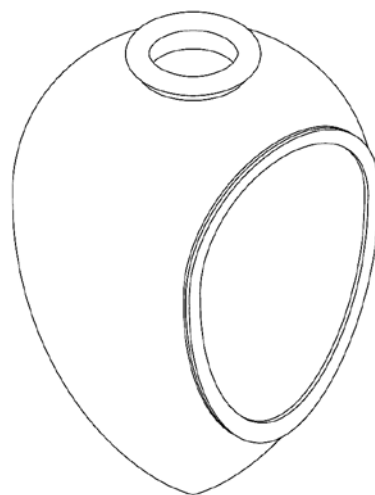

1.7



2.1



2.2



2.3



2.4



2.5

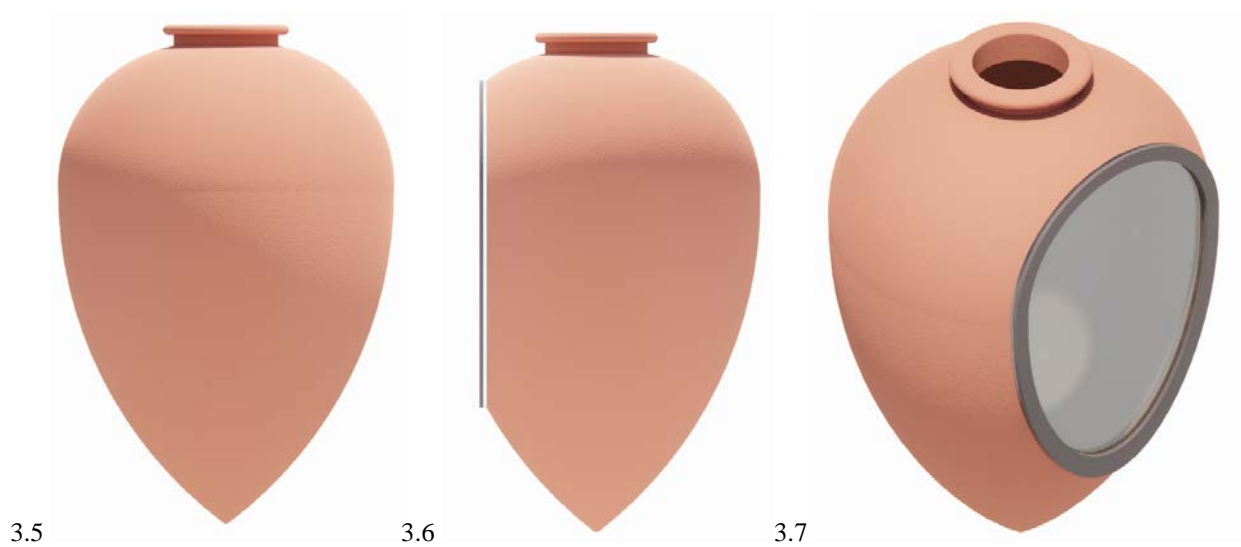
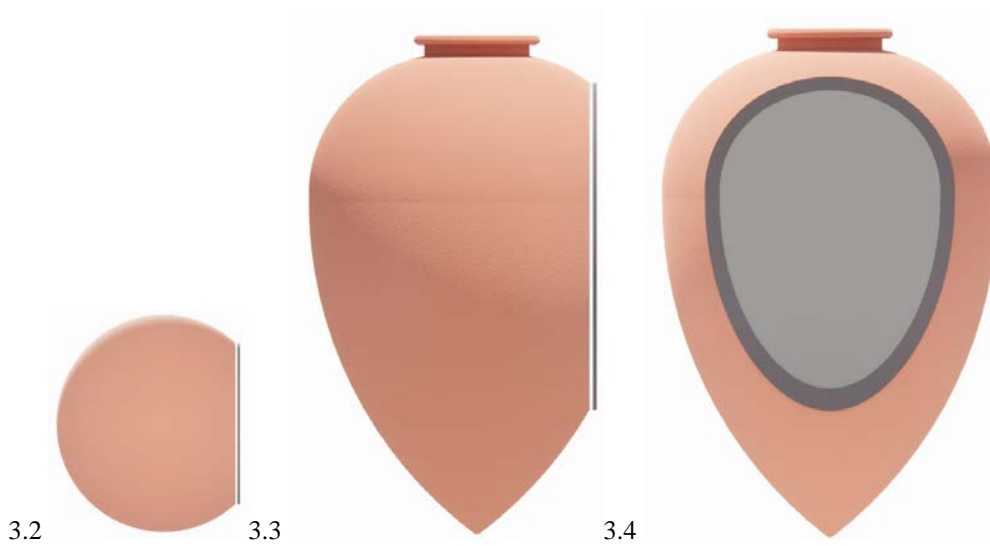
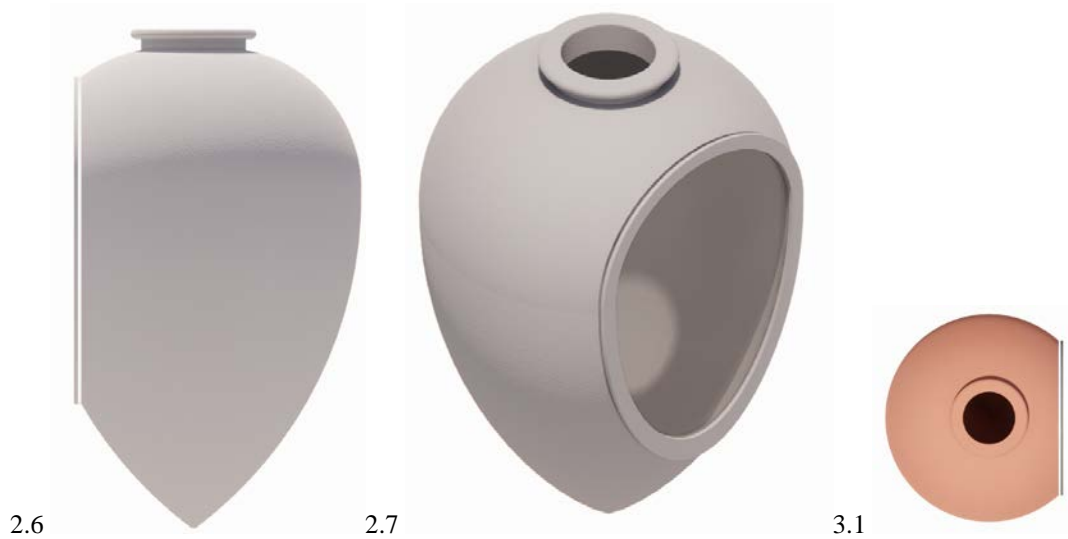



4.1



4.2



4.3



4.4



4.5



4.6



4.7

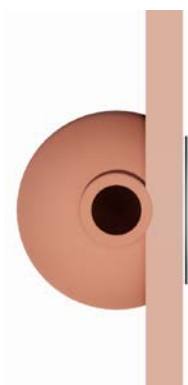

5.1



5.2



5.3

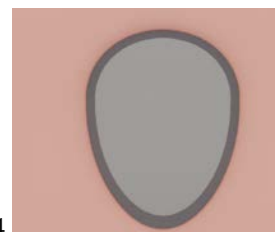

5.4





5.5



5.6



5.7

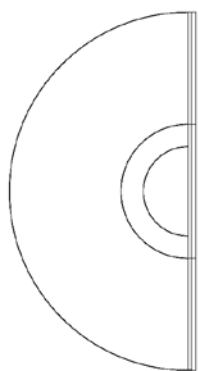

6.1

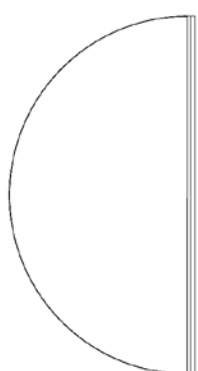

6.2

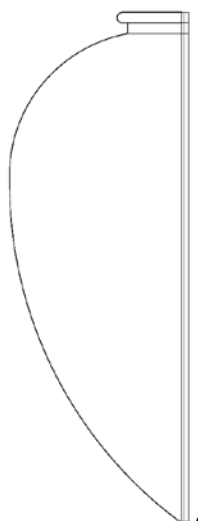

6.3

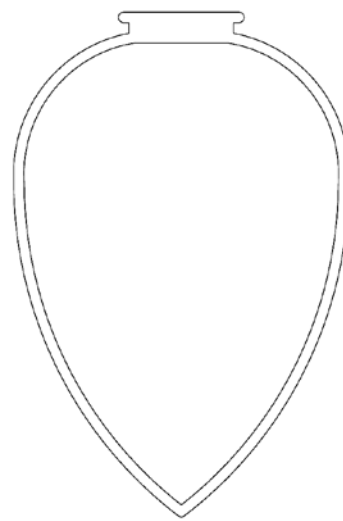

6.4

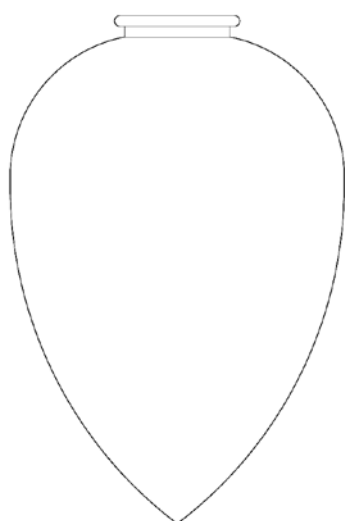

6.5

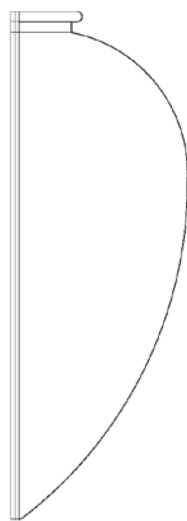

6.6

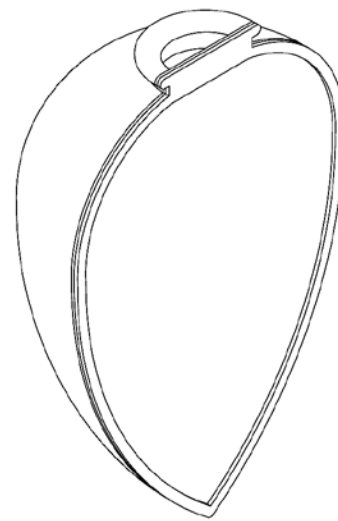

6.7

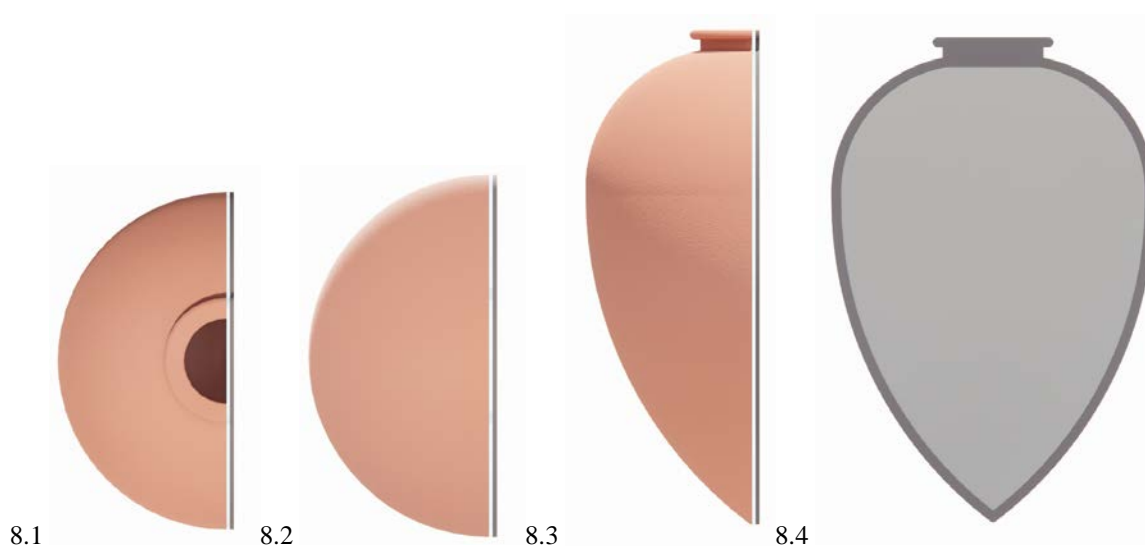
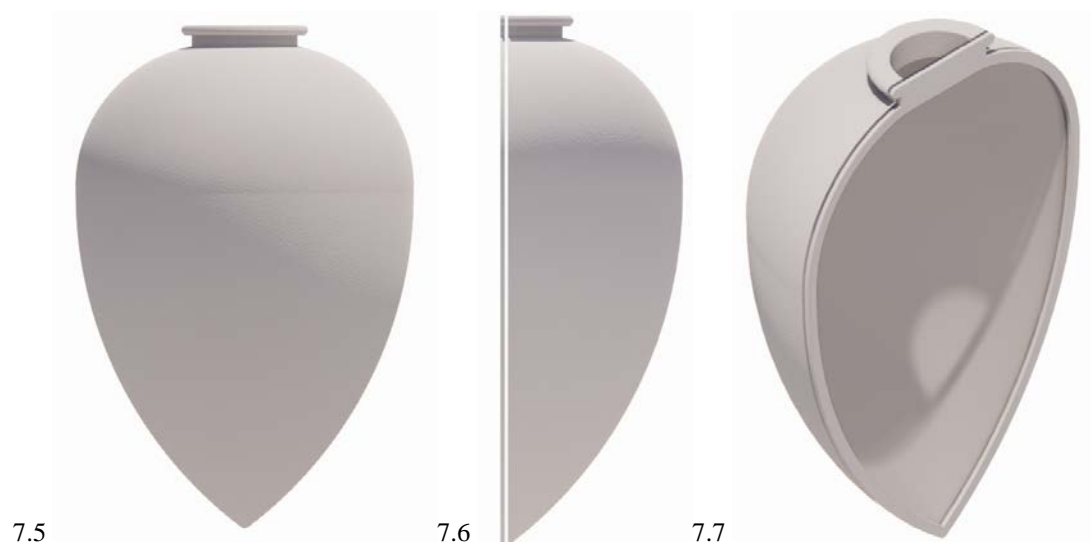
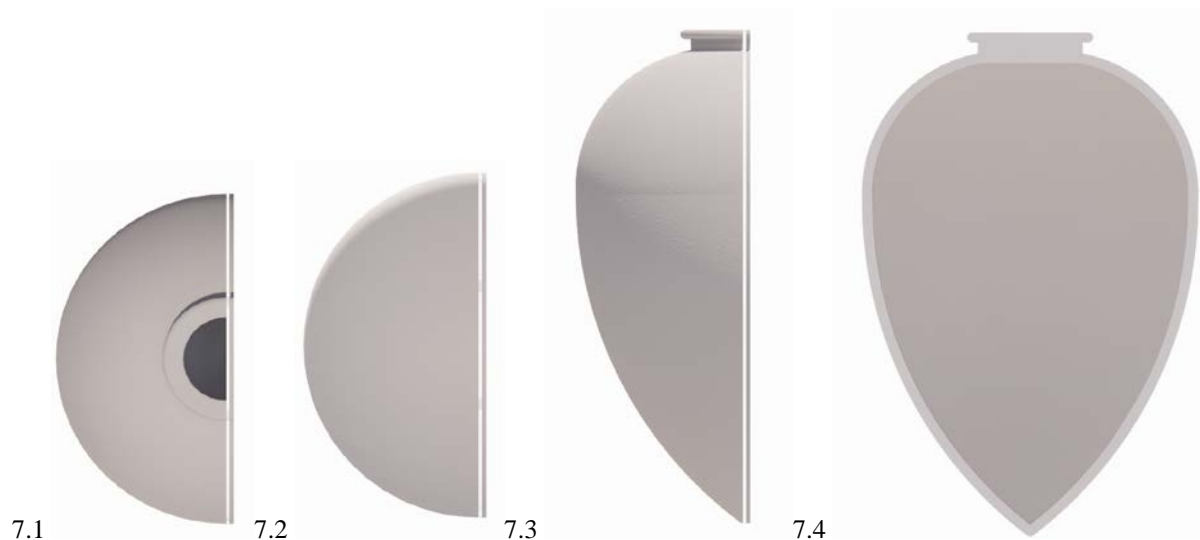



8.5



8.6



8.7



9.1

9.2

9.3



9.4



9.5

9.6



9.7

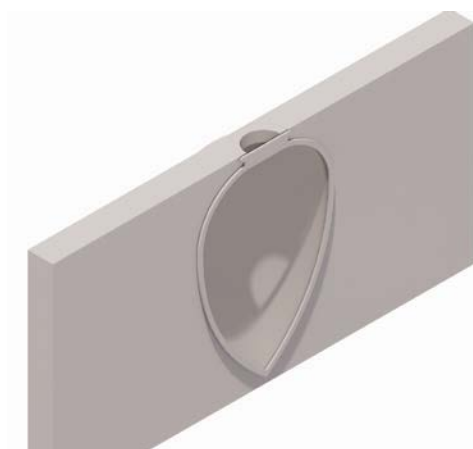

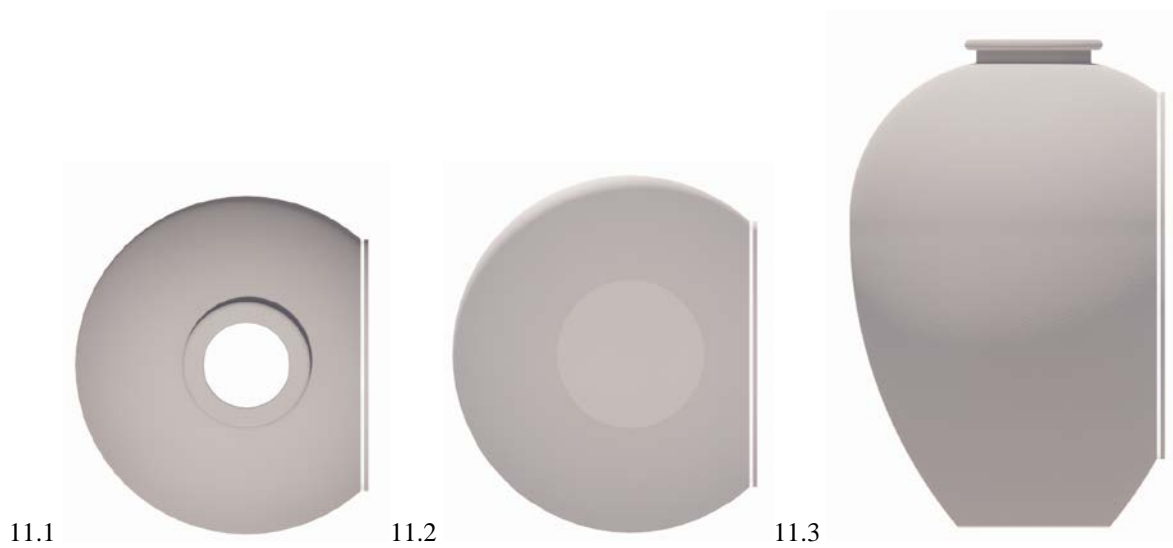
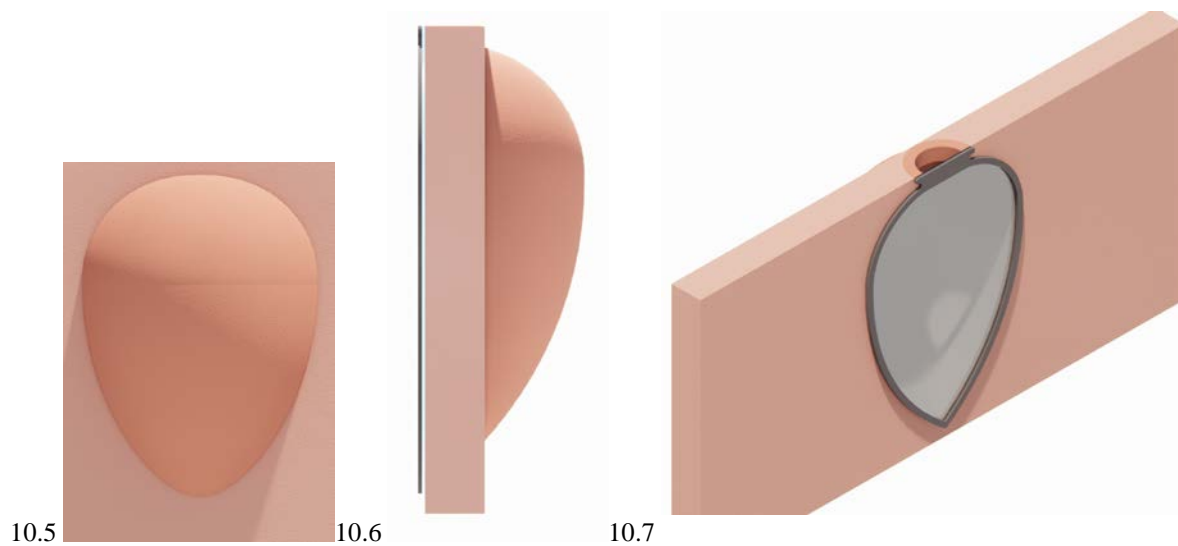
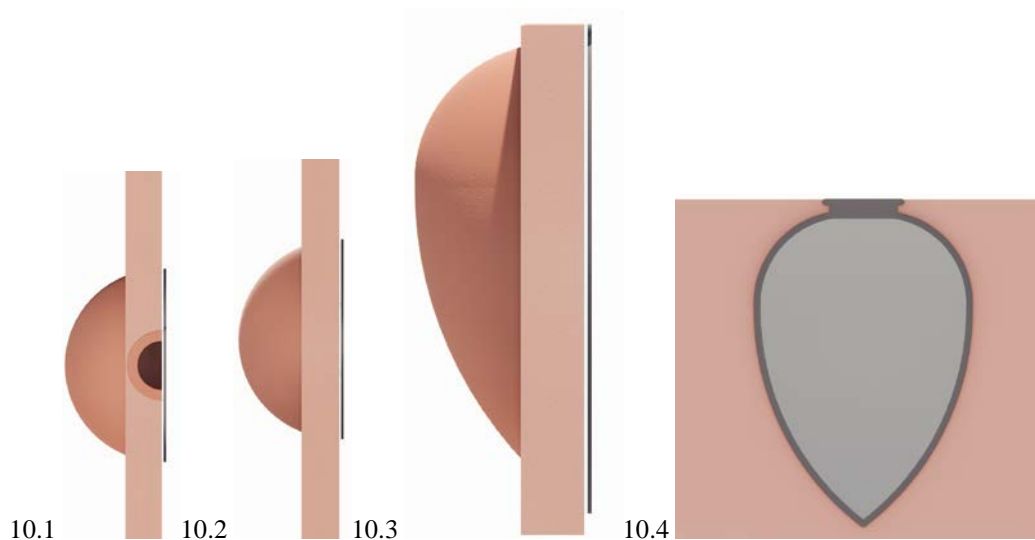



11.4



11.5



11.6



11.7

**DESIGNS, WHICH HAVE BEEN REGISTERED WITH THE INTERNATIONAL BUREAU CLAIMING PRIORITY ON THE TERRITORY OF GEORGIA**

The decision can be appealed at the Chamber of Appeal of Sakpatenti within 3 months from the publication or at the Mtskheta District Court Administrative Cases Board (Address: №17, Samkhedro St., Mtskheta), within 1 month following the publication.

- (11) DM/223 835
- (15) 2022 09 27
- (22) 2022 09 27
- (28) 1
- (73) Chanel SARL  
Quai du Général-Guisan 24, 1204 Genève (CH)
- (85) CH
- (86) CH
- (87) CH
- (88) CH
- (89) CH
- (81) II. GR III. AZ, BG, DK, EG, FI, GE, JP, LT, LV, MA, MD, MX, NO, OM, PL, RU, TN, TR, UA
- (72) Marianna Nitsch  
135 Avenue Charles de Gaulle, 92521, Neuilly sur Seine (FR)
- (46) 2022 10 14
- (54) 1. BRACELET
- (55)

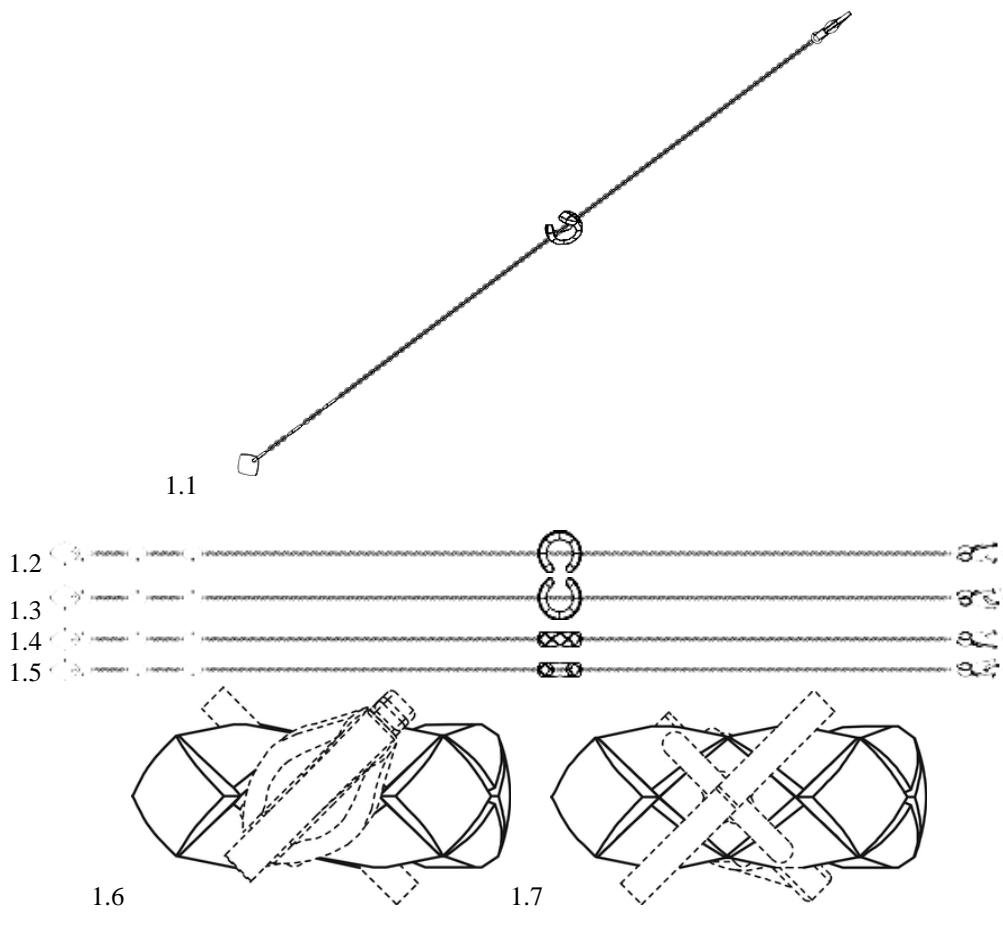

(11) DM/223 839

(51) 11-01

(15) 2022 09 27

(44) 41/2022 (2022 10 14)

(22) 2022 09 27

(28) 1

(73) Chanel SARL

Quai du Général-Guisan 24, 1204 Genève (CH)

(85) CH

(86) CH

(87) CH

(88) CH

(89) CH

(81) II. GR III. AZ, BG, DK, EG, FI, GE, JP, LT, LV, MA, MD, MX, NO, OM, PL, RU, TN, TR, UA

(72) Marianna Nitsch

135 Avenue Charles de Gaulle, 92521, Neuilly sur Seine (FR)

(46) 2022 10 14

(54) 1. BRACELET

(55)

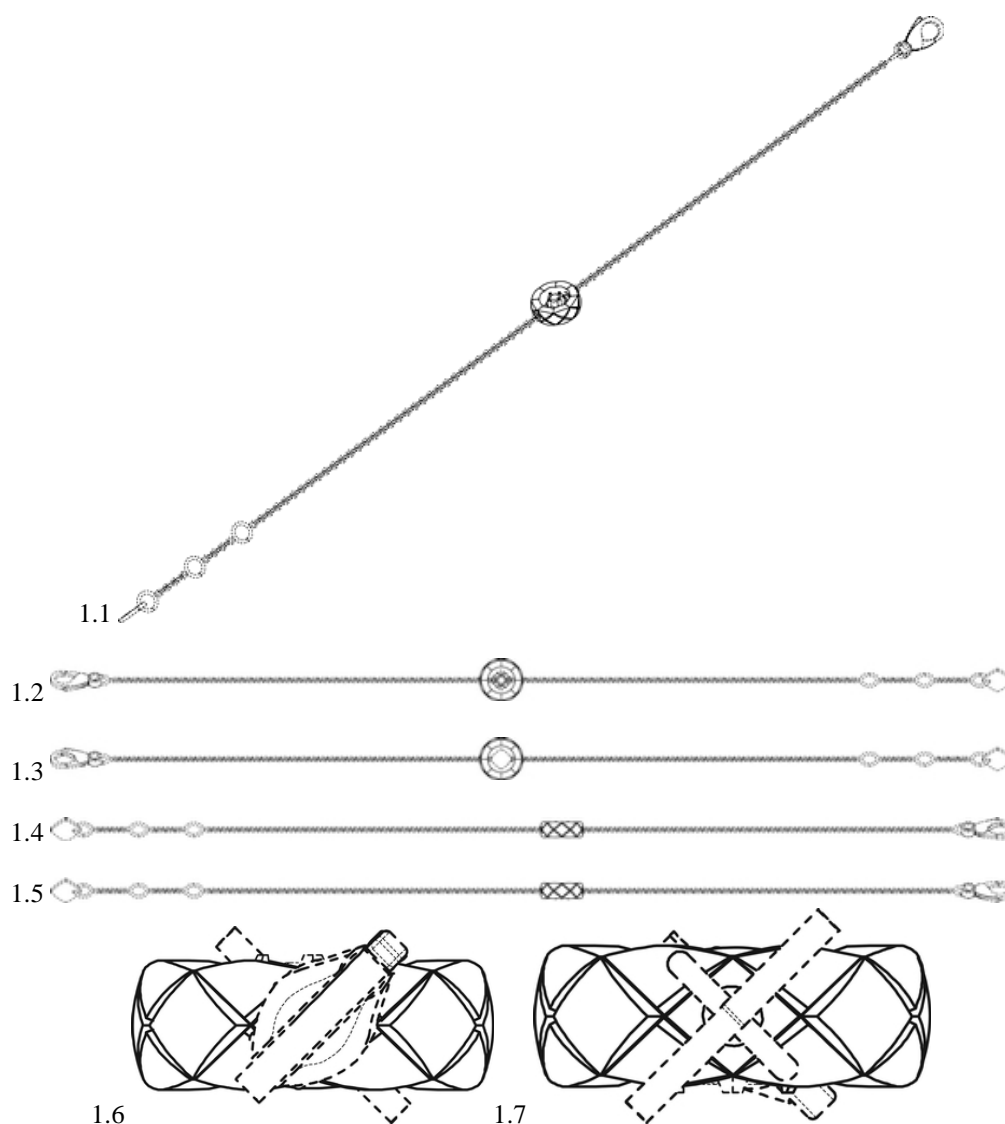

(11) DM/223 841  
(15) 2022 09 27  
(22) 2022 09 27  
(28) 1

(51) 11-01  
(44) 41/2022 (2022 10 14)

(73) Chanel SARL  
Quai du Général-Guisan 24, 1204 Genève (CH)

(85) CH  
(86) CH  
(87) CH  
(88) CH  
(89) CH

(81) II. GR III. AZ, BG, DK, EG, FI, GE, JP, LT, LV, MA, MD, MX, NO, OM, PL, RU, TN, TR, UA

(72) Marianna Nitsch  
135 Avenue Charles de Gaulle, 92521, Neuilly sur Seine (FR)

(46) 2022 10 14

(54) 1. PENDANT [JEWELLERY]

(55)

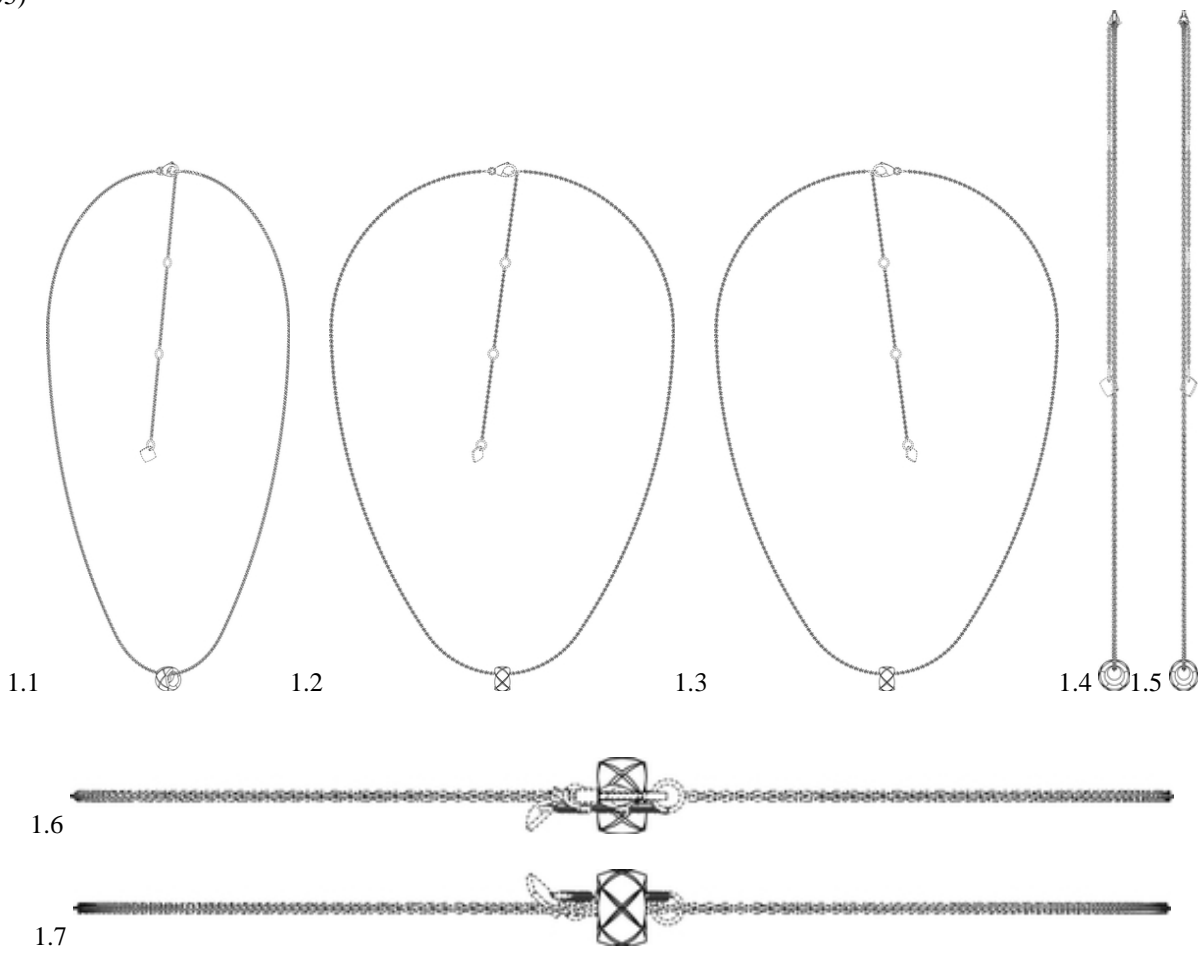



- (11) DM/224 233 (51) 02-04  
(15) 2022 10 13 (44) 43/2022 (2022 10 28)  
(22) 2022 10 13  
(28) 1  
(73) LOWA Sportschuhe GmbH  
Hauptstr. 19, 85305 Jetzendorf (DE)  
(85) DE  
(86) DE  
(87) DE  
(88) DE  
(89) DE  
(81) III. AL, AM, AZ, BA, BN, BW, BZ, CH, EG, EM, GB, GE, GH, IS, KG, KH, LI, LV, MA, MC, MD,  
ME, MK, MN, MX, NA, NO, OA, OM, RS, RW, SG, SM, SR, TJ, TN, TR, UA, WS  
(72) Marcello Trianni  
Poststrasse 28a, 8274, Tägerwilen (CH)  
(74) WEICKMANN & WEICKMANN PATENT- UND RECHTSANWÄLTE PARTMBB  
Richard-Strauss Str. 80, 81679, Munich (DE)  
(46) 2022 10 28  
(54) 1. SOLE FOR FOOTWEAR  
(55)

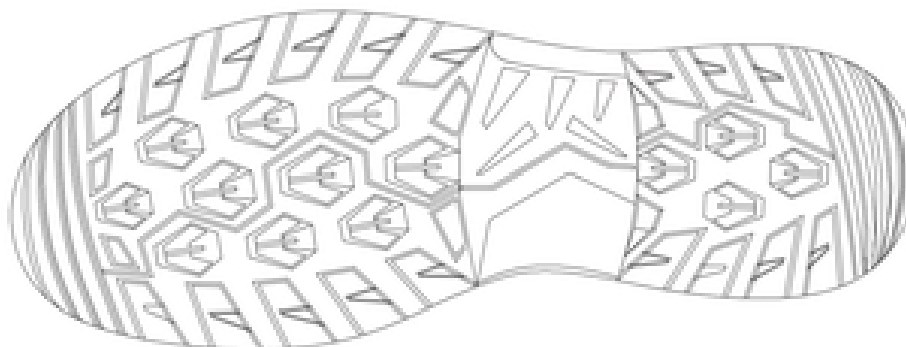

1.1

- (11) DM/224 309 (51) 14-06  
 (15) 2022 09 11 (44) 43/2022 (2022 10 28)  
 (22) 2022 09 11  
 (28) 2  
 (30) No1: 11.05.2021; 29/783, 155; US; No2: 11.05.2021; 29/783, 155; US  
 (73) AMBULANT INC.  
 360 SW Bond St. Ste 310, 97702 Bend, OR (US)  
 (85) US  
 (86) US  
 (87) US  
 (88) US  
 (89) US  
 (81) III. AL, AM, AZ, BA, BN, BW, BX, BY, BZ, CA, CH, EG, EM, ES, GB, GE, GH, HR, IL, IS, JP, KG, KH, KP, KR, LI, LV, MC, MD, ME, MK, MN, MX, NA, NO, OA, OM, RS, RU, RW, SG, SM, ST, SY, TJ, TM, TN, TR, UA, VN, WS  
 (72) Joseph Cole MCGOWAN  
 360 SW Bond St. Ste 310, 97702, Bend, OR (US)  
 (74) Paul G. Johnson / MASCHOFF BRENNAN  
 1389 Center Drive, Suite 300, 84098 Park City, UT (US)  
 (46) 2022 10 28  
 (54) 1.-2. STAND OR GRIP ACCESSORY FOR MOBILE DEVICE  
 (55)

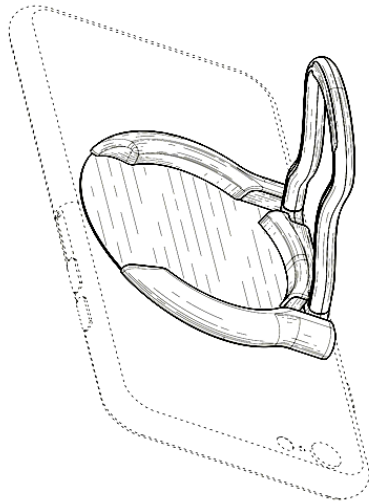

1.1

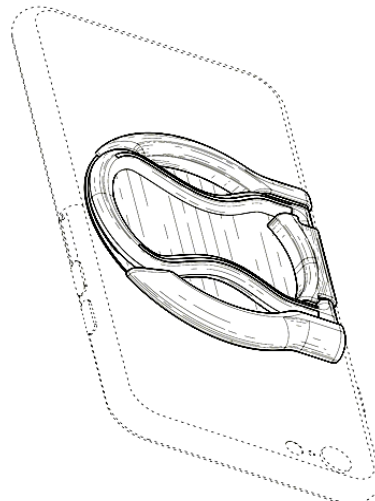

1.2

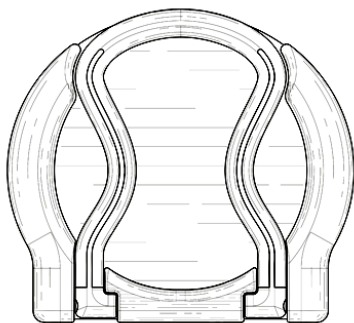

1.3

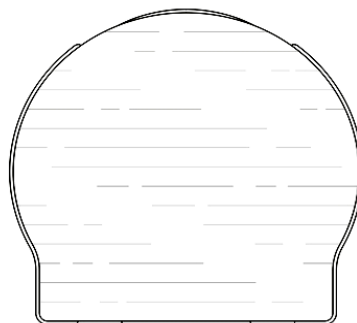

1.4



1.5



1.6



1.7



1.8

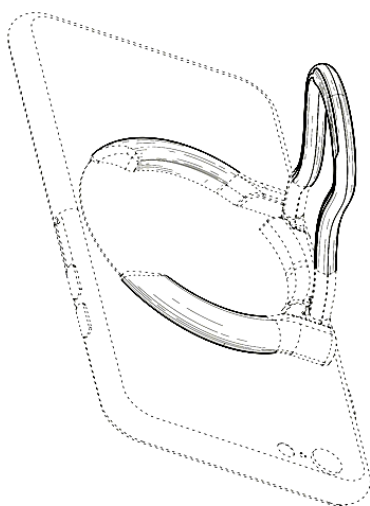

2.1

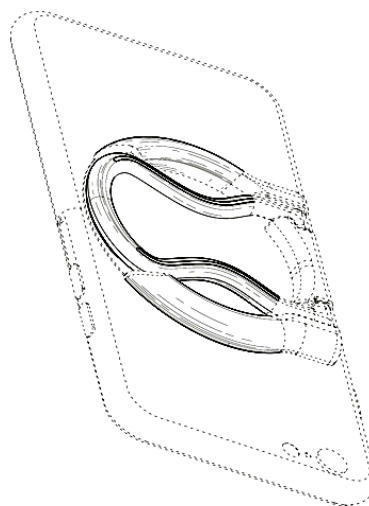

2.2

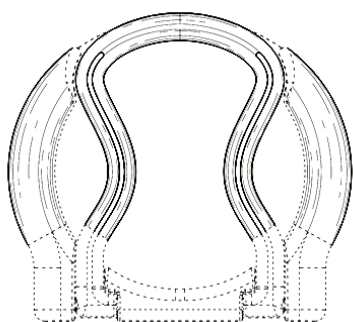

2.3

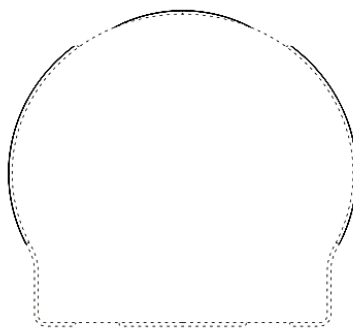

2.4



2.5



2.6



2.7

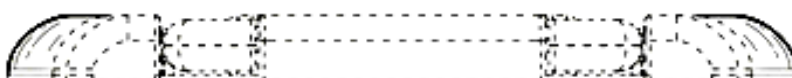

2.8

---

# TRADEMARKS

## APPLICATIONS FILED UNDER THE NATIONAL PROCEDURE APPROVED FOR REGISTRATION

The decision can be appealed at the Chamber of Appeal of Sakpatenti within 3 months from the publication or at the Mtskheta District Court Administrative Cases Board (Address: №17, Samkhedro St., Mtskheta), within 1 month following the publication.

(260) AM 2022 117272 A  
(210) AM 117272  
(220) 2022 03 28  
(731) Philip Morris Brands Sàrl  
Quai Jeanrenaud 3, 2000 Neuchâtel,  
Switzerland  
(740) Pavle Meipariani  
(540)

**TWIST**

(591) Black-white  
(511) 34

---

(260) AM 2022 117308 A  
(210) AM 117308  
(220) 2022 04 04  
(731) Bilim İlaç Sanayi Ve Ticaret Anonim Şirketi  
Kaptanpaşa Mahallesi, Zincirlikuyu Caddesi,  
No:184 Beyoglu, Istanbul, Türkiye  
(740) Giorgi Kartvelishvili  
(540)

**BIMAKS**

(591) Black-white  
(511) 5

---

(260) AM 2022 117433 A  
(210) AM 117433  
(220) 2022 04 11  
(731) LTD "Nagoberi 1"  
Ilia Chavchavadze Ave. 83b, ap. 22, Tbilisi,  
Georgia  
(540)



(591) White, black, green  
(531) 26.13.25; 27.05.04; 27.05.10; 27.05.21;  
29.01.12  
(511) 29, 31, 32

---

(260) AM 2022 117613 A  
(210) AM 117613  
(220) 2022 04 26  
(731) Dezhou Chen  
Xingmin Street, Longgang Town, Cangnan  
County, Zhejiang Province, People's Republic  
of China  
(740) Giorgi Kartvelishvili  
(540)

**V I P O L O W E E T**

(591) Black-white  
(531) 27.05.01  
(511) 25

---

(260) AM 2022 117623 A  
(210) AM 117623  
(220) 2022 04 28  
(731) JSC "FoodMart"  
Tengiz Chantladze Str. 40, Didi Lilo, Tetri  
Khevi Settlement, 0109, Samgori  
District, Tbilisi, Georgia  
(540)



(591) F9F8F2 milky white, A6D196 green  
(531) 10.03.10; 10.03.11; 28.19; 29.01.12  
(511) 16, 29, 30, 31, 32

---

(260) AM 2022 117625 A  
(210) AM 117625  
(220) 2022 04 29  
(731) LTD "Fastpay"  
P. Kavtaradze Str. 25 bld. 4, ap. 63, 0186,  
Saburtalo District, Tbilisi, Georgia  
(540)



(591) Golden, black, white  
(531) 20.05.16; 26.01.01; 26.01.04; 26.04.02;  
26.04.10; 26.04.24; 27.05.01; 29.01.13  
(511) 41

---

(260) AM 2022 117650 A  
 (210) AM 117650  
 (220) 2022 04 29  
 (731) Nikoloz Ghvinadze  
 Melikishvili Str. 10, floor 7, 0179, Tbilisi,  
 Georgia  
 (740) Sopio Panjikidze  
 (540)

**სადარბო**

(591) Black-white  
 (511) 33, 43

(260) AM 2022 117651 A  
 (210) AM 117651  
 (220) 2022 04 30  
 (731) LTD "Luis Coffee"  
 Rustavi Highway 267, bld. 7-2, flat 20,  
 0165, Tbilisi, Georgia  
 (540)



(591) F4F4F4 white, 211F20 black, 753802  
 brown, D1AA67 light brown  
 (531) 05.07.01; 05.07.27; 24.09.07; 27.05.01;  
 27.05.11; 27.05.24; 29.01.14  
 (511) 30

(260) AM 2022 117659 A  
 (210) AM 117659  
 (220) 2022 05 03  
 (731) LTD "Lumenium"  
 Moscow Ave. 9a, Block B, ap. 214,  
 Samgori District, Tbilisi, Georgia  
 (540)

**ნათელი  
 light**

(591) Black-white  
 (511) 32

(260) AM 2022 117664 A  
 (210) AM 117664  
 (220) 2022 05 04  
 (731) LTD "Daily Organics"  
 Tsotne Dadiani Str. 303, 0179, Tbilisi,  
 Georgia

(540)



(591) Pink, white  
 (531) 26.13.25; 27.05.01; 27.05.09; 27.05.10;  
 27.05.24; 29.01.12  
 (511) 5, 29, 30

(260) AM 2022 117669 A  
 (210) AM 117669  
 (220) 2022 05 05  
 (731) LLC "JettyCloud"  
 Nutsbidze Plateau, II mcr., IV qu., bld. 2,  
 ap. 76, Tbilisi, Georgia  
 (740) Giorgi Taktakishvili  
 (540)



(591) Sky-blue, blue, white  
 (531) 26.11.05; 26.11.12; 26.11.13; 27.05.01;  
 29.01.04  
 (511) 9, 38, 42

(260) AM 2022 117670 A  
 (210) AM 117670  
 (220) 2022 05 05  
 (731) LTD "Fastpay"  
 P. Kavtaradze Str. 25 bld. 4, ap. 63, 0186,  
 Saburtalo District, Tbilisi, Georgia  
 (540)



(591) Golden, black, white  
 (531) 20.05.16; 26.01.01; 26.01.24; 26.04.10;  
 26.04.24; 26.11.22; 29.01.13  
 (511) 41

(260) AM 2022 117711 A  
 (210) AM 117711  
 (220) 2022 05 06  
 (731) LTD "Georgian Distribution and Logistics"  
 Marshal Gelovani Ave. 2, 0159, Saburtalo  
 District, Tbilisi, Georgia  
 (740) Mariam Khurtsilava

(540)

**ტიციანი**  
**Titsiani**

(591) Black-white  
(511) 33

(260) AM 2022 117720 A  
(210) AM 117720  
(220) 2022 05 06  
(731) I/E Davit Katamadze  
Vazha-Pshavela Ave. 44, Tbilisi, Georgia  
(540)



(591) Black, red, yellow, white  
(531) 07.01.09; 14.07.06; 14.07.09; 14.07.15;  
14.07.16; 14.07.23; 28.19; 29.01.14  
(511) 37

(260) AM 2022 117721 A  
(210) AM 117721  
(220) 2022 05 06  
(731) LTD "Gunda"  
M. Tamarashvili Str. 11, ap. 141, Tbilisi,  
Georgia  
(740) Giorgi Taktakishvili  
(540)



(591) Black-white  
(531) 27.05.01; 27.05.09  
(511) 29, 30, 32, 33, 43

(260) AM 2022 117727 A  
(210) AM 117727  
(220) 2022 05 10  
(731) LTD "Agronom"  
B. Kvernadze Str. 35, II Lane, fl. 3, 0171,  
Tbilisi, Georgia  
(540)

**Agro Life Science Corporation**  
**Агро Лайф Сайенс Корпорейшн**  
**აგრო ლაიფ საიენს კორპორეიშენ**

(591) Black-white  
(511) 5

(260) AM 2022 117730 A  
(210) AM 117730  
(220) 2022 05 10  
(731) LTD "Agronom"  
B. Kvernadze Str. 35, II Lane, fl. 3, 0171,  
Tbilisi, Georgia  
(540)

**Vista**  
**Виста**  
**ვისტა**

(591) Black-white  
(511) 5

(260) AM 2022 117733 A  
(210) AM 117733  
(220) 2022 05 10  
(731) LTD "Agronom"  
B. Kvernadze Str. 35, II Lane, fl. 3, 0171,  
Tbilisi, Georgia  
(540)

**Uniagro**  
**Униагро**  
**უნიაგრო**

(591) Black-white  
(511) 5

(260) AM 2022 117805 A  
(210) AM 117805  
(220) 2022 05 13  
(731) UCC Holdings Co., LTD.  
6-Go, 1-Ban, 5-Chome, Tamondori, Chuo-  
Ku, Kobe-Shi, Hyogo-Ken, Japan  
(740) Shalva Gvaramadze  
(540)



(591) Black-white  
(531) 27.05.01; 27.05.09; 27.05.17  
(511) 30

(260) AM 2022 117807 A  
(210) AM 117807  
(220) 2022 05 14  
(731) JSC "Gefa"  
Akaki Beliashvili Str. 142, 0159, Tbilisi,  
Georgia

(740) Salome Jeladze  
(540)

**CORDAM 7**  
**კორდამ 7**

(591) Black-white  
(511) 5

(260) AM 2022 117808 A  
(210) AM 117808  
(220) 2022 05 14  
(731) JSC "Gefa"  
Akaki Beliashvili Str. 142, 0159, Tbilisi,  
Georgia  
(740) Salome Jeladze  
(540)

**CORDABALANS**  
**კორდაბალანსი**

(591) Black-white  
(511) 5

(260) AM 2022 117814 A  
(210) AM 117814  
(220) 2022 05 16  
(731) LTD "Mermisi"  
Davit Aghmashenebeli Ave. 142, Tbilisi,  
Georgia  
(740) Giorgi Taktakishvili  
(540)

**DoxoPegyl**

(591) Black-white  
(511) 5

(260) AM 2022 117818 A  
(210) AM 117818  
(220) 2022 05 16  
(731) LTD "Constructions"  
Otar Lortkipanidze Str. 12, ap. 4, 0114,  
Vake District, Tbilisi, Georgia  
(740) Ioane Iarajuli;  
Lia Shikhiashvili;  
Zurab Bezhashvili  
(540)



(591) Dark green, white, grey  
(531) 26.04.01; 26.04.18; 26.04.24; 27.05.01;  
27.05.22; 27.05.24; 28.19; 29.01.13  
(511) 36, 37, 42

(260) AM 2022 117824 A  
(210) AM 117824  
(220) 2022 05 17  
(731) LTD "Matanat"  
Saurtalo Str. 38, 0160, Tbilisi, Georgia  
(740) Kakhaber Tsertsvadze  
(540)

**KAF ÇİM**

(591) 050404 black-white  
(511) 2, 17, 19, 35, 37, 39

(260) AM 2022 117825 A  
(210) AM 117825  
(220) 2022 05 17  
(731) LTD "Matanat"  
Saurtalo Str. 38, 0160, Tbilisi, Georgia  
(740) Kakhaber Tsertsvadze  
(540)

**LASKOL**

(591) 050404 black-white  
(511) 2, 17, 19, 35, 37, 39

(260) AM 2022 117826 A  
(210) AM 117826  
(220) 2022 05 17  
(731) LTD "Matanat"  
Saurtalo Str. 38, 0160, Tbilisi, Georgia  
(740) Kakhaber Tsertsvadze

(540)

**ALKOR**

(591) White, EA0941 red  
(511) 2, 17, 19, 35, 37, 39

(260) AM 2022 117827 A  
(210) AM 117827  
(220) 2022 05 17  
(731) LTD "Matanat"  
Saurtalo Str. 38, 0160, Tbilisi, Georgia  
(740) Kakhaber Tsertsvadze  
(540)

**NAT**

(591) Black-white  
(511) 2, 17, 19, 35, 37, 39

(260) AM 2022 117828 A  
(210) AM 117828  
(220) 2022 05 17  
(731) LTD "Matanat"  
Saurtalo Str. 38, 0160, Tbilisi, Georgia  
(740) Kakhaber Tsertsvadze  
(540)

**VINKOL**

(591) Black-white  
(511) 2, 17, 19, 35, 37, 39

(260) AM 2022 117830 A  
(210) AM 117830  
(220) 2022 05 17  
(731) Joint-Stock Company "Multon"  
14 Sofiyskaya ul., St. Petersburg, 192236,  
Russian Federation  
(740) Giorgi Taktakishvili  
(540)

**BOTANIQ**

(591) Black-white  
(511) 5, 32

(260) AM 2022 117833 A  
(210) AM 117833  
(220) 2022 05 18  
(731) LTD "Caru"  
Vill. Tchala, VII Lane 3, Sachkhere Region,  
Georgia  
(540)



(591) White, blue  
(531) 25.03.01; 25.03.03; 27.05.24; 29.01.12  
(511) 35, 36, 37, 39

(260) AM 2022 117836 A  
(210) AM 117836  
(220) 2022 05 18  
(731) LTD "Chirina"  
Lado Gudiashvili Str. 9, 0105, Tbilisi,  
Georgia  
(540)



(591) DDF716 yellow, 0C0202 black, 267C25  
green, brown, badge  
(531) 02.09.14; 05.03.08; 05.03.20; 25.01.19;  
26.01.15; 29.01.13  
(511) 1



(260) AM 2022 117839 A  
 (210) AM 117839  
 (220) 2022 05 19  
 (731) JSC "Digital Area"  
 Beijing (Pekini) Str. 41, Tbilisi, Georgia  
 (540)



(591) 3D1877 lilac, FF6257 red, 4563FF blue  
 (531) 26.01.01; 26.01.12; 26.02.01; 26.02.03;  
 26.02.07; 26.02.24; 27.05.01; 27.05.17;  
 29.01.13  
 (511) 9, 42

(260) AM 2022 117841 A  
 (210) AM 117841  
 (220) 2022 05 19  
 (731) Mikheil Berishvili  
 Shota Modebadze Str. 66, 3700, Rustavi,  
 Georgia  
 (540)



(591) Orange, yellow, white, black  
 (531) 11.03.03; 11.03.07; 26.04.03; 26.04.04;  
 26.04.18; 26.04.22; 26.04.24; 26.11.03;  
 26.11.05; 26.11.08; 27.05.11; 27.05.22;  
 27.05.24; 29.01.14  
 (511) 32, 43

(260) AM 2022 117845 A  
 (210) AM 117845  
 (220) 2022 05 19  
 (731) LTD "M<sup>2</sup> Group"  
 Al. Kazbegi Ave. 15, 0179, Tbilisi, Georgia  
 (540)



(591) F7941D orange, white  
 (531) 02.01.23; 26.04.01; 26.04.18; 27.05.01;  
 28.19; 29.01.01  
 (511) 36, 37

(260) AM 2022 117900 A  
 (210) AM 117900  
 (220) 2022 05 20  
 (731) British American Tobacco (Brands) Inc.  
 (a Delaware corporation)  
 251 Little Falls Drive, Suite 100, Wilming-  
 ton, Delaware, 19808-1674, USA  
 (740) Tamar Kochlamazashvili  
 (540)



(591) Black, grey  
 (531) 26.04.02; 26.04.22; 26.04.24; 27.05.01;  
 27.05.09; 27.05.17; 27.05.24; 27.07.17;  
 27.07.24; 29.01.12  
 (511) 34

(260) AM 2022 117901 A  
 (210) AM 117901  
 (220) 2022 05 20  
 (731) LLC "Grand Candy"  
 31 Masis Str., 0061, Yerevan, Armenia  
 (740) Giorgi Taktakishvili  
 (540)



(591) White, yellow, red, sky-blue, green, blue,  
 orange, crimson, purple, lilac, brown, golden  
 (531) 25.07.25; 26.01.05; 27.05.02; 29.01.15  
 (511) 30

(260) AM 2022 117902 A  
 (210) AM 117902  
 (220) 2022 05 20  
 (731) JSC "FoodMart"  
 Tengiz Chantladze Str. 40, Didi Lilo, Tetri

Khevi Settlement, 0109, Samgori  
District, Tbilisi, Georgia

(540)



(591) FFFFFFF white, F40E1A red, black  
(511) 35

(260) AM 2022 117903 A

(210) AM 117903

(220) 2022 05 20

(731) JSC "FoodMart"

Tengiz Chantladze Str. 40, Didi Lilo, Tetri  
Khevi Settlement, 0109, Samgori  
District, Tbilisi, Georgia

(540)



(591) FFFFFFF white, F40E1A red, black  
(511) 35

(260) AM 2022 117906 A

(210) AM 117906

(220) 2022 05 20

(731) Shenzhen MicroBT Electronics Technology  
Co., LTD.

Unit 801, Hangsheng Science & Technology  
Tower, Gaoxin South 6th Road, Nanshan  
District, Shenzhen, People's Republic of  
China

(740) Giorgi Kartvelishvili

(540)

**MICROBT**

(591) Black-white

(511) 9

(260) AM 2022 117907 A

(210) AM 117907

(220) 2022 05 20

(731) Shenzhen MicroBT Electronics Technology  
Co., LTD.

Unit 801, Hangsheng Science & Technology  
Tower, Gaoxin South 6th Road, Nanshan  
District, Shenzhen, People's Republic of  
China

(740) Giorgi Kartvelishvili

(540)



(591) Blue, orange

(531) 26.04.09; 27.05.07; 27.05.08; 27.05.09;  
27.05.10; 29.01.12

(511) 9

(260) AM 2022 117910 A

(210) AM 117910

(220) 2022 05 23

(731) LTD "PharmaHub"

Akaki Tsereteli Ave. 116, 0101, Didube  
District, Tbilisi, Georgia

(740) Davit Chikhladze

(540)

**ტონოქსო**

**TONOXO**

**ТОНОКСО**

(591) Black-white

(511) 5

(260) AM 2022 117914 A

(210) AM 117914

(220) 2022 05 23

(731) Davit Shvelidze

Nutsubidze Plateau, II mcr., V qu., bld. 5,  
ap. 22, 0179, Tbilisi, Georgia

(540)

**ლარლა**

(591) Black-white

(511) 43

(260) AM 2022 117916 A

(210) AM 117916

(220) 2022 05 23

(731) LTD "PharmaHub"

Akaki Tsereteli Ave. 116, 0101, Didube  
District, Tbilisi, Georgia

(740) Davit Chikhladze

(540)

**აპრომაქს**

**APROMAX**

**АИПРОМАКС**

(591) Black-white

(511) 5

(260) AM 2022 117917 A

(210) AM 117917

(220) 2022 05 23

(731) LTD "PharmaHub"

Akaki Tsereteli Ave. 116, 0101, Didube  
District, Tbilisi, Georgia

(740) Davit Chikhladze

(540)

ოქსიკალი  
**OXYCAL**  
**ОКСИКАЛ**

(591) Black-white

(511) 5

(260) AM 2022 117918 A

(210) AM 117918

(220) 2022 05 23

(731) LTD "PharmaHub"

Akaki Tsereteli Ave. 116, 0101, Didube  
 District, Tbilisi, Georgia

(740) Davit Chikhladze

(540)

ინტრიკალი  
**INTRICAL**  
**ИНТРИКАЛ**

(591) Black-white

(511) 5

(260) AM 2022 117920 A

(210) AM 117920

(220) 2022 05 24

(731) Tornike Mchedlishvili

Panaskerteli Str. 18a, ap. 13, Tbilisi, Georgia

(540)

**NUSHI**  **ნუში**

(591) Green, brown

(531) 05.07.06; 27.05.01; 28.19; 29.01.12

(511) 29, 31

(260) AM 2022 117922 A

(210) AM 117922

(220) 2022 05 24

(731) LTD "International American High School-  
College Progress"

Kipshidze Str. 7g, Office Space 7, 0162,  
 Vake-Saburtalo District, Tbilisi, Georgia

(740) Giorgi Batlidze

(540)

(591) FFFFFFF white, F9E49D, light beige,  
F29007 orange(531) 01.05.01; 01.17.04; 26.01.04; 26.01.10;  
26.01.20; 26.01.21; 29.01.12

(511) 41

(260) AM 2022 117925 A

(210) AM 117925

(220) 2022 05 25

(731) Alkaloid AD Skopje

Blvd. Aleksandar Makedonski 12, 1000

Skopje, The Republic of North Macedonia

(740) Shalva Gvaramadze

(540)

**MIRLEXO**

(591) Black-white

(511) 5

(260) AM 2022 117927 A

(210) AM 117927

(220) 2022 05 25

(731) Genadi Sulxanishvili

Mekhishvili Str. 14/46, Rustavi, Georgia

(540)



(591) Golden, black, white

(531) 03.09.01; 25.01.25; 26.04.02; 26.04.22;  
26.04.24; 27.05.01; 27.05.24; 29.01.13

(511) 35

(260) AM 2022 117929 A

(210) AM 117929

(220) 2022 05 25

(731) Colgate-Palmolive Company

Delaware Corporation

300 Park Avenue, New York, New York,

10022, USA

(740) Tamaz Shilakadze

(540)

(591) Red, orange, yellow, blue, green, dark blue,  
purple, golden(531) 26.01.04; 26.01.17; 26.01.19; 27.05.01;  
27.05.17; 27.07.01; 29.01.15

(511) 3, 21

(260) AM 2022 117976 A  
 (210) AM 117976  
 (220) 2022 05 27  
 (731) Muradi Ghoghadze  
 Chargali Str. 29, b. 27, Tbilisi, Georgia  
 (540)



(591) Green, yellow, black, white  
 (531) 01.15.15; 05.03.13; 05.03.15; 26.11.13;  
 27.05.11; 28.19; 29.01.14  
 (511) 29, 31

(260) AM 2022 117978 A  
 (210) AM 117978  
 (220) 2022 05 27  
 (731) Mars Incorporated  
 a Delaware corporation  
 6885 Elm Street, Virginia, McLean, 22101,  
 USA  
 (740) Tamar Kochlamazashvili  
 (540)



(591) Yellow, red, white  
 (531) 24.03.01; 27.05.01; 27.05.17; 27.05.24;  
 29.01.13  
 (511) 31

(260) AM 2022 117979 A  
 (210) AM 117979  
 (220) 2022 05 27  
 (731) The Procter & Gamble Company  
 One Procter & Gamble Plaza, Cincinnati,  
 Ohio 45202, USA  
 (540)

**AIRSOFT**

(591) Black-white  
 (531) 27.05.01  
 (511) 5

(260) AM 2022 117981 A  
 (210) AM 117981  
 (220) 2022 05 27  
 (731) Target Brands Inc.  
 1000 Nicollet Mall, Minneapolis, Minnesota  
 55403, USA  
 (740) Giorgi Taktakishvili  
 (540)

**CAT & JACK**

(591) Black-white  
 (511) 9, 14, 16, 18, 21, 25, 26, 28, 35

(260) AM 2022 117982 A  
 (210) AM 117982  
 (220) 2022 05 27  
 (731) Target Brands Inc.  
 1000 Nicollet Mall, Minneapolis, Minnesota  
 55403, USA  
 (740) Giorgi Taktakishvili  
 (540)

**GOODFELLOW & CO**

(591) Black-white  
 (511) 3, 4, 8, 9, 14, 16, 18, 21, 24, 25, 35

(260) AM 2022 117983 A  
 (210) AM 117983  
 (220) 2022 05 27  
 (731) Target Brands Inc.  
 1000 Nicollet Mall, Minneapolis, Minnesota  
 55403, USA  
 (740) Giorgi Taktakishvili  
 (540)



**all in motion**

(591) Black-white  
 (531) 26.11.03; 26.11.06; 26.11.12; 26.13.25  
 (511) 9, 10, 14, 16, 18, 21, 24, 25, 26, 27, 28, 35

(260) AM 2022 117990 A  
 (210) AM 117990  
 (220) 2022 05 28  
 (731) Mikheil Songhulashvili  
 Vill. Dighomi, Davit Aghmashenebeli Lane 2,  
 House 5, 0159, Tbilisi, Georgia

(740) Dimitri Dzamukashvili  
(540)

**სონღული**  
**Songuli**

(591) Black-white  
(511) 33

(260) AM 2022 117992 A  
(210) AM 117992  
(220) 2022 05 30  
(310) M2022/002922  
(320) 2022 04 26  
(330) RO  
(731) Nicoventures Holdings Limited  
Globe House 1 Water Street, London, WC2R  
3LA, United Kingdom  
(740) Tamar Kochlamazashvili  
(540)

**VUSE GRAPE ICE**

(591) Black-white  
(511) 34

(260) AM 2022 117993 A  
(210) AM 117993  
(220) 2022 05 30  
(310) M2022/002923  
(320) 2022 04 26  
(330) RO  
(731) Nicoventures Holdings Limited  
Globe House 1 Water Street, London, WC2R  
3LA, United Kingdom  
(740) Tamar Kochlamazashvili  
(540)

**VUSE WATERMELON  
ICE**

(591) Black-white  
(511) 34

(260) AM 2022 117994 A  
(210) AM 117994  
(220) 2022 05 30  
(310) M2022/002915  
(320) 2022 04 26  
(330) RO  
(731) Nicoventures Holdings Limited  
Globe House 1 Water Street, London, WC2R  
3LA, United Kingdom  
(740) Tamar Kochlamazashvili  
(540)

**VUSE BLUEBERRY ICE**

(591) Black-white  
(511) 34

(260) AM 2022 117995 A  
(210) AM 117995  
(220) 2022 05 30  
(310) M2022/002921  
(320) 2022 04 26  
(330) RO  
(731) Nicoventures Holdings Limited  
Globe House 1 Water Street, London, WC2R  
3LA, United Kingdom  
(740) Tamar Kochlamazashvili  
(540)

**VUSE STRAWBERRY  
ICE**

(591) Black-white  
(511) 34

(260) AM 2022 117996 A  
(210) AM 117996  
(220) 2022 05 30  
(310) M2022/002919  
(320) 2022 04 26  
(330) RO  
(731) Nicoventures Holdings Limited  
Globe House 1 Water Street, London, WC2R  
3LA, United Kingdom  
(740) Tamar Kochlamazashvili  
(540)

**VUSE MANGO ICE**

(591) Black-white  
(511) 34

(260) AM 2022 117997 A  
(210) AM 117997  
(220) 2022 05 30  
(310) M2022/002914  
(320) 2022 04 26  
(330) RO  
(731) Nicoventures Holdings Limited  
Globe House 1 Water Street, London, WC2R  
3LA, United Kingdom  
(740) Tamar Kochlamazashvili  
(540)

**VUSE BERRY BLEND**

(591) Black-white  
(511) 34

(260) AM 2022 117998 A  
 (210) AM 117998  
 (220) 2022 05 30  
 (310) M2022/002908  
 (320) 2022 04 26  
 (330) RO  
 (731) Nicoventures Holdings Limited  
 Globe House 1 Water Street, London, WC2R  
 3LA, United Kingdom  
 (740) Tamar Kochlamazashvili  
 (540)

**VUSE BERRY  
 WATERMELON**

(591) Black-white  
 (511) 34

(260) AM 2022 117999 A  
 (210) AM 117999  
 (220) 2022 05 30  
 (731) Monster Energy Company  
 a Delaware Corporation  
 1 Monster Way, Corona, California 92879,  
 USA  
 (740) Natela Otariidze  
 (540)

**ASSAULT**

(591) Black-white  
 (511) 32

(260) AM 2022 118006 A  
 (210) AM 118006  
 (220) 2022 05 31  
 (731) LTD "Grano Pollo"  
 Anton Katalikosi Str. 8, Tbilisi, Georgia  
 (540)



(591) Red, yellow, black, orange  
 (531) 03.07.03; 26.04.02; 26.04.15; 26.04.24;  
 27.05.01; 27.05.24; 29.01.14  
 (511) 29, 30, 35

(260) AM 2022 118008 A  
 (210) AM 118008  
 (220) 2022 05 31  
 (731) Tamaz Bekauri  
 Otari Oniashvili Str. 89, b. 2, 0160, Tbilisi  
 Georgia

(740) Zurab Bezhashvili;  
 Ioane Iarajuli;  
 Lia Shikhiashvili  
 (540)

**ილტო  
 Iltō  
 ИЛТО**

(591) Black-white  
 (511) 33

(260) AM 2022 118009 A  
 (210) AM 118009  
 (220) 2022 05 31  
 (731) Tamaz Bekauri  
 Otari Oniashvili Str. 89, b. 2, 0160, Tbilisi  
 Georgia  
 (740) Zurab Bezhashvili;  
 Ioane Iarajuli;  
 Lia Shikhiashvili  
 (540)

**ბაწარა  
 Batsara  
 Бацара**

(591) Black-white  
 (511) 32, 33

(260) AM 2022 118012 A  
 (210) AM 118012  
 (220) 2022 06 01  
 (731) European University  
 Davit Guramishvili Ave. 76, 0141, Tbilisi,  
 Georgia  
 (540)



Journal of  
 Biomedical  
 and Medical  
 Sciences

(591) Blue, green, sky-blue  
 (531) 01.13.01; 01.13.15; 26.01.01; 26.01.12;  
 26.04.01; 26.04.10; 26.11.12; 27.05.01;  
 29.01.12  
 (511) 16

(260) AM 2022 118014 A  
 (210) AM 118014  
 (220) 2022 06 01  
 (731) LTD "Clean House"  
 Ksani Str. 36, 0141, Tbilisi, Georgia

(540)



(591) White, yellow, green, blue  
 (531) 05.03.15; 07.01.09; 26.01.02; 28.19; 29.01.14  
 (511) 3, 21, 35, 39

(260) AM 2022 118015 A  
 (210) AM 118015  
 (220) 2022 06 01  
 (731) The Procter & Gamble Company  
 One Procter & Gamble Plaza, Cincinnati,  
 Ohio 45202, USA

(540)

*Naturella*

(591) Black-white  
 (531) 05.05.04; 05.05.20; 27.05.01; 27.05.19  
 (511) 5

(260) AM 2022 118016 A  
 (210) AM 118016  
 (220) 2022 06 02  
 (731) Zarbee's Inc.  
 50 Old Field Road, Greenwich CT 06830,  
 USA

(740) Giorgi Taktakishvili

(540)

**ZARBEE'S**  
 INSPIRED BY NATURE

(591) Black-white  
 (531) 03.13.04; 27.05.01; 27.05.09; 27.05.10  
 (511) 3, 5

(260) AM 2022 118017 A  
 (210) AM 118017  
 (220) 2022 06 02  
 (731) Shalva Bebozhvili  
 Mrevlishvili Str. 4, 3300, Mtskheta, Georgia

(740) Dimitri Dzamukashvili  
 (540)

ნალია  
**NALIA**

(591) Black-white  
 (511) 29, 30, 35

(260) AM 2022 118020 A  
 (210) AM 118020  
 (220) 2022 06 02  
 (731) LTD "Khvanchkara"  
 Vill. Khvanchkara, 0420, Racha,  
 Ambrolauri Region, Georgia  
 (540)



A D O N I S O  
 ა დ ო ნ ი ს ო

(591) Black-white  
 (531) 07.01.24; 09.07.01; 09.07.17; 09.07.25;  
 26.13.25; 27.05.01; 27.07.01; 28.19  
 (511) 33

(260) AM 2022 118021 A  
 (210) AM 118021  
 (220) 2022 06 02  
 (731) Shishapresso S.A.L  
 Manhattan Building, 3rd Floor, 250 Sami Solh  
 Boulevard, Beirut, Lebanon

(540)

**SHISHAPRESSO**

(591) Black-white  
 (531) 27.05.01  
 (511) 34

(260) AM 2022 118022 A  
 (210) AM 118022  
 (220) 2022 06 02  
 (731) LLC "Alazani Winery"  
 Demetre Tavdadebuli Str. 3, 4800, Kvareli,  
 Georgia  
 (740) Giorgi Kartvelishvili



(540)



(591) Blue, dark grey, light grey, white, black  
 (531) 05.01.04; 05.01.05; 05.01.16; 19.07.01;  
 19.07.16  
 (511) 33

(260) AM 2022 118064 A  
 (210) AM 118064  
 (220) 2022 06 06  
 (310) 2021782627; 2021782634; 2021782638;  
 2021782642; 2021782657; 2021782667;  
 2021782674; 2021782686; 2021782691;  
 2021782696  
 (320) 2021 12 13  
 (330) RU  
 (731) GlaxoSmithKline Consumer Healthcare  
 (UK) IP Limited  
 980 Great West Road, Brentford, Middlesex,  
 TW8 9GS, United Kingdom  
 (740) Tamar Kochlamazashvili  
 (540)

**Халеон**

(591) Black-white  
 (531) 28.05  
 (511) 3, 5, 9, 10, 21, 29, 30, 32, 35, 36, 41, 42, 44

(260) AM 2022 118067 A  
 (210) AM 118067  
 (220) 2022 06 06  
 (731) LTD "Jos Group"  
 Sairme Str. 83, ap. 11, Tbilisi, Georgia

(740) Giorgi Jokharidze  
 (540)

**ჯობს**

(591) Black-white  
 (531) 28.19  
 (511) 33

(260) AM 2022 118069 A  
 (210) AM 118069  
 (220) 2022 06 06  
 (731) The Procter & Gamble Company  
 One Procter & Gamble Plaza, Cincinnati,  
 Ohio 45202, USA  
 (540)

**Naturella**

(591) Green, white  
 (531) 27.05.01; 27.05.19; 29.01.03  
 (511) 5

(260) AM 2022 118071 A  
 (210) AM 118071  
 (220) 2022 06 07  
 (731) LTD "Aqua Geo"  
 Vill. Misaktsieli, 3308, Mtskheta Region,  
 Georgia  
 (540)



(591) White, sky-blue, red  
 (531) 06.01.01; 06.01.04; 28.19; 29.01.13  
 (526) აქაგეო  
 (511) 32

(260) AM 2022 118079 A  
 (210) AM 118079  
 (220) 2022 06 09  
 (731) LTD "Lord Honey"  
 Vill. Akhalsopeli, Kvareli Region, Georgia



(540)



(591) Black, golden  
 (531) 03.13.01; 03.13.24; 24.09.02; 27.05.01;  
 27.05.22; 27.05.24; 29.01.12  
 (511) 30, 35

(260) AM 2022 118081 A  
 (210) AM 118081  
 (220) 2022 06 09  
 (731) LLC "ALL-P Group"  
 Mgaloblishvili Str. 13, 0160, Saburtalo  
 District, Tbilisi, Georgia

(540)



(591) BA3535 red, 999191 grey, FFFFFFF white  
 (531) 26.04.01; 26.04.07; 28.19; 29.01.12  
 (511) 37

(260) AM 2022 118082 A  
 (210) AM 118082  
 (220) 2022 06 09  
 (731) LLC "ALL-P Group"  
 Mgaloblishvili Str. 13, 0160, Saburtalo  
 District, Tbilisi, Georgia

(540)



(591) B24040 red, 999191 grey, FFFFFFF white  
 (531) 26.04.01; 26.04.07; 27.05.01; 27.05.10;  
 29.01.12  
 (511) 37

(260) AM 2022 118134 A  
 (210) AM 118134  
 (220) 2022 06 10  
 (731) Inpha LLP Representative Office in Georgia  
 Nearby Besiki Str. 4, (plot 46/10), 0108, Tbilisi,  
 Georgia

(540)

**რაბეზოლ**  
**რადეზოლო**  
**Rabezol**

(591) Black-white  
 (511) 5

(260) AM 2022 118135 A  
 (210) AM 118135  
 (220) 2022 06 10  
 (731) LTD "RaveStag"  
 Tama Chovelidze Str. 8, 0108, Tbilisi,  
 Georgia

(540)



(591) Green, pink, white, black  
 (531) 27.01.01; 27.05.01; 27.05.02; 27.05.05;  
 29.01.14  
 (511) 36

(260) AM 2022 118137 A  
 (210) AM 118137  
 (220) 2022 06 13  
 (731) LLC "PharmaHub"  
 Akaki Tsereteli Ave. 116, Didube District,  
 Tbilisi, Georgia  
 (740) Davit Chikhladze  
 (540)

**ბლოკიზონ**  
**BLOCKIZON**  
**БЛОКИЗОН**

(591) Black-white  
 (511) 5

(260) AM 2022 118145 A  
 (210) AM 118145  
 (220) 2022 06 14  
 (731) LTD "Aqua Geo"  
 Vill. Misaktsieli, 3308, Mtskheta Region,  
 Georgia

(540)



(591) Sky-blue, red, white

(531) 06.01.01; 06.01.04; 28.19; 29.01.13

(526) SNO

(511) 32

---

(260) AM 2022 118152 A

(210) AM 118152

(220) 2022 06 15

(731) Reckitt Health Pain (US) LLC  
399 Interpace Parkway, Parsippany, New  
Jersey, 07054, USA

(740) Liliana Darakhvelidze

(540)

**BIOFREEZE**

(591) Black-white

(511) 5

---

## REGISTERED TRADEMARKS

---

(111) M 2022 36167 R

(151) 2022 12 09

(181) 2032 12 09

(260) AM 2021 114699 A

(220) 2021 09 24

(732) UPL Corporation Limited  
5<sup>th</sup> Floor, Newport Building, Louis Pasteur  
Street, Port Louis, Mauritius

---

(111) M 2022 36174 R

(151) 2022 12 09

(181) 2032 12 09

(260) AM 2021 115118 A

(220) 2021 10 27

(732) Riello S.P.A.  
Via Ing. Pilade Riello, 7, 1-37048 Legnago,  
Verona, Italy

---

(111) M 2022 36189 R

(151) 2022 12 09

(181) 2032 12 09

(260) AM 2022 116220 A

(220) 2022 01 14

(732) LLC "Royal Home Luxury"  
Rustave Highway 19, bld. 3, Seat, fl. 1, Tbilisi,  
Georgia

---

(111) M 2022 36191 R

(151) 2022 12 13

(181) 2032 12 13

(260) AM 2021 112077 A

(220) 2021 03 09

(732) SC IP Limited  
Charter Place, 23-27 Seaton Place, St Helier,  
JE1 1JY, Jersey, United Kingdom

---

(111) M 2022 36192 R

(151) 2022 12 13

(181) 2032 12 13

(260) AM 2021 115124 A

(220) 2021 10 27

(732) Syngenta Participations AG  
Rosentalstrasse 67, 4058 Basel, Switzerland

---

(111) M 2022 36193 R

(151) 2022 12 13

(181) 2032 12 13

(260) AM 2021 115125 A

(220) 2021 10 27

(732) Syngenta Limited  
Syngenta Jealott's Hill International Research  
Centre, Bracknell, Berkshire RG42 6EY,  
United Kingdom

---

(111) M 2022 36194 R

(151) 2022 12 13

(181) 2032 12 13

(260) AM 2021 115515 A

(220) 2021 11 22

(732) Mixuebingcheng Co., LTD  
Room 16004, Block A, Hanhaibeijin Business  
Center, North 3rd Ring Wenhua Road, Jinshui  
District, Zhengzhou City, Henan Province,  
People's Republic of China

---

(111) M 2022 36195 R

(151) 2022 12 13

(181) 2032 12 13

(260) AM 2021 115516 A

(220) 2021 11 22

(732) Mixuebingcheng Co., LTD  
Room 16004, Block A, Hanhaibeijin Business  
Center, North 3rd Ring Wenhua Road, Jinshui  
District, Zhengzhou City, Henan Province,  
People's Republic of China

---

(111) M 2022 36196 R

(151) 2022 12 14

(181) 2032 12 14

(260) AM 2021 115599 A

(220) 2021 11 30

(732) Yanwen Hu  
1206RM, C/26 Building, GuiFangYuan BuJi  
Street, LongGang Dist, Shenzhen, People  
Republic of China

---

(111) M 2022 36197 R

(151) 2022 12 13

(181) 2032 12 13

(260) AM 2021 115600 A

(220) 2021 11 30

(732) Venhua Hu  
No. 28, Group 3, Fuxing Village Wubao Town,  
Gongjing Dist Zigong, Sichuan, People  
Republic of China

---

(111) M 2022 36218 R  
(151) 2022 12 13  
(181) 2032 12 13  
(260) AM 2021 113510 A  
(220) 2021 06 16  
(732) LTD "Ninea"  
Nino Zhvania Str. 28, app. 1, Tbilisi, Georgia

---

(111) M 2022 36219 R  
(151) 2022 12 14  
(181) 2032 12 14  
(260) AM 2022 116318 A  
(220) 2022 01 25  
(732) LLC "Autorider"  
Moscow Av., bld. 36e, app. 39, Tbilisi, Georgia

---

(111) M 2022 36220 R  
(151) 2022 12 14  
(181) 2032 12 14  
(260) AM 2022 116227 A  
(220) 2022 01 17  
(732) British American Tobacco (Brands) Inc.  
(a Delaware corporation)  
251 Little Falls Drive, Suite 100, Wilmington,  
Delaware, 19808-1674, USA

---

(111) M 2022 36221 R  
(151) 2022 12 14  
(181) 2032 12 14  
(260) AM 2022 116226 A  
(220) 2022 01 17  
(732) British American Tobacco (Brands) Inc.  
(a Delaware corporation)  
251 Little Falls Drive, Suite 100, Wilmington,  
Delaware, 19808-1674, USA

---

(111) M 2022 36222 R  
(151) 2022 12 14  
(181) 2032 12 14  
(260) AM 2022 116399 A  
(220) 2022 01 31  
(732) LTD "Rich Group"  
Vill. Mughanlo, Marneuli Region, Georgia

---

(111) M 2022 36223 R  
(151) 2022 12 14  
(181) 2032 12 14  
(260) AM 2022 116397 A  
(220) 2022 01 31  
(732) LTD "Rich Group"  
Vill. Mughanlo, Marneuli Region, Georgia

---

(111) M 2022 36224 R  
(151) 2022 12 15  
(181) 2032 12 15  
(260) AM 2022 116398 A  
(220) 2022 01 31  
(732) LTD "Rich Group"  
Vill. Mughanlo, Marneuli Region, Georgia

---

(111) M 2022 36225 R  
(151) 2022 12 14  
(181) 2032 12 14  
(260) AM 2022 116249 A  
(220) 2022 01 20  
(732) LLC "Master Ok"  
A. Beliashvili Str. 117, Didube District, Tbilisi,  
Georgia

---

(111) M 2022 36227 R  
(151) 2022 12 16  
(181) 2032 12 16  
(260) AM 2021 115533 A  
(220) 2021 11 25  
(732) Tp-Link Corporation Limited  
Room 901, 9/F, New East Ocean Centre,  
9 Science Museum Road, Tsim Sha Tsui,  
Kowloon, Hong Kong

---

(111) M 2022 36228 R  
(151) 2022 12 16  
(181) 2032 12 16  
(260) AM 2021 115605 A  
(220) 2021 12 01  
(732) Tp-Link Corporation Limited  
Room 901, 9/F, New East Ocean Centre,  
9 Science Museum Road, Tsim Sha Tsui,  
Kowloon, Hong Kong

---

(111) M 2022 36229 R  
(151) 2022 12 16  
(181) 2032 12 16  
(260) AM 2021 115535 A  
(220) 2021 11 25  
(732) Tp-Link Corporation Limited  
Room 901, 9/F, New East Ocean Centre,  
9 Science Museum Road, Tsim Sha Tsui,  
Kowloon, Hong Kong

---

(111) M 2022 36230 R  
(151) 2022 12 15  
(181) 2032 12 15  
(260) AM 2021 115536 A  
(220) 2021 11 25  
(732) Tp-Link Corporation Limited  
Room 901, 9/F, New East Ocean Centre,  
9 Science Museum Road, Tsim Sha Tsui,  
Kowloon, Hong Kong

---

(111) M 2022 36231 R  
(151) 2022 12 15  
(181) 2032 12 15  
(260) AM 2022 116316 A  
(220) 2022 01 25  
(732) LTD "AT"  
Zakaria Paliashvili Str. 47a, app. 1, 0179,  
Tbilisi, Georgia

---

(111) M 2022 36232 R  
(151) 2022 12 16  
(181) 2032 12 16  
(260) AM 2021 115413 A  
(220) 2021 11 15  
(732) Sanovel Ilaj Sanaii Ve Tijaret A. S.  
Istinye Mahallesi, Balabandere Caddesi No:14  
TR-34460 Sariyer, Istanbul, Turkey

---

(111) M 2022 36233 R  
(151) 2022 12 16  
(181) 2032 12 16  
(260) AM 2021 115407 A  
(220) 2021 11 15  
(732) Sanovel Ilaj Sanaii Ve Tijaret A. S.  
Istinye Mahallesi, Balabandere Caddesi No:14  
TR-34460 Sariyer, Istanbul, Turkey

---

(111) M 2022 36234 R  
(151) 2022 12 16  
(181) 2032 12 16  
(260) AM 2021 115409 A  
(220) 2021 11 15  
(732) Sanovel Ilaj Sanaii Ve Tijaret A. S.  
Istinye Mahallesi, Balabandere Caddesi No:14  
TR-34460 Sariyer, Istanbul, Turkey

---

(111) M 2022 36245 R  
(151) 2022 12 13  
(181) 2032 12 13  
(260) AM 2021 115993 A  
(220) 2021 12 29  
(732) Shenzhen YouMe Information Techno-  
logy Co., Ltd.  
201, Building B, Dianlian technology building,  
Nanhuan Avenue, Mashantou Community,  
Matian street, Guangming District, Shenzhen,  
518000, People Republic of China

---

## TRADEMARKS REGISTERED ACCORDING TO THE ACCELERATED PROCEDURE

The decision can be appealed at the Chamber of Appeal of Sakpatenti within 3 months from the publication.

(111) M 2022 36256 R  
(151) 2022 12 07  
(181) 2032 12 07  
(210) AM 120528  
(220) 2022 12 01  
(732) LTD "Georgian Airways"  
Airport Settlement 79, Tbilisi, Georgia  
(540)



(591) Red, white  
(531) 01.15.23; 26.04.13; 26.04.16; 27.05.01;  
29.01.12  
(511) 16, 35, 37, 39

(111) M 2022 36257 R  
(151) 2022 12 07  
(181) 2032 12 07  
(210) AM 120505  
(220) 2022 11 28  
(732) LTD "Georgia Airlines"  
Guram Panjikidze Str. 22, Block – "A",  
ap. 18, Tbilisi, Georgia  
(540)



(591) Light sky-blue, golden  
(531) 03.07.16; 03.07.24; 26.01.12; 26.01.15;  
26.11.12; 27.05.01; 27.05.23; 27.07.21;  
29.01.12  
(511) 37, 39

(111) M 2022 36258 R  
(151) 2022 12 07  
(181) 2032 12 07  
(210) AM 120529  
(220) 2022 12 01  
(732) Zurab Arabidze  
Al. Kazbegi Str. 70, Tbilisi, Georgia  
(740) Giorgi Kartvelishvili

(540)



(591) Black-white  
(531) 25.07.17; 26.04.02; 26.04.22; 26.04.24  
(511) 21, 25, 28, 33

(111) M 2022 36259 R  
(151) 2022 12 07  
(181) 2032 12 07  
(210) AM 120247  
(220) 2022 11 08  
(732) Obschestvo s Ogranichenoy  
Otvetsvennostyu "Franchaizi"  
Ul. Ivanovskaya, dom 17, litera A.,  
Pomeshchenie 7H, of. 1, St. Petersburg,  
192117, Russian Federation  
(740) Giorgi Taktakishvili  
(540)

## FEROMON

(591) Black-white  
(531) 27.05.01  
(511) 34, 43

(111) M 2022 36260 R  
(151) 2022 12 16  
(181) 2032 12 16  
(210) AM 120526  
(220) 2022 12 01  
(732) LTD "Avtandil Tskvitinidze"  
Davit Aghmashenebeli Ave. 175, 0112,  
Tbilisi, Georgia  
(540)



(591) 000000 black, FFFFFFFF white  
(531) 26.04.02; 26.04.22; 26.04.24; 27.05.01;  
27.05.24  
(511) 14, 18, 25, 35

(111) M 2022 36261 R  
 (151) 2022 12 16  
 (181) 2032 12 16  
 (210) AM 120620  
 (220) 2022 12 06  
 (732) LLC "Roniko"

Liakhvi Str. 9, 0192, Tbilisi, Georgia

(540)

შრატ პირალი  George Piralli

(591) 000000 black, FFFFFFF white  
 (531) 18.05.03; 18.05.10; 26.01.16; 27.05.01; 28.19  
 (511) 9

(111) M 2022 36262 R  
 (151) 2022 12 16  
 (181) 2032 12 16  
 (210) AM 120360  
 (220) 2022 11 16  
 (732) LTD "Vaporía"

Vazisubani Str. 14, Mansard 19, Isani-Samgori District, Tbilisi, Georgia

(540)



**Shor T**<sup>®</sup>

(591) Black-white  
 (531) 05.05.20; 26.01.05; 26.04.15; 26.04.22;  
 26.11.12; 27.05.01  
 (511) 34, 35

(111) M 2022 36263 R  
 (151) 2022 12 16  
 (181) 2032 12 16  
 (210) AM 120361  
 (220) 2022 11 16  
 (732) LTD "Vaporía"

Vazisubani Str. 14, Mansard 19, Isani-Samgori District, Tbilisi, Georgia

(540)



(591) White, grey  
 (531) 26.01.05; 26.04.05; 26.04.22; 26.04.24;  
 26.13.25  
 (511) 34, 35

(111) M 2022 36264 R  
 (151) 2022 12 16  
 (181) 2032 12 16  
 (210) AM 112691  
 (220) 2021 04 20  
 (732) Irakli Burdiladze

V. Abashidze Str. 10, 0114, Tbilisi, Georgia

(540)



(591) 0A0000 blue, 000000 golden, black  
 (531) 01.15.23; 01.15.24; 25.01.09; 25.01.19;  
 29.01.13  
 (511) 29, 30, 31, 32

(111) M 2022 36265 R  
 (151) 2022 12 16  
 (181) 2032 12 16  
 (210) AM 120601  
 (220) 2022 12 02  
 (732) LTD "Akhali Tbilisi"

Nearby Vazha-Pshavela Ave. 64, Tbilisi, Georgia

(540)



(591) White, black, yellow  
 (531) 07.01.24; 26.04.09; 26.11.03; 26.11.06; 28.19;  
 29.01.12  
 (526) თბილისი  
 (511) 35, 37

(111) M 2022 36266 R  
(151) 2022 12 19  
(181) 2032 12 19  
(210) AM 120611  
(220) 2022 12 05  
(732) LTD "Flatiko"  
Giorgi Leonidze Str. 2a, Area 7, fl. 5, Tbilisi,  
Georgia  
(540)



(591) Black, blue, white  
(531) 26.04.09; 27.01.01; 27.01.02; 27.05.01;  
27.05.21; 29.01.12  
(511) 36

---

(111) M 2022 36267 R  
(151) 2022 12 19  
(181) 2032 12 19  
(210) AM 120370  
(220) 2022 11 17  
(732) LTD "Georgian Agro Product"  
Chirnakhuli Str. 2, Tbilisi, Georgia  
(540)

პოპორელი

(591) FFFFFFFF black-white  
(511) 29, 30, 32

---

(111) M 2022 36268 R  
(151) 2022 12 19  
(181) 2032 12 19  
(210) AM 120599  
(220) 2022 12 02  
(732) Giorgi Chkonia  
26 Maisi Str. 17, ap. 7-8-9, 6010, Batumi,  
Georgia  
(540)



ცენტრალი  
CENTRAL

(591) Black-white  
(531) 07.01.23; 07.03.09; 07.05.05; 07.05.06;  
07.05.08; 07.11.25  
(511) 43

---



## INTERNATIONAL TRADEMARKS FOR WHICH A DECISION ON GRANTING PROTECTIONS IS TAKEN

The decision can be appealed at the Chamber of Appeal of Sakpatenti within 3 months from the publication or at the Mtskheta District Court Administrative Cases Board (Address: №17, Samkhedro St., Mtskheta), within 1 month following the publication.

(260) AM 2022 114957 A

(800) 1619417

(151) 2021 05 24

(891) 2021 05 24

(731) MEDİPOLİTAN SAĞLIK VE EĞİTİM  
HİZMETLERİ ANONİM ŞİRKETİ  
KOŞUYOLU MAH. ALİ DEDE, SOKAK  
NO. 7, KAT. 2-3, KOŞUYOLU, KADIKÖY,  
İSTANBUL, TR-34718, Türkiye

(540)



(591) Blue, grey

(531) 02.09.01; 26.03.23; 27.05.01; 29.01.13

(511)

41 – Education and training; arranging and conducting of conferences, congresses and seminars.

(260) AM 2022 115046 A

(800) 1620199

(151) 2021 07 15

(891) 2021 07 15

(731) Theravance Biopharma Ireland Limited  
Connaught House, 1 Burlington Road,  
Dublin, D04 C5Y6, Ireland

(540)



(591) Black, white

(531) 24.15.21; 26.13.25

(511)

42 – Scientific and technological services and research and design relating thereto; natural science services; scientific and technological services; testing, authentication and quality control.

(260) AM 2022 115268 A

(800) 1624019

(151) 2021 02 19

(891) 2021 02 19

(731) ELDOM Spółka z o.o.  
ul. Pawła Chromika 5a, PL-40-238 Katowice,  
Poland

(540)



(591) Red, white

(531) 26.01.18; 27.05.24; 29.01.12

(511)

8 – Electric curling tongs; non-electric curling irons; electric hair straightening irons; egg slicers, non-electric; cheese slicers [hand-operated]; hand-operated slicers; fruit segmenters; vegetable spiralizers, hand-operated; hand operated food dicers; french fry cutters; bread slicers [hand-operated]; vibrating blade shavers; electrical shavers for removing fuzz from fabric [hand instruments]; electric nasal hair trimmers; electric hair clippers; beard shaping tool; mustache and beard trimmers; electric hair clippers for personal use [hand instruments]; non-electric hair clippers; hair clippers for personal use, electric and non-electric; non-electric beard trimmers; electrical shavers for removing threads from fabric [hand instruments]; non-electric razors; razors; hair clippers; animal shearing implements; clippers for personal use [electric and non electric] (term considered too vague by the International Bureau – rule 13 (2) (b) of the Regulations); dog clippers; nail files, electric; nail files, non-electric; fingernail polishers, electric or non-electric; manicure sets; depilation appliances, electric and non-electric; depilation appliances; pedicure sets; manicure sets, electric; nail files, electric; hair cutting and removal implements; electrically operated hair clippers [hand instruments]; manicure and pedicure tools; hand tools for use in beauty care (term considered too vague by the International Bureau – rule 13 (2) (b) of the Regulations); electronic foot files; foot file roller heads for removing hardened skin; roller head refills for electronic nail files; foot files; hand tools for ex-

foliating skin (term considered too vague by the International Bureau – rule 13 (2) (b) of the Regulations); electronic devices used to exfoliate skin (term considered too vague by the International Bureau – rule 13 (2) (b) of the Regulations); hand-operated sharpening tools and instruments; knife sharpeners; knife sharpeners [hand operated tools]; sharpening steels; electric steam irons; temperature controlled electric flat irons.

10 – Heart rate monitoring apparatus; body fat monitors; physiotherapy and rehabilitation equipment (term considered too vague by the International Bureau – rule 13 (2) (b) of the Regulations); electric massage apparatus for household use; esthetic massage apparatus; physical therapy equipment; electric esthetic massage apparatus for household purposes; electric esthetic massage apparatus; electric massage apparatus for personal use; massage apparatus, electric or non-electric; masks and equipment for artificial respiration; respiratory therapy instruments; temperature measuring instruments for medical use; breast pumps.

21 – Clothes brushes; bath brushes; cosmetic utensils; cosmetic and toilet utensils; brushes; exfoliating brushes; non-electrical coffee grinders; non-electric coffee frothers (term considered too vague by the International Bureau – rule 13 (2) (b) of the Regulations); coffee filters, non-electric; shakers for spices; electric pet brushes; sonic oscillating brushes for skincare; brushes for pets; toothbrushes; dental cleaning articles; eyebrow brushes; eyelash brushes; interdental brushes for cleaning the teeth; apparatus for cleaning teeth and gums using high pressure water for home use; hot air hair brushes; lint removers, electric or non-electric; corkscrews, electric and non-electric; mills for household purposes, hand-operated; hot pots, not electrically heated; pots; blenders, non-electric, for household purposes; cocktail shakers; kitchen grinders, non-electric; coffee makers, non-electric; toothbrushes, electric; electric lint removers; household or kitchen utensils; portable cool boxes, non-electric; electric hair combs; electric rotating hair brushes; coffee pots not of precious metal; deep fryers, non-electric; non-electric plunger style coffee makers; couscous cooking pots, non-electric; food steamers, non-electric; stovetop popcorn poppers; serving pots; electric combs; battery operated lint removers; coffee grinders; pepper mills, hand-operated; spice grinders (non-electric -); salt mills; salt and pepper mills; grinders (non-electric -); portable beverage coolers; vacuum jugs (non-electric -); carpet-cleaning brushes; household utensils for cleaning, brushes and brush-making materials; pot cleaning brushes; scrubbing brushes; tableware, cookware and containers; fruit presses, non-electric, for household purposes; hand-operated food grinders; kitchen grinders, non-electric; non electric juice extractors; automobile wheel cleaning brushes; dishwashing brushes; hairbrushes; brushes for cleaning tanks and containers; carpet rakes; carpet

sweepers (non-electric -); articles for the care of clothing and footwear (term considered too vague by the International Bureau – rule 13 (2) (b) of the Regulations).

(260) AM 2022 115388 A

(800) 1625789

(151) 2021 02 23

(891) 2021 02 23

(731) ELDOM Spółka z o.o.

ul. Pawła Chromika 5a, PL-40-238 Katowice,  
Poland

(540)

## eldom

(591) Black, white

(511)

8 – Electric curling tongs; non-electric curling irons; electric hair straightening irons; egg slicers, non-electric; cheese slicers [hand-operated]; hand-operated slicers; fruit segmenters; vegetable spiralizers, hand-operated; hand operated food dicers; french fry cutters; bread slicers [hand-operated]; vibrating blade shavers; electrical shavers for removing fuzz from fabric [hand instruments]; electric nasal hair trimmers; electric hair clippers; beard shaping tool; mustache and beard trimmers; electric hair clippers for personal use [hand instruments]; non-electric hair clippers; hair clippers for personal use, electric and non-electric; non-electric beard trimmers; electrical shavers for removing threads from fabric [hand instruments]; non-electric razors; razors; hair clippers; animal shearing implements; clippers for personal use [electric and non electric]; dog clippers; nail files, electric; nail files, non-electric; fingernail polishers, electric or non-electric; manicure sets; depilation appliances, electric and non-electric; depilation appliances; pedicure sets; manicure sets, electric; nail files, electric; hair cutting and removal implements; electrically operated hair clippers [hand instruments]; manicure and pedicure tools; hand tools for use in beauty care (term considered too vague by the International Bureau – rule 13 (2) (b) of the Regulations); electronic foot files; foot file roller heads for removing hardened skin; roller head refills for electronic nail files; foot files; hand tools for exfoliating skin (term considered too vague by the International Bureau – rule 13 (2) (b) of the Regulations); electronic devices used to exfoliate skin (term considered too vague by the International Bureau – rule 13 (2) (b) of the Regulations); hand-operated sharpening tools and instruments; knife sharpeners; knife sharpeners [hand operated tools]; sharpening steels; electric steam irons; temperature controlled electric flat irons.

10 – Heart rate monitoring apparatus; body fat monitors; physiotherapy and rehabilitation equipment (term considered too vague by the International Bureau – rule 13 (2) (b) of the Regulations); electric mas-

sage apparatus for household use; esthetic massage apparatus; physical therapy equipment; electric esthetic massage apparatus for household purposes; electric esthetic massage apparatus; electric massage apparatus for personal use; massage apparatus, electric or non-electric; masks and equipment for artificial respiration; respiratory therapy instruments; temperature measuring instruments for medical use; breast pumps.

21 – Clothes brushes; bath brushes; cosmetic utensils; cosmetic and toilet utensils; brushes; exfoliating brushes; non-electrical coffee grinders; non-electric coffee frothers (term considered too vague by the International Bureau – rule 13 (2) (b) of the Regulations); coffee filters, non-electric; shakers for spices; electric pet brushes; sonic oscillating brushes for skincare; brushes for pets; toothbrushes; dental cleaning articles; eyebrow brushes; eyelash brushes; interdental brushes for cleaning the teeth; apparatus for cleaning teeth and gums using high pressure water for home use; hot air hair brushes; lint removers, electric or non-electric; corkscrews, electric and non-electric; mills for household purposes, hand-operated; hot pots, not electrically heated; pots; blenders, non-electric, for household purposes; cocktail shakers; kitchen grinders, non-electric; coffee makers, non-electric; toothbrushes, electric; electric lint removers; household or kitchen utensils; portable cool boxes, non-electric; electric hair combs; electric rotating hair brushes; coffee pots not of precious metal; deep fryers, non-electric; non-electric plunger style coffee makers; couscous cooking pots, non-electric; food steamers, non-electric; stovetop popcorn poppers; serving pots; electric combs; battery operated lint removers; coffee grinders; pepper mills, hand-operated; spice grinders (non-electric -); salt mills; salt and pepper mills; grinders (non-electric -); portable beverage coolers; vacuum jugs (non-electric -); carpet-cleaning brushes; household utensils for cleaning, brushes and brush-making materials; pot cleaning brushes; scrubbing brushes; tableware, cookware and containers; fruit presses, non-electric, for household purposes; hand-operated food grinders; kitchen grinders, non-electric; non electric juice extractors; automobile wheel cleaning brushes; dishwashing brushes; hairbrushes; brushes for cleaning tanks and containers; carpet rakes; carpet sweepers (non-electric -); articles for the care of clothing and footwear (term considered too vague by the International Bureau – rule 13 (2) (b) of the Regulations).

(260) AM 2022 116344 A

(800) 1640318

(151) 2021 12 17

(891) 2021 12 17

(731) Obschestvo s ogranichennoi otvetstvennost'yu  
"Laboratoriya sovremennogo zdorovya"  
ul. Khimzavodskaya, 11/20, Berdsk,  
RU-633004 Novosibirskaya oblast',  
Russian Federation

(540)

## PULSE BOX

(591) Black, white

(511)

5 – Acai powder dietary supplements; acne treatment preparations; adhesive bands for medical purposes; adhesive plasters; air deodorising preparations; air purifying preparations; albumin dietary supplements; albuminous foodstuffs for medical purposes; albuminous preparations for medical purposes; alginate dietary supplements; almond milk for pharmaceutical purposes; aloe vera preparations for pharmaceutical purposes; amino acids for medical purposes; anaesthetics; analgesics; antibacterial handwashes; antibacterial soap; antioxidant pills; antiseptic cotton; antiseptics; anti-uric preparations; appetite suppressant pills; appetite suppressants for medical purposes; asthmatic tea; babies' nappies; balms for medical purposes; barks for pharmaceutical purposes; bath salts for medical purposes; biological preparations for medical purposes; cachets for pharmaceutical purposes; capsules for medicines; casein dietary supplements; chemico-pharmaceutical preparations; chewing gum for medical purposes; chilblain preparations; cod liver oil; collagen for medical purposes; collyrium; contact lens cleaning preparations; corn remedies; decoctions for pharmaceutical purposes; deodorants for clothing and textiles; deodorants, other than for human beings or for animals; depuratives; dietary fiber; dietary supplements for animals; dietary supplements with a cosmetic effect; dietetic beverages adapted for medical purposes; dietetic foods adapted for medical purposes; dietetic substances adapted for medical use; digestives for pharmaceutical purposes; disinfectant soap; disinfectants for hygiene purposes; dressings, medical; drugs for medical purposes; elixirs [pharmaceutical preparations]; enzyme dietary supplements; enzyme preparations for medical purposes; eucalyptus for pharmaceutical purposes; febrifuges; ferments for pharmaceutical purposes; first-aid boxes, filled; flour for pharmaceutical purposes; food for babies; frostbite salve for pharmaceutical purposes; fumigation preparations for medical purposes; gauze for dressings; gelatine for medical purposes; glucose dietary supplements; glucose for medical purposes; hematogen; hemostatic pencils; herbal teas for medicinal purposes; homogenised food adapted for medical purposes; immunostimulants; infant formula; lacteal flour for babies; lactose for pharmaceutical purposes; laxatives; lecithin dietary supplements; liniments; linseed dietary supplements; linseed for pharmaceutical purposes; linseed oil dietary supplements; lotions for pharmaceutical purposes; lyophilised food adapted for medical purposes; magnesia for pharmaceutical purposes; medical preparations for slimming purposes; medicated after-shave lotions; medicated candies; medicated dry shampoos; medicated eye-washes; medicated hair lotions; medicated shampoos; medicated soap; medicated toiletry preparations; medicated toothpaste; medicinal drinks; medicinal hair growth preparations; medicinal herbs; medicinal infusions; medicinal mud;

medicinal oils; medicinal roots; medicinal tea; medicine cases, portable, filled; medicines for alleviating constipation; medicines for human purposes; milk ferments for pharmaceutical purposes; mineral food supplements; mineral waters for medical purposes; mouthwashes for medical purposes; mud for baths; mustard plasters; nervines; nutraceutical preparations for therapeutic or medical purposes; nutritional supplements; ointments for pharmaceutical purposes; organotherapy preparations; panty liners [sanitary]; pastilles for pharmaceutical purposes; pearl powder for medical purposes; personal sexual lubricants; petroleum jelly for medical purposes; pharmaceutical preparations for skin care; pharmaceutical preparations for treating dandruff; pharmaceutical preparations for treating sunburn; pharmaceutical preparations; pharmaceuticals; phytotherapy preparations for medical purposes; plant extracts for pharmaceutical purposes; pollen dietary supplements; pomades for medical purposes; poultices; powdered milk for babies; preparations for the treatment of burns; preparations of trace elements for human and animal use; propolis dietary supplements; propolis for pharmaceutical purposes; protein dietary supplements; protein supplements for animals; purgatives; remedies for perspiration; royal jelly dietary supplements; royal jelly for pharmaceutical purposes; salts for medical purposes; salts for mineral water baths; sanitary napkins; seawater for medicinal bathing; sedatives; tranquilizers; serums; sexual stimulant gels; slimming pills; solutions for contact lenses; styptic preparations; sugar for medical purposes; sunburn ointments; suppositories; syrups for pharmaceutical purposes; tanning pills; therapeutic preparations for the bath; thermal water; tissues impregnated with pharmaceutical lotions; tonics [medicines]; vitamin preparations; vitamin supplement patches; wadding for medical purposes; wheat germ dietary supplements; yeast dietary supplements; yeast for pharmaceutical purposes.

(260) AM 2022 116576 A

(800) 1643138

(151) 2021 06 09

(891) 2021 06 09

(731) ASYA PAMUK SANAYİ ÜRÜNLERİ VE PAZARLAMA TİCARET LİMİTED ŞİRKETİ MEHMET NESİH ÖZMEN MAH, SEMT ŞİMŞİR SK. 6 A, Güngören, İstanbul, Türkiye

(540)



(591) Lilac, dark lilac, orange, white

(531) 26.01.18; 26.13.01; 27.05.02; 29.01.13

(511)

3 – Make-up removers, skin cleaners [non-medicated], hand cleaners [hand cleaning preparations], colognes, pre-impregnated cleansing tissues, ear cleaning sticks, cotton buds for cosmetic use, cotton wool balls for cosmetic use, wet wipes, cotton balls for make-up, cotton discs for make-up, nail paint and varnishes.

5 – Breast pads, nursing pads, hydrophilic cotton, deodorants, air-purifying and deodorizing agents, excluding those for humans and animals, disinfectants, antiseptics (microbicide), medical detergents, medicated soaps, disinfecting soaps, antibacterial hand lotions, hygiene products, disposable pads for incontinence, feminine hygiene pads, tampons, medical patches, dressings, medical, diapers for children, adults and pets made of paper and textiles.

(260) AM 2022 116690 A

(800) 1644613

(151) 2021 12 31

(891) 2021 12 31

(731) Obschestvo s ogranitchennoy otvetstvennostyu "KDV Nizhny Tagil"

Frunze str., bld. 83, Nizhny Tagil, RU-622022

Sverdlovskaya oblast, Russian Federation

(540)

## Belucci

(591) Black, white

(511)

30 – Cereal bars; high-protein cereal bars; pancakes; buns; bread rolls; vareniki [stuffed dumplings]; waffles; natural sweeteners; binding agents for ice cream; seaweed [condiment]; malt biscuits; rice-based snack food; cereal-based snack food; fruit jellies [confectionery]; candy decorations for cakes; confectionery for decorating christmas trees; cakes; pastries; peanut confectionery; almond confectionery; quiches; sweets; liquorice [confectionery]; peppermint sweets; crackers; custard; corn, milled; corn, roasted; meat pies; lollipops [confectionery]; rice cakes; marzipan; dessert mousses [confectionery]; chocolate mousses; museli; mint for confectionery; crushed oats; husked oats; chocolate-coated nuts; stick liquorice [confectionery]; lozenges [confectionery]; biscuits; petit-beurre biscuits; pies; pizzas; fondants [confectionery]; popcorn; pralines; cereal preparations; oat-based food; gingerbread; petits fours; puddings; wheat germ for human consumption; confectionery; rusks; sushi; sandwiches; tarts; dough; pastry dough; almond paste; cake batter; tortillas; chocolate decorations for cakes; halvah; unleavened bread; corn flakes; oat flakes; chips [cereal products]; cheeseburgers [sandwiches]; chocolate; husked barley.

(260) AM 2022 116691 A  
 (800) 1644664  
 (151) 2021 10 18  
 (891) 2021 10 18  
 (731) Euro Games Technology Ltd.  
 4, "Maritsa" Str., "Vranya-Lozen-Triugulnika",  
 BG-1151 Sofia, Bulgaria

(540)

## Book of Versailles

(591) Black, white

(511)

9 – Software; computer gaming software; computer software packages; computer operating system software; computer software, recorded; software drivers; virtual reality software; games software; entertainment software for computer games; computer programs for network management; operating computer software for main frame computers; monitors (computer hardware); computer hardware; apparatus for recording images; monitors (computer programs); computer game programs; computer programs for recorded games; apparatus for recording, transmission or reproduction of sound or images; communications servers [computer hardware]; electronic components for gambling machines; computer application software featuring games and gaming; computer software for the administration of on-line games and gaming; computer hardware for games and gaming; hardware and software for gambling, gambling machines, gambling games on the Internet and via telecommunication network.

28 – Gaming machines for gambling; chips for gambling; mah-jong; arcade games; gambling machines operating with coins, notes and cards; games; electronic games; parlor games; gaming chips; gaming tables; slot machines [gaming machines]; LCD game machines; slot machines and gaming devices; coin-operated amusement machines; roulette chips; poker chips; chips and dice [gaming equipment]; equipment for casinos; roulette tables; gaming roulette wheels; casino games; automats and gambling machines; coin-operated machines and/or electronic coin-operated machines with or without the possibility of gain; boxes for coin-operated machines, slot machines, and gaming machines; electronic or electrotechnical gaming devices, automats and machines, coin-operated machines; housings for coin-operated machines, gaming equipment, gaming machines, machines for gambling; electropneumatic and electrical gambling machines (slot machines).

41 – Gambling; services related to gambling; gaming services for entertainment purposes; casino, gaming and gambling services; training in the development of software systems; provision of gaming equipment for gambling halls; providing casino equipment [gambling]; gaming machine entertainment services; providing casino facilities [gambling]; halls with gaming machines; amusement arcade services; games equip-

ment rental; rental of gaming machines; providing amusement arcade services; rental of gaming machines with images of fruits; editing or recording of sounds and images; sound recording and video entertainment services; hire of sound reproducing apparatus; provision of gaming equipment for casinos; providing of casino facilities; online gambling services; casino management services; operation of gaming establishments, gaming halls, internet casinos, online gambling sites.

(260) AM 2022 116692 A

(800) 1644665

(151) 2021 11 01

(891) 2021 11 01

(731) Eagleline Limited

The Victoria Centre, Unit 2, Lower Ground  
 Floor, Valletta Road, MST 9012 MOSTA,  
 Malta

(540)

## Sizzle Fire

(591) Black, white

(511)

9 – Games software; computer gaming software; software programs for video games; interactive video game programs; computer game cartridges; software; educational software; application software; community software; computer telephony software; interactive computer software; communication software; programs for computers; electronic components for gambling machines; games cartridges for use with electronic games apparatus; juke boxes, musical; computer game software for use with on-line interactive games; computer application software featuring games and gaming; interactive multimedia software for playing games.

28 – Electronic games; quiz games; apparatus for games; arcade games; lottery wheels; lottery tickets; slot machines [gaming machines]; coin-operated amusement machines; bill-operated gaming equipment; LCD game machines; counters [discs] for games; board games; amusement apparatus for use in arcades.

41 – Gambling services; organization of lotteries; games equipment rental; casino services; providing casino facilities; leasing of casino games; providing casino facilities [gambling]; providing of casino and gaming facilities; casino, gaming and gambling services; providing amusement arcade services; video arcade services.

(260) AM 2022 116693 A

(800) 1644668

(151) 2021 09 24

(891) 2021 09 24

(731) İYON SAĞLIK MEDİKAL KOZMETİK

İTHALAT İHRACAT VE SANAYİ TİCARET

ANONİM ŞİRKETİ  
Yukarı Dudullu Mahallesi İmes, Sanayi Sitesi  
B Blok 205. Sokak No:4, Ümraniye, İstanbul,  
Türkiye

(540)



(591) Black and red

(531) 26.11.12; 27.05.01; 27.05.08; 29.01.13

(511)

10 – Surgical, medical, dental and veterinary apparatus and instruments; furniture especially made for medical purposes; artificial limbs and prostheses; medical orthopaedic articles: corsets for medical purposes, orthopaedic shoes, elastic bandages and supportive bandages; surgical gowns and surgical sterile sheets; adult sexual aids; condoms; babies' bottles; babies' pacifiers; teats; teethers for babies.

(260) AM 2022 116695 A

(800) 1644816

(151) 2021 11 30

(891) 2021 11 30

(731) Bitcoinforme S.L.

Calle Germán Bernacer, 65, E-03203 Elche,  
Spain

(540)

## B2M Token

(591) Black, white

(511)

9 – Computer programs relating to financial transaction processing; software for managing monetary awards and bonus points using blockchain technology; computer software for cross blockchain transfers; computer software for blockchain solutions; e-commerce and e-payment software; blockchain technology software; computer software for blockchain technology and cryptocurrency; computer software for developing, building, and operating blockchain applications; computer software for electronic trading of virtual currencies; electronic financial software platform enabling payment and debt transactions in an integrated mobile phone and web-based environment; software for trading in securities and assets; day trading software; downloadable cryptographic keys for receiving and spending cryptocurrencies; software for carrying out online transactions; software for processing electronic payments to third parties, as well as for third parties; security tokens [encryption devices].

(260) AM 2022 116696 A

(800) 1644823

(151) 2021 12 07

(891) 2021 12 07

(731) Philip Morris Products S.A.

Quai Jeanrenaud 3, CH-2000 Neuchâtel,  
Switzerland

(540)

## OASIS PEARL

(591) Black, white

(511)

34 – Wired vaporizers for electronic cigarettes and electronic smoking devices; tobacco, raw or manufactured; tobacco products, including cigars, cigarettes, cigarillos, tobacco for roll-your-own cigarettes, pipe tobacco, chewing tobacco, snuff tobacco, kretek; snus; tobacco substitutes (not for medical purposes); smokers' articles, including cigarette paper and tubes, cigarette filters, tobacco tins, cigarette cases and ashtrays, pipes, pocket apparatus for rolling cigarettes, lighters; matches; tobacco sticks, tobacco products for the purpose of being heated, electronic devices and their parts for the purpose of heating cigarettes or tobacco in order to release nicotine-containing aerosols for inhalation; liquid nicotine solutions for use in electronic cigarettes; electronic smoking devices; electronic cigarettes; electronic cigarettes as substitutes for traditional cigarettes; electronic devices for the inhalation of nicotine-containing aerosol; oral vaporizing devices for smokers, tobacco products and tobacco substitutes; smokers' articles for electronic cigarettes; parts and fittings for the aforesaid products included in this class; devices for extinguishing heated cigarettes and cigars as well as heated tobacco sticks; electronic rechargeable cigarette cases.

(260) AM 2022 116697 A

(800) 1644865

(151) 2021 11 24

(891) 2021 11 24

(731) Public Joint Stock Company "Krasnyj Ocyabr"

ul. Malaya Krasnoselskaya, d. 7, str. 24,  
RU-107140 Moscow, Russian Federation

(540)

## УКРАЇН САХАР

(591) Black, white

(531) 28.05

(511)

30 – Star aniseed; pancakes; buns; waffles; sweets; cocoa; coffee; cinnamon [spice]; biscuits; capers; seasonings; caramels [sweets]; cereal preparations; fondants [confectionery]; cake powder; mint for confectionery; gingerbread; chewing gum; ice, natural or artificial; chips [cereal products]; corn flakes; pies; gro-



ats for human food; cocoa beverages with milk; pastilles [confectionery]; coffee beverages with milk; chocolate beverages with milk; pralines; sago; molasses for food; chocolate; marzipan; condiments; crackers; halvah; hominy grits; chocolate mousses; chocolate-based spreads; chocolate spreads containing nuts; mints for breath freshening.

(260) AM 2022 116699 A

(800) 1644982

(151) 2021 09 24

(891) 2021 09 24

(731) LANCEL INTERNATIONAL SA

Vicolo Nassetta 2, CH-6900 Lugano,

Switzerland

(540)

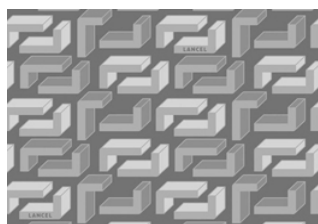

(591) Black, white

(531) 25.07.17; 27.05.01; 27.05.03; 27.05.08;

27.05.09; 27.05.10

(511)

18 – Luggage, bags, wallets and carrying bags including luggage covers, suitcases with wheels, carry-on suitcases, straps for suitcases, handles for suitcases, handbags, beach bags, bucket bags, bum bags, business card cases, card cases, clutch bags, credit card cases, crossbody bags, garment bags for travel, handbag frames, handbag straps, hat boxes of leather, key cases, labels of leather, leather luggage tags, music cases, pocket wallets, purses, backpacks, rucksacks; shoulder bags, shoulder belts of leather, toiletry bags sold empty, tote bags, travelling bags, travelling sets, vanity cases, not fitted, shaving bags sold empty, weekend bags, briefcases, briefcases that can be located via a global positioning system and mobile communications networks; umbrellas, umbrellas that can be located via a global positioning system and mobile communications networks; walking sticks; collars, leashes and clothing for animals.

(260) AM 2022 116700 A

(800) 1645130

(151) 2021 11 29

(891) 2021 11 29

(731) GROUPE ADEO

135 rue Sadi Carnot, CS 00001, F-59790

RONCHIN, France

(540)

**NATERIAL**

(591) Black, white

(511)

35 – Advertising; commercial business management; commercial administration; office functions; organization of exhibitions for commercial or advertising purposes; sales promotion for the benefit of others; retail services for the sale of goods in the field of DIY, namely, structures and transportable buildings, insulation and barrier articles and materials, artificial floor coverings for outdoor use, window coverings, coverings for renovating floor coverings other than paints or oils, flooring laying products, adhesives [glues], kitchen furniture for outdoor use, storage units [furniture], all the aforesaid goods for use in the field of DIY; retail services in relation to goods in the field of decoration, namely, decorative lighting and fixtures, decorative indoor and outdoor lighting fixtures, interior blinds, accessories for curtains and indoor blinds, curtains, Japanese panels and decorative netting, outdoor curtains, shading nets, sun screens for outdoor use, artificial foliage for outdoor use, claddings for walls, ceilings and floors, decorative wall slabs, cushions, lap robes, pouffes, furnishing fabrics, wall decorations, small furniture for decoration and furnishings, decorative objects, namely, picture frames, mirrors, mirror frames, clocks, statuettes, statues and figurines, art objects for ornamental and decorative use, vases, self-adhesive stickers, viatrophy articles, adhesive textile materials in the form of stickers, mountings, table decorations of paper, decorations of cardboard for foodstuffs, expanded plastic articles for use as bases for floral decorations, statues and works of art made of materials such as stone, concrete and marble, decorative elements specially adapted for indoor aquaria, festive decorations, floral decorations, dried plants for decoration, decorative elements made of materials such as stone, concrete and marble, decorative panels, plaques and works of art, ornaments [decorative objects], decoration and art materials and stands, illumination ornaments [candles], decorative illuminations, decorative baskets, all the aforesaid goods for use in the field of decoration; retail services for the sale of goods in the field of gardening, namely, gardening gloves, clothing for gardening, aprons for gardening, all the aforesaid goods for use in the field of gardening; retail services for the sale of garden sheds of metal, swimming pools (buildings of metal), swimming pool covers of metal, fencing, gratings and grilles of metal, entrance gates and wicket gates of metal, outdoor blinds of metal, slabs and paving blocks of metal, common metals and their alloys, metal building materials, transportable buildings of metal, materials of metal for railroad tracks, non-electric cables and wires, non-electric ironmongery, small items of metal hardware, screws and bolts, nails and nuts of metal, pipes of metal, safes, ores, boxes, chests and containers of metal, letter boxes (of metal), buildings of metal, verandas of metal, pergolas of metal, carports of metal, screening panels of metal, scaffolding of metal, railings and balusters of metal, art ob-

jects, statues or figurines (statuettes) in common metal, metal chimneys and metal spare parts for chimneys, non-electric cutlery, forks and especially barbecue forks, tongs and especially barbecue tongs, lighting fixtures, indoor and outdoor string lights, barbecues, barbecue grills and broilers, chimney starters for barbecues, roasting spits, gas patio heaters, apparatus for lighting, heating, steam generating, cooking, refrigeration, drying, ventilation, water supply and sanitary installations, air or water purifying apparatus and machines, air conditioning apparatus or installations, taps and fittings (except parts of machines or motors and taps for casks), sinks, parasols, leather and imitations of leather, trunks and suitcases, backpacks, bags or small bags (envelopes, pouches) for packaging (made of leather), umbrellas and walking sticks, garden sheds, not of metal, children's playhouses, swimming pools (constructions not of metal), swimming pool covers, not of metal, fencing, gratings and grilles, not of metal, entrance gates, not of metal, outdoor blinds not of metal nor of textile, paving slabs and paving blocks not of metal, floors not of metal, duckboards and floors of wood for terraces, buildings not of metal, verandas not of metal, pergolas not of metal, carports not of metal, arbours (building), railings and baluster not of metal, non-metallic building materials, screening panels not of metal, synthetic or natural privacy screens, outdoor blinds, not of metal nor of textile, sand (except foundry sand), gravel, stone, asphalt, pitch and bitumen, concrete, cement, plaster, coatings (building materials), binding agents for making briquettes, furniture and especially garden furniture, pergolas, cabinets, cupboards, doors and furniture shelves, fittings and furniture fittings (not of metal), chair pads, cushions, flower-pot pedestals, wardrobes, furniture partitions of wood, furniture casters (not of metal), display cases (furniture), pegs (hooks) for clothes not of metal, coat stands (not of metal), shelves, shelves for storage, supports for hammocks, cases, boxes, chests, caskets and containers of wood or plastic, wickerwork, looking glasses (mirrors), picture frames, bedding (except bed linen), art objects made of wood, wax, plaster, cork, reed, rushes, wicker, horn, bone, ivory, whalebone, shell, amber, mother-of-pearl, meerschaum and substitutes for all these materials, or of plastics, outdoor blinds of textile for terraces, verandas and pergolas, pottery, pots and window boxes, candle jars (lamps), cleaning equipment, brushes (except paint brushes) and especially barbecue brushes, kitchen utensils and containers, spatulas (kitchen utensils), tents, tarpaulins, hammocks, shade sails, covers for barbecues, protective covers for furniture, covers for parasols, games, toys, gymnastic and sporting articles (other than clothing, footwear and mats), garden games, especially slides, swings, sandboxes and swimming pools, physical training or gymnastics apparatus, Christmas trees of synthetic material, ornaments for Christmas trees (except illumination articles

and confectionery), natural Christmas trees, natural plants and flowers, artificial turf, mats for visual and wind protection, fuels (except motor spirit) and especially firewood and mineral coal, illuminants, candles and wicks for lighting, briquettes, gels and liquids for lighting for fires and barbecues.

---

(260) AM 2022 116701 A  
 (800) 1645164  
 (151) 2021 12 22  
 (891) 2021 12 22  
 (731) Wrangler Apparel Corp.  
 3411 Silverside Road, Wilmington DE 19810, USA  
 (540)

## WRANGLER ANGLER

(591) Black, white  
 (526) ANGLER  
 (511)  
 25 – Jeans; pants; shirts; shorts; vests; jackets; t-shirts.

---

(260) AM 2022 116702 A  
 (800) 1645241  
 (151) 2022 01 14  
 (891) 2022 01 14  
 (731) Accriva Diagnostics, Inc.  
 6260 Sequence Drive, San Diego CA 92121,  
 USA  
 (540)

## DIRECTCHECK

(591) Black, white  
 (511)  
 1 – Reagents for scientific and research use; reagents for scientific or medical research use; diagnostic reagents for clinical or medical laboratory use; diagnostic reagents for scientific or research use.  
 5 – Diagnostic reagents for medicinal use; medical diagnostic reagents; chemical reagents for medical or veterinary purposes; reagents for medical use.

---

(260) AM 2022 116703 A  
 (800) 1645243  
 (151) 2021 12 13  
 (891) 2021 12 13  
 (731) Philip Morris Brands Sàrl  
 Quai Jeanrenaud 3, CH-2000 Neuchâtel,  
 Switzerland  
 (540)





(591) White and gray  
 (531) 03.01.02; 24.07.01; 24.07.23; 24.09.03;  
 24.09.05; 25.01.06; 26.01.04; 26.01.18;  
 26.01.24; 26.13.25; 27.05.01; 27.05.08;  
 27.05.09; 27.05.10; 27.05.22; 27.05.24;  
 27.05.25

(511)  
 34 – Tobacco, raw or manufactured; tobacco products; cigars, cigarettes, cigarillos, tobacco for roll-your-own cigarettes, pipe tobacco, chewing tobacco, snuff tobacco, kretek; snus; tobacco substitutes (not for medical purposes); electronic cigarettes; tobacco products for the purpose of being heated; electronic devices and their parts for the purpose of heating cigarettes or tobacco in order to release nicotine-containing aerosol for inhalation; liquid nicotine solutions for use in electronic cigarettes; smokers' articles, cigarette paper, cigarette tubes, cigarette filters, tobacco tins, cigarette cases, ashtrays, pipes, pocket apparatus for rolling cigarettes, lighters, matches.

(260) AM 2022 116705 A  
 (800) 1645288  
 (151) 2021 11 26  
 (891) 2021 1 26  
 (731) Ursapharm Arzneimittel GmbH  
 Industriestr. 35, 66129 Saarbrücken, Germany  
 (540)



(591) Blue and white  
 (531) 26.04.04; 26.04.06; 26.04.18; 27.05.24;  
 29.01.12

(511)  
 5 – Pharmaceuticals; medical preparations; veterinary preparations; sanitary preparations for medical purposes; foodstuffs and dietetic substances for medical or veterinary purposes; food for babies; dietary supplements for human beings and animals; plasters, materials for dressings; dressings, medical; material for stopping teeth, dental wax; disinfectants; preparations for destroying noxious animals; fungicides; herbicides; contact lens wetting solutions; medicated creams; pharmaceutical creams; ophthalmological ointments; eye drops; ophthalmologic preparations.

10 – Surgical, medical, dental and veterinary apparatus and instruments; artificial limbs, eyes and teeth; orthopedic articles; suture materials; therapeutic and assistive devices adapted for persons with disabilities; massage apparatus; apparatus, devices and articles for nursing infants; sexual activity apparatus, devices and articles; containers with dosing devices for dispensing pharmaceutical products; medical instruments; chemi-

cally activated hot compresses for medical use; chemically activated hot gel packs for medical use; warmers for medical use.

(260) AM 2022 116706 A  
 (800) 1645319  
 (151) 2022 01 04  
 (891) 2022 01 04  
 (731) University of Miami  
 1320 S. Dixie Highway, Suite 1250, Coral  
 Gables FL 33146, USA

(540)



(591) Orange and green  
 (531) 27.05.01; 27.05.17; 27.05.21; 29.01.12  
 (511)

44 – Medical and health services, namely, providing hospital, clinical and surgical medical and health care services on an in-patient basis and out-patient basis.

(260) AM 2022 116708 A  
 (800) 1645394  
 (151) 2021 10 18  
 (891) 2021 10 18  
 (731) Euro Games Technology Ltd.  
 4, "Maritsa" Str., "Vranya-Lozen-Triugulnika",  
 BG-1151 Sofia, Bulgaria  
 (540)

## Book of Sparta

(591) Black, white  
 (511)

28 – Gaming machines for gambling; chips for gambling; mah-jong; arcade games; gambling machines operating with coins, notes and cards; games; electronic games; parlor games; gaming chips; gaming tables; slot machines [gaming machines]; LCD game machines; slot machines and gaming devices; coin-operated amusement machines; roulette chips; poker chips; chips and dice [gaming equipment]; equipment for casinos; roulette tables; gaming roulette wheels; casino games; automats and gambling machines; coin-operated machines and/or electronic coin-operated machines with or without the possibility of gain; boxes for coin-operated machines, slot machines and gaming machines; electronic or electrotechnical gaming devices, automats and machines, coin-operated machines; housings for coin-operated machines, gaming equipment, gaming machines, machines for gambling; electropneumatic and electrical gambling machines (slot machines).

41 – Gambling; services related to gambling; gaming services for entertainment purposes; casino, gaming and gambling services; training in the development of software systems; provision of gaming equipment for gambling halls; providing casino equipment [gambling]; gaming machine entertainment services; providing casino facilities [gambling]; halls with gaming machines; amusement arcade services; games equipment rental; rental of gaming machines; providing amusement arcade services; rental of gaming machines with images of fruits; editing or recording of sounds and images; sound recording and video entertainment services; hire of sound reproducing apparatus; provision of gaming equipment for casinos; providing of casino facilities; online gambling services; casino management services; operation of gaming establishments, gaming halls, internet casinos, online gambling sites.

(260) AM 2022 116713 A  
 (800) 1645576  
 (151) 2021 09 21  
 (891) 2021 09 21  
 (731) MONINI S.P.A.  
 Strada Statale 3 Flaminia Km 129 snc, I-06049  
 SPOLETO (PG), Italy  
 (540)



(591) Black, white  
 (531) 02.09.14; 05.07.19; 25.01.15; 27.05.01  
 (511)  
 29 – Edible fats and oils; flavoured oils; olive oil; olives, processed; olives, preserved; olive paste; olive purée; preserved, frozen, dried and cooked fruits and vegetables; jellies; jams; compotes; cheese dips; bean dips; fruit-based dips and garlic dips; pickles; eggs; milk and milk products; cheese; yogurt; meat, poultry and game; meat extracts; charcuterie; fish, not live.

30 – Vinegar; flavored vinegar; balsamic vinegar; sauces [condiments]; ready-made sauces; pasta sauce; pasta; pasta-based prepared meals; pot pies; cereal preparations; foodstuffs made from cereals; cereal-based snack food; bread and buns; bakery goods; pizzas; flour; pastries; confectionery; cakes; ice cream; honey; golden syrup; yeast; baking powder; salt; mustard; spices; coffee [roasted, powdered, granulated, or in drinks]; artificial coffee; tea; cocoa; sugar; rice; tapioca; sago; ice for refreshment.

(260) AM 2022 116724 A  
 (800) 1192248  
 (151) 2013 08 16  
 (891) 2021 12 17  
 (731) Ukrainian-Bulgarian "Pirana" Ltd.  
 3A Estakadnyi v'ezd, Kharkiv 61080, Ukraine  
 (540)



(591) Black, white  
 (531) 27.05.08  
 (511)  
 3 – Hair dyes; cosmetic dyes, hair colorants; color-removing preparations; paint stripping preparations.

(260) AM 2022 116772 A  
 (800) 1645947  
 (151) 2021 10 26  
 (891) 2021 10 26  
 (731) BALLET TECHNOLOGIES, LLC  
 12 Woodrow Road, Hanover NH 03755, USA  
 (540)

## BALLET

(591) Black, white  
 (511)  
 8 – Electrolysis needles.

(260) AM 2022 116773 A  
 (800) 1645966  
 (151) 2021 10 25  
 (891) 2021 10 25  
 (731) VIENNA INSURANCE GROUP AG Wiener  
 Versicherung Gruppe  
 Schottenring 30, A-1010 Wien, Austria  
 (540)



## VIENNA INSURANCE GROUP

(591) White, black, red and blue  
 (531) 26.11.08; 26.11.25; 26.15.01; 27.05.10; 28.05;  
 29.01.13  
 (511)  
 36 – Insurance; financial affairs; monetary affairs; real estate affairs.

(260) AM 2022 116774 A  
 (800) 1646005  
 (151) 2021 12 15  
 (891) 2021 12 15  
 (731) DAEWOONG CO., LTD.  
 244, Galmachi-ro, Jungwon-gu, Seongnam-si  
 Gyeonggi-do, Republic of Korea  
 (540)



(591) Black, white  
 (531) 03.01.14; 03.01.24; 27.05.01  
 (511)  
 5 – All purpose deodorizing preparations for household, commercial or industrial use; veterinary preparations; insect repellants; mothproofing paper; food supplements; pharmaceuticals containing botulinum toxin; vitamin and mineral food supplements; fungicides; wound dressings; bacterial poisons; breast-nursing pads; dietary supplements; eye bandages; milk sugar for pharmaceutical purposes; powdered milk foods for infants; food for babies; bone cement for surgical and orthopedic purposes; surgical implants (living tissues); dietary supplements for infants; medicated plasters; bacterial preparations for medical purposes; adhesive compositions for medical use; medicines for human purposes; disposable diapers; embedding material for dental and dental technical purposes; glue coated strips for use against vermin; portable first-aid kits.

(260) AM 2022 116775 A  
 (800) 1646030  
 (151) 2021 10 18  
 (891) 2021 10 18  
 (731) Euro Games Technology Ltd.  
 4, "Maritsa" Str., "Vranya-Lozen-Triugulnika",  
 BG-1151 Sofia, Bulgaria  
 (540)

## Book of Troy

(591) Black, white  
 (511)  
 9 – Software; computer gaming software; computer software packages; computer operating system software; computer software, recorded; software drivers; virtual reality software; games software; entertainment software for computer games; computer programs for network management; operating computer software for main frame computers; monitors (computer hardware); computer hardware; apparatus for recording images; monitors (computer programs); computer game programs; computer programs for recorded games; apparatus for recording, transmission or reproduction of sound or images; communications

servers [computer hardware]; electronic components for gambling machines; computer application software featuring games and gaming; computer software for the administration of on-line games and gaming; computer hardware for games and gaming; hardware and software for gambling, gambling machines, gambling games on the Internet and via telecommunication network.

28 – Gaming machines for gambling; chips for gambling; mah-jong; arcade games; gambling machines operating with coins, notes and cards; games; electronic games; parlor games; gaming chips; gaming tables; slot machines [gaming machines]; LCD game machines; slot machines and gaming devices; coin-operated amusement machines; roulette chips; poker chips; chips and dice [gaming equipment]; equipment for casinos; roulette tables; gaming roulette wheels; casino games; automats and gambling machines; coin-operated machines and/or electronic coin-operated machines with or without the possibility of gain; boxes for coin-operated machines, slot machines and gaming machines; electronic or electrotechnical gaming devices, automats and machines, coin-operated machines; housings for coin-operated machines, gaming equipment, gaming machines, machines for gambling; electropneumatic and electrical gambling machines (slot machines).

41 – Gambling; services related to gambling; gaming services for entertainment purposes; casino, gaming and gambling services; training in the development of software systems; provision of gaming equipment for gambling halls; providing casino equipment [gambling]; gaming machine entertainment services; providing casino facilities [gambling]; halls with gaming machines; amusement arcade services; games equipment rental; rental of gaming machines; providing amusement arcade services; rental of gaming machines with images of fruits; editing or recording of sounds and images; sound recording and video entertainment services; hire of sound reproducing apparatus; provision of gaming equipment for casinos; providing of casino facilities; online gambling services; casino management services; operation of gaming establishments, gaming halls, internet casinos, online gambling sites.

(260) AM 2022 116776 A  
 (800) 1646032  
 (151) 2021 09 15  
 (891) 2021 09 15  
 (731) P&C Technologie Zártkörűen Működő  
 Részvénytársaság  
 Bajcsy-Zsilinszky út 48. 2. em., H-1054  
 Budapest, Hungary  
 (540)

## PIERRE CARDIN

(591) Black, white

(511)  
7 – Juice extractors; vacuum cleaners; electric vacuum cleaners; robotic vacuum cleaners; ironing machines.

8 – Flat irons.

9 – Amplifiers; bags adapted for laptops; cameras [photography]; cases for smartphones; computers; cordless telephones; covers for tablet computers; headphones; laptop computers; loudspeakers; mouse pads; photocopiers [photographic, electrostatic, thermal]; pocket calculators; printers for use with computers; radios; scanners [data processing equipment]; sleeves for laptops; smartphones; tablet computers; television apparatus; USB flash drives; vehicle radios.

(260) AM 2022 116783 A

(800) 1646458

(151) 2021 12 23

(891) 2021 12 23

(731) "NEW MAX HOLDING" mas'uliyati  
cheklangan jamiyati  
Sayram str., h.50 passage 7, M.Ulug'bek  
district, Tashkent c., 100000, Uzbekistan

(540)

**MAZZINNI**

(591) Black, white

(531) 27.05.01

(511)

5 – Pharmaceuticals, medical and veterinary preparations; sanitary preparations for medical purposes; dietetic food and substances adapted for medical or veterinary use, food for babies; dietary supplements for human beings and animals; plasters, materials for dressings; material for stopping teeth, dental wax; disinfectants; preparations for destroying vermin; fungicides, herbicides.

29 – Meat, fish, poultry and game; meat extracts; preserved, frozen, dried and cooked fruits and vegetables; jellies, jams, compotes; eggs; milk, cheese, butter, yogurt and other milk products; oils and fats for food.

30 – Coffee, tea, cocoa and substitutes therefor; rice, pasta and noodles; tapioca and sago; flour and preparations made from cereals; bread, pastries and confectionery; chocolate; ice cream, sorbets and other edible ices; sugar, honey, treacle; yeast, baking-powder; salt, seasonings, spices, preserved herbs; vinegar, sauces and other condiments; ice (frozen water).

32 – Beers; non-alcoholic beverages; mineral and aerated waters; fruit beverages and fruit juices; syrups and other preparations for making non-alcoholic beverages.

(260) AM 2022 116789 A

(800) 1646487

(151) 2021 12 08

(891) 2021 12 08

(731) Obshchestvo s ogranichennoj otvetstvennost'yu  
Stellar Group Rus  
1 Magistral'nyj tupik, 5A, room 26, RU-123290  
Moscow, Russian Federation

(540)



(591) Black, white

(531) 26.01.01; 26.01.04; 26.13.25; 27.05.01

(511)

33 – Aperitifs; arak; baijiu [Chinese distilled alcoholic beverage]; brandy; wine; piquette; whisky; vodka; anisette [liqueur]; kirsch; gin; digestifs [liqueurs and spirits]; cocktails; curacao; anise [liqueur]; liqueurs; pre-mixed alcoholic beverages, other than beer-based; alcoholic beverages, except beer; alcoholic beverages containing fruit; spirits [beverages]; distilled beverages; mead [hydromel]; peppermint liqueurs; bitters; nira [sugarcane-based alcoholic beverage]; rum; sake; perry; cider; rice alcohol; alcoholic extracts; fruit extracts, alcoholic; alcoholic essences.

(260) AM 2022 116796 A

(800) 1646675

(151) 2021 12 16

(891) 2021 12 16

(731) China Post Communications Equipment Co.,  
Ltd.  
6 / F, Block D, No.156, Fuxingmennei Street,  
Xicheng District, 100031 Beijing, China

(540)

**Hi nova**

(591) Black, white

(531) 27.05.01

(511)

9 – Selfie sticks [hand-held monopods]; connected bracelets [measuring instruments]; battery chargers; couplers [data processing equipment]; computer programs, recorded; computer software applications, downloadable; tablet computers; pedometers; smartphones; wearable activity trackers; data processing apparatus; cases for smartphones; portable media players; cameras [photography].

(260) AM 2022 116799 A

(800) 1646754

(151) 2022 01 13

(891) 2022 01 13

(731) Kaiserdom-Privatbrauerei Bamberg Wörner GmbH & Co. KG  
Breitäckerstraße 9, 96049 Bamberg, Germany

(540)

Кайзердом

(591) Black, white

(531) 28.05

(511)

30 – Cooling ice, malt extract for food.

(260) AM 2022 116804 A

(800) 1646860

(151) 2021 04 16

(891) 2021 04 16

(731) KERRY GROUP PLC.  
Prince's Street, Tralee, Ireland

(540)

KERRY

(591) Teal

(531) 26.11.01; 26.11.12; 27.05.11; 29.01.04

(511)

1 – Proteins for the manufacture of human foodstuffs which form emulsions or have emulsifying properties; proteins for the manufacture of human foodstuffs which form gel or which have gelling properties; proteins for the manufacture of human foodstuffs which hold water or have water holding properties; gelling agents for human foodstuffs or beverages; absorption agents; emulsifiers for use in the manufacture of foods; wetting agents; stabilising agents for use in food; foaming agents; emulsifiers; texturing agents for use in the manufacture of foods; texturants for food and beverage; sweet particulates and inclusions, sweet sauces, texture systems, sweet and savoury flavours being chemical or organic compositions for use in manufacture of food and beverages; casein; flavour improvers for foods, beverages and oral care products; chemical additives for use in the manufacture of food, drink and oral care products; chemicals for use in brewing; enzymes for the brewing industry; caseinate; chemical products derived from milk for use in industry; chemical products for preserving foodstuffs or beverages; preserving agents for foods and beverages; proteins for use in industry; proteins for the food industry; proteins for the beverage industry; proteins for use in manufacture; food protein as a raw material; proteins for use in the manufacture of foodstuffs or

beverages; proteins for use in the manufacture of food supplements; enzymes for use in flavouring; flavour enhancers for foods, beverages and oral care products; chemical products for the preparation of flavourings; enzymes (other than for medical or veterinary use); enzyme preparations for the food industry; enzyme preparations for the beverage industry; enzyme preparations for use in the baking, confectionery, dairy, meat, human nutrition or animal nutrition industries; fungal enzymes for use in the food industry or beverage industry; fungal enzymes for use in the baking, brewing, confectionery, dairy, meat, human nutrition or animal nutrition industries; fermentation extract; chemical additives for use in fermentation; enzymes for use in fermentation; proteins for use in fermentation technology; ferments for use in the food industry or beverage industry; ferments for use in the baking, brewing, confectionery, dairy, meat, human nutrition or animal nutrition industries; chemical products for the fresh-keeping and preserving of food; chemical products for preserving products during storage; food preservative compositions; food preservatives; catalysts; catalysts for use in the food industry or beverage industry; catalysts for use in the baking, brewing, confectionery, dairy, meat, human nutrition or animal nutrition industries; natural extracts and distillates for use in the food industry or beverage industry; natural extracts and distillates for use in the baking, brewing, confectionery, dairy, meat, human nutrition or animal nutrition industries; beta glucan for use in the food industry or beverage industry; beta glucan for use in the baking, confectionery, dairy, meat, human nutrition or animal nutrition industries; prebiotic bacteria and probiotic bacteria for use in the food industry or beverage industry; prebiotic bacteria and probiotic bacteria for use in the baking, brewing, confectionery, dairy, meat, human nutrition or animal nutrition industries; prebiotic or probiotic bacterial formulations (other than for medical use); nutritional lipids and nutritional bases for use in the food industry or beverage industry; nutritional lipids and nutritional bases for use in the baking, confectionery, dairy, meat, human nutrition or animal nutrition industries; enzymes produced through fermentation of yeast, bacterial or fungal strains; whey and demineralised whey for use in the food industry or beverage industry; whey and demineralised whey for use in the baking, confectionery, dairy, meat, human nutrition or animal nutrition industries; nutrition agents for processing living cells (other than for medical use); nutrition agents for living cells (other than for medical use); protein hydrolysates; recombinant proteins for nutrition of living cells (other than for medical use); media for cell culture for use in the biotechnical industry or in non-medical research laboratories; cultures of cell media (other than for medical or veterinary use); excipients, (other than for medical use); chemical preparations for use in pharmaceuticals; chemical preparations for use in the manufacture of pharmaceuticals; chemical preparations for use in the

pharmaceutical industry; chemical preparations for use in nutraceuticals; pharmaceutical excipients used in the manufacture of pharmaceuticals; cellulose ethers; chemicals and polymers used for coating and/or encapsulating vitamin and/or mineral supplements, pharmaceuticals, food supplements, herbal products or food products; enzymes for use in the manufacture of nutraceuticals; hydrolised vegetable protein; lipid mixtures for use as additives in foodstuffs; lipid mixtures for use as additives in beverages and mixes for making beverages; excipients used in the manufacture of pharmaceuticals; media for cell culture for use in medical research laboratories.

3 – Flavourings being essential oils for foodstuffs or beverages; flavour enhancers for foodstuffs or beverages (essential oils); food flavourings prepared from essential oils; flavourings for beverages (essential oils); substances imparting taste for addition to foodstuffs or beverages (essential oils).

5 – Pharmaceutical preparations; chemical preparations for pharmaceutical purposes; pharmaceutical preparations and substances; delivery agents in the form of coatings for tablets that facilitate the delivery of vitamin and/or mineral supplements, pharmaceutical preparations, food supplements or herbal products in this class; cellulose ethers for pharmaceutical, medical or dietetic purposes; casein dietary supplements; dietary supplements and dietetic preparations; enzyme dietary supplements; nutritional supplements; nutritional supplements consisting of fungal extracts; prebiotic supplements; probiotic supplements; protein supplements; food supplements; feed supplements for veterinary use; medicated food supplements; medicated supplements for animal feedstuffs; nutrition agents for processing living cells (for medical or veterinary use); nutrition agents for living cells (for medical or veterinary use); recombinant proteins for nutrition of living cells (for medical or veterinary use); cultures of cell media (for medical or veterinary use); nutraceuticals for therapeutic purposes; nutraceuticals for use as a dietary supplement; coating and encapsulating materials in the nature of delivery agents in the form of coatings for tablets that facilitate the delivery of pharmaceutical preparations; carbohydrate-based nutritional drink mix for use as a meal replacement for medical use.

29 – Dairy powders; cheese powder; cream powder; powdered butter; powdered cultured dairy products; milk powder; milk fat; milk fat preparations; powdered milk fat; curd; dairy products and dairy substitutes; milk; milk products; edible oils and fats; lipids being edible fats; beverages consisting principally of milk; beverages having a milk base; beverages made with yoghurt; birds eggs and egg products; cheese; cheese products; cheese spreads; dairy desserts; dairy-based spreads; dairy puddings; dairy spreads; dairy-based beverages; dairy-based dips; cheese dips; dairy-

based dips; bean dips; nut-based dips; meat-based dips; vegetable-based dips; plant-based dips; desserts made from milk products; dried milk powder; flavoured milk; flavoured milk beverages; flavoured milk powder for making drinks; milk based beverages [milk predominating]; milk beverages, milk predominating; milk-based beverages containing coffee; milk-based beverages containing fruit juice; milk-based beverages containing fruits; pre-cooked soup; preparations for making soup; vegetable-based spreads; whey; yoghurt; preparations for addition to, or for use in making, dairy products, ice-cream, ice cream desserts, ice cream confections, frozen confections, frozen yoghurt, sorbet, sherbets, sundaes, yoghurt or milk shakes, namely, crystallized fruit, dried fruit, processed nuts, and nut butters; clusters made primarily with potato chips, dried fruits, and processed nuts; inclusions for dairy products, ice cream, ice cream desserts, ice cream confections, frozen confections, frozen yoghurt, sorbet, sherbets, sundaes, yoghurt or milk shakes, namely, dried and crystallized fruit, processed and candied nuts, and nut butters, including pieces of any of the foregoing; inclusions for dairy products, ice-cream, ice cream desserts, ice cream confections, frozen confections, frozen yoghurt, sorbet, sherbets, sundaes, yoghurt or milk shakes, namely, clusters made primarily of potato chips, dried and crystallized fruit, and processed and candied nuts; fruit, nut or dairy based sweet particulates and inclusions, namely candied nuts and dried fruits; dairy products that include added toppings or mix-ins; meat; fish; poultry; game; meat extracts; preserved fruits; preserved vegetables; dried fruits; dried vegetables; cooked fruits; cooked vegetables; jellies; jams; compotes; eggs; prepared meals, dishes and snack foods consisting primarily of meat, meat substitutes, fish, poultry, game, seafood, shellfish, fruit, nuts, seeds, vegetables, mushrooms, dairy products, dairy substitutes, eggs, legumes or tofu; dried mushrooms; preserved mushrooms; prepared mushrooms; banana crisps, coconut crisps, potato crisps; vegetable crisps; dried fruit; dried pulses; edible seeds; fish and seafood spreads; flavoured nuts; fruit salads; meat paste; meat spreads; meat stocks; meat, prepared; meat, preserved; meat, processed; nuts being cooked; nuts being dried; nuts being preserved; nuts, prepared; potato salad; prepared fruits; prepared legumes; prepared nuts; prepared pulses; prepared salads; prepared vegetable products; prepared vegetables; processed fruits; processed meat products; processed nuts; processed seafood products; processed vegetables; pulses, dried; pulses, prepared; pulses, preserved; pulses, processed; seafood products; seafood, not live; seafood, processed; seeds, prepared; shellfish, not live; snack mixes consisting of dehydrated fruit and processed nuts; soup mixes; soups; soya beans, preserved, for food; textured vegetable protein for use as a meat extender; tofu; vegetable extracts for culinary purposes; vegetable salads; vegetable-based meat substitutes; non-dairy



creamers; dairy-based creamers; shortening enzyme-modified whole milk powder; non-dairy milk; stocks, broths and bouillons; pickles; fruit and vegetable based extracts used as additives in the manufacture of foodstuffs; bases for making milk shakes.

30 – Food flavourings; flavourings, other than essential oils, for foods; flavourings, other than essential oils, for beverages; salts, seasonings, flavourings and condiments; substances imparting taste for addition to foodstuffs or beverages (other than essential oils); malt-based food preparations; malt extracts for food; malt extracts for use as flavouring; natural smoke condensates (flavourings) for foodstuffs or beverages; coatings, rubs, marinades and glazes for foodstuffs; clusters made primarily with pretzels, rice, popcorn, crackers, processed and ready to eat cereals, processed grains, chocolate and candy; chocolate and candy for adding to dairy products, frozen yoghurt or ice cream; dairy confectionery, frozen yoghurt or ice cream that include added toppings or mix-ins; starch-based binding agents for ice cream; thickening agents for use in cooking; coffee; tea; cocoa; artificial coffee; preparations made from cereals; confectionery; edible ices; sauces (condiments); flavourings, other than essential oils, for milk shakes; blends of seasonings; chocolate based products; chocolate flavourings; condiments; cooking essences; dried herbs; dry seasonings; edible spices; extracts used as flavouring [not essential oils]; flavour enhancers for food [other than essential oils]; essences for foodstuffs, except etheric essences and essential oils; flavourings and seasonings; fruit sauces; marinades; processed herbs; relish [condiment]; sauces; savoury food flavourings for animal foods [other than essential oils]; savoury food flavourings for food [other than essential oils]; savoury sauces, chutneys and pastes; seasonings; spices; vegetable thickeners; cooking sauces; dressings for salad; gravies; gravy mixes; preparations for making up into sauces; preparations for making gravy; salsas; savoury sauces used as condiments; cereal bars and energy bars; bakery goods; candies [sweets]; chilled desserts; crackers; crème caramel; custard; dessert mousses [confectionery]; dessert puddings; foodstuffs containing chocolate [as the main constituent]; foodstuffs containing cocoa [as the main constituent]; imitation chocolate; sweets (candy), candy bars and chewing gum; pastries, cakes, tarts and biscuits (cookies); prepared desserts [chocolate based]; prepared desserts [confectionery]; savoury biscuits; snack foods consisting principally of confectionery; pastries; pasties; prepared desserts [pastries]; wafers; chocolate candies; chocolate bars; natural sweeteners; sweet glazes and fillings; flavouring syrups; glucose syrups for food; topping syrup; frozen confectionery; frozen yoghurt [confectionery ices]; ice beverages with a chocolate base; ice beverages with a cocoa base; ice beverages with a coffee base; ice cream; ice cream mixes; ice cream substitute; non-dairy ice cream; artificial tea; beverages containing chocolate; beverages

with a chocolate base; beverages with a cocoa base; beverages with coffee base; beverages with tea base; chocolate; chocolate-based beverages with milk; cocoa beverages with milk; coffee beverages with milk; coffee flavourings; preparations for making beverages [cocoa based]; preparations for making beverages [tea based]; preparations for making beverages [coffee based]; preparations for making beverages [chocolate based]; tea extracts; cereals; doughs, batters, and mixes therefor; dried and fresh pastas, noodles and dumplings; food preparations based on grains; organic thickening agents for cooking foodstuffs; natural starches for food; modified starches for food [not medical]; preparations for making bakery products; processed cereals for food for human consumption; processed grains for food for human consumption; thickening agents for cooking foodstuffs; yeast and leavening agents; pre-mixes ready for baking; bread mixes; pastry mixes; cocoa, cereal, sugar or confectionery based sweet particulates and inclusions, namely chocolate pieces, candy pieces, cookie pieces, popcorn pieces, pretzel pieces, cracker pieces, caramel pieces, toffee pieces, snack food (consisting of rolled oats, nuts and honey), sweet sauces, sweet and savoury flavours; yeast; yeast extracts; baking-powder; salt; mustard; vinegar; ice; prepared meals or dishes consisting of rice, with added meat, fish or vegetables; prepared meals, dishes or snack foods consisting primarily of cereals, grains, pasta, pastry, bread, confectionery, rice or noodles; dairy flavours; natural based extracts (flavourings) used as additives in the manufacture of foodstuffs; pickling solutions in the nature of vinegar and brine for pickling and cooking; pickling solutions in the nature of vinegar and brine for cooking used in baking, confectionery, dairy, meat, human nutrition industry; inclusions for dairy products, ice-cream, ice cream desserts, ice cream confections, frozen confections, frozen yoghurt, sorbet, sherbets, sundaes, yoghurt or milk shakes, namely, popcorn, pretzels, crackers, hard candies, toffees, candy and chocolate brittles, candy and chocolate barks, cookie dough, chocolate, and caramel, including pieces of any of the foregoing; inclusions for dairy products, ice-cream, ice cream desserts, ice cream confections, frozen confections, frozen yoghurt, sorbet, sherbets, sundaes, yoghurt or milk shakes, namely, flavouring and topping syrups, sauces, processed and ready-to-eat cereal pieces and clusters made primarily of processed and ready-to-eat cereal pieces, pretzels, crackers, candy sprinkles and other confectionery pieces, namely, chocolate confectionery and confectionery made of sugar; carbohydrate-based nutritional drink mix for use as a meal replacement.

32 – Food flavourings; flavourings, other than essential oils, for foods; flavourings, other than essential oils, for beverages; salts, seasonings, flavourings and condiments; substances imparting taste for addition to foodstuffs or beverages (other than essential oils); malt-based food preparations; malt extracts for food;

malt extracts for use as flavouring; natural smoke condensates (flavourings) for foodstuffs or beverages; coatings, rubs, marinades and glazes for foodstuffs; clusters made primarily with pretzels, rice, popcorn, crackers, processed and ready to eat cereals, processed grains, chocolate and candy; chocolate and candy for adding to dairy products, frozen yoghurt or ice cream; dairy confectionery, frozen yoghurt or ice cream that include added toppings or mix-ins; starch-based binding agents for ice cream; thickening agents for use in cooking; coffee; tea; cocoa; artificial coffee; preparations made from cereals; confectionery; edible ices; sauces (condiments); flavourings, other than essential oils, for milk shakes; blends of seasonings; chocolate based products; chocolate flavourings; condiments; cooking essences; dried herbs; dry seasonings; edible spices; extracts used as flavouring [not essential oils]; flavour enhancers for food [other than essential oils]; essences for foodstuffs, except etheric essences and essential oils; flavourings and seasonings; fruit sauces; marinades; processed herbs; relish [condiment]; sauces; savoury food flavourings for animal foods [other than essential oils]; savoury food flavourings for food [other than essential oils]; savoury sauces, chutneys and pastes; seasonings; spices; vegetable thickeners; cooking sauces; dressings for salad; gravies; gravy mixes; preparations for making up into sauces; preparations for making gravy; salsas; savoury sauces used as condiments; cereal bars and energy bars; bakery goods; candies [sweets]; chilled desserts; crackers; crême caramel; custard; dessert mousses [confectionery]; dessert puddings; foodstuffs containing chocolate [as the main constituent]; foodstuffs containing cocoa [as the main constituent]; imitation chocolate; sweets (candy), candy bars and chewing gum; pastries, cakes, tarts and biscuits (cookies); prepared desserts [chocolate based]; prepared desserts [confectionery]; savoury biscuits; snack foods consisting principally of confectionery; pastries; pasties; prepared desserts [pastries]; wafers; chocolate candies; chocolate bars; natural sweeteners; sweet glazes and fillings; flavouring syrups; glucose syrups for food; topping syrup; frozen confectionery; frozen yoghurt [confectionery ices]; ice beverages with a chocolate base; ice beverages with a cocoa base; ice beverages with a coffee base; ice cream; ice cream mixes; ice cream substitute; non-dairy ice cream; artificial tea; beverages containing chocolate; beverages with a chocolate base; beverages with a cocoa base; beverages with coffee base; beverages with tea base; chocolate; chocolate-based beverages with milk; cocoa beverages with milk; coffee beverages with milk; coffee flavourings; preparations for making beverages [cocoa based]; preparations for making beverages [tea based]; preparations for making beverages [coffee based]; preparations for making beverages [chocolate based]; tea extracts; cereals; doughs, batters, and mixes therefor; dried and fresh pastas, noodles and dumplings; food preparations based on grains; organic

thickening agents for cooking foodstuffs; natural starches for food; modified starches for food [not medical]; preparations for making bakery products; processed cereals for food for human consumption; processed grains for food for human consumption; thickening agents for cooking foodstuffs; yeast and leavening agents; pre-mixes ready for baking; bread mixes; pastry mixes; cocoa, cereal, sugar or confectionery based sweet particulates and inclusions, namely chocolate pieces, candy pieces, cookie pieces, popcorn pieces, pretzel pieces, cracker pieces, caramel pieces, toffee pieces, snack food (consisting of rolled oats, nuts and honey), sweet sauces, sweet and savoury flavours; yeast; yeast extracts; baking-powder; salt; mustard; vinegar; ice; prepared meals or dishes consisting of rice, with added meat, fish or vegetables; prepared meals, dishes or snack foods consisting primarily of cereals, grains, pasta, pastry, bread, confectionery, rice or noodles; dairy flavours; natural based extracts (flavourings) used as additives in the manufacture of foodstuffs; pickling solutions in the nature of vinegar and brine for pickling and cooking; pickling solutions in the nature of vinegar and brine for cooking used in baking, confectionery, dairy, meat, human nutrition industry; inclusions for dairy products, ice-cream, ice cream desserts, ice cream confections, frozen confections, frozen yoghurt, sorbet, sherbets, sundaes, yoghurt or milk shakes, namely, popcorn, pretzels, crackers, hard candies, toffees, candy and chocolate brittles, candy and chocolate barks, cookie dough, chocolate, and caramel, including pieces of any of the foregoing; inclusions for dairy products, ice-cream, ice cream desserts, ice cream confections, frozen confections, frozen yoghurt, sorbet, sherbets, sundaes, yoghurt or milk shakes, namely, flavouring and topping syrups, sauces, processed and ready-to-eat cereal pieces and clusters made primarily of processed and ready-to-eat cereal pieces, pretzels, crackers, candy sprinkles and other confectionery pieces, namely, chocolate confectionery and confectionery made of sugar; carbohydrate-based nutritional drink mix for use as a meal replacement.

(260) AM 2022 116812 A

(800) 1647018

(151) 2021 12 16

(891) 2021 12 16

(731) "SkyLab" AG

Nüscherstrasse, 31, CH-8001 Zurich,  
Switzerland

(540)

## BIONYTI

(591) Black, white

(511)

3 – Aromatics [essential oils]; breath freshening sprays; balms, other than for medical purposes; waxes for leather; dental bleaching gels; perfumery; adhesives for affixing false eyelashes; hair conditioners; beard



dyes; creams for leather; cosmetic creams; hair lotions; lotions for cosmetic purposes; after-shave lotions; beauty masks; oils for cosmetic purposes; soap; cosmetic kits; toothpaste; gel eye patches for cosmetic purposes; breath freshening strips; lipsticks; shaving preparations; hair straightening preparations; hair waving preparations; color-removing preparations; mouthwashes, not for medical purposes; breath freshening preparations for personal hygiene; make-up powder; false eyelashes; tissues impregnated with cosmetic lotions; eyebrow cosmetics; sun-tanning preparations [cosmetics]; hair colorants; neutralizers for permanent waving; cosmetic preparations for eyelashes; cosmetic preparations for skin care; cosmetics; mascara; henna [cosmetic dye]; shampoos; dry shampoos.

5 – Medicinal hair growth preparations; medicated shampoos; medicated dry shampoos.

(260) AM 2022 116826 A

(800) 1612846

(151) 2021 07 20

(891) 2022 02 09

(731) Obshchestvo s ogranichennoy, otvetstvennostyu "TORGOVIY DOM EVRASIA"

Volokolamskoye sh., d.2, et. 23, pom. I, kom. 6,  
RU-125080 Moscow, Russian Federation

(540)

mediOk

(591) Black, white

(531) 27.05.01

(511)

9 – Gloves for divers; gloves for protection against accidents; gloves for protection against X-rays for industrial purposes; asbestos gloves for protection against accidents.

10 – Masks for use by medical personnel; boots for medical purposes; clothing especially for operating rooms; gloves for massage; gloves for medical purposes.

21 – Gloves for household purposes; polishing gloves; gardening gloves.

25 – Gloves [clothing].

42 – Water analysis; computer system analysis; handwriting analysis [graphology]; chemical analysis; architecture; energy auditing; recovery of computer data; industrial design; graphic arts design; computer virus protection services; technical project studies; oil-field surveys; geological surveys; engineering; installation of computer software; meteorological information; material testing; textile testing; bacteriological research; biological research; geological research; research in the field of environmental protection; cos-

metic research; mechanical research; chemical research; research and development of new products for others; scientific research; analysis for oil-field exploitation; underwater exploration; technical surveys; clinical trials; calibration [measuring]; information technology [IT] consultancy; consultancy in the design and development of computer hardware; architectural consultancy; computer software consultancy; oil-well testing; quality control; vehicle roadworthiness testing; website design consultancy; land surveying; dress designing; updating of computer software; monitoring of computer systems by remote access; maintenance of computer software; authenticating works of art; design of interior decor; quality evaluation of standing timber; quality evaluation of wool; digitization of documents [scanning]; conversion of data or documents from physical to electronic media; urban planning; providing scientific information, advice and consultancy relating to carbon offsetting; providing search engines for the internet; data conversion of computer programs and data [not physical conversion]; computer system design; rental of web servers; computer rental; rental of computer software; geological prospecting; oil prospecting; hosting computer sites [web sites]; server hosting; copying of computer programs; construction drafting; computer software design; cloud seeding; consultancy in the field of energy-saving; creating and maintaining websites for others; computer programming; chemistry services; packaging design; scientific laboratory services; styling [industrial design]; physics [research]; surveying.

(260) AM 2022 116870 A

(800) 1647180

(151) 2021 07 27

(891) 2021 07 27

(731) SOCAB GmbH

Verner Pantan Straße 2, 79395 Neuenburg,  
Germany

(540)

**SOCAB**

(591) Black, white

(511)

1 – Flavour improvers for tobacco; preparations for fermenting tobacco; chemicals for fermenting tobacco; sauce for preparing tobacco; antioxidants for use in the manufacture of food and beverages; chemicals for use in fermenting; enzymes for use in flavouring.

34 – Tobacco; leaf tobacco; loose, rolling and pipe tobacco; raw tobacco; manufactured tobacco; smokeless tobacco; shredded tobacco; tobacco and tobacco products (including substitutes); tobacco products; tobacco products for the purpose of being heated; cigarettes containing tobacco substitutes; cigarettes; cigarettes containing tobacco substitutes, not for medical purposes; cigars; cigars for use as an alternative to tobacco cigarettes; cigarettes, cigars, cigarillos and other rea-

dy-for-use smoking articles; flavourings, other than essential oils, for tobacco; flavoured tobacco (other than essential oils); hookah tobacco; tobacco tar for use in electronic cigarettes; tobacco free cigarettes, other than for medical purposes; hookahs; shisha pipes; tobacco pipes; electronic smoking pipes; pipe cleaners for tobacco pipes; pipes for smoking mentholated tobacco substitutes; pipe racks for tobacco pipes; cases, not of precious metal for pipes; tobacco containers and humidors; tobacco tins; tobacco pouches; tobacco jars; tobacco filters; tobacco pouches; tobacco pipe scrapers; pipe cleaners for tobacco pipes; absorbent paper for tobacco pipes; cigarette paper; books of cigarette papers; humidifiers for tobacco; devices for heating tobacco substitutes for the purpose of inhalation; inhalers for use as an alternative to tobacco cigarettes; oral vaporizers for smokers; hand held machines for injecting tobacco into paper tubes; pocket machines for rolling cigarettes; tips of yellow amber for cigar and cigarette holders; cigar holders; cigar holders of precious metal; humidors; ashtrays; lighters for smokers [cigarette lighters] (none of the aforesaid goods of precious metal or coated therewith); articles for use with tobacco; matches; flavourings, other than essential oils, for use in electronic cigarettes; chemical flavorings in liquid form used to refill electronic cigarette cartridges; electronic nicotine inhalation devices; electronic devices for the inhalation of nicotine containing aerosol; electronic cigarettes; electronic cigars; replaceable cartridges for electronic cigarettes; inhalable aerosols and liquids for use in tobacco water pipes; liquid solutions for use in electronic cigarettes; electronic cigarette liquid [e-liquid] comprised of flavorings in liquid form used to refill electronic cigarette cartridges; electronic cigarette liquid [e-liquid] comprised of propylene glycol; electronic cigarette liquid [e-liquid] comprised of vegetable glycerin; cartridges sold filled with chemical flavorings in liquid form for electronic cigarettes; refill cartridges for electronic cigarettes; cartridges for electronic cigarettes; smoking sets for electronic cigarettes; tobacco or its substitutes for inhalation using water pipes, in particular flavored tobacco; smokeless cigarette vaporizer pipes; electronic cigarette atomizers; electronic cigarette cartomizers; chewing tobacco; filter-tipped cigarettes; tobacco free cigarettes, other than for medical purposes; cigarillos; lighters for smokers; absorbent paper for tobacco pipes; bags adapted for pipes for smokers; steam stones for hookahs [tobacco substitutes]; electronic hookahs; electronic smoking pipes; devices for heating tobacco for the purpose of inhalation; electronic cigarette cases; devices for extinguishing heated cigarettes, cigars and heated tobacco sticks; holders for electronic cigarettes; Asian long tobacco pipe sheaths; Asian long tobacco pipes (kiseru); mouthpieces for cigarettes; mouthpieces for pipes, namely for tobacco pipes and water pipes; pipes for smoking mentholated tobacco substitutes; mentholated tobacco; mouthpieces for cigarette holders; to-

bacco pipe filters; tobacco pipe knives; pipe racks for tobacco pipes; pipe tampers; pipe stems; pipe stoppers [smokers requisites]; pipe stands [smokers requisites]; smokers' articles of precious metal; smokers' articles, not of precious metal; electronic cigarette cleaners; absorbent paper for tobacco; electronic cigarette boxes; spittoons for tobacco users; smoking urns; tobacco pipes of precious metal; tobacco pipes, not of precious metal; cigarette filters; cigarette tubes; cigarette tips; ready-made cigarette tubes with filters; cigarette holders; cigarette holders of precious metal; cigar cutters; cigar pouches; cigar filters.

35 – Retail services in relation to tobacco; retail services in relation to articles for use with tobacco; wholesale services in relation to tobacco; wholesale services in relation to articles for use with tobacco; retail services in relation to cigarettes; retailing in relation to articles for use with cigarettes; wholesale services in relation to cigarettes; wholesaling in relation to articles for use with cigarettes; retail services in relation to cigars; retailing in relation to articles for use with cigars; wholesale services in relation to cigars; wholesaling in relation to articles for use with cigars; retailing in relation to smokers' accessories; retailing in relation to articles for use with smokers' accessories; wholesaling in relation to smokers' accessories; wholesaling in relation to articles for use with smokers' accessories.

---

(260) AM 2022 116873 A  
 (800) 1647228  
 (151) 2021 12 23  
 (891) 2021 12 23  
 (731) Avon Products, Inc.  
 1 Avon Place, Suffern NY 10901,  
 USA

(540)

## AVON EVE

(591) Black, white

(511)

3 – Perfumes; fragrances; toilet waters; cologne; room fragrances; incense sticks; essential oils (cosmetic); oils for perfumes and scents; potpourri.

---

(260) AM 2022 116874 A  
 (800) 1647236  
 (151) 2021 12 17  
 (891) 2021 12 17  
 (731) Obshchestvo s ogranichennoi otvetstvennost'yu  
 "Sibirskii logisticheskii tsentr"  
 ul. Lenina, 48, RU-630004 Novosibirsk,  
 Russian Federation

(540)

## BIONETICA

(591) Black, white

(511)

3 – Abrasive cloth; abrasive paper; abrasives; adhesives for affixing false eyelashes; adhesives for affixing false hair; adhesives for cosmetic purposes; aftershave lotions; air fragrance reed diffusers; air fragrancing preparations; almond milk for cosmetic purposes; almond soap; aloe vera preparations for cosmetic purposes; antiperspirant soap; antiperspirants [toiletries]; antistatic preparations for household purposes; aromatics [essential oils]; baby wipes impregnated with cleaning preparations; balms, other than for medical purposes; bases for flower perfumes; bath preparations, not for medical purposes; bath salts, not for medical purposes; beauty masks; bleaching preparations [decolorants] for cosmetic purposes; bleaching preparations [decolorants] for household purposes; bleaching salts; bleaching soda; breath freshening preparations for personal hygiene; breath freshening sprays; breath freshening strips; cakes of toilet soap; canned pressurized air for cleaning and dusting purposes; chemical cleaning preparations for household purposes; cleaning chalk; cleaning preparations; cleansers for intimate personal hygiene purposes, non medicated; cleansing milk for toilet purposes; cloths impregnated with a detergent for cleaning; collagen preparations for cosmetic purposes; color-removing preparations; cosmetic creams; cosmetic dyes; cosmetic kits; cosmetic pencils; cosmetic preparations for baths; cosmetic preparations for skin care; cosmetic preparations for slimming purposes; cosmetics for animals; cosmetics for children; cosmetics; cotton sticks for cosmetic purposes; cotton wool for cosmetic purposes; decorative transfers for cosmetic purposes; degreasers, other than for use in manufacturing processes; dental bleaching gels; denture polishes; deodorant soap; deodorants for human beings or for animals; depilatories; depilatory wax; descaling preparations for household purposes; detergents, other than for use in manufacturing operations and for medical purposes; douching preparations for personal sanitary or deodorant purposes [toiletries]; dry shampoos; dry-cleaning preparations; drying agents for dishwashing machines; eau de cologne; emery paper; essential oils; ethereal essences; eyebrow cosmetics; eye-washes, not for medical purposes; fabric softeners for laundry use; false eyelashes; false nails; floor wax removers [scouring preparations]; floor wax; fumigation preparations [perfumes]; gel eye patches for cosmetic purposes; glass cloth [abrasive cloth]; greases for cosmetic purposes; hair colorants; hair conditioners; hair lotions; hair spray; hair straightening preparations; hair waving preparations; heliotropine; herbal extracts for cosmetic purposes; hydrogen peroxide for cosmetic purposes; joss sticks; lacquer-removing preparations; laundry glaze; laundry preparations; laundry soaking preparations; leather bleaching preparations; lip glosses; lipstick cases; lipsticks; lotions for cosmetic purposes; make-up powder; make-up

preparations; make-up removing preparations; make-up; mascara; massage candles for cosmetic purposes; massage gels, other than for medical purposes; moustache wax; mouthwashes, not for medical purposes; nail art stickers; nail care preparations; nail glitter; nail polish removers; nail varnish; neutralizers for permanent waving; non-slipping liquids for floors; oils for cleaning purposes; oils for cosmetic purposes; oils for perfumes and scents; oils for toilet purposes; paint stripping preparations; pastes for razor strops; perfumery; perfumes; petroleum jelly for cosmetic purposes; phytocosmetic preparations; polishing creams; polishing paper; polishing preparations; polishing stones; polishing wax; pomades for cosmetic purposes; potpourris [fragrances]; preparations for cleaning dentures; cosmetic preparations for eyelashes; preparations to make the leaves of plants shiny; preservatives for leather [polishes]; pumice stone; rust removing preparations; sachets for perfuming linen; scented water; scented wood; scouring solutions; shampoos for animals [non-medicated grooming preparations]; shampoos for pets [non-medicated grooming preparations]; shampoos; sharpening preparations; shaving preparations; shaving soap; shining preparations [polish]; shoe cream; shoe wax; shoemakers' wax; smoothing preparations [starching]; soap for brightening textile; stain removers; starch for laundry purposes; starch glaze for laundry purposes; sunscreen preparations; sun-tanning preparations [cosmetics]; tailors' wax; teeth whitening strips; tissues impregnated with cosmetic lotions; tissues impregnated with make-up removing preparations; toilet water; toiletry preparations; toothpaste; vaginal washes for personal sanitary or deodorant purposes; varnish-removing preparations; volatile alkali [ammonia] [detergent]; astringents for cosmetic purposes; volcanic ash for cleaning; wallpaper cleaning preparations; washing soda, for cleaning; waxes for leather; windshield cleaning liquids.

(260) AM 2022 116876 A

(800) 1647377

(151) 2021 09 24

(891) 2021 09 24

(731) P&C Technologie Zártkörűen Működő  
Részvénytársaság  
Bajcsy-Zsilinszky út 48. 2. em., H-1054  
Budapest, Hungary

(540)



(591) Black, white

(531) 27.05.01; 27.05.13; 27.05.19

(511)

7 – Juice extractors; vacuum cleaners; electric vacuum cleaners; robotic vacuum cleaners; ironing machines.

8 – Flat irons.

9 – Amplifiers; bags adapted for laptops; cameras [photography]; cases for smartphones; computers; cordless telephones; covers for tablet computers; headphones; laptop computers; loudspeakers; mouse pads; photocopiers [photographic, electrostatic, thermic]; pocket calculators; printers for use with computers; radios; scanners [data processing equipment]; sleeves for laptops; smartphones; tablet computers; television apparatus; USB flash drives; vehicle radios.

(260) AM 2022 116879 A

(800) 1647480

(151) 2021 11 12

(891) 2021 11 12

(731) Strong Nederland B.V.

Constructieweg 1 B, NL-3433 NM Nieuwegein, Netherlands

(540)

**STRONG**

(591) Black, white

(531) 27.05.09; 27.05.10; 27.05.17; 27.07.17

(511)

9 – Electrical and electronic apparatus for storing data; computer hardware; telephones; laptop computers; computer software, recorded; computer software applications, downloadable; downloadable mobile operating system software; wearable computers; switchboards; wireless routers; set-top boxes; security surveillance robots; virtual reality glasses; television apparatus; electronic monitoring instruments, other than for medical use; video projectors; electric sockets; remote control apparatus; video screens; transducers; theft prevention installations, electric; smoke detectors; alarms; biometric fingerprint door locks; rechargeable batteries; fingerprint scanners; smartwatches; scales with body mass analysers; cell phones; webcams; television and video converters; cabinets for loudspeakers; headphones; transmitting and receiving apparatus for television broadcasting; telecommunication machines and implements that can be worn in the form of smart wristbands and smart wristwatches; electronic devices for locating and tracking lost articles using global positioning systems; tablet computers; automobile data recorder; switches, electric; camcorders.

(260) AM 2022 116880 A

(800) 1647506

(151) 2022 01 24

(891) 2022 01 24

(731) Becton, Dickinson and Company

1 Becton Drive, Franklin Lakes NJ 07417, USA

(540)

**BD VACUTAINER  
ACCUSTAT**

(591) Black, white

(511)

10 – Medical specimen collection devices in the nature of tubes for the collection of and the transferring and dispensing of blood.

(260) AM 2022 116881 A

(800) 1647523

(151) 2021 11 10

(891) 2021 11 10

(731) LABORATORIOS FARMACEUTICOS ROVI, S.A.

C/ Julián Camarillo, 35, E-28037 Madrid, Spain

(540)

**ХИБОР**

(591) Black, white

(531) 28.05

(511)

5 – Pharmaceutical preparations; drugs for medical use; anticoagulants; antithrombotic agents; anti-inflammatory agents.

(260) AM 2022 116882 A

(800) 1647560

(151) 2021 09 27

(891) 2021 09 27

(731) Baltika Breweries

6-th Verkhny pereulok, 3, RU-194292 Saint Petersburg, Russian Federation

(540)



(591) navy blue, blue, light blue, dark blue, beige and white

(531) 05.11.15; 25.01.06; 25.07.01; 28.05; 29.01.12

(511)

32 – Aperitifs, non-alcoholic; barley wine [beer]; aerated water; lithia water; seltzer water; soda water; waters [beverages]; mineral water [beverages]; table waters; cocktails, non-alcoholic; beer-based cocktails; beer-based beverages; lemonades; non-alcoholic beverages; isotonic beverages; non-alcoholic honey-based beverages; rice-based beverages, other than milk substitutes; soya-based beverages, other than milk substitutes; aloe vera drinks, non-alcoholic; whey beverages; protein-enriched sports beverages; soft drinks; non-alcoholic beverages flavored with coffee; non-alcoholic beverages flavored with tea; non-alcoholic fruit juice beverages; energy drinks; fruit nectars, non-alcoholic; orgeat; beer; de-alcoholized beer; ginger beer; malt beer; powders for effervescing beverages; sarsaparilla [non-alcoholic beverage]; syrups for lemonade; syrups for beverages; smoothies; vegetable juices [beverages]; fruit juices; tomato juice [beverage]; cider, non-alcoholic; preparations for making aerated water; must; grape must, unfermented; beer wort; malt wort; pastilles for effervescing beverages; non-alcoholic fruit extracts; extracts of hops for making beer; kvass; non-alcoholic preparations for making beverages; sherbets [beverages]; non-alcoholic essences for making beverages.

(260) AM 2022 116883 A

(800) 1647561

(151) 2022 01 13

(891) 2022 01 13

(731) What Do You Meme, LLC

214 Sullivan St, New York NY 10012, USA

(540)

## WHAT DO YOU MEME?

(591) Black, white

(511)

28 – Card games, electronic card games, game equipment set sold as a unit comprised primarily of a playing board and playing cards, tabletop games, tabletop electronic games; gag toys, namely, novelty toy items in the nature of practical joke toys, games, namely, practical joke parlour games, card games, action skill games, party games, toy figures and action figures and accessories therefor, inflatable pool toys, swimming floats

(260) AM 2022 116884 A

(800) 1647584

(151) 2021 09 14

(891) 2021 09 14

(731) TERAPIA S.A.

Str. Fabricii nr.124, jud. Cluj, 400632

Cluj-Napoca, Romania

(540)

## ФАРИНГО ИНТЕНСИВ

(591) Black, white

(531) 28.05

(511)

5 – Pharmaceutical, medical and veterinary preparations; sanitary preparations for medical purposes; diet substances and foods adapted for medical or veterinary purposes, food for babies; dietary supplements for human and veterinary use; patches, dressing materials; materials for filling teeth and dental molds; disinfectants; pest destruction products; fungicides, herbicides; chemical- pharmaceutical preparations; chemical preparations for pharmaceutical, medical and veterinary purposes; pills and tablets for pharmaceutical purposes; vitamin preparations; vitamin patch supplements; chemical reagents for medical or veterinary purposes; adjuvants for medical purposes; medicinal sweets and candies; chewing gum for medical purposes; capsules for medicines; caustic substances and pencils for pharmaceutical purposes; hemostatic pencils; pencils against warts; coal for pharmaceutical purposes; depuratives; laxatives, purgatives; diagnostic preparations for medical and veterinary purposes; decoctions for pharmaceutical purposes; elixirs, pharmaceutical preparations; medicinal infusions; tinctures for medical purposes; herbal teas and extracts for medicinal and pharmaceutical purposes; medicinal oils; medicinal herbs and roots; medicinal beverages; syrups for pharmaceutical purposes; mineral waters for medical purposes and mineral water salts; salts for medical purposes; immunostimulants; fibers for medical purposes; dermal filler injection materials; contraceptive sponges; healing sponges; narcotics; opiates; sedatives/tranquilizers; soporifics; sticks against headaches; serums; suppositories; smoking herbs for medical purposes; tonics (medication); preparations based on oligo-elements for human and veterinary use, vaccines; anthelmintic/deworming preparations; preparations for the destruction of parasites; medicinal shampoos for human and veterinary use; anti-bacterial, disinfectant and medicinal soaps; lotions for pharmaceutical and veterinary purposes, medicinal and anti-bacterial lotions for human and veterinary use, medicinal toothpaste; balms for medical purposes; antiseptics; biocides; detergents for medical purposes; hygienic disinfectants; sterilizing preparations; acne treatment preparations; ointments for pharmaceutical and veterinary use; ointments; ointments for medical purposes; massage gels for medical purposes; pharmaceutical preparations for the care of the skin and for the treatment of bums and sunburns; pediculicides and scabicides; after shave lotions with medicinal content; mouthwash for medical purposes; wipes impregnated with pharmaceutical lotions; meal replacements, diet beverages, adapted for medical or veterinary use; antioxidant pills; appetite suppressants for

medical purposes; medical preparations for weight loss; biological, bacterial, and bacteriological preparations for human and veterinary use; cultures of microorganisms for medical or veterinary use; dietary fiber; digestives for pharmaceutical purposes; enzymatic preparations and supplements for medical and veterinary purposes; ferments for pharmaceutical purposes; nutraceuticals for therapy or medical purposes; deodorants, other than for human or veterinary use; perspiration remedies; sanitary preparations for personal hygiene, other than toiletries; toilet medical preparations; diet supplements with cosmetic effect; diapers for babies and incontinence, diapers for veterinary use.

35 – Advertising; business management; business administration; office functions; the bringing together, for the benefit of others, of a variety of goods (excluding the transport thereof), such services may be provided by retail stores, wholesale outlets, through vending machines, mail order catalogues or by means of electronic media, for example, through web sites or television shopping programmes; retail and wholesale services in relation to medicines, sanitary and veterinary preparations and medical supplies; administrative processing of the purchase orders; keeping the accounting records; invoicing; bidding; administration of consumer loyalty programs, providing commercial information and advice to consumers in choosing goods and services; distribution of samples; presentation of products in the media, for retail purposes; commercial intermediation services, import-export agency services; marketing; media relations services; public relations, corporate communications services, commercial lobbying services; opinion polls, market research; organization of exhibitions for commercial or advertising purposes, organization of trade fairs.

(260) AM 2022 116885 A

(800) 1647595

(151) 2021 06 15

(891) 2021 06 15

(731) Medicovert Holding (Cyprus) Limited  
Eirinis, 119, CY-3041 Limassol, Cyprus

(540)



(591) Light blue, blue and dark blue

(531) 02.01.01; 02.01.23; 26.11.12; 27.05.01;  
29.01.04

(511)

9 – Software; downloadable podcasts; downloadable printable planners and organizers; downloadable computer graphics; downloadable multimedia files; downloadable templates for designing audiovisual presen-

tations; downloadable electronic publications; downloadable applications for use with mobile devices; downloadable video recordings; communication software; computer software packages; downloadable software; downloadable media; computer software platforms; interactive software; mobile software; downloadable educational course materials; application software; database management software.

35 – Brand creation services; data processing; providing employment information; compilation of information into computer databases; preparation and compilation of business and commercial reports and information; providing commercial information relating to companies; business information; providing business information via a website; providing marketing information via websites; providing advice and information relating to commercial business management; publication of publicity texts; dissemination of advertising, marketing and publicity materials; information services relating to jobs and career opportunities; advertising services to create corporate and brand identity; providing commercial and business contact information; publicity.

38 – Providing access to internet forums; providing access to an internet discussion website; data streaming; provision of access to content, websites and portals; providing access to computer databases; transmission of information and images relating to pharmaceuticals, medicine and hygiene; providing user access to a global computer network and online sites containing information on a wide range of topics; providing access to platforms and portals on the internet; transmission of digital information; transmission of data, messages and information; providing access to internet chatrooms; broadcasting of audiovisual and multimedia content via the internet; transmission of data, audio, video and multimedia files, including downloadable files and files streamed over a global computer network; transmission of information by electronic means; providing access to information via data networks; transmission of news and current affairs information; telecommunication services provided via platforms and portals on the internet and other media; provision of access to electronic sites; providing multiple-user wireless access to the internet; providing access to multimedia content online; transfer of information and data via online services and the internet; providing access to information via the internet; transmission of messages, data and content via the internet and other communications networks.

41 – Conducting workshops [training]; consultancy and information services relating to arranging, conducting and organisation of symposiums; providing on-line information and news in the field of employment training; publication of texts, other than publicity texts; providing information relating to recreational activities; providing information relating to sports; publication services; publication of the edito-

rial content of sites accessible via a global computer network; publication of scientific information journals; consultancy and information services relating to arranging, conducting and organisation of conferences; publishing of electronic publications; provision of information relating to training; consultancy and information services relating to arranging, conducting and organisation of colloquiums; providing non-downloadable electronic publications; information on education; education information; providing information about cultural activities; providing entertainment information via a website.

42 – Hosting online web facilities for others for sharing online content; provision of information and data relating to medical and veterinary research and development; hosting of computerized data, files, applications and information; hosting platforms on the internet; platform as a service [PaaS]; software development; providing temporary use of on-line non-downloadable operating software for accessing and using a cloud computing network; software engineering; providing scientific research information and results from an online searchable database; smartphone software design; providing information relating to scientific research in the fields of biochemistry and biotechnology.

44 – Rna or dna analysis for cancer diagnosis and prognosis; pharmacy advisory services; arranging of medical treatment; weight reduction diet planning and supervision; medical services, namely, in vitro fertilization; dentistry; dental consultations; sight-testing [opticians] services; midwife services; medical nursing; providing medical information in the field of geriatrics; veterinary services; reflexology; providing veterinary information; psychological counselling; medical consultations; providing information relating to dentistry; medical care; services for the testing of sera; cholesterol testing; consultancy and information services relating to biopharmaceutical products; dental hygienist services; dietetic counselling services [medical]; dental clinic services; medical services relating to the removal, treatment and processing of stem cells; provision of information relating to vaccination for overseas travel; medical analysis services for the diagnosis of cancer; telemedicine services; medical services for the treatment of conditions of the human body; providing medical information in the healthcare sector; medical advisory services; private hospital services; preparation of reports relating to medical matters; providing online medical information relating to oncology; consultancy and information services relating to pharmaceutical products; performing diagnosis of diseases; nutritional advice; convalescent homes; in vitro fertilization services; consultancy and information services in the field of pharmaceutical products; medical services; psychiatric services; medical laboratory services for the analysis of samples taken from patients; medical analysis services

relating to the treatment of patients; hospital services; providing information relating to nursing care services; postnatal care services for women; optician services; nutrition consultancy services relating to slimming; medical screening; health advice and information services; palliative care; professional consultancy relating to diet; services for the provision of medical facilities; medical analysis services relating to the treatment of persons provided by a medical laboratory; medical consultancy services; rest home services; advisory services relating to diet; dietetic advisory services; ambulant medical care; vaccination services; pharmacy services; genetic testing for medical purposes; human healthcare services; consultancy in the field of nutrition; collection and preservation of human blood; consultancy and information services relating to medical products; holistic psychotherapy; providing information to patients in the field of administering medications; providing breastfeeding information; medical treatment services; health care services offered through a network of health care providers on a contract basis; medical testing for diagnostic or treatment purposes; ultrasound services for medical purposes; emergency assistance services in the medical field; advice relating to dentistry; providing health information via a website; cord blood bank services; medical services for the diagnosis of conditions of the human body; medical analysis services relating to the treatment of persons; dietary guidance; health centre services; healthcare information services; medical services relating to the removal, treatment and processing of human blood; physician services; medical and health services relating to dna, genetics and genetic testing; nursing, medical; providing on-line information relating to the prevention of cardiovascular disease and strokes; physical rehabilitation; pathology services; opticians' services; provision of pharmaceutical information; blood bank services; medical and healthcare services; medical information services provided via the internet; consultancy and information services provided via the internet relating to pharmaceutical products; consulting services relating to health care; medical services relating to the removal, treatment and processing of umbilical cord blood; medical laboratory services for the analysis of blood samples taken from patients; medical services relating to the removal, treatment and processing of human cells; dna screening for medical purposes; psychotherapy services; medical testing services relating to the diagnosis and treatment of disease; providing medical information from a web site; services for the testing of blood; medical examination of individuals; consultancy provided via the internet in the field of body and beauty care; diet planning and supervision; medical treatment services provided by clinics and hospitals; providing information relating to dietary and nutritional supplements; providing information relating to the treatment of cardiovascular and cerebrovascular diseases via the internet; medical clinic services; health consultancy;



services for the provision of medical care information; medical analysis services for cancer diagnosis and prognosis; provision of medical treatment; nursing care; conducting of medical examinations; medical consultancy for selecting appropriate wheelchairs, commodes, invalid hoists, walking frames and beds; information services relating to contact lenses; providing information via the internet in the field of diabetes; medical services in the field of in vitro fertilization; medical diagnostic services; analysis of human tissues for medical treatment; medical health assessment services; providing information in the field of health via a website; medical services relating to the removal, treatment and processing of bone marrow; sports medicine services; information relating to blood donation; trans-telephone heart monitoring services; pharmaceutical advice; preparation of medical reports, other than dentistry; medical analysis for the diagnosis and treatment of persons; provision of information relating to psychology; services for the testing of urine; medical information; nursing homes.

(260) AM 2022 116886 A

(800) 1647599

(151) 2021 12 07

(891) 2021 12 07

(731) Larkpark Services Inc., Trident Trust Company, (B.V.I.)  
Trident Chambers, P.O. Box 146, Road Town,  
Tortola, Virgin Islands (British)

(540)



**TINKOFF**  
**CLOUDPAYMENTS**

(591) Black, white, yellow

(531) 23.05.05; 24.01.09; 24.01.13; 24.01.18;  
24.01.19; 24.09.02; 25.01.09; 27.05.10;  
29.01.13

(511)

9 – Cash registers; answering machines; automated teller machines [ATM]; disks, magnetic; wearable video display monitors; electronic numeric displays; electronic interactive whiteboards; electronic notice boards; interfaces for computers; identity cards, magnetic; encoded magnetic cards; encoded key cards; computers; laptop computers; tablet computers; notebook computers; downloadable e-wallets; money counting and sorting machines; magnetic data media; computer hardware; computer software, recorded; transmitters [telecommunication]; transmitters of electronic signals; digital signs; computer software applications, downloadable; computer game software, downloadable; computer game software, recorded; computer programs, recorded; computer screen saver software, recorded or downloadable; computer programs, down-

loadable; computer operating programs, recorded; electronic publications, downloadable; integrated circuit cards [smart cards]; audiovisual teaching apparatus; data processing apparatus; bar code readers; video recorders; couplers [data processing equipment]; readers [data processing equipment]; downloadable image files; downloadable music files; chips [integrated circuits].

35 – Arranging subscriptions to telecommunication services for others; commercial information agency services; advertising agency services; cost price analysis; rental of advertising space; business auditing; financial auditing; business intermediary services relating to the matching of potential private investors with entrepreneurs needing funding; employment agency services; computerized file management; book-keeping; outsourced administrative management for companies; invoicing; demonstration of goods; transcription of communications [office functions]; opinion polling; market studies; business investigations; business research; marketing research; personnel recruitment; consultancy regarding advertising communication strategies; consultancy regarding public relations communication strategies; business management and organization consultancy; business organization consultancy; business management consultancy; personnel management consultancy; professional business consultancy; layout services for advertising purposes; marketing; marketing in the framework of software publishing; targeted marketing; business management of performing artists; business management of sports people; writing of curriculum vitae for others; scriptwriting for advertising purposes; news clipping services; updating and maintenance of information in registries; updating and maintenance of data in computer databases; updating of advertising material; word processing; online retail services for downloadable and pre-recorded music and movies; organization of exhibitions for commercial or advertising purposes; arranging newspaper subscriptions for others; organization of fashion shows for promotional purposes; organization of trade fairs; shop window dressing; business appraisals; payroll preparation; data search in computer files for others; sponsorship search; administrative assistance in responding to calls for tenders; business management assistance; commercial or industrial management assistance; commercial intermediation services; providing business information; providing business information via a website; providing commercial and business contact information; providing commercial information and advice for consumers in the choice of products and services; provision of an online marketplace for buyers and sellers of goods and services; providing user reviews for commercial or advertising purposes; web indexing for commercial or advertising purposes; providing user rankings for commercial or advertising purposes; presentation of goods on communication media, for retail purposes; media relations services; economic forecas-



ting; auctioneering; sales promotion for others; promotion of goods and services through sponsorship of sports events; production of teleshopping programmes; production of advertising films; rental of advertising time on communication media; publicity material rental; rental of billboards [advertising boards]; rental of vending machines; rental of sales stands; consumer profiling for commercial or marketing purposes; publication of publicity texts; radio advertising; bill-posting; distribution of samples; dissemination of advertising matter; registration of written communications and data; writing of publicity texts; advertising; online advertising on a computer network; advertising by mail order; television advertising; compilation of information into computer databases; compilation of statistics; business inquiries; systemization of information into computer databases; advisory services for business management; corporate communications services; negotiation of business contracts for others; negotiation and conclusion of commercial transactions for third parties; compiling indexes of information for commercial or advertising purposes; tax preparation; drawing up of statements of accounts; telemarketing services; interim business management; business management for freelance service providers; commercial administration of the licensing of the goods and services of others; business management of reimbursement programmes for others; administration of consumer loyalty programs; administration of frequent flyer programs; administrative processing of purchase orders; public relations; commercial lobbying services; competitive intelligence services; market intelligence services; website traffic optimization; tax filing services; search engine optimization for sales promotion; appointment scheduling services [office functions]; price comparison services; pay per click advertising; procurement services for others [purchasing goods and services for other businesses]; outsourcing services [business assistance]; telephone answering for unavailable subscribers; telephone switchboard services; business efficiency expert services.

36 – Credit bureau services; debt collection agency services; financial analysis; rental of apartments; rental of offices for co-working; rental of real estate; rental of offices [real estate]; hire-purchase financing; savings bank services; accommodation bureau services [apartments]; rent collection; issuance of travellers' cheques; issuance of credit cards; issuance of tokens of value; capital investment; financial research; clearing, financial; insurance consultancy; financial consultancy; debt advisory services; stock exchange quotations; crowdfunding; lending against security; business liquidation services, financial; brokerage; financial management; exchanging money; online banking; processing of debit card payments; processing of credit card payments; financial exchange of virtual currency; real estate affairs; factoring; organization of monetary collections; arranging finance for construction projects; antique appraisal; jewellery appraisal;

financial evaluation of standing timber; stamp appraisal; real estate appraisal; numismatic appraisal; art appraisal; financial evaluation of development costs relating to the oil, gas and mining industries; financial valuation of intellectual property assets; financial evaluation of wool; financial evaluation [insurance, banking, real estate]; financial appraisals in responding to calls for tenders; repair costs evaluation [financial appraisal]; rental of farms; electronic funds transfer; surety services; securities brokerage; real estate brokerage; brokerage of carbon credits; insurance brokerage; providing insurance information; providing rebates at participating establishments of others through use of a membership card; loans [financing]; pawnbrokerage; providing financial information; providing financial information via a website; cheque verification; investment of funds; charitable fund raising; stocks and bonds brokerage; financial sponsorship; mortgage banking; instalment loans; insurance underwriting; life insurance underwriting; health insurance underwriting; accident insurance underwriting; marine insurance underwriting; fire insurance underwriting; apartment house management; real estate management; financial management of reimbursement payments for others; real estate agency services; actuarial services; banking; stock brokerage services; e-wallet payment services; retirement payment services; bail-bonding; preparation of quotes for cost estimation purposes; electronic transfer of virtual currencies; trusteeship; provident fund services; financial customs brokerage services; mutual funds; financing services; safe deposit services; deposits of valuables; fiscal valuation.

42 – Computer system analysis; recovery of computer data; computer virus protection services; installation of computer software; research and development of new products for others; website design consultancy; computer security consultancy; information technology [IT] consultancy; consultancy in the design and development of computer hardware; computer software consultancy; data security consultancy; technological consultancy; updating of computer software; monitoring of computer systems to detect breakdowns; monitoring of computer systems by remote access; software as a service [SaaS]; maintenance of computer software; conversion of data or documents from physical to electronic media; providing information relating to computer technology and programming via a website; providing search engines for the internet; conversion of computer programs and data, other than physical conversion; computer system design; computer rental; rental of computer software; development of computer platforms; computer software design; creating and designing website-based indexes of information for others [information technology services]; creating and maintaining websites for others; hosting computer sites [web sites]; computer programming; technical writing; off-site data backup; telecommunications technology consultancy; user authentication services

using technology for e-commerce transactions; electronic data storage; electronic monitoring of credit card activity to detect fraud via the internet; electronic monitoring of personally identifying information to detect identity theft via the internet.

(260) AM 2022 116891 A

(800) 1647788

(151) 2021 12 18

(891) 2021 12 18

(731) Yiwu Ackiliss Electric Co., Ltd.

Room 2205, Block B, Futian Yinzuo, No.99,  
Financial 6 Street, Financial Business District,  
Futian Street, Yiwu City, 322000 Jinhua,  
Zhejiang, China

(540)

**RAF**

(591) Black, white

(531) 27.05.01; 27.05.17

(511)

7 – Juice extractors, electric; whisks, electric, for household purposes; beaters, electric; washing machines [laundry]; steam mops; dust exhausting installations for cleaning purposes; kitchen machines, electric; mixing machines; food preparation machines, electro-mechanical; meat choppers [machines].

8 – Hand tools, hand-operated; scissors; vegetable knives; flat irons; egg slicers, non-electric; fruit segmenters; vegetable slicers; table cutlery [knives, forks and spoons]; plastic spoons, table forks and table knives; kitchen mandolines.

11 – Head torches; air fryers; kettles, electric; coffee machines, electric; fabric steamers; hair driers; electric fans for personal use; radiators, electric; refrigerating cabinets; cooking apparatus and installations.

(260) AM 2022 116892 A

(800) 1647819

(151) 2022 01 12

(891) 2022 01 12

(731) Joint Stock Company "United Chemical Company "Uralchem"

Presnenskaya nab., 6, bld. 2, RU-123112  
Moscow, Russian Federation

(540)

**URALCHEM**

(591) Black, white

(531) 27.05.01

(511)

1 – Chemicals for use in industry, science and photography, as well as in agriculture, horticulture and forestry; fertilizers.

5 – Acaricides; dietary supplements for animals; insecticides; pesticides; vitamin preparations; preparations for repelling and destroying vermin; preparations for destroying noxious animals; slug exterminating preparations; preparations of trace elements for human and animal use; fungicides; herbicides.

9 – Software.

35 – Advertising; business management services; business administration services.

37 – Construction; repair; installation services.

39 – Transport; packaging and storage of goods.

42 – Scientific and technological services and research and design relating thereto; industrial analysis and industrial research services; design and development of computer hardware and software.

(260) AM 2022 116893 A

(800) 1647825

(151) 2021 10 07

(891) 2021 10 07

(731) Euro Games Technology Ltd.

4, "Maritsa" Str., "Vranya-Lozen-Triugulnika",  
BG-1151 Sofia, Bulgaria

(540)

**SPINNING CROWN**

(591) Red, orange, yellow and brown

(531) 24.09.07; 27.03.15; 27.05.10; 29.01.14

(511)

9 – Software; computer gaming software; computer software packages; computer operating system software; computer software, recorded; software drivers; virtual reality software; games software; entertainment software for computer games; computer programs for network management; operating computer software for main frame computers; monitors (computer hardware); computer hardware; apparatus for recording images; monitors (computer programs); computer game programs; computer programs for recorded games; apparatus for recording, transmission or reproduction of sound or images; communications servers [computer hardware]; electronic components for gambling machines; computer application software featuring games and gaming; computer software for the administration of on-line games and gaming; computer hardware for games and gaming; hardware and software for gambling, gambling machines, gambling games on the Internet and via telecommunication network.

28 – Gaming machines for gambling; chips for gambling; mah-jong; arcade games; gambling machines operating with coins, notes and cards; games; electro-

nic games; parlor games; gaming chips; gaming tables; slot machines [gaming machines]; LCD game machines; slot machines and gaming devices; coin-operated amusement machines; roulette chips; poker chips; chips and dice [gaming equipment]; equipment for casinos; roulette tables; gaming roulette wheels; casino games; automats and gambling machines; coin-operated machines and/or electronic coin-operated machines with or without the possibility of gain; boxes for coin-operated machines, slot machines and gaming machines; electronic or electrotechnical gaming devices, automats and machines, coin-operated machines; housings for coin-operated machines, gaming equipment, gaming machines, machines for gambling; electropneumatic and electrical gambling machines (slot machines).

41 – Gambling; services related to gambling; gaming services for entertainment purposes; casino, gaming and gambling services; training in the development of software systems; provision of gaming equipment for gambling halls; providing casino equipment [gambling]; gaming machine entertainment services; providing casino facilities [gambling]; halls with gaming machines; amusement arcade services; games equipment rental; rental of gaming machines; providing amusement arcade services; rental of gaming machines with images of fruits; editing or recording of sounds and images; sound recording and video entertainment services; hire of sound reproducing apparatus; provision of gaming equipment for casinos; providing of casino facilities; online gambling services; casino management services; operation of gaming establishments, gaming halls, internet casinos, online gambling sites.

(260) AM 2022 116894 A

(800) 1647855

(151) 2021 11 16

(891) 2021 11 16

(731) Dmitry Petrovich Shmarov

Dayev lane, 4, sq. 20, RU-107045 Moscow,  
Russian Federation

(540)

**BÖDEN**  
TEAM WORK

(591) Red, white

(531) 26.04.02; 26.04.05; 26.04.18; 27.05.10;  
27.05.17; 27.05.24; 29.01.12

(511)

37 – Asphaltting; drilling of deep oil or gas wells; drilling of wells; rebuilding engines that have been worn or partially destroyed; rebuilding machines that have been worn or partially destroyed; renovation of clothing; retreading of tyres; vulcanization of tyres [repa-

ir]; building sealing; linen ironing; pressing of clothing; disinfecting; mining extraction; vehicle battery charging; charging of electric vehicles; knife sharpening; building insulating; bricklaying; riveting; construction consultancy; varnishing; re-tinning; installation of utilities in construction sites; scaffolding; road paving; window cleaning; vehicle washing; building construction supervision; tuning of musical instruments; upholstery; rustproofing; anti-rust treatment for vehicles; sanding; pumicing; strong-room maintenance and repair; vehicle maintenance; paper hanging; painting or repair of signs; cleaning of buildings [exterior surface]; vehicle polishing; vehicle breakdown repair services; providing information relating to repairs; providing construction information; rental of bulldozers; rental of drainage pumps; rental of dish drying machines; rental of road sweeping machines; rental of cleaning machines; rental of cranes [construction equipment]; rental of dishwashing machines; rental of laundry washing machines; rental of construction equipment; rental of excavators; laying of cable; plumbing; masonry; roofing services; painting services; carpentry services; underwater repair; plastering; quarrying services; repair of security locks; umbrella repair; parasol repair; motor vehicle maintenance and repair; burner maintenance and repair; film projector repair and maintenance; airplane maintenance and repair; safe maintenance and repair; clock and watch repair; repair of power lines; pump repair; upholstery repair; shoe repair; clothing repair; photographic apparatus repair; furniture restoration; restoration of musical instruments; restoration of works of art; vehicle greasing; demolition of buildings; warehouse construction and repair; vehicle service stations [refuelling and maintenance]; sterilization of medical instruments; washing; washing of linen; construction; pier breakwater building; pipeline construction and maintenance; underwater construction; harbour construction; factory construction; building of fair stalls and shops; shipbuilding; cleaning of buildings [interior]; snow removal; street cleaning; vermin exterminating, other than for agriculture, aquaculture, horticulture and forestry; housekeeping services [cleaning services]; tyre balancing; pest control services, other than for agriculture, aquaculture, horticulture and forestry; hydraulic fracturing services; refilling of toner cartridges; refilling of ink cartridges; cell phone battery charging services; artificial snow-making services; laundering; services of electricians; installation of doors and windows; irrigation devices installation and repair; elevator installation and repair; installation and repair of flood protection equipment; heating equipment installation and repair; burglar alarm installation and repair; furnace installation and repair; telephone installation and repair; installation and repair of air-conditioning apparatus; fire alarm installation and repair; freezing equipment installation and repair; electric appliance installation and repair; kitchen equipment installation; installation, maintenance and repair of

computer hardware; machinery installation, maintenance and repair; office machines and equipment installation, maintenance and repair; interference suppression in electrical apparatus; swimming-pool maintenance; furniture maintenance; chimney sweeping; boiler cleaning and repair; cleaning of clothing; dry cleaning; vehicle cleaning; diaper cleaning; leather care, cleaning and repair; fur care, cleaning and repair.

(260) AM 2022 116898 A  
 (800) 1647939  
 (151) 2021 12 13  
 (891) 2021 12 13  
 (731) Passaggio Obbligato S.p.A.  
 Piazza Cavour 3, Milano, Italy  
 (540)

## NARACAMICIE

(591) Black, white  
 (511)  
 18 – Luggage, bags, wallets and other carrying bags; leather and imitations of leather.  
 25 – Clothing; footwear; parts of clothing, footwear and headgear included in class 25; shirts.

(260) AM 2022 116899 A  
 (800) 1647953  
 (151) 2022 01 11  
 (891) 2022 01 11  
 (731) Chekhlov Aleksei Gennad'evich  
 Dachnaya str., d. 9B, dp dsk "Michurinec",  
 RU-142784 Moscow, Russian Federation  
 (540)

**neogalen – колени в порядке**

(591) Black, white  
 (531) 24.17.01; 27.05.01; 28.05  
 (511)  
 3 – Balms, other than for medical purposes; cosmetics, including beauty gels, cosmetic creams, beauty masks, oils for cosmetic purposes, mousses [cosmetics], lotions for cosmetic purposes, skin exfoliants, facial emulsions for cosmetic purposes, body emulsions for cosmetic purposes, beauty milk; cosmetics for use on the skin; cosmetics for personal use; cosmetics and toiletries; massage gels, other than for medical purposes; massage oils, balms and lotions; essential oils; cosmetic kits; sanitary preparations being toiletries; pre-moistened cosmetic wipes; cleaning pads impregnated with cosmetics; bath salts, not for medical purposes; cosmetic preparations for baths.

(260) AM 2022 116900 A  
 (800) 1647954  
 (151) 2022 01 11  
 (891) 2022 01 11  
 (731) Chekhlov Aleksei Gennad'evich  
 Dachnaya str., d. 9B, dp dsk "Michurinec",  
 RU-142784 Moscow, Russian Federation  
 (540)

## NEOGALEN

(591) Black, white  
 (511)  
 3 – Cosmetics, including cosmetic creams, beauty gels, beauty masks, balms, other than for medical purposes; oils for cosmetic purposes; shampoos; cosmetic preparations for slimming purposes; cosmetic pencils; essential oils; lotions for cosmetic purposes; cosmetic kits; non-medicated dentifrices; deodorants for personal use; sanitary preparations being toiletries; wipes impregnated with cosmetic preparations; bath salts, not for medical purposes; cosmetic preparations for baths.

(260) AM 2022 116901 A  
 (800) 1647962  
 (151) 2022 01 19  
 (891) 2022 01 19  
 (731) BAUSCH + LOMB IRELAND LIMITED  
 3013 Lake Drive, Citywest Business Campus,  
 Dublin 24, Ireland  
 (540)

## SEENOVA

(591) Black, white  
 (511)  
 10 – Ophthalmic microsurgical apparatus and instruments for use in ocular or eye-related procedures.

(260) AM 2022 116902 A  
 (800) 1647964  
 (151) 2022 01 19  
 (891) 2022 01 19  
 (731) BAUSCH + LOMB IRELAND LIMITED  
 3013 Lake Drive, Citywest Business Campus,  
 Dublin 24, Ireland  
 (540)

## ILUMA

(591) Black, white  
 (511)  
 10 – Ophthalmic microsurgical apparatus and instruments for use in ocular or eye-related procedures.

(260) AM 2022 116910 A

(800) 1648154

(151) 2021 10 19

(891) 2021 10 19

(731) TELESPAZIO S.P.A.

VIA TIBURTINA 965, I-00156 ROMA, Italy

(540)



(591) Red

(531) 24.17.01; 26.01.03; 26.11.02; 26.11.12;

27.05.01; 27.05.09; 27.05.10; 29.01.01

(511)

9 – Electronic equipment and software for controlling satellites; electronic equipment and software for the acquisition and processing of satellite data and images; electronic equipment and software for the acquisition and processing of satellite data and images for monitoring the earth's surface and seas; electronic equipment and software for consultation, analysis and use of satellite data and images; electronic equipment and software for identification, processing and monitoring of data from space and / or from ground of the earth's surface and seas; electronic publications.

38 – Satellite and / or ground telecommunication services relating to satellite data and images; communication services via the internet or telematics for consultation, analysis and use of satellite data and images; services via the Internet or telematics by subscription for access to an informatic platform for consultation, analysis and use of satellite data and images.

42 – Satellite monitoring services; services for the acquisition and processing of satellite data and images; services for the acquisition and processing of satellite data and images for monitoring the earth's surface and seas; services for the analysis and use of satellite data and images: data processing and monitoring services from space and / or from ground of the earth's surface and seas.

45 – Services for the acquisition, monitoring, analysis, processing and use of satellite data and / or images for the protection of persons and property; license of rights to use satellite data and / or images; copyright license; licensing of intellectual property rights.

(260) AM 2022 116911 A

(800) 1648216

(151) 2021 12 21

(891) 2021 12 21

(731) Bestway Inflatables & Materials Corporation  
No. 208 Jinyuanwu Road, 201812 Shanghai,  
China

(540)

## BESTWAY

(591) Black, white

(511)

35 – On-line wholesale and retail store services and web-based catalog services featuring air beds, not for medical purposes, air cushions, not for medical purposes, air mattresses, not for medical purposes, air pillows, not for medical purposes, air pumps, hand-operated, all-purpose sport bags, awnings of synthetic materials specially adapted for use with inflatables and recreational equipment, namely, air floats, backpacks, all-purpose carrying bags, bags especially designed for skis and surfboards, bath tubs, beach bags, canoes, central vacuum cleaning installations, chairs, chemical test paper, compressed air machine components, namely, valves, compressed air pumps, disinfectant dispensers for swimming pools and bath tubs, divers' masks, breathing apparatus for underwater swimming, ear plugs and nose clips for divers and swimmers, filters for non-medical respiratory mask, frames for supporting swimming pools, hammocks, horizontal and vertical tube connectors, hydro massage bath apparatus, inflatable bathtubs for babies, inflatable boats, inflatable floats for swimming pool, inflatable furniture, inflatable pools for recreational use, inflatable ride-on toys, inflatable sofas, inflatable swimming pools, inflatable toys and structures for recreational use, inflatable water and playground slides, machines and apparatus for cleaning pools, electric, namely, automatic swimming pool vacuums and cleaners, mast for sailboards, metal swimming pools, non-metal floating containers for storage, non-metal swimming pools, oars, paddleboards, play balloons, pumps for counter-current swimming, respiratory masks for non-medical purposes, sleeping bags for camping, sleeping bags for kids, sleeping pads, sleeping mats, spas in the nature of heated pools, surf skis, surfboards, swim caps, swimming accessories, swimming pool air floats, swimming pool chlorinating apparatus, swimming pool water cleaning and filtering units, swimsuits, travelling bags, vacuum pumps, valves as machine components, water filtering apparatus.

(260) AM 2022 116912 A

(800) 1648232

(151) 2022 01 19

(891) 2022 01 19

(731) BAUSCH + LOMB IRELAND LIMITED

3013 Lake Drive, Citywest Business Campus,  
Dublin 24, Ireland

(540)

## SEELUMA

(591) Black, white



(511)  
10 – Ophthalmic microsurgical apparatus and instruments for use in ocular or eye-related procedures.

(260) AM 2022 116923 A

(800) 1648522

(151) 2021 12 13

(891) 2021 12 13

(731) Trainocate Japan Ltd.  
6-8-1, Nishishinjuku, Shinjuku-ku,  
Tokyo 163-6019, Japan

(540)

## TRAINOCATE

(591) Black, white

(511)

41 – Educational services relating to computers; education and training services relating to computer operating; educational examination for users to qualify to computer engineering; educational services relating to development of computer software; education and training services relating to computer programming; education and training services in the field of data processing; arranging, conducting and organization of seminars in the field of computers and communication technologies; arranging, conducting and organization of seminars relating to computer programming; arranging, conducting and organization of seminars; providing on-line publications.

(260) AM 2022 116924 A

(800) 1648523

(151) 2021 12 13

(891) 2021 12 13

(731) Trainocate Japan Ltd.  
6-8-1, Nishishinjuku, Shinjuku-ku,  
Tokyo 163-6019, Japan

(540)



(591) Orange

(531) 26.01.03; 26.01.12; 26.03.23; 29.01.12

(511)

41 – Educational services relating to computers; education and training services relating to computer operating; educational examination for users to qualify to computer engineering; educational services relating to development of computer software; education and training services relating to computer programming; education and training services in the field of

data processing; arranging, conducting and organization of seminars in the field of computers and communication technologies; arranging, conducting and organization of seminars relating to computer programming; arranging, conducting and organization of seminars; providing on-line publications.

(260) AM 2022 116925 A

(800) 1648527

(151) 2022 01 04

(891) 2022 01 04

(731) Van Pur S.A.  
ul. Cyberbetyki 7, PL-02-677 Warszawa,  
Poland

(540)



(591) Blue, gold and grey

(531) 27.05.02; 27.05.03; 29.01.13

(511)

32 – Beer, non-alcoholic beer.

(260) AM 2022 116926 A

(800) 1648575

(151) 2022 01 18

(891) 2022 01 18

(731) Vantage Specialty Chemicals, Inc.  
4650 South Racine Avenue, Chicago IL  
60609-3321, USA

(540)

## SENSEID

(591) Black, white

(511)

42 – Product research for others; product research and development for others; product research and development for others in the field of personal care products; product research and development for others in relation to deodorants, antiperspirants, cosmetics, baby care, hair care, skin care, sun care, bath/shower products, cosmetic creams, lotions, shampoos, hair conditioners, hair gels, fragrances, and pet grooming preparations.

(260) AM 2022 116927 A

(800) 159681

(151) 1952 02 11

(891) 2022 02 16

(731) DENTINOX GESELLSCHAFT FÜR  
PHARMAZEUTISCHE PRÄPARATE LENK  
& SCHUPPAN  
Nunsdorfer Ring 19, 12277 Berlin,  
Germany

(540)

**Dentinox**

(591) Black, white  
 (531) 27.05.01; 27.05.17  
 (511)

5 – Chemical pharmaceutical preparations, disinfectants, dental care products, teething remedies for children.

---

(260) AM 2022 116928 A

(800) 735519  
 (151) 2000 06 06  
 (891) 2022 02 15  
 (731) Bayer S.A.S.

16, rue Jean-Marie Leclair, F-69009 LYON,  
 France

(540)

**ATLANTIS**

(591) Black, white  
 (511)  
 5 – Herbicides.

---

(260) AM 2022 116929 A

(800) 798070  
 (151) 2002 12 04  
 (891) 2022 01 31  
 (731) Jemie B.V.

Beneluxweg 37, NL-4904 SJ OOSTERHOUT,  
 Netherlands

(540)

**CANNA****The solution for growth and bloom**

(591) Black, white  
 (531) 27.05.01; 27.05.11  
 (511)

1 – Chemicals used in agriculture, horticulture and forestry; manures and fertilizers.

---

(260) AM 2022 116930 A

(800) 966191  
 (151) 2008 01 14  
 (891) 2022 02 03

(731) Obschestvo s ogranichennoyi otvetstvennostiu  
 "Valbrenta Chemicals"  
 Lyuberetskiy r-n, pos. Tomolino, Rayon  
 Ptitsefabrika, RU-140073 Moskovskaya Oblast,  
 Russian Federation

(540)

**TRAPCOLL**

(591) Black, white  
 (531) 27.05.01  
 (511)

1 – Industrial chemicals; gums (adhesives), other than for stationery or household purposes; adhesives for industrial purposes; birdlime.

5 – Preparations for destroying noxious animals; preparations for destroying noxious plants; fly destroying preparations; preparations for destroying mice; vermin destroying preparations; fly catching paper.

---

(260) AM 2022 116931 A

(800) 1099969  
 (151) 2011 11 11  
 (891) 2022 02 15  
 (731) Montres Tudor SA

Rue François-Dussaud 3, CH-1211 Genève 26,  
 Switzerland

(540)

**TUDORWATCH**

(591) Black, white  
 (511)

14 – Jewelry, horological items, namely watches, wristwatches, component parts for horological items and accessories for horological items not included in other classes, clocks and other chronometric instruments, chronometers, chronographs, apparatus for timing sports events, apparatus and instruments for marking and measuring time not included in other classes; dials, clock hands (clock and watch making), cases, boxes and presentation cases for timepieces and jewelry.

---

(260) AM 2022 116932 A

(800) 1104945  
 (151) 2011 07 05  
 (891) 2022 01 28  
 (731) KONTOR N GmbH & Co. KG

Greifswalder Chaussee 84-85, 18439 Stralsund,  
 Germany

(540)

**Störtebeker**

(591) Black, white  
 (511)

32 – Beers; mineral and aerated waters and other non-alcoholic drinks; fruit drinks and fruit juices; syrups and other preparations for making beverages; non-alcoholic fruit extracts; non-alcoholic fruit drinks; non-alcoholic drinks; non-alcoholic honey based beverages; non-alcoholic aperitifs; apple juice (sweetened

fruit juice) (sweetened apple juice); beer wort; powders for effervescent beverages; pastilles for effervescent beverages; non-alcoholic cocktails; peanut milk (non-alcoholic); preparations for making mineral water; preparations for making aerated water; essences for making beverages; fruit drinks; fruit nectars (non-alcoholic); fruit juices; vegetable juices [beverages]; extracts of hops for making beer; ginger beer; isotonic beverages; aerated waters; kvass (non-alcoholic beverages); lemonades; syrups for lemonade; lithia water; malt beer; malt wort; milk of almonds (beverage); orgeat; mineral water (beverages); whey beverages; must; products for making beverages; preparations for making liqueurs; sarsaparilla (soft drink); seltzer water; syrups for beverages; soda water; sherbets (beverages); table waters; tomato juice (beverage); unfermented grape must; waters [beverages].

---

(260) AM 2022 116934 A  
 (800) 1264589  
 (151) 2014 12 19  
 (891) 2022 02 15  
 (731) Vitabiotics Ltd  
 1 Apsley Way, London NW2 7HF,  
 United Kingdom  
 (540)

## CARDIOACE

(591) Black, white  
 (511)  
 5 – Pharmaceutical preparations; multivitamin and food supplement preparations; all the aforesaid goods for use in the treatment of heart conditions or the maintenance of the heart; all included in this class.

---

(260) AM 2022 116935 A  
 (800) 1264992  
 (151) 2014 12 19  
 (891) 2022 02 15  
 (731) Vitabiotics Ltd  
 1 Apsley Way, London NW2 7HF,  
 United Kingdom  
 (540)

## JOINTACE

(591) Black, white  
 (511)  
 5 – Pharmaceutical preparations; vitamin and mineral preparations, food supplement preparations; all for the treatment of conditions affecting the joints or bones, including arthritis and arthritic pain.

(260) AM 2022 116936 A  
 (800) 1264993  
 (151) 2014 12 19  
 (891) 2022 02 15  
 (731) Vitabiotics Ltd  
 1 Apsley Way, London NW2 7HF,  
 United Kingdom  
 (540)

## MENOPACE

(591) Black, white  
 (511)  
 5 – Pharmaceutical preparations and vitamin preparations, all for use in connection with the menopause; all included in this class.

---

(260) AM 2022 116937 A  
 (800) 1264997  
 (151) 2014 12 19  
 (891) 2022 02 15  
 (731) Vitabiotics Ltd  
 1 Apsley Way, London NW2 7HF,  
 United Kingdom  
 (540)

## OSTEOCARE

(591) Black, white  
 (511)  
 5 – Pharmaceutical preparations; vitamin and mineral preparations; all for infants and invalids; all for the prevention of bone deficiency; all included in this class.

---

(260) AM 2022 116938 A  
 (800) 1264999  
 (151) 2014 12 19  
 (891) 2022 02 15  
 (731) Vitabiotics Ltd  
 1 Apsley Way, London NW2 7HF,  
 United Kingdom  
 (540)

## WELLKID

(591) Black, white  
 (511)  
 5 – Pharmaceutical preparations, vitamin and mineral preparations, food preparations, all for infants.

---

(260) AM 2022 116939 A  
 (800) 1265000  
 (151) 2014 12 19  
 (891) 2022 02 15  
 (731) Vitabiotics Ltd  
 1 Apsley Way, London NW2 7HF,  
 United Kingdom



(540)

**PREGNACARE**

(591) Black, white

(511)

5 – Medicated preparations and vitamin preparations, all for use as supplements for foods for pregnant women.

(260) AM 2022 116940 A

(800) 1265001

(151) 2014 12 19

(891) 2022 02 15

(731) Vitabiotics Ltd

1 Apsley Way, London NW2 7HF,  
United Kingdom

(540)

**PERFECTIL**

(591) Black, white

(511)

5 – Pharmaceutical preparations, vitamin and mineral preparations, food preparations for infants and invalids; all included in this class.

(260) AM 2022 116941 A

(800) 1265003

(151) 2014 12 19

(891) 2022 02 15

(731) Vitabiotics Ltd

1 Apsley Way, London NW2 7HF,  
United Kingdom

(540)

**VISIONACE**

(591) Black, white

(511)

5 – Pharmaceutical preparations, vitamin and mineral preparations, food supplement preparations, all for the treatment of the eyes and ocular conditions.

(260) AM 2022 116942 A

(800) 1265004

(151) 2015 01 30

(891) 2022 02 15

(731) Vitabiotics Ltd

1 Apsley Way, London NW2 7HF,  
United Kingdom

(540)

**WELLMAN**

(591) Black, white

(511)

5 – Multivitamin tablets or capsules, all for human use.

(260) AM 2022 117003 A

(800) 1648758

(151) 2022 01 07

(891) 2022 01 07

(731) Powertrain Engineering Sweden AB

Gunnar Engellaus väg, SE-418 78 Göteborg,  
Sweden

(540)



(591) Black, white

(531) 26.11.03; 26.11.06; 26.11.12

(511)

9 – Smartphone software applications, downloadable; computer software applications, downloadable; navigation apparatus for vehicles on-board computers; audio- and video-receivers; measuring instruments; electronic control units for automobile; car batteries; inverters; simulators for the steering and control of vehicles; electronic key fobs being remote control apparatus; integrated circuits; fuel cells for vehicles.

12 – Speed change gears for land vehicles; gear boxes for land vehicles; automobile engines; engines for land vehicles; motors, electric, for land vehicles; cars; electric vehicles; vehicles for locomotion by land, air, water or rail; upholstery for vehicles; couplings for land vehicles; clutches for land vehicles; torque converters for land vehicles; self-balancing electric scooters; propulsion mechanisms for land vehicles.

37 – Motor vehicle maintenance and repair; vehicle battery replacement service; vehicle breakdown repair services; vehicle greasing; vehicle battery charging; anti-rust treatment for vehicles; vehicle washing; re-reading of tires; vehicle service stations refueling and maintenance; reconditioning of automobiles.

42 – Consultancy within design and development of powertrain, development of software related to powertrain, and manufacturing engineering for powertrain.

(260) AM 2022 117004 A

(800) 1648769

(151) 2022 01 20

(891) 2022 01 20

(731) Belyaev Sergey Ivanovich

ul. Kirova, d. 56, kv. 62, g. Novokuznetsk,  
RU-654000 Kemerovskaya obl, Russian  
Federation

(540)



(591) red, white

(531) 26.01.02; 26.01.04; 26.01.20; 26.01.24; 28.05; 29.01.12

(511)

30 – Coffee; tea; cocoa; sugar; rice; tapioca; sago; coffee substitutes; bread; unleavened bread; pastries; ice cream; honey; yeast; baking powder; cooking salt; mustard; vinegar; condiments; spices; edible ices; aromatic preparations for food; flavourings, other than essential oils, for cakes; flavourings, other than essential oils, for beverages; coffee flavourings; food flavourings, other than essential oils; star aniseed; cereal bars; high-protein cereal bars; pancakes; noodle-based prepared meals; buns; bread rolls; vanillin [vanilla substitute]; waffles; vermicelli; natural sweeteners; sausage binding materials; binding agents for ice cream; seawater for cooking; seaweed [condiment]; malt biscuits; cloves [spice]; cake frosting [icing]; glucose for culinary purposes; gluten additives for culinary purposes; thickening agents for cooking foodstuffs; leaven; rice-based snack food; cereal-based snack food; vegetal preparations for use as coffee substitutes; dressings for salad; fruit jellies [confectionery]; confectionery for decorating Christmas trees; cakes; peanut confectionery; almond confectionery; pasta; pies; ground ginger; frozen yogurt [confectionery ices]; capers; caramels [sweets]; caramels [candies]; curry [spice]; ketchup [sauce]; quiches; gluten prepared as foodstuff; sweets; candies; liquorice [confectionery]; peppermint sweets; cinnamon [spice]; unroasted coffee; starch for food; crackers; custard; hominy grits; semolina; oatmeal; crushed barley; groats for human food; corn, milled; maize, milled; corn, roasted; maize, roasted; meat pies; turmeric; couscous; noodles; ice, natural or artificial; rice cakes; mayonnaise; macarons; macaroni; maltose; hominy; marinades; marzipan; royal jelly; bean meal; tapioca flour; potato flour; corn flour; corn meal; maize flour; maize meal; flour; meal; wheat flour; soya flour; barley meal; confectionery in the form of mousses; chocolate mousses; muesli; mint for confectionery; cocoa beverages with milk; coffee beverages with milk; coffee-based beverages; tea-based beverages; chocolate beverages with milk; chocolate-based beverages; cocoa-based beverages; infusions, not medicinal; crushed oats; husked oats; nutmegs; stick liquorice [confectionery]; miso; lozenges [confectionery]; pastilles [confectionery]; molasses for food; pepper; allspice; peppers [seasonings]; pesto; biscuits; cookies; petit-beurre biscuits; pizzas; meat gravies; fondants [confectionery]; popcorn; powders for making ice cream;

mustard meal; pralines; meat tenderizers for household purposes; oat-based food; propolis; bee glue; gingerbread; petits fours; puddings; cake powder; fruit coulis [sauces]; ravioli; chewing gum; relish [condiment]; wheat germ for human consumption; spring rolls; palm sugar; linseed for culinary purposes [seasoning]; flaxseed for culinary purposes [seasoning]; aniseed; golden syrup; confectionery; sugar confectionery; baking soda [bicarbonate of soda for cooking purposes]; malt for human consumption; salt for preserving foodstuffs; celery salt; sorbets [ices]; sherbets [ices]; ham glaze; soya sauce; tomato sauce; pasta sauce; sauces [condiments]; spaghetti; seasonings; preparations for stiffening whipped cream; rusks; breadcrumbs; sushi; sandwiches; tabbouleh; tacos; pastry dough; cake batter; cake dough; cream of tartar for culinary purposes; tarts; dough; almond paste; tortillas; garden herbs, preserved [seasonings]; beer vinegar; ferments for pastes; halvah; chips [cereal products]; corn flakes; maize flakes; oat flakes; chicory [coffee substitute]; iced tea; chutneys [condiments]; cheeseburgers [sandwiches]; chow-chow [condiment]; saffron [seasoning]; chocolate; malt extract for food; essences for foodstuffs, except etheric essences and essential oils; husked barley.

35 – Dissemination of advertising matter; demonstration of goods; market studies; advertising; publicity; shop window dressing; marketing research; providing business information; online advertising on a computer network; presentation of goods on communication media, for retail purposes; providing business information via a website.

(260) AM 2022 117005 A

(800) 1648770

(151) 2021 12 27

(891) 2021 12 27

(731) AGRIMATCO LIMITED

GLADSTONOS 114, OASIS CENTER,

FLOOR 3, CY-3032 LIMASSOL, Cyprus

(540)

**Agrimatco**

(591) Black, green, white

(531) 01.05.02; 01.05.09; 05.03.13; 05.03.15; 27.05.01; 29.01.13

(511)

1 – Chemicals for use in forestry, except fungicides, herbicides, insecticides and parasiticides; fertilizers; fertilizing preparations.

5 – Pesticides.

7 – Agricultural implements, other than hand-operated; agricultural machines; harvesting machines; mowing and reaping machines.

8 – Agricultural forks [hand tools]; agricultural implements, hand-operated.

11 – Drip irrigation emitters [irrigation fittings].

31 – Seedlings; seeds for planting; plant seeds.

35 – Wholesale services for pharmaceutical, veterinary and sanitary preparations and medical supplies; retail services for pharmaceutical, veterinary and sanitary preparations and medical supplies.

(260) AM 2022 117006 A

(800) 1648797

(151) 2021 12 17

(891) 2021 12 17

(731) Gorokhovskaya Tatyana Germanovna  
Krasnyi prospekt, d. 49, kv. 58, RU-630091  
Novosibirsk, Russian Federation

(540)

## SIBERIAN ROSE

(591) Black, white

(511)

3 – Adhesives for cosmetic purposes; after-shave lotions; air fragrancing preparations; almond milk for cosmetic purposes; aloe vera preparations for cosmetic purposes; antiperspirant soap; antiperspirants [toilettries]; aromatics [essential oils]; astringents for cosmetic purposes; balms, other than for medical purposes; bases for flower perfumes; beauty masks; bleaching preparations [decolorants] for cosmetic purposes; breath freshening sprays; breath freshening strips; cakes of toilet soap; nail care preparations; cleansing milk for toilet purposes; cosmetic creams; cosmetic dyes; cosmetic kits; cosmetic pencils; cosmetic preparations for baths; cosmetic preparations for eyelashes; cosmetic preparations for slimming purposes; cosmetics; cotton sticks for cosmetic purposes; cotton wool for cosmetic purposes; decorative transfers for cosmetic purposes; dental bleaching gels; deodorant soap; deodorants for human beings or for animals; depilatories; dry shampoos; eau de Cologne; essential oils; eyebrow cosmetics; eyebrow pencils; false eyelashes; false nails; fumigation preparations [perfumes]; greases for cosmetic purposes; hair colorants; hair lotions; hair spray; hair waving preparations; hydrogen peroxide for cosmetic purposes; joss sticks; lip glosses; lipsticks; lotions for cosmetic purposes; make-up powder; make-up preparations; make-up removing preparations; make-up; mascara; massage gels, other than for medical purposes; mouthwashes, not for medical purposes; nail art stickers; nail polish; neutralizers for permanent waving; oils for cosmetic purposes; oils for perfumes and scents; oils for toilet purposes; perfumery; perfumes; petroleum jelly for cosmetic purposes; pomades for cosmetic purposes;

potpourris [fragrances]; cosmetic preparations for skin care; sachets for perfuming linen; scented water; scented wood; shampoos; shaving preparations; shaving soap; skin whitening creams; soap; sunscreen preparations; sun-tanning preparations [cosmetics]; talcum powder, for toilet use; tissues impregnated with cosmetic lotions; toilet water; toothpaste; vaginal washes for personal sanitary or deodorant purposes.

(260) AM 2022 117007 A

(800) 1648816

(151) 2021 10 25

(891) 2021 10 25

(731) Sharkoon Technologies GmbH  
Grüninger Weg 48, 35415 Pohlheim, Germany

(540)

## SHARKOON

(591) Black, white

(511)

16 – Desk mats.

20 – Office furniture; metal office furniture; office desks; office armchairs; office tables; computer furniture; computer cabinets [furniture]; computer tables; desks; desks and tables; chair pads; pouffes [furniture]; seating furniture; seats; chairs being office furniture; tables; tables [furniture]; worktables; swivel chairs; head-rests [furniture]; lap desks; work stations [furniture]; personal computer work stations [furniture]; mobile writing desks; desk racks [furniture]; office furniture; metal office furniture; office desks; office armchairs; office tables; computer furniture; computer cabinets [furniture]; computer tables; desks; desks and tables; chair pads; pouffes [furniture]; seating furniture; seats; chairs being office furniture; tables; tables [furniture]; worktables; swivel chairs; head-rests [furniture]; lap desks; furniture; workstations [furniture]; personal computer workstations [furniture]; mobile writing desks; desk racks [furniture].

27 – Floor coverings and artificial ground coverings; door mats.

(260) AM 2022 117008 A

(800) 1648828

(151) 2021 12 30

(891) 2021 12 30

(731) Janssen Pharmaceutica NV  
Turnhoutseweg 30, B-2340 Beerse, Belgium

(540)

## КАРВИКТИ

(591) Black, white

(531) 28.05

(511)

5 – Pharmaceutical preparations for human use.

(260) AM 2022 117009 A  
 (800) 1648875  
 (151) 2022 01 13  
 (891) 2022 01 13

(731) SALOMON SAS  
 14 chemin des Croiselets, F-74370 EPAGNY  
 METZ-TESSY, France

(540)

## TOMORROW IS YOURS

(591) Black, white

(511)

9 – Ski helmets; helmets for sports; helmets for snowboarding; cases for sunglasses; ski goggles; sunglasses; sports goggles; goggles; ski masks.

18 – Hand luggage; travel luggage; umbrellas and parasols; shoulder bags; backpacks; rucksacks on casters; sports backpacks; handbags; handbags, coin purses and wallets; hipsacks; wheeled shopping bags; fanny packs; bags for climbers; school bags; bags for campers; beach bags; sports bags; everyday bags; traveling bags; overnight bags.

25 – Socks; sports socks; footwear; climbing boots; mountaineering boots; running shoes; jogging shoes; trekking shoes; mountaineering footwear; beach shoes and sandals; ski boots, snowboard boots and parts thereof; sports footwear; training shoes; canvas footwear; waterproof footwear; sports tank tops; skiing outfit [clothing]; ski gloves; snowboard gloves; skirts; mittens; snowboard mittens; short trousers; sweatpants; sports pants and shorts; dresses; insoles for footwear; underwear; thermal underwear; sweatshirts; tee-shirts; jogging jackets; sports jackets; tracksuit jackets; waterproof jackets; fleece jackets; clothing; Wind-resistant clothing; clothing for cycling; leisurewear; rainwear; sports clothing; ski clothing.

28 – Sports articles and equipment; ski sticks; ski bindings; padded protectors for sports; protective padding (parts of sportswear); skis; snowboards.

35 – Organization of trade fairs for commercial or advertising purposes; promoting sporting competitions and events; retail sale services, including via global computer networks, for articles and equipment for sports, clothing and footwear, bags and luggage, sunglasses, ski masks, sports helmets, jewelry and timepieces, videos, DVDs, CDs and electronic games.

41 – Organization of sporting activities and competitions; organization of shows; show production; teaching of all snow sports and foot racing techniques.

(260) AM 2022 117010 A  
 (800) 1648899  
 (151) 2021 10 07  
 (891) 2021 10 07

(731) Euro Games Technology Ltd.  
 4, "Maritsa" Str., "Vranya-Lozen-Triugulnika",  
 BG-1151 Sofia, Bulgaria

(540)



(591) Pink, cyan, blue, green, purple, red, yellow and orange

(531) 27.05.04; 29.01.15

(511)

9 – Software; computer gaming software; computer software packages; computer operating system software; computer software, recorded; software drivers; virtual reality software; games software; entertainment software for computer games; computer programs for network management; operating computer software for main frame computers; monitors (computer hardware); computer hardware; apparatus for recording images; monitors (computer programs); computer game programs; computer programs for recorded games; apparatus for recording, transmission or reproduction of sound or images; communications servers [computer hardware]; electronic components for gambling machines; computer application software featuring games and gaming; computer software for the administration of on-line games and gaming; computer hardware for games and gaming; hardware and software for gambling, gambling machines, gambling games on the Internet and via telecommunication network.

28 – Gaming machines for gambling; chips for gambling; mah-jong; arcade games; gambling machines operating with coins, notes and cards; games; electronic games; parlor games; gaming chips; gaming tables; slot machines [gaming machines]; LCD game machines; slot machines and gaming devices; coin-operated amusement machines; roulette chips; poker chips; chips and dice [gaming equipment]; equipment for casinos; roulette tables; gaming roulette wheels; casino games; automats and gambling machines; coin-operated machines and/or electronic coin-operated machines with or without the possibility of gain; boxes for coin-operated machines, slot machines and gaming machines; electronic or electrotechnical gaming devices, automats and machines, coin-operated machines; housings for coin-operated machines, gaming equipment, gaming machines, machines for gambling; electropneumatic and electrical gambling machines (slot machines).

41 – Gambling; services related to gambling; gaming services for entertainment purposes; casino, gaming and gambling services; training in the development of software systems; provision of gaming equipment for gambling halls; providing casino equipment [gambling]; gaming machine entertainment services; providing casino facilities [gambling]; halls with gaming

machines; amusement arcade services; games equipment rental; rental of gaming machines; providing amusement arcade services; rental of gaming machines with images of fruits; editing or recording of sounds and images; sound recording and video entertainment services; hire of sound reproducing apparatus; provision of gaming equipment for casinos; providing of casino facilities; online gambling services; casino management services; operation of gaming establishments, gaming halls, internet casinos, online gambling sites.

(260) AM 2022 117011 A

(800) 1648903

(151) 2021 10 07

(891) 2021 10 07

(731) Avon Products, Inc.

1 Avon Place, Suffern, New York NY 10901,  
USA

(540)

## AVON

(591) Black, white

(511)

5 – Sanitary preparations and substances; pharmaceutical preparations and substances; hygienic products; medicated skin care preparations; salves, balms, gels and sprays used for providing relief from sore or tired feet and muscles, the symptoms of the common cold, and relief from insect bites, stings and skin irritations; medicated toilet preparations; medicated bath preparations; skin creams for medical use; hand creams for medical use; medicated reconditioning creams; room deodorising preparations and air deodorizing preparations; meal replacement drinks for medical use; dietetic products for invalids; medicated foodstuffs; nutritional preparations and supplements for medical purposes; food additives and supplements for medical purposes; vitamins; mineral supplements; vitamin and mineral preparations, substances and supplements; protein dietary supplements.

(260) AM 2022 117012 A

(800) 1648909

(151) 2021 10 13

(891) 2021 10 13

(731) Guangzhou Flamingo Car Care Tech Co., Ltd.

Rm. 210.211, Bld. 2, No. 129, Huangyuan  
Road, Baiyun District, Guangzhou, Guangdong,  
China

(540)

## Flamingo

(591) Black, white

(511)

1 – Transmission fluid; additives, chemical, to motor fuel; chemical additives for motor fuel; detergent additives to petrol [gasoline]; brake fluid; mould-release

preparations; combusting preparations [chemical additives to motor fuel]; anti-boil preparations for engine coolants; coolants for vehicle engines; brake fluid.

(260) AM 2022 117014 A

(800) 1648932

(151) 2021 11 19

(891) 2021 11 19

(731) NATUNUT KURUYEMİŞ GIDA İTHALAT  
İHRACAT ANONİM ŞİRKETİ

Musalla Bağları Mahallesi, Gürbudak Sokak,  
1/1, Selçuklu – Konya, Türkiye

(540)



(591) Red and white

(531) 26.04.05; 26.04.16; 26.04.18; 26.04.24;

26.11.01; 26.11.12; 27.05.01; 27.05.17;

27.05.24; 29.01.12

(511)

29 – Prepared nuts and dried fruits as snacks; dried fruits; sunflower seeds, prepared; sunflower seeds, processed; pumpkin seeds, prepared; pumpkin seeds, processed; chickpeas, dried; chickpeas, processed, peanuts, prepared; peanuts, processed, roasted nuts; roasted almonds; raisins; pistachios, prepared; pistachios, processed; flavoured nuts.

30 – Coffee, cocoa; coffee or cocoa based beverages, chocolate based beverages; corn, roasted.

(260) AM 2022 117015 A

(800) 1648935

(151) 2022 01 12

(891) 2022 01 12

(731) Kia Corporation

12, Heolleung-ro, Seocho-gu, Seoul 06797,  
Republic of Korea

(540)



Movement that inspires

(591) Black, white

(531) 27.05.01; 27.05.09; 27.05.10; 27.05.19;

27.05.22

(511)

25 – Anoraks; clothing; uniforms; leotards and tights; panties, shorts and briefs; hosiery; money belts [clot-

hing]; footwear; sports wear; overcoats (except wear for exclusive use for sports and Korean traditional dress); hanbok [Korean traditional clothing]; under garments; shirts; socks; neckties; gloves for clothing having touch technology for electronic products; caps being headwear; winter face masks (clothing); leather belts [clothing]; waterproof clothing.

(260) AM 2022 117016 A

(800) 1648939

(151) 2022 01 19

(891) 2022 01 19

(731) Kia Corporation

12, Heolleung-ro, Seocho-gu, Seoul 06797,

Republic of Korea

(540)



Movement that inspires

(591) Black, white

(531) 27.05.01; 27.05.19; 27.05.22

(511)

36 – Banking and insurance services; providing information relating to financial and monetary affairs; financing relating to automobiles; automobile lease financing; mortgage banking, lending and brokerage services; financial guarantee services for the reimbursement of expenses incurred as a result of vehicle breakdown; hire-purchase financing; consultancy and brokerage services relating to vehicle insurance; automobile insurance information; motor vehicle insurance brokerage; automobile insurance services; financial affairs; provision of information relating to real estate; credit inquiry and consultancy; financial customs brokerage services; art appraisal and antique evaluation; appraisal of precious metals; providing information relating to the appraisal of automobiles; automobile appraisal.

(260) AM 2022 117017 A

(800) 1648940

(151) 2022 01 19

(891) 2022 01 19

(731) Kia Corporation

12, Heolleung-ro, Seocho-gu, Seoul 06797,

Republic of Korea

(540)



Movement that inspires

(591) Black, white

(531) 27.05.01; 27.05.19; 27.05.22

(511)

38 – Data transmission and data broadcasting; broadcasting and transmission of radio programs; interactive broadcasting and communications services; telecommunications services; transmission, broadcasting and reception of audio, video, still and moving images, text and data; satellite transmission and television broadcasting services; providing access to navigation via the data network; satellite transmission of messages and data for navigation by air; wireless telecommunication services for use on smart phones for the provision of information relating to vehicle trip information history, parking location management, trip information, vehicle health management, driving information, and third-party promotional data in the form of advertising for drivers; transmission of automobile information via communication networks; car telephone communications services; electronic transmission of user location information via satellite and communication mechanisms; providing access to applications via internet/mobile networks; telecommunications services provided via fiber optic, wireless and cable networks; communication by mobile telephone; telephone communication services; communications services; rental of telecommunication machines and apparatus; radio broadcasting; television broadcasting; internet broadcasting services; rental of broadcasting equipment.

(260) AM 2022 117018 A

(800) 1648951

(151) 2021 12 23

(891) 2021 12 23

(731) LTD "VALENTA-INTELLEKT"

ul. Ryabinovaya, d. 26, str. 10, k. 6-26,

RU-121471 Moscow, Russian Federation

(540)

СТЕЗИУМ

(591) Black, white

(531) 28.05

(511)

5 – Pharmaceutical preparations for treating musculoskeletal system disorders; pharmaceutical preparations for treating muscle spasms; pharmaceutical preparations for muscle tone reduction; centrally acting muscle relaxants.

(260) AM 2022 117019 A

(800) 1649033

(151) 2021 10 20

(891) 2021 10 20

(731) The Black & Decker Corporation

701 East Joppa Road, Towson MD 21286,

USA



(540)



(591) Black, white

(531) 03.01.08; 03.01.16; 27.03.01; 27.03.03

(511)

4 – Lubricating fluids for use with powered saws and saw blades coupled to powered saws.

7 – Accessories for use with power tools, namely, saw blades, band saw blades, jig saw blades, hole saws, circular saw blades, drill bits and abrasive wheels.

8 – Hand tools, namely, snap lock punches, pipe duct cutters, tubing cutters, screwdrivers, ratcheting screwdrivers, sockets, nut drivers, utility knives and blades, folding and fix blade knives, pliers and wrenches, hand saws, hack saws, jab saws and folding saws; notchers being hand tools.

9 – Software for use with saw blade selection for powered saws, sensors, software, and internet communication systems for monitoring performance of powered saws and saw blades coupled to powered saws.

18 – Tote bags and soft storage bags for use with power tools, hand tools, and power tool accessories.

(260) AM 2022 117020 A

(800) 1649057

(151) 2022 01 14

(891) 2022 01 14

(731) Honor Device Co., Ltd.

Suite 3401, Unit A, Building 6, Shum Yip Sky Park, No. 8089, Hongli West Road, Xiangmihu Street, Futian District, Shenzhen, 518040 Guangdong, China

(540)

# Magic Live

(591) Black, white

(531) 27.05.01

(511)

9 – Computers; computer operating programs, recorded; computer software, recorded; pedometers; bathroom scales; router; connected bracelets [measuring instruments]; chips [integrated circuits]; smartphone software applications, downloadable; computer software applications, downloadable; tablet computers; smartwatches [data processing apparatus]; notebook computers; smartphones; television apparatus; headsets; cameras [photography]; digital door locks; 3D spectacles; mobile power (rechargeable battery).

(260) AM 2022 117021 A

(800) 1649072

(151) 2021 11 10

(891) 2021 11 10

(731) Orkla Foods Česko a Slovensko a.s.  
Mělnická 133, CZ-277 32 Byšice,  
Czech Republic

(540)

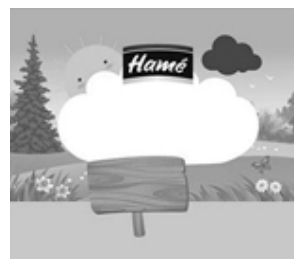

(591) Black, white

(531) 01.03.01; 01.03.20; 01.15.11; 06.19.11; 07.01.18; 25.01.06; 27.05.24

(511)

5 – Baby food containing meat, poultry, vegetables, milk and dairy products.

(260) AM 2022 117022 A

(800) 1649118

(151) 2021 09 16

(891) 2021 09 16

(731) TOP MEDIA DISTRIBUTION LIMITED  
Clarence Thomas Building, P.O. Box 4649,  
Road Town, Tortola, Virgin Islands (British)

(540)



(591) Black, white and green

(531) 14.01.22; 26.05.01; 26.05.19; 26.13.25; 29.01.12

(511)

9 – Scientific, nautical, surveying, photographic, cinematographic, optic, weighting, measuring, signaling, inspecting (checking), life-saving and teaching apparatus and instruments; apparatus and instruments for transmission, switching, transmutation, accumulation, regulation or control of electricity; apparatus for recording, sound and image transmission or reproduction; magnetic data media, phonograph records / sound recording discs; compact discs, DVD and other digital data recording carriers; mechanisms for coin-operated apparatus; cash registers, calculating machines, data processing equipment, computers; computer software; fire extinguishing apparatus; 3D spectacles; answering machines; ticket dispensers; circuit breakers; automated teller machines (ATM); steering apparatus,

automatic, for vehicles; automatic indicators of low pressure in vehicle tyres / automatic indicators of low pressure in vehicle tires; aerometers; asbestos clothing for protection against fire; asbestos gloves for protection against accidents; asbestos screens for firemen; accelerometers; actinometers; batteries for electronic cigarettes; accumulators, electric; acoustic couplers; alidades; altimeters; ammeters; anemometers; anodes; anode batteries / high tension batteries; aerials / antennas; anti-glare glasses; anti-glare screens; anticathodes; remote control apparatus; data processing apparatus; apparatus to check franking / apparatus to check stamping mail; apparatus for fermentation (laboratory apparatus); igniting apparatus, electric, for igniting at a distance / electric apparatus for remote ignition; apparatus and installations for the production of X-rays, not for medical purposes; Global Positioning System (GPS) apparatus; testing apparatus not for medical purposes; apertometers (optics); acid hydrometers; acidimeters for batteries; apparatus and instruments for astronomy; audio- and video-receivers; audiovisual teaching apparatus; audio interfaces; beacons, luminous; balancing apparatus; lighting ballasts; battery jars / accumulator jars; barometers; ignition batteries; batteries, electric; batteries, electric, for vehicles; accumulators, electric, for vehicles; cordless telephones; balances (steelyards) / lever scales (steelyards) / steelyards (lever scales); betatrons; binoculars; biochips; computer memory devices; black boxes (data recorders); fire hose nozzles; connected bracelets (measuring instruments); scales; baby scales; scales with body mass analysers / scales with body mass analyzers; bathroom scales; weighbridges; plumb bobs; vacuum gauges; vacuum tubes (radio); variometers; shoes for protection against accidents, irradiation and fire; gauges; measuring apparatus; measuring devices, electric; measures; current rectifiers; high-frequency apparatus; flowmeters; branch boxes (electricity); video screens; camcorders; video cassettes; video baby monitors; video telephones; viewfinders, photographic; sighting telescopes for firearms / telescopic sights for firearms; telescopic sights for firearms; viscosimeters; wind socks for indicating wind direction; levelling staffs (surveying instruments); rods (surveying instruments); peepholes (magnifying lenses) for doors; marking buoys; fire extinguishers; diving suits; divers' masks; fibre optic cables / fiber optic cables; voltmeters; ear plugs for divers; gas testing instruments; gasometers (measuring instruments); discharge tubes, electric, other than for lighting / electric discharge tubes, other than for lighting; galena crystals (detectors); galvanic batteries; galvanic cells; galvanometers; hands-free kits for telephones; virtual reality headsets; heliographic apparatus; surveying apparatus; surveying chains; weights; hygrometers; hydrometers; needles for surveying compasses; needles for record players / styli for record players; holograms; measuring glassware / graduated glassware; sounding leads; loudspeakers; range finders / telemeters;

decompression chambers; decompression chambers; densitometers; detectors; smoke detectors; counterfeit coin detectors; bells (warning devices); mirrors (optics); mirrors for inspecting work; dictating machines; dynamometers; floppy disks; disks, magnetic; disk drives for computers; juke boxes for computers; tele-rupters; distillation apparatus for scientific purposes; diffraction apparatus (microscopy); breathing apparatus for underwater swimming; breathing apparatus, except for artificial respiration; diagnostic apparatus, not for medical purposes; transparencies (photography); slides (photography); slide projectors / transparency projection apparatus; diaphragms (acoustics); diaphragms (photography); diaphragms for scientific apparatus; DNA chips; adding machines; dosage dispensers; dosimeters; road signs, luminous or mechanical; traffic cones; fuse wire / wires of metal alloys (fuse wire); choking coils (impedance); equalizers (audio apparatus) / equalisers (audio apparatus); screens (photography); exposure meters (light meters); exposure meters (light meters); electrified rails for mounting spot lights; electric installations for the remote control of industrial operations; electrical adapters; electric door bells; electricity conduits; electro-dynamic apparatus for the remote control of railway points; electro-dynamic apparatus for the remote control of signals; electrolyzers; electromagnetic coils; electronic key fobs being remote control apparatus; electronic publications, downloadable; electronic interactive whiteboards; electronic pocket translators; electronic collars to train animals; electronic sheet music, downloadable; electronic pens (visual display units); electronic notice boards; electronic access control systems for interlocking doors; electric and electronic effects units for musical instruments; electronic tags for goods; epidiascopes; ergometers; encoded identification bracelets, magnetic; locks, electric; electronic agendas; voltage surge protectors; fuses; battery chargers; chargers for electric accumulators; chargers for electronic cigarettes; charging stations for electric vehicles; protection devices for personal use against accidents; protection devices against X-rays, not for medical purposes; protective suits for aviators; protective masks; goggles for sports; protective films adapted for computer screens; protective films adapted for computer screens; head guards for sports; mouth guards for sports; protective helmets; protective helmets for sports; acoustic alarms / sound alarms; sound recording carriers; phonograph records / sound recording discs; sound recording strips; acoustic conduits; connectors (electricity); couplers (data processing equipment); connections for electric lines; couplings, electric / connections, electric; wire connectors (electricity); mechanical signs; signs, luminous; probes for scientific purposes; sounding apparatus and machines; buzzers; readers (data processing equipment); bar code readers; identity cards, magnetic; inverters (electricity); slope indicators; inclinometers; clinometers; pressure indicators; incubators for bacteria culture;



instruments containing eyepieces; integrated circuits; integrated circuits; interfaces for computers; infrared detectors; infrared detectors; spark-guards; starter cables for motors; cables, electric; calipers; calibrating rings; calorimeters; pocket calculators; pocket calculators; capillary tubes; memory cards for video game machines; integrated circuit cards (smart cards) / smart cards (integrated circuit cards); encoded key cards; carriers for dark plates (photography); video game cartridges; cathodes; cathodic anti-corrosion apparatus; mouse pads; cinematographic film, exposed; cinematographic cameras; terminals (electricity); push buttons for bells; coaxial cables; encoded magnetic cards; collectors, electric; dog whistles; compact discs (audio-video); compact discs (read-only memory); comparators; directional compasses; marine compasses; computer hardware; computer game software; computer software, recorded; joysticks for use with computers, other than for video games; computer keyboards; computer peripheral devices; printers for use with computers; magnetic tape units for computers; computer programs, downloadable; computer programs, recorded; computer operating programs, recorded; commutators; electric apparatus for commutation; condensers (capacitors) / capacitors; contacts, electric; contact lenses; containers for contact lenses; boiler control instruments; correcting lenses (optics); junction boxes (electricity); cabinets for loudspeakers; battery boxes / accumulator boxes; squares for measuring; cosmographic instruments; clothing for protection against fire; garments for protection against fire; spools (photography); coils, electric; inductors (electricity); droppers; pedometers; circular slide rules; bullet-proof clothing; bullet-proof vests / bullet-proof waistcoats; azimuth instruments; laboratory trays; logs (measuring instruments); lasers, not for medical purposes; lactodensimeters; lactodensimeters; darkroom lamps (photography); flash-bulbs (photography); spectacle chains / eyeglass chains; laptop computers; spectacle lenses / eyeglass lenses; rulers (measuring instruments); carpenters' rules; optical lanterns; optical lamps; counters / meters; revolution counters; distance recording apparatus / apparatus for recording distance; mileage recorders for vehicles / kilometer recorders for vehicles; slide-rules; sounding lines; magnifying glasses (optics); magnets; decorative magnets; magnetic encoders; magnetic wires; magnetic tapes; videotapes; crash test dummies; pressure gauges / manometers; solderers' helmets; mathematical instruments; materials for electricity mains (wires, cables); weighing machines; money counting and sorting machines; material testing instruments and machines; furniture especially made for laboratories; megaphones; portable media players; metal detectors for industrial or military purposes; meteorological instruments; meteorological balloons; rules (measuring instruments); dressmakers' measures; metronomes; mechanisms for counter-operated apparatus; coin-operated mechanisms for television sets; mouse (compu-

ter peripheral); copper wire, insulated; micrometers / micrometer gauges; micrometer screws for optical instruments; microprocessors; microprocessors; microtomes; microphones; audio mixers; measuring spoons; mobile telephones; cell phones / cellular phones; modems; monitors (computer hardware); monitors (computer programs); editing appliances for cinematographic films; apparatus for editing cinematographic film; marine depth finders; naval signalling apparatus; juke boxes, musical / coin-operated musical automata (juke boxes); animated cartoons; junction sleeves for electric cables; navigational instruments; navigation apparatus for vehicles (on-board computers); headphones; knee-pads for workers; covers for electric outlets; semi-conductors; neon signs; identification threads for electric wires; thread counters; surveyors' levels; levelling instruments; verniers; nose clips for divers and swimmers; notebook computers; objectives (lenses) (optics); lenses for astrophotography; close-up lenses; limiters (electricity); sheaths for electric cables; identification sheaths for electric wires; egg-candlers; clothing for protection against accidents, irradiation and fire; clothing especially made for laboratories; ozonisers (ozonators); octants; spectacles / eyeglasses; sunglasses; eyepieces; ohmmeters; spectacle frames / eyeglass frames; optical glass; eyewear; optical fibres [light conducting filaments] / optical fibers [light conducting filaments]; optical discs; optical character readers; optical condensers; optical lenses; optical data media; optical apparatus; telescopic sights for artillery; oscillographs; cleaning apparatus for sound recording discs; selfie sticks (hand-held monopods); parking meters; safety restraints, other than for vehicle seats and sports equipment; pince-nez; stills for laboratory experiments; intercommunication apparatus; speaking tubes; transmitters of electronic signals; oxygen transvasing apparatus; switchboxes (electricity); switchboards; switches, electric; time switches, automatic; converters, electric; periscopes; personal stereos; punched card machines for offices; furnaces for laboratory use / ovens for laboratory use; amplifying tubes / amplifying valves; amplifiers; wrist rests for use with computers; pyrometers; planimeters; plane tables (surveying instruments); tablet computers; plates for batteries; wafers for integrated circuits; printed circuit boards; DVD players; cassette players; compact disc players; films, exposed; plotters; fire escapes; fire engines; fire pumps; fire blankets; fire beaters; fire alarms; fire boats; fire hose; electric loss indicators; quantity indicators; petrol gauges; gasoline gauges; water level indicators; sprinkler systems for fire protection; polarimeters; vehicle breakdown warning triangles; letter scales; precision balances; prisms (optics); computer software applications, downloadable; air analysis apparatus; food analysis apparatus; distance measuring apparatus; appliances for measuring the thickness of leather; apparatus for measuring the thickness of skins; speed checking apparatus for

vehicles; time recording apparatus; weighing apparatus; particle accelerators; hemline markers; railway traffic safety appliances; speed measuring apparatus (photography); invoicing machines; video recorders; tape recorders; apparatus for changing record player needles; film cutting apparatus; electronic book readers; test tubes; flashing lights (luminous signals); conductors, electric; wires, electric; ducts (electricity); record players; projection apparatus; projection screens; washing trays (photography); anti-interference devices (electricity); theft prevention installations, electric; anti-theft warning apparatus; processors (central processing units) / central processing units (processors); rods for water diviners; plumb lines; control panels (electricity); radar apparatus; radiological apparatus for industrial purposes; radiology screens for industrial purposes; baby monitors; radio pagers; transmitting sets (telecommunication); radios; vehicle radios; walkie-talkies; radiotelegraphy sets; radiotelephony sets; masts for wireless aerials; frames for photographic transparencies; screens for photoengraving; abacuses; voting machines; resuscitation training simulators; regulating apparatus, electric; voltage regulators for vehicles; voltage regulators for vehicles; stage lighting regulators; speed regulators for record players; cell switches (electricity) / reducers (electricity); resistances, electric; marking gauges (joinery); T-squares for measuring; relays, electric; cell phone straps; X-ray apparatus not for medical purposes; X-ray films, exposed; X-ray tubes not for medical purposes; X-ray photographs, other than for medical purposes; rheostats; respirators for filtering air; respiratory masks, other than for artificial respiration; retorts; refractometers; refractors; grids for batteries; downloadable ring tones for mobile phones; levels (instruments for determining the horizontal); screw-tapping gauges; humanoid robots with artificial intelligence; sockets, plugs and other contacts (electric couplings); demagnetizing apparatus for magnetic tapes; distribution boxes (electricity); distribution consoles (electricity); distribution boards (electricity); lightning conductors / lightning arresters / lightning rods; lightning conductors / lightning arresters / lightning rods; slide calipers; mercury levels; circuit closers; gloves for divers; gloves for protection against X-rays for industrial purposes; gloves for protection against accidents; horns for loudspeakers; life-saving apparatus and equipment; safety tarpaulins; life buoys; life jackets; life-saving capsules for natural disasters; life-saving rafts; life belts; subwoofers; whistle alarms; reflective articles for wear, for the prevention of accidents; reflective apparel and clothing for the prevention of accidents; lens hoods; blueprint apparatus; light-emitting diodes (LED); light-emitting electronic pointers; traffic-light apparatus (signalling devices); sextants; fog signals, non-explosive; signals, luminous or mechanical; signalling buoys; signal bells; alarm bells, electric; signal lanterns; signalling panels, luminous or mechanical; whistle alarms; signalling whistles; simulators for the

steering and control of vehicles; sirens; safety nets; life nets; nets for protection against accidents; scanners (data processing equipment); smartwatches; smart rings; smartglasses; smartphones; salinometers; solenoid valves (electromagnetic switches); sonars; solar batteries; solar panels for the production of electricity; spectrograph apparatus; spectrometers; spirit levels; alcoholmeters; speed indicators; monitoring apparatus, electric; observation instruments; shutter releases (photography); stereoscopes; stereoscopic apparatus; head cleaning tapes (recording); stroboscopes; sulfimeters; bags adapted for laptops; satellites for scientific purposes; satellite navigational apparatus; drying apparatus for photographic prints; drying racks (photography); spherometers; printed circuits; time clocks (time recording devices); egg timers (sandglasses); hourglasses; taximeters; tachometers; television apparatus; telegraphs (apparatus); telegraph wires; telescopes; teleprompters; teleprinters / teletypewriters; telephone apparatus; telephone transmitters; telephone wires; telephone receivers; temperature indicators; temperature indicator labels, not for medical purposes; theodolites; thermal imaging cameras; heat regulating apparatus; thermo-hygrometers; thermionic valves; thermionic tubes; thermometers, not for medical purposes; thermostats; thermostats for vehicles; crucibles (laboratory) / cupels (laboratory); pressure measuring apparatus; pressure indicator plugs for valves; security tokens (encryption devices); tone arms for record players; toner cartridges, unfilled, for printers and photocopiers; totalizers; precision measuring apparatus; transistors (electronic); transmitters (telecommunication); transponders; protractors (measuring instruments); transformers (electricity); step-up transformers; holders for electric coils; tripods for cameras; triodes; Pitot tubes; urinometers; downloadable image files; downloadable music files; downloadable music files; apparatus and instruments for physics; filters for use in photography; filters for respiratory masks; filters for ultraviolet rays, for photography; wearable activity trackers; USB flash drives; fluorescent screens; cameras (photography); glazing apparatus for photographic prints; glazing apparatus for photographic prints; photovoltaic cells; shutters (photography); enlarging apparatus (photography); photocopiers (photographic, electrostatic, thermic); darkrooms (photography); photometers; flashlights (photography); phototelegraphy apparatus; spectacle cases / eyeglass cases; cases for smartphones; containers for microscope slides; cases especially made for photographic apparatus and instruments; wavemeters; chemistry apparatus and instruments; chromatography apparatus for laboratory use; chromatography apparatus for laboratory use; laboratory centrifuges; centering apparatus for photographic transparencies; cyclotrons; compasses for measuring; digital weather stations; digital signs; digital photo frames; saccharometers; magic lanterns; frequency meters; Petri dishes; chips (integrated circuits); square rulers for measu-

ring; sleeves for laptops; covers for personal digital assistants (PDAs); covers for tablet computers; covers for smartphones; jigs [measuring instruments]; spectacle cords / eyeglass cords; riding helmets; retorts' stands; stands for photographic apparatus; sound locating instruments; workmen's protective face-shields; armatures (electricity).

35 – Advertising; business management; business administration; office functions; administrative processing of purchase orders; administration of consumer loyalty programs; administration of loyalty rewards programs; cost analysis; business auditing; auction sales; outsourcing services [business assistance]; accounting; bookkeeping; web indexing for commercial or advertising purposes; maintenance negotiations on concluding agreements in the field of business for others; market research; public opinion polling; billing; arranging newspaper subscriptions for others; arranging subscriptions to telecommunication services for others; preparation of payment documents; preparation of tax returns; demonstration of goods; business services in the field of entrepreneurial activity; assistance in management of business activities; commercial or industrial management assistance; business management consulting services; business research; economic forecasting; providing information in the field of business through websites; collecting information for business; providing of business information relating to company activities; management of performer's activities; management freelancer's activities; administrative hotel management; management of professional athletes; managing the activities of reimbursement programs for others; commercial information and advice for consumers (consumer support centers); commercial management licensing goods and services for others; computerized database management; management of consulting staff; business management consulting; communication strategy consulting on public relations; consulting on communication strategy for advertising; consulting with organization of business activity; marketing; marketing research; typewritten works; providing information on commercial and business contacts; provision of an online marketplace for buyers and sellers of goods and services; writing biographical references for others; writing of résumés for others; writing processing; updating of advertising materials; updating and maintaining data in computer databases; updating and maintaining information in registers; website traffic optimization; organization of exhibitions for commercial or advertising need; organizing fashion shows for advertising purposes; organization of fairs for commercial or advertising need; rental of advertising space; window dressing; business evaluation; personnel selection using psychological testing; advice on organizing and managing business activities; business intermediary services relating to the matching of potential private investors with entrepreneurs needing funding; commercial information agencies; employment agen-

cy services; expert services on the efficiency of entrepreneurial activity; outsourcing services (business assistance); business project management services for construction projects; commercial mediation services; layout services for advertising purposes; business meeting reminder services (office work); press advertising consultancy; price comparison services; purchasing of goods and services for other businesses; administrative services for the relocation of businesses; photocopying services; assembly services schedules of business meetings (office work); tax return advisory [accountancy] services; services of import-export agencies; mannequin services for advertising or sales promotion; advertising agency services; secretarial services; public relations services; data search in computer files for others; sponsorship search; search engine optimization; presentation of goods on communication media, for retail purposes; receiving phone calls for inaccessible subscribers; rental of billboards [advertising boards]; rental (office machines and equipment); rental of advertising space, time and materials; rental of advertising time on communication media; rental of vending machines; rental of trade stands; photocopying services; direct mail advertising; testing (psychological) for the selection of personnel; publication of advertising texts; radio advertising; registration of written messages and data; advertising of business websites; outdoor advertising; mail-order advertising; online advertising via a computer communications network; reproduction (document); distribution of samples; distribution of advertising materials; development of advertising concepts in the nature of brochures; business investigations; systematization of information into computer databases; preparation of reports on the status of accounts; compilation of indexes of information for commercial or advertising needs; sales promotion for others; creation of promotional films; stenography; writing of advertising texts; television advertising; telemarketing services; negotiation and conclusion of commercial agreements for third parties; professional business consulting.

38 – Telecommunication services; communication by telegraph; providing access to databases; providing users with access to global computer networks; providing communication in Internet chats; providing online forums for communication in the field of electronic games; providing a telecommunication connection with global computer network; provision of telecommunication channels for TV shops; connection for by means of fiber-optic networks; communication by means of computer terminals; communication with cell phones; informing about telecommunication services; paging services (using radio, telephone or other electronic means of communication); video data transmission on demand; transmission of greeting cards on-line; transmission of electronic mail; sending messages and images using computer; transmission of telegrams; electronic file transfer; sending messages; video conferencing services; voice mail services; servi-

ces of electronic information boards (telecommunication services); telecommunication routing and connection services; news agency services; teleconferencing services; data streaming; rental of equipment for sending messages; rental of modems; rental of telecommunication equipment; telephone rental services; rental of telecommunication equipment including telephones and facsimile apparatus; rental of access time to global computer networks; radio communication; radio broadcasting; satellite communication services; television broadcasting; television broadcasting by cable networks; telegraphic communication services; telegraph services; provision of telecommunications connections for telephone chat lines; telephone services; broadcasting by wireless means; facsimile transmission.

41 – Education; providing training; entertainment services; arranging of cultural events; academy services (education); teaching; video recording services; arranging and conducting of congresses; arranging and conducting colloquia; conferences (arranging and conducting of -); arranging and conducting concerts; arrangement and carrying out face-to-face training forums; arranging and conducting practical classes (training); arranging and conducting seminars; arranging and conducting of symposiums; arranging of beauty contests; gymnastic teaching; preparation of publications with the help of electronic desktop publishing tools; preschool schools; animal training; duplicate translation; examinations in training; provision non-downloadable videos online; providing non-downloadable electronic publications in online mode; providing non-downloadable musical works online; provision non-downloadable television programs using video-on-demand video services; providing non-downloadable movies with on-demand video transmission services; provision of sports equipment; provision of equipment for recreation; provision golf equipment; providing equipment for casinos (gambling); ticket reservation and booking services for cultural events; correspondence courses; gaming services provided online via a computer network; providing information relating to entertainment; information on education; informing about entertainment; organisation of film screenings; microfilming; mounting video tapes; training services provided by simulators; aikido training; training on conducting tea ceremony; individual training; education in boarding schools; provision of museum services (presentations, exhibitions); screenplay writing; songwriting; publishing of scripts for theatrical use; writing of texts; arranging and conducting of sporting events; organization of spectacles (impresario services); organization of exhibitions for cultural or educational needs; organizing competitions (educational or entertainment); organization of lotteries; organizing fashion shows for entertainment needs; organization of sports competitions; educational services; language translation; party planning (entertainment); entertainment services provided

by performing artists; electronic library services; disc jockey services; discotheque services; calligraphy services; layout services, other than for advertising purposes; interpretation services; slot machine hall services; zoos; instructor services (training); karaoke services; film studio services; club services (entertainment or educational); health club services (health and fitness training); bodybuilding services for artists; entertainment services provided at nightclubs; orchestra services; amusement park services; translation services; mobile library services; personal trainer services (fitness training); reporter services; sports camp services; recording studio services; holiday camp services; theater production; journalism services; gambling services; music composition services; practical training (demonstration); live performances; organisation of musical performances; presentation of circus performances; conducting fitness classes; rental of home aquariums; rental of audio equipment; rental of spectacular scenery; video camera rental; video recorder rental; video rental services; rental of sound recorders; toy rental; rental of electronic game equipment; rental of lighting apparatus for movie sets or film studios; movie rental (rental of movie DVDs); rental of scuba diving equipment; rental of lighting equipment for theater studios or television studios; rental of radio and television receivers; rental of sports grounds; rental of sports equipment, except vehicles; rental of works of art; rental of theatrical scenery; rental of tennis courts; rental of stadium facilities; professional retraining; career guidance (education advice or teaching); online electronic publishing of books and periodicals; writing and publishing of texts, other than publicity texts; production of radio programs; religious education; creating spectacles; creating music works; creation of radio and television programs; creation of films, except advertising; subtitling; theatrical production services; production of television programs; physical education; photography; timing of sports events.

---

(260) AM 2022 117023 A

(800) 1649151

(151) 2021 11 08

(891) 2021 11 08

(731) Euro Games Technology Ltd.

4, "Maritsa" Str., "Vranya-Lozen-Triugulnika",  
BG-1151 Sofia, Bulgaria

(540)

## **Ape of Luck**

(591) Black, white

(511)

9 – Software; computer gaming software; computer software packages; computer operating system software; computer software, recorded; software drivers; virtual reality software; games software; entertainment software for computer games; computer programs for network management; operating computer

software for main frame computers; monitors (computer hardware); computer hardware; apparatus for recording images; monitors (computer programs); computer game programs; computer programs for recorded games; apparatus for recording, transmission or reproduction of sound or images; communications servers [computer hardware]; electronic components for gambling machines; computer application software featuring games and gaming; computer software for the administration of on-line games and gaming; computer hardware for games and gaming; hardware and software for gambling, gambling machines, gambling games on the internet and via telecommunication network.

28 – Gaming machines for gambling; chips for gambling; mah-jong; arcade games; gambling machines operating with coins, notes and cards; games; electronic games; parlor games; gaming chips; gaming tables; slot machines [gaming machines]; LCD game machines; slot machines and gaming devices; coin-operated amusement machines; roulette chips; poker chips; chips and dice (gaming equipment); equipment for casinos; roulette tables; gaming roulette wheels; casino games; automats and gambling machines; coin-operated machines and/or electronic coin-operated machines with or without the possibility of gain; boxes for coin-operated machines, slot machines and gaming machines; electronic or electrotechnical gaming devices, automats and machines, coin-operated machines; housings for coin-operated machines, gaming equipment, gaming machines, machines for gambling; electropneumatic and electrical gambling machines (slot machines).

41 – Gambling; services related to gambling; gaming services for entertainment purposes; casino, gaming and gambling services; training in the development of software systems; provision of gaming equipment for gambling halls; providing casino equipment [gambling]; gaming machine entertainment services; providing casino facilities [gambling]; halls with gaming machines; amusement arcade services; games equipment rental; rental of gaming machines; providing amusement arcade services; rental of gaming machines with images of fruits; editing or recording of sounds and images; sound recording and video entertainment services; hire of sound reproducing apparatus; provision of gaming equipment for casinos; providing of casino facilities; online gambling services; casino management services; operation of gaming establishments, gaming halls, internet casinos, online gambling sites.

(260) AM 2022 117024 A  
(800) 1649173  
(151) 2021 11 22  
(891) 2021 11 22  
(731) Egis Gyógyszergyár Zrt.  
Kereszturi út 30-38, H-1106 Budapest, Hungary

(540)

# КСИЛТЕСС

(591) Black, white  
(531) 28.05  
(511)  
5 – Pharmaceutical preparations for human use.

(260) AM 2022 117025 A  
(800) 1649178  
(151) 2021 12 07  
(891) 2021 12 07  
(731) Richter Gedeon Nyrt.  
Gyömrői út 19-21, H-1103 Budapest, Hungary  
(540)

# ТЕЛЛЕКОМЪ

(591) Black, white  
(531) 28.05  
(511)  
5 – Pharmaceutical preparations.

(260) AM 2022 117026 A  
(800) 1649179  
(151) 2021 12 07  
(891) 2021 12 07  
(731) Richter Gedeon Nyrt.  
Gyömrői út 19-21, H-1103 Budapest, Hungary  
(540)

# АКЛИДА

(591) Black, white  
(531) 28.05  
(511)  
5 – Pharmaceutical preparations.

(260) AM 2022 117027 A  
(800) 1649180  
(151) 2021 12 07  
(891) 2021 12 07  
(731) Richter Gedeon Nyrt.  
Gyömrői út 19-21, H-1103 Budapest, Hungary  
(540)

# БЛАНОРИН

(591) Black, white  
(531) 28.05  
(511)  
5 – Pharmaceutical preparations.

(260) AM 2022 117028 A  
(800) 1649181  
(151) 2021 12 07  
(891) 2021 12 07  
(731) Richter Gedeon Nyrt.  
Gyömrői út 19-21, H-1103 Budapest, Hungary

(540)

**БОДОНЕТ**

(591) Black, white

(531) 28.05

(511)

5 – Pharmaceutical preparations.

(260) AM 2022 117029 A

(800) 1649184

(151) 2021 12 07

(891) 2021 12 07

(731) Richter Gedeon Nyrt.

Gyömrői út 19-21, H-1103 Budapest, Hungary

(540)

**БРАГОНИТ**

(591) Black, white

(531) 28.05

(511)

5 – Pharmaceutical preparations.

(260) AM 2022 117030 A

(800) 1649200

(151) 2021 11 12

(891) 2021 11 12

(731) TANDUAY DISTILLERS, INC.

KM 43 NATIONAL HIGHWAY BARANGAY

SALA, CABUYAO, 1001 LAGUNA,

Philippines

(540)

**TANDUAY**

(591) Black, white

(511)

33 – Alcoholic beverages [except beers].

(260) AM 2022 117031 A

(800) 1649221

(151) 2022 01 07

(891) 2022 01 07

(731) Dickey's Barbecue Pit, Inc.

4514 Cole Avenue, Suite 1015, Dallas TX

75205, USA

(540)



(591) The color(s) yellow, black and red is/are claimed as a feature of the mark

(531) 01.01.02; 01.01.10; 26.04.04; 26.04.05; 26.04.18; 27.05.10; 27.05.17; 29.01.13

(526) BARBECUE PIT".

(511)

43 – Restaurant, carry-out restaurant and catering services.

(260) AM 2022 117052 A

(800) 1649863

(151) 2021 10 27

(891) 2021 10 27

(731) Laboratoires La Prairie SA

Industriestrasse 8, CH-8604 Volketswil,

Switzerland

(540)

**LA PRAIRIE**  
SWITZERLAND

(591) Black, white

(511)

3 – Non-medicated toiletry preparations and cosmetic products; perfumery products, essential oils; make-up products; non-medicated soaps; non-medicated hair treatments and preparations; deodorants and antiperspirants for personal use; sun protection preparations; all the aforesaid goods of Swiss origin.

21 – Cosmetic utensils; toilet utensils; toilet cases; combs and sponges; brushes, except paintbrushes; make-up brushes; spoons for cosmetic use; spatulas for cosmetic use; perfume vaporizers; all the aforesaid goods of Swiss origin.

44 – Aesthetic treatment services; beauty salon services; facial treatment services; advisory services with respect to skin care and beauty care services; beauty and hygiene care services; manicure services; providing information via the Internet regarding the selection and application of cosmetic preparations and beauty products.

(260) AM 2022 117061 A

(800) 1641525

(151) 2021 12 27

(891) 2022 02 18

(731) Radisson Hospitality Belgium B.V. / S.R.L.

Avenue du Bourget 44, B-1130 Brussel,

Belgium

(540)



(591) Red, black and grey  
 (531) 24.17.20; 26.01.03; 26.01.20; 27.05.10;  
 27.05.19; 29.01.13  
 (511)  
 43 – Hotel, bar and restaurant services; services for  
 the reservation of rooms.

(260) AM 2022 117110 A  
 (800) 1649912  
 (151) 2022 01 13  
 (891) 2022 01 13  
 (731) Honor Device Co., Ltd.  
 Suite 3401, Unit A, Building 6, Shum Yip Sky  
 Park, No. 8089, Hongli West Road, Xiangmihu  
 Street, Futian District, Shenzhen, 518040  
 Guangdong, China

(540)

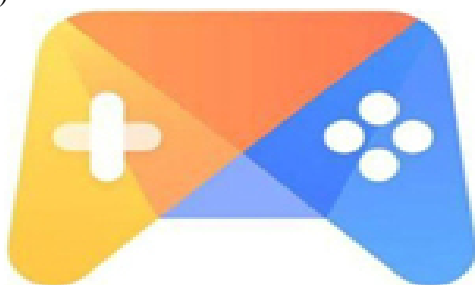

(591) Yellow, orange, blue and white  
 (531) 16.01.25; 29.01.14  
 (511)  
 9 – Downloadable mobilephone software applicati-  
 ons; computer software applications, downloadable;  
 tablet computers; smartwatches; notebook computers;  
 computers; computer hardware; computer software,  
 recorded; pedometers; bathroom scales; smartphones;  
 routers; television apparatus; earphone; cameras [pho-  
 tography]; connected bracelets [measuring instru-  
 ments]; chips [integrated circuits]; digital door locks;  
 3D spectacles; mobile power supply (rechargeable  
 batteries).

42 – Quality check test; design and development of  
 multimedia products; mobile telephone design; cloud  
 computing; computer programming; design and deve-  
 lopment of software in the field of mobile applicati-  
 ons; electronic data storage; recovery of smartphone  
 data; data conversion of computer programs and data  
 [not physical conversion]; computer software (upda-  
 ting of -); design and development of computer soft-  
 ware; computer systems analysis; maintenance of  
 computer software; installation of computer software;  
 data encryption services; development of computer  
 platforms; consultancy in the design and development  
 of computer hardware; data security consultancy.

(260) AM 2022 117112 A  
 (800) 1649970  
 (151) 2022 01 18  
 (891) 2022 01 18  
 (731) FANUC CORPORATION  
 3580, Shibokusa Aza-Komanba, Oshino-mura,  
 Minamitsuru-gun, Yamanashi 401-0597, Japan  
 (540)

## ROBOSHOT

(591) Black, white  
 (511)  
 7 – Injection molding machines; plastic processing  
 machines and apparatus.

(260) AM 2022 117113 A  
 (800) 1649991  
 (151) 2021 12 31  
 (891) 2021 12 31  
 (731) Jiangsu General Science Technology Co., Ltd.  
 Gangxia, Donggang Town, Xishan District,  
 Wuxi City, Jiangsu Province, China

(540)



(591) Black, white  
 (531) 03.01.14; 03.01.24; 03.01.26; 26.04.05;  
 26.04.15; 26.04.18; 26.04.24; 27.05.17;  
 27.05.24  
 (511)  
 12 – Locomotives; motorcycles; strollers; aerial con-  
 veyors; tires for vehicle wheels; air vehicles; boats;  
 electric bicycles; hubs for vehicle wheels; repair out-  
 fits for inner tubes.

(260) AM 2022 117117 A  
 (800) 1650064  
 (151) 2021 12 27  
 (891) 2021 12 27  
 (731) JAPAN PROFESSIONAL FOOTBALL  
 LEAGUE  
 3-10-15, Hongo, Bunkyo-ku, Tokyo 113-0033,  
 Japan  
 (540)

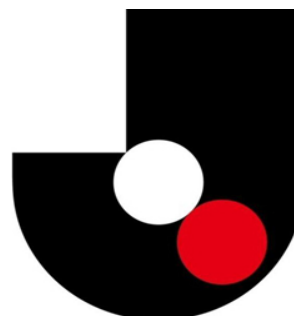

(591) Black, white and red  
 (531) 26.01.01; 26.01.04; 26.01.06; 27.05.08;  
 27.05.21; 29.01.13

(511)  
 38 – Telecommunication services; transmission, broadcasting and reception of audio, video, still and moving images, text and data; broadcasting services; news agency services; leasing of telecommunication equipment, including telephones and facsimile apparatus; transmission of video content via the Internet; transmission of images via the Internet; streaming of video material on the Internet; Internet communication; video-on-demand transmission services; transmission of information by cable; broadcasting and transmission of cable television programs; radio communications; video broadcasting services via the Internet; webcasting services; broadcasting of films and television programs via a video-on-demand service; broadcasting of multimedia content via the Internet; broadcasting of television programmes; electronic bulletin board services; providing on-line forums; providing internet chatrooms; providing on-line forums for the transmission of messages, comments and multimedia content among users.

41 – Lottery services; educational and instruction services relating to arts, crafts, sports or general knowledge; arranging, conducting and organization of seminars; providing electronic publications, not downloadable; reference libraries of literature and documentary records; book rental; publication of books; movie theatre presentations; production and distribution of movie films; providing online videos, not downloadable; presentation of live show performances; directing of plays; presentation of plays; presentation of musical performances; providing digital music from the Internet, not downloadable; production of radio and television programs; directing of radio and television programs; organization of sporting events; organization of entertainment events excluding movies, shows, plays, musical performances, sports, horse races, bicycle races, boat races and auto races; providing sports facilities; providing amusement facilities; game services provided on-line from a computer network; providing facilities for movies, shows, plays, music or educational training; providing audio or video studio services; booking of seats for shows; rental of sports equipment, except vehicles; photography.

---

(260) AM 2022 117148 A  
 (800) 1650991  
 (151) 2021 10 15  
 (891) 2021 10 15  
 (731) ekaterra Group IP Holdings B.V.  
 Weena 455, NL-3013 AL Rotterdam,  
 Netherlands  
 (540)

**EKATERRA**

(591) Black, white  
 (511)  
 5 – Dietetic substances for medical use; herbal preparations for medical purposes; medicated herbal supplements and medicated herbal extracts; herbal tea for medicinal use; medicated herbal beverages; vitamins; minerals for human consumption; food supplements; nutritional supplements for human consumption.

30 – Coffee; artificial coffee; tea; tea products; tea extracts; iced tea; carbonated and non-carbonated iced tea; iced tea mix powders; non medicinal herbal tea and infusions; cocoa; flour and preparations made from cereals; pastries; confectionery; chocolate; biscuits; ice cream; water ices; frozen confectionery; preserved herbs.

32 – Non-alcoholic beverages; soft drinks; sport drinks; energy drinks; mineral and aerated waters; flavoured water; carbonated and non-carbonated beverages; fruit beverages and fruit juices; vegetable juices; syrups and other non-alcoholic preparations for making beverages.

35 – Advertising; dissemination of advertising material; publicity services; promotion services; market research; business management; account auditing and book-keeping services; business administration; business consultancy services; office functions; clerical services; telephone answering services; retail, wholesale, online retail and wholesale services relating to food and beverages; loyalty, incentive and bonus program services.

41 – Education, advice and training, all in relation to food, refreshment and home consumer products; education, advice and training, all in relation to food, beverages and wellbeing; arranging and conducting of seminars, workshops and educational discussion groups; sporting and cultural activities; publication of texts; organisation of exhibitions for cultural or educational purposes; presentation of works of visual art and literature to the public for cultural or educational purposes; entertainment services; entertainment information services; providing online electronic publications, not downloadable.

43 – Services for providing food and drink; catering; restaurants; information, advice and reservation services for the provision of food and drink.

---

(260) AM 2022 117149 A  
 (800) 1650994  
 (151) 2021 09 21  
 (891) 2021 09 21  
 (731) ROLTEK Limited Liability Company  
 Inzhenernaya Street, 19, Romanovka,  
 Vsevolozhsky district, RU-188670  
 Leningradskaya region, Russian Federation



(540)



(591) Black, white

(531) 26.04.02; 26.04.04; 26.04.07; 26.13.25

(511)

6 – Gates of metal; fittings of metal for hanging gates, namely systems of hanging gates that help to open hanging gates; fittings of metal for rolling gates, namely systems of rolling gates that help to open rolling gates; fittings of metal for hanging and rolling gates, namely hinges, guideways, bogies, channel bars, sustainers, rolls, catches, corbels, stands, battens, plugs, locks, profiles, thrust blocks; fittings of metal for hanging conveyor systems, namely trolleys, corbels, guideways, connectors, bangers, switches, bends, hooks, rolls, restraints; fitting of metal for crane systems, namely trolleys, profiles, hangers, thrust blocks, lids; metal corbels for cable placement [current leads].

7 – Belt conveyors; hanging conveyor systems for mechanization of manufacturing processes; cranes [lifting and hoisting apparatus]; crane systems, cable trolleys and hangers for cable of crane systems.

(260) AM 2022 117150 A

(800) 1650997

(151) 2021 10 29

(891) 2021 10 29

(731) Zimmer Biomet Spine, Inc.

10225 Westmoor Drive, Westminster CO

80021, USA

(540)

**ZIMVIE**

(591) Black, white

(511)

5 – Dental implants composed of natural biological materials; spinal implants composed of natural biological materials; human allograft tissue and implants for use in spinal and dental procedures; biological tissue extracts for use in spinal and dental procedures; biological tissue grafts for use in spinal and dental procedures; human bone grafts for use in spinal and dental procedures; bone substitution materials composed of natural biological materials for use in spinal and dental procedures; bone cements for use in spinal and dental procedures; dental preparations and compounds, namely, bone growth substitutes in the nature of bone growth media consisting of biological materials, biological tissue matrices and biological membranes, all for medical purposes.

10 – Spinal implants composed of artificial materials and surgical instruments used in association therewith; dental implants composed of artificial materials and surgical instruments used in association therewith; surgical apparatus and instruments used in spinal and dental procedures; bone substitution materials composed of artificial materials used in spinal and dental procedures; dental implant procedure kits containing dental implants composed of artificial materials, surgical instruments used in dental implant procedures, medical drills, and surgical planning guides; surgical robots for use in dental and spinal surgical procedures; electrical stimulators for use in treating bone and tissue; electrical stimulators for fusing vertebrae in spinal procedures; bone growth stimulators; surgically non-invasive electromagnetic therapeutic equipment for medical treatment of living tissue and/or cells.

(260) AM 2022 117151 A

(800) 1651002

(151) 2021 11 04

(891) 2021 11 04

(731) Zimmer Biomet Spine, Inc.

10225 Westmoor Drive, Westminster CO

80021, USA

(540)



(591) Black, white

(531) 26.01.03; 26.01.18; 26.01.24; 27.05.21

(511)

5 – Dental implants composed of natural biological materials; spinal implants composed of natural biological materials; human allograft tissue and implants for use in spinal and dental procedures; biological tissue extracts for use in spinal and dental procedures; biological tissue grafts for use in spinal and dental procedures; human bone grafts for use in spinal and dental procedures; bone substitution materials composed of natural biological materials for use in spinal and dental procedures; bone cements for use in spinal and dental procedures; dental preparations and compounds, namely, bone growth substitutes in the nature of bone growth media consisting of biological materials, biological tissue matrices and biological membranes, all for medical purposes.

10 – Spinal implants composed of artificial materials and surgical instruments used in association therewith; dental implants composed of artificial materials

and surgical instruments used in association therewith; surgical apparatus and instruments used in spinal and dental procedures; bone substitution materials composed of artificial materials used in spinal and dental procedures; dental implant procedure kits containing dental implants composed of artificial materials, surgical instruments used in dental implant procedures, medical drills, and surgical planning guides; surgical robots for use in dental and spinal surgical procedures; electrical stimulators for use in treating bone and tissue; electrical stimulators for fusing vertebrae in spinal procedures; bone growth stimulators; surgically non-invasive electromagnetic therapeutic equipment for medical treatment of living tissue and/or cells.

(260) AM 2022 117152 A

(800) 1651022

(151) 2021 10 07

(891) 2021 10 07

(731) GÖNÜLLER TEKSTİL İÇ VE DIŞ TİCARET SANAYİ ANONİM ŞİRKETİ  
ABDURRAHMAN NAFİZ GÜRMAN MAH.,  
GENERAL ALİ RIZA GÜRMAN, CAD.  
PLATFORM MERTER OFIS 27 45,  
GÜNGÖREN, İSTANBUL, Türkiye

(540)

**BRANGO**

(591) Black, white

(531) 27.05.01

(511)

3 – Bleaching and cleaning preparations, detergents other than for use in manufacturing operations and for medical purposes, laundry bleach, fabric softeners for laundry use, stain removers, dishwasher detergents; perfumery; cosmetics (except medicated cosmetics); fragrances; deodorants for personal use and animals; soaps (except medicated soap); dental care preparations, dentifrices, denture polishes, tooth whitening preparations, mouth washes, not for medical purposes; abrasive preparations; emery cloth; sandpaper; pumice stone; abrasive pastes; polishing preparations for leather, vinyl, metal and wood, polishes and creams for leather, vinyl, metal and wood, wax for polishing.

14 – Jewellery; imitation jewellery; gold; precious stones and jewellery made thereof; cufflinks; tie pins; statuettes and figurines of precious metal; clocks, watches and chronometrical instruments; chronometers and their parts; watch straps; commemorative statuary cups made of precious metal; chaplets (rosaries).

18 – Unworked or semi-worked leather and animal skins, imitations of leather, stout leather, leather used for linings; goods made of leather, imitations of leather or other materials, designed for carrying items, included in this class; bags, wallets, boxes and trunks made of leather or stout leather; keycases, trunks [luggage], suitcases.

25 – Clothing, including underwear and outerclothing, other than special purpose protective clothing; socks, mufflers [clothing], shawls, bandanas, scarves, belts [clothing]; footwear, shoes, slippers, sandals; headgear, hats, caps with visors, berets, caps [headwear], skull caps.

35 – The bringing together, for the benefit of others of bleaching and cleaning preparations, detergents other than for use in manufacturing operations and for medical purposes, laundry bleach, fabric softeners for laundry use, stain removers, dishwasher detergents, perfumery, cosmetics (except medicated cosmetics), fragrances, deodorants for personal use and animals, soaps (except medicated soap), dental care preparations, dentifrices, denture polishes, tooth whitening preparations, mouth washes, not for medical purposes, abrasive preparations, emery cloth, sandpaper, pumice stone, abrasive pastes, polishing preparations for leather, vinyl, metal and wood, polishes and creams for leather, vinyl, metal and wood, wax for polishing, jewellery, imitation jewellery, gold, precious stones and jewellery made thereof, cufflinks, tie pins, statuettes and figurines of precious metal, clocks, watches and chronometrical instruments, chronometers and their parts, watch straps, commemorative statuary cups made of precious metal, chaplets (rosaries), unworked or semi-worked leather and animal skins, imitations of leather, stout leather, leather used for linings, goods made of leather, imitations of leather or other materials, designed for carrying items, bags, wallets, boxes and trunks made of leather or stout leather, keycases, trunks [luggage], suitcases, clothing, including underwear and outerclothing, other than special purpose protective clothing, socks, mufflers [clothing], shawls, bandanas, scarves, belts [clothing], footwear, shoes, slippers, sandals, headgear, hats, caps with visors, berets, caps [headwear], skull caps, enabling customers to conveniently view and purchase those goods, such services may be provided by retail stores, wholesale outlets, by means of electronic media or through mail order catalogues.

(260) AM 2022 117153 A

(800) 1651025

(151) 2021 11 28

(891) 2021 11 28

(731) Global Trade Finance GmbH  
Rainerstraße 14, A-4020 Linz, Austria

(540)

**GLOBAL TRADE FINANCE**

(591) Black, white

(531) 24.17.25; 26.13.25; 27.01.01; 27.05.01;  
27.05.09

(511)

36 – Issuance of prepaid cards and tokens of value; safe deposit services; financial, monetary and banking services; valuation services; fundraising and financial

sponsorship; real estate services; underwriting services; fundraising and financial sponsorship; insurance services; safe deposit services.

42 – Information technology [IT] consultancy services; design services; testing, authentication and quality control; scientific and technological services; IT services.

45 – Safety and rescue services, security services for the protection of material assets or persons; legal services; political lobbying services.

(260) AM 2022 117154 A

(800) 1651085

(151) 2022 01 20

(891) 2022 01 20

(731) Belyaev Sergey Ivanovich  
ul. Kirova, d. 56, kv. 62, g. Novokuznetsk,  
RU-654000 Kemerovskaya obl., Russian  
Federation

(540)



(591) Red and white

(531) 26.01.02; 26.01.04; 26.01.12; 26.01.20;  
27.05.24; 29.01.12

(511)

30 – Coffee; tea; cocoa; sugar; rice; tapioca; sago; coffee substitutes; bread; unleavened bread; pastries; ice cream; honey; yeast; baking powder; cooking salt; mustard; vinegar; condiments; spices; edible ices; aromatic preparations for food; flavourings, other than essential oils, for cakes; flavourings, other than essential oils, for beverages; coffee flavourings; food flavourings, other than essential oils; star aniseed; cereal bars; high-protein cereal bars; pancakes; noodle-based prepared meals; buns; bread rolls; vanillin [vanilla substitute]; waffles; vermicelli; natural sweeteners; sausage binding materials; binding agents for ice cream; seawater for cooking; seaweed [condiment]; malt biscuits; cloves [spice]; cake frosting [icing]; glucose for culinary purposes; gluten additives for culinary purposes; thickening agents for cooking foodstuffs; leaven; rice-based snack food; cereal-based snack food; vegetal preparations for use as coffee substitutes; dressings for salad; fruit jellies [confectionery]; confectionery for decorating Christmas trees; cakes; peanut confectionery; almond confectionery; pasta; pies; ground ginger; frozen yogurt [confectionery ices]; capers; caramels [sweets]; caramels [candies]; curry [spice]; ketchup [sauce]; quiches; gluten

prepared as foodstuff; sweets; candies; liquorice [confectionery]; peppermint sweets; cinnamon [spice]; unroasted coffee; starch for food; crackers; custard; hominy grits; semolina; oatmeal; crushed barley; groats for human food; corn, milled; maize, milled; corn, roasted; maize, roasted; meat pies; turmeric; couscous; noodles; ice, natural or artificial; rice cakes; mayonnaise; macarons; macaroni; maltose; hominy; marinades; marzipan; royal jelly; bean meal; tapioca flour; potato flour; corn flour; corn meal; maize flour; maize meal; flour; meal; wheat flour; soya flour; barley meal; confectionery in the form of mousses; chocolate mousses; muesli; mint for confectionery; cocoa beverages with milk; coffee beverages with milk; coffee-based beverages; tea-based beverages; chocolate beverages with milk; chocolate-based beverages; cocoa-based beverages; infusions, not medicinal; crushed oats; husked oats; nutmegs; stick liquorice [confectionery]; miso; lozenges [confectionery]; pastilles [confectionery]; molasses for food; pepper; allspice; peppers [seasonings]; pesto; biscuits; cookies; petit-beurre biscuits; pizzas; meat gravies; fondants [confectionery]; popcorn; powders for making ice cream; mustard meal; pralines; meat tenderizers for household purposes; oat-based food; propolis; bee glue; gingerbread; petits fours; puddings; cake powder; fruit coulis [sauces]; ravioli; chewing gum; relish [condiment]; wheat germ for human consumption; spring rolls; palm sugar; linseed for culinary purposes [seasoning]; flaxseed for culinary purposes [seasoning]; aniseed; golden syrup; confectionery; sugar confectionery; baking soda [bicarbonate of soda for cooking purposes]; malt for human consumption; salt for preserving foodstuffs; celery salt; sorbets [ices]; sherbets [ices]; ham glaze; soya sauce; tomato sauce; pasta sauce; sauces [condiments]; spaghetti; seasonings; preparations for stiffening whipped cream; rusks; bread-crumbs; sushi; sandwiches; tabbouleh; tacos; pastry dough; cake batter; cake dough; cream of tartar for culinary purposes; tarts; dough; almond paste; tortillas; garden herbs, preserved [seasonings]; beer vinegar; ferments for pastes; halvah; chips [cereal products]; corn flakes; maize flakes; oat flakes; chicory [coffee substitute]; iced tea; chutneys [condiments]; cheeseburgers [sandwiches]; chow-chow [condiment]; saffron [seasoning]; chocolate; malt extract for food; essences for foodstuffs, except etheric essences and essential oils; husked barley.

35 – Dissemination of advertising matter; demonstration of goods; market studies; advertising; publicity; shop window dressing; marketing research; providing business information; online advertising on a computer network; presentation of goods on communication media, for retail purposes; providing business information via a website.

(260) AM 2022 117156 A

(800) 1132478

(151) 2012 02 29

(891) 2022 03 03

(731) TOPCON CORPORATION

75-1, Hasunuma-cho, Itabashi-ku, Tokyo

174-8580, Japan

(540)

# SOKKIA

(591) Black, white

(531) 27.05.01

(511)

9 – Measuring or testing machines and instruments, including, standard-unit measuring machines and apparatus, temperature indicators, gasometers, thermometers, water meters, balances, tape measures, Japanese style box-shaped volume measure (masu), planimeters, measuring rules, derived-unit measuring machines and apparatus, pressure gauges (manometers), level indicators, spirit levels, acoustic meters, tachometers, accelerometers, refractometers, luminous flux meters, photometers, altimeters, hygrometers, illuminometers, vibration meters, noisemeters, logs (measuring machines), speed indicators, calorimeters, viscosimeters, concentration meters, gravimeters, densimeters, dynamometers, flowmeters, precision measuring machines and instruments, angle gauges, angle dividing apparatus (measuring instruments), spherometers, inclinometers, interferometers, straightness testing machines and instruments, profile projectors, graduation checkers (calibration checkers), length measuring gauges, screw-thread measuring machines and instruments, comparators (non-electronic), surface roughness testing machines and instruments, flatness testing machines and instruments, automatic adjusting/regulating machines and instruments, automatic pressure control machines and instruments, automatic liquid-flow control machines and instruments, automatic fluid-composition control machines and instruments, automatic liquid-level control machines and instruments, automatic temperature control machines and instruments, automatic combustion control machines and instruments, automatic vacuum control machines and instruments, automatic calorie control machines and instruments, program control machines and instruments, material testing machines and instruments, metal compression testing machines, metal hardness testing machines, metal strength testing machines, rubber testing machines, concrete testing machines, cement testing machines, textile testing machines, plastic testing machines, lumber testing machines, surveying machines and instruments, alidades, meteorological machines and apparatus, base plates (for surveying purposes), distance measuring machines or apparatus (range finders), clinometers, tripods (for surveying machines), magnetic compasses (for surveying), surveying compass needles, gyrocompasses,

magnetic gyrocompasses, photogrammetric machines, level measuring machines (for surveying), precision theodolites, rod-floats (for measuring velocity of water current), surveying chains, targets (for levelling rods), transits (for surveying), levelling rods (for surveying), sextants, astronomical measuring machines and instruments, meridian transit telescopes, astronomical spectrographs, zenith telescopes, electronic charts for identifying hiding-power of paint, thermosensitive temperature indicator strips, test pieces for rust formation testing; batteries and cells, including, dry cells, wet cells, accumulators (batteries), photovoltaic cells; optical machines and apparatus, including, telescopes and the like, body-tubes for telescopes (lens-barrels), tripods (for telescopes), periscopes, binoculars, reflectors (for telescopes), prisms (for telescopes), telescopes, lenses (for telescopes), microscopes, magnifying glasses, body-tubes for microscopes (lens-barrels), metallurgical microscopes, biological microscopes, reflectors (for microscopes), prisms (for microscopes), polarizing microscopes, stereoscopes, lenses (for microscopes); telecommunication machines and apparatus, including, telephone apparatus, intercoms, mobile phone, automatic switching apparatus (for telecommunication), manual switching apparatus (for telecommunication), telephone sets, wire communication machines and apparatus, teletypewriters, automatic telegraph apparatus, phototelegraphy apparatus, manual telegraph apparatus, repeating exchange machines, facsimile machines, transmission machines and apparatus (for telecommunication), audio frequency transmission machines and apparatus, cable transmission machines and apparatus, power-line transmission machines and apparatus, open-wire transmission machines and apparatus, transmission and repeating machines and apparatus, broadcasting machines and apparatus, television receivers (tv sets), television transmitters, radio receivers, radio transmitters, radio communication machines and apparatus, portable radio communication machines and apparatus, aeronautical radio communication machines and apparatus, multichannel radio communication machines and apparatus for fixed stations, single-channel radio communication machines and apparatus for fixed stations, vehicular radio communication machines and apparatus, marine radio communication machines and apparatus, radio application machines and apparatus, navigation apparatus for vehicles (on-board computers), radio beacon machines and apparatus, radio direction finders, radar machines and apparatus, loran navigation machines and apparatus, remote control telemetering machines and instruments, audio frequency machines and apparatus, public-address systems and instruments, compact disc players, juke boxes, tape recorders, electric phonographs, record players, sound recording machines and apparatus (audiofrequency apparatus), video frequency devices and apparatus, digital cameras, videocameras (camcorders), videodisc players, videotape recorders, DVD

players, DVD recorders, parts and accessories for telecommunication machines and apparatus, antennas (aerials), cabinets (for telecommunication apparatus), coils (for telecommunication apparatus), magnetic tape erasers, magnetic tape cleaners, magnetic head erasers, magnetic head cleaners (apparatus), loudspeakers, connectors (for telecommunication apparatus), stands and racks (for telecommunication machines and apparatus), dials (of telecommunication apparatus), electric capacitors (for telecommunication apparatus), fuses (for telecommunication apparatus), electric resistors (for telecommunication apparatus), blank magnetic tapes for tape recorders, change-over switches (for telecommunication apparatus), plugboards, pickups (for telecommunication apparatus), blank video tapes, indicator lights (for telecommunication apparatus), electrical phonomotors, headphones, electrical transformers (for telecommunication apparatus), protectors (for telecommunication apparatus), microphones (for telecommunication apparatus), cleaning apparatus for phonograph records, blank record disks, sprays for phonograph records; electronic machines, apparatus and their parts, including, electronic machines and apparatus, geiger counters, high frequency welders, cyclotrons (not for medical purposes), industrial X-ray machines and apparatus (not for medical use), industrial betatrons (not for medical use), magnetic prospecting machines, magnetic object detectors, shield cases for magnetic disks, seismic exploration machines and apparatus, hydrophone machines and apparatus, echo sounders, ultrasonic flaw detectors, ultrasonic sensors, electrostatic copying machines, computers, electron microscopes, electronic desk calculators, hard disk drives, word processors, electron tubes, X-rays tubes (not for medical use), photosensitive tubes (phototubes), vacuum tubes, rectifier tubes, cathode ray tubes, discharge tubes, semiconductor elements, thermistors, diodes, transistors, electronic circuits (not including those recorded with computer programs), integrated circuits, large scale integrated circuits; drawing or drafting instruments and apparatus adapted for use with computers.

37 – Repair of measuring and testing machines and instruments; repair of electronic machines and apparatus; repair of drawing or drafting instruments and apparatus.

42 – Surveying; geological surveys or research; computer software design, computer programming, or maintenance of computer software; rental of measuring apparatus.

(260) AM 2022 117157 A

(800) 1211398

(151) 2014 02 05

(891) 2022 01 21

(731) JACQUEMUS SAS

69 rue de Monceau, F-75008 PARIS, France

(540)

## JACQUEMUS

(591) Black, white

(511)

9 – Optical goods; spectacles (optics), sunglasses, spectacle cases; spectacle frames.

18 – Goods of leather or imitation leather (excluding cases adapted to the goods for which they are intended, gloves and belts); animal skins; umbrellas, parasols, sun umbrellas; walking sticks; handbags, travel bags, backpacks, satchels, school children's bags and satchels, beach bags, beggars' bags (handbags), shopping bags, garment bags (for travel), wheeled bags, kangaroo bags (child carriers), wallets, purses (coin purses), card cases (wallets), document holders, attaché cases, key cases (leather goods), trinket baskets of leather, trunks and suitcases, traveling trunks, sets and cases intended for toiletry articles (empty), clutch bags (leather goods), briefcases (leather goods).

25 – Clothing, footwear (excluding orthopedic footwear), headgear; gloves (clothing), belts (clothing); underwear.

(260) AM 2022 117161 A

(800) 1626222

(151) 2021 09 28

(891) 2022 02 24

(731) Travers Therapeutics, Inc.

3611 Valley Centre Drive, Suite 300, San Diego  
CA 92130, USA

(540)

## KYDGRATA

(591) Black, white

(511)

5 – Pharmaceutical preparations for the treatment of kidney disease; pharmaceutical preparations for the treatment of focal segmental glomerulosclerosis (FSGS); pharmaceutical preparations for the treatment of Immunoglobulin A Nephropathy (IgAN); pharmaceutical preparations for the treatment of Alport Syndrome; pharmaceutical preparations for the treatment of glomerulonephropathy; pharmaceutical preparations for the treatment of glomerulonephritis.

(260) AM 2022 117206 A

(800) 1651328

(151) 2021 12 03

(891) 2021 12 03

(731) NETAŞ MADENCİLİK NAKLİYE İNŞAAT

SAN. VE TİC. LTD. ŞTİ.

BOLAMAN MH. YENİ PAZAR MEVKİİ,

ILICA YOLU ÜZERİ, No:93 – 90 FATSA,

ORDU, Türkiye

(540)



(591) Blue and grey.

(531) 03.06.03; 27.05.08; 29.01.12

(511)

31 – Agricultural and horticultural products not included in other classes, seeds; forestry products not included in other classes; live animals; fertilized eggs for hatching; plants; dried plants for decoration; fresh garden herbs; dried garden herbs for decoration; animal foodstuffs; malt not for human consumption.

(260) AM 2022 117207 A

(800) 1651351

(151) 2021 10 08

(891) 2021 10 08

(731) Toruńskie Zakłady Materiałów Opatrunkowych Spółka Akcyjna  
Żółkiewskiego 20/26, PL-87-100 Toruń, Poland

(540)



(591) Black, white

(531) 05.03.13; 05.03.14; 26.04.04; 26.04.05;  
26.04.15; 26.04.18; 27.05.01; 27.05.09;  
27.05.10; 27.05.24

(511)

3 – Cotton wool for cosmetic purposes, goods made from cotton wool for cosmetic purposes, cotton sticks for cosmetic purposes, cosmetic pads, cotton pads, disposable tissues impregnated with cosmetic lotions, liquids for cleaning skin, body milk, creams for skin care, tissues impregnated with make-up removing preparations, beauty milk, shampoos, face creams for cosmetic use, bath liquids, body emulsions for cosmetic purposes, cleaning milk for toilet purposes, lotions for cosmetic purposes, gels for cosmetic use, body milks, cleaning mousse for cosmetic purposes, cleaning creams for cosmetic purposes, skin care creams for cosmetic purposes, skin cleansing lotions, lotions for cosmetic purposes, skin care oils (non-medicated), ointments for cosmetic use (non-medicated), pads impregnated with cleaning preparations, skin care oil for babies and children (non-medicated), bath lotions (non-medicated), baby oil, toilet powder, feminine hygiene cleaning towelettes.

5 – Sanitary towels, panty liners, tampons for menstruation, disposable diapers made from paper and/or cellulose, disposable diaper-pants made from paper and/or cellulose, disposable diapers for incontinent persons, disposable diaper-pants for incontinent per-

sons, disposable underwear panties for incontinent persons, breast-nursing pads, urological incontinence pads for men, anatomical urological incontinence pads for women, compresses, sets of compresses, dressing materials, cotton goods and cotton wool goods for medical purposes, gauze dressings, eye dressings, nose dressings, cellulose wadding for medical purposes, plasters, medical adhesive tapes, tampons for medical purposes, medical diagnostic test strips, hygienic and gynaecological towels for women in puerperium and after gynaecological surgeries; cotton and cotton wool for hygienic purposes, goods made from cotton and cotton wool for hygienic purposes.

10 – Elastic bandages, supportive bandages, plaster bandages for orthopedic purposes, padding for orthopedic casts, medical bedding, namely protective bedclothes, bed underpads, sheets for use in surgical operations, surgical gowns, apron for surgeon, gloves for medical purposes, bags for collecting liquids for medical purposes, containers especially made for transmitting human organs, sets of surgical instruments for use during surgical operations, medical instruments for use during surgical procedures, medical trays, surgical drapes, sets of surgical drapes, sterile sheets (surgical), protective clothing for medical purposes, protective clothing for surgical purposes, clothing especially for operating rooms, bandage clips, surgical shoe covers, covers for the patients' legs for medical purposes, incision foils for surgical use, protective mask, masks and half mask for use by medical personnel, protective masks for use by persons working in medicine.

16 – Plastic film for packing, towels of paper, disposable tissues of paper, tissues of paper for removing make-up, toilet paper, napkins of paper, disposable bibs made of paper and/or cellulose, bags and pouches for packaging made of paper and/or cellulose; paper bags for use in the sterilization of medical instruments.

17 – Plastic film, other than for wrapping.

(260) AM 2022 117208 A

(800) 1651359

(151) 2021 10 11

(891) 2021 10 11

(731) TIANJIN DAGU CHEMICAL CO., LTD.  
No. 1, Xinghua Road, Tanggu, Binhai  
New Area, Tianjin, China

(540)



(591) Black, white  
 (531) 26.15.09; 27.01.12; 27.05.01; 28.03  
 (511)  
 1 – Propylene glycol; polypropylene; ethylene; propylene.

(260) AM 2022 117209 A  
 (800) 1651370  
 (151) 2021 11 30  
 (891) 2021 11 30  
 (731) Tovarishchestvo s ogranichennoy  
 otvetstvennost'yu "QAZ GOLDMAN"  
 ulica Abylai Khana, 42/1, gorod Kaskelen,  
 Karasaiskiy raion, Almatinskaya oblast',  
 Kazakhstan  
 (540)

## DAUSCHER

(591) Black, white  
 (511)  
 11 – Cooking stoves; hot plates; heating apparatus, electric; hair dryers; bread toasters; ventilation [air-conditioning] installations and apparatus; bread-making machines; refrigerators; kettles, electric; cooking utensils, electric; autoclaves, electric, for cooking; radiators [heating]; cooking rings; microwave ovens [cooking apparatus]; kitchen ranges [ovens]; refrigerating appliances and installations; bakers' ovens; heaters; coffee machines, electric; air-conditioning apparatus; refrigerating chambers; electric fans for personal use.  
 35 – Promoting the goods and services of others.

(260) AM 2022 117210 A  
 (800) 1651411  
 (151) 2021 08 31  
 (891) 2021 08 31  
 (731) Vlaamse overheid, Diensten voor het Algemeen  
 Regeringsbeleid (Afdeling Communicatie)  
 Boudewijnlaan 30 , bus 20, B-1000 Brussel,  
 Belgium  
 (540)



(591) Black, white  
 (531) 03.01.01; 03.01.02; 03.01.16; 26.11.09;  
 27.05.10  
 (511)  
 35 – Advertising; business management; business administration; clerical services; procurement services for others [purchasing goods and services for other businesses]; arranging newspaper subscriptions for

others; arranging subscriptions to telecommunication services for others; administrative processing of purchase orders; business management consultancy; human resources consultancy; business organization consultancy; advisory services for business management; commercial information agency services; employment agency services; business management and organization consultancy; computerized file management; business project management services for construction projects; updating of advertising material; book-keeping; copywriting; shop window dressing; demonstration of goods; retail services for pharmaceutical, veterinary and sanitary preparations and medical supplies; shop window dressing; economic forecasting; shop window dressing; business appraisals; business efficiency expert services; invoicing; photocopying services; compilation of information into computer databases; commercial information and advice for consumers in the choice of products and services; providing business information via a web site; administrative services for the relocation of businesses; tax preparation; commercial or industrial management assistance; commercial or industrial management assistance; business administration assistance; import-export agency services; provision of commercial and business contact information; business information; business inquiries; news clipping services; cost price analysis; layout services for advertising purposes; modelling for advertising or sales promotion; marketing; market research; marketing studies; organization of fashion shows for promotional purposes; negotiation and conclusion of commercial transactions for third parties; business investigations; opinion polling; writing of publicity texts; drawing up of statements of accounts; compilation of statistics; web site traffic optimization; search engine optimisation; data search in computer files for others; organization of trade fairs for commercial or advertising purposes; organization of exhibitions for commercial or advertising purposes; outsourcing services [business assistance]; transcription of communications [office functions]; psychological testing for the selection of personnel; personnel recruitment; presentation of goods on communication media, for retail purposes; price comparison services; production of advertising films; professional business consultancy; professional business consultancy; business management of hotels; business management of performing artists; public relations services; advertising; advertising by mail order; radio advertising; advertising [online] on a computer network; outdoor advertising; advertising by mail order; radio advertising; television advertising; advertising agency services; pay per click advertising; document reproduction; payroll preparation; secretarial services; sponsorship search; shorthand; systemization of information into computer databases; systemization of information into computer databases; layout services for advertising purposes; word processing; telephone answering for unavailable subscribers; telemarketing services; tele-



vision advertising; transcription of communications [office functions]; typing; publication of publicity texts; updating and maintenance of data in computer databases; auctioneering services; rental of advertising space; rental of photocopying machines; rental of office machines and equipment; publicity material rental; rental of advertising time on communication media; rental of vending machines; rental of sales stands; sales promotion for others; auctioneering services; distribution of samples for publicity purposes; dissemination of advertising matter; direct mail advertising; sponsorship search; business management for freelance service providers; business management of sports people; business research; commercial administration of the licensing of the goods and services of others; business auditing; commercial intermediation services; business appraisals.

36 – Insurance services; financial affairs; monetary affairs; real estate brokerage; actuarial services; debt advisory services; financial advisory services; insurance consultancy; real estate agency services; banking; banking; apartment house management; real estate management; lending against security; exchange brokerage services; stock exchange quotations; safe deposit services; deposits of valuables; bail bonding services; fire insurance underwriting; clearing, financial; organization of monetary collections; brokerage services; payment card services; debit card services; pawnbrokerage; pawnbrokerage; provident fund services; savings bank services; customs brokerage; electronic funds transfer; factoring; investment trusteeship; financial management; financial advisory services; financial analysis; financial information; providing financial information via a web site; repair costs evaluation [financial appraisal]; financial evaluation of wool; financial evaluation [insurance, banking, real estate]; financing services; fiscal valuation; fiscal valuation; mutual funds; surety services; currency trading and exchange services; hire-purchase financing; mortgage banking; rent collection; debt collection agency services; insurance information; rent collection; capital investment; capital investment; credit bureau services; hire-purchase financing; loans [financing]; instalment loans; life insurance underwriting; organising of charitable collections; business liquidation services, financial; stock brokerage services; brokerage of carbon credits; insurance brokerage; accident insurance underwriting; retirement payment services; marine insurance underwriting; financial sponsorship; antique appraisal; financial evaluation of standing timber; jewellery appraisal; art appraisal; numismatic appraisal; real estate appraisal; stamp appraisal; online banking; issuance of credit cards; issuance of travellers' cheques; issuance of tokens of value; repair costs evaluation [financial appraisal]; rental of apartments; rental of offices [real estate]; rental of farms; cheque verification; rental of real estate; clearing, financial; insurance brokerage; arranging finance for construction projects; mutual funds; accommoda-

tion bureau services [apartments]; health insurance underwriting.

37 – Construction; installation and repair of air-conditioning apparatus; installation and repair of air-conditioning apparatus; fire alarm installation and repair; burglar alarm installation and repair; vehicle breakdown repair services; repair information; electric appliance installation and repair; irrigation devices installation and repair; warehouse construction and repair; furnace installation and repair; telephone installation and repair; installation, maintenance and repair of computer hardware; office machines and equipment installation, maintenance and repair; machinery installation, maintenance and repair; automobile repair and maintenance; burner maintenance and repair; safe maintenance and repair; strong-room maintenance and repair; clock and watch repair; airplane maintenance and repair; leather care, cleaning and repair; underwater repair; freezing equipment installation and repair; heating equipment installation and repair; boiler cleaning and repair; boiler cleaning and repair; film projector repair and maintenance; upholstery repair; repair of power lines; photographic apparatus repair; clothing repair; umbrella repair; parasol repair; pump repair; repair of security locks; painting or repair of signs; vulcanization of tyres [repair]; vulcanization of tyres [repair]; pipeline construction and maintenance; fur care, cleaning and repair; furniture maintenance; vehicle maintenance; swimming-pool maintenance; vehicle service stations [refuelling and maintenance]; restoration of works of art; furniture restoration; restoration of musical instruments; mending clothing; elevator installation and repair; installation of doors and windows; installation of kitchen paper dispensers; installation of doors and windows.

38 – Telecommunication services; electronic bulletin board services [telecommunications services]; communications by computer terminals; communications by fibre optic networks; computer aided transmission of messages and images; wireless broadcasting; electronic transmission of messages; facsimile transmission; providing telecommunications connections to a global computer network; information about telecommunication; communications by cellular phones; news agency services; transmission of greeting cards online; videoconferencing services; news agency services; news agency services; paging services [radio, telephone or other means of electronic communication]; satellite transmission; teleconferencing services; communications by telephone; telephone services; telegraph services; communications by telegrams; cable television broadcasting; telex services; providing internet chatrooms; providing online forums; providing telecommunication channels for teleshopping services; transmission of digital files; radio broadcasting; transmission of television programs; rental of message sending apparatus; rental of facsimile apparatus; rental of modems; rental of telecommunication equip-



ment; rental of telephones; rental of access time to global computer networks; providing access to databases; providing user access to global computer networks; facsimile transmission; message sending; transmission of electronic mail; sending of telegrams; telecommunications routing and junction services; voice mail services.

39 – Transport; packaging and storage of goods; organisation of trips; water supplying; parcel delivery; ambulance transport; coach transport; escorting of travellers; freighting; message delivery; river transport; bottling services; shipbrokerage; freighting; chauffeur services; ice-breaking; car park services; delivery of goods; distribution of energy; supply of electricity; franking of mail; physical storage of electronically stored data or documents; vehicle breakdown towing services; storage information; transportation information; traffic information; wrapping of goods; courier services [messages or merchandise]; delivery of newspapers; porter services; launching of satellites for others; delivery of goods by mail order; flower delivery; delivery of goods; transportation logistics; piloting; unloading cargo; freight brokerage [forwarding (am)]; transporting furniture; underwater salvage; storage; boat storage; freight warehousing; arranging of cruises; arranging of transportation for travel tours; arranging of cruises; arranging of cruises; parcel delivery; passenger transport; booking of seats for travel; pleasure boat transport; refloating of ships; salvaging; rescue operations [transport]; travel reservation; escorting of travellers; travel and passenger transportation; travel reservation; transport reservation; providing driving directions for travel purposes; towing; operating canal locks; stevedoring; sightseeing [tourism]; tram transport; transport services; air transport; transport and storage of waste; car transport; armoured-car transport; transport brokerage; transport reservation; ferryboat operating; removal services; removal services; car rental; boat rental; rental of diving bells; rental of diving suits; garage rental; rental of vehicle roof racks; refrigerator rental; aircraft rental; rental of navigational systems; rental of storage containers; rental of warehouses; horse rental; parking place rental; rental of motor racing cars; rental of wheelchairs; motor coach rental; railway coach rental; rental of aircraft engines; vehicle rental; rental of freezers; rental of wagons; traffic information; packaging of goods; air transport; transport by pipeline; transport by pipeline; marine transport; barge transport; ambulance transport; boat transport; carting; lighterage services; railway transport; taxi transport; hauling; freight forwarding; refloating of ships; freight [shipping of goods]; armoured-car transport; water supplying; water distribution.

40 – Stripping finishes; photographic printing; abrasion; laser scribing; waste treatment [transformation]; incineration of waste and trash; destruction of waste and trash; fur mothproofing; textile mothproofing; pa-

per finishing; applying finishes to textiles; custom assembling of materials for others; textile treating; metal plating; skin dressing; key cutting; bleaching of textiles; bookbinding; fur conditioning; custom fashioning of fur; embroidering; food and drink preservation; services of a dental technician; printing; processing of cinematographic films; photocomposing services; photogravure; millworking; galvanization; cryopreservation services; decontamination of hazardous materials; fur glossing; glass-blowing; gold plating; engraving; metal hardening; air deodorizing; woodturning services; material treatment information; framing of works of art; freezing of foods; permanent-press treatment of fabrics; timber felling and processing; pottery firing; custom tailoring; window tinting treatment, being surface coating; boilermaking; cloth pre-shrinking; laminating; welding services; leather working; lithographic printing; tanning; air freshening; air purification; magnetization; flour milling; metal treating; metal casting; dressmaking; offset printing; processing of oil; cloth edging; cloth fireproofing; crease-resistant treatment for clothing; photographic film development; pattern printing; energy production; taxidermy; paper treating; fruit crushing; electroplating; cadmium plating; burnishing by abrasion; optical glass grinding; refining services; recycling of waste and trash; food smoking; fur satining; planing of materials; colour separation services; warping [looms]; slaughtering; grinding; blacksmithing; sorting of waste and recyclable material [transformation]; cutting of fabric; chromium plating; gilding; rental of air-conditioning apparatus; knitting machine rental; rental of generators; rental of space heating apparatus; rental of boilers; clothing alteration; nickel plating; tin plating; fur dyeing; leather staining; shoe staining; cloth dyeing; textile dyeing; dyeing services; silver plating; fulling of cloth; vulcanization [material treatment]; water treating; cloth waterproofing; quilting; wool treating; saddlery working; sawing of materials; sandblasting services; silkscreen printing.

41 – Education; training; entertainment services; sporting and cultural activities; academies [education]; educational examination; entertainment services; amusement park services; vocational guidance [education or training advice]; providing casino facilities [gambling]; presentation of circus performances; club services [entertainment or education]; coaching [training]; music composition services; electronic publishing services; amusement arcade services; mobile library services; zoological garden services; zoological garden services; disc jockey services; entertainer services; recording studio services; news reporters services; educational services provided by schools; language interpreter services; animal training; discotheque services; teaching; videotaping; film production, other than advertising films; movie studio services; rental of motion pictures; conducting fitness classes; photography; photographic reporting; health club services [health and fitness training]; health club services

[health and fitness training]; religious education; gambling services; gymnastic instruction; arranging and conducting of colloquiums; arranging and conducting of conferences; arranging and conducting of congresses; arranging and conducting of seminars; arranging and conducting of symposiums; arranging and conducting of workshops [training]; scriptwriting services; entertainment information; education information; information services relating to recreation; training; sign language interpretation; calligraphy services; nursery schools; boarding school education; layout services, other than for advertising purposes; physical education; tutoring; microfilming; mobile library services; modelling for artists; organization of fashion shows for entertainment purposes; videotape editing; providing museum facilities [presentation, exhibitions]; music-halls; production of musical shows; nightclub services [entertainment]; dubbing; vocational retraining; subtitling; teaching; online publication of electronic books and journals; radio entertainment; television entertainment; writing of texts, other than publicity texts; organization of balls; organization of lotteries; arranging of beauty contests; organization of sports competitions; arranging of exhibitions for cultural or educational purposes; organization of shows [impresario services]; organization of competitions [education or entertainment]; arranging and conducting of concerts; orchestra services; personal trainer services [fitness training]; ticket agency services [entertainment]; booking of seats for shows; practical training [demonstration]; amusement park services; film production, other than advertising films; production of shows; party planning [entertainment]; production of radio and television programmes; organisation of correspondence courses; correspondence courses; writing of texts, other than publicity texts; sport camp services; layout services, other than for advertising purposes; publication of texts, other than publicity texts; providing golf facilities; providing recreation facilities; karaoke services; providing online music, not downloadable; providing online videos, not downloadable; game services provided online from a computer network; providing online electronic publications, not downloadable; providing sports facilities; theatre productions; timing of sports events; presentation of live performances; publication of books; publication of texts, other than publicity texts; lending library services; holiday camp services [entertainment]; music-halls; rental of audio equipment; lease of scenery; rental of skin diving equipment; rental of motion pictures; rental of movie projectors and accessories; hire of phonograph records; rental of radio and television sets; toy rental; games equipment rental; rental of sports grounds; rental of sports equipment, except vehicles; rental of stadium facilities; rental of tennis courts; rental of stage scenery; rental of lighting apparatus for theatrical sets or television studios; rental of videotapes; rental of video cameras;

rental of video cassette recorders; translation and interpretation; cinema presentations.

42 – Scientific and technological services and research and design relating thereto; industrial analysis and research services; design and development of computer hardware and software; web site design consultancy; information technology [it] consultancy; architectural consultancy; consultancy in the field of energy-saving; consultancy in the design and development of computer hardware; computer software consultancy; water analysis; energy auditing; analysis for oil-field exploitation; architectural services; authenticating works of art; bacteriological research; computer virus protection services; architectural design for interior decoration; biological research; construction drafting; cartography services; chemical research; chemical analysis; cloud computing; computer programming; monitoring of computer systems by remote access; oil-well testing; conversion of computer programs and data, other than physical conversion; conversion of data or documents from physical to electronic media; cosmetic research; chemistry services; land surveying; clothing design services; scientific laboratory services; electronic data storage; engineering services; surveying; off-site data backup; research in the field of physics; geological research; geological surveys; geological prospecting; graphic arts design; handwriting analysis [graphology]; recovery of computer data; server hosting; calibration [measuring]; industrial design; industrial design; providing information on computer technology and programming via a web site; installation of computer software; cloud seeding; clinical trials; copying of computer software; quality evaluation of standing timber; quality evaluation of wool; quality control; quality checking; meteorological forecasting; research in the field of physics; oil prospecting; maintenance of computer software; underwater exploration; research and development of new products for others; mechanical research; research in the field of environmental protection; oil-field surveys; computer system design; creating and maintaining web sites for others; packaging design; land surveying; digitization of documents [scanning]; computer software design; updating of computer software; urban planning; styling [industrial design]; computer system analysis; engineering research; vehicle roadworthiness testing; conducting technical project studies; software as a service [saas]; providing search engines for the internet; material testing; textile testing; updating of computer software; rental of computer software; computer rental; rental of web servers; water analysis; hosting web sites; meteorological information; mechanical research; provision of research services; provision of scientific information, advice and consultancy in relation to carbon offsetting.

43 – Services for providing food and drink; temporary accommodation; bar services; retirement home servi-

ces; accommodation bureau services [hotels, boarding houses]; café services; food and drink catering; day-nursery [crèche] services; boarding for animals; hotel services; hotel reservations; canteen services; day-nursery [crèche] services; day-nursery [crèche] services; motel services; boarding house bookings; boarding house services; temporary accommodation reservations; restaurant services; snack-bar services; food sculpting; providing campground facilities; food and drink catering; tourist home services; holiday camp services [lodging]; rental of cooking apparatus; rental of chairs, tables, table linen, glassware; rental of tents; rental of temporary accommodation; rental of meeting rooms; rental of lighting apparatus; rental of transportable buildings\*; rental of drinking water dispensers; self-service cafeteria services.

44 – Medical services; animal healthcare services; hygienic and beauty care for human beings or animals; agriculture, horticulture and forestry services; health counselling; pharmacy advice; alternative medicine services; preparation of prescriptions by pharmacists; aromatherapy services; midwife services; floral design services; tree surgery; tree nurseries; surgery (cosmetic -); animal grooming services; blood bank services; chiropractic; health spa services; health centre services; medical clinic services; opticians' services; sauna services; solarium services; beautician services; solarium services; services of a psychologist; telemedicine services; depilatory waxing; farming (animals); physiotherapy; lawn care; medical assistance; medical services; hair implantation; convalescent homes; in vitro fertilization services; hair salon services; nursing home services; artificial insemination services; landscape architecture services; speech therapy; manicuring; massage; lawn care; weed killing; rehabilitation of drug addicted patients; public bath services for hygiene purposes; wreath making; hospices; orthodontic services; tree planting for carbon offsetting purposes; plastic surgery; medical clinic services; in vitro fertilization services; convalescent home services; sanatorium services; beauty salon services; dentistry; tattooing; therapy services; animal grooming services; landscape gardening; horticulture; gardening; Turkish bath services; aerial and surface spreading of fertilizers and other agricultural chemicals; vermin exterminating for agriculture, aquaculture, horticulture and forestry; weed killing; farming equipment rental; medical equipment rental; rental of sanitary installations; aerial and surface spreading of fertilizers and other agricultural chemicals; aquaculture services; hospital services; nursing, medical.

45 – Legal aid services; security services for the protection of property and individuals; personal background investigations; babysitting; embalming services; chaperoning; burial services; conducting funeral ceremonies; alternative dispute resolution services; fire-fighting; crematorium services; detective services; adoption agency services; litigation services; house si-

ting; marriage agency services; releasing doves for special occasions; mediation; missing person investigations; dating agency services; opening of security locks; horoscope casting; pet sitting; organization of religious meetings; planning and arranging of wedding ceremonies; online social networking services; genealogical research; lost property return; rental of evening wear; rental of clothing.

(260) AM 2022 117213 A

(800) 1651604

(151) 2022 01 18

(891) 2022 01 18

(731) FANUC CORPORATION

3580, Shibokusa Aza-Komanba, Oshino-mura, Minamitsuru-gun, Yamanashi 401-0597, Japan

(540)

## ROBOCUT

(591) Black, white

(511)

7 – Electric discharge machines; other metalworking machines and tools.

(260) AM 2022 117214 A

(800) 1651605

(151) 2022 01 18

(891) 2022 01 18

(731) FANUC CORPORATION

3580, Shibokusa Aza-Komanba, Oshino-mura, Minamitsuru-gun, Yamanashi 401-0597, Japan

(540)

## ROBODRILL

(591) Black, white

(511)

7 – Machining centers; other metalworking machines and tools.

(260) AM 2022 117215 A

(800) 1651673

(151) 2022 02 06

(891) 2022 02 06

(731) bahrebardari va tamin hotelhaye rexan

No34, Street golrokh, street azin, Quarter aseman, City Tehran, Islamic Republic of Iran

(540)

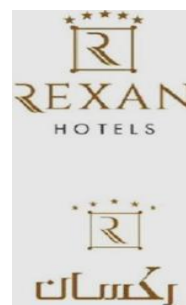

(591) Golden and black  
 (531) 01.01.05; 01.01.10; 26.04.06; 26.04.18;  
 27.05.01; 27.05.09; 27.05.10; 28.01; 29.01.13  
 (526) hotels  
 (511)  
 43 – Hotel reservations; hotel services; accommodation bureau services [hotels, boarding houses].

(260) AM 2022 117216 A  
 (800) 1651674  
 (151) 2021 12 10  
 (891) 2021 12 10  
 (731) ONAYLIFT ASANSÖR İNŞAAT  
 OTOMOTİV MAKİNA SANAYİ VE  
 TİCARET LİMİTED ŞİRKETİ  
 K.O.S. Bölgesi Büyükkayacık Mahallesi,  
 Vezirköy Caddesi, Kocadere Sokak, No: 3,  
 Selçuklu, Konya, Türkiye

(540)



(591) Green, grey and white  
 (531) 27.05.10; 29.01.12  
 (526) Components  
 (511)  
 7 – Lifting, loading and transmission machines and robotic mechanisms (machines) for lifting, loading and transmission purposes: elevators, escalators and cranes; elevator doors, elevator cabins, elevator motors.

(260) AM 2022 117217 A  
 (800) 1651714  
 (151) 2021 12 23  
 (891) 2021 12 23  
 (731) Kraft Foods Schweiz Holding GmbH  
 Chollerstrasse 4, CH-6300 Zug, Switzerland

(540)



(591) Purple, white, brown, gold, beige and pink  
 (531) 03.04.02; 03.04.24; 06.01.02; 06.01.04;  
 19.03.03; 27.05.01; 27.05.08; 27.05.24;  
 29.01.15  
 (511)  
 29 – Dried, preserved, cooked and steamed fruits; jellies; jams; marmalades; cocoa butter; dairy products, dairy-based spreads, milk-based desserts and

chilled milk-based desserts, including creams (dairy products); yoghurt and yoghurt products, including yoghurt-based drinks, sweet fromage blanc, cottage cheese, all coated with chocolate or cocoa, or flavoured with chocolate or cocoa; milk and dairy products, milk powder, desserts and preparations for desserts based on dairy products, all coated with chocolate or cocoa, or flavoured with chocolate or cocoa; milkshakes; buttercream; crème fraîche; sour cream; whipping cream; whipped cream; beverages, mainly milk-based, milk-based beverages, coffee cream for beverages, all flavoured with chocolate or cocoa; milk substitutes, including almond milk, soy milk, rice milk, coconut milk, oat milk, peanut milk; yogurt and beverages based on milk-substitute yogurt; desserts based on milk substitutes; beverages based on milk substitutes; snacks based on potatoes, vegetables or fruit; roasted, dehydrated, salted and seasoned nuts; hazelnut spreads; fruit spreads; nut-based spreads.

30 – Cocoa; chocolate; tea; coffee; cocoa-based beverages; Chocolate beverages; chocolate-based beverages; tea-based beverages; coffee-based beverages and preparations for making such beverages; bread and pastries; sugar and artificial sweeteners (chemical products); pastry; biscuits and cookies; brownies; cheesecakes; cakes; waffles; wafers; confectionery, particularly sugar confectionery and chocolate confectionery; chocolate spreads; chocolate toppings; chocolate syrups; flavoring syrups; frozen and chilled confectionery; ice cream; desserts based on cereals and chocolate; frozen desserts based on cereals and chocolate; frozen cakes; frozen pastries; frozen bakery preparations; frozen yogurt; chilled desserts based on cereals and chocolate; dough-based products; preparations based on cereals, bakery preparations; breakfast cereals; sherbets (ices); ice cream cones; pudding; desserts in the form of mousses (confectionery); popcorn; corn chips; snacks based on corn, rice, barley, rye or in the nature of pastries; all the aforesaid goods also gluten free; trifles; cream pudding.

(260) AM 2022 117218 A  
 (800) 1651724  
 (151) 2021 08 10  
 (891) 2021 08 10  
 (731) CHONGQING AMITY MACHINERY CO.,  
 LTD.  
 28-5# No. 200 Zhongshan 2 Road, Yuzhong  
 District, 400014 Chongqing, China  
 (540)

## TICOTA

(591) Black, white  
 (511)  
 6 – Common metals, unwrought or semi-wrought; tubes of metal; sleeves [metal hardware]; fittings of metal for building; railway material of metal; bands of metal for tying-up purposes; clips of metal for cables

and pipes; ironmongery; buckles of common metal [hardware]; nails; fittings of metal for furniture; door bells of metal, non-electric; locks of metal, other than electric; padlocks of metal, other than electronic; keys of metal; safes; vice claws of metal; tool chests of metal, empty; labels of metal; bells for animals; rods of metal for welding; anchors; identification bracelets of metal; wind vanes of metal; tree protectors of metal; traps for wild animals; works of art of common metal; iron ores; monuments of metal; angle irons of metal; props of metal; elbows of metal for pipes; junctions of metal for pipes; valves of metal, other than parts of machines; reinforcing materials of metal for pipes; collars of metal for fastening pipes; staircases of metal; buildings, transportable, of metal; fences of metal; building materials of metal; scaffolding of metal; steel wire; ropes of metal; wall plugs of metal; screws of metal; hinges of metal; hooks [metal hardware]; pulleys of metal, other than for machines.

7 – Agricultural machines; lawnmowers [machines]; aerating pumps for aquaria; fodder cutting machines [feed cutters]; milking machines; electric shearing machines; woodworking machines; saws [machines]; cardboard manufacturing machines; diaper producing equipment; printing machines; looms; sizing machines; tea manufacturing machines; food preparation machines, electromechanical; brewing machines; tobacco processing machines; leather-working machines; stitching machines; bicycle assembling machines; brick making machines; engraving machines; machines for battery industry; cord making machines; enamel making machinery; light bulb making machines; packaging machines; briquet making machines; washing machines [laundry]; centrifugal mills; rubber cementing machines; glass-working machines; fertilizer manufacturing equipment; electromechanical machines for chemical industry; mine borers; cutters [machines]; oil-well pumps for petroleum industry; mixing machines; disintegrators; hoist cranes; pneumatic hammers; trimming machines; foundry machines; metalworking machines; steam engines; igniting devices for internal combustion engines; wind power plants; needle making machines; zipper making machines; stands for machines; cutting machines; electric wire and cable manufacturing machines; tools [parts of machines]; machines and apparatus for polishing [electric]; drilling heads [parts of machines]; hand-held tools, other than hand-operated; angle polishers; machines for the electronic industry; optical cold working machines; gas separating installations; paint-spraying machines; dynamos; motors, other than for land vehicles; pumps [machines]; valves [parts of machines]; compressed air machines; pneumatic cylinders [parts of machines]; propulsion mechanisms, other than for land vehicles; bearings [parts of machines]; belts for machines; welding machines, electric; machines and apparatus for cleaning, electric; high pressure washers; vacuum cleaners; filter presses; electric gate scrolling machines; shoe polishers, elec-

tric; electroplating machines; door openers, electric; kitchen machines, electric.

8 – Abrading instruments [hand instruments]; agricultural implements, hand-operated; garden tools, hand-operated; instruments and tools for skinning animals; harpoons; manicure sets; bits [parts of hand tools]; perforating tools [hand tools]; riveters [hand tools]; lifting jacks, hand-operated; graving tools [hand tools]; masons' trowels; pruning scissors; sabres; tableware [knives, forks and spoons]; handles for hand-operated hand tools; hand tools, hand-operated; guns, hand-operated, for the extrusion of mastics.

9 – Counters; apparatus to check franking; counterfeit coin detectors; ticket dispensers; voting machines; face recognition apparatus; photocopiers [photographic, electrostatic, thermic]; weighing apparatus and instruments; measuring apparatus; electronic notice boards; navigational instruments; electric and electronic video surveillance installations; cameras [photography]; surveying apparatus and instruments; levels [instruments for determining the horizontal]; speed checking apparatus for vehicles; pressure measuring apparatus; chemistry apparatus and instruments; measuring devices, electric; lasers, not for medical purposes; electronic chips; capacitors; switches, electric; connections, electric; electric plugs; control panels [electricity]; covers for electric outlets; video screens; remote control apparatus; optical fibers [light conducting filaments]; heat regulating apparatus; lightning arresters; electrolyzers; fire extinguishing apparatus; radiological apparatus for industrial purposes; protection devices for personal use against accidents; clothing for protection against accidents, irradiation and fire; protective masks; gloves for protection against accidents; kneepads for workers; theft prevention installations, electric; locks, electric; eyeglasses; animated cartoons; protective industrial boots; electrical sockets; electric contacts; ear plugs for divers; biometric fingerprint door locks; endoscopy cameras for industrial purposes; rearview cameras for vehicles; sensors; alarms; cabinets for loudspeakers; event data recorders; bathroom scales; computer network switches; computer network bridges; network routers; radio receivers and transmitters; radio signal tuners; electric door bells; intercoms; videophones; video monitors; air analysis apparatus; wireless routers; slide calipers; measures; rulers [measuring instruments]; micrometers; marking gauges [joinery]; square rulers for measuring; dial gauge; measuring tapes; ultrasonic thickness gauges; electronic sliding calipers; mobile power supply [rechargeable battery]; batteries, electric; battery chargers; materials for electricity mains [wires, cables].

11 – Electric lamps; lighting apparatus and installations; fluorescent tubes; lights for vehicles; germicidal lamps for purifying air; curling lamps; oil lamps; cooking apparatus and installations; lava rocks for use in barbecues; cooling appliances and installations; air purifying apparatus and machines; fans [air-conditio-

ning]; electric hair dryers; heating apparatus, electric; fog machines for theater; faucets; pipes [parts of sanitary installations]; watering installations, automatic; bath installations; sanitary apparatus and installations; water purification installations; radiators, electric; gas lighters; polymerisation installations; light bulbs; searchlights; electric flashlights; refrigerating appliances and installations; air-conditioning installations; water purifying apparatus and machines; pocket warmers; air purifiers [for household purposes]; electric water purifiers for household purposes; humidifiers for household purposes; kettles, electric; extractor hoods for kitchens; gas ranges; heat guns; cocks for pipes and pipelines; disinfectant apparatus; electrically heated clothing.

(260) AM 2022 117219 A

(800) 1651766

(151) 2021 12 29

(891) 2021 12 29

(731) Gorilla Drinks Limited

Amathountos, 50E, PEARL BUILDING,  
3rd floor, Flat/Office 1, Agios Tychonas,  
CY-4532 Limassol, Cyprus

(540)



(591) Orange, blue, white and green

(531) 02.01; 02.01.08; 02.01.16; 03.05; 03.05.19;  
03.05.20; 03.05.24; 05.01; 05.01.12; 05.07;  
05.07.06; 26.04; 26.04.07; 26.04.16; 26.04.18;  
26.04.24; 26.13; 26.13.01; 27.05; 27.05.01;  
27.05.09; 27.05.10; 27.05.19; 29.01; 29.01.14

(526) ENERGY DRINK MANGO Coconut

(511)

32 – Non-alcoholic beverages; fruit beverages and fruit juices; syrups and other non-alcoholic preparations for making beverages; aperitifs, non-alcoholic; cocktails, non-alcoholic; isotonic beverages; protein-enriched sports beverages; soft drinks; non-alcoholic fruit juice beverages; non-alcoholic energy drinks; non-alcoholic tonic drinks, including those containing caffeine, taurine, except for medical and dietary purposes; fruit nectars, non-alcoholic; smoothies; non-alcoholic fruit extracts.

(260) AM 2022 117220 A

(800) 1651775

(151) 2021 10 14

(891) 2021 10 14

(731) Intertech Services AG

Werftstrasse 4, CH-6005 Lucerne, Switzerland

(540)

## Toloka

(591) Black, white

(511)

9 – Electronic interactive whiteboards; electronic notice boards; interfaces for computers; computer software, recorded; computer software platforms, recorded or downloadable; computer software applications, downloadable; computer programs, recorded; computer game software, downloadable; computer game software, recorded; computer programs, downloadable; computer operating programs, recorded; electronic publications, downloadable; downloadable image files; downloadable music files; animated cartoons; downloadable graphics for mobile phones; downloadable mobile applications.

35 – Provision of an online marketplace for buyers and sellers of goods and services.

41 – Publication of texts, other than publicity texts; providing online electronic publications, not downloadable; arranging and conducting of workshops [training]; vocational guidance [education or training advice].

42 – Graphic design of promotional materials; installation of computer software; research and development of new products for others; website design consultancy; data security consultancy; monitoring of computer systems by remote access; providing information relating to computer technology and programming via a website; platform as a service [PaaS]; rental of computer software; hosting computer sites [web sites]; server hosting; development of computer platforms; creating and designing website-based indexes of information for others [information technology services]; creating and maintaining websites for others; technical writing; cloud computing; information technology services provided on an outsourcing basis; off-site data backup; user authentication services using single sign-on technology for online software applications; user authentication services using technology for e-commerce transactions; data encryption services; electronic data storage.

(260) AM 2022 117221 A

(800) 1651809

(151) 2022 01 19

(891) 2022 01 19

(731) Kia Corporation

12, Heolleung-ro, Seocho-gu, Seoul 06797,  
Republic of Korea

(540)



Movement that inspires



(591) Black, white  
 (531) 27.05.01; 27.05.09; 27.05.10; 27.05.19;  
 27.05.22

(511)  
 10 – Medical apparatus and instruments; medical instruments; artificial limbs, eyes and teeth; robotic exoskeleton suits for medical purposes; chiropractic suspension vests; massaging apparatus for personal use; body rehabilitation apparatus for medical purposes; medical thermometers; body fat measuring devices for medical use; orthopedic articles; blood glucose meters; nanorobots for medical purposes; surgical robots; dental apparatus and instruments; blankets for medical purposes; thread for medical use; baby bottles; bedpans; sterilised clothing for surgical purposes; gloves for medical purposes; sanitary masks for medical purposes.

(260) AM 2022 117222 A  
 (800) 1651852  
 (151) 2022 01 26  
 (891) 2022 01 26  
 (731) Taka Terminals  
 Lubanas soseja 9km, Stopinu pag., LV-2130  
 Ropazu novads, Latvia

(540)



(591) Black, white  
 (531) 26.11.01; 26.11.12; 27.05.12  
 (511)

34 – Electronic cigarette atomizers; electronic cigarettes; personal vaporisers and electronic cigarettes, and flavourings and solutions therefor; liquid solutions for use in electronic cigarettes; smoking sets for electronic cigarettes; oral vaporizers for smokers; electronic cigarette cartomizers; cigarette cutters; cartridges for electronic cigarettes; electronic cigarette liquid [e-liquid] comprised of flavorings in liquid form used to refill electronic cigarette cartridges; refill cartridges for electronic cigarettes; electronic nicotine inhalation devices; electronic cigarette cleaners.

35 – Advertising.

(260) AM 2022 117223 A  
 (800) 1651915  
 (151) 2021 10 01  
 (891) 2021 10 01  
 (731) Egis Gyógyszergyár Zrt.  
 Keresztúri út 30-38., H-1106 Budapest,  
 Hungary

(540)

**ПЛАЗЭК**

(591) Black, white  
 (531) 28.05  
 (511)  
 3 – Cosmetics and cosmetic preparations.

5 – Human pharmaceutical preparations (term considered linguistically incorrect by the International Bureau – rule 13 (2) (b) of the Regulations); dietetic substances adapted for medical use; dietary supplements; medicinal ointments; medicated skin creams; plasters, materials for dressings.

(260) AM 2022 117224 A  
 (800) 1651916  
 (151) 2021 10 01  
 (891) 2021 10 01  
 (731) Egis Gyógyszergyár Zrt.  
 Keresztúri út 30-38., H-1106 Budapest,  
 Hungary

(540)

**АЗЕЛОСОЛЮТ**

(591) Black, white  
 (531) 28.05  
 (511)  
 3 – Cosmetics and cosmetic preparations.

5 – Human pharmaceutical preparations (term considered linguistically incorrect by the International Bureau – rule 13 (2) (b) of the Regulations); dietetic substances adapted for medical use; dietary supplements; medicinal ointments; medicated skin creams; plasters, materials for dressings.

(260) AM 2022 117227 A  
 (800) 1651919  
 (151) 2021 10 01  
 (891) 2021 10 01  
 (731) Egis Gyógyszergyár Zrt.  
 Keresztúri út 30-38., H-1106 Budapest,  
 Hungary

(540)

**НАЙТСОЛЮТ**

(591) Black, white  
 (531) 28.05  
 (511)  
 3 – Cosmetics and cosmetic preparations.

5 – Human pharmaceutical preparations (term considered linguistically incorrect by the International Bureau – rule 13 (2) (b) of the Regulations); dietetic substances adapted for medical use; dietary supplements; medicinal ointments; medicated skin creams; plasters, materials for dressings.

(260) AM 2022 117229 A

(800) 1651932

(151) 2022 02 07

(891) 2022 02 07

(731) Pharm-A-Care (Australia) Pty Ltd  
18 Jubilee Avenue, WARRIEWOOD NSW  
2102, Australia

(540)

## PROMENSIL

(591) Black, white

(511)

5 – Pharmaceutical preparations; preparations derived from plant extracts and herbal extracts; isoflavone containing preparations; phyto-oestrogen supplements.

---

(260) AM 2022 117230 A

(800) 1651934

(151) 2021 12 08

(891) 2021 12 08

(731) Amaxa LTD  
31 John Islip Street, London SW1P 4FE,  
United Kingdom

(540)

## Veragynax

(591) Black, white

(511)

5 – Analgesics; anaesthetics; antibiotics; anti-uric preparations; antiseptics; first-aid boxes, filled; germicides; bacterial preparations for medical and veterinary use; bacteriological preparations for medical and veterinary use; vaginal washes for medical purposes; decoctions for pharmaceutical purposes; vitamin preparations; disinfectants; detergents for medical purposes; diagnostic preparations for medical purposes; dietetic substances adapted for medical use, dietetic foods adapted for medical purposes; calomel [fungicide]; capsules for medicines; medicines for human purposes; personal sexual lubricants; menstruation tampons; antibacterial handwashes; antibacterial soap; disinfectant soap, pharmaceutical preparations; pharmaceuticals; chemico-pharmaceutical preparations; chemical preparations for medical purposes; chemical preparations for pharmaceutical purposes.

---

(260) AM 2022 117240 A

(800) 1652156

(151) 2021 08 11

(891) 2021 08 11

(731) miHoYo Co., Ltd.  
Room 1104-6, Building 1, No. 100, Qinzhou  
Road, Xuhui District, Shanghai, China

(540)

## Genshin Impact

(591) Black, white

(511)

9 – Pedometers; chips [integrated circuits]; USB cables; animated cartoons; downloadable computer application software for mobile phones, namely, software for games; computer game software, downloadable; rulers [measuring instruments]; downloadable emoticons for mobile phones; safety goggles; goggles for sports; cases for smartphones; cameras [photography]; battery chargers; eyeglasses; stands adapted for laptops; mouse pads; portable media players; downloadable image files; downloadable ring tones for mobile phones; electronic sheet music, downloadable; downloadable music files; phonograph records; headphones; coin-operated musical automata [juke boxes]; audio- and video-receivers.

14 – Retractable key chains; brooches [jewellery]; watch bands; presentation boxes for watches; works of art of precious metal; split rings of precious metal for keys; key rings [split rings with trinket or decorative fob]; charms for key rings; chains [jewellery]; jewellery boxes.

16 – Printed publications; printed matter; song books; bookbinding material; architects' models; paper tapes and cards for the recordal of computer programmes; document files [stationery]; photographs (printed); paper; books; calendars; comic books; hygienic paper; ink; gummed tape [stationery]; pens [office requisites]; coasters of paper; advertisement boards of paper or cardboard; paintings [pictures], framed or unframed.

20 – Stuffed animals; containers, not of metal [storage, transport]; slatted indoor blinds; furniture; nesting boxes for household pets; work benches; sleeping pads; mirrors [looking glasses]; identification bracelets, not of metal; nameplates, not of metal.

25 – Sleep masks; scarfs; hats; gloves [clothing]; clothing; girdles; hosiery; waterproof clothing; boots; shoes.

28 – Machines for physical exercises; boxing gloves; swimming pools [play articles]; gym balls for yoga; action figure toys; ornaments for christmas trees, except lights, candles and confectionery; playing cards; playing balls; fishing tackle; arcade video game machines; portable games with liquid crystal displays; apparatus for games; scratch cards for playing lottery; stuffed toys; parlor games; games; toys; toy figures; toy models.

35 – Rental of vending machines; sponsorship search; business auditing; compilation of information into computer databases; marketing; advertising; business management of performing artists; pay per click advertising; online advertising on a computer network.

38 – Rental of message sending apparatus; message sending; transmission of greeting cards online; transmission of digital files; streaming of data; radio broadcasting; transmission of electronic mail; television



broadcasting; video-on-demand transmission; computer aided transmission of messages and images.

41 – Providing online music, not downloadable; providing online electronic publications, not downloadable; songwriting; providing television programmes, not downloadable, via video-on-demand services; production of music; providing information in the field of entertainment; entertainment services; karaoke services; arranging and conducting of concerts; organization of competitions [education or entertainment]; production of radio and television programmes; videotape editing; production of shows; television entertainment; providing recreation facilities; amusement park services; entertainer services; games equipment rental; organization of cosplay entertainment events; game services provided online from a computer network.

42 – Information technology [IT] consultancy; packaging design; providing search engines for the internet; dress designing; website design consultancy; consultancy in the design and development of computer hardware; rental of computer software; maintenance of computer software; computer software design; software as a service [SaaS]; technological research; research and development of new products for others; cloud computing; chemical research; medical research; geological research; interior design; material testing; electronic data storage.

45 – Leasing of internet domain names; dating services; online social networking services; planning and arranging of wedding ceremonies; personal wardrobe styling consultancy; pet sitting; monitoring of burglar and security alarms; evening dress rental; clothing rental; escorting in society [chaperoning].

(260) AM 2022 117322 A

(800) 1652458

(151) 2022 02 15

(891) 2022 02 15

(731) Off-White LLC

360 Hamilton Ave., #100, White Plains NY  
10601, USA

(540)



(591) Black, white

(531) 05.03.04; 05.03.20; 24.15.03; 24.15.11

(511)

25 – Apparel for men and women, namely, jackets, sweatshirts, coats, blazers, suits, pants, jeans, pullovers, sweaters, vests, shorts, shirts, dresses, skirts,

neckwear, shawls; scarves; socks, leggings; stockings; belts, suspenders; braces as suspenders; hats, caps being headwear, gloves, shoes, boots; flip flops, sandals and sneakers.

(260) AM 2022 117323 A

(800) 1652548

(151) 2022 02 11

(891) 2022 02 11

(731) AGF88 HOLDING Srl

Via del Palù 7/D, I-35018 San Martino di  
Lupari (PD), Italy

(540)

## EGOBOND

(591) Black, white

(511)

3 – Hair care lotions; shampoos; hair balsam; tints for the hair; hair care masks; hair dyes; hair lighteners; hair bleaching preparations; hair strengthening treatment lotions; hair preparations and treatments; ethereal oils; soap; face cream; body lotion; anti-wrinkle cream; hand creams; cosmetics; beauty masks.

(260) AM 2022 117324 A

(800) 1652589

(151) 2021 10 06

(891) 2021 10 06

(731) Polymateria Limited

First Floor, 5 Fleet Place, London EC4M 7RD,  
United Kingdom

(540)



(591) Blue

(531) 24.15.01; 24.15.13; 27.05.21; 29.01.04

(511)

1 – Polymer solutions; polymerisation plastics, polymers for industrial use; polymerisates of organic compounds for the plastics industry; biodegradable polymer compositions; additives (chemical and organic) for use in plastic; additives (chemical and organic) for use in the processing of plastic; unprocessed plastic materials.

16 – Plastic wrap; plastic food wrap; plastic bin liners; garbage bags of plastic; plastic shopping bags; general purpose plastic bags; plastic oven cooking bags; plastic materials for packaging; plastic bags for packing and packaging; plastic film for packaging; plastic cling film for palletization; plastic bubble packs for

wrapping or packaging; biodegradable plastic materials for packaging, in particular plastic films, plastic bags, garbage bags, plastic sacks, plastic envelopes, plastic film for wrapping, plastic bubble packs for wrapping or packaging.

17 – Recycled plastics; insulating materials of plastics; stuffing materials of plastics; plastic sheeting for agricultural and horticultural purposes; plastic materials in the form of chips for use as packing; plastics in the form of sheets, films, blocks, rolls and tubes; biodegradable plastic materials for insulation, stuffing, agricultural and horticultural purposes; water hoses for irrigation, biodegradable water hoses for irrigation.

20 – Plastic boxes; plastic crates; plastic stacking trays and boxes; plastic packaging containers; plastic boxes for storage purposes; plastic storage chests; plastic trays and containers used in food packaging; plastic egg trays; plastic closures for containers; plastic storage drums; plastic mailing tubes; plastic medication containers; plastic plant markers; plastic washers; biodegradable plastic boxes, crates, trays and packaging containers; plastic labels.

21 – Plastic household and kitchen utensils and containers; plastic combs and sponges; plastic brushes; plastic articles for cleaning purposes.

(260) AM 2022 117325 A

(800) 1652590

(151) 2021 10 06

(891) 2021 10 06

(731) Polymateria Limited

First Floor, 5 Fleet Place, London EC4M 7RD,  
United Kingdom

(540)



(591) Black, white

(531) 24.15.01; 24.15.13; 27.05.21

(511)

1 – Polymer solutions; polymerisation plastics, polymers for industrial use; polymerisates of organic compounds for the plastics industry; biodegradable polymer compositions; additives (chemical and organic) for use in plastic; additives (chemical and organic) for use in the processing of plastic; unprocessed plastic materials.

16 – Plastic wrap; plastic food wrap; plastic bin liners; garbage bags of plastic; plastic shopping bags; general purpose plastic bags; plastic oven cooking bags;

plastic materials for packaging; plastic bags for packing and packaging; plastic film for packaging; plastic cling film for palletization; plastic bubble packs for wrapping or packaging; biodegradable plastic materials for packaging, in particular plastic films, plastic bags, garbage bags, plastic sacks, plastic envelopes, plastic film for wrapping, plastic bubble packs for wrapping or packaging.

17 – Recycled plastics; insulating materials of plastics; stuffing materials of plastics; plastic sheeting for agricultural and horticultural purposes; plastic materials in the form of chips for use as packing; plastics in the form of sheets, films, blocks, rolls and tubes; biodegradable plastic materials for insulation, stuffing, agricultural and horticultural purposes; water hoses for irrigation, biodegradable water hoses for irrigation.

20 – Plastic boxes; plastic crates; plastic stacking trays and boxes; plastic packaging containers; plastic boxes for storage purposes; plastic storage chests; plastic trays and containers used in food packaging; plastic egg trays; plastic closures for containers; plastic storage drums; plastic mailing tubes; plastic medication containers; plastic plant markers; plastic washers; biodegradable plastic boxes, crates, trays and packaging containers; plastic labels.

21 – Plastic household and kitchen utensils and containers; plastic combs and sponges; plastic brushes; plastic articles for cleaning purposes.

(260) AM 2022 117326 A

(800) 1652599

(151) 2021 11 23

(891) 2021 11 23

(731) STOCK COMPANY "CLOSED NON-DIVERSIFIED VENTURE, CORPORATE INVESTMENT FUND, "ARISTON"  
Zhylianska street, 59, office 102, Kyiv 01033,  
Ukraine

(540)



(591) Black, white

(531) 04.05.21; 05.07.06; 05.09.03; 27.05.24; 28.05

(511)

29 – Peanuts, prepared; nuts, prepared; flavoured nuts; cashews, prepared; roasted cashews; sweet corn, processed; almonds, prepared; roasted almonds; pistachios, prepared; hazelnuts, prepared.

30 – Cereal bars; high-protein cereal bars; muesli bars; muesli bars with added chopped fruits or nuts; crackers; corn, milled; corn, roasted; corn flakes; muesli; chips [cereal products]; popcorn; microwave popcorn.

(260) AM 2022 117338 A

(800) 1653020

(151) 2021 09 10

(891) 2021 09 10

(731) Medicover Holding (Cyprus) Limited  
Eirinis 119, CY-3041 Limassol, Cyprus

(540)



(591) Blue, white

(531) 04.05.03; 26.04.22; 26.04.24; 26.11.12;  
29.01.12

(511)

42 – Biochemistry consultancy; analytical laboratory services; design and development of medical technology; research of pharmaceuticals; conducting clinical trials for pharmaceutical products; toxicity testing for research purposes; biological research; research and development services in the field of bacteriology; services for the development of methods of testing; scientific research relating to bacteriology; scientific investigations for medical purposes; provision of information and data relating to medical and veterinary research and development; biomedical research services; design and development of computer software for use with medical technology; research on the subject of pharmaceuticals; provision of scientific information; development of pharmaceutical preparations and medicines; research and development services in the field of immunology; preparation of immunohistological samples for analysis in research laboratories; design and development of medical diagnostic apparatus; biochemical research and development; product research and development; conducting clinical trials; research and development services in the field of cytology; providing scientific information in the field of medical disorders and their treatment; provision of information relating to scientific research; medical research; laboratory research in the field of gene expression; development of new technology for others; laboratory services relating to the production of monoclonal antibodies; preparation of biological samples for analysis in research laboratories; scientific research in the field of social medicine; scientific research services; research and development services in the field of

immunohistology; genetic research; cell separation research services; bacteriology consultancy; medical laboratories; consultancy relating to research in the field of pharmacogenetics; providing medical and scientific research information in the field of pharmaceuticals and clinical trials; DNA screening for scientific research purposes; medical research laboratory services; consultancy relating to biotechnology; scientific services; stem cell research; testing of pharmaceuticals; research and development services in the field of antibodies; design services; biological research, clinical research and medical research; analysis of human tissues for medical research; medical and pharmacological research services; computer programming in the medical field; research and development in the field of diagnostic preparations; research relating to medicines; scientific research for medical purposes; research in the field of pharmacogenetics; biochemistry research services; consultancy in the field of scientific research; chemical research and analysis; research relating to pharmaceuticals; information technology engineering services in the field of the pharmaceutical and healthcare industries; providing information relating to scientific research in the fields of biochemistry and biotechnology; research of new products for others; medical laboratory services; advisory services relating to gene therapy research; laboratory analysis in the field of bacteriology; research and development in the pharmaceutical and biotechnology fields; research laboratories; research relating to biotechnology; scientific research in the field of genetics and genetic engineering; research in the field of gene therapy; bacteriological research and testing; consultancy relating to research and development in the field of therapeutics; providing information about the results of clinical trials for pharmaceutical products; scientific research; research relating to molecular sciences; scientific research and development; consultancy relating to pharmaceutical research and development; blood analysis services for scientific research purposes; scientific research for medical purposes in the area of cancerous diseases; scientific consultancy.

44 – RNA or DNA analysis for cancer diagnosis and prognosis; pharmacy advisory services; arranging of medical treatment; weight reduction diet planning and supervision; dentistry; medical services, namely, in vitro fertilization; professional consultancy relating to health care; dental consultations; midwife services; providing medical information in the field of geriatrics; medical nursing; veterinary services; reflexology; providing veterinary information; psychological counselling; providing information relating to dietary and nutritional guidance; medical consultations; providing information relating to dentistry; medical care; testing of sera for medical purposes; cholesterol testing for medical purposes; consultancy and information services relating to biopharmaceutical products; dental hygienist services; dietetic counselling services [medical]; medical services relating to the removal,

treatment and processing of stem cells; dental clinic services; medical analysis services for the diagnosis of cancer; telemedicine services; medical services for the treatment of conditions of the human body; providing medical information in the healthcare sector; private hospital services; medical advisory services; preparation of reports relating to medical matters; consultancy and information services relating to pharmaceutical products; performing diagnosis of diseases; nutritional advice; convalescent homes; in vitro fertilization services; consultancy and information services in the field of pharmaceutical products; medical services; medical laboratory services for the analysis of samples taken from patients; psychiatric services; medical analysis services relating to the treatment of patients; hospital services; providing information relating to nursing care services; optician services; postnatal care services for women; nutrition consultancy services relating to slimming; medical screening; health advice and information services; palliative care; professional consultancy relating to diet; services for the provision of medical facilities; medical analysis services relating to the treatment of persons provided by a medical laboratory; medical consultancy services; advisory services relating to diet; rest home services; dietetic advisory services; ambulant medical care; pharmacy services; genetic testing for medical purposes; consultancy in the field of nutrition; human healthcare services; collection and preservation of human blood; consultancy and information services relating to medical products; providing information to patients in the field of administering medications; providing health information relating to breastfeeding; medical treatment services; health care services offered through a network of health care providers on a contract basis; medical testing for diagnostic or treatment purposes; ultrasound services for medical purposes; emergency assistance services in the medical field; advice relating to dentistry; medical services for the diagnosis of conditions of the human body; cord blood bank services; medical analysis services relating to the treatment of persons; dietary guidance; health centre services; healthcare information services; medical services relating to the removal, treatment and processing of human blood; physician services; medical and health services relating to DNA, genetics and genetic testing; nursing, medical; physical rehabilitation; pathology services; opticians' services; provision of pharmaceutical information; blood bank services; medical and healthcare services; medical consultancy for selecting appropriate wheelchairs, commodes, invalid hoists, walking frames and beds; consulting services relating to health care; medical services relating to the removal, treatment and processing of umbilical cord blood; medical laboratory services for the analysis of blood samples taken from patients; DNA screening for medical purposes; medical services relating to the removal, treatment and processing of human cells; psychotherapy

services; medical testing services relating to the diagnosis and treatment of disease; testing of blood for medical purposes; medical examination of individuals; diet planning and supervision; medical treatment services provided by clinics and hospitals; providing information relating to dietary and nutritional supplements; medical clinic services; health consultancy; medical analysis services for cancer diagnosis and prognosis; services for the provision of medical care information; nursing care; provision of medical treatment; conducting of medical examinations; information services relating to contact lenses; medical services in the field of in vitro fertilization; medical diagnostic services; analysis of human tissues for medical treatment; medical health assessment services; medical services relating to the removal, treatment and processing of bone marrow; information relating to blood donation; sports medicine services; trans-telephone heart monitoring services; pharmaceutical advice; preparation of medical reports, other than dentistry; provision of information relating to psychology; medical analysis for the diagnosis and treatment of persons; testing of urine for medical purposes; medical information; holistic psychotherapy; nursing homes.

(260) AM 2022 117345 A

(800) 1653421

(151) 2022 01 04

(891) 2022 01 04

(731) LIMITED LIABILITY COMPANY "ASKONA LIFE GROUP"  
BOULEVARD ZVEZDNIY, building 1, room 19, 2 floor, DOBROGRAD, KOVROVSKY district, RU-601967 Vladimir region, Russian Federation

(540)

**beyosa**  
be yourself

(591) Black, white

(511)

20 – Bumper guards for cots, other than bed linen; sideboards; bolsters; coatstands; divans; kennels for household pets; indoor window blinds; mirrors; mats for infant playpens; cradles; chests of drawers; moses baskets; armchairs; beds; waterbeds, not for medical purposes; bedsteads of wood; air beds, not for medical purposes; cots for babies; edgings of plastic for furniture; playpens for babies; mattresses; air mattresses, not for medical purposes; camping mattresses; sleeping mats; upholstered furniture; furniture of metal; inflatable furniture; office furniture; school furniture; furniture; pillows; cushions; head support cushions for babies; anti-roll cushions for babies; air cushions, not for medical purposes; air pillows, not for medical purposes; head positioning pillows for babies; tables;

steps, not of metal; seats; high chairs for babies; furniture fittings, not of metal; infant walkers; chaise lounges; screens; chests for toys; children's furniture; bedroom furniture; modular furniture; garden furniture; outdoor furniture; cupboards being furniture.

24 – Household linen; bed linen; cot bumpers [bed linen]; sleeping bag liners; baby buntings; furniture coverings of textile; sleeping bags; sleeping bags for babies; pillowcases; mattress covers; bed blankets; blankets for household pets; picnic blankets; travelling rugs; bed covers; bed covers of paper; furniture coverings of plastic; sheets; door curtains; upholstery fabrics; covers for cushions; loose covers for furniture; pillow shams; eiderdowns; drapes; household textiles.

25 – Underwear; sweat-absorbent underwear; hosiery; slips [underclothing]; sleep masks; clothing; pajamas; bath slippers; headwear; tee-shirts; dressing gowns; shower caps; footwear; nightgowns; baby doll pajamas; pajamas for children.

35 – Computerized file management; demonstration of goods; opinion polling; market studies; personnel management consultancy; marketing; providing business information via a website; rental of sales stands; advertising; online advertising on a computer network; administrative processing of purchase orders; procurement services for others [purchasing goods and services for other businesses]; wholesale or retail store services; publicity and sales promotion relating to non-food goods, namely household goods; on-line ordering services.

(260) AM 2022 117347 A

(800) 1653493

(151) 2022 02 15

(891) 2022 02 15

(731) Bolt Technology OÜ

Vana-Lõuna tn 15, Kesklinna linnaosa,  
Tallinn, Estonia

(540)

## Bolt Drive

(591) Black, white

(511)

9 – Downloadable computer software, software applications and databases for use in the field of transportation, transport network and vehicles, including for sale, rental, servicing, parking and recharging of vehicles, mobility, delivery, financial and insurance services; downloadable computer software, software applications and databases for use in the field of transportation, storage and vehicle rental services.

39 – Transport; vehicle rental; car-sharing services; rental of barrows; transport reservation; vehicle parking and storage.

(260) AM 2022 117348 A

(800) 1653514

(151) 2022 02 23

(891) 2022 02 23

(731) Neurocrine Biosciences, Inc.

12780 El Camino Real, San Diego CA 92130,  
USA

(540)

## VYCRINSA

(591) Black, white

(511)

5 – Pharmaceutical preparations for human use; pharmaceutical preparations for the diagnosis, prevention and treatment of psychiatric, neurological, hormonal, genetic and endocrine disorders and conditions; pharmaceutical preparations for human use for diagnosis, prevention and treatment of diseases and disorders by gene therapy; pharmaceuticals for human use for the treatment of rare and orphan diseases, disorders and conditions; pharmaceutical preparations for the treatment of congenital adrenal hyperplasia.

(260) AM 2022 117349 A

(800) 1653535

(151) 2022 02 25

(891) 2022 02 25

(731) Sazerac Brands, LLC

10101 Linn Station Rd., Suite 400, Louisville  
KY 40223, USA

(540)

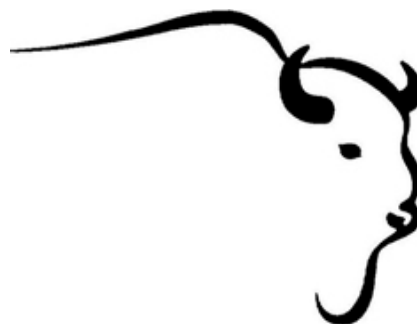

(591) Black, white

(531) 03.04.01; 03.04.04; 03.04.24

(511)

33 – Alcoholic beverages, except beer.

(260) AM 2022 117351 A

(800) 1653576

(151) 2021 11 25

(891) 2021 11 25

(731) Limited Liability Company "SHIKOR"

Osennaya str., 23, fl. 7, room 58, RU-121609  
Moscow, Russian Federation

(540)

## TECHNOSONUS

(591) Black, white

(511)

16 – Fountain pens; watercolors [paintings]; albums; almanacs; document laminators for office use; mimeograph apparatus and machines; atlases; banknotes; banners of paper; paper bows, other than haberdashery or hair decorations; name badges [office requisites]; table linen of paper; tickets; baggage claim check tags of paper; forms, printed; announcement cards [stationery]; glitter for stationery purposes; note books; pads [stationery]; drawing pads; wristbands for the retention of writing instruments; pamphlets; booklets; paper; paper sheets [stationery]; waxed paper; paper for medical examination tables; paper for recording machines; paper for radiograms; papers for painting and calligraphy; electrocardiograph paper; wood pulp paper; carbon paper; copying paper [stationery]; parchment paper; writing paper; rice paper; luminous paper; toilet paper; wrapping paper; filter paper; blotters; newsletters; rollers for typewriters; house painters' rollers; composing sticks; modelling wax, not for dental purposes; signboards of paper or cardboard; sewing patterns; bunting of paper; newspapers; electrotypes; hectographs; modelling clay; polymer modelling clay; terrestrial globes; drawing sets; engravings; slate pencils; pencil leads; document holders [stationery]; pencil holders; chalk holders; holders for cheque books; holders for stamps [seals]; page holders; name badge holders [office requisites]; diagrams; table runners of paper; engraving plates; writing slates; blackboards; galley racks [printing]; drawing boards; advertisement boards of paper or cardboard; duplicators; punches [office requisites]; cream containers of paper; magazines [periodicals]; money clips; clips for name badge holders [office requisites]; tags for index cards; pen clips; bookmarks; etching needles; tracing needles for drawing purposes; periodicals; printed publications; paper shredders for office use; graphic representations; credit card imprinters, non-electric; graining combs; drawing instruments; calendars; tracing paper; tracing cloth; tracing patterns; gums [adhesives] for stationery or household purposes; lithographic stones; ink stones [ink reservoirs]; pencils; pencil lead holders; charcoal pencils; pictures; transfers [decalcomanias]; paintings [pictures], framed or unframed; cardboard; wood pulp board [stationery]; hat boxes of cardboard; cards; index cards [stationery]; geographical maps; paper tapes and cards for the recordal of computer programmes; trading cards, other than for games; perforated cards for Jacquard looms; catalogues; spools for inking ribbons; flower-pot covers of paper; paintbrushes; painters' brushes; writing brushes; typewriter keys; glue for stationery or household purposes; isinglass for stationery or household purposes; gluten [glue] for stationery or household purposes; starch paste [adhesive] for stationery or household purposes; printing blocks; books; manifolds [stationery]; comic books; drawing pins; cigar bands; envelopes [stationery]; boxes of paper or cardboard; cases for stamps [seals]; paint boxes for use in

schools; correcting fluids [office requisites]; printed coupons; stencils [stationery]; French curves; paper ribbons, other than haberdashery or hair decorations; typewriter ribbons; barcode ribbons; gummed tape [stationery]; adhesive bands for stationery or household purposes; correcting tapes [office requisites]; inking ribbons; adhesive tapes for stationery or household purposes; self-adhesive tapes for stationery or household purposes; square rulers for drawing; drawing rulers; flyers; absorbent sheets of paper or plastic for foodstuff packaging; humidity control sheets of paper or plastic for foodstuff packaging; viscose sheets for wrapping; sheets of reclaimed cellulose for wrapping; plastic bubble packs for wrapping or packaging; steel letters; type [numerals and letters]; lithographs; paint trays; architects' models; postage stamps; plastics for modelling; graphic prints; modelling materials; teaching materials [except apparatus]; sealing compounds for stationery purposes; adhesives [glues] for stationery or household purposes; padding materials of paper or cardboard; bookbinding material; packing [cushioning, stuffing] materials of paper or cardboard; filtering materials of paper; addressing machines; pencil sharpening machines, electric or non-electric; bookbinding apparatus and machines [office equipment]; typewriters, electric or non-electric; paper creasers [office requisites]; franking machines for office use; chalk for lithography; writing chalk; tailors' chalk; marking chalk; spray chalk; bags [envelopes, pouches] of paper or plastics, for packaging; garbage bags of paper or of plastics; plastic bags for pet waste disposal; painters' easels; hand-rests for painters; printing sets, portable [office requisites]; bibs of paper; bibs, sleeved, of paper; stickers [stationery]; fingerstalls for office use; writing cases [stationery]; cords for bookbinding; paper knives [letter openers]; printed sheet music; numbering apparatus; bottle envelopes of paper or cardboard; sealing wafers; covers [stationery]; passport holders; plastic cling film, extensible, for palletization; embroidery designs [patterns]; handwriting specimens for copying; oleographs; musical greeting cards; greeting cards; postcards; etchings; conical paper bags; paper bags for use in the sterilization of medical instruments; bags for microwave cooking; palettes for painters; ink sticks; pantographs [drawing instruments]; loose-leaf binders; papier mâché; pastels [crayons]; modelling paste; pen cases; pen wipers; office perforators; pens [office requisites]; nibs of gold; nibs; steel pens; drawing pens; song books; seals [stamps]; sealing stamps; clipboards; address plates for addressing machines; handkerchiefs of paper; plastic film for wrapping; trays for sorting and counting money; coasters of paper; bookends; stamp stands; mats for beer glasses; stands for pens and pencils; photograph stands; obliterating stamps; inking pads; stamp pads; binding strips [bookbinding]; towels of paper; inking sheets for document reproducing machines; inking sheets for duplicators; cloth for bookbinding; gummed

cloth for stationery purposes; printers' blankets, not of textile; portraits; paperweights; writing cases [sets]; inkstands; office requisites, except furniture; writing materials; writing instruments; drawing materials; school supplies [stationery]; adhesive tape dispensers [office requisites]; hand labelling appliances; printed matter; lithographic works of art; prospectuses; printed timetables; ledgers [books]; printers' galleys; indexes; paper cutters [office requisites]; rubber erasers; elastic bands for offices; T-squares for drawing; graphic reproductions; retractable reels for name badge holders [office requisites]; penholders; marking pens [stationery]; tissues of paper for removing make-up; paper wipes for cleaning; dental tray covers of paper; face towels of paper; place mats of paper; tablemats of paper; tablecloths of paper; paper clasps; document files [stationery]; scrapers [erasers] for offices; paper-clips; clips for offices; erasing products; biological samples for use in microscopy [teaching materials]; histological sections for teaching purposes; steatite [tailor's chalk]; writing board erasers; composing frames [printing]; sealing wax; arithmetical tables; placards of paper or cardboard; writing or drawing books; fabrics for bookbinding; stationery; pencil sharpeners, electric or non-electric; transparencies [stationery]; stencil plates; stencils for decorating food and beverages; cardboard tubes; Indian inks; moisteners [office requisites]; moisteners for gummed surfaces [office requisites]; squares for drawing; chart pointers, non-electronic; bottle wrappers of paper or cardboard; envelope sealing machines for offices; sealing machines for offices; vignetting apparatus; apparatus for mounting photographs; stapling presses [office requisites]; manuals [handbooks]; paper coffee filters; flags of paper; silver paper; moulds for modelling clays [artists' materials]; photo-engravings; photographs [printed]; stencil cases; canvas for painting; chromolithographs [chromos]; animation cels; compasses for drawing; numbers [type]; artists' watercolour saucers; ink; correcting ink [heliography]; inkwells; blueprints; stencils; erasing shields; balls for ball-point pens; desktop cabinets for stationery [office requisites]; printing type; address stamps; stamps [seals]; shields [paper seals]; prints [engravings]; labels of paper or cardboard; posters; drawer liners of paper, perfumed or not; Japanese paper; letter trays; starch-based packaging material; table place setting mats of paper; files [office requisites]; folder covers for documents; desk mats; figurines of papier mâché.

17 – Shock-absorbing buffers of rubber; fittings, not of metal, for compressed air lines; asbestos; cellulose acetate, semi-processed; balata; floating anti-pollution barriers; asbestos paper; paper for electrical capacitors; insulating paper; cotton wool for packing [caulking]; mineral wool [insulator]; asbestos felt; insulating felt; asbestos fibres; plastic fibres, other than for textile use; carbon fibres, other than for textile use; vulcanized fibre; gutta-percha; foam supports for flower arrangements [semi-finished products]; dielectrics

[insulators]; lute; insulators; insulators for railway tracks; insulators for electric mains; insulators for cables; asbestos millboards; liquid rubber; synthetic rubber; rubber, raw or semi-worked; valves of india-rubber or vulcanized fibre; clack valves of rubber; rings of rubber; water-tight rings; insulating paints; insulating varnish; latex [rubber]; duct tapes; insulating bands; adhesive bands, other than stationery and not for medical or household purposes; self-adhesive tapes, other than stationery and not for medical or household purposes; asbestos sheets; viscose sheets, other than for wrapping; foil of regenerated cellulose, other than for wrapping; insulating oils; insulating oil for transformers; reinforcing materials, not of metal, for pipes; weatherstripping compositions; caulking materials; brake lining materials, partly processed; soundproofing materials; insulating materials; insulating refractory materials; padding materials of rubber or plastics; rubber material for recapping tyres; non-conducting materials for retaining heat; boiler composition to prevent the radiation of heat; packing [cushioning, stuffing] materials of rubber or plastics; sealant compounds for joints; filtering materials of semi-processed foams of plastic; filtering materials of semi-processed films of plastic; compositions to prevent the radiation of heat; bags [envelopes, pouches] of rubber, for packaging; pipe mufflers, not of metal; rubber sleeves for protecting parts of machines; asbestos packing; clutch linings; threads of plastic for soldering; plastic filaments for 3D printing; threads of rubber, other than for textile use; elastic yarns, other than for textile use; door stops of rubber; window stops of rubber; stops of rubber; dock bumpers of rubber; insulating gloves; plastic sheeting for agricultural purposes; plastic film, other than for wrapping; anti-glare films for windows [tinted films]; asbestos coverings; bark coverings for sound insulation; asbestos cloth; rubber stoppers; gaskets; expansion joint fillers; cylinder jointings; washers of rubber or vulcanized fibre; pipe gaskets; draught excluder strips; rubber solutions; gum, raw or semi-worked; mica, raw or partly processed; acrylic resins, semi-processed; synthetic resins, semi-processed; pipe couplings, not of metal; substances for insulating buildings against moisture; chemical compositions for repairing leaks; glass wool for insulation; fibreglass for insulation; asbestos fabrics; fibreglass fabrics for insulation; insulating fabrics; flexible hoses, not of metal; hoses of textile material; connecting hose for vehicle radiators; waterproof pacings; rubber seals for jars; fittings, not of metal, for flexible pipes; fittings, not of metal, for rigid pipes; foils of metal for insulating; ebonite moulds; asbestos slate; slag wool [insulator]; watering hose; canvas hose pipes; cords of rubber; asbestos safety curtains; insulating plaster; ebonite; threads of plastic materials, other than for textile use; plastic substances, semi-processed.

19 – Aquaria [structures]; alabaster; door frames, not of metal; asbestos cement; asphalt; beams, not of



metal; balustrades, not of metal; huts; swimming pools [structures], not of metal; silos, not of metal; harbours [structures], not of metal; concrete; bitumen; plastic landscape edgings; joists, not of metal; telephone booths, not of metal; beacons, not of metal, non-luminous; building paper; busts of stone, concrete or marble; bird baths [structures], not of metal; binding agents for making briquettes; binding material for road repair; stained-glass windows; felt for building; aviaries [structures], not of metal; gates, not of metal; diving boards, not of metal; geotextiles; gypsum [building material]; plaster; clay; potters' clay; earth for bricks; gravel; aquarium gravel; granite; armoured doors, not of metal; doors, not of metal; swing doors, not of metal; folding doors, not of metal; coal tar; chimney pots, not of metal; prefabricated houses [kits], not of metal; parquet floor boards; memorial plaques, not of metal; roofing shingles; wood for making household utensils; veneer wood; mouldable wood; chimney shafts, not of metal; outdoor blinds, not of metal and not of textile; жалюзи, not of metal; roof gutters, not of metal; street gutters, not of metal; agglomerated bagasses of cane [building material]; road signs, non-luminous and non-mechanical, not of metal; non-luminous and non-mechanical signs, not of metal; limestone; lime; fences, not of metal; works of stonemasonry; works of art of stone, concrete or marble; cabanas, not of metal; soundproof booths, transportable, not of metal; stone; rubble; artificial stone; building stone; paint spraying booths, not of metal; gravestones; reeds for building; greenhouse frames, not of metal; framework, not of metal, for building; cornices, not of metal; bitumen paper for building; wood pulp board for building; paperboard for building; skating rinks [structures], not of metal; quartz; caissons for construction work under water; bricks; firebricks; water-pipe valves, not of metal or plastic; drain traps [valves], not of metal or plastic; cask wood; mooring bollards, not of metal; pillars, not of metal, for building; cement posts; chimney cowls, not of metal; buildings, not of metal; buildings, transportable, not of metal; stringers [parts of staircases], not of metal; silica [quartz]; roofing, not of metal; roofing, not of metal, incorporating photovoltaic cells; manhole covers, not of metal; xylolith; chicken-houses, not of metal; manufactured timber; sawn timber; staircases, not of metal; road marking sheets and strips of synthetic material; reinforcing materials, not of metal, for building; bituminous products for building; tar; road coating materials; materials for making and coating roads; fireclay; pitch; building materials, not of metal; refractory construction materials, not of metal; masts [poles], not of metal; raw chalk; calcareous marl; mosaics for building; mouldings, not of metal, for cornices; mouldings, not of metal, for building; marble; slate powder; porches [structures], not of metal; tombs, not of metal; flashing, not of metal, for building; roof flashing, not of metal; perches; duckboards, not of metal; wall claddings, not of metal, for building;

ding; coatings [building materials]; tomb or grave enclosures, not of metal; laths, not of metal; wood panelling; wall linings, not of metal, for building; palings, not of metal; crash barriers, not of metal, for roads; latticework, not of metal; windows, not of metal; olivine for building; shuttering, not of metal, for concrete; posts, not of metal, for power lines; props, not of metal; rubber bearings for seismic isolation of buildings; branching pipes, not of metal; fair huts; tombs [monuments], not of metal; monuments, not of metal; acoustic panels, not of metal; wainscoting, not of metal; signalling panels, non-luminous and non-mechanical, not of metal; building panels, not of metal; parquet flooring; partitions, not of metal; lintels, not of metal; casement windows, not of metal; aquarium sand; silver sand; sand, except foundry sand; sandstone for building; tarred strips for building; planks of wood for building; rocket launching platforms, not of metal; platforms, prefabricated, not of metal; floor tiles, not of metal; tiles, not of metal, for building; paving slabs, not of metal; cement slabs; grave slabs, not of metal; scaffolding, not of metal; armour-plating, not of metal; asphalt paving; wood paving; paving blocks, not of metal; luminous paving blocks; macadam; fireproof cement coatings; bituminous coatings for roofing; roof coverings, not of metal; wooden floor boards; cladding, not of metal, for building; linings, not of metal, for building; fireplace mantles, not of metal; door panels, not of metal; floors, not of metal; sills, not of metal; porphyry [stone]; ceilings, not of metal; agglomerated cork for building; window frames, not of metal; mortar for building; asbestos mortar; tanks of masonry; scantlings [carpentry]; furrings of wood; vinyl siding; pilings, not of metal; insect screens, not of metal; burial vaults, not of metal; schists; shutters, not of metal; statues of stone, concrete or marble; alabaster glass; safety glass; glass granules for road marking; window glass for building; window glass, other than vehicle window glass; building glass; plate glass [windows] for building; insulating glass for building; enamelled glass, for building; tombstone stelae, not of metal; non-metal stables; advertisement columns, not of metal; posts, not of metal; telegraph posts, not of metal; hips for roofing; stair-treads [steps], not of metal; tombstone plaques, not of metal; greenhouses, transportable, not of metal; terracotta [building material]; penstock pipes, not of metal; water-pipes, not of metal; gutter pipes, not of metal; ducts, not of metal, for ventilating and air-conditioning installations; drain pipes, not of metal; chimneys, not of metal; rigid pipes, not of metal, for building; sandstone pipes; turnstiles, not of metal; tufa; angle irons, not of metal; lengthening pieces, not of metal, for chimneys; bicycle parking installations, not of metal; plywood; flagpoles [structures], not of metal; foundry moulds, not of metal; rock crystal; cement for blast furnaces; cement for furnaces; magnesia cement; cement; pantiles, not of metal; roofing tiles, not of metal; slate; roofing slates; slag [building material];



slag stone; railway sleepers, not of metal; wood veneers; clinker ballast; concrete building elements; accordion doors, not of metal; brackets, not of metal, for building; building timber; wood, semi-worked; wall tiles, not of metal; tile floorings, not of metal; slabs, not of metal, for building; floating docks, not of metal, for mooring boats; pigsties, not of metal; figurines of stone, concrete or marble; letter boxes of masonry.

35 – Arranging subscriptions to telecommunication services for others; import-export agency services; commercial information agency services; advertising agency services; cost price analysis; rental of office equipment in co-working facilities; rental of advertising space; business auditing; financial auditing; business intermediary services relating to the matching of potential private investors with entrepreneurs needing funding; employment agency services; computerized file management; book-keeping; invoicing; demonstration of goods; transcription of communications [office functions]; opinion polling; market studies; business investigations; business research; marketing research; personnel recruitment; business management and organization consultancy; business organization consultancy; business management consultancy; personnel management consultancy; professional business consultancy; consultancy regarding advertising communication strategies; consultancy regarding public relations communication strategies; layout services for advertising purposes; marketing; marketing in the framework of software publishing; targeted marketing; business management of performing artists; business management of sports people; writing of curriculum vitae for others; scriptwriting for advertising purposes; news clipping services; updating and maintenance of information in registries; updating and maintenance of data in computer databases; updating of advertising material; word processing; online retail services for downloadable and pre-recorded music and movies; online retail services for downloadable ring tones; online retail services for downloadable digital music; organization of exhibitions for commercial or advertising purposes; arranging newspaper subscriptions for others; organization of fashion shows for promotional purposes; organization of trade fairs; shop window dressing; business appraisals; payroll preparation; data search in computer files for others; sponsorship search; administrative assistance in responding to calls for tenders; business management assistance; commercial or industrial management assistance; commercial intermediation services; providing business information; providing business information via a website; providing commercial and business contact information; providing commercial information and advice for consumers in the choice of products and services; providing user reviews for commercial or advertising purposes; web indexing for commercial or advertising purposes; providing user rankings for commercial or advertising purposes; economic forecasting; auctioneering; retail services for

works of art provided by art galleries; sales promotion for others; promotion of goods and services through sponsorship of sports events; production of teleshopping programmes; production of advertising films; office machines and equipment rental; rental of advertising time on communication media; publicity material rental; rental of billboards [advertising boards]; rental of vending machines; rental of sales stands; rental of photocopying machines; consumer profiling for commercial or marketing purposes; publication of publicity texts; radio advertising; development of advertising concepts; bill-posting; distribution of samples; dissemination of advertising matter; direct mail advertising; registration of written communications and data; writing of publicity texts; advertising; online advertising on a computer network; advertising by mail order; television advertising; compilation of statistics; compilation of information into computer databases; business inquiries; systemization of information into computer databases; administrative services for medical referrals; advisory services for business management; corporate communications services; negotiation of business contracts for others; negotiation and conclusion of commercial transactions for third parties; compiling indexes of information for commercial or advertising purposes; tax preparation; drawing up of statements of accounts; telemarketing services; psychological testing for the selection of personnel; interim business management; business management of hotels; business management for freelance service providers; business project management services for construction projects; commercial administration of the licensing of the goods and services of others; business management of reimbursement programmes for others; administration of consumer loyalty programs; administration of frequent flyer programs; administrative processing of purchase orders; pay per click advertising; administrative services for the relocation of businesses; public relations; commercial lobbying services; competitive intelligence services; modelling for advertising or sales promotion; typing; market intelligence services; appointment reminder services [office functions]; website traffic optimization; tax filing services; search engine optimization for sales promotion; retail services relating to bakery products; gift registry services; price comparison services; secretarial services; procurement services for others [purchasing goods and services for other businesses]; shorthand; outsourcing services [business assistance]; telephone answering for unavailable subscribers; telephone switchboard services; photocopying services; business efficiency expert services; retail services; retail services provided by television stores or via Web sites; provision of an online marketplace for buyers and sellers of goods and services; presentation of goods on communication media, for retail purposes; media relations services; retail or wholesale services for pharmaceutical, veterinary and sanitary preparations and medical supplies; outsour-

ced administrative management for companies; appointment scheduling services [office functions]; wholesale or retail services; wholesale or retail store services; retail services provided by means of mail order catalogs.

42 – Water analysis; computer system analysis; handwriting analysis [graphology]; chemical analysis; rental of meters for the recording of energy consumption; energy auditing; recovery of computer data; business card design; graphic design of promotional materials; industrial design; graphic arts design; computer virus protection services; oil-field surveys; geological surveys; engineering; installation of computer software; meteorological information; clinical trials; material testing; textile testing; bacteriological research; biological research; geological research; research in the field of environmental protection; cosmetic research; mechanical research; research in the field of welding; research in the field of building construction; research in the field of telecommunications technology; research in the field of physics; chemical research; research and development of new products for others; medical research; scientific and technological research relating to patent mapping; scientific and technological research in the field of natural disasters; scientific research; analysis for oil-field exploitation; underwater exploration; technological research; calibration [measuring]; website design consultancy; computer security consultancy; information technology [IT] consultancy; computer technology consultancy; consultancy in the design and development of computer hardware; architectural consultancy; internet security consultancy; computer software consultancy; data security consultancy; technological consultancy; oil-well testing; quality control; vehicle roadworthiness testing; land surveying; dress designing; updating of computer software; monitoring of computer systems to detect breakdowns; monitoring of computer systems for detecting unauthorized access or data breach; monitoring of computer systems by remote access; software as a service [SaaS]; maintenance of computer software; authenticating works of art; design of interior decor; quality evaluation of standing timber; quality evaluation of wool; digitization of documents [scanning]; conversion of data or documents from physical to electronic media; urban planning; providing information relating to computer technology and programming via a website; providing search engines for the internet; platform as a service [PaaS]; conversion of computer programs and data, other than physical conversion; conducting technical project studies; computer system design; rental of web servers; computer rental; rental of computer software; unlocking of mobile phones; geological prospecting; oil prospecting; hosting computer sites [web sites]; server hosting; development of computer platforms; construction drafting; computer software design; software development in the framework of software publishing; cloud seeding; consultancy in the field of energy-sa-

ving; creating and designing website-based indexes of information for others [information technology services]; creating and maintaining websites for others; computer programming; technical writing; copying of computer programs; cloud computing; architectural services; information technology services provided on an outsourcing basis; chemistry services; packaging design; off-site data backup; telecommunications technology consultancy; scientific laboratory services; user authentication services using single sign-on technology for online software applications; user authentication services using technology for e-commerce transactions; weather forecasting; styling [industrial design]; cartography services; exploration services in the field of the oil, gas and mining industries; data encryption services; electronic data storage; surveying; electronic monitoring of credit card activity to detect fraud via the internet; electronic monitoring of personally identifying information to detect identity theft via the internet; interior design; providing scientific information, advice and consultancy relating to carbon offsetting.

(260) AM 2022 117367 A

(800) 1620433

(151) 2021 07 16

(891) 2022 03 16

(731) RTS, S.A.

Polígono Industrial Erramone, E-20850

Mendaro (Gipuzkoa), Spain

(540)



(591) Blue Pantone 301 C

(531) 26.01.18; 26.01.24; 27.05.19; 27.05.24;  
29.01.12

(511)

12 – Steering rods for vehicles, steering assemblies for vehicles, steering ball joints for vehicles and axle ball joints for vehicles; suspension ball joints for vehicles, suspension arms for vehicles; suspension trapezes for vehicles; stabilizer rods and silent blocks as part of suspension systems for vehicles; vehicle suspension and steering products, suspension arms, steering columns, steering racks, axles for suspension systems, suspension springs, springs for suspension systems, wheel suspension, axles for pneumatic suspension systems of vehicles, torsion/sway bars (vehicle suspension parts), suspensions, suspension arms, all relating to vehicles; Pitman arms and stabilizer bar mounts; vehicles; apparatus for locomotion by land, air or water.

(260) AM 2022 117376 A  
 (800) 1653884  
 (151) 2022 02 02  
 (891) 2022 02 02  
 (731) Avon Products, Inc.  
 1 Avon Place, Suffern NY 10901, USA  
 (540)

AVON  
 LOV | U

(591) Black, white  
 (531) 26.11.01; 27.05.01  
 (511)  
 3 – Perfumes; fragrances; toilet waters; cologne; room fragrances; incense sticks; essential oils (cosmetic); oils for perfumes and scents; potpourri.

(260) AM 2022 117378 A  
 (800) 1654040  
 (151) 2022 02 08  
 (891) 2022 02 08  
 (731) Obshchestvo s ogranichennoy otvetstvennostyu "EVRA"  
 Solnechnogorskaya ul., 4, str. 6, RU-125413  
 Moscow, Russian Federation  
 (540)

ЗАБАВНЫЙ  
 СЮРПРИЗ

(591) Black, white  
 (531) 28.05  
 (511)  
 30 – Cocoa products; confectionery.

(260) AM 2022 117379 A  
 (800) 1654042  
 (151) 2022 02 18  
 (891) 2022 02 18  
 (731) Limited Liability Company "SportRadar"  
 ulitsa Azovskaya, dom 6, korpus 3,  
 etazh/pomeshch 2/204, RU-117149 Moscow,  
 Russian Federation  
 (540)



(591) Green and white

(531) 27.05.19; 29.01.13  
 (511)  
 41 – Gambling services.

(260) AM 2022 117381 A  
 (800) 1654163  
 (151) 2021 10 13  
 (891) 2021 10 13  
 (731) Fellowship of Christian Athletes  
 8701 LEEDS ROAD, KANSAS CITY MO  
 64129, USA  
 (540)

FCA

(591) Black, white  
 (511)  
 41 – Sports camp services, namely, operation of sports and religious camps (term considered too vague by the International Bureau – Rule 13 (2) (b) of the Regulations); educational services, namely, conducting training workshops and seminars in the field of sports and religion; entertainment in the nature of an on-going podcasts; publication of electronic magazines featuring athletics and religion.

45 – Providing christian evangelistic and ministerial services directed towards athletes and coaches.

(260) AM 2022 117382 A  
 (800) 1654236  
 (151) 2021 10 06  
 (891) 2021 10 06  
 (731) Polymateria Limited  
 First Floor, 5 Fleet Place, London EC4M 7RD,  
 United Kingdom  
 (540)

lyfecycle

 The logo for lyfecycle consists of a circular icon on the left containing a stylized lowercase 'y' with a curved arrow pointing upwards and to the right. To the right of the icon, the word 'lyfecycle' is written in a lowercase, rounded, sans-serif font.

(591) Black, white  
 (531) 24.15.01; 24.15.13; 24.15.17; 26.01.03;  
 26.01.18; 27.05.01

(511)  
 1 – Polymer solutions; polymerisation plastics, polymers for industrial use; polymerisates of organic compounds for the plastics industry; biodegradable polymer compositions; additives (chemical and organic) for use in plastic; additives (chemical and organic) for use in the processing of plastic; unprocessed plastic materials.

16 – Plastic wrap; plastic food wrap; plastic bin liners; garbage bags of plastic; plastic shopping bags; general purpose plastic bags; plastic oven cooking bags; plastic materials for packaging; plastic bags for packing and packaging; plastic film for packaging; plastic cling film for palletization; plastic bubble packs for

wrapping or packaging; biodegradable plastic materials for packaging, in particular plastic films, plastic bags, garbage bags, plastic sacks, plastic envelopes, plastic film for wrapping, plastic bubble packs for wrapping or packaging.

17 – Recycled plastics; insulating materials of plastics; stuffing materials of plastics; plastic sheeting for agricultural and horticultural purposes; plastic materials in the form of chips for use as packing; plastics in the form of sheets, films, blocks, rolls and tubes; biodegradable plastic materials for insulation, stuffing, agricultural and horticultural purposes; water hoses for irrigation, biodegradable water hoses for irrigation.

20 – Plastic boxes; plastic crates; plastic stacking trays and boxes; plastic packaging containers; plastic boxes for storage purposes; plastic storage chests; plastic trays and containers used in food packaging; plastic egg trays; plastic closures for containers; plastic storage drums; plastic road cones; plastic mailing tubes; plastic medication containers; plastic plant markers; plastic washers; biodegradable plastic boxes, crates, trays and packaging containers; plastic labels.

21 – Plastic household and kitchen utensils and containers; plastic combs and sponges; plastic brushes; plastic articles for cleaning purposes.

(260) AM 2022 117383 A  
(800) 1654265  
(151) 2022 01 25  
(891) 2022 01 25  
(731) WW Equity House Trading Limited  
Equity House, Deerpark Business Complex,  
Dublin Road, Carlow R93 K7W4, Ireland  
(540)

## Writers Tears

(591) Black, white  
(511)  
33 – Alcoholic beverages (except beers).

(260) AM 2022 117385 A  
(800) 1654352  
(151) 2022 03 08  
(891) 2022 03 08  
(731) Apple Inc.  
One Apple Park Way, Cupertino CA 95014,  
USA  
(540)

## APPLE STUDIO DISPLAY

(591) Black, white  
(526) DISPLAY  
(511)  
9 – Computer monitors.

(260) AM 2022 117386 A  
(800) 1654384  
(151) 2021 10 05  
(891) 2021 10 05  
(731) BESTWAY INFLATABLES & MATERIAL  
CORP.  
No. 208 Jinyuanwu Road, 201812 Shanghai,  
China

(540)



(591) Black, white  
(531) 27.05.02  
(511)

6 – Wash down spray nozzles of metal for commercial and industrial use; props of metal in the nature of horizontal and vertical tube connectors; ladders of metal; metal swimming pools.

7 – Pumps for counter-current swimming; compressed air pumps; vacuum pumps; pumps for machines; valves as machine components; central vacuum cleaning installations; compressed air machine components, namely, valves; machines and apparatus for cleaning pools, electric, namely, automatic swimming pool vacuums, automatic swimming pool cleaners.

8 – Air pumps, hand-operated.

11 – Swimming pool water filtering machines; cleaning machine for pools, namely, water cleaning and filtering units (terms too vague in the opinion of the International Bureau – Rule 13 (2) (b) of the Regulations); pool water filtering machines; spas in the nature of heated pools; bath tubs; hydromassage bath apparatus; water filtering apparatus; swimming pool chlorinating apparatus; disinfectant dispensers for swimming pools and bath tubs.

12 – Boats; oars; air cushion vehicles; launches; canoes.

19 – Props, not of metal, in the nature of frames for supporting swimming pools; non-metal swimming pools; stair treads not of metal.

20 – Inflatable furniture; mattresses; inflatable sofas; air beds, not for medical purposes; air pillows, not for medical purposes; air cushions, not for medical purposes; air mattresses, not for medical purposes; chairs; inflatable publicity objects; sleeping pads, sleeping mats; non-metal and non-paper floating containers for storage; poles, not of metal.

22 – Awnings of synthetic materials.

28 – Play balloons; swimming pool air floats; parlour games, parlor games; surfboards; surf skis; climbers' harness; bags especially designed for skis and surfboards; mast for sailboards; inflatable swimming po-

ols; flippers for swimming; swimming belts; swimming jackets; paddleboards; inflatable pools for recreational use; inflatable bouncers in the nature of inflatable toys and structures for recreational use; swimming rings; water slides; inflatable water and playground slides; inflatable ride-on toys; inflatable floating beds in the nature of mattress and floats for swimming pool; darts; dart games; specially adapted for use with inflatables and recreational equipment, namely, air floats (terms too vague in the opinion of the International Bureau – Rule 13 (2) (b) of the Regulations).

(260) AM 2022 117473 A  
 (800) 1655549  
 (151) 2022 03 03  
 (891) 2022 03 03  
 (731) Salesforce, Inc.  
 Salesforce Tower, 415 Mission Street,  
 3rd Floor, San Francisco CA 94105, USA  
 (540)

## TABLEAU

(591) Black, white  
 (511)  
 9 – Computer software for data mining, data query, and data analysis.  
 41 – Educational services, namely, conducting seminars, conferences, workshops, and computer application training in the fields of data mining, data query, and data analysis.  
 42 – Providing temporary use of on-line non-downloadable software for data mining, data query, and data analysis.

(260) AM 2022 117474 A  
 (800) 1655560  
 (151) 2022 03 04  
 (891) 2022 03 04  
 (731) HANKOOK & COMPANY CO., LTD.  
 286, Pangyo-ro, Bundang-gu, Seongnam-si,  
 Gyeonggi-do, Republic of Korea  
 (540)

(591) Black, white  
 (531) 03.07.16; 03.07.17; 18.01.21; 26.13.25;  
 27.03.11; 27.05.07  
 (511)  
 37 – Repair of tire tubes; motor vehicle maintenance and repair; retreading of tires; regrooving of tires; washing of motor vehicles; vehicle service stations [refuelling and maintenance]; vehicle noise prevention works; vehicle polishing; anti-rust treatment for

vehicles; cleaning of vehicles; advisory services relating to maintenance of motor vehicle.

(260) AM 2022 117475 A  
 (800) 1655611  
 (151) 2021 06 09  
 (891) 2021 06 09  
 (731) Individual'nyj predprinimatel' Malik Andrej  
 Vladimirovich  
 Ul. 2-ja linija Krasnoarmejskoj slobody, 40, kv.  
 12, RU-214000 g. Smolensk, Russian  
 Federation  
 (540)



(591) Black, white  
 (531) 27.05.01; 27.05.24  
 (511)  
 16 – Fountain pens; albums; almanacs; document laminators for office use; mimeograph apparatus and machines; atlases; banknotes; banners of paper; paper bows, other than haberdashery or hair decorations; name badges [office requisites]; table linen of paper; tickets; baggage claim check tags of paper; forms, printed; announcement cards [stationery]; glitter for stationery purposes; note books; pads [stationery]; drawing pads; wristbands for the retention of writing instruments; pamphlets; booklets; paper; paper sheets [stationery]; waxed paper; paper for medical examination tables; paper for recording machines; paper for radiograms; papers for painting and calligraphy; electrocardiograph paper; drawer liners of paper, perfumed or not; wood pulp paper; carbon paper; copying paper [stationery]; parchment paper; writing paper; rice paper; luminous paper; toilet paper; wrapping paper; filter paper; blotters; newsletters; rollers for typewriters; house painters' rollers; composing sticks; modelling wax, not for dental purposes; signboards of paper or cardboard; sewing patterns; bunting of paper; newspapers; electrotypes; hectographs; modelling clay; polymer modelling clay; terrestrial globes; drawing sets; engravings; slate pencils; pencil leads; document holders [stationery]; pencil holders; chalk holders; holders for cheque books; holders for stamps [seals]; page holders; name badge holders [office requisites]; diagrams; table runners of paper; engraving plates; writing slates; blackboards; galley racks [printing]; drawing boards; advertisement boards of paper or cardboard; duplicators; punches [office requisites]; cream containers of paper; magazines [periodicals]; money clips; clips for name badge holders [office re-

quisites]; tags for index cards; pen clips; bookmarks; etching needles; tracing needles for drawing purposes; periodicals; printed publications; paper shredders for office use; graphic representations; credit card imprints, non-electric; graining combs; drawing instruments; calendars; tracing paper; tracing cloth; tracing patterns; gums [adhesives] for stationery or household purposes; lithographic stones; ink stones [ink reservoirs]; pencils; pencil lead holders; charcoal pencils; pictures; transfers [decalcomanias]; paintings [pictures], framed or unframed; cardboard; wood pulp board [stationery]; hat boxes of cardboard; cards; index cards [stationery]; geographical maps; paper tapes and cards for the recordal of computer programmes; trading cards, other than for games; perforated cards for Jacquard looms; catalogues; spools for inking ribbons; flower-pot covers of paper; paintbrushes; painters' brushes; writing brushes; typewriter keys; glue for stationery or household purposes; isinglass for stationery or household purposes; gluten [glue] for stationery or household purposes; starch paste [adhesive] for stationery or household purposes; printing blocks; books; manifolds [stationery]; comic books; drawing pins; cigar bands; envelopes [stationery]; boxes of paper or cardboard; cases for stamps [seals]; paint boxes for use in schools; correcting fluids [office requisites]; printed coupons; stencils [stationery]; French curves; paper ribbons, other than haberdashery or hair decorations; typewriter ribbons; barcode ribbons; gummed tape [stationery]; adhesive bands for stationery or household purposes; correcting tapes [office requisites]; inking ribbons; adhesive tapes for stationery or household purposes; self-adhesive tapes for stationery or household purposes; square rulers for drawing; drawing rulers; flyers; absorbent sheets of paper or plastic for foodstuff packaging; humidity control sheets of paper or plastic for foodstuff packaging; viscose sheets for wrapping; sheets of reclaimed cellulose for wrapping; plastic bubble packs for wrapping or packaging; steel letters; type [numerals and letters]; lithographs; letter trays; paint trays; architects' models; postage stamps; plastics for modelling; graphic prints; modelling materials; teaching materials [except apparatus]; sealing compounds for stationery purposes; adhesives [glues] for stationery or household purposes; padding materials of paper or cardboard; bookbinding material; packing [cushioning, stuffing] materials of paper or cardboard; packaging material made of starches; filtering materials of paper; addressing machines; pencil sharpening machines, electric or non-electric; bookbinding apparatus and machines [office equipment]; typewriters, electric or non-electric; paper creasers [office requisites]; franking machines for office use; chalk for lithography; writing chalk; tailors' chalk; marking chalk; spray chalk; bags [envelopes, pouches] of paper or plastics, for packaging; garbage bags of paper or of plastics; plastic bags for pet waste disposal; painters' easels; hand-rests for painters; printing sets, portable [office requisites];

bibs of paper; bibs, sleeved, of paper; stickers [stationery]; fingerstalls for office use; writing cases [stationery]; cords for bookbinding; paper knives [letter openers]; printed sheet music; numbering apparatus; bottle envelopes of paper or cardboard; sealing wafers; covers [stationery]; passport holders; plastic cling film, extensible, for palletization; embroidery designs [patterns]; handwriting specimens for copying; oleographs; musical greeting cards; greeting cards; postcards; etchings; conical paper bags; paper bags for use in the sterilization of medical instruments; bags for microwave cooking; palettes for painters; ink sticks; pantographs [drawing instruments]; loose-leaf binders; files [office requisites]; folders for papers; papier mâché; pastels [crayons]; modelling paste; pen cases; pen wipers; office perforators; pens [office requisites]; nibs of gold; nibs; steel pens; drawing pens; song books; seals [stamps]; sealing stamps; clipboards; address plates for addressing machines; handkerchiefs of paper; plastic film for wrapping; desk mats; trays for sorting and counting money; coasters of paper; bookends; stamp stands; mats for beer glasses; stands for pens and pencils; photograph stands; obliterating stamps; inking pads; stamp pads; binding strips [bookbinding]; towels of paper; inking sheets for document reproducing machines; inking sheets for duplicators; cloth for bookbinding; gummed cloth for stationery purposes; printers' blankets, not of textile; portraits; paperweights; writing cases [sets]; inkstands; office requisites, except furniture; writing materials; writing instruments; drawing materials; school supplies [stationery]; adhesive tape dispensers [office requisites]; hand labelling appliances; printed matter; lithographic works of art; prospectuses; printed timetables; ledgers [books]; printers' galleys; indexes; paper cutters [office requisites]; rubber erasers; elastic bands for offices; T-squares for drawing; graphic reproductions; retractable reels for name badge holders [office requisites]; penholders; marking pens [stationery]; tissues of paper for removing make-up; paper wipes for cleaning; dental tray covers of paper; face towels of paper; place mats of paper; tablemats of paper; tablecloths of paper; paper clasps; document files [stationery]; scrapers [erasers] for offices; paper-clips; clips for offices; erasing products; biological samples for use in microscopy [teaching materials]; histological sections for teaching purposes; figurines of papier mâché; steatite [tailor's chalk]; writing board erasers; composing frames [printing]; sealing wax; arithmetical tables; placards of paper or cardboard; writing or drawing books; fabrics for bookbinding; stationery; pencil sharpeners, electric or non-electric; transparencies [stationery]; stencil plates; stencils for decorating food and beverages; cardboard tubes; Indian inks; moisteners [office requisites]; moisteners for gummed surfaces [office requisites]; squares for drawing; chart pointers, non-electronic; bottle wrappers of paper or cardboard; envelope sealing machines for offices; sealing machines for

offices; vignetting apparatus; apparatus for mounting photographs; stapling presses [office requisites]; manuals [handbooks]; paper coffee filters; flags of paper; silver paper; moulds for modelling clays [artists' materials]; photo-engravings; photographs [printed]; stencil cases; canvas for painting; chromolithographs [chromos]; animation cels; compasses for drawing; numbers [type]; artists' watercolour saucers; ink; correcting ink [heliography]; inkwells; blueprints; stencils; erasing shields; balls for ball-point pens; desktop cabinets for stationery [office requisites]; printing type; address stamps; stamps [seals]; shields [paper seals]; prints [engravings]; labels of paper or cardboard; aquarelles; posters.

30 – Vanilla flavourings for culinary purposes; flavourings, other than essential oils, for cakes; flavourings, other than essential oils, for beverages; coffee flavourings; food flavourings, other than essential oils; star aniseed; baozi; cereal bars; high-protein cereal bars; pancakes; noodle-based prepared meals; freeze-dried dishes with the main ingredient being pasta; freeze-dried dishes with the main ingredient being rice; buns; bulgur; bread rolls; edible rice paper; edible paper; burritos; vanillin [vanilla substitute]; vareniki [stuffed dumplings]; waffles; vermicelli; natural sweeteners; sausage binding materials; binding agents for ice cream; seawater for cooking; seaweed [condiment]; malt biscuits; cloves [spice]; mirror icing [mirror glaze]; cake frosting [icing]; glucose for culinary purposes; mustard; croûtons; buckwheat, processed; gluten additives for culinary purposes; yeast; thickening agents for cooking foodstuffs; leaven; rice-based snack food; cereal-based snack food; artificial coffee; vegetal preparations for use as coffee substitutes; dressings for salad; zephyr [confectionery]; fruit jellies [confectionery]; candy decorations for cakes; confectionery for decorating Christmas trees; cakes; pastries; peanut confectionery; almond confectionery; pasta; ground ginger; frozen yogurt [confectionery ices]; cocoa; cream of tartar for culinary purposes; capers; caramels [sweets]; curry [spice]; ketchup [sauce]; prepared rice rolled in seaweed; kimchi pancakes; quinoa, processed; quiches; gluten prepared as foodstuff; flour-based dumplings; sweets; liquorice [confectionery]; peppermint sweets; mints for breath freshening; dulce de leche; cinnamon [spice]; coffee; unroasted coffee; starch for food; crackers; custard; hominy grits; semolina; oatmeal; crushed barley; groats for human food; ice cubes; corn, milled; corn, roasted; meat pies; turmeric; couscous; noodles; soba noodles; udon noodles; ice for refreshment; ice, natural or artificial; edible ices; candy; rice cakes; potato-based flatbreads; mayonnaise; macarons; macaroni; maltose; hominy; piccalilli; marinades; marzipan; honey; miso; royal jelly; ice cream; bean meal; buckwheat flour; tapioca flour; potato flour; corn flour; nut flours; flour; wheat flour; soya flour; barley meal; dessert mousses [confectionery]; chocolate mousses; muesli; mint for confectionery; cocoa beverages with milk; coffee be-

verages with milk; coffee-based beverages; cocoa-based beverages; chamomile-based beverages; tea-based beverages; chocolate beverages with milk; chocolate-based beverages; infusions, not medicinal; crushed oats; husked oats; savoury pancakes; onigiri; nutmegs; chocolate-coated nuts; stick liquorice [confectionery]; pastila [confectionery]; lozenges [confectionery]; molasses for food; pâtés en croûte; pelmeni; pepper; allspice; peppers [seasonings]; pesto; biscuits; petit-beurre biscuits; bibimbap [rice mixed with vegetables and beef]; pies; pizzas; meat gravies; fondants [confectionery]; popcorn; powders for making ice cream; baking powder; mustard meal; pralines; aromatic preparations for food; condiments; meat tenderizers for household purposes; cereal preparations; oat-based food; propolis; gingerbread; spices; petits fours; rice pudding; puddings; cake powder; fruit coulis [sauces]; ravioli; ramen; chewing gum; chewing gum for breath freshening; relish [condiment]; rice; instant rice; wheat germ for human consumption; spring rolls; sago; sugar; palm sugar; sesame seeds [seasonings]; linseed for culinary purposes [seasoning]; processed seeds for use as a seasoning; aniseed; agave syrup [natural sweetener]; golden syrup; confectionery; savoury pancake mixes; baking soda [bicarbonate of soda for cooking purposes]; malt for human consumption; salt for preserving foodstuffs; cooking salt; celery salt; sorbets [ices]; ham glaze; cranberry sauce [condiment]; soya sauce; tomato sauce; apple sauce [condiment]; sauces [condiments]; pasta sauce; spaghetti; seasonings; chocolate-based spreads; chocolate spreads containing nuts; preparations for stiffening whipped cream; shaved ice with sweetened red beans; rusks; breadcrumbs; sushi; rice crackers; sandwiches; tabbouleh; tacos; tapioca; tarts; dough; pastry dough; almond paste; rice pulp for culinary purposes; cake batter; tortillas; garden herbs, preserved [seasonings]; chocolate decorations for cakes; vinegar; beer vinegar; ferments for pastes; halvah; bread; unleavened bread; chips [cereal products]; corn flakes; oat flakes; hot dog sandwiches; flowers or leaves for use as tea substitutes; jiaozi; chicory [coffee substitute]; tea; iced tea; chutneys [condiments]; minced garlic [condiment]; cheeseburgers [sandwiches]; chow-chow [condiment]; saffron [seasoning]; chocolate; malt extract for food; essences for foodstuffs, except etheric essences and essential oils; husked barley.

35 – Arranging subscriptions to telecommunication services for others; import-export agency services; commercial information agency services; advertising agency services; cost price analysis; rental of office equipment in co-working facilities; rental of advertising space; business auditing; financial auditing; business intermediary services relating to the matching of potential private investors with entrepreneurs needing funding; employment agency services; computerized file management; book-keeping; invoicing; demonstration of goods; transcription of communications [office functions]; opinion polling; market studies;



providing business information; providing commercial information and advice for consumers in the choice of products and services; business investigations; business research; marketing research; personnel recruitment; business management and organization consultancy; business organization consultancy; business management consultancy; personnel management consultancy; professional business consultancy; consultancy regarding advertising communication strategies; consultancy regarding public relations communication strategies; layout services for advertising purposes; marketing; marketing in the framework of software publishing; targeted marketing; business management of performing artists; business management of sports people; writing of curriculum vitae for others; script-writing for advertising purposes; news clipping services; updating and maintenance of information in registries; updating and maintenance of data in computer databases; updating of advertising material; word processing; online retail services for downloadable and pre-recorded music and movies; online retail services for downloadable ring tones; online retail services for downloadable digital music; organization of exhibitions for commercial or advertising purposes; arranging newspaper subscriptions for others; organization of fashion shows for promotional purposes; organization of trade fairs; shop window dressing; development of advertising concepts; business appraisals; payroll preparation; data search in computer files for others; sponsorship search; administrative assistance in responding to calls for tenders; business management assistance; commercial or industrial management assistance; commercial intermediation services; providing business information via a website; providing commercial and business contact information; provision of an online marketplace for buyers and sellers of goods and services; web indexing for commercial or advertising purposes; presentation of goods on communication media, for retail purposes; media relations services; economic forecasting; auctioneering; wholesale services for pharmaceutical, veterinary and sanitary preparations and medical supplies; retail services for works of art provided by art galleries; retail services for pharmaceutical, veterinary and sanitary preparations and medical supplies; sales promotion for others; promotion of goods and services through sponsorship of sports events; production of teleshopping programmes; production of advertising films; office machines and equipment rental; rental of advertising time on communication media; publicity material rental; rental of billboards [advertising boards]; rental of vending machines; rental of sales stands; rental of photocopying machines; publication of publicity texts; radio advertising; bill-posting; distribution of samples; dissemination of advertising matter; direct mail advertising; registration of written communications and data; writing of publicity texts; advertising; online advertising on a computer network; advertising by mail order; television adverti-

sing; compilation of statistics; compilation of information into computer databases; business inquiries; systemization of information into computer databases; advisory services for business management; corporate communications services; negotiation of business contracts for others; negotiation and conclusion of commercial transactions for third parties; compiling indexes of information for commercial or advertising purposes; tax preparation; drawing up of statements of accounts; telemarketing services; psychological testing for the selection of personnel; interim business management; outsourced administrative management for companies; business management of hotels; business management for freelance service providers; business project management services for construction projects; commercial administration of the licensing of the goods and services of others; business management of reimbursement programmes for others; administration of consumer loyalty programs; administration of frequent flyer programs; administrative processing of purchase orders; public relations; commercial lobbying services; competitive intelligence services; modelling for advertising or sales promotion; typing; market intelligence services; appointment reminder services [office functions]; website traffic optimization; administrative services for the relocation of businesses; tax filing services; search engine optimization for sales promotion; appointment scheduling services [office functions]; gift registry services; price comparison services; pay per click advertising; secretarial services; procurement services for others [purchasing goods and services for other businesses]; shorthand; outsourcing services [business assistance]; telephone answering for unavailable subscribers; photocopying services; business efficiency expert services.

39 – Air transport; motor coach rental; boat rental; garage rental; rental of vehicle roof racks; aircraft rental; parking place rental; rental of electric wine cellars; rental of warehouses; rental of tractors; booking of seats for travel; travel reservation; transport reservation; towing; vehicle breakdown towing services; bottling services; water distribution; delivery of newspapers; message delivery; parcel delivery; delivery of goods; delivery of goods by mail order; flower delivery; replenishment of vending machines; launching of satellites for others; providing traffic information; providing transportation information; providing information relating to storage services; transportation logistics; rescue operations [transport]; arranging of cruises; arranging of passenger transportation services for others via an online application; arranging of transportation for travel tours; armoured-car transport; hauling; carting; transport and storage of waste; transporting furniture; lighterage services; ferry-boat transport; removal services; transport of travellers; guarded transport of valuables; bus transport; car transport; barge transport; boat transport; railway transport; marine transport; passenger transport; river transport; ambulance transport; tram transport; portage; refloa-



ting of ships; cash replenishment of automated teller machines; shipbrokerage; transport brokerage; freight brokerage [forwarding (Am.)]; providing driving directions for travel purposes; car rental; railway truck rental; rental of diving bells; rental of diving suits; rental of motor racing cars; rental of aircraft engines; railway coach rental; rental of wheelchairs; rental of storage containers; horse rental; rental of freezers; rental of navigational systems; refrigerator rental; vehicle rental; stevedoring; unloading cargo; electricity distribution; distribution of energy; packaging of goods; collection of recyclable goods [transport]; ice-breaking; piloting; water supplying; escorting of travellers; transport by pipeline; wrapping of goods; operating canal locks; car parking; chauffeur services; pleasure boat transport; car sharing services; courier services [messages or merchandise]; salvaging; salvage of ships; gift wrapping; underwater salvage; taxi transport; transport; transport services for sightseeing tours; luggage storage; franking of mail; freight [shipping of goods]; freighting; physical storage of electronically stored data or documents; boat storage; storage of goods; storage; freight forwarding.

43 – Accommodation bureau services [hotels, boarding houses]; rental of temporary accommodation; rental of meeting rooms; tourist home services; hotel reservations; boarding house bookings; temporary accommodation reservations; hotel services; retirement home services; snack-bar services; information and advice in relation to the preparation of meals; café services; cafeteria services; motel services; boarding house services; boarding for animals; rental of cooking apparatus; rental of chairs, tables, table linen, glassware; rental of lighting apparatus; rental of tents; rental of transportable buildings; rental of drinking water dispensers; restaurant services; self-service restaurant services; reception services for temporary accommodation [management of arrivals and departures]; food sculpting; canteen services; decorating of food; cake decorating; holiday camp services [lodging]; bar services; providing campground facilities; personal chef services; food and drink catering; was-hoku restaurant services; udon and soba restaurant services; day-nursery [crèche] services.

(260) AM 2022 117493 A

(800) 1656023

(151) 2021 12 20

(891) 2021 12 20

(731) Holland & Barrett International Limited  
Samuel Ryder House, Barling Way, Eliot Park,  
Nuneaton, Warwickshire CV10 7RH, United  
Kingdom

(540)

**H&B**

(591) Black, white

(511)

3 – Soaps; perfumery, essential oils, cosmetics; toiletries; non-medicated toilet preparations; cosmetic preparations for slimming purposes; aromatherapy products; hair lotions, shampoos; anti-perspirants and deodorants for personal use; skin lotions; personal care products; hair conditioners; bath preparations; body care products; body lotions, oils and washes; dental and dental hygiene products (term considered too vague by the International Bureau – Rule 13 (2) (b) of the Regulations); dentifrices; fragrance oils; incense; lip balms; massage oils; cleaning, polishing, scouring and abrasive preparations.

5 – Pharmaceutical preparations; dietetic substances for medical use; diabetic foodstuffs; dietetic foods adapted for medical purposes; dietetic substances adapted for medical use; medical preparations for slimming purposes; slimming pills; medicinal herbs; herbal preparations for medical purposes; herbal supplements and herbal extracts for medical use; herbal beverages for medical use; herbal teas for medical purposes; vitamins, vitamin preparations; minerals, mineral preparations for medical use; vitamin and mineral food supplements; food supplements; nutritional supplements; protein dietary supplements; dietetic substances, foodstuffs and beverages; herbal supplements; herbal extracts; herbal beverages (term considered too vague by the International Bureau – Rule 13 (2) (b) of the Regulations); mineral preparations; detox preparations and substances; diuretic preparations and substances; herbal medicinal products, preparations and substances; homeopathic preparations and substances; nutraceutical preparations and substances; dietary supplements; nutraceutical foodstuffs and beverages; vitamin drinks and beverages; medicated confectionery; medicated preparations for making beverages; preparations for promoting weight loss; tonics (medicine); nutritional drink mixes for use as a meal replacement; meal replacement powders; protein shakes (term considered too vague by the International Bureau – Rule 13 (2) (b) of the Regulations); protein powder dietary supplement; nutritional bars (term considered too vague by the International Bureau – Rule 13 (2) (b) of the Regulations); foods for babies and infants; creatine food supplements; amino acid food supplements.

35 – Demonstration of goods; direct mail advertising; distribution of samples; retail services relating to beverage products, drinks, food products, food, gardening products, herbal products, household cleaning products, magazines and periodicals, printed matter, products for the promotion of bodily fitness, shopping and carrier bags, snackfoods, snacks, sporting articles, wholefoods; retail services connected with the sale of cosmetics, toiletries, dental products, diabetic foodstuffs, dietary supplements and dietetic preparations, herbal supplements and preparations, vitamins and vitamin preparations, essential oils and fragrances, he-

alth foods, supplements, minerals, nutraceuticals, nutritional supplements, perfumery, personal care products, pharmaceuticals, printed matter, sports nutrition products, therapeutic products.

---

(260) AM 2022 117497 A

(800) 1656161

(151) 2021 10 26

(891) 2021 10 26

(731) Publicis Groupe SA

133, avenue des Champs-Élysées, F-75008

PARIS, France

(540)

## ZENITH

(591) Black, white

(511)

42 – Industrial research in the field of advertising and marketing; industrial and commercial design services; graphic design services; research into and design of new products; new product development; design, development, maintenance, hosting and implementation of websites, computer software, computer software applications, computer platforms and computer programs; software as service [SaaS]; software as a service [SaaS], namely, software in the field of advertising and marketing; software as service [SaaS], namely, software for tracking, monitoring and reporting on media, press, social media, trends; software as a service [SaaS], namely, software technology tools in the nature of search engines and digital coding; platform as a service [PaaS] featuring online computer platforms for tracking, monitoring and reporting on media, press, social media, trends; platform as a service [PaaS] featuring online computer platforms for advertising, marketing, promotional and public relation purposes; software as service, namely, software for evaluating customer behavior and analysing social networking behaviour; platform as a service [PaaS] featuring online computers for the development of advertising focused technology data and analytic tools; provision of online non-downloadable software [application service provider] and platforms for media buying; design and development of brand and social analytical tools, technical data analysis; provision of online non-downloadable software in the form of brand and social analytical tools; implementation of software for reporting, simulation and optimization of marketing; troubleshooting in the nature of diagnosing problems with consumer electronics, namely, 24/7 service desk or help desk service for IT infrastructure, operating systems, database systems and web applications; platform as a service [PaaS] for information technology support services namely 24/7 service desk or help desk services for IT infrastructure, operating systems, database systems and web applications; information services relating to information technology; computer software support services; online support services for computer program users;

consultancy and advisory services relating to computer software, application software, telecommunications technology and graphic design services; electronic storage of digital media, photographs, film, video tape, sound tracks, emails; electronic storage of secure digital media, photographs, film, video tape, sound tracks, emails, electronic storage of documentary records; electronic storage of documents; storage of electronically stored data or documents; electronic storage of data in the field of commercial and promotional information; electronic storage of data in the field of commercial and promotional information via website; electronic remote file storage; file and document retrieval; graphic design services for creating graphic elements of corporate logos.

---

(260) AM 2022 117498 A

(800) 1656163

(151) 2021 10 21

(891) 2021 10 21

(731) Elzbieta Ingłot Zbigniew Ingłot Spółka Cywilna  
ul. Grunwaldzka 62A, PL-37-700 Przemyśl,  
Poland

(540)

## INGLOT

(591) Black, white

(511)

35 – The bringing together, for the benefit of others, of goods, namely colorants for toilet purposes, cosmetics, deodorants and antiperspirants, perfumes and perfumery, toilet water, scented water and eau de cologne, essential oils, soaps, fragranced soaps, disinfectant soaps, antiperspirant soaps and medicated soaps, beauty masks, creams, nail varnishes and nail conditioners, nail varnish removers, lotions for cosmetic purposes, make-up and make-up removing agents and preparations, eye pencils and eyebrow pencils and sharpeners for the aforesaid pencils, lip pencils, lip glosses, protective lipsticks, eye shadows, foundation, make-up fluids and powders, eyelash curlers, preparations for care of the skin, hair and nails, dentifrices and dental bleaching preparations, mouthwashes, eyelash care preparations, mascara, decorative transfers for cosmetic purposes, false hair, false eyelashes and false nails, sun-tanning and after-sun preparations, talcum powder for toilet use, cleansing milk for toilet purposes and astringents for cosmetic purposes, oils and petroleum jelly for cosmetic purposes, cosmetic kits, depilatory preparations, hair care and hair styling preparations, hair dyes and hair dye creams, henna, hair dye removing preparations, preparations for permanent waving, neutralisers for permanent waving, hair straightening creams, hair fixatives, hair lacquers, hair gels, hair mousses, hair wax, hair creams, hair putty, oils for hair conditioning, hair glaze, hair pastes, hair-bleaching preparations, hair sprays, hydrogen peroxide for hair, preparations for regeneration and revitalisation of hair, serum, hair masks, hair balms

and conditioners, shampoos, shaving preparations, after-shave lotions, lotions, gels, bath beads and bath salts, breath-freshening sprays, pumice stones, sachets for perfuming linen, scented wood, joss sticks, nail art stickers, impregnated wipes, potpourri, cotton pads, cotton sticks for cosmetic purposes, household chemicals, powders, liquids, gels and tablets for laundry use, laundry fabric conditioners and fabric softeners, bleaching preparations and other substances for laundry use, colour-brightening chemicals for household purposes, cleaning, polishing, scouring and abrasive preparations, non-slipping preparations for floors, antistatic preparations for household purposes, detergents and disinfectants, descalers and preparations for removing scale and similar residues for household purposes, smoothing preparations (starching), colour-removing preparations, degreasing preparations, preparations for cleaning dentures, rust removing preparations, preparations for clearing canal pipes, windscreen cleaner fluids, tissues impregnated with cleaning preparations, air fresheners, drying agents for dishwashing machines, wallpaper cleaning preparations, turpentine, stain removers, preparations for cleaning and maintenance of footwear, preparations for cleaning and maintenance of floors and furniture, preparations for cleaning and maintenance of electric and electronic household appliances and radio and television units, candles, oil-burners, decorative candles, special-occasion candles and festive candles, perfumed candles, tapers, beeswax candles, candles for christmas trees, sanitary preparations for medical purposes, dietetic food, beverages and substances adapted for medical or veterinary use, lacteal flour and food for babies, dietary supplements for humans and animals, plasters, material for dressings, disinfectants, pharmaceutical and veterinary substances, balms for pharmaceutical purposes, tissues impregnated with pharmaceutical lotions, contact lens cleaning preparations, solutions for contact lenses, herbal teas for medicinal purposes, medicinal tea, personal sexual lubricants, bath salts for medical purposes, pharmaceutical preparations for treating dandruff, panty liners, breast pads, mothproofing paper and mothproofing preparations, medical preparations for slimming purposes, deodorants for clothing and textiles, insect repellent incense and insect repelling preparations, nappies, nappy pants, sanitary pads, tampons, mouthwashes for pharmaceutical purposes, pharmaceutical preparations for body and foot perspiration, air deodorising preparations, vitamin preparations, promotional goods of common metal, figurines of common metal, nail files, nail clippers and nail buffers (electric or non-electric), manicure and pedicure implements, accessories for cosmetic use, cutlery, scientific, nautical, surveying, photographic, cinematographic, optical, weighing, measuring, signalling, checking (supervision), life-saving and teaching apparatus and instruments, apparatus and instruments for conducting, switching, transforming, accumulating, regulating or controlling

electricity, apparatus for recording, transmission or reproduction of sound or images, mechanisms for coin-operated apparatus, cash registers, calculating machines, advertising material on data carriers, multimedia presentations for advertising purposes, mouse pads, computer hardware, software and computer accessories, data carriers, photographic equipment, audio-video equipment, electric and electronic household appliances, fire-extinguishing apparatus, apparatus for lighting, heating, steam generating, cooking, refrigerating, drying, ventilating, water supply and sanitary purposes, bicycles, motorcycles, land, water and air vehicles, fireworks, promotional key rings, brooches, emblems, cases, chains, medals, ornaments of precious metal, goods in precious metals, clocks and watches, special-occasion coins, prize cups, special-occasion statuettes and badges, jewellery, precious stones, semi-precious stones and ornamental stones, natural and synthetic stones, figurines of precious metal, musical instruments, books, albums, posters, printed matter for advertising purposes, calendars, catalogues, flyers, banners, notebooks, bookmarkers, stationery, holders for identity cards, mats for beer glasses, goods of paper, film, cardboard and plastic, for packaging, table napkins of paper, instructional and teaching material, paper, cardboard and goods made from these materials, printed goods, bookbinding materials, photographs, atlases, pamphlets, flags of paper, magazines and periodicals, shields, figurines of papier mâché, transfers (decalcomanias), postcards, framed or unframed paintings, maps, modelling materials, stickers, covers, prospectuses, writing cases (stationery), towels of paper, graphic representations, seals, office requisites, stamps, typewriters and office requisites, bags and small bags, briefcases, bags and sleeves for laptops, backpacks, backpacks for laptops, bags for sports, suitcases, trunks, trunks and cases for storing cosmetics and cosmetic accessories, parasols, leatherware, goods of leather and imitations of leather, belts (clothing), garden and beach parasols, pocket wallets and purses, shopping bags, walking sticks, whips, harness and saddlery, spectacles, sunglasses, figurines of stone, concrete or marble, goods of wood, cork, reed, cane, wicker, horn, bone, ivory, whalebone, shell, amber, mother-of-pearl, meerschaum and substitutes for all these materials, furniture, mirrors, picture frames, goods of wood, cork, reed, cane, wicker, garden, catering and conference furniture, display furniture, furniture for use in massage salons, wellness centres, spa salons, hairdressing salons, beauty salons, manicure salons, pedicure salons, tattooing salons and visage salons, furniture for beauty salons, lamps and apparatus for lighting, screens (furniture), display stands, market stalls, stands, hangers, bamboo curtains and curtains for decoration, figurines of wood, wax, plaster or plastic, accessories for cosmetic use, nail brushes, sponges, facial sponges for applying make-up, make-up brushes, shaving brushes, hair combs and hair brushes, eyebrow brushes, implements

for cosmetic use, household or kitchen utensils and containers, glassware, porcelain and earthenware, paper plates and disposable plates, figurines of porcelain, terra cotta and glass, glassware, porcelain and earthenware, soap dispensers and toilet paper holders, comb cases, paintbrushes and brushes, cases for storing toiletries and cosmetics, soap boxes, floss for dental purposes, powder compacts, thermally insulated containers and bags for food, tents, commercial tents, holiday tents, knights' tents, banquet tents, storage sheds, tent halls, canopies (awnings) and canopies, including in particular for picnics, trade fairs, exhibitions, terraces, gardens and exterior parts of service and commercial premises, porches, porch tents for caravans, awnings, tarpaulins, ropes, strings, tapes, vehicle covers, bags of textile for packaging, textiles and textile goods, bed clothes and towels, table napkins of textile, bed covers, blankets, table covers, flags of textile, clothing, footwear and headgear for women, men, children and for sports, underwear, furs (clothing), haberdashery, promotional lanyards, sublimation lanyards, short hand lanyards, zip lanyards, silicone lanyards, silicone wristbands, tapes with sublimation print, accessories for promotional lanyards, namely fastening clips, clip hooks, tags, rings, shackles, printed tapes, haberdashery tapes, elastic ribbons, emblems for advertising purposes, not of precious metals, brooches for advertising purposes, shoe laces, numerals for marking linen, snap fasteners, ornaments for clothing, footwear and headgear, not of precious metals, ornaments for the hair, hair nets, hair pins, plaited hair, false hair, hair extensions, ornamental buckles for clothing and footwear, reins for guiding children, haberdashery articles for advertising purposes, carpets, rugs, mats and matting, linoleum and other materials for covering existing floors, wall hangings (non-textile), games and playthings, gymnastic and sporting articles, sports equipment, specialised sports equipment, decorations for christmas trees, meat, fish, poultry and game, meat extracts, preserved, frozen, dried, cooked, baked, stewed and fried fruits, vegetables and mushrooms, jellies, jams and fruit sauces, eggs, milk, and milk products, edible oils and fats, fruit and potato crisps, potato crisps, jams, fish fillets, jellies for food, meat jellies, vegetable soups, yogurt, sauerkraut, kefir, croquettes, salmon, milk products, milk beverages, milk predominating, fruit jellies, fruit salads, fruit-based snack food, fish meals, foods prepared from fish, meat dishes, meat and vegetable dishes, vegetable dishes, vegetable salads, herrings, tuna fish, soups, anchovies, whipped cream, bouillon, dates, tripe, hummus, eggs, sausages, sausages in batter, bouillon and broth concentrates, gherkins, butter, fruit pulp, toasted laver, nuts (fruits), frosted fruits, liver pâté, tomato purée, apple purée, fruit pulp, nuts and dried fruits, raisins, cheese and cottage cheese, fruit peel, charcuterie, potato fritters, chips, cooked and frozen foodstuffs, coffee, tea, cocoa, sugar, rice, tapioca and sago, artificial coffee, flour and pre-

parations made from cereals, bread, pastry and confectionery, ices, honey, treacle, yeast, baking-powder, salt, mustard, vinegar, sauces (condiment), spices, ice, sponge cakes, buns, bread rolls, unleavened bread, dough, meat pies, farinaceous food pastes, cakes, biscuits, halvah, biscuits, fruit jellies, waffles, sandwiches, groats for human food, pasta, macaroni, ribbon vermicelli, farinaceous foods, rice-based foods, pasta-based foods, groat-based foods, muesli, pancakes, ravioli, pies, rice-based snack food, cereal-based snack food, puddings, popcorn, spring rolls, spaghetti, sushi, tabbouleh, quiches, fruit tarts, tortillas, aromatic preparations for food, sweets, chocolate, mayonnaise, ketchup (sauce), meat gravies, vegetable gravies, meat and vegetable gravies, dessert sauces, pastries, chocolate-based beverages, cocoa-based beverages, tea-based beverages, coffee-based beverages, pizzas, corn flakes, oat flakes, salad sauces, ready-made and frozen foodstuffs, fresh fruits and vegetables, fruit and vegetable salads, nuts (fruits), bran, fresh herbs, non-alcoholic beverages, fruit juices, fruit nectars and fruit mousses, vegetable juices, vegetable nectars and vegetable mousses, vegetable and fruit juices, vegetable and fruit nectars and vegetable and fruit mousses, fruit syrups, mineral and aerated waters, beers, alcoholic beverages, matches, smokers' articles, enabling customers to conveniently view and purchase those goods in shops, warehouses, commercial stands, trade fairs and exhibitions, online and by mail order, advertising of all the aforesaid goods, direct mail advertising, organising and conducting of trade fairs and exhibitions for commercial or advertising purposes, rental of sales stands, publicity materials and digital billboards for trade fairs and commercial and advertising exhibitions, dissemination of advertising matter and advertising gadgets, import-export agencies, commercial information agencies, office and secretarial services, business management; business administration, business management and organisation consultancy, personnel management consultancy, business efficiency experts services and economic forecasting, sales promotion for others, public relations, publication of publicity texts, publicity columns preparation, radio and television advertising, bill-posting, Internet advertising and other forms of advertising, arranging of sales, rental of advertising space, publicity material rental, rental of automatic vending machines, updating of advertising material, business representation, advertising, computerised file management, maintaining computer databases, updating of computer databases.

44 – Hygienic and beauty care for human beings or animals; massage salons, wellness centres and spa salons, saunas, solariums, aromatherapy, hairdressing salons, beauty salons, manicuring, pedicuring, tattooing, animal grooming, flower arrangement, visagists' services, consultancy relating to hygienic and beauty care for human beings or animals, medical services.

(260) AM 2022 117594 A  
 (800) 1657472  
 (151) 2021 12 28  
 (891) 2021 12 28  
 (731) TANIKAWA YUKA KOGYO CO., LTD.  
 13-11, Yakoh 1-chome, Tsurumi-ku,  
 Yokohama-shi, Kanagawa-ken 230-0001, Japan

(540)

**TCL**

(591) Black, white

(531) 27.05.17

(511)

1 – Chemicals; antifreezing liquids; antifreeze for automobile engine; antifreeze for motorcycle engine; antifreeze for vehicle radiators; antifreeze for vehicle engines; coolants; coolants for vehicle engines; coolants for automobile engine; coolants for motorcycle engine; coolants for vehicle radiators; engine antifreeze coolants; anti-rust additives for radiators; defoaming agents; chemical additives for engine cooling systems; chemical additives for fuel in the nature of octane boosters; chemical additives for gasoline; chemical additives for fuel treatment; chemical additives for fuel injection system cleaners; chemical additives for fuel; chemical additives for greases; chemical additives for diesel fuels; chemical additives for transmission fluids; detergent additives for motor oil; chemical additives for motor oil; chemical additives for use with internal combustion engine fuels; chemical additives to motor fuel; combusting preparations [chemical additives to motor fuel]; chemical additives for oils; detergent additives to gasoline; detergent additives to petrol; detergent additives for fuels; chemical additives for lubricants; brake fluid; brake fluid for motorcycle; brake fluid for automobile; transmission fluids; automatic transmission fluids.

4 – Engine oils; diesel oils; non-chemical additives for gasoline; non-chemical additives for fuels; additives, non-chemical, to motor fuel; industrial oils; mineral oils and greases for industrial purposes [not for fuel]; lubricating oils; non-chemical additives for lubricants; non-chemical additives for greases; non-chemical additives for engine oils; non-chemical additives for fuels, lubricants and greases; non-chemical additives for motor oil; non-chemical additives for oils and fuels.

(260) AM 2022 117595 A

(800) 1657500

(151) 2022 02 09

(891) 2022 02 09

(731) Doka GmbH

Josef-Umdasch-Platz 1, A-3300 Amstetten,  
 Austria

(540)

**FRAMAX**

(591) Black, white

(511)

6 – Load-bearing and supporting structures made of metal for concrete formwork sheets, in particular formwork beams; form ties, pins, tensioning wedges, anchor angles, brackets of metal for building, framed structures, lifting hooks, steel walings for formwork panels, steel connectors for formwork panels, formwork she-bolts, formwork anchor plates, formwork form-tie nuts, formwork tie rods, all goods made of metal that are exclusively intended for scaffolding and formwork.

19 – 3-ply plywood sheets, building boards, not of metal, plywood sheets.

(260) AM 2022 117633 A

(800) 1658085

(151) 2022 02 23

(891) 2022 02 23

(731) Cofoe Medical Technology Co., Ltd.  
 No.816, Zhenhua Road, Yuhua District, Changsha City, Hunan Province, China

(540)

**Cofoe**

(591) Black, white

(531) 27.05.01

(511)

10 – Sphygmotensimeters; hearing aids; orthopaedic belts; condoms; ultraviolet ray lamps for medical purposes; thermometers for medical purposes; trusses.

(260) AM 2022 117634 A

(800) 1658103

(151) 2021 12 16

(891) 2021 12 16

(731) Euro Games Technology Ltd.

4, "Maritsa" Str., "Vranya-Lozen-Triugulnika",  
 BG-1151 Sofia, Bulgaria

(540)

**GOLD  
 KEEPER**

(591) Red, orange, yellow, white, pink, purple, blue, brown and black

(531) 01.15.05; 27.05.01; 27.05.03; 27.05.07;  
 27.05.08; 27.05.09; 27.05.10; 27.05.19;  
 29.01.15

(511)

9 – Software; computer gaming software; computer software packages; computer operating system software; computer software, recorded; software drivers; virtual reality software; games software; entertainment software for computer games; computer programs for network management; operating computer software for main frame computers; monitors (computer hardware); computer hardware; apparatus for recording images; monitors (computer programs); computer game programs; computer programs for recorded games; apparatus for recording, transmission or reproduction of sound or images; communications servers [computer hardware]; electronic components for gambling machines; computer application software featuring games and gaming; computer software for the administration of on-line games and gaming; computer hardware for games and gaming; hardware and software for gambling, gambling machines, gambling games on the Internet and via telecommunication network.

28 – Gaming machines for gambling; chips for gambling; mah-jong; arcade games; gambling machines operating with coins, notes and cards; games; electronic games; parlor games; gaming chips; gaming tables; slot machines [gaming machines]; LCD game machines; slot machines and gaming devices; coin-operated amusement machines; roulette chips; poker chips; chips and dice [gaming equipment]; gaming equipment for casinos; roulette tables; gaming roulette wheels; casino games; gambling machines and amusement machines, automatic and coin-operated; coin-operated amusement machines and/or electronic coin-operated amusement machines with or without the possibility of gain; boxes for coin-operated machines, slot machines and gaming machines; electronic or electrotechnical amusement machines and apparatus, gaming machines, coin-operated entertainment machines; housings for coin-operated machines, gaming equipment, gaming machines, machines for gambling; electropneumatic and electrical gambling machines (slot machines).

41 – Gambling; entertainment services related to gambling; gaming services for entertainment purposes; casino, gaming and gambling services; training in the development of software systems; provision of gaming equipment for gambling halls; providing casino equipment [gambling]; gaming machine entertainment services; providing casino facilities [gambling]; gaming hall services; amusement arcade services; games equipment rental; rental of gaming machines; providing amusement arcade services; rental of gaming machines with images of fruits; editing or recording of sounds and images; sound recording and video entertainment services; hire of sound reproducing apparatus; provision of gaming equipment for casinos; providing of casino facilities; online gambling services; casino, gaming and gambling services; provision

of gaming facilities, gaming hall facilities, Internet casinos and online gambling services.

(260) AM 2022 117635 A

(800) 1658262

(151) 2021 10 21

(891) 2021 10 21

(731) XIAOMI INC.

No.006, Floor 6, Building 6, Yard 33,  
Middle Xierqi Road, Haidian District, Beijing,  
China

(540)

# Redmi

(591) Black, white

(511)

2 – Dyes; dyestuffs; colorants; metal powders for painters, decorators, printers and artists; pigments; toner for copiers; ink cartridges, filled, for printers and photocopiers; automotive paints; anti-rust preparations; anti-corrosive preparations; gum resins.

3 – Hand cleaners [hand cleaning preparations]; wipes impregnated with a skin cleanser; laundry preparations; baby wipes impregnated with cleaning preparations; laundry fabric conditioner; soap; shaving soap; shampoos; automotive cleaning preparations; detergent; dishwasher detergents; shining preparations [polish]; polishing wax for automobiles and bicycles; grinding preparations; perfumery; aromatics [essential oils]; perfumes; cosmetic preparations for skin care; toothpaste; mouthwashes, not for medical purposes; breath freshening sprays; teeth whitening strips; breath freshening preparations for personal hygiene; incense; non-medicated mouth washes for pets; shampoos for pets [non-medicated grooming preparations].

7 – Agricultural machines; incubators for eggs; saws [machines]; printing machines; spinning machines; tea manufacturing machines; mixing machines; mills [machines]; mixers [machines]; kneading machines; sausage making machines; food preparation machines, electromechanical; peeling machines; cigarette making machines; leather-working machines; sewing machines; ironing machines; industrial inkjet printing machines; machines for battery industry; packaging machines; dishwashers; blenders, electric, for household purposes; coffee grinders, other than hand-operated; dish washing machines for household purposes; can openers, electric; kitchen machines, electric; food processors, electric; dry-cleaning machines; rinsing machines; extractors for mines; cutters [machines]; excavators; elevating apparatus; pneumatic jacks; metalworking machines; foundry machines; steam engines; sparking plugs for automobile engines; ignition coils for automobile engines; wind turbines; zipper making machines; tools [parts of machines]; screwdrivers, electric; hand-held tools, other than hand-operated.

ted; electric hand-held drills; optical cold working machines; dynamos; filters for cleaning cooling air, for engines; engines, other than for land vehicles; radiators [cooling] for automobile engines; cooling water tanks for automobile engines; water pipes of cooling radiators for automobile engines; hoods of cooling radiators for automobile engines; cooling fans for automobile engines; cooling fan housings for automobile engines; clutches of cooling fan for automobile engines; exhaust purifier for automobile engines [catalyst reactor]; exhaust recycling systems for automobile engines; mufflers for automobile engines; exhaust mufflers for motors and engines; resonators of exhaust systems for automobile engines; pistons for automobile engines; automobile engine cylinders; air filters for automobile engines; cylinder heads for engines; oil pumps for automobiles; water pumps for automobiles; pumps [machines]; valves [parts of machines]; aerocondensers; compressed air machines; air suction machines; pneumatic cylinders [parts of machines]; axles for machines; door openers, electric; window closers, electric; bearings [parts of machines]; flywheels for automobile engines; crankshafts for automobile engines; belts for machines; electric welding apparatus; machines and apparatus for cleaning, electric; electric cordless sweepers; steam cleaning machines; electric steam mops; brushes for vacuum cleaners; suction nozzles for vacuum cleaners; washing apparatus; vacuum cleaners; crushing machines; filtering machines; robotic exoskeleton suits, other than for medical purposes; pneumatic pumps; dust exhausting installations for cleaning purposes; steam cleaners for household purposes; cordless vacuum cleaners; dust filters and bags for vacuum cleaners.

8 – Abrading instruments [hand instruments]; agricultural implements, hand-operated; shovels; syringes for spraying insecticides; electric animal nail grinders; harpoons; oyster openers; beard clippers; electric beard trimmers; razor blades; nail clippers; electric hair clippers; hair clippers for babies; depilation appliances, electric and non-electric; laser hair removal apparatus, other than for medical purposes; electric nasal hair trimmers; electric hair straighteners; electric irons for styling hair; bit drivers for hand tools; pin-cers; borers; electric flat irons; flat irons; metal band stretchers [hand tools]; meat choppers [hand tools]; air pumps, hand-operated; tweezers; graving tools [hand tools]; scissors; knives; kitchen knives; paring irons; fruit corers; hair clippers for animals [hand instruments]; punch rings [knuckle dusters]; table knives, forks and spoons of plastic; handles for hand-operated hand tools; bits [hand tools].

9 – Computers; bags adapted for laptops; wearable computers; computer software, recorded; computer programs, downloadable; computer hardware; notebook computers; tablet computers; calculating machines; processors [central processing units]; computer game software, recorded; computer memory devices; inte-

reactive touch screen terminals; mobile phone software applications, downloadable; computer peripheral devices; data processing apparatus; encoded identification bracelets, magnetic; telepresence robots; encoded magnetic cards; readers [data processing equipment]; scanners [data processing equipment]; downloadable image files; downloadable music files; downloadable ring tones for mobile phones; electronic pens [visual display units]; electronic publications, downloadable; electronic pocket translators; smartglasses [data processing]; magnetic data media; magnetic encoded credit cards; SIM cards; monitors [computer hardware]; mouse pads; mouse [computer peripheral]; humanoid robots with artificial intelligence; printers for use with computers; photo printers; ink cartridges, unfilled, for printers and photocopiers; pens with conductive point for touch screen devices; computer keyboards; ink jet printers; laptop sleeves; smartwatches [data processing]; LED displays; display screens; digital photograph printers; cases adapted for computers; computer programs, recorded; identity cards, magnetic; microprocessors; monitors [computer programs]; optical discs; electronic tags for goods; integrated circuit cards [smart cards]; smart cards [integrated circuit cards]; pocket calculators; USB flash drives; laptop computers; sleeves for laptops; protective films adapted for computer screens; security tokens [encryption devices]; covers for tablet computers; electronic interactive whiteboards; personal digital assistants [PDAs]; computer software platforms, recorded or downloadable; computer game software, downloadable; stands adapted for laptops; downloadable e-wallets; biometric identity cards; smart rings [data processing]; electronic agendas; pedometers; counters; time recording apparatus; counterfeit coin detectors; credit card terminals; fingerprint identifier; facial recognition apparatus; photocopiers [photographic, electrostatic, thermic]; time clocks [time recording devices]; scales with body mass analysers; body fat scale; compasses for measuring; rulers [measuring instruments]; electronic notice boards; signal lanterns; protective films adapted for smartphones; cases for smartphones; mobile telephones; hands-free kits for telephones; Global Positioning System [GPS] apparatus; intercommunication apparatus; navigational instruments; telephone apparatus; transmitters [telecommunication]; video telephones; heat sink for cellular phones; routers; monopods used to take photographs by positioning a smartphone or camera beyond the normal range of the arm; wireless local area network controllers; electronic navigational and positioning apparatus and instruments; branch boxes [electricity]; radios; protective film for mobile phone screen; automobile navigational apparatus; car antennas; camcorders; security surveillance robots; rearview cameras for vehicles; compact discs [audio-video]; earphone; juke boxes, musical; loudspeakers; microphones; portable media players; sound recording apparatus; sound transmitting apparatus; video recorders; wearable vi-

deo display monitors; virtual reality headsets; wireless headsets for smartphones; audio mixers; event data recorders; audiovisual teaching apparatus; translation machine; electronic book readers; set-top boxes; television displays; cabinets for loudspeakers; loud-speaker cabinets with touch screen; audio receivers; head-mounted video displays; cameras; laser projection television; teaching robots for children and pupils in elementary and secondary school and higher education; downloadable digital content being visual stories; audiovisual teaching apparatus with artificial intelligence; bluetooth earphones; camcorder waterproof cases; high definition televisions; digital sound processors; personal computer cameras; audio equipment; radio sets; web cameras; DMB [Digital Multimedia Broadcasting] televisions; noise cancelling earphones; tape recorders; digital photo frames; baby monitors; electronic audible devices with books; car speakers; car stereos; cases especially made for photographic apparatus and instruments; filters [photography]; projection apparatus; projectors; laser projectors; projection screens; projection screens for movie films; viewfinders, photographic; diaphragms [photography]; filters for ultraviolet rays, for photography; tripods for cameras; flashlights [photography]; selfie lenses; bags adapted for photographic apparatus; surveying apparatus and instruments; measuring apparatus; telemeters; infrared detectors; tire-pressure measurers; speed checking apparatus for vehicles; diagnostic apparatus, not for medical purposes; tool measuring instruments; pressure measuring apparatus; temperature indicators; teaching apparatus; laboratory robots; chemistry apparatus and instruments; inductors [electricity]; probes for scientific purposes; microscopes; magnifying glasses [optics]; apparatus and instruments for astronomy; telescopes; USB cables for cellphones; telephone wires; materials for electricity mains [wires, cables]; data cables; USB cables; audio connecting cables; electric wire harnesses for automobiles; automobile electronic control units; commutators; magnetic materials and devices; light-emitting diodes [LED]; motion sensors; infrared sensors; humidity sensors; door and window sensors; light sensors; waterlogging and leak sensor; high speed charging plug; wireless switches; wall switches; smart switches; touchscreen sensors; touch sensors; adapter plugs; alarm sensors; sensors for determining temperature; biochip sensors; motion recognizing sensors; coils, electric; junction boxes [electricity]; distribution consoles [electricity]; connections for electric lines; connections, electric; parking sensors for vehicles; touch screens; electric apparatus for commutation; lightning arresters; fire extinguishing apparatus for automobiles; apparatus and installations for the production of X-rays, not for medical purposes; ski goggles; swimming goggles; swimming face masks; helmets for motorcyclists; goggles for scuba diving; ski glasses; snowboard helmets; underwater breathing apparatus; nose clips for swimming; protective clot-

hing for wear by motorcyclists for protection against accident or injury; clothing for protection against accidents, irradiation and fire; anti-glare glasses; visors for helmets; snorkels; alarms; anti-theft warning apparatus; sound alarms; biometric fingerprint door locks; peepholes [magnifying lenses] for doors; electric door bells; fire alarms; smoke detectors; water intrusion alarms; digital door locks; locks, electric; electronic access control systems for interlocking doors; 3D spectacles; batteries, electric; wireless chargers; USB chargers; mobile power supply [rechargeable battery]; mobile phone battery chargers for use in vehicles; batteries, electric, for vehicles; automobile batteries; accumulators for automobiles; set-top boxes [digital signal receivers]; digital cameras; television cameras; blind spot cameras for cars; speed measuring apparatus [photography]; air analysis apparatus; rods for water diviners; hygrometers; distribution boards [electricity]; electronic numeric displays; electronic locks; cell phone straps; protective films for mobile phone touch screens; equipment for communication network; wide area network [WAN] routers; computer network bridges; ethernet switches; electronic devices used to locate lost articles employing the global positioning system or cellular communication networks; telecommunication apparatus in the form of jewellery; radar receivers with amplifiers; connected bracelets [measuring instruments]; electronically encoded identity wristbands; radio-frequency identification (RFID) readers; keyboards for smartphones; smartphone screen magnifiers; transmitting and receiving apparatus for television broadcasting; digital cameras; body fat scale for household purposes; wrist-mounted smartphones; car phone holder; cases for mobile phones; cell phone cases; network routers; stands adapted for mobile phones; smartphones in the shape of a watch; intercoms; electronic apparatus and instruments for navigation and positioning; selfie sticks [hand-held monopods]; multimedia projectors; temperature sensors; change-over switches [for telecommunication apparatus]; bicycle helmets; protection devices for personal use against accidents; audiovisual teaching apparatus; automatic indicators of low pressure in vehicle tyres; protective helmets; heat regulating apparatus; conductors, electric; switches, electric; electric plugs; animated cartoons; measures; measuring devices, electric; electrolyzers; protective masks; optical apparatus and instruments; weighing apparatus and instruments; stands for photographic apparatus; radiological apparatus for industrial purposes; thermometers, not for medical purposes; simulators for the steering and control of vehicles; cash registers; semi-conductors; sunglasses; automated teller machines [ATM]; power adapters; cell phones; wearable activity trackers; fire extinguishing apparatus; bathroom scales; teaching robots; electric sockets; video projectors; sensors; goggles; electronic chips; selfie sticks for mobile phones; ink-jet document printers; electronic card readers; computer programs for pre-recorded games; touch



screen pens; magnifying peepholes for doors; computer screen saver software, recorded or downloadable; downloadable graphics for mobile phones; telephone ring tones [downloadable]; apparatus for controlling static electricity.

10 – Surgical instruments and apparatus; electric massage apparatus for household purposes; foot massage equipment; electric massage armchairs; electric nasal irrigators; esthetic massage apparatus; blood oxygen monitors; glucometers; oxygen concentrators for medical purposes; medical devices for moxibustion therapy; vibromassage apparatus; testing apparatus for medical purposes; pulse meters; nanorobots for medical purposes; oral irrigators for use in dentistry; prosthetic instruments for dental purposes; dental apparatus and instruments; lasers for cosmetic purposes; blood pressure monitors; lasers for medical purposes; physiotherapy apparatus; heart rate monitoring apparatus; LED masks for therapeutic purposes; air pillows for medical use; ear plugs [ear protection devices]; hearing aids; hearing protectors; soporific pillows for insomnia; sanitary masks for medical purposes; bracelets for medical purposes; biomagnetic rings for therapeutic or medical purposes; feeding bottles; pacifiers for babies; baby feeding dummies; contraceptive apparatus; sex toys; artificial limbs; abdominal belts; wheeled walkers to aid mobility; orthopaedic belts; orthopedic articles; elastic stockings for surgical purposes; compression garments; thread, surgical; ear thermometers; artificial surgical implants; wearable walking assistive robots for medical purposes; back supports for medical purposes; teething rings; breast pumps; massage apparatus; medical apparatus and instruments; sphygmotensimeters; suture materials; dental apparatus, electric; fumigation apparatus for medical purposes; contraceptives, non-chemical; thermometers for medical purposes; electric acupuncture instruments; body composition monitors; surgical robots.

11 – Lights for automobiles; lamps for directional signals for automobiles; anti-dazzle devices for automobiles [lamp fittings]; lanterns for lighting; electric lamps; electric torches; light bulbs; ultraviolet ray lamps, not for medical purposes; curing lamps, not for medical purposes; flaming torches; electrical rice cookers; kettles, electric; electromagnetic induction cookers; pressure cookers, electric; gas burners; microwave ovens [cooking apparatus]; autoclaves, electric, for cooking; roasting apparatus; air fryers; electric baking pan; electric egg boilers; electrically-heated mugs; food steamers, electric; steam oven; electric toasters [for household purposes]; coffee roasters; cooking utensils, electric; cooking stoves; bread toasters; kitchen ranges [ovens]; heaters, electric, for feeding bottles; deep fryers, electric; bread-making machines; USB-powered cup heaters; soya milk making machines, electric; lava rocks for use in barbecue grills; refrigerating apparatus and machines; ice ma-

chines and apparatus; heating and cooling apparatus for dispensing hot and cold beverages; ice-cream making machines; ventilation [air-conditioning] installations and apparatus; laundry dryers, electric; extractor hoods for kitchens; fans [air-conditioning]; air conditioners; humidifiers; fabric steamers; air purifiers; fan heater; air-conditioning installations; air filtering installations; desiccating apparatus; dehumidifiers; preheaters for automobile engine; air conditioners for automobiles; air purifiers for automobiles; heating apparatus; fog machines; taps; radiators [heating]; sanitary apparatus and installations; toilets [water-closets]; steam facial apparatus [saunas]; hydromassage bath apparatus; electric hot air hand dryers; heaters for baths; heating lamps for bath; bath installations; water purifying apparatus and machines; electric hot water dispensers; filters for water purifiers; water purifiers; electric sterilizers for feeding bottles; disinfectant apparatus; pocket warmers; coffee machines, electric; electrical coffee pots incorporating percolators; gas scrubbing apparatus; air sterilizers; air purifying apparatus and machines; induction water heaters; filters for drinking water; electric kettles [for household purposes]; filters for air conditioning.

12 – Vehicles for locomotion by land, air, water or rail; rearview mirrors; driverless cars [autonomous cars]; self-driving cars; go-karts; automatic guided vehicles; propulsion mechanisms for land vehicles; automobile hoods; automobile chains; automobile chassis; vehicle running boards; cars; automobile bodies; bumpers for automobiles; shock absorbers for automobiles; signal arms for vehicles; air bags [safety devices for automobiles]; brake pads for automobiles; cigar lighters for automobiles; ashtrays for automobiles; lug nuts for vehicle wheels; clips adapted for fastening automobile parts to automobile bodies; automobile wheel hubs; warning horns for automobiles; air pumps for automobiles; safety seats for use in cars; automobile spare wheel holders; electric motors for motor cars; axles and cardan shaft for motor vehicles; wheel rims [for automobiles]; windscreen wipers [for automobiles]; clutch mechanisms for motor cars; safety seats for children for motor cars; automobile windshields [windcreens]; sun visors for automobiles; rearview mirrors for automobiles; direction signals for automobiles; doors for automobiles; spokes for automobiles; suspension springs for motor cars; petrol tank caps for motor cars; gearboxes for motor cars; mudguards for automobiles; wheel rims for automobiles; motor car seats; safety belts for vehicles; head rests for seats for motor cars; steering wheels for automobiles; anti-theft devices for motor cars; electric cars; torque converters for motor cars; automotive interior trim; motor car windows; automobile roof racks; automobile roof containers; luggage racks for motor cars; automobile dashboards; fuel tanks [parts of land vehicles]; protective rings for automobile wheel hubs; automobile engines; fitted vehicle covers for automobiles; shaped covers for motor cars; stee-

ring wheel spinners for automobiles; steering wheel covers for automobiles; sunroofs for automobiles; automobile radiator grills; license plate frames for automobiles; brakes for automobiles; body panels for vehicles; push scooters [vehicles]; self-balancing electric unicycles; electric bicycles; self balancing electric scooters; self-balancing scooters; aerial conveyors; carts; wheelchairs; sleighs [vehicles]; automobile tyres; inner tubes for automobile tires; aeronautical apparatus, machines and appliances; delivery drones; air vehicles; boats; diving bells; seat covers for vehicles; upholstery for vehicles; anti-theft devices for vehicles; side view mirrors for vehicles; anti-dazzle devices for vehicles; windshield wipers; anti-glare devices for vehicles; head-rests for vehicle seats; air pumps for motorcycles; electrically powered scooters [vehicles].

14 – Precious metals, unwrought or semi-wrought; boxes of precious metal; key chains of precious metal; works of art of precious metal; figurines of precious metal; jade carving artworks; medals; prize cups of precious metals; rings [jewellery]; jewellery, including imitation jewellery and plastic jewellery; watches; watch bands; clocks and watches, electric; presentation boxes for watches; clocks.

15 – Musical instruments; stringed musical instruments; horns [musical instruments]; tuners for musical instruments; bags specially adapted for holding musical instruments; musical boxes; straps for musical instruments; mutes for musical instruments; electronic musical instruments; stands for musical instruments.

16 – Paper for bags and sacks; copying paper [stationery]; papers for painting and calligraphy; towels of paper; paper coasters; kitchen paper; packing cardboard; signboards of paper or cardboard; envelopes; calendars; decorative stickers for cars; printed publications; posters; books; periodicals; pictures; boxes of paper or cardboard; garbage bags of paper or of plastics; stapling presses [office requisites]; paper shredders for office use; ink; inkstands; inkpad; pens [office requisites]; writing materials; adhesives [stationery]; pantographs [drawing instruments]; typewriters, electric or non-electric; typewriter ribbons; blackboards; small blackboards; pen ink refills; drawing materials for blackboards; staplers; Indian inks; seals [stationery]; drawing materials; laser printing paper; stickers; rollerball pens; architects' models; note books; toilet paper; inking ribbons; office requisites, except furniture; apparatus for mounting photographs; bags [envelopes, pouches] of paper or plastics, for packaging; newsletters; children's books incorporating electronic audible device.

18 – Leather, unworked or semi-worked; bags; wallets; rucksacks; trunks [luggage]; shopping bags; school bag for children; leather trimmings for furniture; leather thongs; umbrellas; walking sticks; animal harnesses.

21 – Place mats, not of paper or textile; utensils for household purposes; kitchen utensils; tableware, other than knives, forks and spoons; bottle openers, electric and non-electric; coffee filters, non-electric; cooking pots; household glassware [including cups, plates, jugs and urns]; ceramics for household purposes; porcelain imitations; drinking vessels; thermally insulated cups; liqueur sets; tea sets; coffee sets; toilet utensils; deodorizing apparatus for personal use; drying racks for laundry; dispensers for liquid soap [for household purposes]; toothbrush holders; scalp scratchers; sieves [household utensils]; garbage cans; aromatic oil diffusers, other than reed diffusers, electric and non-electric; combs; brushes; electric brushes, except parts of machines; material for brush-making; heads for electric toothbrushes; toothbrushes; toothpicks; make-up removing appliances; thermally insulated containers for food; reusable ice cubes; ice cube moulds; cleaning instruments, hand-operated; gloves for household purposes; non-electric carpet cleaners; mop heads; cloths for cleaning; glass, unworked or semi-worked, except building glass; crystal [glassware]; mangers for animals; litter boxes for pets; electronic pet waterers; feeding vessels for pets; animal activated animal feeders; cages for household pets; indoor terrariums [plant cultivation]; indoor aquaria; electric devices for attracting and killing insects; plug-in diffusers for mosquito repellents; ultrasonic pest repellents; water apparatus for cleaning teeth and gums; appliances for removing make-up, electric; dusting cloths; cat litter trays; cosmetic utensils; lint removers, electric or non-electric.

24 – Fabric; fabric imitating animal skins; gummed cloth, other than for stationery purposes; non-woven textile fabrics; filtering materials of textile; brocade; printers' blankets of textile; cloths for removing make-up; sleeping bags; bed linen; tablemats of textile; curtains of textile or plastic; flags of textile or plastic; tablecloths, not of paper.

25 – Tee-shirts; coats; bath robes; babies' pants [underwear]; motorists' clothing; raincoats; sports shoes; headbands [clothing]; headwear; sweat-absorbent socks; riding gloves; neckties; girdles; chasubles; sleep masks.

28 – Apparatus for games; electronic games for the teaching of children; hand-held consoles for playing video games; kites; rocking horses; drones [toys]; toy robots; building blocks [toys]; stuffed toys; scooters [toys]; toys; scale model vehicles; carnival masks; dolls; toy figures; children's toy bicycles other than for transport; toys for domestic pets; manipulative puzzles; jigsaw puzzles; cube-type puzzles; radio controlled scale model vehicles; toy models; collectable toy figures; baby gyms; chess; pumps specially adapted for use with balls for games; rackets; body-building apparatus; running machines; archery implements; machines for physical exercises; skis; climbers' harness; gloves for games; knee guards [sports articles];

protective paddings [parts of sports suits]; swimming rings; ice skates; ornaments for Christmas trees, except lights, candles and confectionery; Christmas trees of synthetic material; twirling batons; battery operated toys; playing card; playing cards.

35 – Advertising; publicity material rental; rental of advertising space; rental of advertising time on communication media; advertising agency services; presentation of goods on communication media, for retail purposes; demonstration of goods; promotion of goods and services through sponsorship of sports events; organization of exhibitions for commercial or advertising purposes; providing business information; opinion polling; price comparison services; business research; public relations; commercial or industrial management assistance; commercial information and advice for consumers [consumer advice shop]; commercial administration of the licensing of the goods and services of others; marketing; import-export agency services; sales promotion for others; auctioneering; employment agency services; systemization of information into computer databases; arranging subscriptions to telecommunication services for others; administration of consumer loyalty programs.

36 – Providing insurance information; insurance brokerage; insurance underwriting; providing financial information; financial evaluation [insurance, banking, real estate]; hire-purchase financing; financial management; automobile lease financing; instalment loans; credit sale of land vehicle [hire-purchase financing]; loans [financing]; e-wallet payment services; art appraisal; real estate brokerage; surety services; charitable fund raising.

37 – Providing information relating to repairs; construction consultancy; plumbing; construction; mining extraction; cleaning of buildings; installation and repair of air-conditioning apparatus; electric appliance installation and repair; kitchen equipment installation; motor vehicle maintenance and repair; vehicle breakdown repair services; vehicle battery charging; safe maintenance and repair; tyre balancing; furniture maintenance; leather care, cleaning and repair; disinfecting; vermin exterminating, other than for agriculture, aquaculture, horticulture and forestry; telephone installation and repair; jewelry repair; repair of damaged computers; repair or maintenance of fire alarms; maintenance and repair of mobile phones; repair and maintenance of smartphones; cell phone battery charging services; telephone repair; advisory services relating to the installation of telephone equipment; repair or maintenance of industrial washing machines; repair or maintenance of telephone apparatus.

38 – News agency services; broadcasting of programmes via the internet; streaming of data; providing instant messaging services; communications by cellular phones; providing telecommunications connections to a global computer network; providing user ac-

cess to global computer networks; providing online forums; providing access to databases; electronic bulletin board services [telecommunications services]; telephone services; transmission of electronic mail; chatroom services for social networking; communications by computer terminals; rental of smartphones; webcasting services.

39 – Unloading cargo; providing traffic information; transport; passenger transport; vehicle breakdown towing services; automobile salvage; hired car transport; chauffeur driven car hire services; air transport; vehicle rental; rental of electric cars; garage rental; car rental; chauffeur services; car parking; parcel delivery; delivery of goods; travel information; travel reservation.

41 – Educational services; training services provided via simulators; arranging and conducting of colloquiums; organization of shows [impresario services]; organization of events for cultural purposes; organization of competitions [education or entertainment]; lending library services; providing online electronic publications, not downloadable; publication of books; publication of texts, other than publicity texts; providing online videos, not downloadable; video production; production of radio and television programmes; translation; subtitling; photography; providing television programmes, not downloadable, via video-on-demand services; providing online music, not downloadable; providing films, not downloadable, via video-on-demand services; game services provided online from a computer network; entertainment services; providing information in the field of entertainment; club services [entertainment or education]; virtual reality game services provided on-line from a computer network; conducting fitness classes; art exhibitions; providing museum facilities [presentation, exhibitions]; zoological garden services.

42 – Scientific research; technological research; quality testing; exploration services in the field of the oil, gas and mining industries; chemical research; weather forecasting; packaging design; design of telephones; design of mobile telephones; interior design; updating of computer software; maintenance of computer software; consultancy in the design and development of computer hardware; recovery of computer data; computer system analysis; computer system design; computer programming; updating of mobilephone software; mobilephone software design; recovery of smartphone data; unlocking of mobile phones; software as a service [SaaS]; development of computer platforms; hosting computer sites [web sites]; platform as a service [PaaS]; creating and maintaining web sites for others; cloud computing; electronic data storage; off-site data backup; server hosting; monitoring of computer systems by remote access; data encryption services; computer virus protection services; information technology [IT] consultancy; internet security consultancy; conversion of data or documents from physical

to electronic media; providing search engines for the internet; graphic design of promotional materials; business card design; rental of meters for the recording of energy consumption; computer network design for others; research and development of computer software.

45 – Monitoring of alarms; personal background investigations; escorting in society [chaperoning]; house sitting; clothing rental; conducting religious ceremonies; rental of life jackets; licensing of intellectual property; legal research; licensing of computer software [legal services]; licensing [legal services] in the framework of software publishing; licensing of registered designs [legal services]; legal services; providing information about legal services via a website.

---

(260) AM 2022 117637 A

(800) 1658303

(151) 2022 01 26

(891) 2022 01 26

(731) Avon Products, Inc.

1 Avon Place, Suffern NY 10901, USA

(540)

## PLANET SPA

(591) Black, white

(511)

4 – Candles; scented and unscented candles, including scented pillar candles, scented tea light candles and scented filled candles; scented candle gift sets; scented candles incorporating candle plates and holders; scented candle gift sets incorporating scented candles in glass, wood and metal containers and candle plates; candle gardens [candles] incorporating scented candles in glass, wood and metal containers and candle plates together with coloured and white rocks.

---

(260) AM 2022 117671 A

(800) 1658917

(151) 2022 02 28

(891) 2022 02 28

(731) CORDIER

1 rue de la Seiglière, F-33800 BORDEAUX,  
France

(540)

## CORDIER

(591) Black, white

(511)

32 – Beers, mineral and carbonated waters and other non-alcoholic beverages, particularly whey-based beverages; non-alcoholic beverages optionally consisting of milk; isotonic beverages; lemonades; fruit beverages and fruit juices; tomato juice; vegetable juices (beverages); syrups for beverages; preparations for making beverages (except tea-based, coffee-based, or cocoa-based, milk beverages); pastilles and powders

for effervescing beverages; essences for making beverages; non-alcoholic essences for making beverages, non-alcoholic beverages namely de-alcoholized wine-based beverages, non-alcoholic aperitifs and cocktails; non-alcoholic beverages obtained by de-alcoholizing wine and flavored non-alcoholic beverages based on de-alcoholized wine.

43 – Provision of food and beverages (meals); self-service restaurants; snack bars; restaurant, cafe and bar services; cafeterias, canteens; catering services; temporary accommodation; accommodation agencies (hotels, boarding houses); hotel services; motel services; hotel, boarding house and temporary accommodation reservation services; holiday camp services (lodging); holiday homes; providing campground facilities; day-nurseries [crèches]; retirement homes; boarding for animals; rental of chairs, tables, table linen and glassware; rental of transportable buildings; rental of temporary accommodation; rental of meeting rooms; rental of tents.

---

(260) AM 2022 117672 A

(800) 1658937

(151) 2021 11 15

(891) 2021 11 15

(731) Apple Inc.

One Apple Park Way, Cupertino CA 95014,  
USA

(540)

## ICLOUD+

(591) Black, white

(511)

35 – Computerized database and file management; data processing services; providing business and commercial information over computer networks and global communication networks; compilation of directories for publishing on the Internet and other electronic, computer and communications networks.

38 – Telecommunications, namely, electronic transmission and retrieval of data, images, audio, video and documents, including text, messages, and electronic mail, over local or global communications networks, including the internet, intranets, extranets, mobile communication, cellular and satellite networks; communications by computer terminals; communication between computer terminals; electronic transmission of streamed and downloadable audio and video files via computer and other communications networks; delivery of messages by electronic transmission; electronic mail services; streaming of video materials via a global computer network; electronic transmission of audio and video files via communications networks.

40 – Film processing and photofinishing; photographic film developing; information, advisory and consultancy services relating to all the aforesaid.

41 – Educational services; providing entertainment information about uploading, storing, sharing, viewing and posting of images, audio, videos, online journals, blogs, podcasts, and multimedia content via a website; publication of books, periodicals, newspapers, newsletters, manuals, blogs, journals, and other publications; providing educational and entertainment information relating to books, periodicals, newspapers, newsletters, manuals, blogs, journals, and other publications via a website and computer applications; news reporting; electronic and online library services.

42 – Electronic data storage; electronic data storage for text, images, audio, and video; providing online non-downloadable software used to provide sharing and the synchronization of data.

(260) AM 2022 117673 A

(800) 1658986

(151) 2021 11 09

(891) 2021 11 09

(731) Otkrytoe Aktsionerное Obschestvo "Valuisky kombinat rastitelnykh masel"  
ul. Nikolskaya, 119, Valuiki, RU-309992  
Belgorod Oblast, Russian Federation

(540)



(591) Black, white, green and dark-green

(531) 26.01.04; 26.01.24; 26.02.07; 26.11.12;  
26.13.25; 27.05.01; 27.05.09; 29.01.13

(511)

5 – Nutritional supplements; albumin dietary supplements; protein dietary supplements; dietetic beverages adapted for medical purposes; albuminous preparations for medical purposes; dietetic foods adapted for medical purposes; protein powder dietary supplements.

29 – Soups.

30 – Salad seasonings; high-protein cereal bars; protein-chocolate paste.

32 – Cocktails, non-alcoholic; protein-enriched sports beverages.

(260) AM 2022 117697 A

(800) 1659706

(151) 2022 03 22

(891) 2022 03 22

(731) Engelhard Arzneimittel GmbH & Co. KG  
Herzbergstraße 3, 61138 Niederdorfelden,  
Germany

(540)

**ISLA**

(591) Black, white

(511)

5 – Medicinal products, chemical products for medical use, pharmaceutical drugs and preparations, disinfectants, dietetic foodstuffs and food supplements for medical purposes, pharmaceutical and veterinary preparations; sanitary preparations for medical purposes; food for babies.

(260) AM 2022 117698 A

(800) 1659709

(151) 2021 12 09

(891) 2021 12 09

(731) PRIVATE JOINT-STOCK COMPANY,  
"VENTILATION SYSTEMS"  
Vul. M. Kotsiubynskoho, 1, m. Kyiv 01030,  
Ukraine

(540)



(591) Black, white

(531) 05.05.20; 05.07.11; 05.07.12; 05.07.22;  
15.01.13; 26.11.02; 26.11.06; 26.11.12;  
26.13.25

(511)

6 – Reinforcing materials of metal for pipes; hardware of metal, small; water-pipes of metal; gutter pipes of metal; sleeves [metal hardware]; street gutters of metal; accordion doors of metal; folding doors of metal; swing doors of metal; chimney cowls of metal; chimneys of metal; chimney shafts of metal; drain pipes of metal; жалюзи of metal; plugs of metal; hoop iron; outdoor blinds of metal; clips of metal for cables and pipes; junctions of metal for pipes; water-pipe valves of metal; drain traps [valves] of metal; valves of metal, other than parts of machines; chimney pots of metal; manifolds of metal for pipelines; elbows of metal for pipes; pipe muffs of metal; penstock pipes of metal; casings of metal for oilwells; branching pipes of metal; fireplace grates of metal; grilles of metal; furnace fireguards of metal; ducts of metal for ventilating and air-conditioning installations; ducts of metal, for central heating installations / ducts and pipes of metal for central heating installations; pipes of metal; steel pipes; pipework of metal; fittings of metal for compressed air lines.

7 – Vacuum pumps [machines]; fans for motors and engines; centrifugal pumps; suction machines for industrial purposes; motors, other than for land vehicles;

flues for engine boilers; feeders [parts of machines]; feeding apparatus for engine boilers; valves [parts of machines]; compressors [machines]; compressors for refrigerators; steam condensers [parts of machines]; condensing installations; pumps [machines]; pumps [parts of machines, engines or motors]; pumps for heating installations; fittings for engine boilers; steam engines; fan belts for motors and engines; air suction machines; blowing machines; fans for the compression, sucking and carrying of grain; blowing machines for the compression, exhaustion and transport of gases; air condensers; air pumps [garage installations]; boiler tubes [parts of machines]; filters for cleaning cooling air, for engines; filters being parts of machines or engines; filter presses; filtering machines.

11 – Steam accumulators; heat accumulators; hot air apparatus; air deodorizing apparatus; ionization apparatus for the treatment of air or water; air cooling apparatus; desiccating apparatus; drying apparatus for fodder and forage; hand drying apparatus for washrooms; air purifying apparatus and machines; fans [air-conditioning]; fans [parts of air-conditioning installations]; electric fans for personal use; ventilation [air-conditioning] installations for vehicles; ventilation [air-conditioning] installations and apparatus; extractor hoods for kitchens; ventilation hoods; ventilation hoods for laboratories; pipes [parts of sanitary installations]; disinfectant apparatus; disinfectant apparatus for medical purposes; deodorizing apparatus, not for personal use; chimney flues; flues for heating boilers; safety accessories for water or gas apparatus and pipes; humidifiers; coils [parts of distilling, heating or cooling installations]; air valves for steam heating installations; furnace grates; air conditioners for vehicles; taps for pipes and pipelines; mixer taps for water pipes; boilers, other than parts of machines; steam boilers, other than parts of machines; cooling appliances and installations; air-conditioning apparatus; air sterilizers; thermostatic valves [parts of heating installations]; pipes [parts of sanitary installations]; boiler pipes [tubes] for heating installations; air-conditioning installations; filters for air conditioning.

19 – Water-pipes, not of metal; roof gutters, not of metal; gutter pipes, not of metal; street gutters, not of metal; accordion doors, not of metal; folding doors, not of metal; swing doors, not of metal; chimney shafts, not of metal; lengthening pieces, not of metal, for chimneys; drain pipes, not of metal; jalousies, not of metal; water-pipe valves, not of metal or plastic; drain traps [valves], not of metal or plastic; chimney pots, not of metal; penstock pipes, not of metal; branching pipes, not of metal; ducts, not of metal, for ventilating and air-conditioning installations; rigid pipes, not of metal, for building.

(260) AM 2022 117699 A  
 (800) 1659725  
 (151) 2021 11 19  
 (891) 2021 11 19  
 (731) LTD "VALENTA-INTELLEKT"  
 ul. Ryabinovaya, d.26, str.10, k.6-26,  
 RU-121471 Moscow, Russian Federation

(540)

**ОМЕГАМАМА**

(591) Black, white

(531) 28.05

(511)

5 – Antibiotics; germicides; balms for medical purposes; dietetic substances adapted for medical use; vitamin preparations; veterinary preparations; mineral waters for medical purposes; mustard plasters; sanitary preparations for medical purposes; mineral food supplements; food supplements for medical purposes; yeast for pharmaceutical purposes; candy for medical purposes; acids for pharmaceutical purposes; medicated sweets; medicinal roots; starch for dietetic or pharmaceutical purposes; milk sugar for pharmaceutical purposes; medicines for human purposes; lecithin for medical purposes; adhesive plasters; liniments; medicinal oils; dressings, medical; drugs for medical purposes; medicines for veterinary purposes; milk ferments for pharmaceutical purposes; medicinal drinks; dietetic beverages adapted for medical purposes; medicinal infusions; tinctures for medical purposes; albuminous preparations for medical purposes; preparations of trace elements for human and animal use; pharmaceutical preparations; chemico-pharmaceutical preparations; chemical preparations for pharmaceutical purposes; chemical preparations for veterinary purposes; chemical preparations for medical purposes; albuminous foodstuffs for medical purposes; food for babies; dietetic foods adapted for medical purposes; by-products of the processing of cereals for dietetic or medical purposes; syrups for pharmaceutical purposes; antiseptics; anaesthetics; disinfectants for hygiene purposes; febrifuges; tonics [medicines]; medical preparations for slimming purposes; medicinal herbs; sedatives; enzymes for veterinary purposes; enzymes for medical purposes; ferments for pharmaceutical purposes; herbal teas for medicinal purposes; elixirs [pharmaceutical preparations].

(260) AM 2022 117700 A  
 (800) 1659726  
 (151) 2022 01 11  
 (891) 2022 01 11  
 (731) Chekhlov Aleksei Gennad'evich  
 Dachnaya str., d. 9B, dp dsk "Michurinec",  
 RU-142784 Moscow, Russian Federation

(540)

**neogalen – вены в порядке**

(591) Black, white

(531) 28.05

(511)

3 – Balms, other than for medical purposes; cosmetics, including beauty gels, cosmetic creams, beauty masks, oils for cosmetic purposes, mousses [cosmetics], lotions for cosmetic purposes, skin exfoliants, facial emulsions for cosmetic purposes, body emulsions for cosmetic purposes, beauty milk; cosmetics for use on the skin; cosmetics for personal use; cosmetics and toiletries; massage gels, other than for medical purposes; essential oils; cosmetic kits; pre-moistened cosmetic wipes; cleaning pads impregnated with cosmetics; bath salts, not for medical purposes; cosmetic preparations for baths.

(260) AM 2022 117701 A

(800) 1659796

(151) 2021 12 23

(891) 2021 12 23

(731) J.M. HUBER CORPORATION

3100 Cumberland Blvd., Suite 600, Atlanta GA  
30339, USA

(540)



(591) Black, white

(531) 26.01.03; 26.01.21; 26.01.22; 27.01.01;  
27.05.01

(511)

1 – Chemicals for use in industry, science and photography, as well as in agriculture, horticulture and forestry; unprocessed artificial resins, unprocessed plastics; fire extinguishing and fire prevention compositions and smoke suppressant chemicals; fertilizers; biological preparations for use in industry and science; fillers and filtering materials for use in industry and science.

2 – Pigments.

(260) AM 2022 117793 A

(800) 1443392

(151) 2018 06 21

(891) 2022 04 22

(731) Dr. Vranjes Firenze S.p.A.

Via Sandro Pertini, 5, Frazione Antella,  
I-50012 Bagno a Ripoli (FI), Italy

(540)



DR. VRANJES

(591) Black, white

(531) 05.05.02; 05.05.20; 24.01.15; 24.01.25;  
27.05.01

(511)

3 – Bleaching preparations and other substances for laundry use; cleaning, polishing, scouring and abrasive preparations; soap; perfumery; essential oils; cosmetics; hair care lotions; dentifrices; scented oils; fragrance sachets; scented soaps; perfumed creams; perfumed tissues; amber [perfume]; musk [perfumery]; vanilla perfumery; aromatics for perfumes; air fragrancing preparations; extracts of perfumes; potpourris [fragrances]; scented room sprays; scented ceramic stones; scented linen sprays; potpourri sachets for incorporating in aromatherapy pillows; natural essential oils; oils for perfumes and scents; scented bathing salts; perfumed powder [for cosmetic use]; extracts of flowers [perfumes]; cleaning and fragrancing preparations; scented body spray; sachets for perfuming linen; scented fabric refresher sprays; scented oils for skin care; scented oils used to produce aromas when heated; scented body lotions and creams; essential oils for use in the manufacture of scented products; perfume oils for the manufacture of cosmetic preparations; perfumed body lotions [toilet preparations]; exfoliant creams; make-up removing creams; cosmetic creams; washing creams; cleansing creams; hair creams; night cream; day creams; eye cream; body cream; cosmetic nourishing creams; toners for cosmetic use; facial peel preparations for cosmetic use; facial scrubs [cosmetic]; bath lotion; cosmetic facial lotions; fragrances for automobiles; fragrance refills for non-electric room fragrance dispensers; refills for electric room fragrance dispensers; reed diffusers.

4 – Tapers; perfumed candles; candles for absorbing smoke; wicks for candles; aromatherapy fragrance candles; wax for making candles; candles and wicks for lighting; lamp wicks; wicks for oil lamps; lamp fuel; lamp oils; light oils; combustible waxes; illuminating wax; beeswax; lubricants; illuminating greases; general purpose grease; waxes; lighter fluids; beeswax for use in the manufacture of candles; wax [raw material]; combustible waxes; beeswax for use in the manufacture of cosmetics; beeswax for use in the manufacture of ointments.

35 – Advertising; business management; business administration; clerical services; commercial administration of the licensing of the goods and services of others; dissemination of advertisements; demonstration of goods; direct mail advertising; marketing; or-

ganization of exhibitions for commercial or advertising purposes; organization of trade fairs for commercial or advertising purposes; presentation of goods on communication media, for retail purposes; sales promotion for others; publication of publicity texts; on-line advertising on a computer network; television advertising; providing information and advice to consumers regarding the selection of products and items to be purchased; online retail services related to the following products, bleaching preparations and other substances for laundry use, cleaning, polishing, scouring and abrasive preparations, soap, perfumery, essential oils, cosmetics, hair care lotions, dentifrices, scented oils, fragrance sachets, scented soaps, perfumed creams, perfumed tissues, amber [perfume], musk [perfumery], vanilla perfumery, aromatics for perfumes, air fragrancing preparations, extracts of perfumes, potpourris [fragrances], scented room sprays, scented ceramic stones, scented linen sprays, cushions filled with perfumed substances, natural essential oils, oils for perfumes and scents, scented bathing salts, perfumed powder [for cosmetic use], extracts of flowers [perfumes], cleaning and fragrancing preparations, scented body spray, sachets for perfuming linen, cushions impregnated with perfumed substances, scented fabric refresher sprays, scented oils for skin care, scented oils used to produce aromas when heated, scented body lotions and creams, essential oils for use in the manufacture of scented products, perfume oils for the manufacture of cosmetic preparations, perfumed body lotions [toilet preparations], exfoliant creams, make-up removing creams, cosmetic creams, washing creams, cleansing creams, hair creams, night cream, day creams, eye cream, body cream, cosmetic nourishing creams, toners for cosmetic use, facial peel preparations for cosmetic use, facial scrubs [cosmetic], bath lotion, cosmetic facial lotions, fragrances for automobiles, fragrance refills for non-electric room fragrance dispensers, refills for electric room fragrance dispensers, reed diffusers, tapers, perfumed candles, candles for absorbing smoke, wicks for candles, aromatherapy fragrance candles, wax for making candles, candles and wicks for lighting, lamp wicks, wicks for oil lamps, lamp fuel, lamp oils, light oils, combustible waxes, illuminating wax, beeswax, lubricants, illuminating greases, general purpose grease, waxes, lighter fluids, beeswax for use in the manufacture of candles, wax [raw material], combustible waxes, beeswax for use in the manufacture of cosmetics, beeswax for use in the manufacture of ointments

(260) AM 2022 117796 A  
 (800) 1602299  
 (151) 2021 04 27  
 (891) 2022 04 26  
 (731) Massimo Meneghetti  
 Via Ca' Dolfin 241, I-36061 Bassano del  
 Grappa (VI), Italy

(540)

## TABLESWIN

(591) Black, white

(511)

9 – Electronic components for gambling machines; electronic indicator panels; score recorders [electronic]; battery chargers; computer application software featuring games and gaming.

20 – Counters [tables]; tables [furniture]; occasional tables; seat cushions; chair pads; seats; footstools; furniture fittings, not of metal; furniture; textile covers [shaped] for furniture; multi-purpose stands [furniture].

24 – Fabric for gaming tables.

28 – Board games; roulette tables; air hockey tables; foosball tables; billiard tables; billiard tables; billiard table cushions; tables for table tennis; nets for billiard tables; pool bumpers; electronic amusement apparatus incorporating a liquid crystal display; joysticks for video games; apparatus for electronic games adapted for use with an external display screen or monitor; LCD game machines; playing cards; chips for gambling; card shuffling machines; gaming machines for gambling; playing card shuffling device; automatic gaming machines.

(260) AM 2022 117874 A

(800) 1662248

(151) 2021 11 30

(891) 2021 11 30

(731) fischerwerke GmbH & Co. KG  
 Klaus-Fischer-Straße 1, 72178 Waldachtal,  
 Germany

(540)

## fischer

(591) Black, white

(511)

19 – Building materials (non-metallic), including fire-proof building materials, in particular for construction of fire protection bulkheads and plates; self-hardening mortar, in particular for the anchoring of fastening elements; Expanding foam; Mounting foams for building, including in the form of fireproof substances; Mortar, Artificial resin mortar; Mineral mortar; Cements.

(260) AM 2022 117875 A

(800) 1662285

(151) 2022 02 11

(891) 2022 02 11

(731) BTL Industries  
 8 Tzar Kaloyan str, BG-1000 Sofia,  
 Bulgaria



(540)

**EMMASK**

(591) Black, white

(511)

10 – Medical apparatus generating electromagnetic, magnetic, electrical, mechanical, radiofrequency or thermal energy for use in skin treatment procedures; medical apparatus and instruments for body toning and body shaping; medical apparatus and instruments for the removal of fat, circumference reduction, tightening of skin, reduction of wrinkles, reduction of scars, reduction of stretch marks, rejuvenation of skin, treatment of pigmentation spots, increase in muscle volume, increase in number of muscle fibres and increase in muscle tonus; medical apparatus and instruments for the treatment of cellulite; therapeutic facial masks; facial toning machines for cosmetic use; medical apparatus particularly apparatus for pain management, elimination of muscle spasms; gynecological and urological apparatus and instruments, namely, for genital rejuvenation, treatment sexual dysfunction, gynecological treatment and pelvic floor treatment.

(260) AM 2022 117876 A

(800) 1662286

(151) 2022 02 11

(891) 2022 02 11

(731) BTL Industries

8 Tzar Kaloyan str, BG-1000 Sofia, Bulgaria

(540)

**BTL ONE**

(591) Black, white

(511)

10 – Medical apparatus generating electromagnetic, magnetic, electrical, mechanical, radiofrequency or thermal energy for use in skin treatment procedures; medical apparatus and instruments for body toning and body shaping; medical apparatus and instruments for the removal of fat, circumference reduction, tightening of skin, reduction of wrinkles, reduction of scars, reduction of stretch marks, rejuvenation of skin, treatment of pigmentation spots, increase in muscle volume, increase in number of muscle fibres and increase in muscle tonus; medical apparatus and instruments for the treatment of cellulite; massage apparatus for use in lymphatic drainage and to increase circulation of body fluids; therapeutic facial masks, facial toning machines for cosmetic use; medical apparatus particularly apparatus for pain management, elimination of muscle spasms; gynecological and urological apparatus and instruments, namely, for genital rejuvenation, treatment sexual dysfunction, gynecological treatment and pelvic floor treatment.

(260) AM 2022 117878 A

(800) 1662410

(151) 2021 11 22

(891) 2021 11 22

(731) "Holding company Varton" Limited Liability Company

Dorogobuzhskaya ul., d. 14, str. 6, et/pom 2/7, RU-121354 Moskva, Russian Federation

(540)

**BAPTOH**

(591) Black, white

(531) 28.05

(511)

6 – Aluminium; fittings of metal for compressed air lines; fittings of metal for building; white metal; beacons of metal, non-luminous; vats of metal; beams of metal; joists of metal; bottles [containers] of metal for compressed gas or liquid air; balustrades of metal; preserve tins; swimming pools [structures] of metal; arbours [structures] of metal; blooms [metallurgy]; ingots of common metal; anchors; bolts of metal; eye bolts; casks of metal; mooring buoys of metal; barrels of metal; identification bracelets of metal; bronze; bells; bells for animals; letters and numerals of common metal, except type; silos of metal; busts of common metal; vanadium; bird baths [structures] of metal; valves of metal, other than parts of machines; screws of metal; aviaries [structures] of metal; tungsten; hoppers of metal, non-mechanical; gates of metal; sleeves [metal hardware]; ferrules of metal for handles; signboards of metal; diving boards of metal; loading gauge rods of metal for railway wagons; nuts of metal; galena [ore]; celtium [hafnium]; nails; tacks [nails]; horseshoe nails; shoe pegs of metal; germanium; vice claws of metal; armoured doors of metal; doors of metal; folding doors of metal; swing doors of metal; chimney pots of metal; door closers of metal, non-electric; memorial plates of metal; chimney shafts of metal; wall plugs of metal; troughs of metal for mixing mortar; packaging containers of metal; containers of metal for storing acids; jalousies of metal; outdoor blinds of metal; iron strip; roof gutters of metal; street gutters of metal; tinplate; iron slabs; door bolts of metal; window fasteners of metal; bolts, flat; clips of metal for sealing bags; binding screws of metal for cables; cramps of metal [crampons]; wheel clamps [boots]; rivets of metal; box fasteners of metal; locks of metal for bags; locks of metal for vehicles; locks of metal, other than electric; spring locks; closures of metal for containers; plugs of metal; latches of metal; tension links; couplings of metal for chains; road signs, non-luminous and non-mechanical, of metal; registration plates of metal; signs, non-luminous and non-mechanical, of metal; fences of metal; buckles of common metal [hardware]; bronzes [works of art]; works of art of common metal; ironmongery; indium; cabanas of metal; soundproof booths of metal, tran-

sportable; telephone booths of metal; cadmium; paint spraying booths of metal; trolley cables; ropes of metal; jerrycans of metal; horticultural frames of metal; greenhouse frames of metal; framework of metal for building; cornices of metal; skating rinks [structures] of metal; cermets; water-pipe valves of metal; drain traps [valves] of metal; metal cages for wild animals; keys of metal; mooring bollards of metal; cobalt, raw; chill-moulds [foundry]; elbows of metal for pipes; bed casters of metal; furniture casters of metal; manifolds of metal for pipelines; casings of metal for oilwells; pillars of metal for building; chimney cowls of metal; bottle caps of metal; sealing caps of metal; tent pegs of metal; pegs of metal; copper rings; split rings of common metal for keys; rings of metal; door fittings of metal; fittings of metal for windows; brackets of metal for building; buildings of metal; buildings, transportable, of metal; steel buildings; oil drainage containers of metal; containers of metal [storage, transport]; check rails of metal for railways; baskets of metal; door frames of metal; tool boxes of metal, empty; stringers [parts of staircases] of metal; taps of metal for casks; tubing of metal; brackets of metal for furniture; roofing of metal; roofing of metal, incorporating photovoltaic cells; turntables [railways]; screw tops of metal for bottles; manhole covers of metal; hooks [metal hardware]; pitons of metal; pot hooks of metal; hooks of metal for roofing slates; sash fasteners of metal for windows; hooks of metal for clothes rails; bag hangers of metal; clothes hooks of metal; chicken-houses of metal; chests of metal; bands of metal for tying-up purposes; scaffolding of metal; staircases of metal; ladders of metal; limonite; steel sheets; cast steel; traps for wild animals; magnesium; manganese; reinforcing materials, of metal, for concrete; reinforcing materials of metal for machine belts; reinforcing materials of metal for pipes; reinforcing materials of metal for building; railway material of metal; materials of metal for funicular railway permanent ways; building materials of metal; refractory construction materials of metal; masts of metal; steel masts; sheets and plates of metal; common metals, unwrought or semi-wrought; pyrophoric metals; metals in powder form; mouldings of metal for building; molybdenum; metal knockers; pipe muffs of metal; shoe dowels of metal; porches [structures] of metal; bronzes for tombstones; tombs of metal; flashing of metal for building; roof flashing of metal; fish plates [rails]; anvils; anvils [portable]; beak-irons; rope thimbles of metal; ferrules of metal for walking sticks; handcuffs; jets of metal; duckboards of metal; belt stretchers of metal; stretchers for metal bands [tension links]; wire stretchers [tension links]; stretchers for iron bands [tension links]; nickel silver; nickel; niobium; grease nipples; binding thread of metal for agricultural purposes; thread of metal for tying-up purposes; braces of metal for handling loads; wall claddings of metal for building; mouldings of metal for cornices; enclosures of metal for tombs; laths of metal; barrel hoops of metal;

wall linings of metal for building; palings of metal; crash barriers of metal for roads; tree protectors of metal; latticework of metal; door stops of metal; stops of metal; window stops of metal; windows of metal; ironwork for doors; ironwork for windows; tin; shuttering of metal for concrete; filings of metal; posts of metal for power lines; props of metal; branching pipes of metal; monuments of metal; monuments of metal for tombs; metal ramps for use with vehicles; acoustic panels of metal; wainscoting of metal; signalling panels, non-luminous and non-mechanical, of metal; building panels of metal; partitions of metal; lintels of metal; casement windows of metal; strap-hinges of metal; shims; rocket launching platforms of metal; platforms, prefabricated, of metal; floor tiles of metal; tiles of metal for building; anchor plates; grave slabs of metal; tile floorings of metal; lead seals; loading pallets of metal; handling pallets of metal; trays of metal; stakes of metal for plants or trees; firedogs [andirons]; armour-plating of metal; paving blocks of metal; roof coverings of metal; cladding of metal for building; linings of metal for building; fireplace mantles of metal; steel strip; floors of metal; sills of metal; bathtub grab bars of metal; ceilings of metal; brazing alloys; gold solder; silver solder; collars of metal for fastening pipes; floating docks of metal, for mooring boats; aluminium wire; iron wire; wire of common metal; wire of common metal alloys, except fuse wire; barbed wire; copper wire, not insulated; soldering wire of metal; steel wire; springs [metal hardware]; rods of metal for welding; rods of metal for brazing; peeled metal bars; drawn and polished metal bars; bright steel bars; dispensers for dog waste bags, fixed, of metal; window frames of metal; frames of metal for building; crucifixes of common metal, other than jewellery; containers of metal for liquid fuel; containers of metal for compressed gas or liquid air; tanks of metal; floating containers of metal; rails of metal; straps of metal for handling loads; furnace fireguards of metal; gratings of metal; runners of metal for sliding doors; iron ores; ores of metal; chrome ores; door handles of metal; knobs of metal; sheet piles of metal; pigsties of metal; safes [metal or non-metal]; safes, electronic; insect screens of metal; burial vaults of metal; door scrapers; junctions of metal for pipes; nozzles of metal; anti-friction metal; silver-plated tin alloys; alloys of common metal; sheaf binders of metal; bindings of metal; shutters of metal; steel alloys; tinfoil; statues of common metal; cask stands of metal; tombstone stelae of metal; bars for metal railings; stables of metal; advertisement columns of metal; posts of metal; telegraph posts of metal; railway points; steps [ladders] of metal; slings of metal for handling loads; stair treads [steps] of metal; machine belt fasteners of metal; tombstone plaques of metal; nameplates of metal; tantalum [metal]; titanium; wire cloth; tombac; mobile boarding stairs of metal for passengers; wire rope; pipework of metal; penstock pipes of metal; water-pipes

of metal; gutter pipes of metal; ducts of metal for ventilating and air-conditioning installations; drain pipes of metal; chimneys of metal; pipes of metal; ducts of metal, for central heating installations; steel pipes; angle irons of metal; tinplate packings; door fasteners of metal; bicycle parking installations of metal; window closers of metal, non-electric; door openers of metal, non-electric; window openers of metal, non-electric; wind-driven bird-repelling devices made of metal; tungsten iron; molybdenum iron; silicon iron; titanium iron; chrome iron; figures of common metal; flagpoles [structures] of metal; hand-held flagpoles of metal; flanges of metal [collars]; weather- or wind-vanes of metal; aluminium foil; metals in foil or powder form for 3D printers; foils of metal for wrapping and packaging; ice moulds of metal; foundry moulds of metal; fittings of metal for coffins; fittings of metal for beds; fittings of metal for furniture; clips of metal for cables and pipes; chromium; cattle chains; chains of metal; safety chains of metal; zinc; zirconium; pantiles of metal; roofing tiles of metal; washers of metal; balls of steel; hinges of metal; poles of metal; safety cashboxes; pulleys of metal, other than for machines; window pulleys of metal; railway sleepers of metal; window casement bolts; cotter pins of metal; spurs; pins [hardware]; roller blinds of steel; latch bars of metal; badges of metal for vehicles; labels of metal; lock bolts; cashboxes [metal or non-metal]; tool chests of metal, empty; boxes of common metal; letter boxes of metal; reels of metal, non-mechanical, for flexible hoses; beryllium [glucinium]; prefabricated houses [kits] of metal; iron, unwrought or semi-wrought; door bells of metal, non-electric; crampons [climbing irons]; brass, unwrought or semi-wrought; copper, unwrought or semi-wrought; house numbers of metal, non-luminous; wall tiles of metal; paving slabs of metal; slabs of metal for building; transport pallets of metal; winding spools of metal, non-mechanical, for flexible hoses; hot-rolled steel bars; lead, unwrought or semi-wrought; cable joints of metal, non-electric; bottle closures of metal; steel, unwrought or semi-wrought; figurines of common metal; cast iron, unwrought or semi-wrought; turnstiles of metal; greenhouses of metal, transportable; cables of metal, non-electric.

7 – 3D printers; vending machines; welding machines, electric; soldering apparatus, gas-operated; vulcanization apparatus; acetylene cleaning apparatus; high pressure washers; apparatus for drawing up beer under pressure; apparatus for aerating water; apparatus for aerating beverages; electrical apparatus for sealing plastics [packaging]; electric arc cutting apparatus; electric arc welding apparatus; electric welding apparatus; inking apparatus for printing machines; fittings for engine boilers; expansion tanks [parts of machines]; drums [parts of machines]; reels, mechanical, for flexible hoses; brake shoes, other than for vehicles; concrete mixers [machines]; reels [parts of machines]; bobbins for weaving looms; harrows; journal boxes

[parts of machines]; bulldozers; hoppers [mechanical discharging]; mine borers; railway wagon lifts; rolling mill cylinders; crank shafts; printing rollers for machines; camshafts for vehicle engines; transmission shafts, other than for land vehicles; valves [parts of machines]; fans for motors and engines; saw benches [parts of machines]; winnowers; vibrators [machines] for industrial use; bearings [parts of machines]; water heaters being parts of machines; bellows [parts of machines]; agitators; drilling rigs, floating or non-floating; lawnmowers [machines]; card clothing [parts of carding machines]; nail extractors, electric; emergency power generators; alternators; dynamos; bicycle dynamos; current generators; generators of electricity; hydraulic controls for machines, motors and engines; mufflers for motors and engines; drilling heads [parts of machines]; drilling bits [parts of machines]; cylinder heads for engines; soldering blow pipes, gas-operated; gas-operated blow torches; raking machines; stalk separators [machines]; sieves [machines or parts of machines]; mud catchers and collectors [machines]; tarring machines; rubber tracks being parts of crawlers on mining machines; rubber tracks being parts of crawlers on snow ploughs; rubber tracks being parts of crawlers on loading-unloading machines and apparatus; rubber tracks being parts of crawlers on agricultural machines; rubber tracks being parts of crawlers on construction machines; hydraulic engines and motors; aeronautical engines; aeroplane engines; engines for air cushion vehicles; compressed air engines; jet engines, other than for land vehicles; engines for boats; driving motors, other than for land vehicles; motors, other than for land vehicles; propulsion mechanisms, other than for land vehicles; disintegrators; tympan [parts of printing presses]; holding devices for machine tools; turf removing ploughs; pump diaphragms; chisels for machines; jacks [machines]; rack and pinion jacks; moving walkways; electric hand drills; crushers for kitchen use, electric; flues for engine boilers; reapers; reapers and binders; millstones; rakes for raking machines; shredders [machines] for industrial use; kitchen grinders, electric; injectors for engines; incubators for eggs; ski edge sharpening tools, electric; hand-held tools, other than hand-operated; agricultural implements, other than hand-operated; air condensers; control cables for machines, engines or motors; capstans; calenders; rotary steam presses, portable, for fabrics; ditchers [ploughs]; carburettors; sliders for knitting machines; crankcases for machines, motors and engines; steamrollers; pressure valves [parts of machines]; clack valves [parts of machines]; pressure reducers [parts of machines]; cowlings [parts of machines]; machine wheels; freewheels, other than for land vehicles; scale collectors for machine boilers; lasts for shoes [parts of machines]; brake pads, other than for vehicles; piston segments; grease rings [parts of machines]; reapers and threshers; coal-cutting machines; compressors [machines]; air pumps [garage installations]; compressors for ref-

rigerators; conveyors [machines]; belt conveyors; converters for steelworks; steam condensers [parts of machines]; aerocondensers; diggers [machines]; rams [machines]; thermic lances [machines]; mechanized livestock feeders; boxes for matrices [printing]; gear boxes, other than for land vehicles; grease boxes [parts of machines]; housings [parts of machines]; harvesting machines; steam engine boilers; coffee grinders, other than hand-operated; taps [parts of machines, engines or motors]; cranes [lifting and hoisting apparatus]; roller bridges; mobile cranes; water separators; spray guns for paint; cranks [parts of machines]; potters' wheels; grindstones [parts of machines]; cultivators [machines]; soldering lamps; winches; ploughshares; belts for conveyors; lubricators [parts of machines]; igniting magnetos; handling machines, automatic [manipulators]; churns; matrices for use in printing; machine fly-wheels; shearing machines for animals; blowing machines; knitting machines; galvanizing machines; bending machines; ironing machines; mineworking machines; net hauling machines [fishing]; electroplating machines; bottle sealing machines; sealing machines for industrial purposes; embossing machines; engraving machines; finishing machines; crushing machines; waste disposal units; blade sharpening [stropping] machines; earth moving machines; cord making machines; lace making machines; butter machines; cigarette machines for industrial purposes; sausage making machines; stereotype machines; hosiery looms; dyeing machines; bottle washing machines; dishwashers; bottle filling machines; cheese slicers, electric; racket stringing machines; leather-working machines; dairy machines; glass-working machines; tobacco processing machines; grain husking machines; painting machines; oil refining machines; peeling machines; machines for processing plastics; ore treating machines; printing machines for use on sheet metal; brewing machines; whitewashing machines; road sweeping machines, self-propelled; leather paring machines; bitumen making machines; papermaking machines; pasta making machines, electric; machines for the production of sugar; weeding machines; sifting machines; cinder sifters [machines]; puddling machines; notchers [machine tools]; bread cutting machines; road making machines; railroad constructing machines; machines for the textile industry; rammers [machines]; rail-laying machines; bottle capping machines; bottle stoppering machines; waste compacting machines; vegetable peelers, electric; die-stamping machines; stamping machines; darning machines; milking machines; drainage machines; wrapping machines; grain separators; bookbinding apparatus and machines for industrial purposes; machines and apparatus for cleaning, electric; machines and apparatus for carpet shampooing, electric; machines and apparatus for polishing [electric]; sizing machines; punching machines; riveting machines; kitchen machines, electric; foundry machines; smoothing presses; fleshing machines; flour mill machines; type-se-

ting machines [printing]; hemming machines; grating machines for vegetables; braiding machines; wringing machines for laundry; cutting machines; steam engines; printing machines; rotary printing presses; industrial inkjet printing machines; compressed air machines; tilling machines for agricultural purposes; trimming machines; spinning machines; filling machines; friezing machines; cutters [machines]; satinizing machines; agricultural machines; mixing machines; sorting machines for industry; stitching machines; washing machines [laundry]; coin-operated washing machines; clippers [machines]; spinning frames; looms; kneading machines; typographic machines; type-setting machines [photocomposition]; beating machines; beaters, electric; packing machines; packaging machines; filtering machines; moulding machines; carding machines; sewing machines; typesetting machines; electromechanical machines for chemical industry; labellers [machines]; mills [machines]; mills for household purposes, other than hand-operated; pepper mills, other than hand-operated; centrifugal mills; machine wheelwork; feeders [parts of machines]; forge blowers; mixers [machines]; blenders, electric, for household purposes; vacuum cleaner bags; threshing machines; pneumatic hammers; hammers [parts of machines]; tilt hammers; power hammers; reeling apparatus, mechanical; motorized cultivators; motors for boats; clutches, other than for land vehicles; meat choppers [machines]; superchargers; brake linings, other than for vehicles; guides for machines; suction nozzles for vacuum cleaners; vacuum cleaner attachments for disseminating perfumes and disinfectants; pumps [machines]; pumps [parts of machines, engines or motors]; aerating pumps for aquaria; vacuum pumps [machines]; compressed air pumps; pumps for heating installations; beer pumps; pumps for counter-current swimming; lubricating pumps; self-regulating fuel pumps; fuel dispensing pumps for service stations; centrifugal pumps; hydrogen dispensing pumps for service stations; blades [parts of machines]; knives for mowing machines; chaff cutter blades; knives, electric; shears, electric; scissors, electric; vegetable spiralizers, electric; engine mounts, other than for land vehicles; bearing brackets for machines; pulverisers [machines]; axles for machines; steam traps; chucks [parts of machines]; drill chucks [parts of machines]; exhaust manifold for engines; soldering irons, gas-operated; soldering irons, electric; superheaters; gears, other than for land vehicles; reduction gears, other than for land vehicles; drilling machines; saws [machines]; chain saws; guns [tools using explosives]; glue guns, electric; compressed air guns for the extrusion of mastics; carburetter feeders; feeding apparatus for engine boilers; loading ramps; ploughs; pneumatic transporters; pneumatic controls for machines, motors and engines; hangers [parts of machines]; anti-friction bearings for machines; roller bearings; self-oiling bearings; bearings for transmission shafts; ball-bearings; elevators [lifts]; hoists; lifts, other than ski-lifts; pu-

lleys; saw blades [parts of machines]; pistons [parts of machines or engines]; shock absorber plungers [parts of machines]; pistons for engines; pistons for cylinders; catalytic converters; torque converters, other than for land vehicles; fuel conversion apparatus for internal combustion engines; presses [machines for industrial purposes]; wine presses; fodder presses; printing presses; typographic presses; swaging machines; pedal drives for sewing machines; cleaning appliances utilizing steam; food processors, electric; springs [parts of machines]; spinning wheels; punches for punching machines; vacuum cleaners; radiators [cooling] for motors and engines; sewage pulverizers; air brushes for applying colour; regulators [parts of machines]; pressure regulators [parts of machines]; speed governors for machines, engines and motors; knives [parts of machines]; cutting blow pipes, gas-operated; blade holders [parts of machines]; loom shafts; gears for weaving looms; belts for machines; elevator belts; fan belts for motors and engines; dynamo belts; belts for motors and engines; adhesive bands for pulleys; industrial robots; 3D printing pens; kick starters for motorcycles; joysticks being parts of machines, other than for game machines; stuffing boxes [parts of machines]; paper feeders [printing]; whisks, electric, for household purposes; sparking plugs for internal combustion engines; glow plugs for Diesel engines; brake segments, other than for vehicles; tedding machines; steam/oil separators; cream/milk separators; ball rings for bearings; sowers [machines]; pigs for cleaning pipes; snow ploughs; sheaf-binding machines; shaft couplings [machines]; juice extractors, electric; straw [chaff] cutters; suction cups for milking machines; stands for machines; machine tools; die-cutting and tapping machines; wood-working machines; sharpening machines; bicycle assembling machines; mortising machines; stone-working machines; metalworking machines; threading machines; planing machines; lathes [machine tools]; milling machines; trueing machines; metal drawing machines; rolling mills; starters for motors and engines; stators [parts of machines]; glaziers' diamonds [parts of machines]; tables for machines; derricks; slide rests [parts of machines]; couplings, other than for land vehicles; heat exchangers [parts of machines]; transmissions for machines; transmissions, other than for land vehicles; boiler tubes [parts of machines]; wind turbines; hydraulic turbines; turbines, other than for land vehicles; turbocompressors; central vacuum cleaning installations; suction machines for industrial purposes; machines for the mineralization of drinking water; washing installations for vehicles; degreasers [machines]; dust exhausting installations for cleaning purposes; sifting installations; pneumatic tube conveyors; dust removing installations for cleaning purposes; condensing installations; floating production, storage and offloading [FPSO] units; pneumatic waste oil drainers; lifting apparatus; air suction machines; dividing machines; igniting devices for in-

ternal combustion engines; washing apparatus; binding apparatus for hay; haulage apparatus [mining]; door openers, hydraulic; door openers, pneumatic; door openers, electric; curtain drawing devices, electrically operated; adhesive tape dispensers [machines]; anti-pollution devices for motors and engines; beverage preparation machines, electromechanical; food preparation machines, electromechanical; elevator operating apparatus; control mechanisms for machines, engines or motors; shoe polishers, electric; machines and apparatus for wax-polishing, electric; air cushion devices for moving loads; handling apparatus for loading and unloading; elevating apparatus; aprons [parts of machines]; filter presses; filters for cleaning cooling air, for engines; filters being parts of machines or engines; moulds [parts of machines]; printing plates; journals [parts of machines]; centrifugal machines; elevator chains [parts of machines]; driving chains, other than for land vehicles; transmission chains, other than for land vehicles; cylinders for motors and engines; cylinders for machines; printing cylinders; pneumatic jacks; shuttles [parts of machines]; universal joints [Cardan joints]; steam mops; pulleys [parts of machines]; vacuum cleaner hoses; screwdrivers, electric; brushes [parts of machines]; dynamo brushes; brushes, electrically operated [parts of machines]; carbon brushes [electricity]; ejectors; robotic exoskeleton suits, other than for medical purposes; fuel economisers for motors and engines; excavators; shovels, mechanical; agricultural elevators; motors, electric, other than for land vehicles; electrodes for welding machines; electric hammers; parquet wax-polishers, electric; cartridges for filtering machines; moving staircases [escalators]; automatic grapnels for marine purposes; tambours for embroidery machines; exhausts for motors and engines; joints [parts of engines]; window closers, pneumatic; window closers, hydraulic; window closers, electric; window openers, hydraulic; window openers, pneumatic; window openers, electric; blowing machines for the compression, exhaustion and transport of gases; blowing machines for the compression, sucking and carrying of grain; de-aerators for feedwater; tools [parts of machines].

9 – DVD players; ticket dispensers; juke boxes, musical; fire engines; answering machines; electrical adapters; batteries for electronic cigarettes; accumulators, electric; batteries, electric, for vehicles; accelerometers; actinometers; alidades; altimeters; ear pads for earphones; ammeters; nanoparticle size analysers; anemometers; anodes; aerials; anticathodes; apertometers [optics]; high-frequency apparatus; testing apparatus not for medical purposes; remote control apparatus; electro-dynamic apparatus for the remote control of railway points; electro-dynamic apparatus for the remote control of signals; monitoring apparatus, other than for medical purposes; sound recording apparatus; Global Positioning System [GPS] apparatus; distillation apparatus for scientific purposes; diffraction apparatus [microscopy]; air analysis apparatus; ap-

paratus to check franking; sound transmitting apparatus; apparatus for fermentation [laboratory apparatus]; breathing apparatus for underwater swimming; breathing apparatus, except for artificial respiration; apparatus and installations for the production of X-rays, not for medical purposes; cash registers; electric apparatus for commutation; intercommunication apparatus; stills for laboratory experiments; projection apparatus; fire extinguishing apparatus; radiological apparatus for industrial purposes; X-ray apparatus not for medical purposes; blueprint apparatus; flashing lights [luminous signals]; stereoscopic apparatus; telephone apparatus; facsimile machines; phototelegraphy apparatus; igniting apparatus, electric, for igniting at a distance; acid hydrometers; salinometers; acidimeters for batteries; aerometers; beacons, luminous; battery jars; automated teller machines [ATM]; barometers; anode batteries; galvanic batteries; ignition batteries; solar batteries; solar panels for the production of electricity; batteries, electric; balances [steelyards]; betatrons; binoculars; biochips; electronic tags for goods; lens hoods; magnetic tape units for computers; computer memory devices; fire hose nozzles; encoded identification bracelets, magnetic; connected bracelets [measuring instruments]; safety tarpaulins; electronic key fobs being remote control apparatus; bullet-proof clothing; signalling buoys; life buoys; marking buoys; directional compasses; vacuum gauges; electrolyzers; variometers; verniers; scales; baby scales; bathroom scales; letter scales; weighbridges; precision balances; scales with body mass analysers; levelling staffs [surveying instruments]; camcorders; video baby monitors; video cassettes; video projectors; video telephones; video screens; viewfinders, photographic; electric plugs; micrometer screws for optical instruments; viscosimeters; circuit closers; wavemeters; voltmeters; mechanical signs; signs, luminous; switchboxes [electricity]; current rectifiers; gas testing instruments; gasometers [measuring instruments]; galvanometers; hands-free kits for telephones; heliographic apparatus; hygrometers; hydrometers; weights; peepholes [magnifying lenses] for doors; hairdressing training heads [teaching apparatus]; holograms; plotters; sounding leads; plumb bobs; range finders; parking sensors for vehicles; piezoelectric sensors; densimeters; densitometers; detectors; smoke detectors; infrared detectors; counterfeit coin detectors; joysticks for use with computers, other than for video games; transparencies [photography]; slide projectors; diaphragms [photography]; dictating machines; dynamometers; light-emitting diodes [LED]; quantum dot light-emitting diodes [QLED]; organic light-emitting diodes [OLED]; floppy disks; phonograph records; disks, magnetic; optical discs; circular slide rules; disk drives for computers; juke boxes for computers; wearable video display monitors; electronic numeric displays; DNA chips; electronic interactive whiteboards; electronic notice boards; electric wire harnesses for automobiles; bullet-proof vests; life jackets; reflective safety vests;

identification threads for electric wires; nose clips for divers and swimmers; padlocks, electronic; locks, electric; bells [warning devices]; alarm bells, electric; electric door bells; signal bells; acoustic conduits; mirrors for inspecting work; road signs, luminous or mechanical; marine depth finders; probes for scientific purposes; buzzers; needles for surveying compasses; needles for record players; eyewear; reflective articles for wear, for the prevention of accidents; measures; pressure measuring apparatus; simulators for the steering and control of vehicles; inverters [electricity]; pressure indicators; automatic indicators of low pressure in vehicle tyres; temperature indicators; incubators for bacteria culture; measuring instruments; cosmographic instruments; mathematical instruments; levelling instruments; instruments containing eyepieces; surveying instruments; azimuth instruments; interfaces for computers; ionization apparatus not for the treatment of air or water; satellite finder meters; spark-guards; coaxial cables; fibre optic cables; cables, electric; calipers; slide calipers; screw-tapping gauges; calorimeters; calculating machines; pocket calculators; decompression chambers; rearview cameras for vehicles; cinematographic cameras; thermal imaging cameras; mouth guards for sports; life-saving capsules for natural disasters; electronic pens [visual display units]; holders for electric coils; biometric identity cards; identity cards, magnetic; video game cartridges; ink cartridges, unfilled, for printers and photocopiers; memory cards for video game machines; encoded magnetic cards; riding helmets; protective helmets; carriers for dark plates [photography]; cathodes; spools [photography]; choking coils [impedance]; coils, electric; electromagnetic coils; cinematographic film, exposed; computer keyboards; solenoid valves [electromagnetic switches]; wire connectors [electricity]; thin client computers; downloadable cryptographic keys for receiving and spending cryptocurrency; encoded key cards; electronic book readers; electronic agendas; push buttons for bells; magnetic encoders; visors for helmets; collectors, electric; calibrating rings; smart rings; ring sizers; protective suits for aviators; commutators; compact discs [audio-video]; comparators; marine compasses; computers; laptop computers; tablet computers; notebook computers; wearable computers; condensers [capacitors]; contacts, electric; wind socks for indicating wind direction; traffic cones; branch boxes [electricity]; distribution boxes [electricity]; junction boxes [electricity]; battery boxes; cabinets for loudspeakers; diving suits; downloadable e-wallets; galena crystals [detectors]; covers for electric outlets; logs [measuring instruments]; lasers, not for medical purposes; lactodensimeters; lactometers; vacuum tubes [radio]; darkroom lamps [photography]; thermionic valves; amplifying tubes; flashlights [photography]; head cleaning tapes [recording]; magnetic tapes; videotapes; surveying chains; fire escapes; rulers [measuring instruments]; square rulers for measuring; slide-rules; con-

tact lenses; correcting lenses [optics]; optical lenses; optical condensers; sounding lines; electricity conduits; measuring spoons; magnifying glasses [optics]; thread counters; magnets; decorative magnets; close-up lenses; crash test dummies; resuscitation mannequins [teaching apparatus]; pressure gauges; security tokens [encryption devices]; divers' masks; solderers' helmets; protective masks; respiratory masks, other than for artificial respiration; materials for electricity mains [wires, cables]; voting machines; money counting and sorting machines; material testing instruments and machines; furniture especially made for laboratories; megaphones; portable media players; diaphragms [acoustics]; diaphragms for scientific apparatus; metal detectors for industrial or military purposes; digital weather stations; metronomes; rules [measuring instruments]; carpenters' rules; dressmakers' measures; mechanisms for coin-operated apparatus; mechanisms for counter-operated apparatus; coin-operated mechanisms for television sets; shutter releases [photography]; micrometers; microprocessors; microscopes; microtomes; microphones; audio mixers; modems; lightning conductors; monitors [computer hardware]; monitors [computer programs]; selfie sticks [hand-held monopods]; terminals [electricity]; junction sleeves for electric cables; teeth protectors; temperature indicator labels, not for medical purposes; knee-pads for workers; headphones; earpieces for remote communication; surveyors' levels; sound recording carriers; magnetic data media; optical data media; electronic sheet music, downloadable; sheaths for electric cables; identification sheaths for electric wires; weighing machines; computer hardware; punched card machines for offices; life saving equipment; objectives [lenses] [optics]; lenses for astrophotography; selfie lenses; egg-candlers; fire extinguishers; rescue laser signalling flares; electrified fences; limiters [electricity]; clothing for protection against accidents, irradiation and fire; clothing for protection against fire; asbestos clothing for protection against fire; clothing especially made for laboratories; survival blankets; ozonisers [ozonators]; octants; eyepieces; ohmmeters; wrist rests for use with computers; spectacle frames; oscillographs; plumb lines; mirrors [optics]; spectacles; sunglasses; goggles for sports; electronic collars to train animals; finger sizers; signalling panels, luminous or mechanical; biometric passports; wah-wah pedals; radio pagers; pince-nez; electronic pocket translators; transmitters [telecommunication]; telephone transmitters; transmitters of electronic signals; switches, electric; periscopes; data gloves; gloves for divers; gloves for protection against accidents; gloves for protection against X-rays for industrial purposes; asbestos gloves for protection against accidents; furnaces for laboratory use; droppers for measuring, other than for medical or household purposes; laboratory pipettes; pyrometers; planimeters; plane tables [surveying instruments]; plates for batteries; computer software platforms, recorded or download-

able; wafers for integrated circuits; printed circuit boards; compact disc players; cassette players; protective films adapted for computer screens; protective films adapted for smartphones; sound recording strips; X-ray films, exposed; films, exposed; life-saving rafts; animal signalling rattles for directing livestock; laboratory trays; digital signs; stands adapted for laptops; semi-conductors; polarimeters; personal digital assistants [PDAs]; fire pumps; measuring glassware; weight belts for divers; life belts; fuses; circuit breakers; converters, electric; telerrupters; food analysis apparatus; diagnostic apparatus, not for medical purposes; distance recording apparatus; distance measuring apparatus; speed measuring apparatus [photography]; appliances for measuring the thickness of leather; apparatus for measuring the thickness of skins; speed checking apparatus for vehicles; teaching apparatus; time recording apparatus; apparatus and instruments for astronomy; surveying apparatus and instruments; weighing apparatus and instruments; nautical apparatus and instruments; navigational instruments; optical apparatus and instruments; apparatus and instruments for physics; chemistry apparatus and instruments; measuring apparatus; measuring devices, electric; boiler control instruments; meteorological instruments; naval signalling apparatus; observation instruments; navigation apparatus for vehicles [on-board computers]; satellite navigational apparatus; regulating apparatus, electric; telecommunication apparatus in the form of jewellery; precision measuring apparatus; audio- and video-receivers; prisms [optics]; computer software applications, downloadable; ticket printers; printers for use with computers; retorts' stands; apparatus for changing record player needles; drainers for use in photography; cleaning apparatus for phonograph records; fire beaters; sighting telescopes for firearms; telescopic sights for artillery; test tubes; pressure indicator plugs for valves; magnetic wires; telegraph wires; telephone wires; wires, electric; conductors, electric; copper wire, insulated; fuse wire; computer game software, downloadable; computer programs, downloadable; computer screen saver software, recorded or downloadable; record players; processors [central processing units]; rods for water diviners; electronic publications, downloadable; distribution consoles [electricity]; control panels [electricity]; radar apparatus; masts for wireless aerials; transmitting sets [telecommunication]; radios; vehicle radios; sprinkler systems for fire protection; frames for photographic transparencies; screens for photoengraving; flowmeters; walkie-talkies; voltage surge protectors; voltage regulators for vehicles; stage lighting regulators; speed regulators for record players; cell switches [electricity]; washing trays [photography]; marking gauges [joinery]; T-squares for measuring; time switches, automatic; relays, electric; body harnesses for support when lifting loads; X-ray photographs, other than for medical purposes; rheostats; respirators for filtering air; retorts; refractometers; ref-

ractors; grids for batteries; security surveillance robots; laboratory robots; teaching robots; telepresence robots; humanoid robots with artificial intelligence; electric sockets; height measuring instruments; speaking tubes; horns for loudspeakers; subwoofers; saccharometers; optical fibres [light conducting filaments]; traffic-light apparatus [signalling devices]; dog whistles; signalling whistles; sports whistles; sextants; inductors [electricity]; safety nets; nets for protection against accidents; fire alarms; signals, luminous or mechanical; rescue flares, non-explosive and non-pyrotechnic; sirens; electronic access control systems for interlocking doors; hand-held electronic dictionaries; integrated circuit cards [smart cards]; smart-glasses; smartphones; smartwatches; connections for electric lines; couplings, electric; sonars; sound locating instruments; lighting ballasts; resistances, electric; spectrograph apparatus; spectrometers; speed indicators; alcoholmeters; satellites for scientific purposes; protection devices for personal use against accidents; audiovisual teaching apparatus; charging stations for electric vehicles; radiotelegraphy sets; radiotelephony sets; spectacle lenses; anti-glare glasses; optical glass; personal stereos; stereoscopes; stands for photographic apparatus; stroboscopes; fire boats; sulfimeters; bags adapted for laptops; drying racks [photography]; spherometers; integrated circuits; printed circuits; counters; parking meters; mileage recorders for vehicles; revolution counters; abacuses; egg timers [sandglasses]; taximeters; ear plugs for divers; tachometers; television apparatus; telegraphs [apparatus]; telescopes; teleprompters; teleprinters; cordless telephones; mobile telephones; theodolites; credit card terminals; interactive touch screen terminals; thermohygrometers; thermometers, not for medical purposes; thermostats; thermostats for vehicles; climate control digital thermostats; crucibles [laboratory]; tone arms for record players; totalizers; transistors [electronic]; transponders; protractors [measuring instruments]; transformers [electricity]; step-up transformers; resuscitation training simulators; vehicle breakdown warning triangles; triodes; starter cables for motors; discharge tubes, electric, other than for lighting; capillary tubes; neon signs; Pitot tubes; X-ray tubes not for medical purposes; telephone receivers; headgear being protective helmets; squares for measuring; gauges; quantity indicators; petrol gauges; water level indicators; electric loss indicators; light-emitting electronic pointers; slope indicators; levels [instruments for determining the horizontal]; mercury levels; spirit levels; urinometers; amplifiers; particle accelerators; electric installations for the remote control of industrial operations; baby monitors; steering apparatus, automatic, for vehicles; balancing apparatus; video recorders; sound reproduction apparatus; invoicing machines; tape recorders; protection devices against X-rays, not for medical purposes; railway traffic safety appliances; data processing apparatus; oxygen transvasing apparatus; theft prevention installations,

electric; devices for the projection of virtual keyboards; film cutting apparatus; drying apparatus for photographic prints; optical character readers; centering apparatus for photographic transparencies; dosage dispensers; battery chargers; chargers for electric accumulators; chargers for electronic cigarettes; acoustic alarms; sounding apparatus and machines; apparatus for editing cinematographic film; cathodic anti-corrosion apparatus; couplers [data processing equipment]; anti-theft warning apparatus; computer peripheral devices; anti-interference devices [electricity]; demagnetizing apparatus for magnetic tapes; acoustic couplers; alarms; fog signals, non-explosive; whistle alarms; adding machines; heat regulating apparatus; photocopiers [photographic, electrostatic, thermic]; electric and electronic effects units for musical instruments; bar code readers; downloadable image files; downloadable music files; animated cartoons; filters for respiratory masks; filters for ultraviolet rays, for photography; filters for use in photography; USB flash drives; magic lanterns; optical lanterns; signal lanterns; cameras [photography]; glazing apparatus for photographic prints; shutters [photography]; dark-rooms [photography]; photometers; flash-bulbs [photography]; digital photo frames; enlarging apparatus [photography]; photovoltaic cells; containers for contact lenses; spectacle cases; containers for microscope slides; cases for smartphones; cases especially made for photographic apparatus and instruments; chromatography apparatus for laboratory use; chronographs [time recording apparatus]; laboratory centrifuges; spectacle chains; cyclotrons; compasses for measuring; frequency meters; time clocks [time recording devices]; Petri dishes; sleeves for laptops; covers for personal digital assistants [PDAs]; covers for tablet computers; covers for smartphones; fire blankets; chips [integrated circuits]; jigs [measuring instruments]; pedometers; meteorological balloons; electrified rails for mounting spot lights; asbestos screens for firemen; fire hose; virtual reality headsets; protective helmets for sports; head guards for sports; lifeboats; snorkels; cell phone straps; spectacle cords; tripods for cameras; switchboards; distribution boards [electricity]; equalizers [audio apparatus]; workmen's protective face-shields; projection screens; radiology screens for industrial purposes; fluorescent screens; exposure meters [light meters]; ducts [electricity]; galvanic cells; downloadable graphics for mobile phones; epidiascopes; ergometers; armatures [electricity]; black boxes [data recorders]; 3D spectacles; magnetic resonance imaging [MRI] apparatus, not for medical purposes; screens [photography]; downloadable emoticons for mobile phones; downloadable ring tones for mobile phones; audio interfaces; toner cartridges, unfilled, for printers and photocopiers; mouse pads; compact discs [read-only memory]; mouse [computer peripheral]; trackballs [computer peripherals]; ear pads for headphones; computer software, recorded; shoes for protection against accidents, irradiation and



fire; hemline markers; computer programs, recorded; light dimmers [regulators], electric; lanyards for safety purposes for fall protection; scanners [data processing equipment]; wearable activity trackers; readers [data processing equipment].

10 – Cholesterol meters; blood testing apparatus; anaesthetic apparatus; galvanic therapeutic appliances; apparatus for artificial respiration; apparatus for the treatment of deafness; physical exercise apparatus for medical purposes; body rehabilitation apparatus for medical purposes; dental apparatus and instruments; surgical apparatus and instruments; resuscitation apparatus; dental apparatus, electric; physiotherapy apparatus; bed vibrators; hot air therapeutic apparatus; diagnostic apparatus for medical purposes; traction apparatus for medical purposes; radiotherapy apparatus; microdermabrasion apparatus; fumigation apparatus for medical purposes; apparatus for the regeneration of stem cells for medical purposes; apparatus for DNA and RNA testing for medical purposes; apparatus and installations for the production of X-rays, for medical purposes; medical cooling apparatus for treating heatstroke; medical cooling apparatus for use in therapeutic hypothermia; radiological apparatus for medical purposes; X-ray apparatus for medical purposes; hearing aids; nasal aspirators; trusses; maternity belts; support bandages; bandages, elastic; cupping glasses; dental burs; acupressure bands; bracelets for medical purposes; anti-nausea wristbands; anti-rheumatism bracelets; feeding bottles; air cushions for medical purposes; vaporizers for medical purposes; hot air vibrators for medical purposes; vibromassage apparatus; gastroscopes; glucometers; lice combs; surgical sponges; pill cutters; defibrillators; dialyzers; containers especially made for medical waste; clips, surgical; mirrors for dentists; mirrors for surgeons; probes for medical purposes; urethral probes; artificial teeth; acupuncture needles; suture needles; needles for medical purposes; orthopedic articles; pill crushers; surgical implants comprised of artificial materials; inhalers; hydrogen inhalers; injectors for medical purposes; incubators for medical purposes; incubators for babies; obstetric apparatus; obstetric apparatus for cattle; electric acupuncture instruments; surgical cutlery; insufflators; chambers for inhalers; endoscopy cameras for medical purposes; cannulae; droppers for medical purposes; dropper bottles for medical purposes; heart monitors; heart pacemakers; catheters; catgut; draw-sheets for sick beds; enema apparatus for medical purposes; clips for dummies; artificial skin for surgical purposes; menstrual cups; teething rings; anti-rheumatism rings; compressors [surgical]; thermo-electric compresses [surgery]; oxygen concentrators for medical purposes; abdominal corsets; corsets for medical purposes; crutches; dentists' armchairs; armchairs for medical or dental purposes; waterbeds for medical purposes; beds specially made for medical purposes; feeding bottle valves; love dolls [sex dolls]; lasers for medical purposes; lamps for medical purposes;

ses; curing lamps for medical purposes; quartz lamps for medical purposes; ultraviolet ray lamps for medical purposes; lancets; kinesiology tapes; lenses [intraocular prostheses] for surgical implantation; spoons for administering medicine; sanitary masks for medical purposes; masks for use by medical personnel; respiratory masks for artificial respiration; anaesthetic masks; LED masks for therapeutic purposes; therapeutic facial masks; gum massagers for babies; suture materials; childbirth mattresses; air mattresses for medical purposes; furniture especially made for medical purposes; water bags for medical purposes; douche bags; breast pumps; body fat monitors; body composition monitors; urinals being vessels; portable handheld urinals; teeth protectors for dental purposes; temperature indicator labels for medical purposes; knee bandages, orthopaedic; tips for crutches; nano-robots for medical purposes; finger guards for medical purposes; bone void fillers comprised of artificial materials; medical guidewires; pumps for medical purposes; thread, surgical; knives for surgical purposes; scissors for surgery; ambulance stretchers; stretchers, wheeled; boots for medical purposes; orthopaedic footwear; clothing especially for operating rooms; compression garments; blankets, electric, for medical purposes; supports for flat feet; ophthalmometers; ophthalmoscopes; cooling pads for first aid purposes; slings [supporting bandages]; gloves for massage; gloves for medical purposes; pessaries; saws for surgical purposes; ear picks; cooling patches for medical purposes; spittoons for medical purposes; plaster bandages for orthopaedic purposes; orthopaedic bandages for joints; abdominal pads; cushions for medical purposes; pads for preventing pressure sores on patient bodies; air pillows for medical purposes; soporific pillows for insomnia; heating cushions, electric, for medical purposes; patient hoists; abdominal belts; galvanic belts for medical purposes; hypogastric belts; belts for medical purposes; orthopaedic belts; umbilical belts; belts, electric, for medical purposes; condoms; aerosol dispensers for medical purposes; sphygmotensimeters; pulse meters; esthetic massage apparatus; massage apparatus; veterinary apparatus and instruments; medical apparatus and instruments; urological apparatus and instruments; brushes for cleaning body cavities; appliances for washing body cavities; corn knives; incontinence sheets; sterile sheets, surgical; surgical drapes; artificial eyes; artificial breasts; dentures; artificial limbs; artificial jaws; ice bags for medical purposes; toe separators for orthopaedic purposes; orthodontic rubber bands; X-ray photographs for medical purposes; respirators for artificial respiration; surgical robots; ear trumpets; strait jackets; sex toys; scalpels; tongue scrapers; dummies for babies; feeding bottle teats; baby feeding dummies; receptacles for applying medicines; spirometers [medical apparatus]; vaginal syringes; implantable subcutaneous drug delivery devices; hearing protectors; contraceptives, non-chemical; orthopaedic soles; stents; stethoscopes;

medical examination tables; operating tables; commode chairs; basins for medical purposes; bed pans; instrument cases for use by doctors; arch supports for footwear; ear plugs [ear protection devices]; thermometers for medical purposes; tomographs for medical purposes; trocars; walking sticks for medical purposes; drainage tubes for medical purposes; X-ray tubes for medical purposes; radium tubes for medical purposes; balling guns; protection devices against X-rays, for medical purposes; apparatus for acne treatment; filters for ultraviolet rays, for medical purposes; patient examination gowns; quad canes for medical purposes; wheeled walkers to aid mobility; walking frames for disabled persons; cases fitted for medical instruments; elastic stockings for surgical purposes; stockings for varices; splints, surgical; laser therapy helmets for treating alopecia; tongue depressors for medical purposes; syringes for injections; syringes for medical purposes; hypodermic syringes; uterine syringes; urethral syringes; pins for artificial teeth; castrating pincers; robotic exoskeleton suits for medical purposes; radiology screens for medical purposes; electrodes for medical use; electrocardiographs; brain pacemakers; forceps for medical purposes; thermal packs for first aid purposes; suspensory bandages; surgical bougies; hair prostheses; biomagnetic rings for therapeutic or medical purposes; biodegradable bone fixation implants; magnetic resonance imaging [MRI] apparatus for medical purposes; testing apparatus for medical purposes; analysers for bacterial identification for medical purposes.

11 – Lampshades; steam accumulators; heat accumulators; defrosters for vehicles; disinfectant apparatus for medical purposes; distillation apparatus; desiccating apparatus; hydromassage bath apparatus; disinfectant apparatus; air deodorizing apparatus; tanning apparatus [sun beds]; ionization apparatus for the treatment of air or water; coffee roasters; beverage cooling apparatus; hand drying apparatus for washrooms; fruit roasters; water purifying apparatus and machines; refrigerating apparatus and machines; underfloor heating apparatus and installations; drying apparatus and installations; freezers; heating and cooling apparatus for dispensing hot and cold beverages; drying apparatus; coolers for furnaces; expansion tanks for central heating installations; flushing tanks; refining towers for distillation; bidets; boilers, other than parts of machines; bath tubs; spa baths [vessels]; bath tubs for sitz baths; waffle irons, electric; fans [air-conditioning]; fans [parts of air-conditioning installations]; electric fans for personal use; roasting spits; refrigerating display cabinets; heated display cabinets; dehumidifiers; water heaters; water flushing installations; air reheaters; extractor hoods for kitchens; gas condensers, other than parts of machines; acetylene generators; fog machines; microbubble generators for baths; hydrants; burners; acetylene burners; gas burners; burners for lamps; germicidal burners; incandescent burners; oxyhydrogen burners; laboratory bur-

ners; oil burners; alcohol burners; hot water bottles; footwarmers, electric or non-electric; bed warmers; USB-powered hand warmers; pocket warmers; warming pans; roasting apparatus; food dehydrators, electric; lampshade holders; stills; showers; refrigerating containers; lighters; gas lighters; friction lighters for igniting gas; chimney blowers; coils [parts of distilling, heating or cooling installations]; furnace ash boxes; evaporators; shower cubicles; Turkish bath cabinets, portable; heating apparatus; cool boxes, electric; refrigerating chambers; fireplaces, domestic; chimney flues; coffee capsules, empty, for electric coffee machines; structural framework for ovens; air valves for steam heating installations; level controlling valves in tanks; thermostatic valves [parts of heating installations]; electrically heated carpets; light bulbs; light bulbs, electric; solar thermal collectors [heating]; distillation columns; furnace grates; ventilation hoods; ventilation hoods for laboratories; lamp globes; air-conditioning apparatus; air conditioners for vehicles; gas boilers; laundry room boilers; heating boilers; coffee machines, electric; taps; taps for pipes and pipelines; mixer taps for water pipes; forges, portable; lava rocks for use in barbecue grills; couscous cookers, electric; lights, electric, for Christmas trees; acetylene flares; safety lamps; gas lamps; curling lamps; nail lamps; curing lamps, not for medical purposes; germicidal lamps for purifying air; light bulbs for directional signals for vehicles; arc lamps; laboratory lamps; oil lamps; ultraviolet ray lamps, not for medical purposes; miners' lamps; electric lamps; chandeliers; barbecues; watering machines for agricultural purposes; ice-cream making machines; soya milk making machines, electric; pounded rice cake making machines, electric, for household purposes; multicookers; footmuffs, electrically heated; heaters for baths; heaters for heating irons; immersion heaters; brackets for gas burners; anti-splash tap nozzles; heat pumps; filaments for electric lamps; magnesium filaments for lighting; heating filaments, electric; luminous house numbers; socks, electrically heated; heating apparatus for defrosting vehicle windows; hot air bath fittings; bath fittings; loading apparatus for furnaces; kiln furniture [supports]; sauna bath installations; refrigerating appliances and installations; directional lights for bicycles; electrically heated clothing; blankets, electric, not for medical purposes; fabric steamers; lamp reflectors; vehicle reflectors; hearths; electric cooktops; food steamers, electric; steam boilers, other than parts of machines; pasteurisers; lamp mantles; sockets for electric lights; coffee percolators, electric; stoves [heating apparatus]; bakers' ovens; hot air ovens; kitchen ranges [ovens]; microwave ovens [cooking apparatus]; microwave ovens for industrial purposes; incinerators; kilns; solar furnaces; dental ovens; furnaces, other than for laboratory use; urinals being sanitary fixtures; feeding apparatus for heating boilers; heating plates; cooking stoves; hot plates; wine cellars, electric; heaters, electric, for feeding bott-

les; aquarium heaters; USB-powered cup heaters; aquarium lights; heating cushions, electric, not for medical purposes; clean chambers [sanitary installations]; tortilla presses, electric; water intake apparatus; deodorizing apparatus, not for personal use; apparatus for dehydrating food waste; fumigation apparatus, not for medical purposes; gas scrubbing apparatus; oil-scrubbing apparatus; glue-heating appliances; drying apparatus for fodder and forage; water filtering apparatus; air purifying apparatus and machines; ice machines and apparatus; cooling appliances and installations; cooking apparatus and installations; lighting apparatus and installations; sanitary apparatus and installations; cooking rings; lighting apparatus for vehicles; light-emitting diodes [LED] lighting apparatus; heating apparatus for solid, liquid or gaseous fuels; heating apparatus, electric; hot air apparatus; steam facial apparatus [saunas]; safety accessories for water or gas apparatus and pipes; regulating and safety accessories for gas apparatus; regulating accessories for water or gas apparatus and pipes; regulating and safety accessories for water apparatus; regulating and safety accessories for gas pipes; roasting jacks; plate warmers; anti-glare devices for vehicles [lamp fittings]; rotisseries; radiator caps; searchlights; diving lights; light projectors; washers for water taps; heat guns; radiators [heating]; central heating radiators; radiators, electric; sinks; disinfectant dispensers for toilets; drip irrigation emitters [irrigation fittings]; light diffusers; nuclear reactors; heat regenerators; pressure water tanks; roasters; beverage urns, electric; lamps; ceiling lights; toilet seats; hydroponic growing systems; lighting installations for air vehicles; autoclaves, electric, for cooking; gas scrubbers [parts of gas installations]; lamp glasses; sterilizers; water sterilizers; air sterilizers; air dryers; laundry dryers, electric; hair dryers; malt roasters; tobacco roasters; tajines, electric; heat exchangers, other than parts of machines; bread toasters; discharge tubes, electric, for lighting; lamp chimneys; luminous tubes for lighting; pipes [parts of sanitary installations]; flues for heating boilers; boiler pipes [tubes] for heating installations; toilets [water-closets]; toilets, portable; humidifiers; humidifiers for central heating radiators; wash-hand basins [parts of sanitary installations]; toilet bowls; water conduits installations; air-conditioning installations; desalination plants; installations for processing nuclear fuel and nuclear moderating material; watering installations, automatic; cooling installations for water; cooling installations for liquids; milk cooling installations; cooling installations for tobacco; water purification installations; purification installations for sewage; steam generating installations; water distribution installations; air filtering installations; swimming pool chlorinating apparatus; ventilation [air-conditioning] installations and apparatus; ventilation [air-conditioning] installations for vehicles; water softening apparatus and installations; cooling installations and machines; heating installations; heaters for vehicles; heating ins-

tallations [water]; polymerisation installations; water supply installations; flare stacks for use in the oil industry; ash conveyor installations, automatic; whirlpool-jet apparatus; air cooling apparatus; sous-vide cookers, electric; aquarium filtration apparatus; cooking utensils, electric; flaming torches; headlights for automobiles; vehicle headlights; filters for air conditioning; filters for drinking water; wicks adapted for oil stoves; lights for automobiles; bicycle lights; motorcycle lights; lights for vehicles; electric torches; head torches; lanterns for lighting; candle lanterns; street lamps; Chinese lanterns; fountains; ornamental fountains; chocolate fountains, electric; air fryers; deep fryers, electric; fittings, shaped, for furnaces; oven fittings made of fireclay; bread-making machines; refrigerators; refrigerators, cooling apparatus and freezers for medical storage purposes; chromatography apparatus for industrial purposes; kettles, electric; dampers [heating]; book sterilization apparatus; refrigerating cabinets; carbon for arc lamps; heating elements; fairy lights for festive decoration; electric appliances for making yogurt; bread baking machines; bath installations; standard lamps; thermo-pots, electric.

35 – Arranging subscriptions to telecommunication services for others; import-export agency services; commercial information agency services; advertising agency services; cost price analysis; rental of office equipment in co-working facilities; rental of advertising space; business auditing; financial auditing; business intermediary services relating to the matching of potential private investors with entrepreneurs needing funding; employment agency services; computerized file management; book-keeping; invoicing; demonstration of goods; transcription of communications [office functions]; opinion polling; market studies; business investigations; business research; marketing research; personnel recruitment; business management and organization consultancy; business organization consultancy; business management consultancy; personnel management consultancy; professional business consultancy; consultancy regarding advertising communication strategies; layout services for advertising purposes; marketing; targeted marketing; business management of performing artists; business management of sports people; writing of curriculum vitae for others; scriptwriting for advertising purposes; news clipping services; updating and maintenance of information in registries; updating and maintenance of data in computer databases; updating of advertising material; word processing; online retail services for downloadable and pre-recorded music and movies; online retail services for downloadable ring tones; online retail services for downloadable digital music; organization of exhibitions for commercial or advertising purposes; arranging newspaper subscriptions for others; organization of fashion shows for promotional purposes; organization of trade fairs; shop window dressing; business appraisals; payroll preparation; data search in computer files for others; sponsorship se-

arch; administrative assistance in responding to calls for tenders; business management assistance; commercial or industrial management assistance; commercial intermediation services; providing business information; providing business information via a website; providing commercial and business contact information; providing commercial information and advice for consumers in the choice of products and services; providing user reviews for commercial or advertising purposes; web indexing for commercial or advertising purposes; providing user rankings for commercial or advertising purposes; economic forecasting; auctioneering; retail services for works of art provided by art galleries; sales promotion for others; promotion of goods and services through sponsorship of sports events; production of teleshopping programmes; production of advertising films; office machines and equipment rental; rental of advertising time on communication media; publicity material rental; rental of billboards [advertising boards]; rental of vending machines; rental of sales stands; rental of photocopying machines; consumer profiling for commercial or marketing purposes; publication of publicity texts; radio advertising; development of advertising concepts; bill-posting; distribution of samples; dissemination of advertising matter; direct mail advertising; registration of written communications and data; writing of publicity texts; advertising; online advertising on a computer network; advertising by mail order; television advertising; compilation of statistics; compilation of information into computer databases; business inquiries; systemization of information into computer databases; administrative services for medical referrals; advisory services for business management; corporate communications services; negotiation of business contracts for others; negotiation and conclusion of commercial transactions for third parties; compiling indexes of information for commercial or advertising purposes; tax preparation; drawing up of statements of accounts; telemarketing services; psychological testing for the selection of personnel; interim business management; business management of hotels; business management for freelance service providers; business project management services for construction projects; commercial administration of the licensing of the goods and services of others; business management of reimbursement programmes for others; administration of consumer loyalty programs; administration of frequent flyer programs; administrative processing of purchase orders; administrative services for the relocation of businesses; public relations; commercial lobbying services; competitive intelligence services; modelling for advertising or sales promotion; typing; market intelligence services; appointment reminder services [office functions]; website traffic optimization; tax filing services; search engine optimization for sales promotion; retail services relating to bakery products; gift registry services; price comparison services; pay per click advertising; secre-

tarial services; procurement services for others [purchasing goods and services for other businesses]; shorthand; outsourcing services [business assistance]; telephone answering for unavailable subscribers; telephone switchboard services; photocopying services; business efficiency expert services; consultancy regarding public relations communication strategies; marketing in the framework of software publishing; provision of an online marketplace for buyers and sellers of goods and services; presentation of goods on communication media, for retail purposes; media relations services; wholesale services for pharmaceutical, veterinary and sanitary preparations and medical supplies; retail services for pharmaceutical, veterinary and sanitary preparations and medical supplies; outsourced administrative management for companies; appointment scheduling services [office functions].

38 – News agency services; wireless broadcasting; television broadcasting; cable television broadcasting; electronic bulletin board services [telecommunications services]; providing user access to global computer networks; providing access to databases; providing telecommunications connections to a global computer network; providing telecommunication channels for teleshopping services; video-on-demand transmission; transmission of podcasts; message sending; computer aided transmission of messages and images; transmission of telegrams; transmission of digital files; providing information in the field of telecommunications; providing online forums; videoconferencing services; rental of message sending apparatus; rental of access time to global computer networks; rental of modems; rental of telecommunication equipment; rental of smartphones; rental of telephones; rental of facsimile apparatus; radio broadcasting; radio communications; transmission of electronic mail; communications by fibre optic networks; communications by cellular phones; communications by computer terminals; satellite transmission; communications by telegrams; communications by telephone; facsimile transmission; paging services [radio, telephone or other means of electronic communication]; teleconferencing services; telex services; voice mail services; streaming of data; telegraph services; telephone services; providing internet chatrooms; transmission of greeting cards online; telecommunications routing and junction services.

41 – Modelling for artists; academies [education]; rental of indoor aquaria; rental of artwork; rental of sports grounds; rental of tennis courts; lending library services; booking of seats for shows; videotaping; physical education; production of music; discotheque services; animal training; dubbing; publication of books; film distribution; movie studio services; nightclub services [entertainment]; layout services, other than for advertising purposes; microfilming; videotape editing; production of radio and television programmes; screenplay writing; religious education; ai-

kido instruction; gymnastic instruction; judo instruction; correspondence courses; practical training [demonstration]; training services provided via simulators; organization of balls; organization of exhibitions for cultural and educational purposes; providing recreation facilities; arranging and conducting of colloquiums; arranging and conducting of congresses; arranging and conducting of conferences; arranging and conducting of concerts; arranging and conducting of workshops [training]; arranging and conducting of seminars; arranging and conducting of symposiums; organization of competitions [education or entertainment]; arranging of beauty contests; organization of cosplay entertainment events; organization of lotteries; organization of fashion shows for entertainment purposes; organization of shows [impresario services]; organization of sports competitions; vocational guidance [education or training advice]; amusement park services; sign language interpretation; language interpretation; know-how transfer [training]; television entertainment; vocational retraining; providing online videos, not downloadable; providing information in the field of education; providing information relating to recreational activities; providing information in the field of entertainment; providing online music, not downloadable; providing television programmes, not downloadable, via video-on-demand services; providing films, not downloadable, via video-on-demand services; providing user reviews for entertainment or cultural purposes; providing golf facilities; providing user rankings for entertainment or cultural purposes; providing sports facilities; providing amusement arcade services; cinema presentations; providing online electronic publications, not downloadable; presentation of circus performances; presentation of variety shows; presentation of live performances; theatre productions; conducting guided climbing tours; conducting fitness classes; educational examination; film production, other than advertising films; rental of audio equipment; rental of video cameras; rental of video cassette recorders; rental of videotapes; rental of show scenery; rental of sound recordings; toy rental; rental of cinematographic apparatus; rental of motion pictures; games equipment rental; rental of stadium facilities; rental of lighting apparatus for theatrical sets or television studios; rental of radio and television sets; rental of skin diving equipment; rental of sports equipment, except vehicles; rental of stage scenery; rental of training simulators; electronic desktop publishing; online publication of electronic books and journals; publication of texts, other than publicity texts; radio entertainment; entertainment services; writing of texts; sado instruction [tea ceremony instruction]; zoological garden services; news reporters services; film directing, other than advertising films; party planning [entertainment]; music composition services; subtitling; tutoring; holiday camp services [entertainment]; video editing services for events; conducting guided tours; disc jockey services; sound

engineering services for events; game services provided online from a computer network; personal trainer services [fitness training]; providing casino facilities [gambling]; calligraphy services; karaoke services; club services [entertainment or education]; songwriting; cultural, educational or entertainment services provided by art galleries; providing museum facilities [presentation, exhibitions]; teaching; educational services provided by special needs assistants; educational services provided by schools; orchestra services; translation; scriptwriting, other than for advertising purposes; physical fitness assessment services for training purposes; face painting; ticket agency services [entertainment]; educational examination for users to qualify to pilot drones; coaching [training]; lighting technician services for events; sport camp services; recording studio services; nursery schools; photography; photographic reporting; timing of sports events; boarding school education; production of shows; mobile library services; health club services [health and fitness training]; arranging and conducting of in-person educational forums; organization of lotteries and other gambling activities.

42 – Water analysis; computer system analysis; handwriting analysis [graphology]; chemical analysis; rental of meters for the recording of energy consumption; energy auditing; recovery of computer data; business card design; graphic design of promotional materials; industrial design; graphic arts design; computer virus protection services; oil-field surveys; geological surveys; engineering; installation of computer software; meteorological information; clinical trials; material testing; textile testing; bacteriological research; biological research; geological research; research in the field of environmental protection; cosmetic research; mechanical research; research in the field of welding; research in the field of building construction; research in the field of telecommunications technology; research in the field of physics; chemical research; research and development of new products for others; medical research; scientific and technological research relating to patent mapping; scientific and technological research in the field of natural disasters; scientific research; analysis for oil-field exploitation; underwater exploration; technological research; calibration [measuring]; website design consultancy; computer security consultancy; information technology [IT] consultancy; computer technology consultancy; consultancy in the design and development of computer hardware; architectural consultancy; internet security consultancy; computer software consultancy; data security consultancy; technological consultancy; oil-well testing; quality control; vehicle roadworthiness testing; land surveying; dress designing; updating of computer software; monitoring of computer systems to detect breakdowns; monitoring of computer systems for detecting unauthorized access or data breach; monitoring of computer systems by remote access; software as a service [SaaS]; maintenance of compu-

ter software; authenticating works of art; design of interior decor; quality evaluation of standing timber; quality evaluation of wool; digitization of documents [scanning]; conversion of data or documents from physical to electronic media; urban planning; providing information relating to computer technology and programming via a website; providing search engines for the internet; conversion of computer programs and data, other than physical conversion; conducting technical project studies; computer system design; rental of web servers; computer rental; rental of computer software; unlocking of mobile phones; geological prospecting; oil prospecting; hosting computer sites [web sites]; development of computer platforms; construction drafting; computer software design; software development in the framework of software publishing; cloud seeding; server hosting; consultancy in the field of energy-saving; creating and designing website-based indexes of information for others [information technology services]; creating and maintaining websites for others; computer programming; technical writing; copying of computer programs; cloud computing; architectural services; information technology services provided on an outsourcing basis; chemistry services; packaging design; off-site data backup; telecommunications technology consultancy; scientific laboratory services; user authentication services using single sign-on technology for online software applications; user authentication services using technology for e-commerce transactions; weather forecasting; styling [industrial design]; cartography services; exploration services in the field of the oil, gas and mining industries; data encryption services; electronic data storage; surveying; electronic monitoring of credit card activity to detect fraud via the internet; electronic monitoring of personally identifying information to detect identity theft via the internet; interior design; providing scientific information, advice and consultancy relating to carbon offsetting; platform as a service [PaaS].

(260) AM 2022 117879 A

(800) 1662435

(151) 2022 01 19

(891) 2022 01 19

(731) Alois Auer S.à r.l.

7, rue Robert Stümper, L-2557 Luxembourg,  
Luxembourg

9540)



(591) Black, white

(531) 26.04.01; 26.04.05; 26.04.18; 26.04.24;  
27.05.01; 27.05.24

(511)

9 – 3D scanners; stereoscopic equipment for 3D display; augmented reality software for creating and accessing augmented reality experiences; virtual reality software for creating and accessing virtual reality experiences; virtual and augmented reality software; augmented reality software for tracking objects; downloadable computer software for blockchain technology; augmented reality software for creating works.

16 – Mural art works reproduced in 3D using cardboard; mural art works reproduced in 3D using paper; 3D reproduction of paintings (works of art); 3D reproductions of art prints.

35 – Business organization advice in the artistic field; retailing of works of art; auctioneering; advice and information with respect to the retailing of works of art; advertising, advertising and consultancy and advisory services relating to business concerning the purchase of works of art; retail services for works of art, paintings [pictures], pictures [paintings], framed or unframed, painting reproductions [works of art], 3D picture reproductions [paintings], framed or unframed, art prints, 3D wall art; online retail services for works of art, paintings [pictures], pictures [paintings], framed or unframed, painting reproductions [works of art], 3D picture reproductions [paintings], framed or unframed, art prints, 3D wall art.

40 – 3D printing services; custom 3D printing services for third parties.

41 – Cultural services; cultural activities; organization and conducting of colloquiums, seminars, conferences, symposiums, congresses, internships for cultural or artistic purposes; organization of exhibitions for cultural or artistic purposes; organization of exhibitions and trade fairs for professionals or the general public for cultural or educational purposes in the field of art; design and organization of events and exhibitions for cultural and artistic purposes; publishing and editing of illustrated works and books; organization and conducting of online virtual art exhibitions; hosting of online virtual art exhibitions; entertainment in the nature of virtual art exhibitions; providing online art exhibitions for cultural or educational purposes; all these services not related to gambling, games of chance, luck and knowledge.

42 – Computer services, namely, providing online pages featuring user-defined or user-specified virtual reality and augmented reality information, content and data; Blockchain as a Service [BaaS] for the purchase and sale of non-fungible tokens; user authentication services using blockchain technology; data storage by means of blockchains; certification of data by means of blockchains; Blockchain as a Service [BaaS]; enc-

ryption, decryption and authentication of information, messages and data.

(260) AM 2022 117880 A

(800) 1662446

(151) 2021 07 15

(891) 2021 07 15

(731) Clinical Trial Center SRL

Str. Rapsodie nr. 2, Mun. Timișoara, jud.

Timiș, Timișoara, Romania

(540)



(591) Dark blue, light blue, violet, white and black

(531) 26.02.01; 26.02.03; 26.02.07; 26.02.24;  
29.01.14

(511)

42 – Design services; IT services (term considered too vague by the International Bureau – Rule 13 (2) (b) of the Regulations); science and technology services (term considered too vague by the International Bureau – Rule 13 (2) (b) of the Regulations); testing, authentication and quality control.

44 – Animal grooming services; agriculture, aquaculture, horticulture and forestry services; animal healthcare services; human healthcare services; human hygiene and beauty care; pet grooming.

(260) AM 2022 117881 A

(800) 1662472

(151) 2022 03 11

(891) 2022 03 11

(731) Obshchestvo s ogranichennoy otvetstvennostyu "STUDEX"

Dmitrovskoe shosse, d. 100, str. 2, of. 3274,

RU-127247 Moscow, Russian Federation

(540)



(591) Black, white

(531) 01.01.12; 02.03.01; 02.03.16; 27.05.03;  
27.05.19

(511)

3 – Cosmetic preparations for skin care; skin cleansers, non-medicated.

5 – Disinfectants for hygiene purposes; antiseptic cleansers.

10 – Medical instruments; medical apparatus and instruments for cosmetic surgery.

14 – Precious metals and their alloys; imitation jewellery; earrings; studs [earrings]; pierced earrings; jewellery; precious and semi-precious gems.

(260) AM 2022 117882 A

(800) 1662487

(151) 2022 04 05

(891) 2022 04 05

(731) JOINT STOCK COMPANY "FATS AND OIL INTEGRATED WORKS"

UL. TITOVA, 27, EKATERINBURG,

RU-620085 SVERDLOVSKAYA OBLAST,

Russian Federation

(540)



(591) Green

(531) 26.01.03; 26.01.24; 27.05.01; 27.05.17;  
28.05; 29.01.03

(511)

29 – Margarine; vegetable fats for food; edible fats; vegetable oils for food; high oleic oils for food; lecithin for culinary purposes.

30 – Ketchup [sauce]; mayonnaise; mayonnaise sauce; sauces [condiments]; pasta sauce; condiments; spices; seasonings; dressings for salad; food dressings on the base of vegetable oils; mustard.

(260) AM 2022 117883 A

(800) 1662488

(151) 2022 04 05

(891) 2022 04 05

(731) JOINT STOCK COMPANY "FATS AND OIL INTEGRATED WORKS"

UL. TITOVA, 27, EKATERINBURG,

RU-620085 SVERDLOVSKAYA OBLAST,

Russian Federation

(540)



(591) Green and light green

(531) 26.01.03; 26.04.04; 26.04.05; 26.04.18;  
26.04.24; 27.05.01; 27.05.24; 29.01.12

(511)

29 – Margarine; vegetable fats for food; edible fats; vegetable oils for food; high oleic oils for food; lecithin for culinary purposes.

30 – Ketchup [sauce]; mayonnaise; mayonnaise sauce; sauces [condiments]; pasta sauce; condiments; spices; seasonings; dressings for salad; food dressings on the base of vegetable oils; mustard.

(260) AM 2022 117969 A

(800) 1302336

(151) 2016 05 10

(891) 2022 05 06

(731) Ace Rent A Car Reservations, Inc.

902 E. Market Street, Indianapolis IN 46202,  
USA

(540)

## Ace Rent A Car

(591) Black, white

(526) RENT A CAR

(511)

39 – Automobile rental services.

(260) AM 2022 117970 A

(800) 1304713

(151) 2016 05 10

(891) 2022 05 06

(731) Ace Rent A Car Reservations, Inc.

902 E. Market Street, Indianapolis IN 46202,  
USA

(540)



(591) Black, white

(531) 26.11.03; 26.11.09; 27.05.08; 27.05.17

(526) RENT A CAR

(511)

39 – Automobile rental services.

(260) AM 2022 117974 A

(800) 1642003

(151) 2021 11 19

(891) 2022 05 02

(731) Jungheinrich Aktiengesellschaft

Friedrich-Ebert-Damm 129, 22047 Hamburg,  
Germany

(540)

## POWERCUBE

(591) Black, white

(511)

6 – Structures and transportable buildings of metal; warehouses of metal; metal storage shelters; racks

[structures] of metal; storage containers of metal; chests of metal; bins of metal; containers of metal [storage, transport]; storage containers of metal; containers of metal for transport; pallet racks of metal; storage pallets of metal; buildings of metal; prefabricated metal buildings; modular building units (metal-); ready made building components [metal]; modular portable building units of metal; modular portable buildings of metal; structures of metal; modular portable building structures [metal]; metal trim for buildings; frameworks of metal; framework of metal for building; modular prefabricated steel framing; frames of metal for building; blocks (metal-) for construction; latticework of metal; metal panels; faceplates of metal; uprights of metal; laths of metal; joists of iron or steel; metal flooring; building beams (metal-); steel rails; sliding rails of metal; guide rails of metal; metal sheet, strip and coil; racks [structures] of metal; frameworks of metal; handling pallets of metal.

7 – Moving and handling equipment; transferring machines; transporting machines; conveyors [machines]; conveyors; batch loading machines; machines for the handling of materials.

20 – Racks [furniture]; shelving units; portable boxes [containers] of plastic; containers, not of metal, for storage; containers, not of metal [storage, transport]; boxes for stacking purposes [plastic]; bins, not of metal.

(260) AM 2022 117975 A

(800) 1657078

(151) 2022 01 24

(891) 2022 05 02

(731) BWT Holding GmbH

Walter Simmer-Straße 4, A-5310 Mondsee,  
Austria

(540)

## COSMY THE BOT

(591) Black, white

(511)

7 – Swimming pool equipment, namely circulating pump installations (machines and parts of machines), pneumatic valves; swimming bath cleaning machines; pumps [machines], in particular pumps for counter-current swimming; attrition machines for cleaning; swimming pool cleaning machines; robotic swimming pool cleaning machines; robotic cleaning machines; parts and fittings of the aforesaid goods, not included in other classes; membrane filters for use as parts of machines.

9 – Pool alarms; radio buoys; mobile apps; software for monitoring, analysing, controlling and running physical world operations; measuring, detecting, monitoring and controlling devices.



---

**INTERNATIONAL TRADEMARKS PROTECTED IN GEORGIA**

(260) AM 2022 104485 A  
(800) 1481159  
(151) 2019 07 09  
(181) 2029 07 09  
(891) 2019 07 09  
(511) 07

---

(260) AM 2022 113221 A  
(800) 1362756  
(151) 2017 03 27  
(181) 2027 03 27  
(891) 2021 03 18  
(511) 34

---

(260) AM 2022 115443 A  
(800) 1625993  
(151) 2021 10 20  
(181) 2031 10 20  
(891) 2021 10 20  
(511) 29

---

(260) AM 2022 115444 A  
(800) 1626001  
(151) 2021 10 13  
(181) 2031 10 13  
(891) 2021 10 13  
(511) 12, 20

---

(260) AM 2022 115445 A  
(800) 1626008  
(151) 2021 06 08  
(181) 2031 06 08  
(891) 2021 06 08  
(511) 09, 28, 41

---

(260) AM 2022 115446 A  
(800) 1626009  
(151) 2021 06 08  
(181) 2031 06 08  
(891) 2021 06 08  
(511) 09, 28, 41

---

(260) AM 2022 115461 A  
(800) 1626451  
(151) 2021 05 12  
(181) 2031 05 12

(891) 2021 05 12  
(511) 08, 18

---

(260) AM 2022 115465 A  
(800) 1626643  
(151) 2021 10 15  
(181) 2031 10 15  
(891) 2021 10 15  
(511) 43

---

(260) AM 2022 115466 A  
(800) 1626660  
(151) 2021 06 14  
(181) 2031 06 14  
(891) 2021 06 14  
(511) 09, 25, 28, 35, 38, 41, 42

---

(260) AM 2022 115467 A  
(800) 1626667  
(151) 2021 06 01  
(181) 2031 06 01  
(891) 2021 06 01  
(511) 09, 25, 28, 35, 38, 41, 42

---

(260) AM 2022 115468 A  
(800) 1626685  
(151) 2021 10 22  
(181) 2031 10 22  
(891) 2021 10 22  
(511) 03

---

(260) AM 2022 115484 A  
(800) 1627396  
(151) 2021 06 16  
(181) 2031 06 16  
(891) 2021 06 16  
(511) 35, 41

---

(260) AM 2022 115485 A  
(800) 1627444  
(151) 2021 06 18  
(181) 2031 06 18  
(891) 2021 06 18  
(511) 10, 24, 30, 35

---

(260) AM 2022 115486 A  
(800) 1627480  
(151) 2021 07 13  
(181) 2031 07 13  
(891) 2021 07 13  
(511) 09

---

(260) AM 2022 115495 A  
(800) 1191078  
(151) 2013 12 06  
(181) 2023 12 06  
(891) 2021 10 20  
(511) 35, 38, 42

---

(260) AM 2022 115488 A  
(800) 1627522  
(151) 2021 07 27  
(181) 2031 07 27  
(891) 2021 07 27  
(511) 01, 02, 17, 19

---

(260) AM 2022 115496 A  
(800) 1403682  
(151) 2018 03 21  
(181) 2028 03 21  
(891) 2021 11 03  
(511) 05

---

(260) AM 2022 115489 A  
(800) 1627527  
(151) 2021 10 01  
(181) 2031 10 01  
(891) 2021 10 01  
(511) 35

---

(260) AM 2022 115497 A  
(800) 1449482  
(151) 2018 10 12  
(181) 2028 10 12  
(891) 2021 10 20  
(511) 09, 16, 28, 38, 41, 42

---

(260) AM 2022 115490 A  
(800) 1627529  
(151) 2021 09 24  
(181) 2031 09 24  
(891) 2021 09 24  
(511) 07, 37, 42

---

(260) AM 2022 115498 A  
(800) 1449517  
(151) 2018 10 12  
(181) 2028 10 12  
(891) 2021 10 20  
(511) 16, 38, 42

---

(260) AM 2022 115491 A  
(800) 1627537  
(151) 2021 10 07  
(181) 2031 10 07  
(891) 2021 10 07  
(511) 03

---

(260) AM 2022 115613 A  
(800) 1628997  
(151) 2021 07 26  
(181) 2031 07 26  
(891) 2021 07 26  
(511) 05

---

(260) AM 2022 115492 A  
(800) 1627555  
(151) 2021 08 31  
(181) 2031 08 31  
(891) 2021 08 31  
(511) 12

---

(260) AM 2022 115614 A  
(800) 1629108  
(151) 2021 09 08  
(181) 2031 09 08  
(891) 2021 09 08  
(511) 03

---

(260) AM 2022 115494 A  
(800) 1098654  
(151) 2011 09 23  
(181) 2031 09 23  
(891) 2021 10 01  
(511) 03

---

(260) AM 2022 115615 A  
(800) 1629118  
(151) 2021 09 27  
(181) 2031 09 27  
(891) 2021 09 27  
(511) 06, 20

---

(260) AM 2022 115617 A  
(800) 1629165  
(151) 2021 06 15  
(181) 2031 06 15  
(891) 2021 06 15  
(511) 03, 21

---

(260) AM 2022 115724 A  
(800) 1631803  
(151) 2021 08 17  
(181) 2031 08 17  
(891) 2021 08 17  
(511) 35, 41

---

(260) AM 2022 115618 A  
(800) 1629239  
(151) 2021 09 28  
(181) 2031 09 28  
(891) 2021 09 28  
(511) 09, 10, 42

---

(260) AM 2022 115725 A  
(800) 1631804  
(151) 2021 08 17  
(181) 2031 08 17  
(891) 2021 08 17  
(511) 35, 41

---

(260) AM 2022 115719 A  
(800) 1631569  
(151) 2021 09 16  
(181) 2031 09 16  
(891) 2021 09 16  
(511) 31, 35

---

(260) AM 2022 115726 A  
(800) 1631819  
(151) 2021 10 30  
(181) 2031 10 30  
(891) 2021 10 30  
(511) 09, 35, 39, 42

---

(260) AM 2022 115720 A  
(800) 1631690  
(151) 2021 08 12  
(181) 2031 08 12  
(891) 2021 08 12  
(511) 03

---

(260) AM 2022 115727 A  
(800) 1631914  
(151) 2020 11 20  
(181) 2030 11 20  
(891) 2020 11 20  
(511) 29, 30, 35, 43

---

(260) AM 2022 115721 A  
(800) 1631700  
(151) 2021 10 28  
(181) 2031 10 28  
(891) 2021 10 28  
(511) 09

---

(260) AM 2022 115728 A  
(800) 1631920  
(151) 2021 06 03  
(181) 2031 06 03  
(891) 2021 06 03  
(511) 29

---

(260) AM 2022 115722 A  
(800) 1631743  
(151) 2021 09 30  
(181) 2031 09 30  
(891) 2021 09 30  
(511) 28

---

(260) AM 2022 115811 A  
(800) 1633794  
(151) 2021 10 15  
(181) 2031 10 15  
(891) 2021 10 15  
(511) 32, 33

---

(260) AM 2022 115723 A  
(800) 1631802  
(151) 2021 08 17  
(181) 2031 08 17  
(891) 2021 08 17  
(511) 35, 41

---

(260) AM 2022 115812 A  
(800) 1633802  
(151) 2021 10 14  
(181) 2031 10 14  
(891) 2021 10 14  
(511) 09

---

(260) AM 2022 115813 A  
(800) 1633865  
(151) 2021 11 08  
(181) 2031 11 08  
(891) 2021 11 08  
(511) 05

---

(260) AM 2022 115814 A  
(800) 1633879  
(151) 2021 11 07  
(181) 2031 11 07  
(891) 2021 11 07  
(511) 09

---

(260) AM 2022 115815 A  
(800) 1633916  
(151) 2021 07 28  
(181) 2031 07 28  
(891) 2021 07 28  
(511) 35

---

(260) AM 2022 115816 A  
(800) 1633970  
(151) 2021 10 11  
(181) 2031 10 11  
(891) 2021 10 11  
(511) 29

---

(260) AM 2022 115817 A  
(800) 949642  
(151) 2007 09 17  
(181) 2027 09 17  
(891) 2021 12 01  
(511) 30

---

(260) AM 2022 115818 A  
(800) 999870  
(151) 2009 02 23  
(181) 2029 02 23  
(891) 2021 10 12  
(511) 18, 25

---

(260) AM 2022 115819 A  
(800) 1026597  
(151) 2009 12 30  
(181) 2029 12 30  
(891) 2021 10 12  
(511) 18, 25

---

(260) AM 2022 116254 A  
(800) 1639271  
(151) 2021 10 04  
(181) 2031 10 04  
(891) 2021 10 04  
(511) 30, 32, 33

---

(260) AM 2022 116255 A  
(800) 1639398  
(151) 2021 04 28  
(181) 2031 04 28  
(891) 2021 04 28  
(511) 29

---

(260) AM 2022 116256 A  
(800) 1639399  
(151) 2021 12 17  
(181) 2031 12 17  
(891) 2021 12 17  
(511) 05

---

(260) AM 2022 116257 A  
(800) 1639431  
(151) 2021 10 21  
(181) 2031 10 21  
(891) 2021 10 21  
(511) 09

---

(260) AM 2022 116259 A  
(800) 1639455  
(151) 2021 06 10  
(181) 2031 06 10  
(891) 2021 06 10  
(511) 09, 10, 41, 44

---

(260) AM 2022 116260 A  
(800) 1639457  
(151) 2020 12 21  
(181) 2030 12 21  
(891) 2020 12 21  
(511) 01, 08, 10, 11, 17, 20, 21, 28, 35

---

(260) AM 2022 116261 A  
(800) 1639461  
(151) 2021 05 26  
(181) 2031 05 26  
(891) 2021 05 26  
(511) 31

---

(260) AM 2022 116262 A  
(800) 1639466  
(151) 2021 08 13  
(181) 2031 08 13  
(891) 2021 08 13  
(511) 10

---

(260) AM 2022 116663 A  
(800) 1637893  
(151) 2021 11 21  
(181) 2031 11 21  
(891) 2021 11 21  
(511) 43

---

---

**APPELLATIONS OF ORIGIN OF GOODS**  
**REGISTERED APPELLATION OF ORIGIN OF GOODS**

(111) 985

(151) 2022 12 12

(732) LTD "Ethno Okami"

Kandelaki Str. 8b, ap. 39, Tbilisi, Georgia

(540)

**OKAMI**

(511) 33 – Wine.

---

---

## AMENDMENTS IN PDO WINE PRODUCTION SPECIFICATION

In accordance with the Order №10950/06, 14.12.2022, of the Acting Head of Department of Trademarks, Geographical Indications and Design of the LEPL National Intellectual Property Center of Georgia – SAKPATENTI, amendment was entered in the production specification of appellations of origin of wine registered at Sakpatenti: **Kisi Magraani** (Reg. №981; 31.05.2021).

In accordance with the Law of Georgia on Appellations of Origin of Goods and Geographical Indications, abovementioned information shall be published in the Official Bulletin of Industrial Property of Georgia, as well as in one central and in one local newspaper.

Within 3 months after the publication of the application materials, the notes and additional information regarding these materials submitted with Sakpatenti shall be sent to the Ministry of Environmental Protection and Agriculture of Georgia for the review. If within 3 months no information is submitted with Sakpatenti regarding abovementioned materials, the published data shall be reflected in the State Registry of Appellations of Origin and Geographical Indications.

Amendments shall be made for PDO Wine "**Kisi Magraani**" Specification Article 2(2.3), as following:

### KISI MAGRAANI

#### "2.3. Physical and Chemical Characteristics of Product.

Wine "Kisi Magraani" white dry shall satisfy the following requirements:

- Actual volumetric spirit content – no less than 11 %;
- Common volumetric spirit content – no more than 15 %;
- Sugar content – no more than 4 g/l;
- **Titratable acidity in young wine should be – no less than 5 g/l, in aged wine – no less than 4.3 g/l;**
- Volatile acidity – no more than 1.0 g/l;
- Sulfur dioxide common mass concentration – no more than 200 mg/l;
- Sugar free extract mass concentration – no less than 16 mg/l.

Wine "Kisi Magraani" amber dry shall satisfy the following requirements:

- Actual volumetric spirit content – no less than 12 %;
- Common volumetric spirit content – no more than 15 %;
- Sugar content – no more than 4 g/l;
- **Titratable acidity should be – no less than 3.5 g/l;**
- Volatile acidity – no more than 1.2 g/l;
- Sulfur dioxide common mass concentration – no more than 150 mg/l;
- Sugar free extract mass concentration – no less than 22 mg/l."

---

**OFFICIAL NOTIFICATIONS  
INVENTIONS  
RESTORATION OF PATENTS**

(21) AP 2013 13247  
(11) P 2019 6994 B  
(73) Ivane Beroshvili;  
Absalom Beroshvili;  
Teimuraz Kechiani  
(54) METHOD FOR GAS INJECTION  
DATE OF PATENT CANCELLATION: 2022 09 27  
DATE OF PATENT RESTORATION: 2022 12 26

---

(21) AP 2005 9784  
(11) P 2009 4681 B  
(73) Takeda AS  
(54) AGGLOMERATION OF CALCIUM-CONTAINING COMPOUND OBTAINED BY ROLLER  
COMPACTION  
DATE OF PATENT CANCELLATION: 2022 05 24  
DATE OF PATENT RESTORATION: 2022 12 26

---

(21) AP 2005 9802  
(11) P 2010 4896 B  
(73) Takeda AS  
(54) CHEWABLE, SUCKABLE AND SWALLOWABLE TABLET CONTAINING A CALCIUM-  
CONTAINING COMPOUND AS AN ACTIVE SUBSTANCE  
DATE OF PATENT CANCELLATION: 2022 05 24  
DATE OF PATENT RESTORATION: 2022 12 26

---

**ABOLITION OF PATENTS WITH THE RIGHT TO RESTORE**

(21) AP 2008 11833  
(11) P 2012 5646 B  
(73) JSC "Grindex"  
(54) 3-(2,2,2-TRIMETHYLHYDRAZINIUM) PROPIONATE SALTS FOR ISCHEMIC HEART DISEASE  
TREATMENT  
DATE OF PATENT CANCELLATION: 2022 12 03  
LIMITED DATE OF PATENT RESTORATION: 2023 12 03

---

(21) AP 2008 11836  
(11) P 2013 5911 B  
(73) Turkcell Teknoloji Arastirma & Gelistirme Anonim Sirketi  
(54) GSM TRAFFIC MANAGEMENT SYSTEM  
DATE OF PATENT CANCELLATION: 2022 11 24  
LIMITED DATE OF PATENT RESTORATION: 2023 11 24

---



(21) AP 2013 13863  
(11) P 2017 6718 B  
(73) Pfizer Inc.  
(54) ARYL AND HETEROARYL FUSED LACTAMS  
DATE OF PATENT CANCELLATION: 2022 12 05  
LIMITED DATE OF PATENT RESTORATION: 2023 12 05

---

(21) AP 2017 15120  
(11) P 2020 7137 B  
(73) Medid Innovation Development LTD  
(54) ANTISEPTIC COMPOSITION COMPRISING UNITHIOL AND DIMETHYLSULFOXIDE, USE OF THE  
COMPOSITION AND METHOD OF WOUND TREATMENT WITH ITS USE  
DATE OF PATENT CANCELLATION: 2022 12 05  
LIMITED DATE OF PATENT RESTORATION: 2023 12 05

---

(21) AP 2017 15121  
(11) P 2022 7353 B  
(73) Merck Sharp & Dohme Corp.  
(54) TETRACYCLIC HETEROCYCLE COMPOUNDS USEFUL AS HIV INTEGRASE INHIBITORS  
DATE OF PATENT CANCELLATION: 2022 11 30  
LIMITED DATE OF PATENT RESTORATION: 2023 11 30

---

## EXPIRATION OF PATENTS RESTORATION DATE

(21) AP 2010 12757  
(11) P 2014 6206 B  
(73) RV Lizenz AG  
(54) THERMAL-CHEMICAL UTILIZATION OF CARBON-CONTAINING MATERIALS, IN PARTICULAR  
FOR THE EMISSION-FREE GENERATION OF ENERGY  
DATE OF PATENT CANCELLATION: 2021 11 19  
DATE OF PATENT RESTORATION EXPIRATION: 2022 11 19

---

(21) AP 2013 13845  
(11) P 2018 6839 B  
(73) Chiesi Farmaceutici S.P.A.  
(54) COMPOUNDS HAVING MUSCARINIC RECEPTOR ANTAGONIST AND BETA 2 ADRENERGIC  
RECEPTOR AGONIST ACTIVITY  
DATE OF PATENT CANCELLATION: 2021 12 05  
DATE OF PATENT RESTORATION EXPIRATION: 2022 12 05

---

(21) AP 2018 14929  
(11) P 2020 7116 B  
(73) Savle Chkhitunidze  
(54) SOIL TREATMENT TOOL  
DATE OF PATENT CANCELLATION: 2021 11 21  
DATE OF PATENT RESTORATION EXPIRATION: 2022 11 21

---

## EXPIRATION OF TERMS OF PATENTS

(21) AP 2012 12912

(11) P 2015 1855 B

(73) N(N)LE "Tbilisi State Medical University"

(54) METHOD OF TRITERPENIC SAPONINS PRODUCTION HAVING ANTIINFLAMMATORY  
ACTIVITY AT INFLAMMATIONS OF NOSE APPENDAGES AND AURICLE SINUS

DATE OF PATENT EXPIRATION: 2022 12 06

---

(21) AP 2002 8284

(11) P 2006 3875 B

(73) Merck Sharp & Dohme LLC

(54) PHARMACEUTICAL NANOPARTICULATE COMPOSITION OF A TACHYKININ RECEPTOR  
ANTAGONIST

DATE OF PATENT EXPIRATION: 2022 12 09

---

## TRANSFER OF RIGHTS

(21) AP 2015 14450

(11) P 2021 7331 B

(54) ANTI-TIGIT ANTIBODIES

NAME AND ADDRESS OF NEW PATENT OWNER: Merck Sharp & Dohme LLC (US)

26 East Lincoln Ave., P.O.Box 2000, Rahway,  
New Jersey, 07065, USA (US)

NAME AND ADDRESS OF FORMER PATENT OWNER: Merck Sharp & Dohme Corp.

126 East Lincoln Ave., Rahway, New Jersey,  
07065-0907, USA (US)

DATE OF REGISTRATION: 2022 12 11

---

## CHANGE OF NAME AND/OR ADDRESS OF PATENT OWNER

(21) AP 2016 14720

(11) P 2021 7326 B

(54) CONSTRUCTS HAVING A SIRP-ALPHA DOMAIN OR VARIANT THEREOF

NAME AND ADDRESS OF NEW PATENT OWNER: ALX Oncology Inc. (US)

323 Allerton Avenue, South San Francisco, CA , 94080,  
USA (US)

NAME AND ADDRESS OF FORMER PATENT OWNER: ALX Oncology Inc. (US)

866 Malcolm Road, Suite 100, Burlingame, CA,

94010, USA (US)

DATE OF REGISTRATION: 2022 12 11

---

## UTILITY MODELS RESTORATION OF PATENT

(21) AU 2018 14928  
(11) U 2020 2030 Y  
(73) Marine Nikolaishvili;  
Tea Muselian;  
Elene Giorgadze;  
Natia Chkheidze  
(54) THERAPEUTIC AGENT FOR TYPE II DIABETES  
DATE OF PATENT CANCELLATION: 2022 11 20  
DATE OF PATENT RESTORATION: 2022 12 26

---

## ABOLITION OF PATENT WITH THE RIGHT TO RESTORE

(21) AU 2018 14928  
(11) U 2020 2030 Y  
(73) Marine Nikolaishvili;  
Tea Muselian;  
Elene Giorgadze;  
Natia Chkheidze  
(54) THERAPEUTIC AGENT FOR TYPE II DIABETES  
DATE OF PATENT CANCELLATION: 2022 11 20  
LIMITED DATE OF PATENT RESTORATION: 2024 11 20

---

## EXPIRATION OF PATENT RESTORATION DATE

(21) AU 2018 14944  
(11) U 2019 2023 Y  
(73) Revaz Sikharulidze  
(54) DEVICE FOR FLEXIBLE ROD  
DATE OF PATENT CANCELLATION: 2021 11 30  
DATE OF PATENT RESTORATION EXPIRATION: 2022 11 30

---

**TRADEMARKS****EXTENSION OF TERMS OF TRADEMARKS REGISTRATION**

(111) M 2002 14501 R2

(156) 2002 06 13

(186) 2032 06 13

(732) JSC "Silknet"

Tsinamdzgvrishvili Str. 95, 0112, Tbilisi,  
Georgia

(111) M 2011 22033 R1

(156) 2011 12 07

(186) 2031 12 07

(732) Guram Darsania

Mosashvili Str. 5, app. 42, 0162, Tbilisi,  
Georgia

(111) M 2003 14922 R2

(156) 2003 01 30

(186) 2033 01 30

(732) G.G. Properties LTD

Thistle House, 4 Burnaby Street, Hamilton,  
HM 11, United Kingdom

(111) M 2012 22991 R1

(156) 2012 10 09

(186) 2032 10 09

(732) LTD "Simetra"

Ateni Str. 20, app. 28, 0179, Tbilisi, Georgia

(111) M 2002 14804 R2

(156) 2002 11 15

(186) 2032 11 15

(732) Eaton Eleqtrical IP GmbH & Co. KG

Aiport Center Schönefeld, Mittelstrasse 5-5a,  
12529 Schönefeld, Germany

(111) M 2012 22946 R1

(156) 2012 09 24

(186) 2032 09 24

(732) Davit Asatiani

Mosashvili Str. 6, 0162, Tbilisi, Georgia

(111) M 2002 14818 R2

(156) 2002 11 28

(186) 2032 11 28

(732) Johnson & Johnson

One Johnson & Johnson Plaza,  
New Brunswick, New Jersey 08933, USA

(111) M 2012 22674 R1

(156) 2012 06 07

(186) 2032 06 07

(732) LTD "Saga Impex"

Chachava Str. 2-4-6-8-10, 0159, Tbilisi, Georgia

(111) M 2003 14948 R2

(156) 2003 01 30

(186) 2033 01 30

(732) Novo Nordisk A/S

Novo Alle, DK-2880 Bagsvaerd, Denmark

(111) M 2012 23007 R1

(156) 2012 10 09

(186) 2032 10 09

(732) Itunkaya Insaat Nakliyat Gida Tikaret Anonim  
Sirketi

Gezimuhtarpara Bulvari Kalyon Ismerkezi K:4  
No:14 Gaziantep, Türkiye

(111) M 2003 15133 R2

(156) 2003 05 19

(186) 2033 05 19

(732) Ipr Pharmaceuticals Inc.

Road 188, Lot 17, San Isidro Industrial Park,  
Canovanas, PR 00729 Puerto Rico, USA

(111) M 2012 23111 R1

(156) 2012 11 29

(186) 2032 11 29

(732) PZ Cussons (International) Limited

3500 Aviator Way, Manchester Business  
Park, Manchester M22 5TG, United Kingdom

(111) M 2003 15328 R2

(156) 2003 11 14

(186) 2033 11 14

(732) Grindeks a Joint Stock Company

53, Krustpils Street, 1057 Riga, Latvia

(111) M 2013 23446 R1

(156) 2013 03 13

(186) 2033 03 13

(732) Universal City Studios LLC

100 Universal City Plaza, Universal City,  
California 91608, USA

(111) M 2013 23447 R1  
(156) 2013 03 13  
(186) 2033 03 13  
(732) Universal City Studios LLC  
100 Universal City Plaza, Universal City,  
California 91608, USA

---

(111) M 2013 24038 R1  
(156) 2013 09 17  
(186) 2033 09 17  
(732) AstraZeneca AB  
Vastra Malarehamnen 9, SE-151 85 Sodertalje,  
Sweden

---

(111) M 2013 23260 R1  
(156) 2013 01 18  
(186) 2033 01 18  
(732) Dotchirne Pidpriemstvo Konditerska  
Korporatzia "Roshen"  
1 Nauky Avenue, building 1, Kyiv 03039,  
Ukraine

---

(111) M 2013 23474 R1  
(156) 2013 03 18  
(186) 2033 03 18  
(732) Pasha Bank OJSC  
15 Yusif Mammadaliyev Street, Sabail district,  
Baku AZ 1005, Azerbaijan

---

(111) M 2013 23470 R1  
(156) 2013 03 18  
(186) 2033 03 18  
(732) Pasha Bank OJSC  
15 Yusif Mammadaliyev Street, Sabail district,  
Baku AZ 1005, Azerbaijan

---

(111) M 2013 23471 R1  
(156) 2013 03 18  
(186) 2033 03 18  
(732) Pasha Bank OJSC  
15 Yusif Mammadaliyev Street, Sabail district,  
Baku AZ 1005, Azerbaijan

---

## COMPLETE TRANSFER OF RIGHTS

(111) M 2019 31486 R  
(732) Natia Chigirinskaya  
Kutuzov Ave. 24, app. 112, Moscow, Russian  
Federation

(770) SAM Support and Management LLC  
Iasamani Str. 6, app. 112, Saburtalo district,  
Tbilisi, Georgia  
(580) 2022 11 09

(111) M 2021 33890 R  
(732) Natia Chigirinskaya  
Kutuzovsky Ave. 24, app. 112, Moscow,  
Russian Federation

(770) SAM Support and Management LLC  
Iasamani Str. 6, app. 112, Saburtalo District,  
Tbilisi, Georgia  
(580) 2022 11 09

(111) M 2022 35160 R  
(732) LTD "Bekauri Family Vineyards"  
Iosebidge Str. 72, ap. 27, 0160, Saburtalo  
District, Tbilisi, Georgia

(770) Tamaz Bekauri  
Otar Oniashvili Str. 89, ap. 2, 0160,  
Tbilisi, Georgia  
(580) 2022 11 15

(111) M 2022 35759 R  
(732) LTD "Bekauri Family Vineyards"  
Iosebidge Str. 72, ap. 27, 0160, Saburtalo  
District, Tbilisi, Georgia

(770) Tamaz Bekauri  
Otar Oniashvili Str. 89, ap. 2, 0160,  
Tbilisi, Georgia  
(580) 2022 11 15

(111) M 2014 25338 R  
(732) JSC "Silknet"  
Tsinamdzgvrishvili Str. 95, 0112, Tbilisi,  
Georgia

(770) LTD "Geocell"  
Right bank of the river Mtkvari, Gotua Str. 3,  
0160, Tbilisi, Georgia  
(580) 2022 11 17

(111) M 2015 26493 R  
(732) LTD "Company Besini"  
Gamrekeli Str. 19, 0160, Saburtalo District,  
Tbilisi, Georgia

(770) LTD "Rossoft Consulting"

Shalva Nutsbidze's Slope, Ivmer., bld. 11,  
ap. 90, 0183, Tbilisi, Georgia  
(580) 2022 11 15

(111) M 2016 27213 R  
(732) JSC "Silknet"  
Tsinamdzgvrishvili Str. 95, 0112, Tbilisi,  
Georgia  
(770) LTD "Geocell"  
Right bank of the river Mtkvari, Gotua Str. 3,  
0160, Tbilisi, Georgia

(580) 2022 11 17

(111) M 2019 30820 R  
(732) LTD "Company Besini"  
Gamrekeli Str. 19, 0160, Saburtalo District,  
Tbilisi, Georgia

(770) LTD "Vite Veta"  
Zakaria Paliashvili Str. 33a, 0179, Tbilisi,  
Georgia  
(580) 2022 11 15

(111) M 2018 29768 R  
(732) LTD "Company Besini"  
Gamrekeli Str. 19, 0160, Saburtalo District,  
Tbilisi, Georgia

(770) LTD "Rossoft Consulting"  
Shalva Nutsbidze's Slope, Ivmer., bld. 11,  
ap. 90, 0183, Tbilisi, Georgia  
(580) 2022 11 15

## CHANGES OF NAMES AND/OR ADDRESSES OF TRADEMARKS OWNERS

(111) M 1997 4986 R  
(732) Sanofi Mature IP  
82, avenue Raspail - (94250) Gentilly, France  
(770) Sanofi Mature IP  
54 rue La Boétie F-75008 Paris, France  
(580) 2022 11 15

---

(111) M 1997 4987 R  
(732) Sanofi Mature IP  
82, avenue Raspail - (94250) Gentilly, France  
(770) Sanofi Mature IP  
54 rue La Boétie F-75008 Paris, France  
(580) 2022 11 15

---

(111) M 2013 23586 R  
(732) Teijin Limited  
2-4, Nakanoshima 3-chome, Kita-ku,  
Osak, Japan  
(770) Teijin Limited  
6-7, Minamihommachi 1-chome, Chuo-ku,  
Osaka, Japan  
(580) 2022 10 17

---

(111) M 2013 23587 R  
(732) Teijin Limited  
2-4, Nakanoshima 3-chome, Kita-ku,  
Osak, Japan  
(770) Teijin Limited  
6-7, Minamihommachi 1-chome, Chuo-ku,  
Osaka, Japan  
(580) 2022 10 17

---

(111) M 2013 23538 R  
(732) Teijin Limited  
2-4, Nakanoshima 3-chome, Kita-ku,  
Osak, Japan  
(770) Teijin Limited  
6-7, Minamihommachi 1-chome, Chuo-ku,  
Osaka, Japan  
(580) 2022 10 17

---

(111) M 2013 23816 R  
(732) Teijin Limited  
2-4, Nakanoshima 3-chome, Kita-ku,  
Osak, Japan  
(770) Teijin Limited  
6-7, Minamihommachi 1-chome, Chuo-ku,  
Osaka, Japan  
(580) 2022 10 17

---

## CANCELLATION OF TRADEMARK REGISTRATION

(111) M 1998 11069 R  
(151) 1998 11 09  
(732) GlaxoSmithKline Consumer Healthcare (UK)  
IP Limited  
980 Great West Road, Brentford, Middlesex  
TW8 9GS, United Kingdom  
(141) 2022 12 05 – Registration is canceled  
Ground: The Law of Georgia Article 27(1)(A)

---

---

# CLASSIFICATION INDEXES

## INVENTIONS

### CONCORDANCE TABLE OF INTERNATIONAL CLASSIFICATION INDEX AND PUBLICATION NUMBERS

INTERNATIONAL CLASSIFICATION INDEXES (51)	NUMBER OF PUBLISHED APPLICATION (10)
C 04 B 28/14; C 04 B 11/00	AP 2022 15261 A
C 07 B 59/00; C 07 D 295/145	AP 2022 15719 A
C 07 B 59/00; C 07 D 295/145	AP 2022 15720 A
C 07 C 231/02; C 07 C 51/16; C 07 D 265/32	AP 2022 15407 A

### CONCORDANCE TABLE OF PUBLICATION NUMBERS AND INTERNATIONAL CLASSIFICATION INDEX

NUMBER OF PUBLISHED APPLICATION (10)	INTERNATIONAL CLASSIFICATION INDEXES (51)
AP 2022 15261 A	C 04 B 28/14; C 04 B 11/00
AP 2022 15719 A	C 07 B 59/00; C 07 D 295/145
AP 2022 15720 A	C 07 B 59/00; C 07 D 295/145
AP 2022 15407 A	C 07 C 231/02; C 07 C 51/16; C 07 D 265/32

### CONCORDANCE TABLE OF INTERNATIONAL CLASSIFICATION INDEX, PATENT NUMBERS AND PUBLICATION NUMBERS

INTERNATIONAL CLASSIFICATION INDEX (51)	NUMBER OF PATENT (11)	NUMBER OF PUBLISHED APPLICATION (10)
C 04 B 7/36	P 2022 7452 B	AP 2022 15578 A
C 07 D 405/12; C 07 D 403/14; C 07 D 403/12; C 07 D 401/14; C 07 D 401/12; C 07 D 231/40	P 2022 7451 B	AP 2022 15709 A

### CONCORDANCE TABLE OF PATENT NUMBERS, PUBLICATION NUMBERS AND INTERNATIONAL CLASSIFICATION INDEX

NUMBER OF PATENT (11)	NUMBER OF PUBLISHED APPLICATION (10)	INTERNATIONAL CLASSIFICATION INDEX (51)
P 2022 7451 B	AP 2022 15709 A	C 07 D 405/12; C 07 D 403/14; C 07 D 403/12; C 07 D 401/14; C 07 D 401/12; C 07 D 231/40
P 2022 7452 B	AP 2022 15578 A	C 04 B 7/36



**CONCORDANCE TABLE OF APPLICATION NUMBERS,  
PUBLICATION NUMBERS AND PATENTS**

NUMBER OF APPLICATION (21)	NUMBER OF PUBLISHED APPLICATION (10)	NUMBER OF PATENT (11)
AP 2021 15578	AP 2022 15578 A	P 2022 7452 B
AP 2020 15709	AP 2022 15709 A	P 2022 7451 B

**UTILITY MODELS**

**CONCORDANCE TABLE OF INTERNATIONAL CLASSIFICATION INDEX  
AND PUBLICATION NUMBERS**

INTERNATIONAL CLASSIFICATION INDEXES (51)	NUMBER OF PUBLISHED APPLICATION (10)
E 02 B 8/06	AU 2022 15738 U

**CONCORDANCE TABLE OF PUBLICATION NUMBERS  
AND INTERNATIONAL CLASSIFICATION INDEX**

NUMBER OF PUBLISHED APPLICATION (10)	INTERNATIONAL CLASSIFICATION INDEXES (51)
AU 2022 15738 U	E 02 B 8/06

**CONCORDANCE TABLE OF INTERNATIONAL CLASSIFICATION INDEX,  
PATENT NUMBERS AND PUBLICATION NUMBERS**

INTERNATIONAL CLASSIFICATION INDEX (51)	NUMBER OF PATENT (11)	NUMBER OF PUBLISHED APPLICATION (10)
F 24 D 19/00; F 24 H 9/00	U 2022 2141 Y	AU 2022 15765 U

**CONCORDANCE TABLE OF PATENT NUMBERS,  
PUBLICATION NUMBERS AND INTERNATIONAL CLASSIFICATION INDEX**

NUMBER OF PATENT (11)	NUMBER OF PUBLISHED APPLICATION (10)	INTERNATIONAL CLASSIFICATION INDEX (51)
U 2022 2141 Y	AU 2022 15765 U	F 24 D 19/00; F 24 H 9/00

**CONCORDANCE TABLE OF APPLICATION NUMBERS,  
PUBLICATION NUMBERS AND PATENTS**

NUMBER OF APPLICATION (21)	NUMBER OF PUBLISHED APPLICATION (10)	NUMBER OF PATENT (11)
AU 2021 15765	AU 2022 15765 U	U 2022 2141 Y

**DESIGNS**

**CONCORDANCE TABLE OF INTERNATIONAL CLASSIFICATION INDEX,  
NUMBERS OF REGISTRATION AND PUBLICATION NUMBERS**

INTERNATIONAL CLASSIFICATION INDEX (51)	NUMBER OF REGISTRATION (11)	NUMBER OF PUBLISHED APPLICATION (10)
09-01	D 2022 952 S	AD 2022 1262 S
11-01	D 2022 953 S	AD 2022 1264 S

**CONCORDANCE TABLE OF NUMBERS OF REGISTRATION,  
PUBLICATION NUMBERS AND INTERNATIONAL CLASSIFICATION INDEX**

NUMBER OF REGISTRATION (11)	NUMBER OF PUBLISHED APPLICATION (10)	INTERNATIONAL CLASSIFICATION INDEX (51)
D 2022 952 S	AD 2022 1262 S	09-01
D 2022 953 S	AD 2022 1264 S	11-01

**CONCORDANCE TABLE OF APPLICATION NUMBERS,  
PUBLICATION NUMBERS AND NUMBERS OF REGISTRATION**

NUMBER OF APPLICATION (21)	NUMBER OF PUBLISHED APPLICATION (10)	NUMBER OF REGISTRATION (11)
AD 2022 1262	AD 2022 1262 S	D 2022 952 S
AD 2022 1264	AD 2022 1264 S	D 2022 953 S

## DESIGNS REGISTERED ACCORDING TO THE ACCELERATED PROCEDURE

### CONCORDANCE TABLE OF INTERNATIONAL CLASSIFICATION INDEX AND PUBLICATION NUMBERS

INTERNATIONAL CLASSIFICATION INDEXES (51)	NUMBER OF REGISTRATION (11)
07-01	D 2022 951 S

### CONCORDANCE TABLE OF PUBLICATION NUMBERS AND INTERNATIONAL CLASSIFICATION INDEX

NUMBER OF REGISTRATION (11)	INTERNATIONAL CLASSIFICATION INDEXES (51)
D 2022 951 S	07-01

### CONCORDANCE TABLE OF APPLICATION NUMBERS, PUBLICATION NUMBERS AND PATENTS

NUMBER OF APPLICATION (21)	NUMBER OF REGISTRATION (11)
AD 2022 1285	D 2022 951 S

## TRADEMARKS

### CONCORDANCE TABLE OF REGISTRATION NUMBERS, APPLICATION NUMBERS, PUBLICATION NUMBERS AND BULLETIN NUMBERS

NUMBER OF REGISTRATION (111)	NUMBER OF APPLICATIONS (210)	NUMBER OF PUBLISHED APPLICATIONS (260)	NUMBER OF BULLETIN
M 2022 36167 R	AM 114699	AM 2022 114699 A	9(588)2022
M 2022 36174 R	AM 115118	AM 2022 115118 A	9(588)2022
M 2022 36189 R	AM 116220	AM 2022 116220 A	14(593)2022
M 2022 36191 R	AM 112077	AM 2021 112077 A	17(573)2021
M 2022 36192 R	AM 115124	AM 2022 115124 A	11(590)2022
M 2022 36193 R	AM 115125	AM 2022 115125 A	11(590)2022
M 2022 36194 R	AM 115515	AM 2022 115515 A	11(590)2022
M 2022 36195 R	AM 115516	AM 2022 115516 A	11(590)2022
M 2022 36196 R	AM 115599	AM 2022 115599 A	12(591)2022
M 2022 36197 R	AM 115600	AM 2022 115600 A	12(591)2022
M 2022 36218 R	AM 113510	AM 2022 113510 A	2(581)2022
M 2022 36219 R	AM 116318	AM 2022 116318 A	15(594)2022
M 2022 36220 R	AM 116227	AM 2022 116227 A	15(594)2022
M 2022 36221 R	AM 116226	AM 2022 116226 A	15(594)2022
M 2022 36222 R	AM 116399	AM 2022 116399 A	15(594)2022
M 2022 36223 R	AM 116397	AM 2022 116397 A	15(594)2022
M 2022 36224 R	AM 116398	AM 2022 116398 A	15(594)2022
M 2022 36225 R	AM 116249	AM 2022 116249 A	15(594)2022
M 2022 36227 R	AM 115533	AM 2022 115533 A	11(590)2022
M 2022 36228 R	AM 115605	AM 2022 115605 A	12(591)2022
M 2022 36229 R	AM 115535	AM 2022 115535 A	11(590)2022
M 2022 36230 R	AM 115536	AM 2022 115536 A	11(590)2022
M 2022 36231 R	AM 116316	AM 2022 116316 A	15(594)2022
M 2022 36232 R	AM 115413	AM 2022 115413 A	11(590)2022
M 2022 36233 R	AM 115407	AM 2022 115407 A	11(590)2022
M 2022 36234 R	AM 115409	AM 2022 115409 A	11(590)2022
M 2022 36245 R	AM 115993	AM 2022 115993 A	14(593)2022
M 2022 36256 R	AM 120528	–	24(603)2022
M 2022 36257 R	AM 120505	–	24(603)2022
M 2022 36258 R	AM 120529	–	24(603)2022
M 2022 36259 R	AM 120247	–	24(603)2022
M 2022 36260 R	AM 120526	–	24(603)2022
M 2022 36261 R	AM 120620	–	24(603)2022
M 2022 36262 R	AM 120360	–	24(603)2022
M 2022 36263 R	AM 120361	–	24(603)2022
M 2022 36264 R	AM 112691	–	24(603)2022
M 2022 36265 R	AM 120601	–	24(603)2022
M 2022 36266 R	AM 120611	–	24(603)2022
M 2022 36267 R	AM 120370	–	24(603)2022
M 2022 36268 R	AM 120599	–	24(603)2022

CONCORDANCE TABLE OF PUBLICATION NUMBERS  
AND APPLICATION NUMBERS

NUMBER OF PUBLISHED APPLICATION (260)	NUMBER OF APPLICATION (210)	1	2
1	2		
AM 2022 117272 A	AM 117272	AM 2022 117916 A	AM 117916
AM 2022 117308 A	AM 117308	AM 2022 117917 A	AM 117917
AM 2022 117433 A	AM 117433	AM 2022 117918 A	AM 117918
AM 2022 117613 A	AM 117613	AM 2022 117920 A	AM 117920
AM 2022 117623 A	AM 117623	AM 2022 117922 A	AM 117922
AM 2022 117625 A	AM 117625	AM 2022 117925 A	AM 117925
AM 2022 117650 A	AM 117650	AM 2022 117927 A	AM 117927
AM 2022 117651 A	AM 117651	AM 2022 117929 A	AM 117929
AM 2022 117659 A	AM 117659	AM 2022 117976 A	AM 117976
AM 2022 117664 A	AM 117664	AM 2022 117978 A	AM 117978
AM 2022 117669 A	AM 117669	AM 2022 117979 A	AM 117979
AM 2022 117670 A	AM 117670	AM 2022 117981 A	AM 117981
AM 2022 117711 A	AM 117711	AM 2022 117982 A	AM 117982
AM 2022 117720 A	AM 117720	AM 2022 117983 A	AM 117983
AM 2022 117721 A	AM 117721	AM 2022 117990 A	AM 117990
AM 2022 117727 A	AM 117727	AM 2022 117992 A	AM 117992
AM 2022 117730 A	AM 117730	AM 2022 117993 A	AM 117993
AM 2022 117733 A	AM 117733	AM 2022 117994 A	AM 117994
AM 2022 117805 A	AM 117805	AM 2022 117995 A	AM 117995
AM 2022 117807 A	AM 117807	AM 2022 117996 A	AM 117996
AM 2022 117808 A	AM 117808	AM 2022 117997 A	AM 117997
AM 2022 117814 A	AM 117814	AM 2022 117998 A	AM 117998
AM 2022 117818 A	AM 117818	AM 2022 117999 A	AM 117999
AM 2022 117824 A	AM 117824	AM 2022 118006 A	AM 118006
AM 2022 117825 A	AM 117825	AM 2022 118008 A	AM 118008
AM 2022 117826 A	AM 117826	AM 2022 118009 A	AM 118009
AM 2022 117827 A	AM 117827	AM 2022 118012 A	AM 118012
AM 2022 117828 A	AM 117828	AM 2022 118014 A	AM 118014
AM 2022 117830 A	AM 117830	AM 2022 118015 A	AM 118015
AM 2022 117833 A	AM 117833	AM 2022 118016 A	AM 118016
AM 2022 117836 A	AM 117836	AM 2022 118017 A	AM 118017
AM 2022 117839 A	AM 117839	AM 2022 118020 A	AM 118020
AM 2022 117841 A	AM 117841	AM 2022 118021 A	AM 118021
AM 2022 117845 A	AM 117845	AM 2022 118022 A	AM 118022
AM 2022 117900 A	AM 117900	AM 2022 118064 A	AM 118064
AM 2022 117901 A	AM 117901	AM 2022 118067 A	AM 118067
AM 2022 117902 A	AM 117902	AM 2022 118069 A	AM 118069
AM 2022 117903 A	AM 117903	AM 2022 118071 A	AM 118071
AM 2022 117906 A	AM 117906	AM 2022 118079 A	AM 118079
AM 2022 117907 A	AM 117907	AM 2022 118081 A	AM 118081
AM 2022 117910 A	AM 117910	AM 2022 118082 A	AM 118082
AM 2022 117914 A	AM 117914	AM 2022 118134 A	AM 118134
		AM 2022 118135 A	AM 118135
		AM 2022 118137 A	AM 118137
		AM 2022 118145 A	AM 118145
		AM 2022 118152 A	AM 118152

CONCORDANCE TABLE OF INDEX OF GOODS AND/OR SERVICES  
AND APPLICATION NUMBERS

INDEX OF GOODS AND/OR SERVICES (511)	NUMBER OF PUBLISHED APPLICATIONS (260)	1	2
1	2	16	AM 2022 117623 A
1	AM 2022 117836 A	16	AM 2022 117981 A
2	AM 2022 117824 A	16	AM 2022 117982 A
2	AM 2022 117825 A	16	AM 2022 117983 A
2	AM 2022 117826 A	16	AM 2022 118012 A
2	AM 2022 117827 A	17	AM 2022 117824 A
2	AM 2022 117828 A	17	AM 2022 117825 A
3	AM 2022 117929 A	17	AM 2022 117826 A
3	AM 2022 117982 A	17	AM 2022 117827 A
3	AM 2022 118014 A	17	AM 2022 117828 A
3	AM 2022 118016 A	17	AM 2022 117981 A
3	AM 2022 118064 A	18	AM 2022 117982 A
4	AM 2022 117982 A	18	AM 2022 117983 A
5	AM 2022 117308 A	19	AM 2022 117824 A
5	AM 2022 117664 A	19	AM 2022 117825 A
5	AM 2022 117727 A	19	AM 2022 117826 A
5	AM 2022 117730 A	19	AM 2022 117827 A
5	AM 2022 117733 A	19	AM 2022 117828 A
5	AM 2022 117807 A	21	AM 2022 117929 A
5	AM 2022 117808 A	21	AM 2022 117981 A
5	AM 2022 117814 A	21	AM 2022 117982 A
5	AM 2022 117830 A	21	AM 2022 117983 A
5	AM 2022 117910 A	21	AM 2022 118014 A
5	AM 2022 117916 A	21	AM 2022 118064 A
5	AM 2022 117917 A	24	AM 2022 117982 A
5	AM 2022 117918 A	24	AM 2022 117983 A
5	AM 2022 117925 A	25	AM 2022 117613 A
5	AM 2022 117979 A	25	AM 2022 117981 A
5	AM 2022 118015 A	25	AM 2022 117982 A
5	AM 2022 118016 A	25	AM 2022 117983 A
5	AM 2022 118064 A	26	AM 2022 117981 A
5	AM 2022 118069 A	26	AM 2022 117983 A
5	AM 2022 118134 A	27	AM 2022 117983 A
5	AM 2022 118137 A	28	AM 2022 117981 A
5	AM 2022 118152 A	28	AM 2022 117983 A
8	AM 2022 117982 A	29	AM 2022 117433 A
9	AM 2022 117669 A	29	AM 2022 117623 A
9	AM 2022 117839 A	29	AM 2022 117664 A
9	AM 2022 117906 A	29	AM 2022 117721 A
9	AM 2022 117907 A	29	AM 2022 117920 A
9	AM 2022 117981 A	29	AM 2022 117976 A
9	AM 2022 117982 A	29	AM 2022 118006 A
9	AM 2022 117983 A	29	AM 2022 118017 A
9	AM 2022 118064 A	29	AM 2022 118064 A
10	AM 2022 117983 A	30	AM 2022 117623 A
10	AM 2022 118064 A	30	AM 2022 117651 A
14	AM 2022 117981 A	30	AM 2022 117664 A
14	AM 2022 117982 A	30	AM 2022 117721 A
14	AM 2022 117983 A	30	AM 2022 117805 A
		30	AM 2022 117901 A
		30	AM 2022 118006 A
		30	AM 2022 118017 A

1	2
30	AM 2022 118064 A
30	AM 2022 118079 A
31	AM 2022 117433 A
31	AM 2022 117623 A
31	AM 2022 117920 A
31	AM 2022 117976 A
31	AM 2022 117978 A
32	AM 2022 117433 A
32	AM 2022 117623 A
32	AM 2022 117659 A
32	AM 2022 117721 A
32	AM 2022 117830 A
32	AM 2022 117841 A
32	AM 2022 117999 A
32	AM 2022 118009 A
32	AM 2022 118064 A
32	AM 2022 118071 A
32	AM 2022 118145 A
33	AM 2022 117650 A
33	AM 2022 117711 A
33	AM 2022 117721 A
33	AM 2022 117990 A
33	AM 2022 118008 A
33	AM 2022 118009 A
33	AM 2022 118020 A
33	AM 2022 118022 A
33	AM 2022 118067 A
34	AM 2022 117272 A
34	AM 2022 117900 A
34	AM 2022 117992 A
34	AM 2022 117993 A
34	AM 2022 117994 A
34	AM 2022 117995 A
34	AM 2022 117996 A
34	AM 2022 117997 A
34	AM 2022 117998 A
34	AM 2022 118021 A
35	AM 2022 117824 A
35	AM 2022 117825 A
35	AM 2022 117826 A
35	AM 2022 117827 A
35	AM 2022 117828 A
35	AM 2022 117833 A
35	AM 2022 117902 A
35	AM 2022 117903 A
35	AM 2022 117927 A

1	2
35	AM 2022 117981 A
35	AM 2022 117982 A
35	AM 2022 117983 A
35	AM 2022 118006 A
35	AM 2022 118014 A
35	AM 2022 118017 A
35	AM 2022 118064 A
35	AM 2022 118079 A
36	AM 2022 117818 A
36	AM 2022 117833 A
36	AM 2022 117845 A
36	AM 2022 118064 A
36	AM 2022 118135 A
37	AM 2022 117720 A
37	AM 2022 117818 A
37	AM 2022 117824 A
37	AM 2022 117825 A
37	AM 2022 117826 A
37	AM 2022 117827 A
37	AM 2022 117828 A
37	AM 2022 117833 A
37	AM 2022 117845 A
37	AM 2022 118081 A
37	AM 2022 118082 A
38	AM 2022 117669 A
39	AM 2022 117824 A
39	AM 2022 117825 A
39	AM 2022 117826 A
39	AM 2022 117827 A
39	AM 2022 117828 A
39	AM 2022 117833 A
39	AM 2022 118014 A
41	AM 2022 117625 A
41	AM 2022 117670 A
41	AM 2022 117922 A
41	AM 2022 118064 A
42	AM 2022 117669 A
42	AM 2022 117818 A
42	AM 2022 117839 A
42	AM 2022 118064 A
43	AM 2022 117650 A
43	AM 2022 117721 A
43	AM 2022 117841 A
43	AM 2022 117914 A
44	AM 2022 118064 A

CONCORDANCE TABLE OF INDEX OF GOODS AND/OR SERVICES  
AND NUMBERS OF TRADEMARKS REGISTERED ACCORDING  
TO THE ACCELERATED PROCEDURE

INDEX OF GOODS AND/OR SERVICES (511)	NUMBERS OF REGISTERED ACCORDING TO THE ACCELERATED PROCEDURE (111)
9	M 2022 36261 R
14	M 2022 36260 R
16	M 2022 36256 R
18	M 2022 36260 R
21	M 2022 36258 R
25	M 2022 36258 R
25	M 2022 36260 R
28	M 2022 36258 R
29	M 2022 36264 R
29	M 2022 36267 R
30	M 2022 36264 R
30	M 2022 36267 R
31	M 2022 36264 R
32	M 2022 36264 R
32	M 2022 36267 R
33	M 2022 36258 R
34	M 2022 36259 R
34	M 2022 36262 R
34	M 2022 36263 R
35	M 2022 36256 R
35	M 2022 36260 R
35	M 2022 36262 R
35	M 2022 36263 R
35	M 2022 36265 R
36	M 2022 36266 R
37	M 2022 36256 R
37	M 2022 36257 R
37	M 2022 36265 R
39	M 2022 36256 R
39	M 2022 36257 R
43	M 2022 36259 R
43	M 2022 36268 R



# **OFFICIAL BULLETIN OF THE INDUSTRIAL PROPERTY**

**INVENTIONS**

**UTILITY MODELS**

**DESIGNS**

**TRADEMARKS**

**APPELLATIONS OF ORIGIN OF GOODS**

## **24(603)**

EDITOR-IN-CHIEF: N. Bebrishvili

EDITOR-TRANSLATOR: E. Gabunia

PROOFREADER: A. Shixashvili

COMPUTER LAYOUT: M. Ordenidze  
K. Svanidze

ISSN 2720-8486

[info@sakpatenti.gov.ge](mailto:info@sakpatenti.gov.ge)  
[www.sakpatenti.gov.ge](http://www.sakpatenti.gov.ge)