



ASSEMBLY INSTRUCTION FOR 3-7422L-EM-MSR-75

| | | |
|---|---|---|
| <p>Note</p> <ul style="list-style-type: none"> • Read instructions carefully. • Carefully identify each component especially those that are similar. • Separate and identify each component from the hardware pack and rest each one in its proper location before fastening. • Do not over tighten the screws or bolts when assembling. |  <p>2 Persons</p> | <p>TOOL REQUIRED</p>  |
|---|---|---|

Step 1

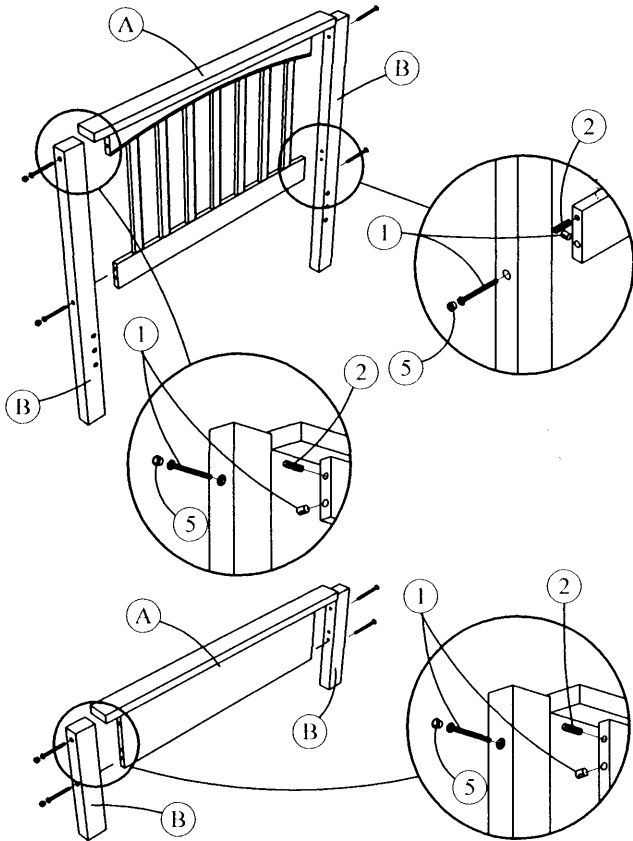

Assemble the bed frame headboard and footboard component as shown and tighten all bolt.

Step 2

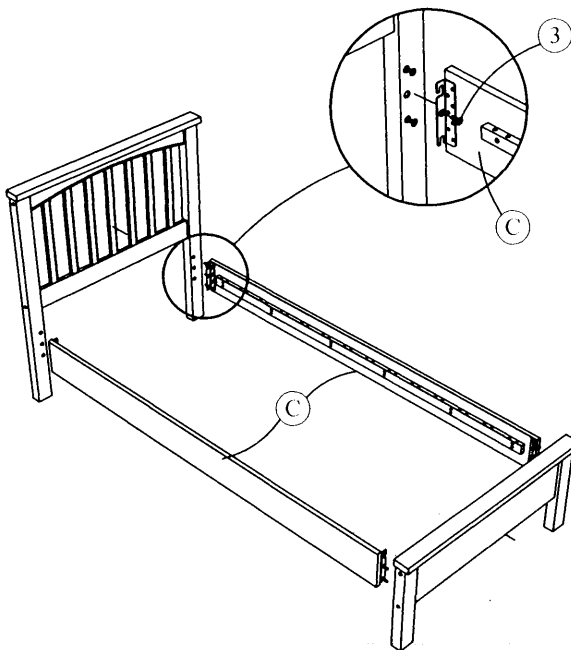

Attach the side rail (C) to the headboard and footboard using bolt (3) and allen key (G) as shown ensuring the pre-drilled holes on the side rail are facing up.

Step 3



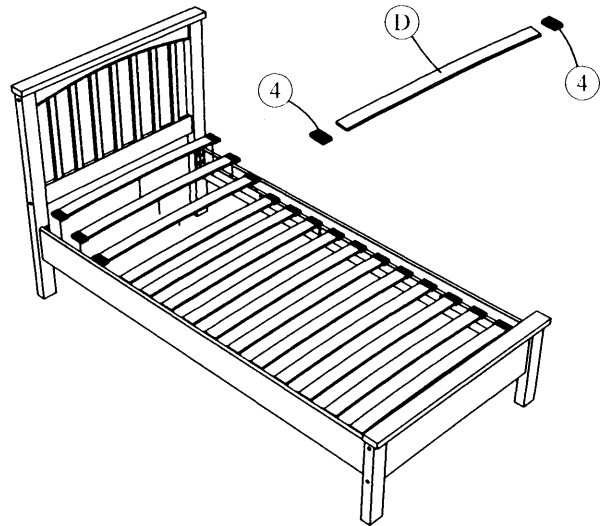





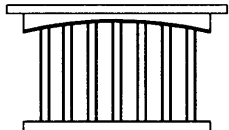
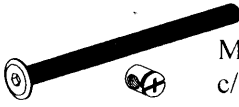
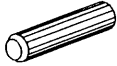

Each wood slat must be inserted with a single end plastic cap and a double end plastic cap as shown on the picture.

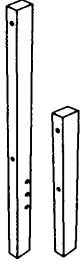

Once both wood slats have been inserted with the plastic caps, fix it on the wood side rails and center bar by pressing it accordingly to the default holes. Ensure the plastic cap's pin is aimed to the hole. At last make sure all screws and bolts are tighten.

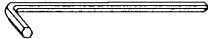
Please follow our assembly instruction procedure for easier assemble.

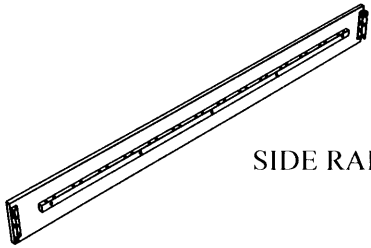
PARTS & HARDWARE LIST FOR 3-7422L-EM-MSR-75

| NO | PART | QTY | NO | HARDWARE | QTY |
|----|--|-------|----|---|--------|
| A |  HEAD FRAME | 1 pc | 1 |  M6x90mm c/w Barrel Nut | 8 pcs |
| | | 1 pc | 2 |  Wood Dowel | 8 pcs |
| | FOOT FRAME | | 3 |  M8x25mm | 12 pcs |
| B |  HEAD POST - L/R | 2 pcs | 4 |  Single end plastic cap | 28 pcs |
| |  FOOT POST - L/R | 2 pcs | 5 |  Wood Button | 8 pcs |
| | | | 6 |  M8- Allen key | 1 pc |
| | | | 7 |  M6- Allen key | 1 pc |
| C |  SIDE RAIL | 2pcs | | | |
| D |  WOOD SLAT | 14pcs | | | |