



## **Important Information**

When you have built your bed, **put the mattress on the frame in the tilt position before attempting to close the bed.**

Then push the bed frame down using both hands on top of the bed frame. **Please note this may require some force when closing for the first time.**

## **Safety**

Please note caution should be taken when operating the lift mechanism. The lift mechanism should not be operated by children.

**CAUTION:**

Do not allow children to operate the lift mechanism.

Do not allow children near the lift base when operating the mechanism.

Do not allow children to enter the internal storage space.

Do not stand on the inside the bed internal storage space.

Do not overload the internal storage space.

Keep hands clear of the mechanism when operating the base system.

**DO NOT OPERATE THE LIFTING MECHANISM WITHOUT THE MATTRESS BEING IN PLACE.**

A. The lifting mechanism provides assistance to lift the mattress when fitted to the bed. It does not lift the mattress for you. The system has been designed to assist with lifting a variety of mattress weights and thicknesses. The amount of assistance that the mechanism provides will depend on the weight and thickness of the mattress.

B. Always use the strap handle to lift up the mattress and base, using both hands.

To pull the mattress base down, use both hands equally spaced from the centre of the mattress base. **DO NOT** pull down on one side of the base only as this may damage lift mechanism.



**OPERATION OF THE LIFT MECHANISM IN ANY WAY OTHER THAN STATED COULD CAUSE INJURY & VOID THE WARRANTY.**

# ASSEMBLY INSTRUCTIONS -KING

## QB-8446(OT)

### ASSEMBLY PARTS

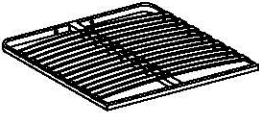
- 1.Slat Frame-----2pcs
- 2.Bolts-----2pcs
- 3.Nuts-----4pcs
- 4.Mattress Stoppers-----1pc

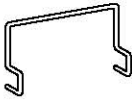
			
①. x 2pcs	( $\phi 8 \times 80$ ) ②. x 2pcs	( $\phi 8$ ) ③. x 4pcs	④. x 1pc



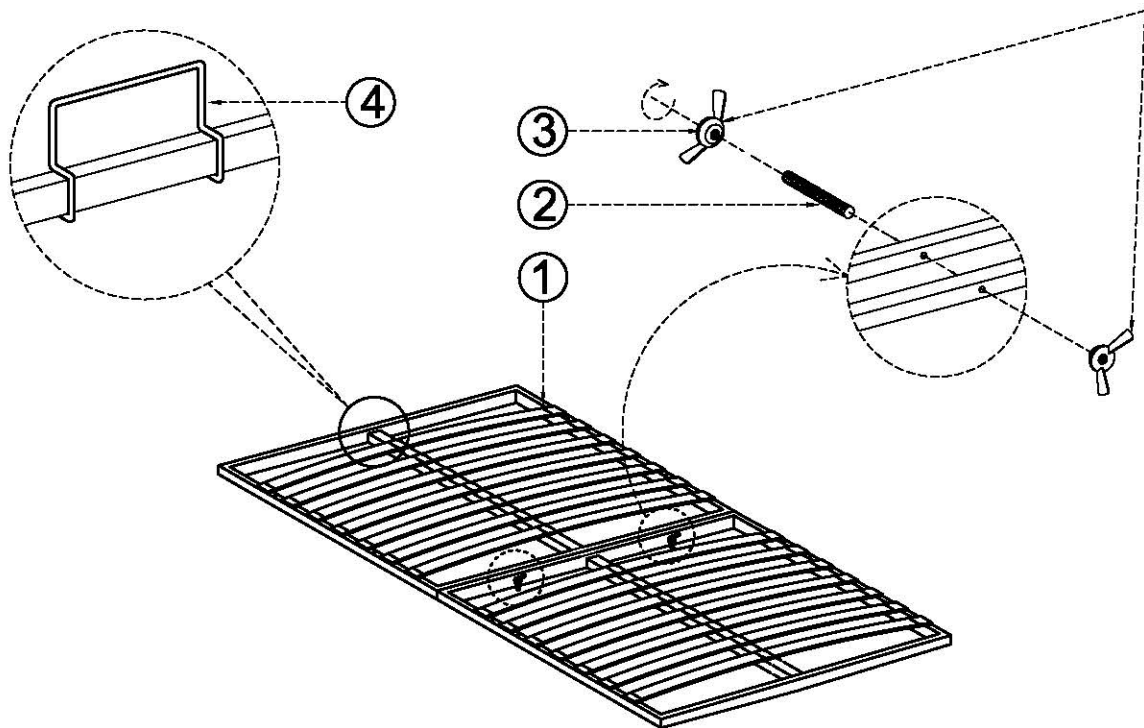





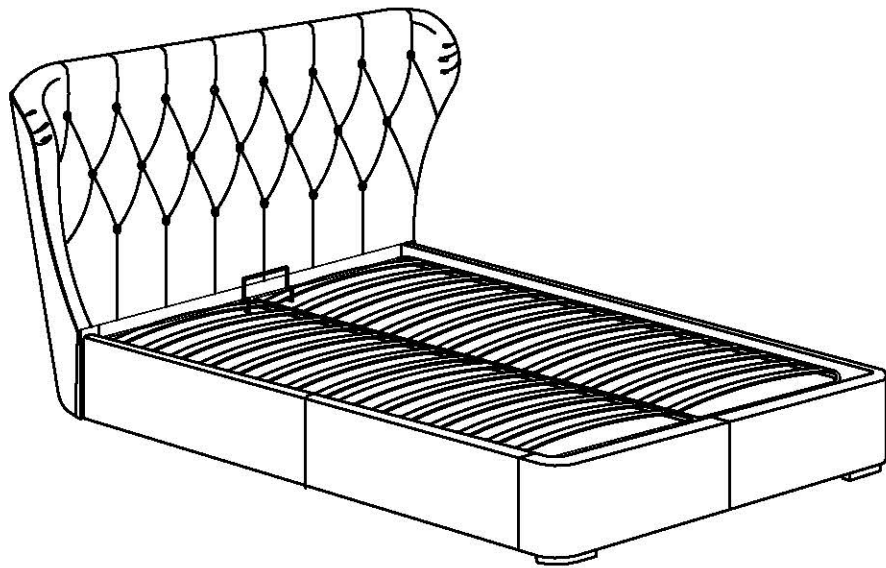

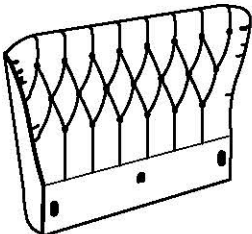

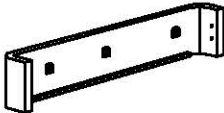

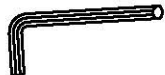

Place bed slats in reverse position, tighten both slats using washer and "butterfly" bolt.

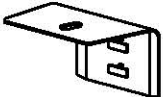

# ASSEMBLY INSTRUCTIONS

QB-8446-OT



 <p>① Headboard=1pc</p>	 <p>② Side Rails=2pcs</p>	 <p>③ Footboard=1pc</p>	 <p>④ Bolts(M8*18) =4pcs</p>	 <p>⑤ Allen Key =1pc</p>	 <p>⑥ Bolts(M8*20) =4pcs</p>	
 <p>⑦ Cross Rails =2pcs</p>	 <p>⑧ Baseboards =4pcs</p>	 <p>⑨ Slat Frame =1pc</p>	 <p>⑩ Brackets=6pcs</p>	 <p>⑪ Bolts(M4*10) =6pcs</p>	 <p>⑫ Handle=1pc</p>	
 <p>⑬ Stick Felts=6pcs</p>	 <p>⑭ Screws=2pcs</p>	 <p>⑮ Nuts(Ø8) =8pcs</p>		 <p>⑯ Bolts(Ø8*45) =8pcs</p>	 <p>⑰ Spanner=1pc</p>	 <p>⑱ Allen Key =1pc</p>

