

بِسْمِ اللَّهِ الرَّحْمَنِ الرَّحِيمِ

HOME ECONOMICS

7



Punjab Curriculum & Text Book Board, Lahore.

All rights reserved with the
Punjab Curriculum Textbook
Board Lahore. Prepared by
Punjab Curriculum Text
Book Board Lahore. Approved by
Federal Ministry of Education, Islamabad.
Vide letter No.F.2-15/87 Agro. Tech. Dated 27.3.94

IMPORTANT NOTES



Authors:

Mrs. Safia Nazir Chughtai
Mrs. Anjum Nawaz
Miss Waseem Bano

Editors:

Mrs. Aisha Akhtar
Zabinda Mashkur.

Translated by:

Mrs. Khalida Riaz

Technical Asstt:

Reprocessing: Maktaba-i-Moin-ul-Adab, &
Star Scan Lahore

Published by: Arslan Book Depot, Lahore.

Printed by: Al-Raheem Art Press, Lahore.

Date of Printing	Edition	Impression	No. of copies	Price
April 2018	4th	2nd	8,500	68.00

FOOD AND NUTRITION





Chapter	Contents	Page
---------	----------	------

Food and Nutrition

1.

Meat Cookery

1

Plain korma

Minced meat with potatoes

2.

Vegetable Cookery

12

Vegetable soup

Mixed vegetable bhujia

3.

Cereal Cookery

20

Boiled rice

Dal Masoor

4.

Growing Seasonal Vegetables

27

Advantages of growing Vegetables at home

Proper method and time for the plantation of different vegetables

Sewing

1.

Use of Sewing Machine

37

Main parts of a machine and their functions

2.

Preparation for Sewing

49

Chapter	Contents	Page
3.	Machine Seams	61
	Plain Seam	
	French Seam	
4.	Decorative and Regional Stitches	67
	Satin stitch	
	Phulkari or Swati stitch	
	Sindhi stitch	
	Mirror work	
5.	Making Different Articles	78
	Tea-cosy cover	
	Tray-cover	
	Making a doll	
Effective Living in the Family		
1.	Importance of Education	91
	Responsibilities of an educated girl	
2.	House Work	95
	Time and activity plan	
	Care of clothes	
3.	Cleaning the House	114
	General hints for keeping the House clean	



Nutritive Value of Meat

The nutritive value of meat depends upon its constituents. Meat is considered to be an important food due to the presence of proteins. Nutritionally cell protein is very important due to the following facts.

1. Meat (whatever its kind) is different in its nutrients and composition. It contains sixteen to twenty two percent of complete protein, which is necessary for growth, repair and maintenance of body cells and tissues.
2. Organ meat like heart, kidney and liver are excellent sources of proteins, iron, phosphorus and vitamin B₁₂. These nutrients are necessary for the formation of red blood cells.
3. Meat contain rare quantity of vitamins. All kinds of meat are good sources of niacin and vitamin B₁₂. These are required for the growth and development of cells and tissues.
4. Bones and lower parts of the legs of animals are good sources of calcium and phosphorus. These are important for the strength and firmness of bones and teeth.



Kinds of Meat

Meat is of two kinds according to its colour.

1. **White Meat:** It includes meat of chicken, duck, rabbit, pigeon turkey and fish. It is easily digestible. It provides less energy.
2. **Red Meat:** It includes meat of goat, lamb, cow, veal and camel. It is a good source of iron. It provides more energy.

Selection of Meat

Following points should be kept in mind while purchasing meat.

1. Meat should be fresh. Fresh meat is juicy and has a sweet odour.
2. The flesh of a young animal is pinkish red. The flesh of an older animal is blackish or greyish red in colour.
3. Fresh meat maintains its shape. Its tissues are tender and firm.
4. Fresh meat of a healthy animal carries a stamp from the health department.

Cooking of Meat

The main objective of cooking the meat is to increase its taste and flavour and to make it palatable and digestible. All the germs and parasites present in the meat are killed by cooking. Meat is full of nutrients, therefore, special care should be taken while cooking it so as to maintain its nutritive value.



1. Remove hair and other particles from fresh meat. Wash it under running water once or twice and cook it.
2. Frozen meat should not be soaked in water. It should be cooked directly.
3. Always cook meat on low heat. Cooking meat on high heat makes it stiff. Moreover, its nutritive value and flavour are lost. Meat cooked on low heat is tender and delicious.
4. Meat cooked by frying will make it more palatable and delicious. Moreover, its nutritive value will be saved.
5. Use only required quantity of water for cooking.

Meat Curries

Meat curries are cooked in different ways e.g. bhuna ghost, korma, meat with vegetables, meat with dal, kofta curry, fried fish, fish curry, chicken curry, chicken roast, shami kababs, and seekh kababs etc. Typical and different methods are used for cooking. Whatever method is to be used spices and ghee or oil are added which also contain rare quantity of important nutrients e.g. Spices make the food tasty and increase appetite because they contain aromatic organic oils which increase the secretion of digestive juices and help in the digestion of food.



Meat fried in ghee or oil retains its nutritive value, because, the water present in the meat evaporates by frying and mineral salts settle on its surface. The fat present in ghee or oil serves as fuel and provide heat and energy to the body. Meat cooked in fat also include vitamin A, D, E and K. They protect delicate organs of the body e.g. heart, kidney and intestines.

Korma (Plain)

Ingredients

Meat	▶ ½ Kilogram
Ghee	▶ 125gms (½cup)
Onion (large)	▶ 2
Garlic (fresh) finely crushed	▶ 1 teaspoon
Ginger (fresh) finely crushed	▶ 1 teaspoon
Coriander powder	▶ 1 teaspoon
Red chilli powder	▶ 1 teaspoon
Turmeric powder	▶ 1/4 teaspoon
Spices (finely ground)	▶ ½teaspoon or as desired
Salt	▶ ½ teaspoon or as desired
Coriander (fresh)	▶ few leaves
Tomatoes (medium)	▶ 2
Water	▶ 3-4 cups



Equipment

Stove, saucepan or degchi, match-box, duster, cooking spoon (ladle) knife, cutting board, sieve, plastic bowl, curry bowl, serving spoon, curry plate, quarter plate, tray with tray cover.

Method

1. Clean and wash the meat.
2. Peel and slice onions.



3. Heat the ghee and brown onion in it. Take out the onions, and fry garlic and ginger in the same ghee. Take them out and grind onion, ginger and garlic.



4. Brown meat in the same ghee. Add ground onion, garlic, ginger, salt, chilli powder, turmeric powder, coriander powder and spices. Fry on low heat.
5. Add water. Cook on low heat till the meat is tender.
6. When meat is tender, add tomatoes and fry. Add a little water. Cook on low heat till gravy thickens to desired consistency. Korma is ready. Pour it in a curry bowl.
7. Serve with hot chapaties and salad in a tray with curry bowl, serving spoon, curry plate and quarter plate.

Minced Meat with Potatoes

Minced meat with potatoes is a common dish. It is full of nutrients. This dish is equally liked by children, the young and the old.

Potato is a cheap and popular vegetable. It is cooked alone, mixed with other vegetables, cooked with meat or minced meat.

Potatoes are rich in carbohydrates and iron with a few traces of vitamin C. Proteins, minerals and vitamins are present in a large amount in minced meat. Therefore, minced meat with potatoes is full of nutrients.

Selection of Minced Meat

Following points should be kept in mind while purchasing minced meat.

1. Try to get meat piece from the thigh with less fat and tendons.
2. The meat ground by hand or passed once through the grinding machine is good for frying or to be cooked with vegetables.
3. For kababs and koftas it is advisable to pass it through the machine twice.



Minced Meat with Potatoes

Ingredients

Potatoes	▶ 1/4 Kilogram
Minced meat	▶ 1/2 Kilogram
Ghee	▶ 60 gm
Onions (medium)	▶ 2
Garlic (fresh) Finely crushed	▶ 1 teaspoon
Ginger (fresh) finely crushed	▶ 1/2 teaspoon
Red chilli powder	▶ 1 teaspoon
coriander powder	▶ 1 teaspoon
Tumeric powder	▶ 1/4 teaspoon
Salt	▶ 1/2 teaspoon or as desired
Tomatoes	▶ 2
Spices	▶ 1/4 teaspoon
Green coriander/Green chillies	▶ As desired

Equipment

Stove, sauce pan or degchi, match-box, duster, cooking spoon (ladle), knife, cutting board, plastic bowl, plastic sieve, curry bowl, serving spoon, curry plate, quarter plate, tray with tray cover.



Method

1. Wash minced meat once or twice under running water.
2. Peel and slice onions. Brown onions in ghee.
3. Add minced meat in it and fry.
4. Add all spices, salt, red chilli powder, coriander powder, turmeric powder and one cup of water. Cook on low heat.
5. When minced meat is tender, then add tomatoes and fry till water dries.
6. Peel the potatoes and cut into small cubes.
7. Add potatoes in minced meat. Fry a little and add $\frac{1}{2}$ cup of water. Cook on low heat till potatoes are tender. Sprinkle coriander leaves and green chillies and stew for one to two minutes on low heat.



Questions

1. Write a note on the nutritive value of meat .
2. What care should be taken while cooking meat?
3. Which points should be kept in mind while purchasing minced meat?
4. Write down the method of plain korma and minced meat with potatoes under the following headings.
 - a. Ingredients
 - b. Equipment
 - c. Method
5. Fill in the blanks with appropriate words:
 - a. Meat should be cooked on _____ heat.
 - b. _____ meat is digestible.
 - c. Red meat includes the meat of _____.
 - d. White meat provides _____ energy than red meat.
 - e. _____, minerals and _____ are present in minced meat.
6. Tick ✓ in the on correct statement.
 - a. White meat includes meat of mutton, lamb, beef and veal.
 - b. Rabbit is included in the white meat.
 - c. Chicken provides less energy than beef.
 - d. Red meat provides less energy than white meat.
 - e. Potatoes should be boiled before peeling.



Evaluation

Practical _____ Korma (Plain)

Standard marks are given against each statement in the following table. Write down the marks obtained by the student in the related column.

Sr. No.	Characteristics	Standard Marks	Marks Obtained
1.	Meat is tender.	5	
2.	Korma is cooked according to the method	5	
3.	Proportion of salt, chili and spices is correct.	5	
4.	Gravy is of desired consistency.	5	
5.	Korma is delicious and palatable.	5	
	Total marks	25	

Grade

Signatures of the
Teacher in charge _____

Dated _____



Evaluation

Practical _____ Korma (Plain)

Standard marks are given against each statement in the following table. Write down the marks obtained by the student in the related column.

Sr. No.	Characteristics	Standard Marks	Marks Obtained
1.	Minced meat is tender	5	
2.	The colour is appetizing.	5	
3.	The potato pieces are tender but Not mashed.	5	
4.	Proportion of salt, chilli and spices is correct.	5	
5.	Curry is delicious and palatable.	5	
	Total marks	25	

Grade

Signatures of the
Teacher in charge _____

Dated _____

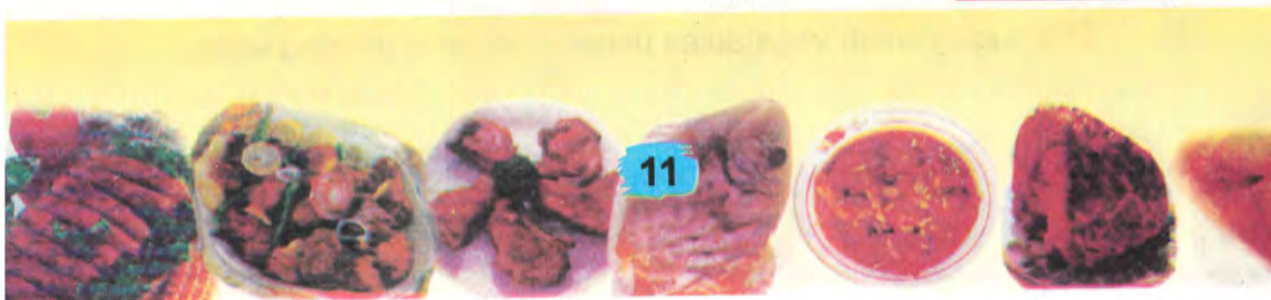

2

VEGETABLE COOKERY



Nutritive Value of Vegetables

Vegetables are used daily in our homes. They are essential for the growth and development of our body. Vegetables provide vitamins, especially vitamin C and minerals in abundance. Vegetables relieve constipation because of fibers in them and help in digestion.

Vegetables are cooked in different ways, for example fried vegetables cooked alone in bhuna masala, boiled vegetables mixed vegetable bhujia, vegetables mixed with meat or minced meat. Vegetables cooked with meat or minced meat are higher in nutritive value.

Principles of Vegetable Cookery

Following points should be kept in mind while cooking vegetables to retain their nutrients.

1. Always use fresh vegetables.
2. Thoroughly wash vegetables under clean and running water.

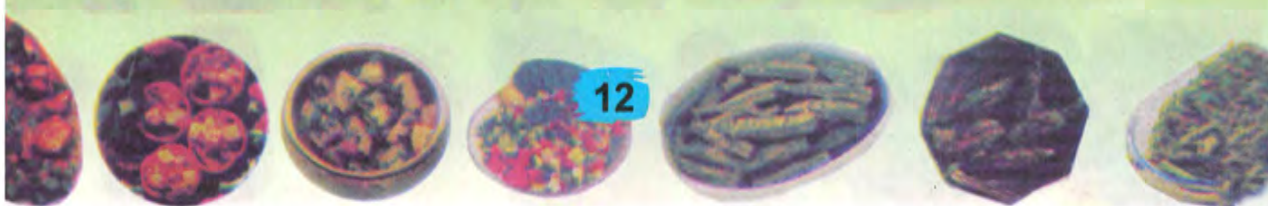

3. Vegetables should be soaked in a solution of potassium permanganate before washing.
4. Peel thin skins from vegetables because vegetables peeled with thick skins lose their nutritive value. Use a sharp knife for scraping bitter gourds, cut them in center to remove the seeds.
5. Cut off rotten parts of vegetables and cut vegetables into medium sized pieces.
6. Prolong soaking of vegetables should be avoided. Because vitamins and minerals are dissolved in water by soaking.
7. Peel and cut vegetables just before cooking to avoid wastage of water soluble vitamins.
8. Prolong cooking should be avoided.



9. Always cook vegetables with a tight lid, because vitamin C is lost by the action of oxygen. Green leafy vegetables should be cooked with an open lid for a few minutes only.
10. Use required quantity of water to make the vegetables tender. Cook vegetables in their own water, to avoid the wastage of vitamin C and minerals.

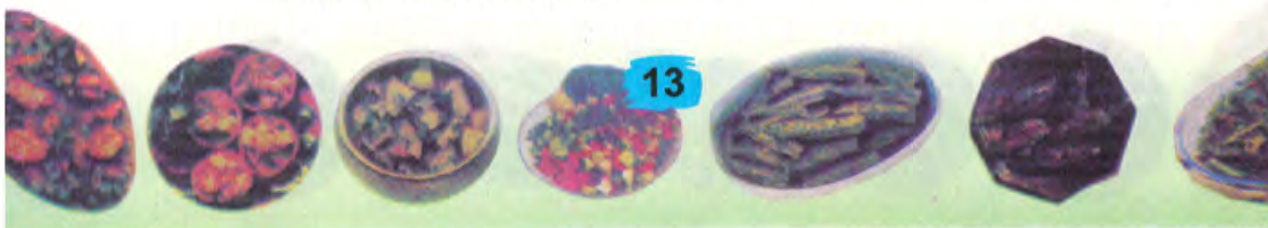

Vegetable Soup

Ingredients

Carrot	▶	1
Turnip	▶	1
Cauliflower	▶	60 gms.
Potato	▶	1
Tomato	▶	1
Onion	▶	1
Salt	▶	½ teaspoon or as desired
Pepper	▶	½ teaspoon
Peas	▶	½ cup
Water	▶	5 cups



Equipment

Saucepan or degchi, stove, match-box, duster, plastic bowl, sieve, knife, cutting board, cooking spoon (ladle), tablespoon, serving bowl with spoon, soup cup, tray with tray cover.

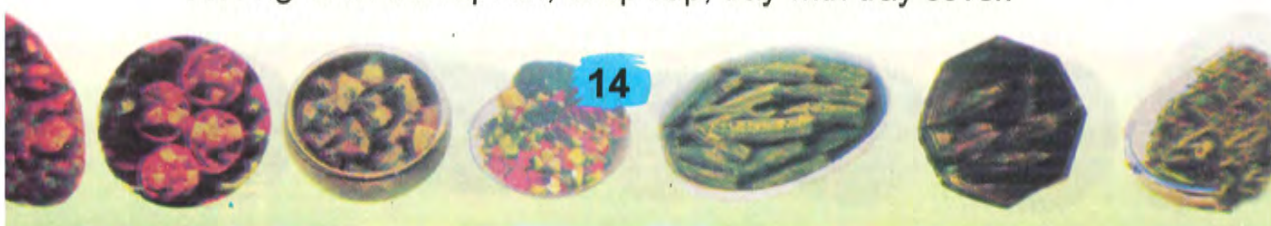

Method

1. Wash and cut the vegetables in medium sized pieces.
2. Put water in the saucepan. Add all the vegetables in it with salt and pepper. Cook on low heat.
3. When vegetables are tender, mash them and strain. Pour into the soup bowl.
4. Serve in a tray with serving spoon, small bowl and tablepoon.

Mixed Vegetable Bhujia

Ingredients

Seasonal vegetables	▶ 1 kg.
Onion (large)	▶ 2
Tomatoes	▶ 2
Garlic (fresh) finely ground	▶ 1 teaspoon
Ginger (fresh) finely ground	▶ 1 teaspoon
Coriander powder	▶ ½ teaspoon
Turmeric powder	▶ ¼ teaspoon
Salt	▶ ½ teaspoon or as desired
Red chilli powder	▶ 1 teaspoon or as desired
Ghee / oil	▶ 60 gm (½ cup)
Green chillies (chopped)	▶ 3-4
Green coriander (fresh)	▶ A few leaves.

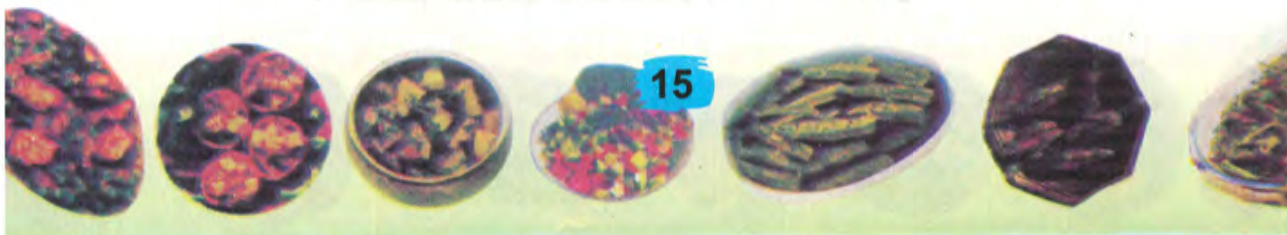

Equipment

Stove, match-box, saucepan, spatula, duster, knife, cutting board, plastic bowl, serving bowl, serving spoon, curry plate, quarter plate, tray with tray cover.

Method

1. Wash, peel and cut vegetables into medium sized pieces.
2. Peel and cut onions into slices.
3. Brown onions in ghee.
4. Add garlic, ginger, salt and all the spices. Sprinkle a little water and fry for few minutes.



5. Add vegetables and fry. Add a little water if required. Cook on low heat.
6. When vegetables are tender, then sprinkle green chillies and green coriander leaves. Steam for 2-3 minutes.
7. Put bhujia in a serving bowl. Serve with hot chapatias in a tray with serving spoon, curry plate and quarter plate.

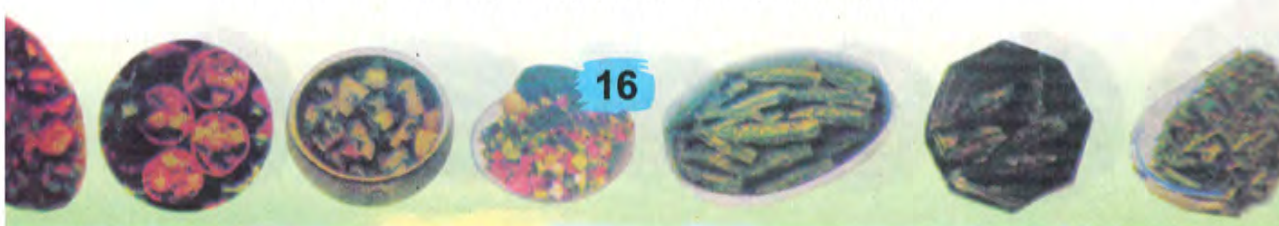

Questions

1. Which points should be kept in mind while cooking vegetables?
2. Write down the method of vegetable soup under the following headings.
 - a. Ingredients
 - b. Equipment
 - c. Method
3. Write down the method of vegetable bhujia under the following headings.
 - a. Ingredients
 - b. Equipment
 - c. Method
4. Tick ✓ in on the correct statement.
 - a. Vegetables can remain fresh for a longer time.
 - b. Vegetables are necessary for the growth and development of our body.
 - c. Vegetables should be soaked in water for prolong time.
 - d. Vegetables provide vitamin C and minerals.
 - e. Vegetables peeled with thick skins, lose their nutritive Value.
5. Fill in the blanks with appropriate words.
 - a. Vegetables are good sources of _____
 - b. Vegetables _____ constipation.
 - c. When vegetables are cooked with _____ their _____ is increased.
 - d. Peel vegetables _____

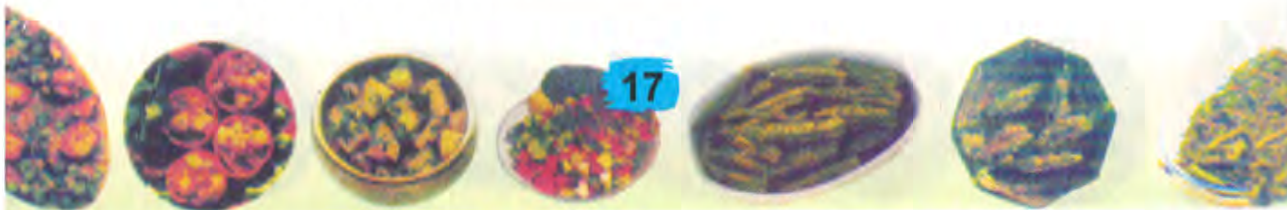

Evaluation

Practical _____ Vegetable soup

Standard marks are given against each statement in the following table. Write down the marks obtained by the student in the related column.

Sr. No.	Characteristics	Standard Marks	Marks Obtained
1.	Soup is neither thick nor thin.	5	
2.	Soup is of appealing colour.	5	
3.	Proportion of salt, chilli and spices is correct.	5	
4.	Vegetables are mashed properly.	5	
5.	Soup is served properly.	5	
6.	Soup is tasty and delicious.	5	
	Total marks	30	

Grade

Signatures of the
Teacher in charge _____

Dated _____



Evaluation

Practical _____ Mixed vegetable bhujia

Standard marks are given against each statement in the following table. Write down the marks obtained by the student in the related column.

Sr. No.	Characteristics	Standard Marks	Marks Obtained
1.	Proportion of spices is accurate.	5	
2.	Bhujia is of appealing colour.	5	
3.	Vegetables are tender.	5	
4.	Pieces of vegetables are not mashed.	5	
5.	Bhujia is tasty and delicious.	5	
6.	Bhujia is served properly.	5	
	Total marks	30	

Grade

Signatures of the
Teacher in charge _____

Dated _____

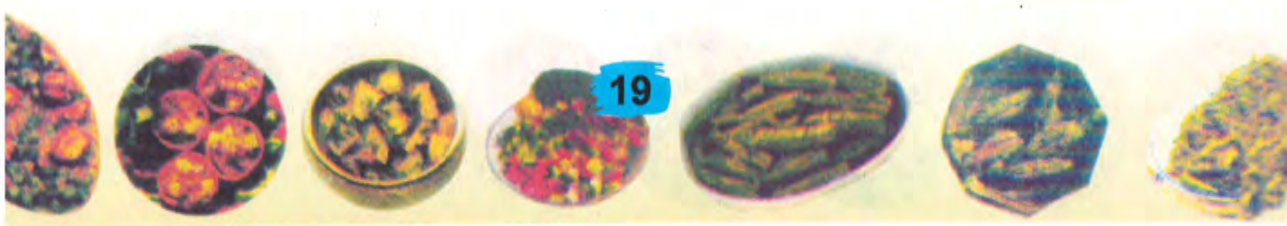



3

CEREAL COOKERY

Nutritive value of Cereals

Cereals include those foods which are used as whole grains or in the form of flour e.g. wheat, maize, barley, millet, rice and pulses etc.

Rice provide calcium, phosphorus and carbohydrates in abundance. Calcium and phosphorus are important for the growth and development of bones and teeth. Boiled rice with dal or milk are liked by children, young and old. Pulao and zarda are also prepared with rice which are full of nutrients. Wheat, maize, barley, millet etc. contains iron, calcium, proteins, carbohydrates and vitamin B in abundance.

Pulses are rich sources of carbohydrates and proteins. Pulses provide calories to the body. Deficiency of calories reduce body weight. When pulses are eaten with wheat or rice, their nutritive value becomes equivalent to meat. Pulses are not digestive without cooking. They should be soaked in water for one to one and a half hour before cooking

Boiled Rice

Ingredients

Rice	▶	1 cup
Water	▶	2 cups
Salt	▶	¼ teaspoon or as desired

Equipment

Saucepan or degchi, stove, match-box, duster, spatula, plastic bowl, cup, plate, dish for rice, dish spoon, tablespoon, tray with tray cover

Method

- 1 Pick the rice and wash under running water.
- 2 Soak for half an hour.
- 3 Boil water in a saucepan with salt.
- 4 When water boils add rice in it. Cook on medium heat.
- 5 When water dries up and rice become tender, then remove from stove and put rice in a dish.
- 6 Serve with dal in a tray with serving spoon, plate and tablespoon.

Precautions:

Following points should be kept in mind while cooking rice.

- 1 Too much rubbing during washing should be avoided.



2. The water in which rice are soaked should be used for cooking.
3. Rice should be boiled in the required quantity of water. Use of excess water should be avoided. water soluble vitamins are wasted when excessive water is thrown away.

Cooking of Dal

Dal is cooked in different ways. It can be cooked alone, with meat or with vegetables. Different methods require less or more quantity of water e.g. dal masoor and dal moong are cooked with more water. Dal mash and dal channa are cooked dry in bhuna masala.

Dal Masoor

Ingredients

Dal masoor	▶ 1 cup (1/4 kg.)
Ghee / Oil	▶ 2 tablespoons
Red chilli powder	▶ ½ teaspoon
Salt	▶ ¼ teaspoon or according to taste
Turmeric powder	▶ ¼ teaspoon
Coriander powder	▶ ½ teaspoon
Water	▶ 2 cups
Garlic (fresh sliced)	▶ 3-4 cloves
White cumin seed	▶ ¼ teaspoon
Green chillies (fresh)	▶ as desired
Green coriander (fresh)	▶ as desired



Equipment

Stove, saucepan or degchi, match-box, dustre, ladle, frying pan, knife, plastic bowl, curry bowl, serving spoon small curry plate, tablespoon, tray with tray cover.

Method

1. Pick and wash dal. Soak in water for five minutes.
2. Pour water in a saucepan. Add salt, chilli powder, turmeric powder, coriander powder and dal in it.
3. Cook on low heat, till dal is tender.



4. Sprinkle chopped green chillies and green coriander leaves on it. Remove from fire. Take out the dal in a curry bowl.
5. Brown garlic and cumin seeds in ghee and sprinkle on the dal.
6. Serve with boiled rice or chapaties in a tray with dal bowl, serving spoon, curry plate and tablespoon.

Questions

1. Write a note on the nutritive value of cereals.
2. Which points should be kept in mind while cooking rice?
3. Write down the method of boiled rice and dal masoor under following headings.
 - a. Ingredients
 - b. Equipment
 - c. Method
4. Tick ✓ in the on correct statement.
 - A. Excessive water of boiled rice should be thrown away
 - b. Rice should be cooked in the same water in which they are soaked.
 - c. Pulses are not good sources of carbohydrates and proteins.
 - d. Pulses are digestible without cooking.
 - e. Dal and boiled rice are favourite dish of the children, the young and the old.
 - f. The _____ value of boiled rice is lost
5. Fill in the blanks with appropriate words:
 - a. After Cleaning rice should be soaked for _____
 - b. The _____ nutritive value of boiled rice is lost when water is thrown away.
 - c. Pulses provide _____ to the body.
 - d. Pulses also contain carbohydrates and _____
 - e. Pulses should be _____ in water for one to one and a half hour before cooking



Evaluation

Practical _____ Boiled Rice

Standard marks are given against each statement in the following table. Write down the marks obtained by the student in the related column.

Sr. No.	Characteristics	Standard Marks	Marks Obtained
1.	Rice are picked before washing.	5	
2.	Rice grains are tender.	5	
3.	Rice are long and separate.	5	
4.	Rice are white in colour.	5	
5.	The flavour of rice is pleasant.	5	
6.	Rice are served properly.	5	
	Total marks	30	

Grade

Signatures of the Teacher in charge _____

Dated _____

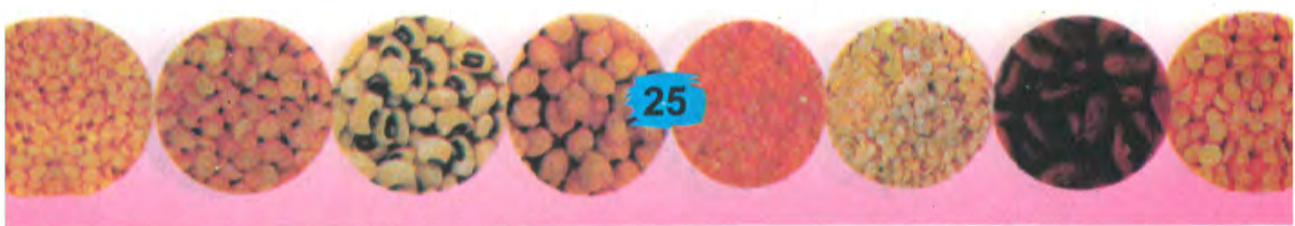

Evaluation

Practical _____ Dal Masoor

Standard marks are given against each statement in the following table. Write down the marks obtained by the student in the related column.

Sr. No.	Characteristics	Standard Marks	Marks Obtained
1.	Dal is picked before soaking.	5	
2.	Dal is tender.	5	
3.	Dal and water are not separate.	5	
4.	Dal is of appealing colour and flavour.	5	
5.	Proportion of salt, chilli and spices are correct.	5	
6.	Dal is served properly.	5	
	Total marks	30	

Grade

Signatures of the
Teacher in charge _____

Dated _____





■ Advantages of growing vegetables at home

Presence of a garden in the home is a sign for good and optimum health. Vegetables grown at home provide satisfaction and happiness. Moreover, fresh vegetables are available which are full of nutrients, clean and are cheaper. The vegetables purchased from the market are often stale and are expensive.

■ Selection of land for Growing of Vegetables

The land selected for growing of vegetables should have enough sunlight and it should be away from the shade of trees. The land should be fertile, because, fertile and soft soil produce, more vegetables.

If there is enough land available in the home it is best for growing vegetables. If there is not enough land in the home then empty ghee tins, wooden boxes, earthen vessels or flower pots can be used for growing creeping vegetable plants like pumpkin, torries, bitter-gourds and tomatoes. These may be kept against a wall. The creepers will climb over the wall thus saving the space. Other vegetables such as spinach, coriander and mint can be grown on date-leaves mat, with enough soil spread on it evenly. It should be surrounded with bricks.



Selection of Gardening Tools

Following gardening tools should be used for homegardening.



1. Shovel:

It is used for breaking soil pieces and for levelling the ground.

2. Spade:

It is used for digging hard ground to make it soft. It is also used for making beds and rows.

3. Hoe:

It is used for softening the soil in the beds and for weeding.

4. Water Sprinkler and Pipe:

Water sprinkler is used for spraying and sprinkling water on the plants. Rubber pipe is also used for watering of plants.



Principles of Growing Vegetables at Home

Following principles should be observed while growing vegetables at home.

I. Preparing the land:

1. Dig the ground about 5 centimeters deep. Make it soft by removing pieces of stones and bricks.
2. Put fertilizer in the prepared piece of land. Mix it with the hoe to incorporate air in it. The soil will become fertile.
3. For proper growth of vegetables it is necessary to use right kind of fertilizer. It should be mixed in the soil long before putting seeds in it.

II. Preparing the beds

1. Beds should be prepared in straight rows.
2. Different vegetables should be sown in each bed.

III. Sowing the seeds

Following points should be kept in mind while sowing the seeds.

1. Always use good quality of seeds. The characteristics of the good quality of seeds are:
 - a. The seed should be thick and without any wrinkles on its skin.
 - b. The seed should not be old and it should not have eaten by insects.
 - c. The seed should be of full bright colour and light in weight.
2. Seeds should be sown at depth so that birds can not pick them away.
3. Seeds should be spread at a distance apart to provide enough space for the plants to grow.
4. Do not over-wet the ground.
5. Spray water over beds after every third or fourth day.



IV. Growing seedlings

In certain cases we grow seeds in a small place and then transfer younger plants to some other place. While transferring plants care should be taken to avoid incorporation of air in them. It is better to take some soil along with the seedlings and sow it immediately at the place selected.



V. Care of plants

Following measures should be taken for healthy growth of plants.

1. Protect plants from insects and pests.
2. Protect plants from heat, cold and wind.
3. Protect plants from animals like dogs, hens, rabbits, cats etc. It is better to put a wire fence around the beds.
4. Protect plants from birds by hanging old tins over dug wooden sticks in the beds.
5. Plants should be watered in the morning and evening.
6. Weeding should be done at regular intervals.
7. Digging should be done for healthy growth of plants.
8. If some plants develop any disease, they should be immediately removed away from the other healthy plants.







IV. Observing the plants



Note down the date and time of showing the seeds in a note book. Observe them after two or three days.

Proper Method and Time for the Plantation of Different Vegetables

If you paste given chart in your kitchen, you will be well aware about proper method and time for the plantation of different vegetables throughout the year.

Vegetables	Proper method and time for plantation
Onions 	<ol style="list-style-type: none">1. Grown in middle of October.2. More water is needed in hot weather.
Turnips 	<ol style="list-style-type: none">1. Seeds are planted from September to October.2. Put the seeds at a distance of 3 decimeters in the fertilized land.3. They need more water.
Tomatoes 	<ol style="list-style-type: none">1. Tomatoes are grown in July.2. Keep a distance of ½ decimeters between plants.3. Support the plants with wooden sticks or strings to prevent tomatoes from rotting.
Beetroots 	<ol style="list-style-type: none">1. Sow seeds in September.2. Put seeds about 2.5 centimeters further apart.3. They need more water.4. Protect plants from birds, hens and pets.



<p>Chillies</p> 	<ol style="list-style-type: none"> 1. Chillies are grown in May. 2. Seedlings should be planted at a distance of 3.6 decimeters. 3. Weeding is necessary. 4. Water the plants after every two weeks. 5. If there is pest in the soil then sulphur spray is necessary.
<p>Coriander</p> 	<ol style="list-style-type: none"> 1. Seeds should be sown in October. 2. Water the plants after every fourth day. In hot weather it should be watered daily.
<p>Carrot and radish</p> 	<ol style="list-style-type: none"> 1. Seeds are sown from August to November. 2. Keep a distance of 3-6 decimeters between the plants. 3. They need more water.
<p>Mint</p> 	<ol style="list-style-type: none"> 1. Sow plants in April. 2. Its roots should be planted deep in the ground. 3. It should be watered daily in summer but less frequently in winter.
<p>Spinach</p> 	<ol style="list-style-type: none"> 1. Sow the seeds at the end of rainy season and in October. 2. Put the seeds 8 centimeters deep and 2.5 centimeters apart.



Besides these vegetables, cauliflower, brinjal, pumpkin and other vegetables can also be grown easily at home. You can also take guidance from other books in this respect.



Questions

1. What are the advantages of growing vegetables at home?
2. Which principles should be followed while growing vegetables at home?
3. Write down the proper time and method for the plantation of chillies, radish, carrot and spinach.
4. Tick ✓ in the on correct statement.
 - a. The soil should be fertile for growing vegetables.
 - b. Vegetables grown at home are not fresh.
 - c. Fertilizer is necessary for healthy growth of vegetables.
 - d. Seed should not be spread in the beds.
 - e. Plants should not be protected from insects and pests.
5. Fill in the blanks with appropriate words:
 - a. Presence of garden at home is a sign for _____ and _____ health.
 - b. The land should be _____ for growing vegetables.
 - c. _____ is used for breaking pieces of soil and for levelling the ground.
 - d. The seed should be _____ and without any _____ on its skin.
 - e. Plants should be watered in the _____ and _____



Evaluation

Practical _____ Growing Seasonal Vegetables

Standard marks are given against each statement in the following table. Write down the marks obtained by the student in the related column.

Sr. No.	Characteristics	Standard Marks	Marks Obtained
1.	Ground is prepared properly.	5	
2.	The soil is soft, stones and pieces of bricks have been removed.	5	
3.	Healthy and proper seeds are used.	5	
4.	Seeds are sown at proper time.	5	
5.	Beds are made at proper distance.	5	
6.	Plants are watered at proper time.	5	
	Total marks	30	

Grade

Signatures of the
Teacher in charge _____

Dated _____



SEWING

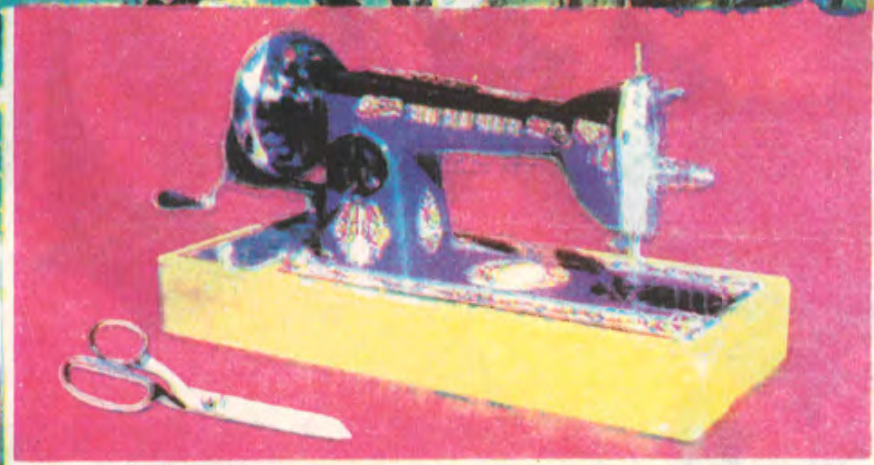



1 USE OF SEWING MACHINE



■ Sewing Machines

Stitching of clothes is an art which requires effort, interest, hardwork and skill. Young girls are fond of stitching from an early age. They start stitching dresses for their dolls when they see their mother and elder sisters doing so. In every home stitching and sewing is done. In order to emphasize their interest in sewing, it is necessary to teach them the basic principles of sewing clothes with machine from the very beginning. For example sewing machine is used for stitching and it is necessary to acquire skill in machine sewing.

Now-a-days sewing machine is present in every home. We can say that sewing machine is of fundamental importance in every home. in this chapter complete information about sewing machine, its various parts and their functions is given, which will be helpful for the girls during sewing.



Types of Sewing Machines

In Pakistan different types of sewing machines are available at a very reasonable price. These machines are durable, strong and easy to operate. These machines can also be bought on instalments.

1. Hand Operated Machine:

This machine is operated by hand. It has a handle, which can be replaced by an electric motor. This machine can easily be shifted from one place to another. It can be used by placing it on a table or a stool. It is quite cheaper as compared with other machines.



2. Foot Operated Machine:

This machine is fixed on a stand. It operates by the movement of pedal (footrest). It is mostly used for embroidery. It can be used for ordinary stitching by fixing an electric motor on it.



3. Electric Machine:

This machine works with electricity. An electric motor is fixed on it.

One wire of the motor is connected to a plug and the other to the speed controller. For operating this machine, the speed controller is pressed. The more the pressure is applied on the speed controller, the faster it works. The use of this machine is very common

these days because work can be easily and quickly done by this machine. Moreover, physical energy is also saved. It is more costly than hand and foot operated machine.

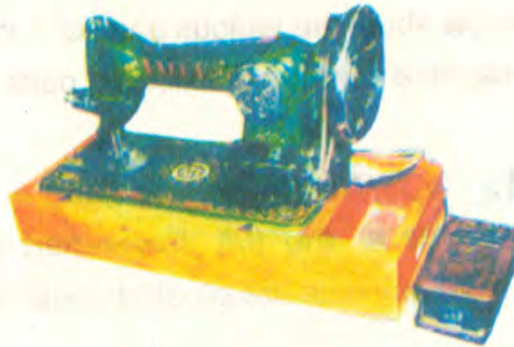

4. Computerized Machine:

This is the most advanced type of machine. Different designs can be created with this machine in addition to ordinary stitching. Different disks are provided with this machine, which are used for making a number of designs. This machine saves time and energy. It also works with an electric motor. It is more expensive than all other machines.



Before buying any type of machine, its performance should be examined carefully so that it may not cause any trouble afterwards. Further more, special attention should be given to its care and maintenance because it is not possible to buy it repeatedly.



1. Main Part of a Machine and their Functions

To become master in operating a machine, it is necessary to know about the various parts of a machine and their functions. A sewing machine consists of following parts which perform different functions.

1. Bed

It is the flat lower part of the machine. All parts of the machine are situated under it.

2. Arm

It is the front rounded part of the machine. Threading of machine is started from it. The bed of the machine can be lifted by holding back the arm.

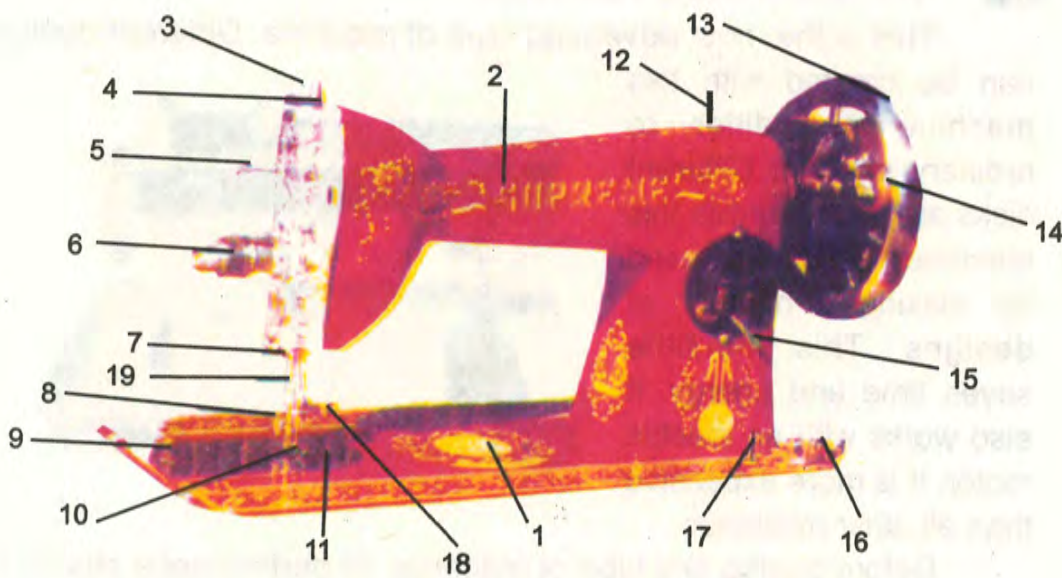

3. Presser bar

It controls the pressure of presser foot on the cloth.



4. Thread lever

It is responsible for smooth flow of the needle thread.

5. Presser bar lifter

It is used for lifting and lowering the presser foot. It is located at the back of the machine.

6. Tension regulator

It increase or decrease tension of the thread to obtain correct stitching. If the upper thread is tigh. it will break the thread repeatedly.

7. Thread cutter

It is used for cutting of thread.

8. Foot

It keeps the cloth pressed on the feed dog.

9. Slide plate

It slides backward and forward. The bobbin can be put in or taken out by sliding the plate.

10. Feed dog

It helps the cloth to move on at the time of sewing.



11 Throat plate

It provides space for the cloth while sewing. It also covers and protects the lower parts of the machine.

12 Spool pin

It is used to place the spool of thread during sewing.

13 Balance wheel

It is round in shape and is fixed at the right side of the machine. It controls the movement of the thread lever and the needle.

14 Bobbin winder

It is used to fill the bobbin with thread. When the thread is filled, it comes up automatically.

15 Stitch length dial

It has numbers on it, which show the number of stitches in 2.5 centimeters. Reverse stitching is done by lifting its handle upward.

16 Bobbin regulator

When the bobbin is being wound it releases the thread in right tension and the bobbin is evenly filled with thread.

17 Spool pin

It is fixed on the bed of the machine. Spool is placed on it during filling of bobbin thread.



18. Needle screw clamp

It tightens the needle and keep it in place.

19. Thumb screw clamp

The foot of the machine can be removed by loosening the clamp and replaced by tightening the clamp.

Common defects, their causes and methods to rectify them

During stitching some defects might occur in the sewing machine. For example, heaviness in the working of machine, breaking of thread, skipping of stitches, loose stitchese etc. These are minor defects which can be easily rectified. Achievement of knowledge about these defects and how to rectify them is necessary for perfect operation of the sewing machine.

Some common defects, their causes and methods to rectify them are given below:

1. If the machine works heavily

Sometimes the lint of the cloth or pieces of thread get accumulated in and around the shuttle and under the feed dog. For this;

1. Open the machine, clean the shuttle and the area around it with a fine brush. The machine will again run smoothly.
2. Clean and oil the machine. Often machines run hard after standing idle and not used or oiled properly.



2. **If the needle breaks**

Sometimes the needle breaks repeatedly during stitching. For this, check and see whether,

1. The needle is bent.
2. The presser foot is not firmly held in its place.
3. The size of the needle is not according to the thickness of the cloth.
4. The cloth is handled tightly during stitching.

3. **If the needle thread breaks**

Sometimes the needle thread breaks repeatedly during stitching. For this check and see whether,

1. The needle is not threaded correctly.
2. The needle is not straight and sharp.
3. The size of the needle is not according to the thread.
4. The needle thread tension is too tight.

4. **If the bobbin thread breaks**

Sometimes the bobbin thread breaks repeatedly. For this, check and see whether

1. The bobbin thread tension is too tight during stitching.
2. The bobbin is over-wound with thread.
3. The shuttle is clogged with lint or some thread.

5. **If the machine skip stitches**

Some times the machine skip stitches during stitching. For this,



Check and see whether;

1. The size of the needle is according to the thread and cloth.
2. The needle is inserted correctly in the needle clamp and is straight and sharp.
3. The lint had not accumulated under the faaed dog.

6. If the stitches are loose

Sometimes the machine give loose stitches during stitching. For this check and see whether;

1. The machine is properly threaded.
2. The upper tension (needle thread) and lower tension (bobbin thread) are correct
3. The stitch length regulator is in correct position.
4. The bobbin is not loosely wound.
5. The size of the needle is according to the thread.

Care and Cleaning of the Sewing Machine

A sewing machine is a very expensive and long lasting item, therefore, it should be looked after carefully. The performance of a sewing machine depends on its maintenace. If any part of the machine is rusted, its operation is affected. Therefore, it is necessary to clean the machine after use and oil it twice a month or so.



Cleaning the Machine

1. Always use a soft cotton cloth or a fine brush for cleaning. Clean outer parts of the machine with a soft cotton cloth
2. Clean inner parts of the machine with a fine brush as shown in fig .1
Remove the throat plate and slide plate. Open the cover of the shuttle, take out the bobbin and thoroughly brush the inner parts so that no lint or thread is left in it.

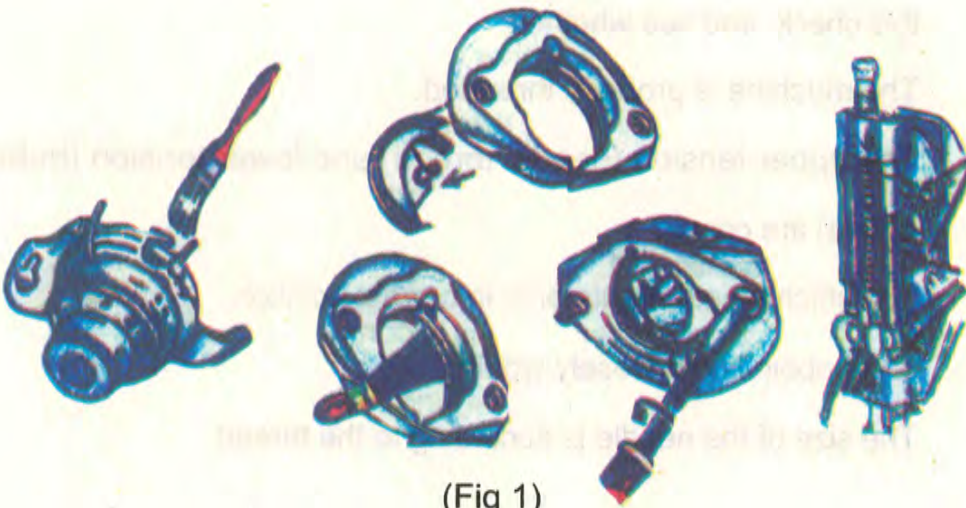

(Fig 1)

Oiling the Machine

1. Use machine oil for oiling the machine. Apply one drop of oil at each place indicated by arrows in the Fig 2. Then run the machine rapidly so that oil may reach in all the inner part. After the machine has been oiled completely, run it on a piece of old cloth. By doing this excess oil will come off on the material.



2. Open the machine and apply oil on all inner parts of the machine with a brush. Run the machine rapidly to let the oil reach at all inner parts. Keep it in sun for few hours and then cover it.

If you desire to use it, then wipe it with a cloth and run it on a waste cloth. The excess oil will come off on the waste cloth and the

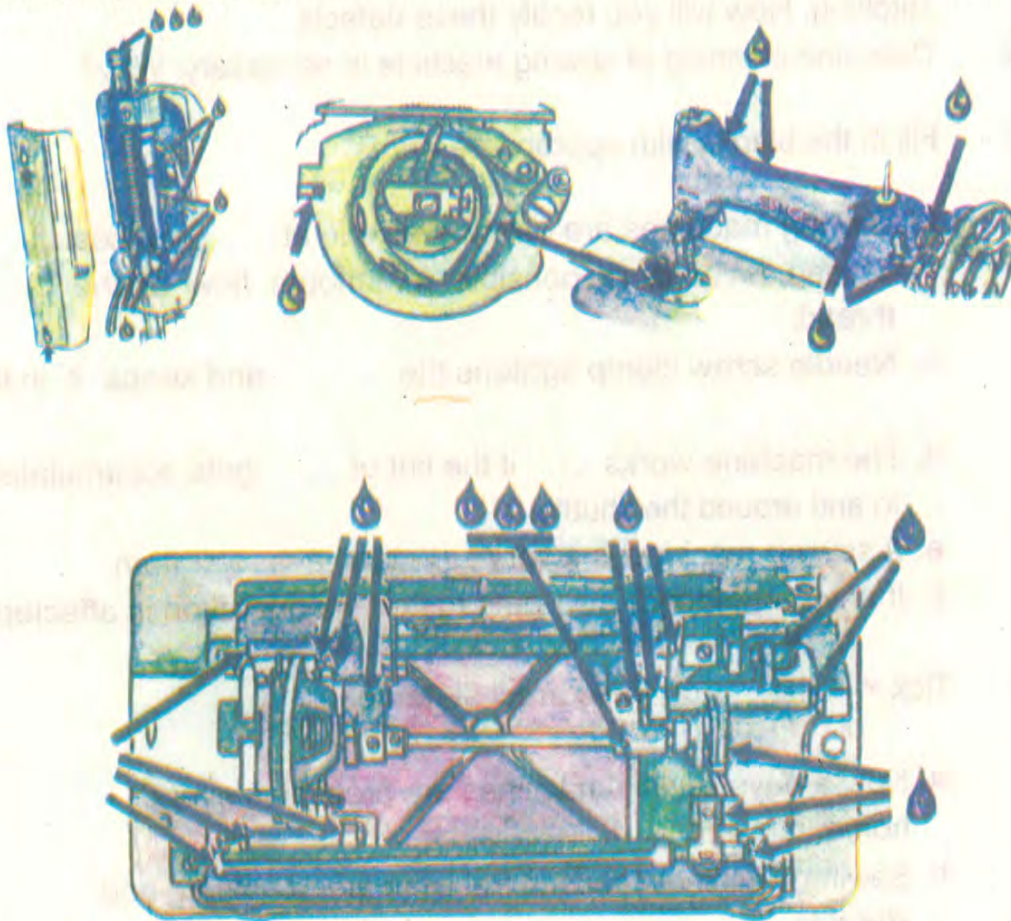

(Fig 2)

actual cloth will not get oil spots.

If you desire to keep the machine unused for sometime, then loosen the balance wheel, place a folded piece of cloth under the presser foot and cover it with its lid. This will prevent the machine from dust and rust.



Questions

1. Explain in detail the various types of sewing machines.
2. Write the main parts of a sewing machine and their functions.
3. Write down the main defects which might occur during machine stitching. How will you rectify these defects.
4. Care and cleaning of sewing machine is necessary. Why?
5. Fill in the blanks with appropriate words.
 - a. Sewing machines are easily available at _____ prices.
 - b. Thread lever is responsible for smooth flow of the _____ thread.
 - c. Needle screw clamp tightens the _____ and keeps it in its
 - d. The machine works _____ if the lint of _____ gets accumulated in and around the shuttle.
 - e. A sewing machine is a very _____ and a _____ item.
 - f. If any part of the _____ gets rusted, its operation is affected.
6. Tick ✓ in the on the correct statement.
 - a. Now-a-days sewing machines are present in every home.
 - b. Sewing machines made in Pakistan are not strong and durable.
 - c. Work is done easily with on electric sewing machine.
 - d. A sewing machine does not have complicated and delicate part.
 - e. A soft cloth and a brush should be used for cleaning the sewing machine.



2

PREPARATION FOR SEWING



To become master in sewing it is necessary to use the correct methods of machine sewing, so as to make the sewing process easy and to retain the interest in sewing. Following steps may be considered for the preparation of sewing.

1. To use the correct method of sewing.
2. To acquire skill in operating the machine.
3. To fix the needle.
4. To thread the machine.
5. To keep the thread tension correct.
6. To regulate the length of stitches.
7. To use the correct method for beginning and ending of stitches.
8. To use the correct method for holding the cloth during stitching.

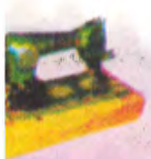

1. To use the correct method of sewing.

Sit straight while sewing so that the eye and hand muscles are in harmony with one another. If you stop down while sewing, your shoulder and back muscles will be tired soon. Furthermore, the sewing machine should be placed at a place where light comes from the left side of the worker.

2. To acquire skill in operating the machine.

In order to acquire proper skill in operating the machine, it is necessary to practice stitching on a brown paper in straight lines and in different directions without threading the needle. (Fig 2.1). This

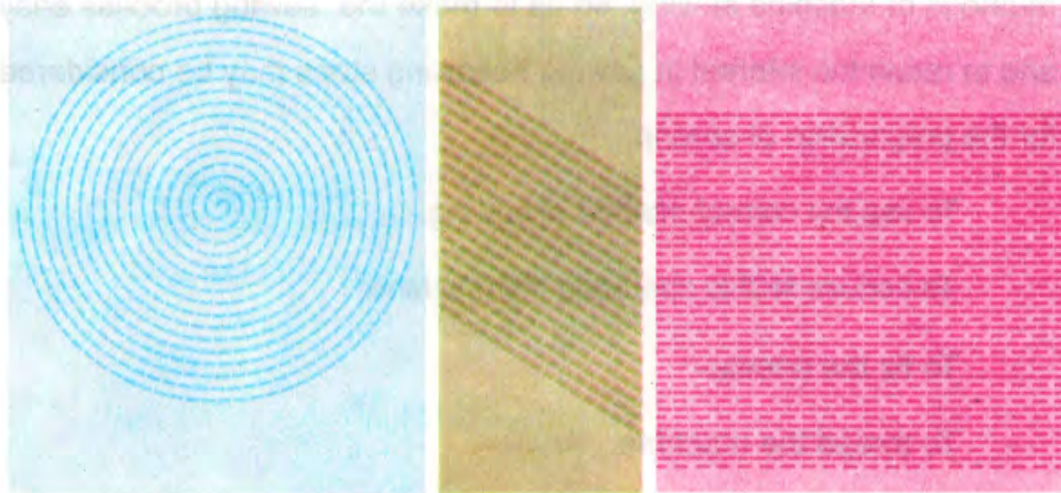

practice will be helpful during actual sewing. Moreover, you will learn to control the motion of the machine at the beginning and ending of the stitches. After this, thread the needle and practice machine stitching in straight, diagonal and circular lines.



3. To fix the needle

To fix the needle properly, is an important step in machine sewing. The needle should be straight and fine for proper stitching. The needles number 9,11,16,and 18 are mostly used for machine. The needle should have a clear eye or hole so that it can be threaded easily. (Fig2.2A,B)

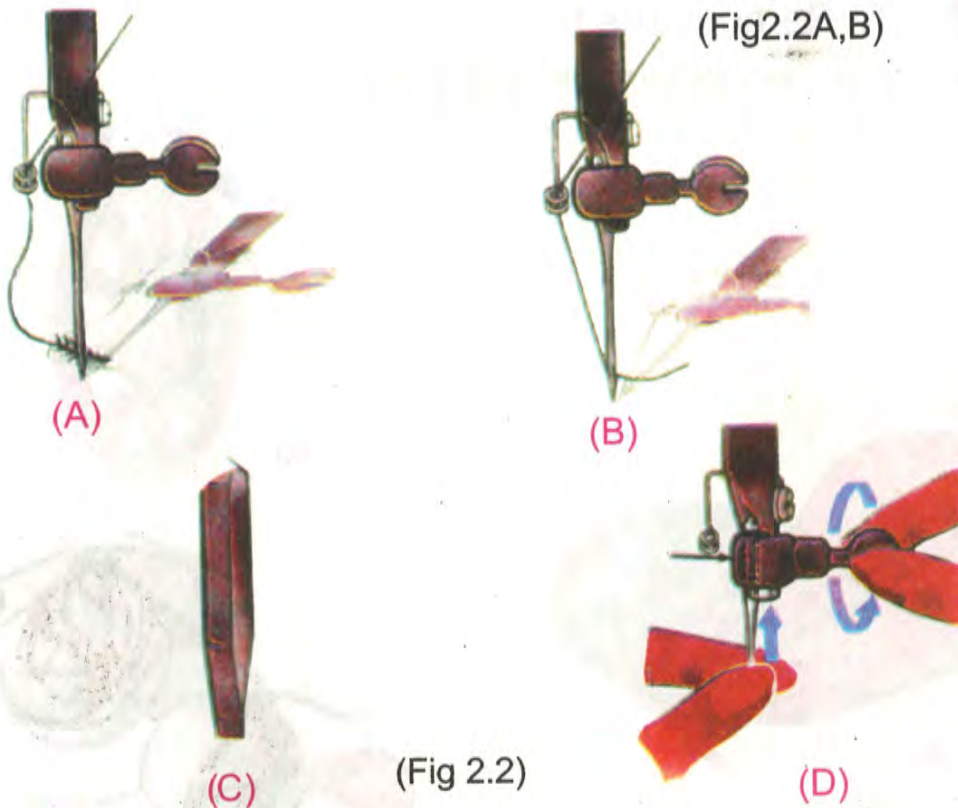

Method:

1. Turn the balance wheel towards you till the needle goes at its highest position. Loosen the screw of the needle clamp.
2. Push the needle into the needle clamp by keeping flat side of the needle towards right side. (Fig2.2C) and rounded side towards left side.
3. Tighten the screw clamp. (Fig 2.2D)



4. Threading the machine

To stitch with the machine, a set of two threads is required.

- A. Lower thread comes up from the bobbin through the feed-dog.
- B. Upper thread comes from the spool into the needle.

A. To wind the bobbin

I To Remove the bobbin

- 1. Turn the balance wheel. (Fig. 2.3A)

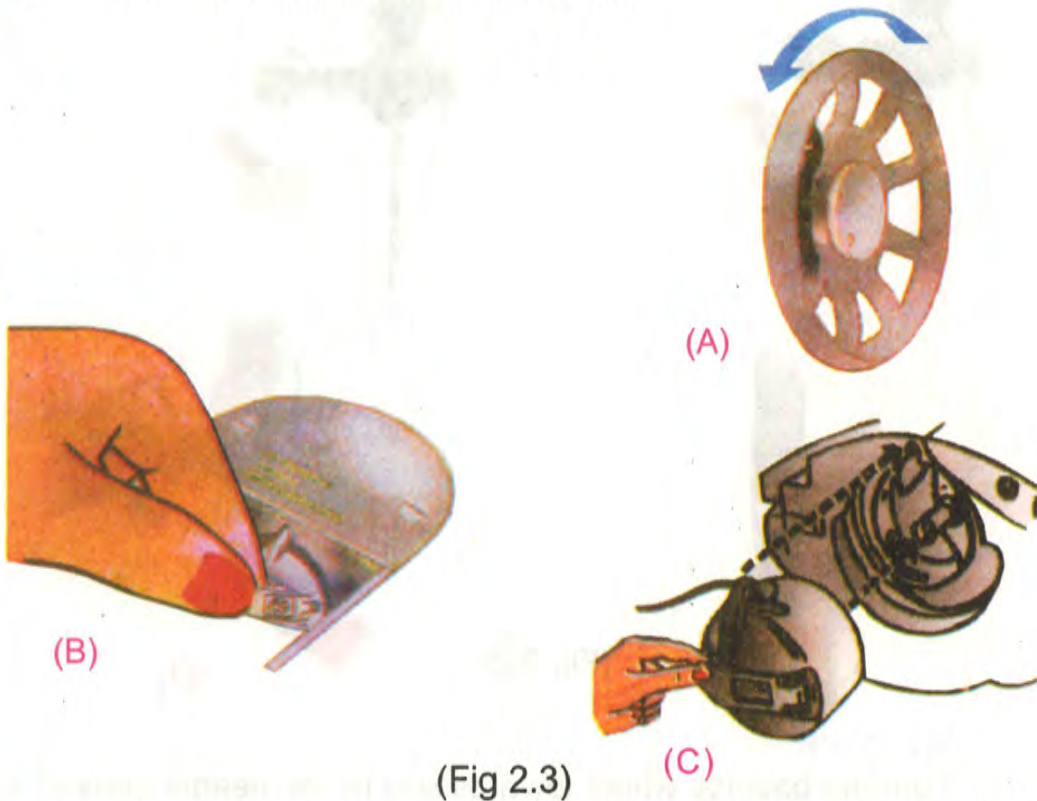

- 2. Withdraw the slide plate open the bobbin case latch with your left hand and bring out the bobbin case (Fig 2.3B)
- 3. Release the latch and take out the bobbin from the bobbin case. (Fig 2.3C)



(ii) To wind the bobbin

1. Hold the balance wheel with the right hand and loosen the stop motion screw (Fig 2.4A).
2. Place bobbin on the bobbin spindle, and press it with the balance wheel (Fig 2.4B)
3. Place spool of thread on the spool pin. Pass thread through slots in the bobbin and bring it out. Wind a little thread on the bobbin with your hand. (Fig 2.4C)

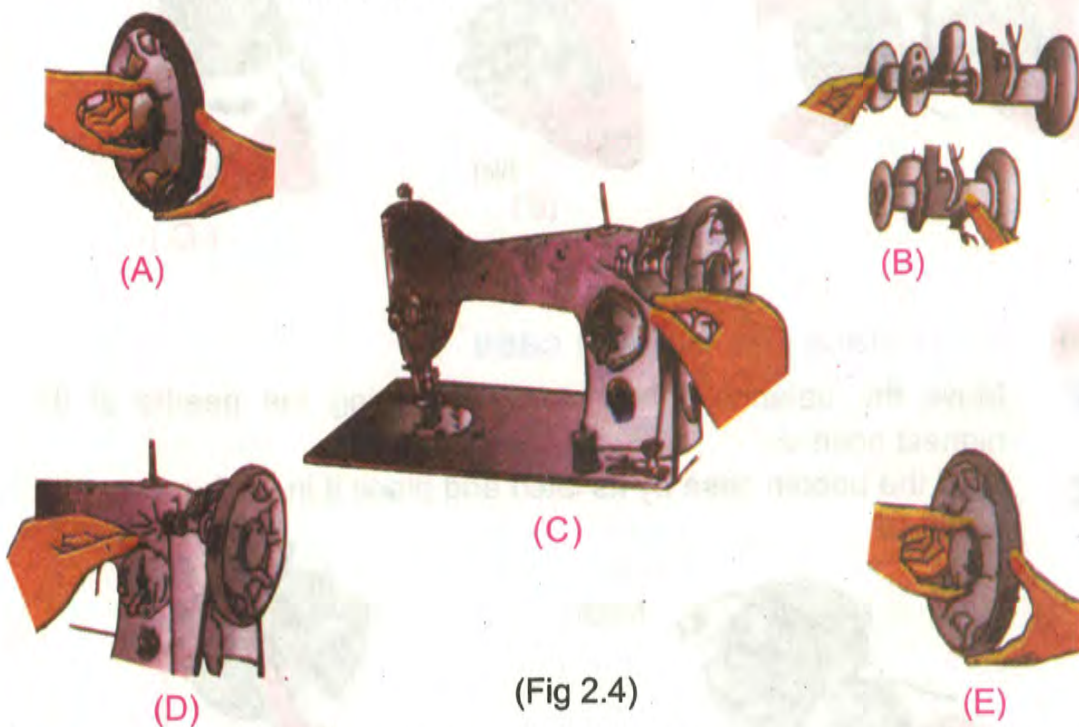

4. Now operate the machine, when sufficient thread is wound around the bobbin, stop the machine and break off thread from the spool. (Fig 2.4D)
5. Take out the bobbin from the bobbin winder spindle and tighten the stop motion screw. (Fig 2.4E)



(iii) To thread the bobbin case

1. Hold the bobbin in such a way that its thread can be pulled out easily (Fig 2.5A) Now put the bobbin in the bobbin case by leaving the end of the thread outside.
2. Put this end of thread into the slot and under the spring in the bobbin case and take it out of the hole. (Fig 2.5B)
3. Take out about 5 centimeters of thread. (Fig 2.5C)

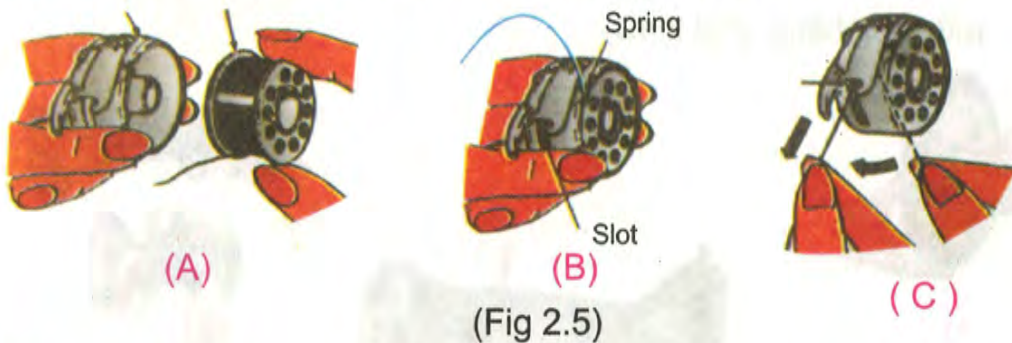

(iv) To replace the bobbin case

1. Move the balance wheel slowly and bring the needle at its highest position.
2. Hold the bobbin case by its latch and place it in such a way that

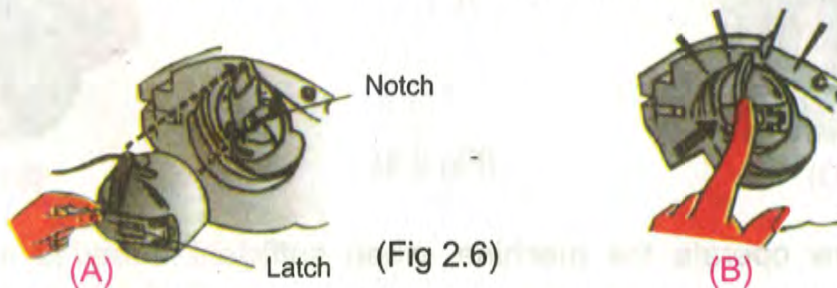

the little finger in the bobbin case is opposite to the notch at the top of the shuttle case. (Fig 2.6A)

3. Release the latch and push the bobbin case in it till it sets and gives a sound of tick. (Fig 2.6B) Close the slide plate.



(B.) To thread the needle

Raise needle to its highest level. Place spool on the spool pin.

1. Pass thread through all the thread guides (Fig 2.7)
2. Thread the needle from right to left through eye of the needle. Draw out about ten centimeters of thread.

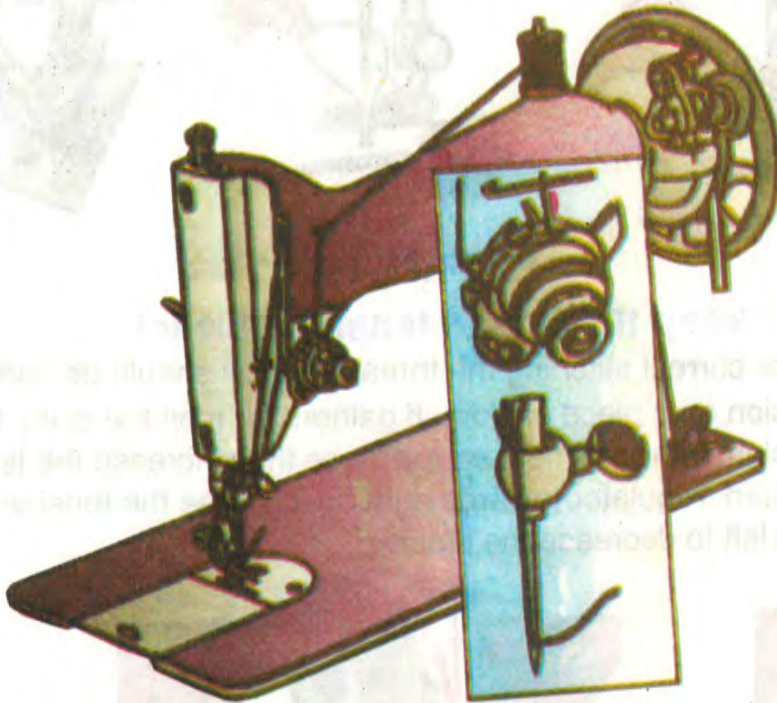

(Fig 2.7)

C. To draw out the lower thread

Hold the needle thread with the left hand. Turn the balance wheel slowly till the needle goes inside the feed dog. (Fig 2.8A)

1. Keep on moving the balance wheel slowly, hold on the needle thread till needle comes up again. Pull the needle thread. The bobbin thread will come up along with the needle thread.
2. Pull the needle thread. The bobbin thread will come up along with the needle thread.

(Fig 2.8B)



3. Lay both threads under the presser foot. (Fig 2.8C) Now Your machine is ready for stitching.

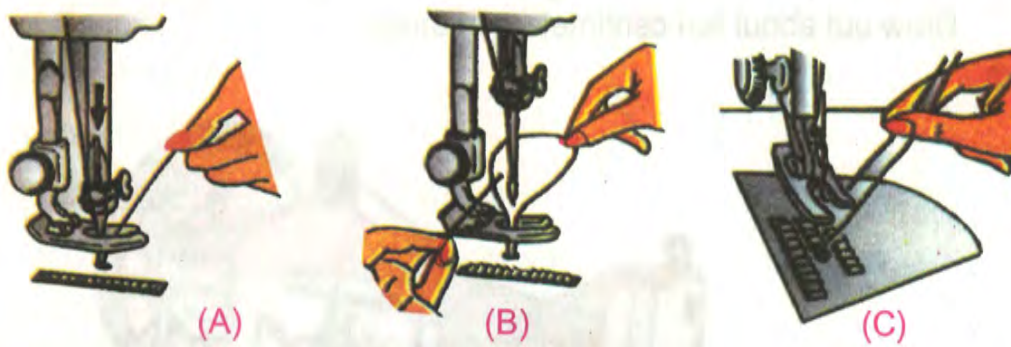

(Fig 2.8)

5. **To keep the thread tension correct**

For correct stitching the thread tension should be correct. Check the tension on a piece of cloth. If gathers form on the cloth, then loosen the tension. If the stitches are too loose then increase the tension. Turn the tension regulator towards right to increase the tension and turn it towards left to decrease the tension.

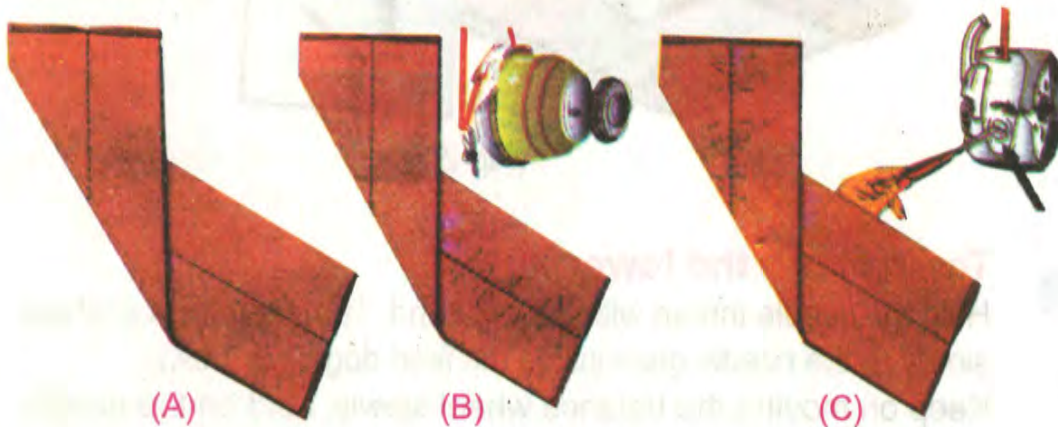

(Fig 2.9)

- I For correct stitching the needle thread and the bobbin thread should lock at the center of the cloth. (Fig 2.9A)



- ii If the tension of the needle thread is too tight or the bobbin thread tension is too loose, the needle thread will be straight on the upper surface of the cloth and the bobbin thread will come up in loops. This stitch is not correct (Fig 2.9 B)
To correct it, tighten the screw of the bobbin towards lower numbers to decrease the tension. Higher numbers denote increased tension.(Fig 2.9C)
- iii If the tension of the bobbin thread is too tight, the thread will accumulate under the material. (Fig 2.9D)
To correct it, loosen the bobbin screw to decrease the tension.

6. To regulate the length of stitches

This part of the machine performs two functions. It controls the length of the stitches and also do reverse stitching.

On the stitch indicator plate there are numbers. These numbers indicate the number of stitches in 2.5 centimeters. To regulate the length of stitches, loosen the thumb screw, move the stitch regulator till



Fig No 10

its upper side is at the level of the numbers of desired length of stitches. Tighten the screw so that lever remains at this level. (Fig 2.10)



You can also do reverse stitching on the cloth by moving stitch regulator lever up beyond the numbers. Now the direction of the stitching is reversed.

7. To use the correct method for beginning and ending of stitching

A. To begin with the stitching

- i** Fix the number of stitches. Lift the presser foot. Insert the needle into the cloth about one centimeter down (Fig 2.11A)
- ii** Lower the presser foot. Do reverse stitching up to the edge of the cloth. (Fig 2.11B) and then start stitching.

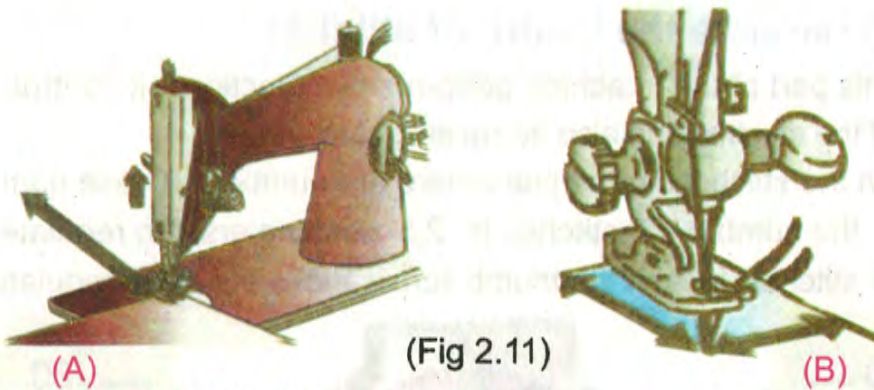

B. To end with the stitching



Raise the stitch regulator at its highest point and do reverse stitching to make end of the stitches strong. (Fig 2.12A. B)



- ii Move balance wheel towards yourself to lift the needle
- iii Raise presser foot and take out the cloth. Cut thread with the cutter (Fig. 2.12 C)

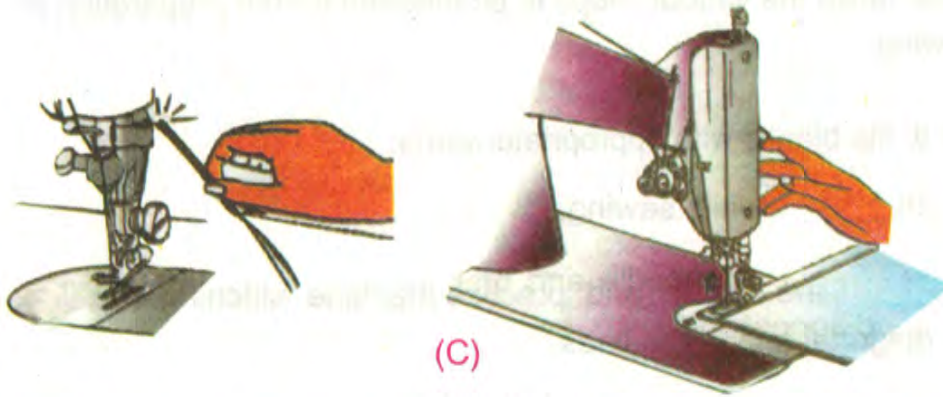

(C)
(Fig 2.12)

8. To use the correct method for holding the cloth during stitching

During stitching many materials require grip near the presser

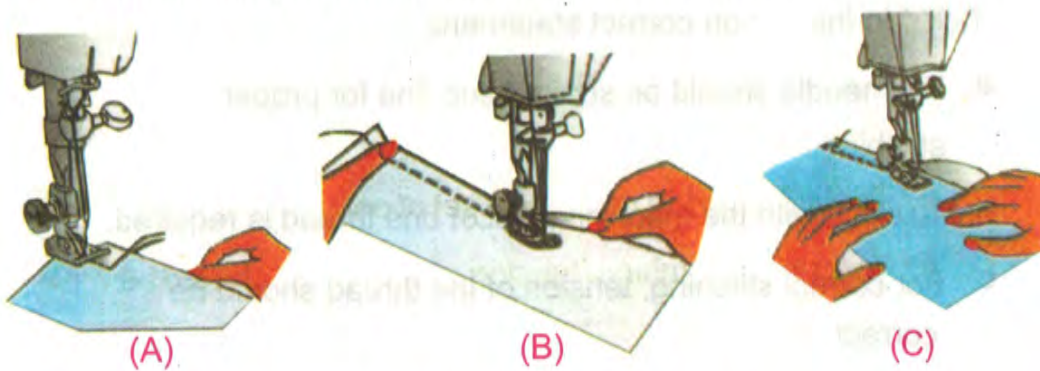

(Fig 2.12)

foot. For example, cotton materials require little grip whereas flexible materials require more grip while stitching. (Fig 2.13A, B,C)



Questions

1. Write down the various steps to be followed for the preparation of sewing.

2. Fill in the blanks with appropriate words:

- Sit _____ while sewing.
- _____ the needle and practice machine stitching in diagonal and _____ lines.
- The _____ should be straight and _____ for proper stitching.
- For correct stitching _____ should be correct.
- To stitch with the machine a set of _____ threads is required.

3. Tick ✓ in the on correct statement.

- The needle should be straight and fine for proper stitching.
- To stitch with the machine a set of one thread is required.
- For correct stitching, tension of the thread should be correct.
- For reverse stitching, turn the lever towards back.
- It is not necessary to strengthen the end of stitches.



3 MACHINE SEAMS



Machine stitching is of prime importance in stitching. It plays an important role in the construction of garments. To make a seam firm and neat, its edges are finished by using different seams which are called seam finishes.

Following four seams are used for the stitching of garments. In this class you will only **Learn** the method of plain seam and french seam.

1. Plain Seam.
2. French Seam.
3. Flat Fell Seam.
4. Lapped Seam.



1. Plain seam.

It is basic and an easy seam. It is used for stitching all types of garments.

Method

1. Join two pieces of fabric from the right side and pin them together.
2. Draw a line at a distance of $\frac{1}{4}$ cm. from the edge (Fig 3.1A)
3. Thread the machine with matching thread.
4. Place cloth under the presser foot and stitch on the line from one end to the other.

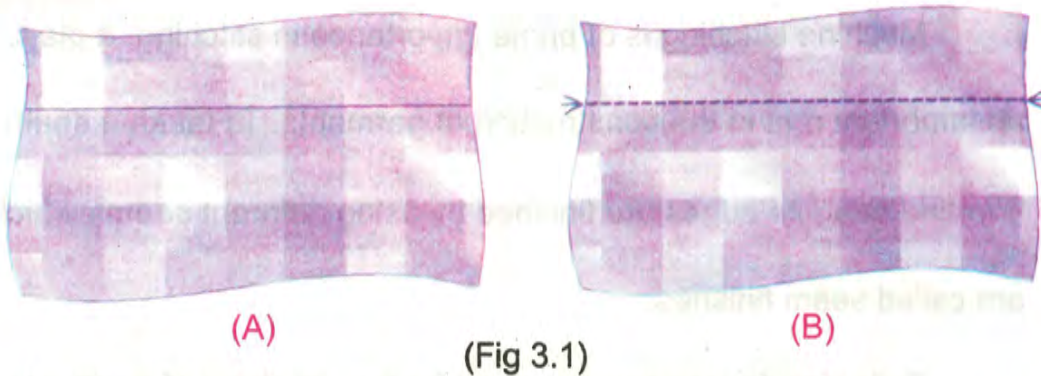

5. Cut thread with a scissors. Make knots of threads on both ends of the cloth.
6. Plain seam is ready. (Fig 3.1B)

2. French seam.

It is used for sheer materials so that the edges of the cloth do not get ravel and are concealed.

Method

1. Join two pieces of fabric with right sides out and pin.





(A)

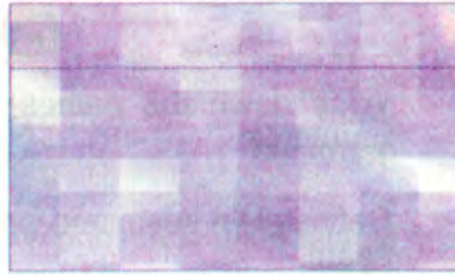

(B)

(Fig 3.2)

2. Draw a line with a pencil at a distance of 1cm. from the edge. (Fig 3.2A)
3. Thread machine with matching thread. Stitch on the line. (Fig 3.2B)

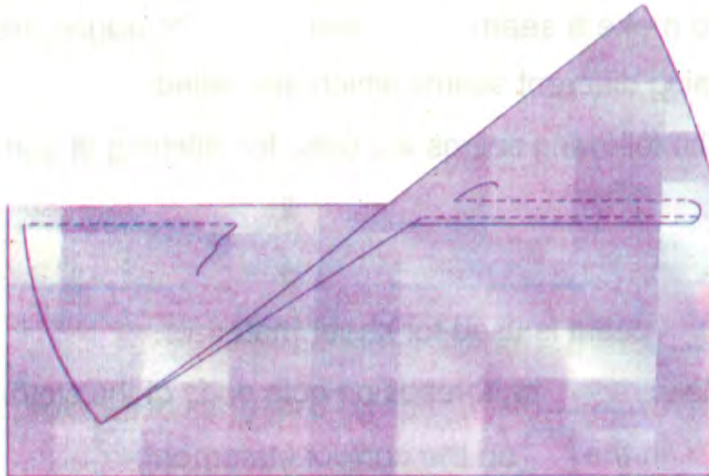

(C)

(Fig 3.2)

4. Fold right sides together with stitched line exactly on edge of fold and press. Stitch on the seamline so that the first seam is completely concealed.



Questions

1. Write down the names of the seams used for stitching of garments.
2. Define plain seam and write down the method of making a plain seam.
3. What is the purpose of using a french seam? Write down the method of making a french seam.
4. Fill in the blanks with appropriate words:
 - a. _____ stitching is of prime importance in stitching.
 - b. To make a seam _____ and _____ its edges are finished by using different seams which are called _____.
 - c. The following seams are used for stitching of garments.
 1. _____
 2. _____
 3. _____
 4. _____
 - d. _____ seam is used for sheer materials.
 - e. Make _____ of threads on both ends of the cloth.
5. Tick ✓ in the on the correct statement:
 - a. Machine stitching is of prime importance in stitching.
 - b. Machine stitching does not play an important role in the construction of garments.
 - c. Seam finishes make the seams firm.
 - d. Plain seam is not a basic seam.
 - e. French seam is mostly used for sheer materials.



Evaluation

Practical Plain Seam

Standard marks are given against each statement in the following table. Write down the marks obtained by the student in the related column.

Sr. No.	Characteristics	Standard Marks	Marks Obtained
1.	The pieces of cloth are of suitable size.	5	
2.	Pieces of cloth are stitched according to the instructions.	5	
3.	The stitches are even.	5	
4.	The method used for plain seam is correct .	5	
5.	Plain seam is made neatly.	5	
	Total marks	25	

Grade

Signatures of the
Teacher in charge _____

Dated _____



Evaluation

Practical _____ French Seam

Standard marks are given against each statement in the following table. Write down the marks obtained by the student in the related column.

Sr. No.	Characteristics	Standard Marks	Marks Obtained
1.	The pieces of cloth are of suitable size.	5	
2.	The pieces of cloth are stitched according to the instructions.	5	
3.	The stitches are even.	5	
4.	The basic stitches are not visible.	5	
5.	The french seam is made neatly.	5	
	Total marks	25	

Grade

Signatures of the
Teacher in charge _____

Dated _____



4

DECORATIVE AND REGIONAL STITCHES

Importance of decorative and regional stitches

Embroidery is an interesting and easy art. Girls are fond of embroidery from an early age. In the beginning simple stitches and coloured threads are used for embroidery. Since practice makes one perfect, therefore perfection in the use of simple stitches makes it easy to learn embroidery. A number of decorative and regional stitches are used to embroider the clothes, dresses and other household articles.

Satin stitch

This stitch is most commonly used in embroidery and is used to fill the leaves and petals of flowers. In this stitch the stitches are taken very close to each other and are straight or slanting. One uniqueness of this stitch is that the stitches are same on both sides of the fabric. The stitches are close enough to completely cover the design. This stitch is used not only on sheer fabrics but it can be used on fabrics of all kinds.

Method

1. Draw a petal on the fabric with a pencil and mark points 1,2,3,4,5,6 (Fig 4.1A)
2. Bring the needle out of cloth at point 1 and pass it down wards from point 1.
3. Take the needle out of cloth from point 3 and pass it downwards from point 4. Continue taking stitches in this way till the petal is filled. (Fig 4.1 BC)

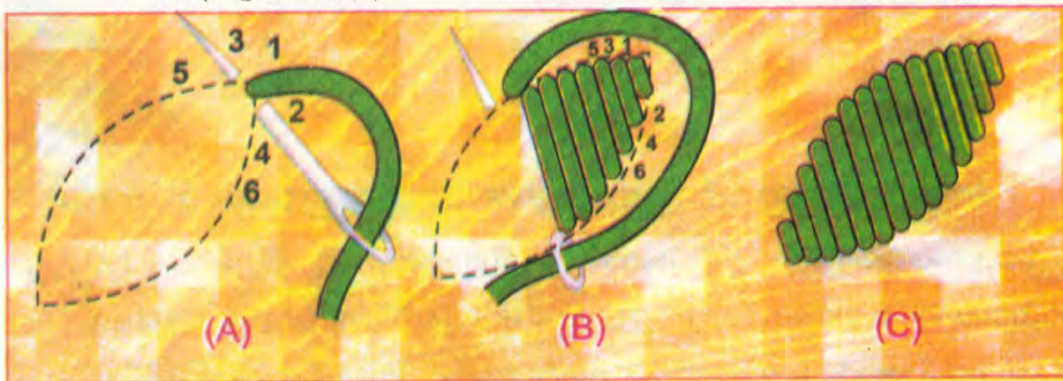

(Fig 4.1)

Phulkari or Swati stitch

This typical stitch is used in swat and other northern areas. The fabric used for it should be such in which threads can be counted easily. One uniqueness of this stitch is that it is made on the wrong side of the fabric. Raw silky threads in dark colours, for example dark pink, yellow, maroon, green or violet are used for embroidery. The embroidery is mostly done on white or black khaddar. Necklines of kurtas are filled with this stitch and design is scattered on the rest of the dress. The same design is repeated on cuffs, shirts and paenchahas of the shalwars.

The designs of phulkari for shawls are such in which the whole fabric is filled with stitches, but in some designs the fabric is visible.



Method

1. Trace the pattern on the fabric.
2. Make outline of the pattern with straight stitches by using black thread. (Fig 4.2 A)
3. For filling, take four strands of thread. With the right side up take out the needle from point 1. Take the needle downwards at point 2 and then take it out at point 3. Take the needle downwards at point 4 and bring it upwards at point 5. (Fig 4.2 B) Repeat it to complete the design. (Fig4.2C)

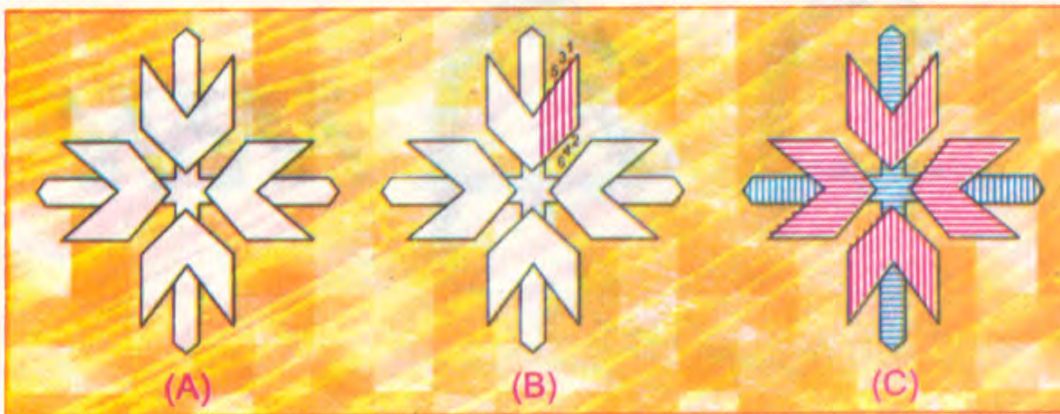

(Fig 4.2)

Sindhi stitch

Sindhi stitch is from Sind and is used on different fabrics and garments. This stitch is easy to make, but it is necessary to gain perfection in it. The foundation of this stitch is a double row of herringbone stitches made into a square. Usually six strands of threads are used for embroidery.



Making the Herringbone stitch

1. Take the needle out of the fabric at point 1.
2. Make a slanting stitch at point 2 (Fig 4.3A) and bring the needle out wards at point 3.
3. Make a slanting stitch between point 3 and 4, bring the needle out wards at point 5. (Fig 4.3 B) Repeat it to complete the herringbone stitch. (Fig 4.3 C)

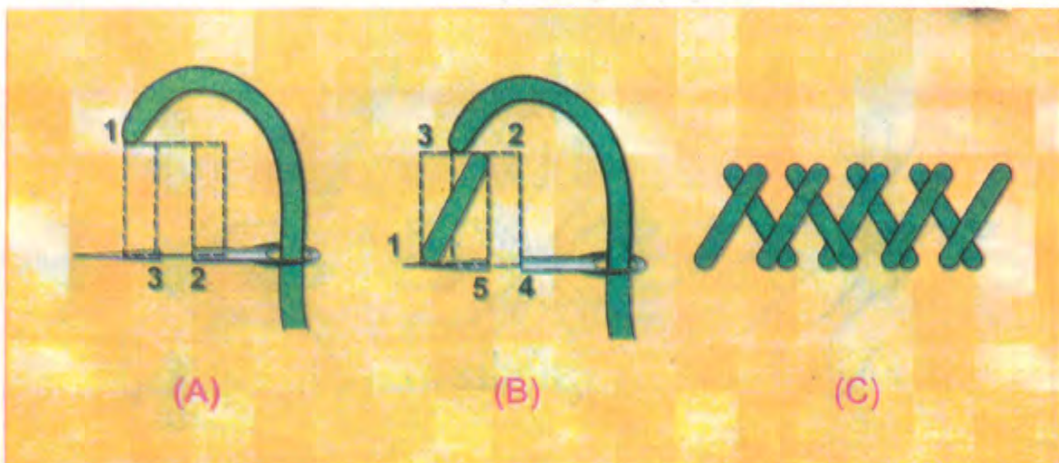

(Fig 4.3)

Making squares in Sindhi stitch

Follow Fig4.4 a b and c.

- A. Bang the thread outwards at point A, take a stitch through B and C. Then take the stitches from C to D and D to E to complete the foundation stitches.
- B. Now start filling the pattern from F and complete it.



C. A square in Sindhi stitch is complete.

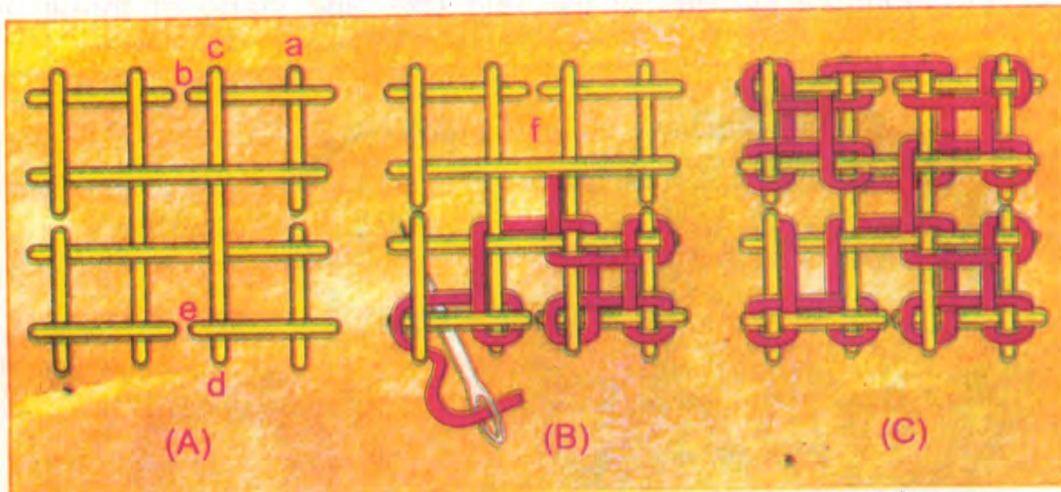

(Fig 4.4)

Mirror work

Mirror work is common in Baluchistan and Sind, but it is equally liked everywhere. A number of things are made with mirror work. It is done with small round mirrors and with or without the ring. (Fig 4.5 A) It is easier to make it with the ring and it has a neat look.

Method of making the mirror work with a ring

1. Make buttonhole stitches on the ring of the mirror closely so that the ring is completely concealed. (Fig 4.5A)
2. Place prepared ring on the mirror (on the pattern) in such a way



that edges of the mirror are completely covered with it.

3. Fix the mirror on the cloth by taking small stitches through the buttonhole stitches of the ring. Use one stand of thread in

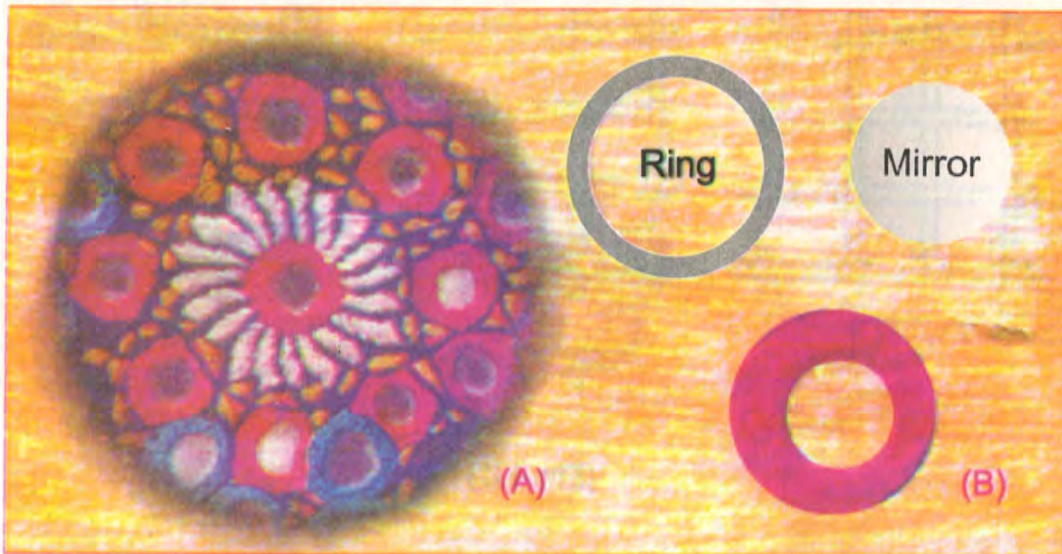

(Fig 4.5)



matching colour. (Fig 4.5B)

Note: Be careful that the stitches taken from the buttonhole stitches of the ring are not visible on the front side.



Questions

1. Write a note on the importance of decorative and regional stitches.
2. Write down the method of making squares in Sindhi stitch.
3. Write down the method of making the mirror work with a ring.
4. Tick ✓ in the on the correct statement.
 - a. Embroidery is an easy and interesting art.
 - b. In satin stitch the stitches are not taken closely
 - c. Sindhi stitch is not used on different fabrics and garments.
 - d. Mirror work is common in Sind and Baluchistan.
 - e. In phulkari stitch the whole fabric is filled with stitches.
5. Fill in the blanks with appropriate words:
 - a. Embroidery is an _____ and _____ art.
 - b. In satin stitch, the stitches are taken very _____ to one another and are straight or _____
 - c. _____ stitch is used in swat and other northern areas.
 - d. The foundation of sindhi stitch is a double row of _____
 - e. Mirror work is common in _____ and _____



Evaluation

Practical _____ satin stitch

Standard marks are given against each statement in the following table. Write down the marks obtained by the student in the related column.

Sr. No.	Characteristics	Standard Marks	Marks Obtained
1.	Selection of pattern is correct.	5	
2.	Correct method is used for beginning and ending of stitches.	5	
3.	stitches are taken close to each other and are made neatly.	5	
4.	Satin stitch looks neat and beautiful.	5	
	Total marks	20	

Grade

Signatures of the Teacher in charge _____

Dated _____



Evaluation

Practical _____ Phulkari or Swati stitch

Standard marks are given against each statement in the following table. Write down the marks obtained by the student in the related column.

Sr. No.	Characteristics	Standard Marks	Marks Obtained
1.	Selection of pattern is correct.	5	
2.	Selection of fabric is correct.	5	
3.	Proper method is used.	5	
4.	Proper thread is used.	5	
5.	Swati stitch looks neat and beautiful.	5	
	Total marks	25	

Grade

Signatures of the
Teacher in charge _____

Dated _____



Evaluation

Practical _____ Sindhi stitch

Standard marks are given against each statement in the following table. Write down the marks obtained by the student in the related column.

Sr. No.	Characteristics	Standard Marks	Marks Obtained
1.	Proper method is used.	5	
2.	Stitches are not loose. Filling is done properly.	5	
3.	Selection of fabric and thread is correct.	5	
4..	Stitches are taken neatly.	5	
	Total marks	20	

Grade

Signatures of the Teacher In charge _____

Dated _____



Evaluation

Practical _____ Mirror work

Standard marks are given against each statement in the following table. Write down the marks obtained by the student in the related column.

Sr. No.	Characteristics	Standard Marks	Marks Obtained
1.	Selection of pattern is according to the stitch.	5	
2.	Button hole stitch is made neatly on the ring.	5	
3.	Selection of fabric and thread is correct.	5	
4.	Correct method is used.	5	
5.	Mirrors are fixed neatly.	5	
6.	Mirror work looks neat and beautiful.	5	
	Total marks	30	

Grade

Signatures of the
Teacher In charge _____

Dated _____



5

MAKING DIFFERENT ARTICLES



After learning and having skill in sewing and embroidery, you will be able to make different articles, for example tea cosy cover, tray cover and doll ect. Not much time and effort is required for making these things and you can make them easily, By making these things you will not only save money but you can also add to your family income by selling these articles at the time of need

In this chapter the method of making the above mentioned articles is given. You can easily make these articles by following the methods given and with the help and guidance of your teacher.

Tea Cosy Cover

Tea cosy is a useful kitchen item. It is used to keep the tea hot for a longer time. Tea cosy is made by filling cotton or foam in it and then covering it with a cover so that the cotton or foam may not be stained. the method of making a simple teacosy cover is given on next page.



Selection of fabric for tea cosy cover

Tea cosy is used very frequently in our homes. It is, therefore, important to select a fast colour fabric for tea cosy cover which is durable and easily washable. The design and colour should be in harmony with the trolley set or the tray cover.

Method:

1. Measure the lower and upper rounded part of the tea cosy.

The draft of the cover will be made by taking half of the total measurements. For example, if the size of tea cosy is 40x32 cm.

The draft will be made in the following way.

AB= 16cms.

AC= 40cms.

Complete rectangle ABCD, shape it according to the draft.

(Fig 5.1A)

2. Mark 1cm. seam allowance at sides and top and 3cms. at bottom for hemming.



3. Fold the fabric lengthwise, pin the draft, trace it and cut on the marked lines.
4. Thread the machine and stitch on the seam line.

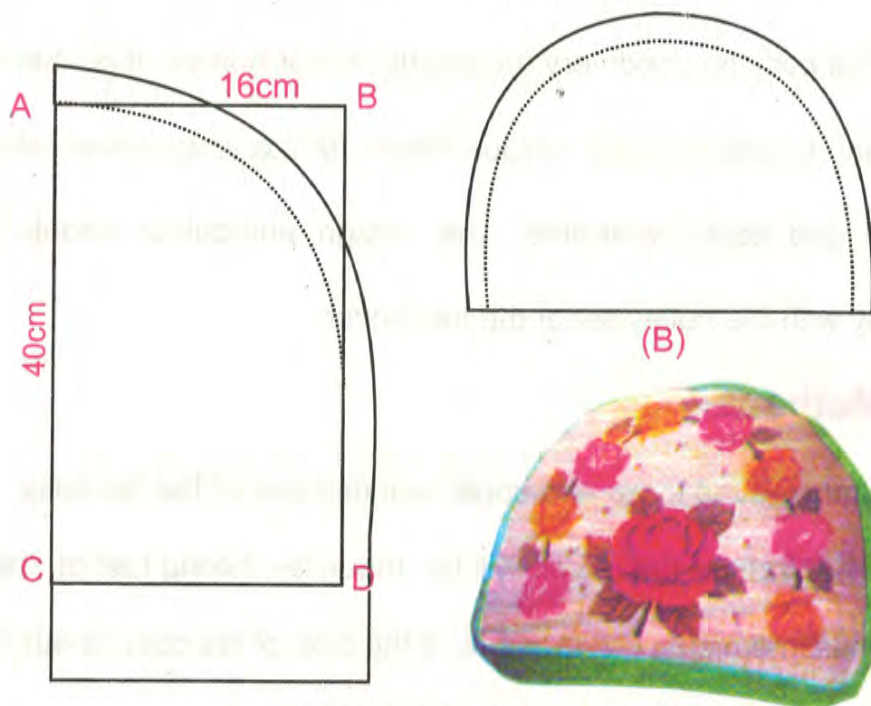

(Fig 5.1)

(C)

5. Make small tucks on the rounded portion for accurate roundness. (Fig 5.1B)
6. Turn lower portion and hem.
7. If you desire to have embroidery on it, then consult your teacher. But embroidery should be done before stitching.
8. The tea cosy cover is complete. (Fig 5.1C)

Tray cover

Tray cover is placed on tray and its use is very common in our homes.

Selection of fabric for tray cover

1. The fabric selected should be heavy, durable and colour fast,
2. Cotton fabric is usually used for making tray covers.



3. A fabric with a small print is suitable for informal use but for formal use it should be of plain fabric with embroidery on it.

Method

1. Measure your tray by taking its inner length and width.
2. During cutting add 2.5cms. hem allowance on all sides.
(Fig 5.2A)
3. Turn the fabric towards wrong side and hem it.

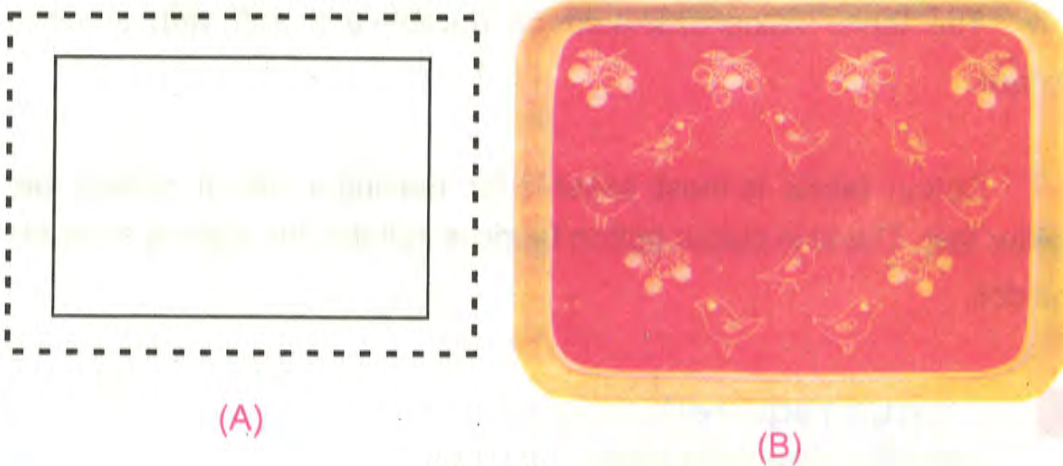

(Fig 5.2)

4. Press it after hemming.
5. If you desire to have embroidery on it, then take the help and guidance of your teacher in the selection of a suitable design. Embroider by using fast colour threads.



Making a Doll

Making different dolls and dressing them with clothes is a leisure time hobby of young girls. Girls start making dolls from an early age. Many girls gain perfection in it with the passage of time.

In this chapter a very easy and simple method of making a doll is given. After making this doll you will be able to make different dolls.

Selection of fabric

The fabric selected should be durable and soft with smooth texture.

Cotton fabric is most suitable for making a doll, It should be colour fast. The skin colour cotton fabric is suitable for making body of the doll,

Things required

Flannel, Latha or Khaddar.

Cotton wool or foam rubber dust (for filling).

Coloured threads (for making features of the doll)

Black or brown wool (for hair)

Carbon paper.

Card board.

Sewing box.



Method

1. Make pattern of the doll. In diagram 5.3 a very easy and simple graph of a doll is given. You can increase or decrease this size for making different dolls.

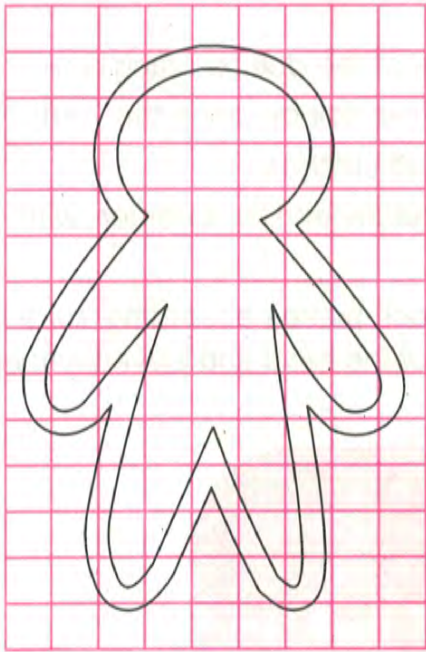

(A)

(Fig 5.3)

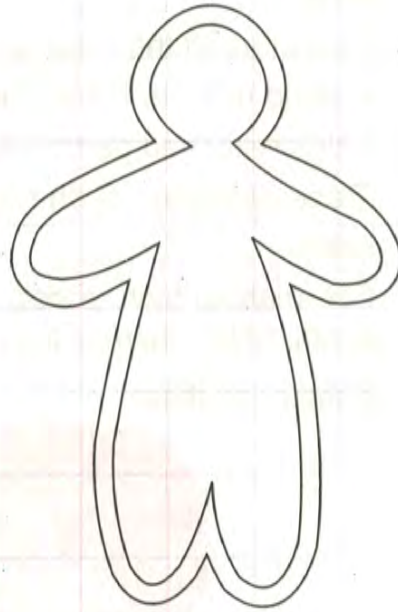

(B)

2. Trace the pattern on cardboard and cut it.
3. Fold fabric towards wrong side.
4. Place carbon paper on the fabric for transferring the pattern and trace it from all sides with a pencil,



5. Cut the fabric on these lines, join front and back side of the doll.
6. Thread the machine and stitch from the outer side of the foot to the middle of the foot, leaving a little portion unstitched.
7. Make small tucks on the rounded portions.
8. Turn doll to the right side, keep it straight on a table and start filling.
9. First of all fill the head and arms of the doll by using a pencil or a knitting needle. Fill the body of the doll by using this method.
10. Sew unstitched portion with small stitches.
11. Trace features of the doll carefully and embroider with satin stitch.
12. For making hair of doll, cut wool pieces according to desired length. Stitch them at the middle of the head and leave them either open or tie them.



13. After completing the doll, dress it by following your teacher's instructions.



Questions

1. What type of fabric should be selected for making a tea cosy cover? Write down the method of making a tea cosy cover.
What steps should be followed while making a tray-cover? Write down the method of making a tray cover?
3. What type of fabric should be used for making a doll, Write down the method of making a doll.
4. Fill in the blanks with appropriate words:
 - a. The fabric selected for tea cosy cover should be _____
 - b. Make small _____ on rounded parts.
 - c. _____ fabric is suitable for tray cover.
 - d. Measure the _____ and _____ of the tray.
 - e. Fill the doll with _____ or foam-rubber dust.
5. Tick ✓ in the on the correct statement:
 - a. Select a durable fabric for making a tea cosy cover.
 - b. Thick cotton fabric should not be used for tray cover.
 - c. Light coloured fabric should be used for making body of the doll.
 - d. Carbon paper should not be used for tracing the pattern.
 - e. The arms and legs of the doll should be filled properly.



Evaluation

Practical _____ Tea Cosy Cover

Standard marks are given against each statement in the following table. Write down the marks obtained by the student in the related column.

Sr. No.	Characteristics	Standard Marks	Marks Obtained
1.	Size of tea cosy is correct.	5.	
2.	The roundness of tea cosy is correct.	5.	
3.	Stitching has been done correctly.	5.	
4.	The lower portion of tea cosy cover is hemmed properly.	5.	
5.	Tea cosy cover is neat and beautiful.	5.	
	Total marks	25	

Grade

Signatures of the Teacher in charge _____

Dated _____



Evaluation

Practical _____ Tray Cover

Standard marks are given against each statement in the following table. Write down the marks obtained by the student in the related column.

Sr. No.	Characteristics	Standard Marks	Marks Obtained
1.	Size of tray cover is correct.	5	
2.	Edges of tray cover are uniformly turned.	5	
3.	The corners are made neatly.	5	
4.	Hemming has been neatly and firmly done.	5	
5	Tray cover looks neat and beautiful.	5	
	Total marks	25	

Grade

Signatures of the Teacher in charge _____

Dated _____



Evaluation

Practical _____ Making a doll

Standard marks are given against each statement in the following table. Write down the marks obtained by the student in the related column.

Sr. No.	Characteristics	Standard Marks	Marks Obtained
1.	Draft of doll has been made properly.	5	
2.	Cutting and stitching has been properly done.	5	
3.	Filling is even and smooth.	5	
4.	Features of doll and hair are correctly made.	5	
5	The doll looks neat and beautiful.	5	
	Total marks	25	

Grade

Signatures of the Teacher in charge _____

Dated _____



The image is a composite of two paintings. The top painting shows a two-story house with a white facade, a red-tiled roof, and a prominent gable. A large tree stands to the right of the house. The bottom painting shows an interior living space with a low wooden coffee table, several patterned cushions on the floor, and a red sofa in the background. A central yellow box with a white border contains the text.

**EFFECTIVE
LIVING
IN THE FAMILY**



1 IMPORTANCE OF EDUCATION



The word education means training of mind and character and be acquainted about morals and things. Education is of great importance for every one. During the whole life a human being learns. Education is a gift of God which has been given to man. It is through learning that man recognizes god and develops certain capabilities which help him to recognize his weaknesses. An educated person is able to overcome his weaknesses and develops good qualities in himself.

Our religion Islam has given a great importance to education. For example, in the first revelation God ordered our Prophet (PBUH)

إِقْرَأْ بِاسْمِ رَبِّكَ الَّذِي خَلَقَ ۝ خَلَقَ الْإِنْسَانَ مِنْ عَلَقٍ ۝ اقْرَأْ وَرَبُّكَ الْأَكْرَمُ ۝
الَّذِي عَلَّمَ بِالْقَلَمِ ۝ عَلَّمَ الْإِنْسَانَ مَا لَمْ يَعْلَمْ ۝

Translation: Read in the name of thy Lord. Who creates, creates, man from a clot. Read and thy Lord is most generous. Who taught by the pen. Taught man what he knows not.

The Holy Prophet (PBUH) said that

- A. "The acquisition of knowledge is duty incumbent on every muslim either males or females from cradle to grave.
- B. "Seek knowledge even if you have to go to China".

The Holy Quran also emphasizes the importance and superiority



of education in many places because education has no boundaries. Education is a wealth which cannot be stolen. The more you use it, the more it grows.

Advantages of education

There are many advantages of education. Such as;

1. It helps in the mental and moral development of an individual.
2. It develops sense of unity and discipline.
3. It helps an individual to understand his environment in a better manner.
4. It develops in an individual the ability to understand himself and to evaluate his personality.
5. It develops confidence and dedication in an individual. It develops in an individual the ability to serve in different fields of life, for example agriculture, industry, business, banking, engineering, medicine etc.
6. It develops in an individual the capabilities and qualities to fulfil the present demands and to prepare himself for future.
7. It helps in the development of a country. It improves the mental perception of young people and guides their behavior.
8. It strengthens the character of a person. Therefore, educated members of the family are useful citizens of a society and the country.



Responsibilities of an Educated Girl

An educated girl can prove to be a useful member of the family and the society. She can improve the living conditions of her family. A society is made up of families and a family is made up of individuals. A society having more educated families is considered to be an ideal society. Such a society is given due respect because of its performance. Being an educated member of the family you have certain responsibilities, such as;

1. To motivate your younger brothers and sisters to get education by telling them the advantages of education.
2. To teach uneducated people how to read and write.
3. To follow good examples and to set good examples for others.
4. To check and correct the bad habits of others by setting good examples.
5. To help the individuals of the society to become useful and educated members by improving their habits.



Thus, a nation which consists of many educated people can make progress in every field of life. A nation with many educated people is not dependant on others for the fulfilment of its needs. Its people can lead their lives in their own independent way.



Questions

1. What is the importance of education? Write a note on it.
2. Write down the advantages of education.
3. Write down the responsibilities of an educated girl.

4. Tick ✓ in the on correct statement.

- a. Education helps in the moral and mental development of an individual.
- b. A society having more educated families is considered to be an ideal society.
- c. There are on advantages of education.
- d. Education strengthens the character of a person.
- e. It is not compulsory to teach the uneducated people.

5. Fill in the blanks with appropriate words.

- a. Education means being _____ or _____ something.
- b. Education is a gift of _____
- c. _____ has no limits. It is a _____ which cannot be stolen.
- d. Education develops sense of _____ and _____
- e. A _____ having more educated families is considered to be an _____ society.



2 HOUSEHOLD WORK



Sharing Responsibilities:

A home is just like a dominion, In a dominion an administrator is helped by his advisors. In the same way members of the family are expected to help in the household tasks for smooth running of the home. Household responsibilities are divided into many tasks, for example, cooking meals, washing dishes, cleaning the house, washing and ironing of clothes, sewing and care of clothes etc. An individual is unable to perform all these duties effectively, therefore, it is the prime duty of all the members of the family to participate in the household tasks, for example, you can help your mother in cutting the vegetables, kneading flour, washing dishes, dusting, washing clothes and ironing etc.

By helping your mother, you will not only consider yourself as responsible member of the family, but you will also gain confidence, develop the habit of doing work and acquire skill in doing different tasks, By doing so time will be saved and the work will become less tiring. When all the family members participate in the household work everyone will develop a sense of responsibility and no one will be overburdened with work.



Time and Activity Plan

It is necessary to plan different household activities. By doing so the work will be done easily and in short time. Following points should be kept in mind while planning a time and activity plan.

1. Important tasks should be given prime importance.
2. Heavy tasks should be done in the morning.
3. Fix the time for every task and try to finish the task in the given time.
4. The plan should be flexible.
5. The plan should be followed strictly.

A sample of the time and activity plan is given on the next page. Keeping the salient features in view, make a time and activity plan for yourself.

Care of Clothes

It is necessary to take care of clothes for their best upkeep and for prolonging its life for maximum use. Good care will improve their appearance and will add to their life as well. The clothes will have new look when worn and will give a longer service. Clothes require daily, weekly and yearly (seasonal) care.

Daily Care of Clothes

The steps to be followed for daily care of clothes. are



Time and activity plan

No.	Activities	Time
	Getting up, cleaning and washing and offering prayer.	5.30 a.m-6.30 a.m
	Getting ready for school	6.30 a.m-7.00 a.m
	Taking breakfast.	7.30 a.m-8.00 a.m
	School time	8.30 a.m-1.30 p.m
	Changing uniform and taking lunch.	1.30 p.m-2.30 p.m
	Offering Zohar prayer.	2.30 p.m-3.00 p.m
	Taking rest and doing home work.	3.00 p.m-3.00 p.m
	Offering Asar prayer.	5.30 p.m-4.40 p.m
	Making and serving evening tea.	5.40 p.m-6.15 p.m
	Helping the mother, washing the uniform etc.	6.15 p.m-7.15 p.m
	Offering Prayer.	7.15 p.m-7.30 p.m
	Watching T.V.	7.30 p.m-9.00 p.m
	Dinner time.	9.00 p.m-9.30 p.m
	Washing dishes.	9.30 p.m-10.00 p.m
	Ironing school uniform	10.00 p.m-10.15 p.m
	Offering prayer.	10.15 p.m-10.45 p.m
	Bedtime (rest)	10.45 p.m-5.30 a.m
	Total time	One day



1. Airing the clothes

After changing the clothes, hang them on a hanger or on a rope for sometime to let the air circulate. Underarm portions of the shirt may be washed under tap water, if and dried in the air.

Shoes should also be kept in the air for sometime so that the smell of the sweat is gone.

2. Keeping the clothes at their proper places

Proper places should be allotted for keeping the clothes, for example, wardrobe, boxes etc. Hang the clothes on the hangers in the wardrobe or keep them in the box or put them in the shelves of the wardrobe.

Clean, and brush the shoes and put them with care at their appropriate place. Gloves, sweaters, handkerchiefs, socks and undergarments should also be kept with care at their appropriate places.



3. Mending and repairing

Clothes should be checked daily for minor repairs and mending to prevent them from further tearing.



4. Washing

It is not necessary to wash shalwars, shirts, dopattas etc. daily but all the undergarments like, vests, under wears, socks etc. must be washed or changed daily because they absorb sweat, dirt and smell directly from the body. Every individual should have at least two pairs of these garments.

Undergarments and hosiery articles should be soaked in luke warm suds for 5 to 7 minutes. Rub them gently, rinse, wring and dry in the sun.

5. Ironing

After airing or washing and drying the garments of daily wear iron them, fold them and hang them on hangers, so that they are readily available when needed.

The temperature of iron should be set according to the nature of fibre.

Weekly Care of Clothes

A weekly holiday is the most suitable day for weekly care of clothes. Following tasks are included in the weekly care of clothes.

1. Mending and Repairing.
2. Washing of clothes.
3. Ironing of clothes.
4. Putting clothes at their proper places.



1. Mending and repairing

It is necessary to mend and repair garments before washing. This prevents further tearing and ravelling. All loose buttons and snaps should be firmly fixed before washing. Replace the broken buttons with new ones.

2. Washing of clothes

Washing of clothes include following steps:

- a) Collecting and sorting.
- b) Removing stains.
- c) Soaking.
- d) Washing
- e) Rinsing
- f) Wringing
- g) Drying

A Collecting and sorting

There should be a special place in the home, where all the family members should put their soiled clothes. This practice will save time and energy.

For this purpose a family might utilize a cupboard, a trunk, a cane basket or may have a laundry bag made of cloth. This bag can be hung



behind the bathroom door or store room door. All the family members should put their soiled garments in it.

When all the garments for washing have been collected, they should be sorted according to the fibre and colour combination. Make a separate pile for each of the following.

- (a) White and light coloured cotton and linen.
- (b) Dark coloured cotton and linen.
- (c) White and coloured silk and synthetics (nylon, dacron etc.)
- (d) Woollens and semi - woollens.

Some garments require special care and handling during washing. Garments, which lose colour, socks, gloves, sweaters etc. Undergarments, for instance, vests and under wears should be washed separately.

B Removing stains

The stains should be removed while still fresh with a suitable solvent. Remove stain at first with the simplest method, for instance, wash with warm soapy water and put it in open air to dry. Use solvent only on stained portion of the cloth. It is better to use a weak solvent than a strong solvent. Before using any stain removal or solvent it should always be tested on hidden part of the garment.



C. Soaking

Close buttons and zips of the shirts. Open cuffs and collars. The heavily soiled clothes should be soaked in hot water and soap solution for 1 to 1 ½ hour. Less soiled clothes should be soaked in warm water and soap solution for 10-15 minutes. Never soak silk, synthetics and woollens.

D Washing

Wash clothes according to the type of fibre either in hot or cold water solution and in weak or strong solution of soap. If clothes are soaked, drain off dirty water and wash in fresh suds. Silk require luke warm water. Heavily soiled white cotton articles e.g. shalwars, bed sheets and pillow covers should be boiled in soap solution. Normal tap water is suitable for ordinary cotton garments.

E Rinsing

Rinse the clothes under tap water twice or thrice to remove the suds. Woollen and silken clothes should be rinsed by using luke warm water.

F Wringing

1. Cotton garments should be wrung hard to remove water.
2. Silken clothes should be rolled in a towel to remove excess moisture.
3. Woollen clothes should never be wrung or twisted. They should be squeezed very gently between two hands and then rolled in towels to absorb the remaining moisture.



F Drying

Clothes should be dried in back courtyard, verandah or lawn. White clothes except woollens should be dried in sun and coloured clothes in the shade or indoors. The garments which may lose their shape if hung, should be laid down straight on an absorbent material to retain their shape. Garments made from synthetic fiber, for example, wash 'n' wear shirts and trousers etc. should be hung on hangers to drip dry.

Garments should never be hung on wire or on jute rope because wire will leave rust spots and jute rope will stain the garments especially if they are white. A nylon rope or a plastic coated wire should be used for drying of clothes.

3 Ironing

Damp clothes are pressed easily. It is better to dampen the garments or may be taken off the drying string while they are still damp. if the clothes are completely dry, then dampen the cloth by dipping the right hand in the bowl of water and shaking it on the garment. When the garment is damp, roll the garment and leave it for some time to allow moisture to distribute evenly.

Ironing is done in two ways according to the type of fabric.

1. The cloth is ironed by lifting and pressing the iron on the cloth in



strokes till wrinkles are removed. This method is called pressing and is used mostly for woollen garments.

2. The cloth is laid straight on the ironing board and the hot iron is moved from right to left till all the wrinkles are removed. Ironing should be done from one edge to the other e.g. while ironing a



shirt always start from lower portion to the upper portion. Further more, the back side of the garment should be ironed first.

Types of Irons

The following four types of irons are available in the market.

1. **Coal iron**

This type of iron is usually made of iron. In certain cases the base



plate is made of copper or brass. The cavity is filled with smouldering coals and the lid is clamped tightly. The iron is then left for some time to get heated. Vents at the side of the iron allow enough air to circulate inside the iron to prevent the coals from extinguishing.

Since, this is the most ordinary form of iron and has no temperature control, its use is recommended mostly for cotton and linen garments. It can be used for woollen clothes only when it has sufficiently cooled down.



2. Electric iron

This type of iron is operated electrically and is suitable for almost all types of fabrics. It has a small plate or ring under or over its handle which is known as the 'dial' with which the heat can be controlled. By rotating this dial to the indicator marked, the temperature desired for the fabric to be ironed can be adjusted. In some cases the dial is marked in degrees, for example, 150° to 450° for appropriate control of dial.



In some irons the name of the fiber is written on the dial, for example, linen, cotton rayon and woollens etc. This is the most common and the best type of iron used in homes.



3. Steam iron

The steam iron works on the same principle as the thermostat controlled electric iron with the exception that it has a special hole in front of the handle which is filled with water. The heated water is converted into steam. This steam is transferred to the fabric through

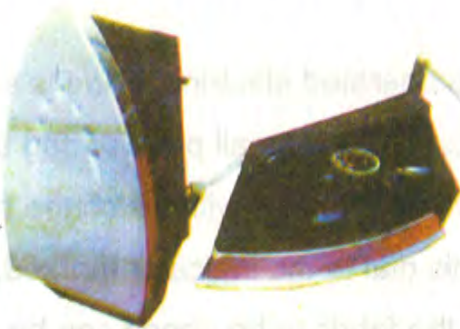

tiny holes at the base of the iron. This type of iron dampens the cloth during ironing or pressing which makes the work easy and saves time and energy.



4. Gas iron

It is a new invention. It is heated by using the sui-gas . Gas iron resembles coal iron in its shape. The only difference is that it has an inlet for gas and a nozel is attached at the back of the lid. This nozel is attached with the gas connection with a strong rubber pipe. When this iron is used the gas connection is put at on', the lid is lifted and the burner is lit. The lid is then closed and the iron is allowed to get hot. The flame can be adjusted by moving the knob or regulator fixed with the connection.



Precautions

Following precautionary measures may be taken while using the gas iron:

1. Fix the connection firmly with nozel to avoid the leakage of gas.
2. Keep the flame at medium in the beginning.
3. Flame is not visible, therefore use the regulator for adjustment of heat. Some regulators have numbers 1-5 written on it. Keep the regulator at no. 3 for medium heat and no. 5 for hot.
4. Turn off the main connection when it is not in use.



Ironing board

In most of our homes, table or top of a large box is used for ironing. However, a proper ironing board makes ironing much more easy and comfortable. The proper ironing board is slightly less than 1 meter high, sixty centimeters wide and 1.5 meter in length. The left edge of the board is tapered like > shape. Such boards are readily available in the market. In some ironing boards, there are cupboard or shelves for storing clothes or a stool is attached for sitting while ironing.



Laundering different types of fabrics

For better care and washing of clothes, it is necessary to be familiar with the characteristics of different fibres, so that these can be washed easily. Soap and water have different effects on different fibres which can damage the cloth and the clothes may lose their luster and strength.



Cotton fabrics

1. Before washing, sort out coloured cotton from white ones and soak them in separate containers.
2. Coloured fabrics which lose colour should not be soaked. These should be washed immediately. Some coloured fabrics lose colour during washing. Such clothes should be washed by adding one teaspoon of ground alum or one tablespoon of salt to the soap sud.
3. Ordinary tap water should be used for washing all cotton garments. White but heavily soiled garments should be soaked in hot soapy solution, then rubbed and washed in suds of soap and water.
4. Stubborn spots on collar and cuffs need extra rubbing and stroking between the hands. In case of using a soap cake instead of a detergent, the soiled parts should be rubbed thoroughly with hands or with a brush.
5. After rubbing, soak garments in suds, then rinse thoroughly.
6. If there are suds left, then rub another garment in it instead of throwing it away.
7. Rinse the clothes thoroughly in clean water. The first rinse should be in warm water because hot water removes soap easily. The last rinse should be in luke warm water. Wring the clothes to remove excess water.



8. If you feel that the clothes are not satisfactorily clean, then give them a second wash. Rinse them again and be sure that all the soap has been removed, because white clothes will become pale when ironed and coloured clothes will have spots when ironed, The soap will also weaken the fabric.
9. After washing, bluing and bleaching of clothes is done. Bleach only white cotton and linen garments. Never bleach coloured fabrics, silk and wool. Use a commercial bleach e.g. "leeko" or "Tinopal" and carefully follow the instructions written on the packet. After using any bleach always rinse thoroughly, because chemicals are harmful for fibers. When white clothes are washed and rinsed properly then require bluing. Too much bluing will affect the appearance of garment, therefore always test it on a corner of the cloth before immersing it in bluing solution.
10. Starch is used to give cotton or linen garments a fresh and crisp look, Commercially made starch is more expensive. Starch can be made at home with flour (maida) or ararot. Always use a cold solution of starch for coloured garments.
11. Iron all starched garments, while they are damp. Hang them on hangers or fold them and keep them in a cupboard.



Woollen fabrics

1. The washing of woollen clothes require special care. Such fabrics are never soaked before washing. only highly soiled garments should be soaked. Use tap water and a generous amount of mild suds for all types of woollen garments. Never use hot water.
2. Squeeze fabric in suds, but do not rub.
3. When the garment is thoroughly clean, squeeze out suds. Rinse thrice or more in water.
4. Before washing a sweater, trace the outline of the sweater on a brown or plain paper. (Fig. 1)
5. Wash the sweater with right side out Cup the whole sweater in your hands before lifting it out of water, (Fig.2)
Careless lifting can stretch it out of shape.
6. Rinse by squeezing the sweater between the hands but do not twist.
7. Roll the sweater in a towel. (Fig.3)
8. Place the sweater on the traced outline. (Fig. 4)
9. Do not dry sweater in the sun for too long time.
10. When damp, remove from pattern and let it dry.



11. Some sweaters have natural fur on their surface. Brush them lightly to raise the fur.



Silken fabrics

Use lukewarm water and mild soap for washing silken garments. Squeeze suds through garments but do not rub. Wash white garments first, then pale ones before dark ones. When suds become dirty, squeeze out the garment, rinse thoroughly by using lukewarm water for all rinses. Hang on hangers to dry. Press when still damp. Do not use very hot iron. It is better to set the dial for silk before ironing.



Questions

1. Why is it important to work together. Which points should be kept in mind while planning a time and activity plan?
2. Which tasks are included in the weekly care of clothes?
3. Write down different steps included in the washing of clothes?
4. How will you wash cotton clothes?
5. Which points should be kept in mind while washing a woollen sweater?
6. Tick ✓ in the on the correct statement:
 - a. A home is like a dominion.
 - b. Heavy tasks should be done in the evening.
 - c. Clothes require daily, weekly and seasonal care.
 - d. It is not necessary to mend and repair the clothes before washing.
 - e. Heavily soiled clothes should be soaked in hot water and soap solution.
7. Fill in the blanks with appropriate words:
 - a. Household responsibilities are divided into many _____
 - b. All the family members should _____ in the household tasks.
 - c. The time plan should be _____
 - d. Clothes should always be dried in _____
 - e. Sort out _____ clothes from _____ ones.





3

CLEANING THE HOUSE

A house whether small or large is a place where we spend most of our time, therefore, it should be neat and clean and comfortable. Cleanliness plays an important role in making a house beautiful. A neat, clean, and comfortable house provides happiness and pleasant feelings to the family.

There are hundreds of things present in every home. Some of these things are used very frequently and some occasionally. All things require regular cleaning and upkeep because it is not possible to clean every thing thoroughly each day. The process of cleaning a home can be divided into three kinds.

Daily Cleaning.

Weekly Cleaning.

Seasonal or Yearly Cleaning.

Daily cleaning

Daily cleaning of the house includes dusting of doors, windows and furniture sweeping and moping of floors, making the beds and putting all things in order in all the rooms.

Method

Daily cleaning of the house should be planned in such a way that time and energy are saved, for example:

1. Open all the doors and windows of the rooms early in the morning to let the fresh air enter and circulate in the rooms.
2. Use a soft broom (phool or deb) to sweep the cemented or chipped floors.
3. Clean the carpets or darries with a carpet brush. A bamboo broom can also be used for cleaning of carpets.
4. Sweep the corners, edges of the floor and floor strips while sweeping the floors.
5. Remove cobwebs from the walls and corners which are in easy reach.
6. Dust the furniture, doors, windows and other things after sweeping.
7. Use a soft and absorbent duster for dusting and dampen it slightly to absorb the dust.
8. Always dust larger pieces of furniture first and then smaller ones.
9. Take off table covers and bed sheets, shake and spread them.
10. After dusting, mop the floors by using a thick, soft and absorbent cloth
11. Use a clean cloth for mopping.
12. The mop should be washed and dipped in phenyl water every time while mopping.
13. Replace all articles
14. Arrange fresh flowers (if available) in every room.
15. All rugs and dusters etc. should be immediately washed after use.
16. Put back brooms, brushes etc. in their proper places.
17. Wash the mop. spread it in the sun and then keep it back in its proper place.



Weekly cleaning

Weekly cleaning includes washing of clothes, cleaning and dusting of walls and ceilings, polishing of decoration pieces, mending and repairing of clothes etc. All these tasks are usually done on holidays when all the family members are at home.

Method

1. Remove all pillows, cushions, foot mats, mattresses etc. from the room and put them in the sun.
2. Push all furniture, for example beds, chairs, sofas, tables etc in the center of the room and cover them with an old bed sheet or with old newspapers.
3. Clean the walls with a brush, Remove cobwebs especially from the corners by using a tall bamboo with a brush.
4. Tie a soft cloth on the tall bamboo and clean the ceilings and walls with it.
5. Clean pictures, glasses, mirrors and windows by using the following method:
 - (i) Make a solution of one glass of water + $\frac{1}{2}$ tablespoon of washing soda.
 - (ii) Dip soft cotton duster in it, squeeze it and clean glasses with it.
 - (iii) Wipe with a dry cotton duster or with damp news paper
6. Sweep and mop floors and brush the carpet.
7. Fold all sheets and papers.
8. Replace all the furniture.
9. Bring in all the articles and put them back in their proper places.
10. Change bed sheets, bed covers, table cover and pillow covers etc. and put them aside for washing.



11. Clean the book shelves and wall hangings with a duster or a brush.
12. Clean and dust the bulbs, lightening shades, switches etc.
13. Clean and polish the articles and decoration pieces made of copper and brass at least once a week.
To polish and clean these metals, the cheapest thing is lemon and salt. Use following method for polishing.
 - (i) Dust the article with a cloth.
 - (ii) Apply lemon juice and salt on metal and leave it for sometime.
 - (iii) Scrub and wash it by using vim. Dry it with a soft cotton cloth.
14. Rearrange the clothes in the cupboard.
15. Shoes should also be cleaned, polished and arranged properly in the shelves.
16. Clean and rearrange the kitchen cabinets.
17. Remove water stains from bathroom sinks and flush by using hydrochloric acid.

Seasonal cleaning

In our country, the season usually changes after every three months. Our needs also change according to the demands of the season, for example, clothing and bedding are changed. In addition, the house also needs to be whitewashed, doors and windows needs to be painted and furniture polished.

1. White-washing or painting

Repairs, whitewashing and painting must be done to keep the house in good shape.



The following measures should be taken before white washing or painting the house.

1. Spread old newspapers on floors close to the walls. Keep small stones on them to prevent them from flying.
2. Spread newspapers on the window sills too.
3. Cover the doors and windows with old bed sheets.
4. Remove all these papers and sheets carefully after the work has been finished.
5. If some spots remain visible, remove them by rubbing with a wet cloth.
6. In order to remove any stains of paint, apply some turpentine oil on them with a duster. The oil will soften the stains and these will be removed easily by rubbing slightly.

2. Cleaning of furniture

The seasonal cleaning of furniture is very essential. Spots from hot cup of tea and careless handling may stain wooden furniture. To remove these stains, polishing of furniture is necessary. By using following method you can make furniture polish at home.

1. Mix together equal amounts of turpentine oil, linseed oil, spirit and vinegar. Put them in a bottle and shake thoroughly.
2. Dust the furniture with a soft cloth.
3. Apply this polish on the furniture with a pad made from clean rags.
4. Rub with a soft cloth till the furniture begins to shine.



3. Cleaning of copper and brass articles

1. Spread newspaper on the floor and put the articles to be cleaned on it.
2. Clean with a duster or remove the dust with an old tooth brush.
3. Apply metal polish on it with a soft cotton cloth. Leave it for Sometime.
4. Rub with a duster till it begins to shine.

General hints for keeping the house clean

It is not only the responsibility of a single person of the family to keep the house clean. All the family members should share this work jointly. A clean and well arranged house is liked by all. Therefore, it is necessary to give special attention to the cleanliness of the house. For example:

1. There should be a place for keeping the things.
2. Every member of the family should learn the habit of putting back every thing in its place after use, so that he or she can get it easily at the time of need and the other members of the family will not have to search for that particular thing when needed.
3. When the children return back from school they should put their shoes, clothes, school bag, lunch box etc. at their proper places.
4. There should be a proper arrangement for the disposal of refuse in the house and outside the house. There should be a dust bin or a plastic basket placed in or near the kitchen to throw the peels of vegetables and fruits and other kitchen refuse. It should have a cover so that the flies do not sit on the refuse. The dust bin basket should be washed daily and dried in the sun.
5. Also place waste paper baskets in all the rooms for throwing papers, hair etc. In this way you can keep the rooms clean.
6. Teach the younger children to keep the surroundings clean. In this way they will develop the habit of cleanliness.



Questions

1. Why it is important to keep the house clean? Write down the method used for daily cleaning of the house.
2. Write down in detail weekly cleaning of the house?
3. Which activities are included in the seasonal cleaning of a house?
4. Write down the method of cleaning copper and brass articles.
5. Write down the general hints for keeping the house clean.
6. Fill in the blanks with appropriate words:
 - a. A neat and clean home provides _____ and _____ feelings to the family.
 - b. _____ plays an important role in making a home look beautiful.
 - c. Always use a _____ cloth for dusting.
 - d. Arrange _____ flowers (if available) in every room.
 - e. The _____ cleaning of furniture is very essential.
7. Tick ✓ in the on correct statement:
 - a. Cleanliness plays an important role in making a house look beautiful.
 - b. Mop the floors before dusting.
 - c. After cleaning replace all the things at their proper places.
 - d. It is not necessary to clean the metal articles once in a week.
 - e. Measures should be taken before white-washing or painting the house.

