

A New Antenna Model

*Think you know how an antenna radiates a signal?
This article may give you some new insight.*

This article is intended to provide a useful interpretive model for understanding how antennas operate. While many amateurs are likely to have good practical knowledge of antennas, how to construct them, how to match to them, the use of baluns, wave polarization and so on, when it comes to having a picture of how and why an antenna generates a wave that can be received far away or why the feed point has a particular impedance value, things may not be so clear. A precise closed form alternative to the equations presently used for antenna analysis won't be provided here. Instead of that, this article is intended to give a reasonably complete and accurate intuitive way to view simple antennas that most amateurs commonly use.

Antennas have been important for more than a century and the analytical theory to describe them, derived from electromagnetic theory by James Clerk Maxwell, Heaviside and others, has been developed for a long time as well. This theory may leave most of us without an intuitive understanding — without a useful mental picture. To help change this it is useful to first look at what analytical theory, measurement and computer modeling does tell us. We can then go on to form a new understanding that may be easier to picture.

Antennas such as dipoles are usually analyzed by applying Maxwell's equations to the current within infinitesimal segments of a longer conductor and then computing the resulting fields and impedances. A common approach is to start with a description of the fields produced by current in an infinitesimal section of a dipole, as shown in Figure 1. A dipole can be modeled as a collection of a very large number of these elements laid end to end. The currents in each of the elements are assumed to follow something close to a sinusoidal distribution along the length

of the dipole, and to be opposite in the two dipole halves. At the dipole tips, where the element ends, the current is assumed to be zero. An interesting consequence of solving analytically in this way is that both the radiation pattern and the feed point impedance are obtained.

Solutions of the traditional field theory are much more approachable these days because of the availability of the numerical electromagnetics code (*NEC*) modeling tool and its derivatives. These computer programs can quickly solve the equations and display both antenna impedance and pattern. For the discussion that follows, let's look at what classic Maxwellian field theory — with the help of modern computer tools — tells us about a thin, perfectly conducting one meter long center-fed dipole. This is an antenna that, if we had thin, perfectly conducting material from which to make it, would be a fine dipole for 2 meters.

Antenna Pattern

Figure 2 displays the far field pattern of a one meter long center-fed dipole as calculated by *4NEC2*.¹ For these displays,

¹Notes appear on page 18.

the dipole may be imagined as located at the center of the plot with its elements running vertically, above and below center. This analysis is of a vertically polarized dipole far from any ground, conductors, dielectrics and anything else, so the antenna is said to be located in "free space."

Plots for 150 MHz, 300 MHz and 570 MHz are shown. These three plots correspond to different wave sizes. That is, at 150 MHz this dipole is a conventional center fed half-wave dipole, at 300 MHz it is a full-wave dipole and at 570 MHz the length is about 1.9 wavelengths, all of these measured from tip to tip.

Note particularly that to an observer located to the right or left of center, the half wave and the full wave dipoles each have a maximum. This is the broadside direction of the antenna. You can see about 2 and 4 dB indicated gain for the half and full wavelength dipoles, respectively. If the observer were located at the top or bottom of the plot, it would be found that there was no signal at all coming off the side, that is, from the element ends.

This is what most of us expect from a dipole. Note what happens, however, when the antenna length is about 1.9 wavelengths.

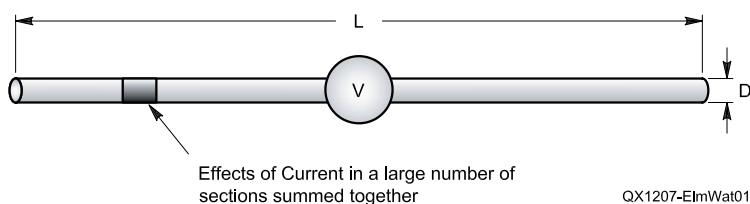

Figure 1 — The individual effects of currents in a very large number of small elements laid end-end can be summed to model the operation of a center fed dipole of length L . These elements are presumed to be perfectly conducting and very much thinner than their length, $D \ll L$.

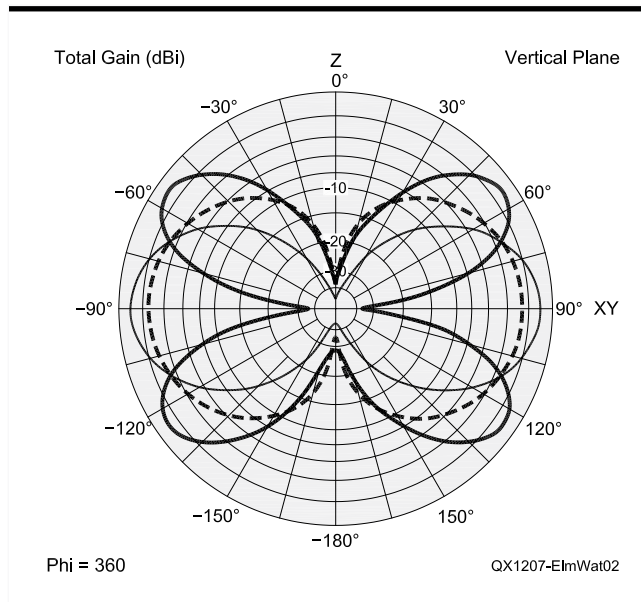

Figure 2 — Far field radiation pattern of a half-wave (dashed line) and full wave (thin line) and 1.9 wave (bold line) center-fed dipoles. Notice the broadside nulls at 1.9 wavelengths.

Instead of a broadside maximum with nulls off the sides, a dipole of this electrical length produces two peaks, around 35° above and below the broadside direction and a null off the ends. Perhaps surprisingly, at the same time there is also a null in the broadside direction where the other dipole lengths gave a maximum.

Figure 3 shows the patterns from the same center-fed dipole again placed vertically at the center in open space with no nearby ground. But in this case the two plots show the patterns when the frequency has been increased to around 3000 MHz, where the overall lengths are 10 and 10.5 wavelengths. By keeping the dipole physical size the same, but changing the frequency (wavelength) we are examining a dipole of varying *wavesize*. The plots show what happens to the radiation pattern as the dipole gets considerably longer than the common half-wave variety many of us use at our stations. The direction of maximum gain, the main lobe, is split and points more along the axis in the direction of the ends. Just as we saw in Figure 2 with shorter dipoles, as the antenna length is increased, there is a continuous alternation of peaks and nulls in the broadside direction. If you think about this, it may seem surprising that a dipole can have any broadside nulls at all.

Antenna Feed Point

Now let's turn our attention to what we measure at the center feed point of this dipole and what happens when we change frequency. Figure 4A plots the reactance against the *logarithm* of the resistance as frequency and with it, wavesize, are increased. This

is the form of the plot shown in the *ARRL Antenna Book*. This plot doesn't explicitly show frequency or length but the various resonances associated with a dipole as wave size is varied are easy to spot. A very short dipole starts with a very small resistive component but high capacitive reactance. This is a point down on the lower left of the plot and is the sort of impedance that a 160 m mobile whip might present to a loading coil or tuner. As the length approaches a half wave, the reactance drops to zero and the antenna reaches its first resonance and shows a value for the logarithm of resistance of about 1.86. This corresponds to $10^{1.86}$ or about 72 Ω. This is the common operating length and impedance for many dipoles used in Amateur Radio. As the length increases further, the reactance becomes inductive and the resistance increases to a much higher value. When the antenna reaches one full wavelength, at about 300 MHz in this example, the reactance again drops to zero and the feed-point resistance reaches its maximum of around 8 kΩ at this first "high impedance resonance."

As the length continues to increase, a sequence of low impedance resonance followed by high impedance resonance

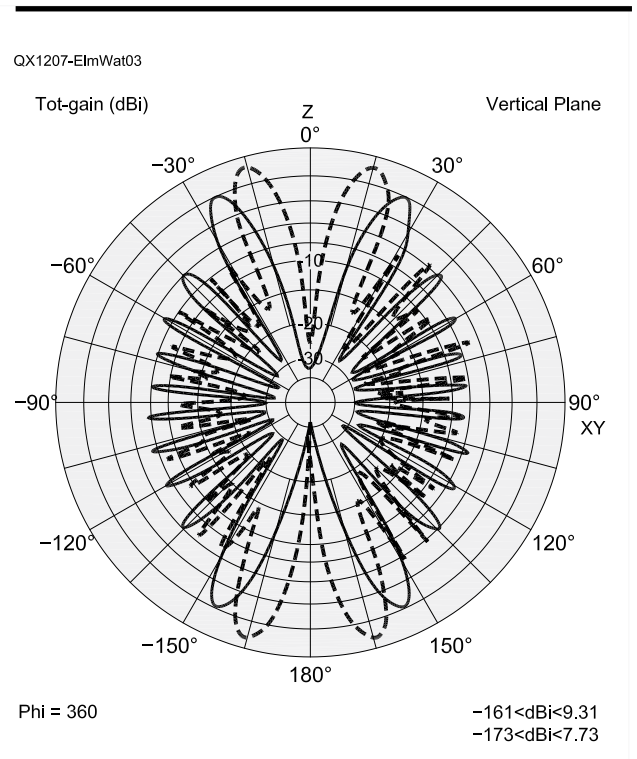

Figure 3 — When a dipole gets electrically long, it can be said to have a large wave size. Here the patterns of two such antennas are plotted, one that is 10 wavelengths long (dashed line) and a second that is 10.5 wavelengths. For these antennas, the direction of the maximum lobe splits into two major beams each side of the broadside direction and the direction of these maximum signals gets closer to the longitudinal direction of the dipole element. Note that there may also be a null in the broadside direction.

continues with the reactive component looking alternately inductive and capacitive in between.

Figures 4B, C and D plot this same behavior versus frequency in different ways.

Figure 4B shows the resistance and reactance separately but on the same linear scale. Figure 4C shows them combined into an equivalent impedance magnitude. Figure 4D shows the effects this impedance has on the SWR when fed from a 50 Ω transmission line. For all of these, the repetitive nature of the low impedance resonances is clearly visible. These occur at about 3/2, 5/2, 7/2 wavelengths and so on. This is the same phenomenon that also allows us to easily use a 7 MHz half wave dipole at 21 MHz — the third harmonic of its half wave resonance.

Beyond 50 Ω

An interesting thing seems to have happened within Amateur Radio sometime around the end of World War II. Amateur antennas, which had previously been fed with single or balanced wires, were increasingly fed with 50 Ω coaxial cable. Then a bit later, in the 1970s, our transmitters, which had often included pi-network output net-

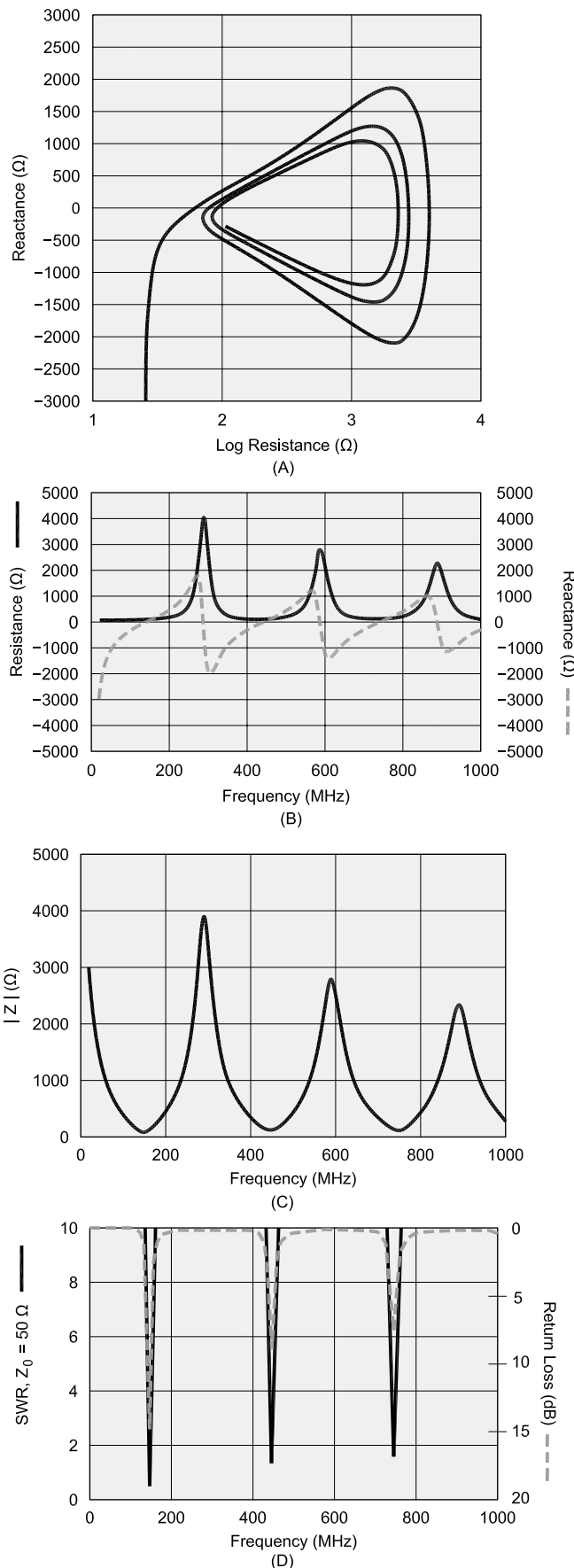

Figure 4 — Four different representations of the feed point characteristics of a center fed dipole. These show resistance, reactance, impedance SWR and return loss for the same very thin, perfectly conducting 1 meter long center-fed dipole. Examination of these different views reveals the low-impedance resonances at odd half-wave lengths as well as the high impedances ones near even half-wave lengths.

works capable of matching these high impedance antennas, increasingly became solid state and were designed to only drive loads of 50 Ω or something close to this. More recently, 50 Ω reference SWR bridges for use with 50 Ω coax have been included right inside amateur transceivers.

Coaxial cable has certainly been of great benefit, and most of us have spent considerable time trying to assure ourselves that the SWR we measure on our 50 Ω coax using a 50 Ω reference SWR meter was low enough. From the point of view of antenna physics or the way an antenna fundamentally operates, however, there is really nothing special about a 50 Ω reference impedance.

The rectangular graph of Figure 5B, shows a plot of the SWR of a dipole in a 50 Ω system, as before, along with a second plot of the SWR that would be measured if you were using a much higher impedance reference. Note the nature of the high impedance resonance you see when viewing SWR from a 6 kΩ perspective for this antenna. This second resonance, the high impedance one located between the low impedance resonances we normally use, actually has lower SWR over a wider bandwidth. The precise value computed by modeling tools for this high impedance may vary somewhat depending upon the tool and the dipole dimensions, just as it does for low impedance resonances.

Figures 5A and 5C plot these same feed-point characteristics in terms of impedance when plotted on a Smith chart. If you aren't too comfortable with Smith charts, don't let this format put you off. It's only another method to simultaneously display both resistance and reactance. You can think of it as a sort of "warped grid" for plotting the same information you saw in Figure 4A. This method has some nice features, however, when it comes to considering how to match to a load, whether you're using lumped elements or transmission lines.

In Figure 5A the Smith chart has a reference impedance of 50 Ω. This means that a 50 Ω resistive load with no capacitive or inductive reactance component will plot as a point right at the center. In fact, on a Smith chart of any reference impedance, a load of that impedance would be perfectly matched,

QX1207-ElmWat04

Figure 5 — Here the characteristics of a dipole are shown from the point of view of different reference impedances. The SWR plot shows the same dipole viewed from 50 Ω and 6 kΩ viewpoints. The Smith charts show the data plotted against a chart impedance of 50 and 754 Ω. A circle around Smith Chart center is characteristic of a mismatched transmission line, $Z_0 = Z_{ref} \neq Z_{load}$.

would plot at the chart center and the SWR for that would be 1:1. Also notice the circles on both of the Smith charts. If you are familiar with Smith charts, you may recognize them as “SWR circles” and know that a circle around the center of a Smith chart is a characteristic of a mismatched transmission line. Recognizing that a dipole operates like a transmission line with SWR is a benefit we get from looking at the data using the Smith chart.

In Figure 5C the reference impedance of the Smith chart has been changed to 754 Ω. At this value the circles that describe the dipole impedance are nearly centered on the Smith chart.

In Figure 6 the impedance of a thin, one meter long dipole is again plotted, but the frequency goes all the way to 3.1 GHz, where the dipole is 10.5 wavelengths long. Here again, with a chart reference impedance of 754 Ω, a dipole looks an awful lot like a mismatched transmission line and the size of the circle indicates that the SWR on that line is about 8:1.

If you are wondering about the choice of this particular reference impedance, it might help to realize that 754 Ω is twice 377 Ω, which is the impedance of an electromagnetic wave in free space, and that a center-fed dipole has two elements going in opposite directions from the center. This may make more sense when we consider a possible schematic model of a dipole.

A Simple Circuit Model of a Dipole

These observations show us that for the calculated data provided, a dipole behaves a lot like a pair of mismatched transmission lines, each operating with an SWR of about 8:1. It is as though each of the dipole elements was a 377 Ω transmission line and each was terminated with a resistor of about 3 kΩ.

All this invites us to use a rather simple circuit model for a dipole. Figure 7 portrays this schematically. In this schematic, the transmitter’s 50 Ω output impedance is connected through a length of 50 Ω coaxial cable to an antenna tuner or matching network of some sort. This tuner may include provision for converting the unbalanced coaxial feed to a balanced load like a dipole or Yagi or the balun may be built into the matching struc-

Frequency: 147 MHz
 S_{11} : 0.184 / -5.14°

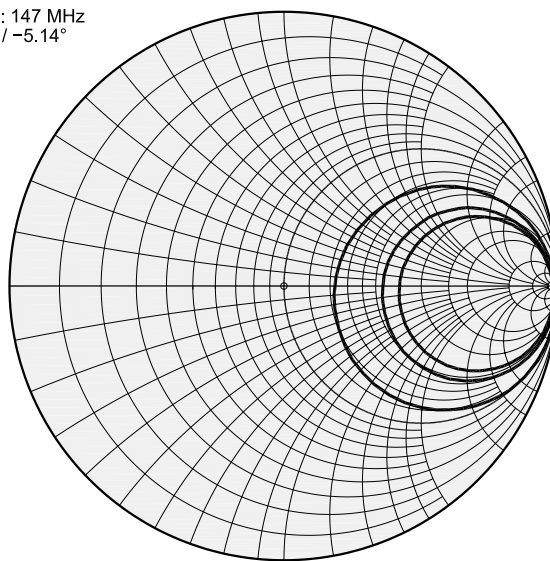

$Z_{ref} = 50 \Omega$

(A)

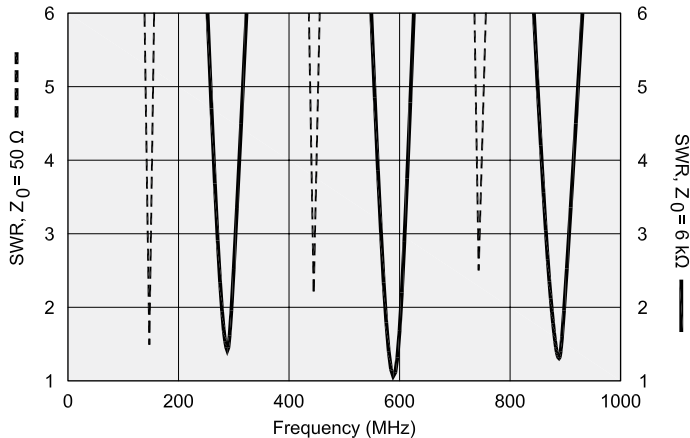

(B)

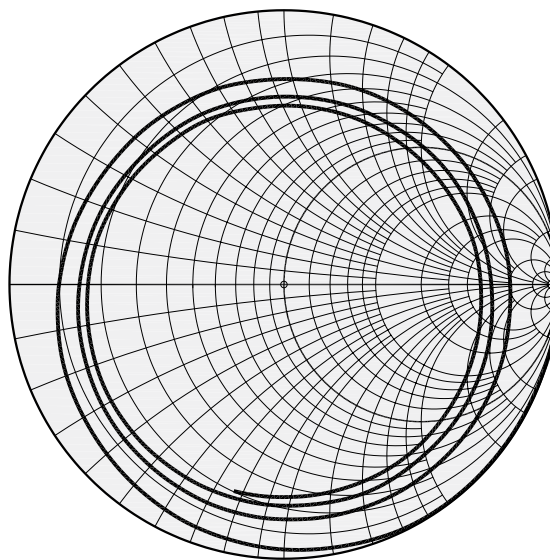

$Z_{ref} = 754 \Omega$

(C)

QX1207-ElmWat05

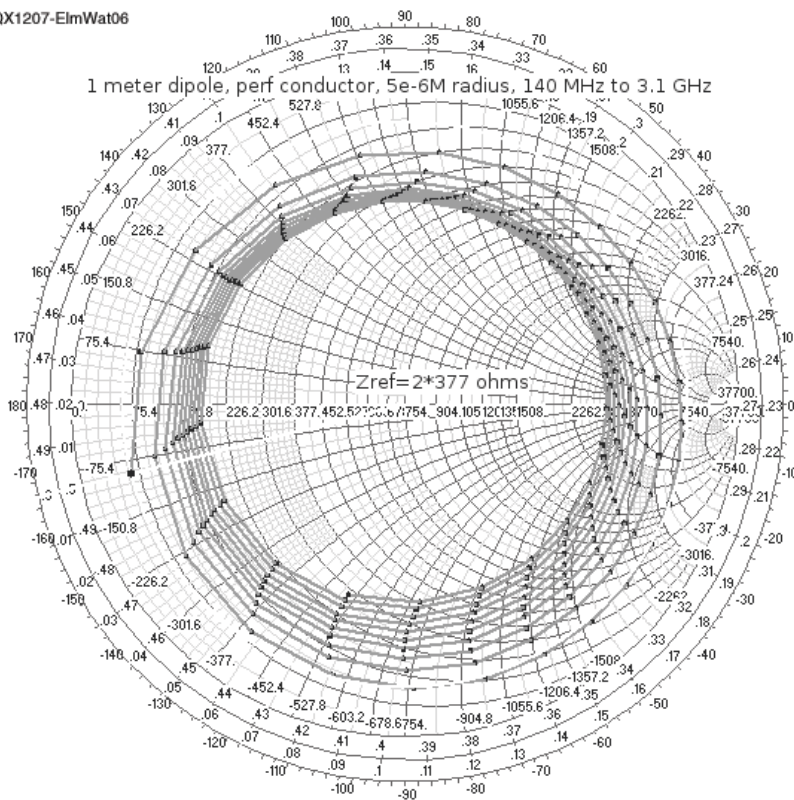

Figure 6 — Feed point impedance (from 4NEC2) of a thin 1 meter dipole plotted on a Smith chart having a reference impedance of 754 Ω. This value is approximately twice the impedance of a wave in free space. For this plot, frequency is swept from just below the 2 m amateur band to above 3 GHz so the antenna wave size is changing from one half wavelength to over ten wavelengths. Notice that as the antenna gets electrically long, successive circles have nearly the same center and radius.

radiation polarity and pattern — of a full-size dipole but with only a single element. The feed-point impedance is one half that of the dipole because for the same voltage there is twice the current, the original current in the element plus the equal image current due to the image element in the ground plane. Because of this relationship, the circuit model we create for a balanced dipole can easily be adapted to work for a single-ended antenna as well.

The resulting circuit model for the dipole has two mismatched transmission lines between the feed point at the center and the radiation resistors at the tips. The feed point impedance acts like each of these lines is terminated with a resistance of 2 to 3 kΩ. For a thicker dipole, the termination resistance will be lower. For shorter dipoles, say less than a wavelength or two, there is also a little bit of shunt capacitance between the ends of the lines — that is, between the tips of the dipole — that affects the impedance slightly. The terminating resistance and this shunt capacitance vary somewhat with dipole length, element thickness and taper, but overall this model is pretty good.

When we build transmitters and tuners, our goal is usually to transfer as much transmitter power, often coming from a 50 Ω transmitter, to these radiating termination resistors at the ends of the lines. This circuit model can give us some insight of how to do this effectively.

Near-Field Characteristics

Now that we have examined both the far field pattern and the feed characteristics let's turn to see what sorts of fields are present very close to the elements of this dipole. We call this region close to the antenna the "near field." Figure 8 shows four different near field plots produced by 4NEC2, solving Maxwell's equations. For these plots the vertical dipole is centered on the left edge of the plot and color is used to indicate field intensity. [Since

ture at the antenna itself. For a radio communications system designer, the goal is usually to transfer as much of the transmitter power into the radiation resistance as possible.

Sometimes both the balun and any required matching is built into an antenna. A ground plane fed directly with coaxial cable is an example of this. For an antenna that uses a ground plane, a perfect ground system, we can say that there is an "image plane" that

acts like a mirror to reflect the image of the actual antenna element to create an "inverted twin." Imagine looking into a mirror that has only one element of a dipole placed so that it stands on the reflecting surface. If you looked at both the element and the mirror you would see a full size dipole but only half of it would be real, the other half would be a reflected image. This effect is present in a ground plane antenna and produces the effects — the

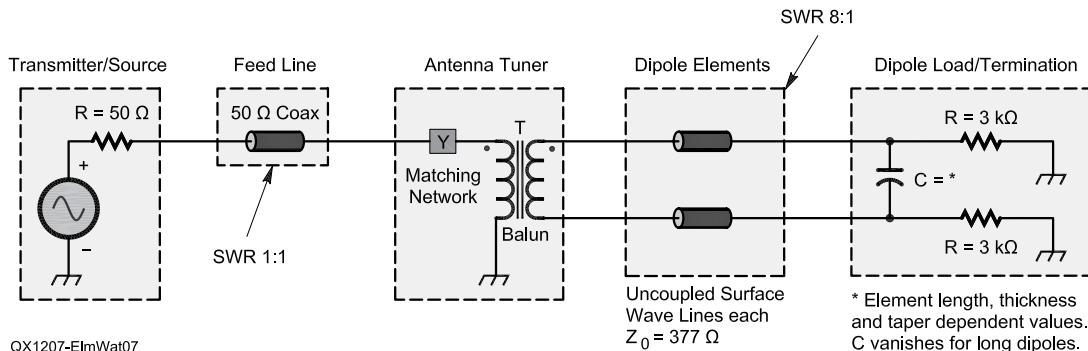
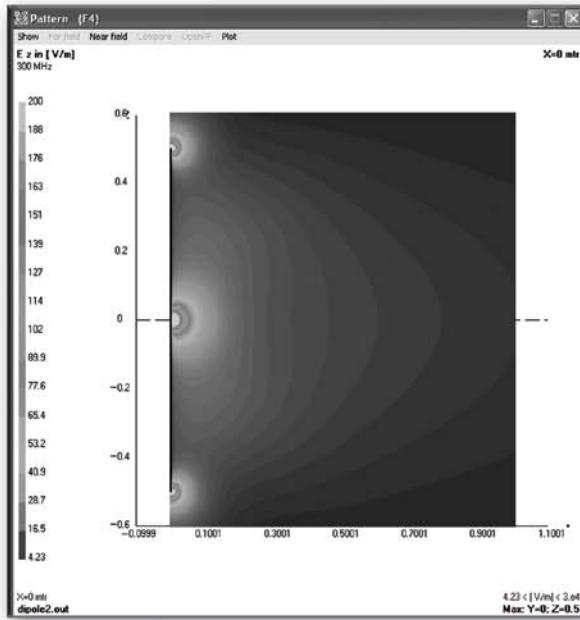
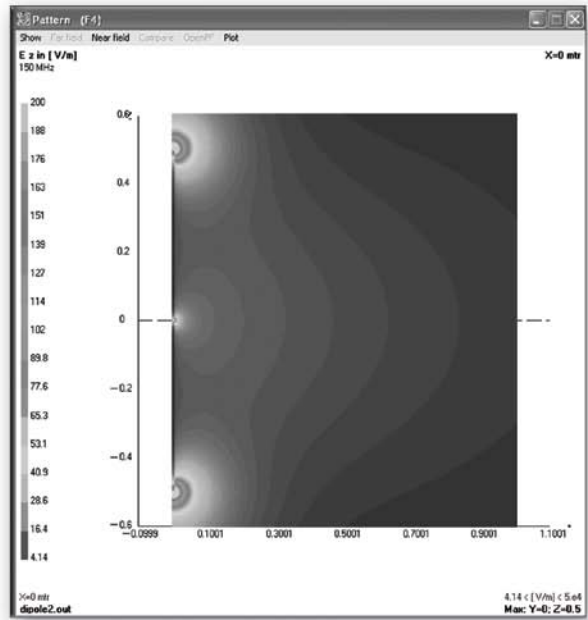

Figure 7 — A simple schematic model for matching a center-fed dipole to a radio receiver or transmitter.



(A)



(B)

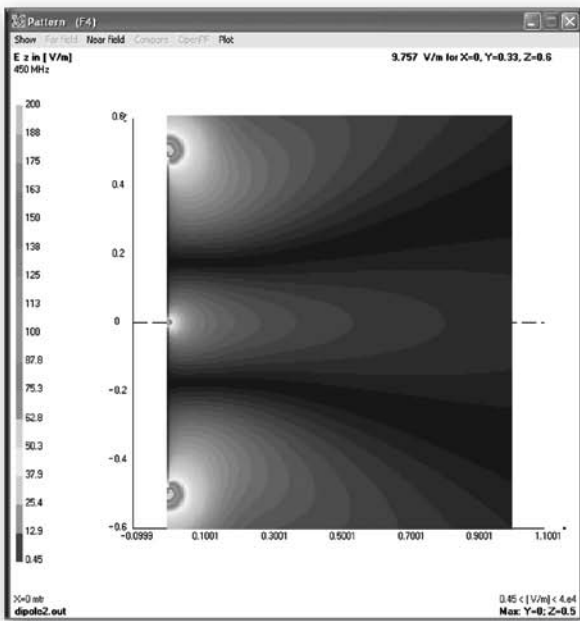

(C)

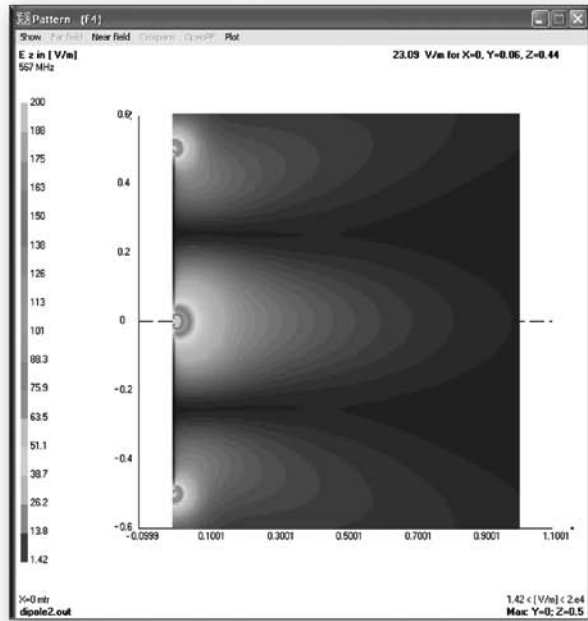

(D)

Figure 8 — Longitudinal electric field strength in the vicinity of a center-fed dipole. Various antenna sizes (in wavelengths) are shown here. The antenna is located at the left edge of each plot and color is used to represent field strength. Notice that the only significant “hot spots” are at the tips of the dipole and, for some lengths, at the center.

we can't print color in *QEX*, it will appear as gray shading here. I will put the original color screen captures on the ARRL *QEX* files website. Go to www.arrl.org/qexfiles and look for the file **7x12_Elmore.zip**. — *Ed.*² Only the electric field parallel to the dipole conductor is shown for this center fed dipole driven at different frequencies. We're calling this field direction the E_z direction. This is not the total electric field. There are other components coming away from the dipole at right angles to the elements, the E_x and E_y directions. We can, however, take advantage of something we know from the analytical solution mentioned at the beginning. In the far field, due to symmetry and cancellation, E_x and E_y each become zero and may be ignored. Both common experience and analytical theory tell us that at great distance a vertical antenna radiates only a vertically polarized signal. This simplifies the display and allows us to see something else of interest — significant E_z components are present only at the element ends and (sometimes) at the center of the dipole.

Putting It Together — A New Interpretive Model

As a result of these observations about the patterns, impedances and fields associated with a dipole it is possible to form a new interpretive model of how an antenna acts when it is fed, and how it radiates. Since there is a central plane of symmetry, this model can also be applied to a monopole having an image plane, a vertical working against an infinite ground plane.

The Antenna as a Wave Device

We saw from the impedance information plotted on a Smith chart that the dipole acted like a transmission line with a relatively high SWR, that is, with forward and reflected waves. Figure 9 fills out this description. In it, two oppositely directed and opposite phase waves flow from the feed point at the center toward the tips. A wave model is just an alternative to using voltages and currents for considering power flow. Here, the feed is shown as a voltage source split into two equal parts to emphasize the plane of symmetry that exists at the center. At this point, now switching to the wave model, waves begin and continue along the antenna elements, which act just like transmission lines. When the waves reach the mismatch at the element end some power is coupled into the radiating Tip region, where the radiation resistance is located, but most of the wave is reflected back toward the center. By recognizing that the dipole is symmetric and that the waves in the two halves are opposite, both in phase and direction, it is easy to see that the regions of radiation at the tips are equal in both phase and magnitude.

Depending upon element length, at the center of the dipole the reflected waves may or may not be phased so as to add with the source wave to produce a third radiating field. For a half wave dipole, or actually any dipole that is an odd number of half waves long, the returning waves exhibit about 180° of phase reversal and mostly cancel with the outgoing waves produced by the voltage sources at the center. I say “mostly” because the reflected

wave is slightly smaller than the outbound one, some of the power in the outbound wave was radiated away at the element tip. It is the phasing of these reflected waves, determined by the element length that produce the alternating low and high impedance resonances that are so familiar to us. For the half wave dipole the radiation source at the center produces only a small contribution to the far field pattern, as shown in Figure 8A and 8C. For other antenna lengths there can be significant contribution to the far field pattern from this central electric field source. At an antenna size of about 1.9 wavelengths, in the broadside direction the phase and magnitude of this central source just cancel the combined sources at the tips. It is this cancellation that produces the broadside nulls and beam splitting shown in Figures 2 and 3.

Surprisingly, the antenna element conductors themselves act like 377Ω transmission lines that don't radiate at all! This type of line is called a surface wave transmission line (SWTL) and construction and use of practical lines of this type for amateur purposes has been described, as has been a more theoretical and historical description.^{3,4} The antenna elements can be thought of as transmission line matching elements, transformers or “resonators” that exhibit significant Q .

The areas producing the radiation are located in the space just beyond the ends of the SWTL, the dipole tips, and sometimes at the center of the dipole. This “wave model” of a dipole helps to make clear how and why the harmonic characteristics of a dipole are produced.

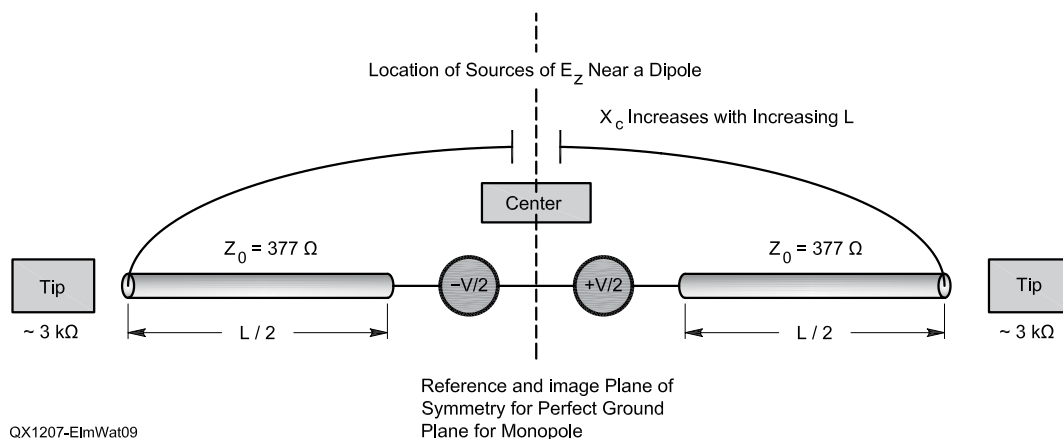

Figure 9 — Considering both the feed-point characteristics and the far field radiation pattern, a thin center-fed dipole can be modeled as a simple structure. The dipole elements themselves do not radiate but act as 377Ω surface wave transmission lines. Radiation occurs near the element tips and, depending upon the element electrical length, sometimes near the center as well. The feed-point impedance is the same as if the transmission lines were connected to approximately $3 \text{ k}\Omega$ loads and each operating with an SWR of 8:1. For short dipoles, generally those under a wavelength in length, there is an additional capacitive load that appears between the element tips. This effect becomes small as the dipole gets electrically large.

Waves on a SWTL produce a longitudinal electric field; longitudinal electric lines of force that begin and terminate on the conductor itself. This wave is said to have transverse magnetic (TM) fields. Compare this to conventional coaxial cable, which operates mostly in transverse electromagnetic (TEM) mode and has both electric and magnetic fields that are transverse to the direction of propagation. TM mode has components of the electric field in the direction of propagation but magnetic fields are only transverse. To fully support a wave in this mode requires a line at least one half wave long. In practice, some extra length is often required to properly start (launch) the process. This condition is not fully met for short dipoles so they show a mixture of modes. Rather than all the electric field produced by the source going into generating a surface wave, some of the field lines terminate back on their “twin” in the other element of the dipole.

That a long thin antenna also behaves somewhat like a transmission line and resonator is hardly news, but that a dipole can behave like a 377Ω mismatched surface wave transmission line terminated with two $\sim 3 \text{ k}\Omega$ loads may be something that you haven’t heard before.⁵

The far field radiation pattern and the impedance of a center-fed dipole (or monopole) can be modeled as due to sources of longitudinal electric field at the ends and feed point. At the tips, these regions act as the mismatched loads to non-radiating surface wave transmission lines. For short dipoles, the lines are slightly coupled and the feed impedance

is modified somewhat by a shunt coupling capacitance.

Wrapping It Up

While Figure 9 shows a new model that describes a dipole in an intuitive way, if you’re like me, something simpler, with fewer pieces, may be easier to picture and remember. Toward that end, Figure 10 shows only one half of the dipole but includes the perfect ground plane already mentioned. It really is just Figure 9 laid on its side with only the top element and ground plane remaining. Because of the symmetry and function of the image plane, this is fair to do. What we have is simply a vertical antenna, fed from the bottom against a perfect ground. As shown, power from the source propagates in a wave along the element without radiating. When the wave reaches the top, some of it is coupled into a region of radiation having a relatively high radiation resistance compared to the impedance of the line. The majority of the wave reflects off of this mis-

match and returns toward the feed point. At the feed-point, the forward wave and the slightly diminished reflected wave add together and, depending upon the phasing produced by the out-and-back travel, may add together to either nearly cancel or else produce another significant source of radiation similar to the one at the top.

If you can remember this model for a monopole with its image plane, you also have the model for a dipole by just “looking in the mirror”.

If you’ve read this far but you’re still wondering “Why do we need another model?” read a bit more and perhaps you will find that this new model provides an intuitive way to understand familiar antennas and to get some new insight into how to best use them.

A Practical Application – A Very Broadband Vertical

Hopefully this new antenna model provides an intuitive way for understanding the

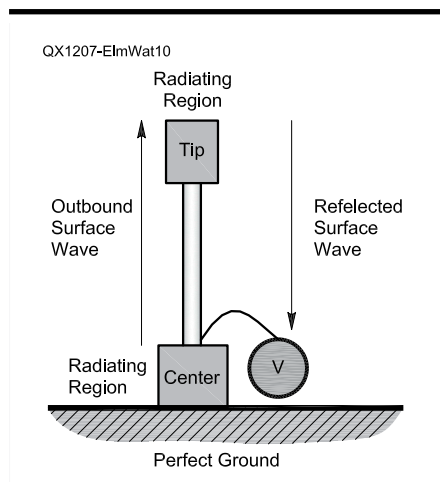

Figure 10 — The model shown in Figure 9 applies well to a monopole antenna operating over a good ground system. Since a plane of symmetry exists down the center of the structure, the resulting pattern for a monopole like this (a ground plane antenna) is the same and because there is twice as much current for the same feed-point voltage, the impedance is one half that of the dipole.

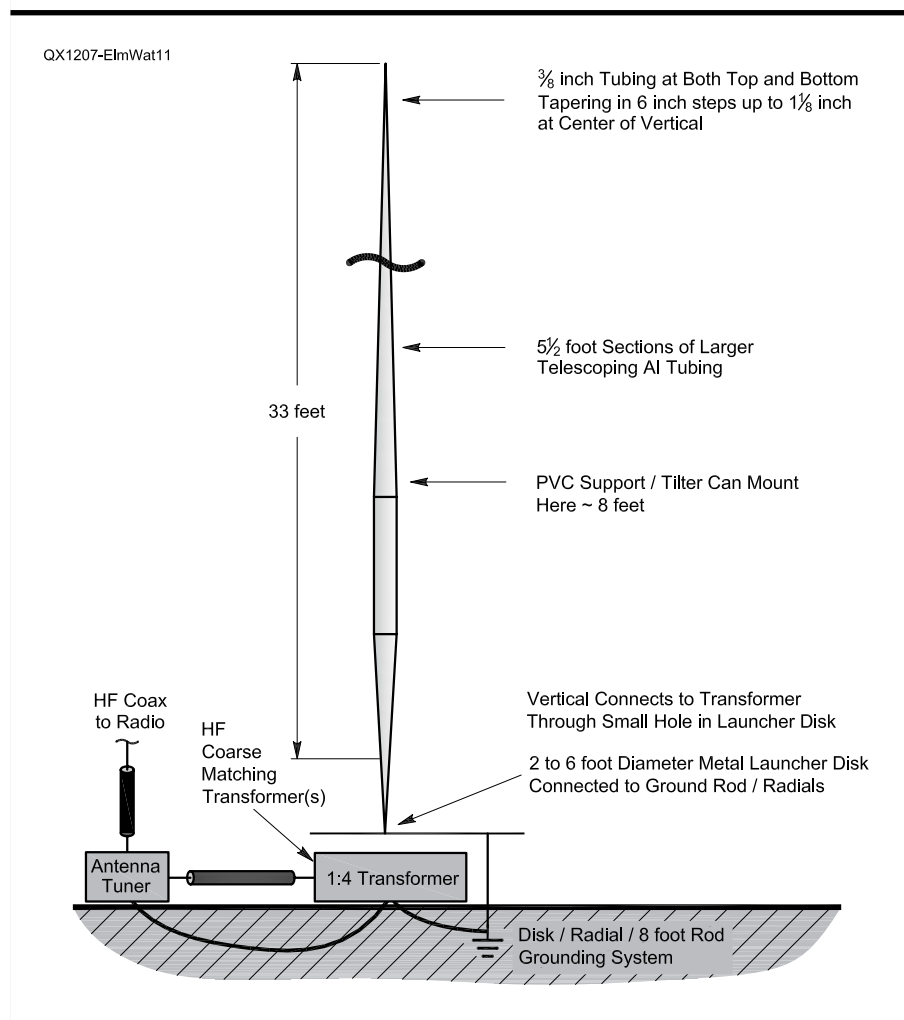

Figure 11 — A practical application of the new antenna model makes a general coverage, 7 MHz to 432+ MHz vertical antenna possible.

feed-point impedance and the radiation characteristics of a very thin, perfectly conducting center-fed dipole or monopole. To help this model be a bit more practical, let's look at a real vertical monopole antenna that you can easily build. This vertical can be used at any frequency between 7 MHz and 432 MHz and even beyond, to produce a good match and radiation performance.

The antenna shown in Figure 11 is approximately 33 feet high and made from 6 foot long aluminum tubing sections that can "nest" together. It's quite similar to the usual quarter wave 40 m vertical. One slight difference is that these sections vary in diameter from $\frac{3}{8}$ inch at the top and bottom to $1\frac{1}{8}$ inch near the middle. The larger middle sections overlap only about 6 inches and provide most of the length. The remainder of the length is made up by tapering down quickly near the ends with smaller tubing in 6 inch steps. Because these ends are not very strong, the whole structure is supported by an insulator made from 2 inch PVC pipe fittings located about 8 feet from the ground end. For grounding, an 8 foot ground rod is used, and in addition to this ground rod, immediately under this vertical antenna, there is a 2 foot diameter metal foil disk. For the measurement shown, this was simply a plywood disk covered with aluminum foil. This measurement was made by connecting a vector network analyzer to an SMA connector mounted at the center of the foil disk. The center pin of this connector attached to the bottom of the vertical and the disk and ground rod were connected together with a short piece of wire.

Figure 12 shows the measured feed impedance, displayed as S_{11} on a Smith chart having a reference impedance of $200\ \Omega$. The plotted data shows measurement from 0.3 MHz to 250 MHz. The characteristic circles like those previously shown for the 4NEC2 model of the 1 meter dipole are obvious, but there is additional information present here too. Below approximately 50 MHz, the circles are not centered as nicely, they are a little ragged and they are shifted slightly to the right in the direction of higher impedance. Above this frequency they look cleaner, have nearly a common center and lie nicely on top of one another.

Figure 13 shows this same data displayed as the SWR that would be produced if the antenna was fed by a $200\ \Omega$ transmission line. As a practical matter, this "strange" impedance can be transformed with a 4:1 transformer to achieve the same results with $50\ \Omega$ coax and a $50\ \Omega$ SWR meter. Above about 6 MHz, where the antenna is not quite a quarter wave long, the SWR is around 6:1 or better. Above 90 MHz, where the disk apart from the ground and ground rod provides a better image plane, the SWR is

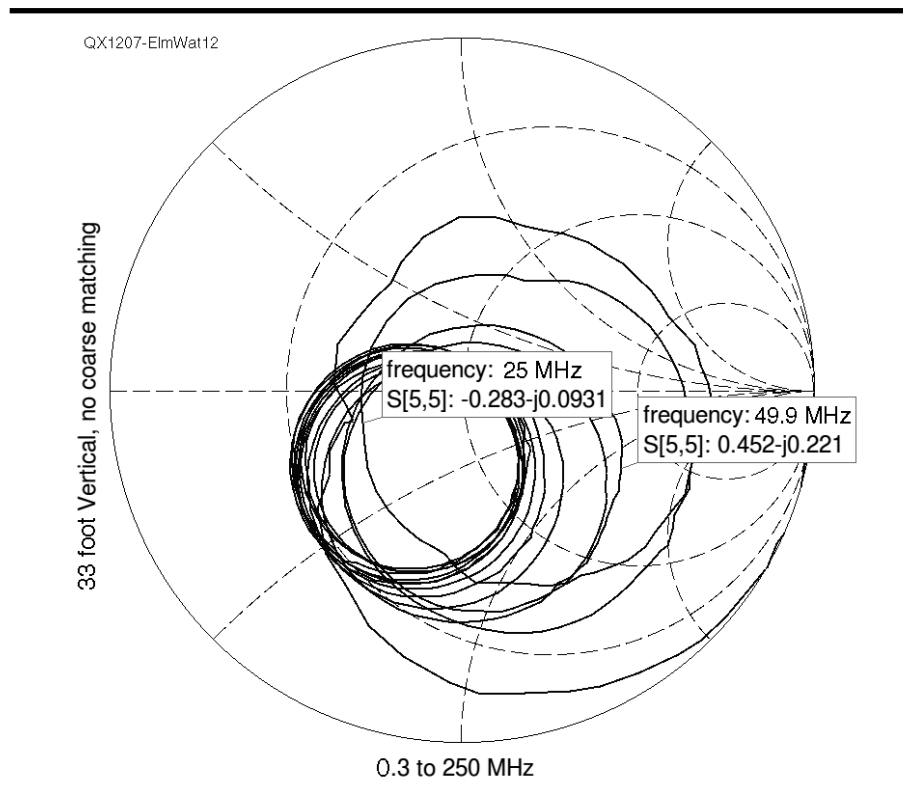

Figure 12 — Measured S_{11} parameters of a 33 foot monopole having tapered end sections. The monopole is mounted at ground level directly above an additional 2 foot diameter metal ground disk (launcher).

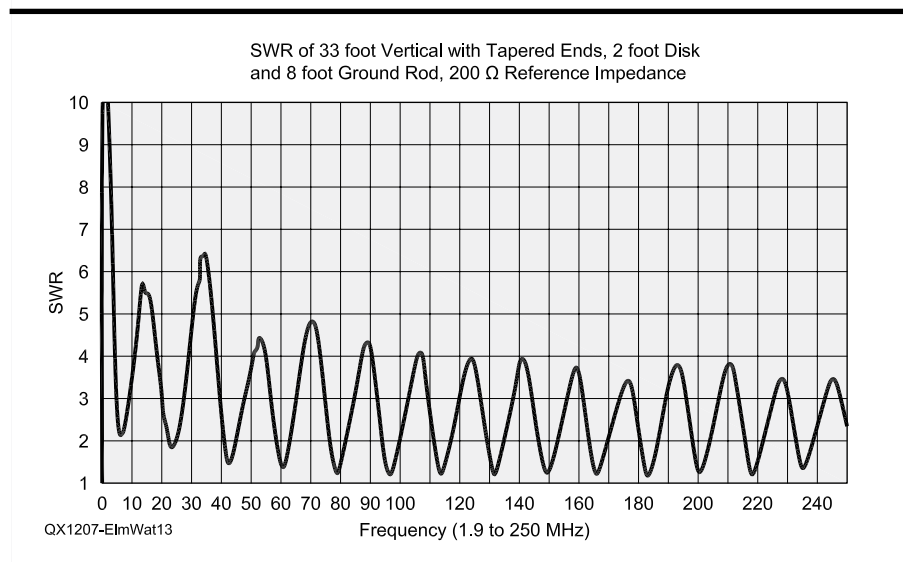

Figure 13 — Measured SWR of a 33 foot vertical with tapered ends with a reference impedance of $200\ \Omega$. A 2 foot diameter ground launcher is used in conjunction with an 8 foot ground rod.

always less than 4:1. This relatively small degree of mismatch can be easily handled by most antenna tuners. The 50 to $200\ \Omega$ transformer should have a minimum of stray reactance at the operating frequency. For very broadband usage, it may be necessary to use several different 4:1 transformers in

order to get sufficient coverage. Both toroidal and transmission line transformers are good candidates, depending upon the frequency of operation.

This arrangement produces an antenna usable over most of the HF and even VHF amateur bands. For frequencies below

6 MHz, the impedance is capacitive and additional inductance may need to be added in order to get within the matching range of some antenna tuners. Even so, with relatively simple matching circuits and equipment, this simple vertical can effectively operate over a much larger frequency range than might be commonly thought.

The circumstances described here are those that amateurs encounter with any simple vertical, quarter wave or otherwise, with regard to ground rods, radials and counterpoises, but we are considering these from the viewpoint of the new model. We are also considering use over a much wider frequency range than you might have thought appropriate for a 40 m vertical.

By viewing this vertical as a length of mismatched surface wave transmission line, the ground, ground rod, and the metal disk combination can be thought of as a planar surface wave launcher. Launchers are devices that convert a different mode, in this case the TEM mode in the coaxial cable at the SMA connector, to the TM mode on a SWTL.³ Here, that launcher is the combination of the ground, the ground rod and the disk. The disk portion has much higher conductivity, however, and is a better defined plane than the ground rod and the sod under and around the antenna. Above about 90 MHz, this 2 foot disk is completely sufficient to effectively launch a surface wave. Below that, the ground beyond the 1 foot radius limits of the disk becomes involved and, because it is not so good, the impedance seen at the feed point rises due to ground losses and the effective ground depth. A larger disk, perhaps 6 feet in diameter could make things better from about the 20 meter band and higher.

This model also lets us see how to match to this vertical everywhere, not just near a resonance and it gives us a better understanding of the radiation pattern we should expect at any frequency.

Thinking of the antenna element as a SWTL also gives some practical insight into mounting an antenna at a typical QTH. SWTL theory indicates that the vast majority of the power propagated along the line is very near the surface, within a few conductor diameters of the line. Combined with what we saw about regions of radiation, we have a good indication that a thin vertical antenna at a low-impedance resonance might actually be operated very successfully as long as only the immediate space around it is kept clear and the tip can stick up above absorbers and clutter. It may not be necessary to have a large flat open space to get good results.

Remember that a trade-off with low-impedance operation is that a better ground system is required. A vertical operated at the high-impedance resonance with a lot of foliage

near the bottom and the top clear might lose significant efficiency because of absorption of the energy radiating from the bottom.

By using this new model we have found a way to match and use a conventional vertical antenna over a very broad range of frequencies rather than only at a resonance. The model has shown us a way to couple transmitter power to the radiating regions of space near the antenna itself without requiring a particular length of element. It has also shown us an easier way to provide a reference ground point from which to feed it. While common wisdom has suggested that a quarter wave grounding system is important, you can see that at least for matching purposes, a good planar ground much smaller than a quarter wave, on the order of 5 to 10% of a wavelength radius, can actually be quite adequate. Note that we are only talking about feeding and effectively matching. By using a very good but smaller plane, ground losses can be avoided but this does not necessarily mean that the far field pattern of a vertical will be good at all take off angles. Particularly for low angles, the qualities of the ground quite far from the antenna base may be important. Our model is only addressing the problem of coupling power to the radiating part of the antenna structure. Far field radiation pattern and take off angle may be strongly affected by ground characteristics at much larger distances, where we have no access or ability to modify the ground.

An antenna of this sort can provide excellent performance over most of the amateur HF and VHF bands. At HF it works particularly well when operation near one of the familiar low-impedance resonances is avoided. Operating at higher impedance points reduces the antenna current and the equal image current in the ground system. This reduces the I²R loss in the grounding system. At the 33 foot length shown here, only 40 m and 12 m are very close to a low-impedance resonance. Because this antenna does not depend upon a resonance to operate, however, you are free to adjust the length to accommodate different requirements.

For higher HF and VHF operation there is a trade-off here. Although the efficiency of feeding the antenna is better at the high-impedance resonance because of reduced ground losses, at these wave sizes the lower radiation point shown in Figure 13 is very significant — there is a lot of electric field at ground level. For many amateur locations, this can mean that more transmitter power is lost to foliage, buildings and other ground clutter. This is in contrast to the benefit of the radiation region at the top, which is likely to be furthest away from these absorbers and up where the signal is more likely to be radiated away. At antenna wave sizes that produce a

low impedance feed point, this top point is dominant, but it may be possible to “have your cake and eat it too” in some situations. A length may be found that lets you set one of the low-impedance resonances on higher bands, say, 10, 6 or 2 m at the same time you achieve a high impedance resonance near 20 m. When used with a relatively small disk, of perhaps 2 to 3 foot radius, radiation on the higher band will occur primarily from the top while at 20 m the ground losses will still be quite low.

Obviously there are a lot of possibilities and an impedance measurement like that shown in Figure 12 should give you good guidance as to what lengths will or won't work the best. The markers placed at the 12 and 6 m bands illustrate this. An impedance bridge or vector network analyzer is probably required to do the best job of selecting the exact length. Of course, an alternative is to slightly adjust the length of the antenna between band changes to select a high impedance resonance for HF and a low impedance resonance for higher bands.

This antenna can perform well from 10 m through 450 MHz and even beyond, since it gets the radiation point well up in the air and away from absorbers. Measurements at N6GN show on the order of 10 dB better performance at 432 MHz as compared to a dipole or ground plane mounted at 10 feet. The “height gain” makes it work as well as a medium sized Yagi would if placed only at roof level. The biggest challenge to VHF operation seems to be providing a 4:1 transformer and low loss antenna tuner this high. Transmission line transformers are probably good candidates.

A related version of this antenna that can operate over an even broader frequency range by also using the HF vertical conductor as a SWTL having a bottom launcher to feed a top-mounted discone antenna with integrated launcher was presented at ARRL Pacificon in 2011, and will be published in *QEX* in an upcoming issue.⁷

Models

This article is meant to provide a model that is helpful for understanding how and why an antenna operates without requiring a thorough understanding of Maxwell's equations. George Box, an expert in quality control and modeling, once wrote “All models are wrong — but some are useful.” Models are at the heart of the scientific method. In all scientific endeavors, it is important to remember that we are only using models. Remembering this helps keep us humble, keeps us from thinking we know all the answers and keeps us looking for better models.

Sometimes we use more than one model, even overlapping and potentially conflicting models, to describe our world. The two different models for describing light, the wave model and the particle model, are an example of this. While they seem at odds with one another, each is extremely useful for describing certain aspects of measurement and observation in situations where the other doesn't work so well.

A good model should be useful to:

1) Describe the Known — A good model accurately describes what we already know and experience. It fits our observations.

The antenna model described here does a good job at explaining what we already know about the radiation pattern and the feed-point characteristics of a common center-fed dipole. It provides a method for intuitively grasping what an antenna does.

2) Point to New Possibilities — A good model should provide something previous models don't. It should enable new understandings and indicate new applications.

This model has already pointed to some new possibilities. Hopefully the SWTL previously described and the All Band antenna to be presented in a future issue of *QEX* will prove useful to radio amateurs. It may be that this new model may also be useful for better understanding how other antennas, such as the Beverage or "Wave Antenna" work. Recognizing that this antenna is a slightly unbalanced, terminated SWTL and that it acts very much like a directional coupler to an incoming sky wave signal might lead to new ways of using this old favorite for efficient transmit as well as receive.⁶

3) Make Us Ask Questions that Lead to Better Models — A good model should cause us to seek even better models. It should raise questions or raise possibilities that point us to explore further and better. A good model can provide the seeds of its own replacement.

This model also makes us ask questions. For example, Maxwellian field theory provides us with the tools to examine the effects due to the moving charge (current) in an antenna. This theory only deals with the charge of an electron and not the mass. Recognizing that a long dipole acts as a wave device with little or no coupling between the halves invites a question.

We know from other areas of physics that the charge and mass of an electron are inseparable, the presence of a "current column" due to moving charge on a dipole would seem to be associated with the presence of a "momentum column" due to the moving mass of the electron carriers. From physics we believe that in any closed system, momentum is always conserved. Since we see that the electron current at the ends of a dipole is zero and that for a long dipole

there is insignificant coupling between the elements, isn't the wave on each element in a closed system? If the displacement field and displacement current provided by Maxwell are necessary to provide continuity of the magnetic field, is there not a need for a parallel device — a "displacement field for momentum" to account for conservation of momentum on an antenna? Is there an associated "momentum field" or "momentum wave" emanating from the tip of a dipole?

Whether there is a simple answer to this from classical mechanics, a vector potential analysis, one from quantum electrodynamics that explains an antenna as a quantum device, or whether some other explanation is required, hopefully the process of discovering the answer will prove to be useful to generate new applications.⁸ Maybe this model of a dipole as a surface wave device will even prove to be useful enough to be replaced by a better one.

Glenn Elmore, N6GN, has been a licensed Radio Amateur for the past 50 years, and has held call signs of WV6STS, WA6STS and now N6GN. He has held an Amateur Extra class license since 1972. For most of his working career, Glenn has been an electrical engineer involved with the design of RF and microwave test and measurement equipment, notably scalar, vector network and spectrum analyzers.

Glenn's Amateur Radio interests have included weak signal VHF/microwave operation including meteor scatter, EME, terrestrial DX as well as higher speed Amateur TCP/IP radios and networks. He has recently been active on WSPR, the weak signal reporting network. Glenn is an ARRL Member.

Notes

¹You can download a copy of 4NEC2 at <http://home.ict.nl/~arivoors/Home.htm>.

²The color plots for Figure 8 are available for download from the ARRL QEX files website. Go to www.arrl.org/qexfiles and look for the file **7x12_Elmore.zip**.

³Glenn Elmore, N6GN, John Watrous, K6PZB, "A Surface Wave Transmission Line," May/June 2012 *QEX*, pp 3-9.

⁴Glenn Elmore, N6GN, *Introduction to the Propagating Wave on a Single Conductor*, 2009, www.corridorsystems.com/FullArticle.pdf.

⁵John Kraus, W8JK, *Antennas*, McGraw-Hill 1950, Chapter 1. "Thus, a single device, in this case the dipole, exhibits simultaneously properties characteristic of an antenna, a transmission line, and a resonator."

⁶Beverage, Kellogg, Rice, "The Wave Antenna," *Transactions of the AIEE*, Feb 1923, p 215.

⁷Glenn Elmore, N6GN, John Watrous K6PZB, "An All-Band Antenna," ARRL Pacificon, 2011.

⁸Natalia Nikolova and Robert Zimmerman, *Detection of the Time-Dependent Electromagnetic Potential at 1.3 GHz*, II.A. McMaster University, CEM-R-46, Nov 2007.

